

Motor 390 Adventure 2023

ART.-NR.: 081290WEN





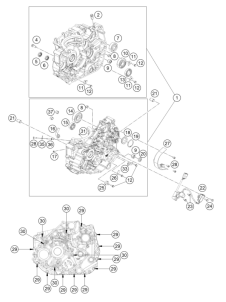
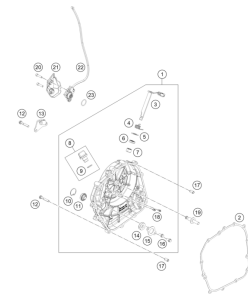
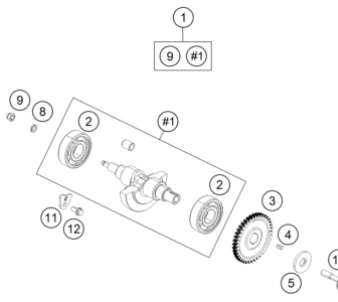
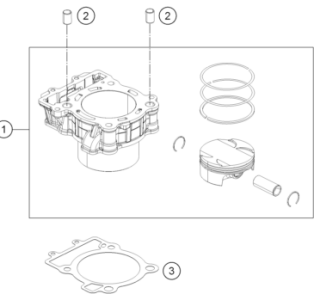
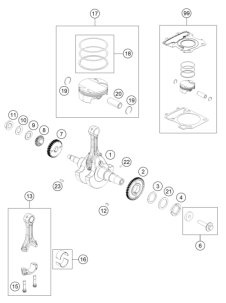
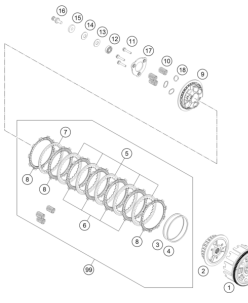
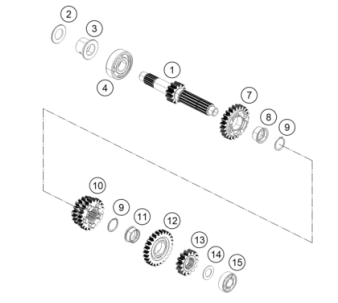
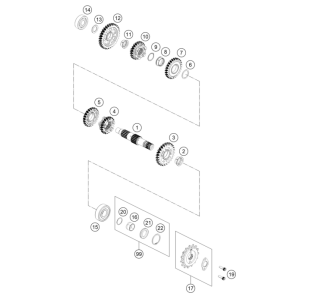
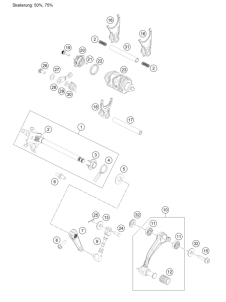
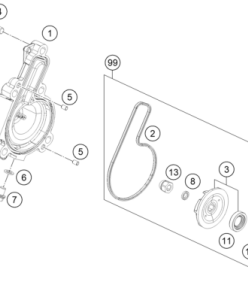
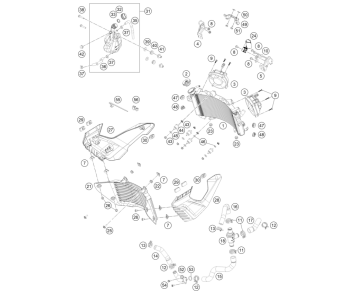
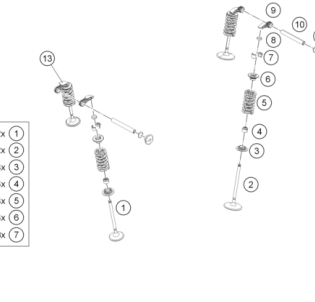

All information contained is without obligation. KTM Sportmotorcycle GmbH particularly reserves the right to modify any equipment, technical specifications, prices, colors, shapes, materials, services, service work, constructions, equipment and the like so as to adapt them to local conditions or to cancel any of the above items, all without previous announcement and without giving reasons. KTM may stop manufacturing certain models without previous notice. KTM shall not be held liable for any deviations of availability and/or ability to deliver, illustrations, descriptions, printing and/or other errors. The illustrated models partly contain extra equipment, which is not applied to standard models.

© by KTM Sportmotorcycle GmbH, Mattighofen AUSTRIA; All rights reserved; Reprint, also in extracts, with written allowance of KTM Sportmotorcycle GmbH, Mattighofen only.

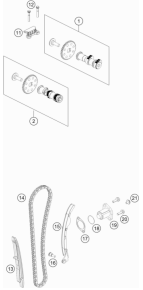
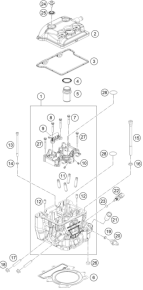
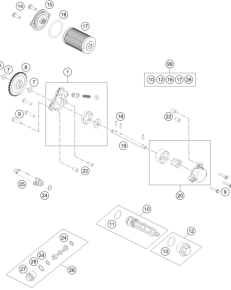
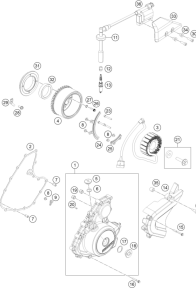
<p>ENGINE CASE</p>  <p style="text-align: right;">3</p>	<p>CLUTCH COVER</p>  <p style="text-align: right;">4</p>	<p>BALANCER SHAFT</p>  <p style="text-align: right;">5</p>	<p>CYLINDER</p>  <p style="text-align: right;">6</p>
<p>CRANKSHAFT, PISTON</p>  <p style="text-align: right;">7</p>	<p>CLUTCH</p>  <p style="text-align: right;">8</p>	<p>TRANSMISSION I - MAIN SHAFT</p>  <p style="text-align: right;">9</p>	<p>TRANSMISSION II - COUNTERSHAFT</p>  <p style="text-align: right;">10</p>
<p>SHIFTING MECHANISM</p>  <p style="text-align: right;">11</p>	<p>WATER PUMP</p>  <p style="text-align: right;">12</p>	<p>COOLING SYSTEM</p>  <p style="text-align: right;">13</p>	<p>VALVE DRIVE</p>  <p style="text-align: right;">15</p>

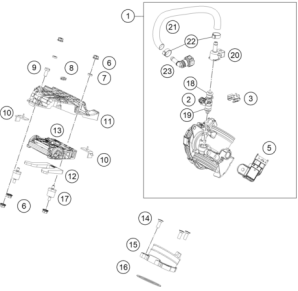
<p>TIMING DRIVE</p>  <p>17</p>	<p>CYLINDER HEAD</p>  <p>18</p>	<p>LUBRICATING SYSTEM</p>  <p>19</p>	<p>IGNITION SYSTEM</p>  <p>20</p>
<p>ELECTRIC STARTER</p>  <p>21</p>	<p>THROTTLE BODY</p>  <p>22</p>		

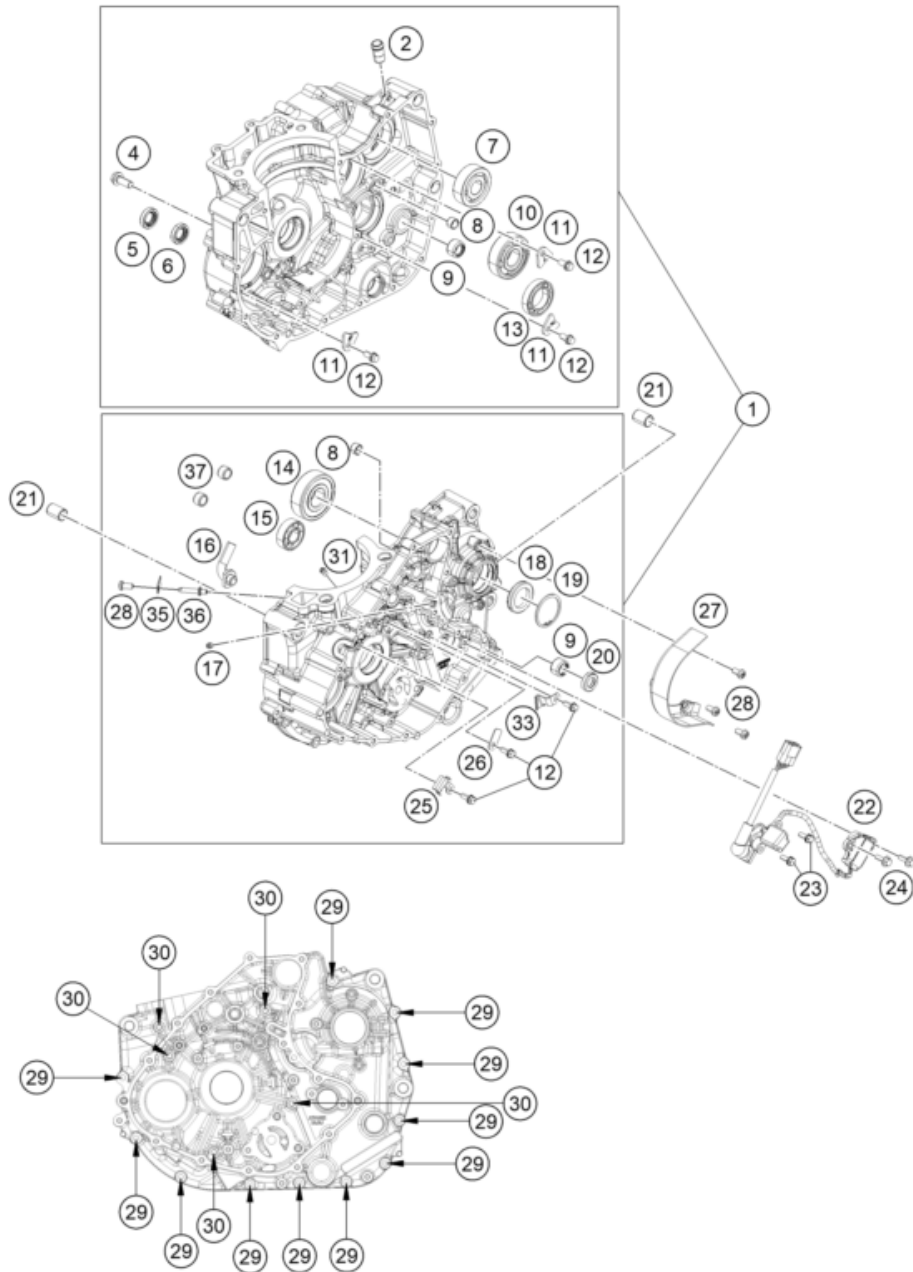

POS	PARTNUMBER		PIECE
1	9383000044	KIT CRCASE ANTHRBLK ADVDUK MY20	1
2	90230022000	Pipe breather	1
4	J011080203S	FLANGED BOLT M8X20	1
5	J760122455	SHAFT SEALING RING 12X24X5,5	1
6	0760122406	Shaft seal ring 12x24x6	1
7	90233010001	DEEP GROOVE BALL BEARING	1
8	90234030000	BUSH SHIFT RAIL	2
9	J618131912	NEEDLE ROLLER BEARING HK1312	2
10	J625063040	DEEP GROOVE BALL BEARING 6304	1
11	90230079000	STOPPER BALANCER SHAFT BEARING	3
12	J01665060123S	Hex collar screw, M6x12	6
13	90130004004	Bearing ball	1
14	J625063320	BALL BEARING 22X56X16-C3L-	1
15	J625062122	BALL BEARING 15X35X11-C3-1	1
16	90238014000	OIL PIPE	1
17	90230066100	OIL NOZZLE	1
18	90230077000	OIL SEAL OUTPUT SHAFT	1
19	J472037150	CIRCLIP 37X1,5	1
20	90130003004	Seal - oil	1
21	90130003007	DOWEL D14	2
22	93811023100	sensor assembly pick up	1
23	J011050133	HH COLLAR SCREW M5X13 SW8	5
24	J025050163S	FLANGED BOLT M5X16	2
25	93711022000	BRACKET HARNESS	1
26	93711021000	PLATE HARNESS	1
27	90230047000	CHAIN GUARD	1
28	J005060123S	SCREW PAN CROSS M6X12 PH SS	4
29	J025060353	Hex collar screw M6X35	11
30	J028060753S	FLANGED BOLT M6X75	5
31	90130164000	OIL NOZZLE	1
33	93711024000	BRACKET HARNESS GI SENSOR	1
35	93830066000	Bracket	1
36	93830064000	Nozzle	1
37	90240018000	BUSH STARTER SHAFT	2

179023010

53993

* NEW PART

X ON DEMAND

CLUTCH COVER

Motor 390 Adventure 2023

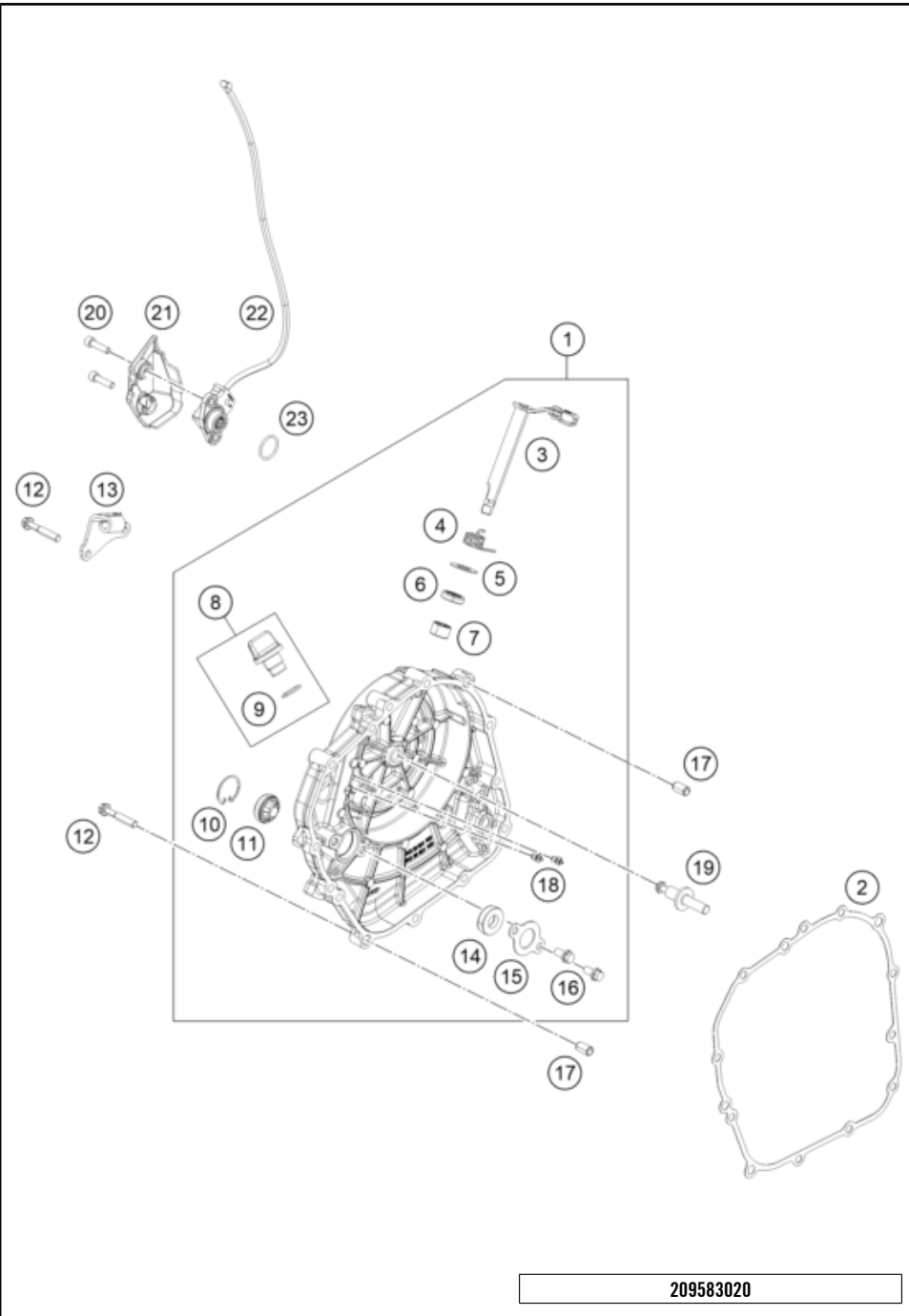

POS	PARTNUMBER		PIECE
1	94330001133	Clutch cover cmpl. with Quick Shifter	1
2	90230027000	GASKET CLUTCH COVER	1
3	90232048133	CLUTCH RELEASE LEVER CPL.	1
4	90232048003	SPRING F. RELEASE LEVER	1
5	90132048005	WASHER 12,5X24X0,8MM	1
6	90132051000	OIL SEAL RING	1
7	90132050000	needle bearing	1
8	90130020000	OIL PLUG CPL.	1
9	J770013824	O-RING 13,8X2,4	1
10	90130095001	WIRE CIRCLIP 28X1,5	1
11	90130095100	OIL GAUGE GLASS	1
12	J025060353	Hex collar screw M6X35	12
13	90230059100	BRACKET CLUTCH CABLE	1
14	90134127000	Oill seal ring	1
15	90230060001	STOPPER SHAFT SEAL RING	1
16	J01665060123S	Hex collar screw, M6x12	2
17	90130024000	PIN DOWEL 8X6,4X14MM	2
18	90130064000	OIL JET	2
19	90232048004	PULL ROD	1
20	J000150502000	bolt flanged-m5x0.8	2
21	94311024010	Cover. Quick-Shift sensor	1
22	94334051000	Shift shaft sensor	1
23	J770017721	O-RING 17,7X2,1 MM	1

209583020

53556

* NEW PART

X ON DEMAND

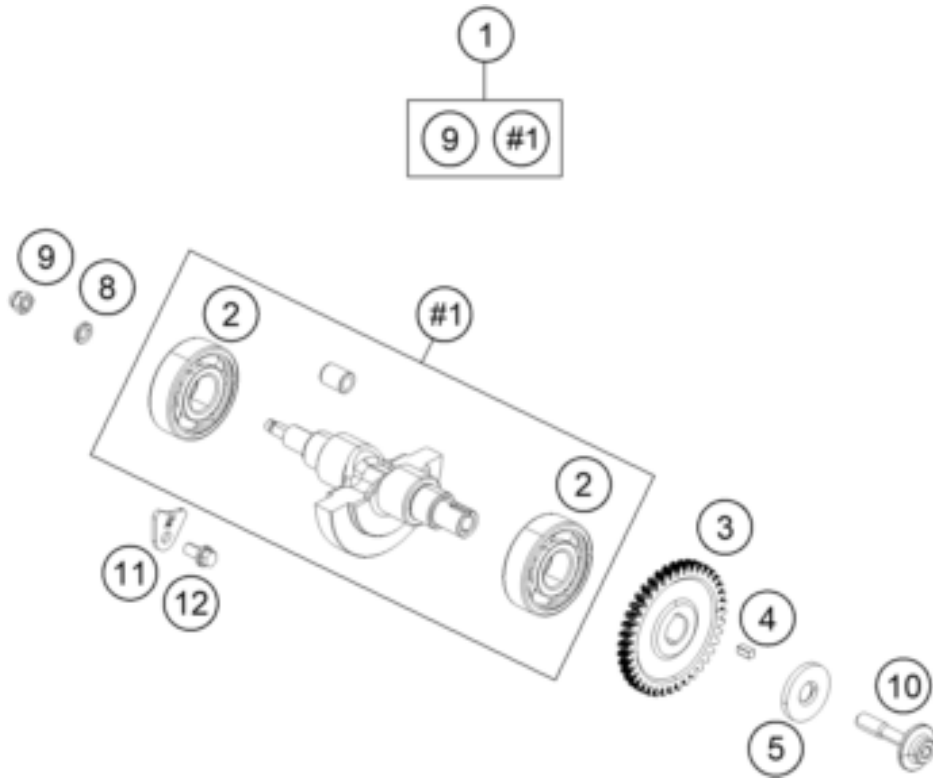

POS	PARTNUMBER		PIECE
1	94330057044	Balancer ASSEMBLY WITH Dom nut	1
2	J625063041	DEEP GR. BALL BEAR.6304 HN3 C3	2
3	90130055000	DRIVE WHEEL BALANCER SHAFT	1
4	90130055001	Parallel key	1
5	90130057150	Washer 8,2X26X3	1
8	90130055006	SPACER SHIM	1
9	90135058000	DOME NUT WAPU-WHEEL	1
10	90130055103	Special screw	1
11	90230079000	STOPPER BALANCER SHAFT BEARING	1
12	90130078001	FLANGED BOLT 6X12	1

209333030

54596

* NEW PART

X ON DEMAND

CYLINDER

Motor 390 Adventure 2023

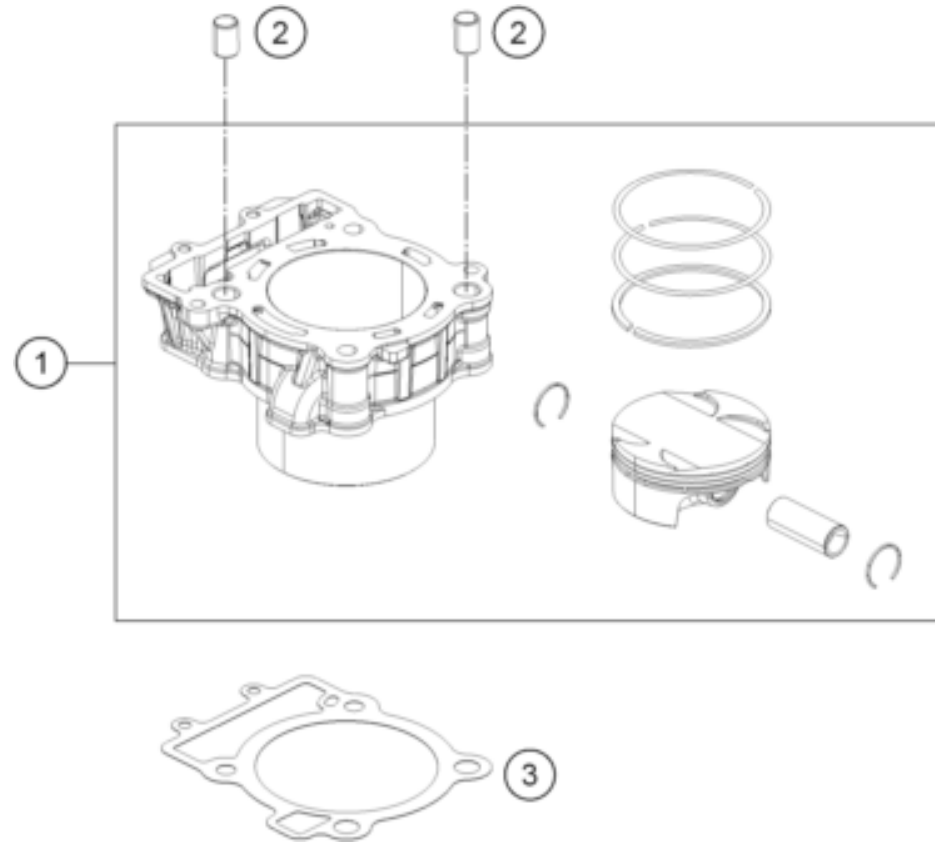

POS	PARTNUMBER		PIECE
1	93830038000	Cylinder + piston cpl.	1
2	90130003007	DOWEL D14	2
3	90230035000	GASKET CYLINDER BLOCK	1

139023040

49980

* NEW PART

X ON DEMAND

CRANKSHAFT, PISTON

Motor 390 Adventure 2023

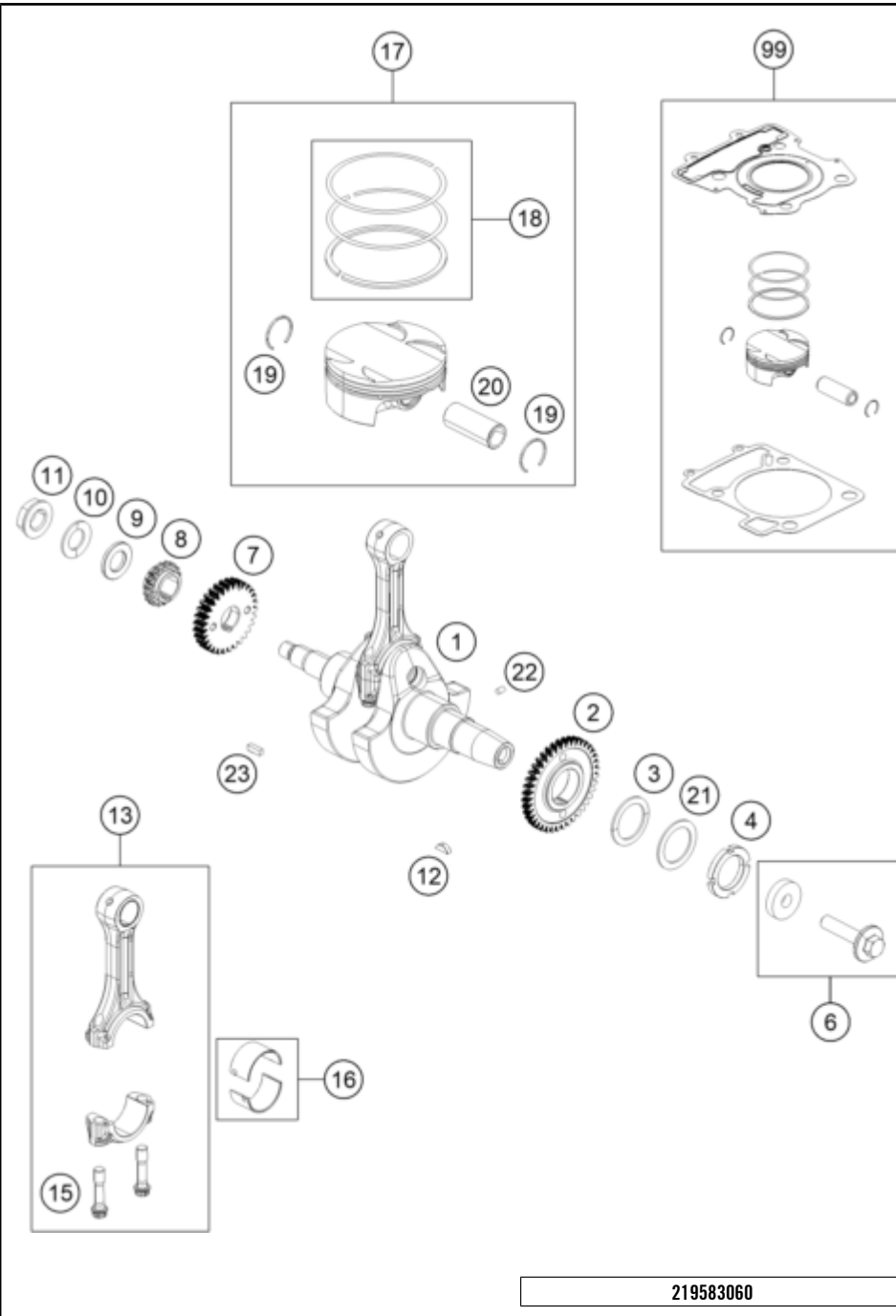

POS	PARTNUMBER		PIECE
1	94330018033	Crankshaft CPL	1
2	90230055000	GEAR BALANCER DRIVE	1
3	90230069000	CONICAL WASHER 28,35X38X1,75	1
4	90130018008	NUT FOR DRIVE WHEEL AGW	1
6	90239005050	ROTOR SCREW CPL.	1
7	90232023030	PRIMARY GEAR 30T	1
8	90236014000	SPROCKET CRANKSHAFT	1
9	90236015000	WASHER PLAIN	1
10	90236015001	SPECIAL WASHER	1
11	90230029000	NUT M16X1,5	1
12	J950001300400	KEY WOODRUFF	1
13	93830015033	CONROD ASSEMBLY	1
15	J900000903300	BOLT FLANGED M8.5X0.75	2
16	90230015010	CONROD BEARING SHELL	1
16	90230015011	CONROD BEARING SHELL (GREEN)	x
16	90230015012	CONROD BEARING SHELL (BLUE)	x
17	90230007200	PISTON D89	1
18	90230030010	PISTON RINGS CPL.	1
19	90230074000	RING SNAP	2
20	90230033000	PISTON PIN	1
21	90230068000	PLAIN WASHER 28,2X39X1,5	1
22	90134013000	Parallel pin	1
23	J888040150	Woodruff key 4X4X12	1
99	90230007010	PISTON KIT 390 DUKE 2013	1

219583060

59562

* NEW PART

X ON DEMAND

CLUTCH

Motor 390 Adventure 2023

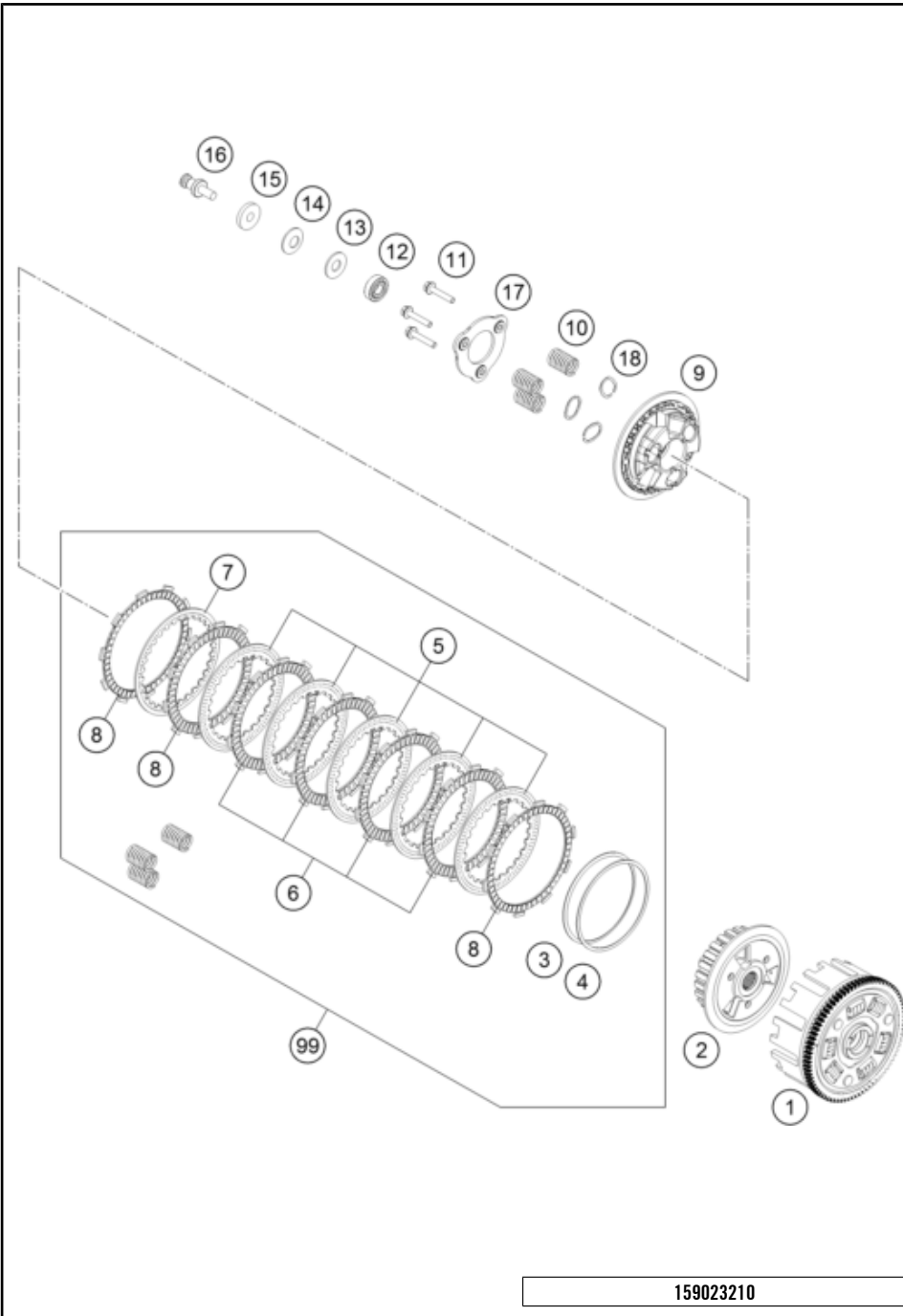

POS	PARTNUMBER		PIECE
1	93832101033	Outer clutch hub	1
2	90232102000	INNER CLUTCH HUB	1
3	90232134000	JUDDER SPRING	1
4	90232135000	SEAT JUDDER SPRING	1
5	90232010100	INTERMEDI. DISC A	5
6	90232011000	LINING DISC	4
7	90232110000	INTERMEDI. DISC B	1
8	90232211000	LINING DISC TURNED OFF	3
9	90232103000	PRESSURE PLATE	1
10	90232105000	CLUTCH SPRING	3
11	90232101101	HH COLLAR SCREW M6X35	3
12	J625069020	BALL BEARING 6902 15X28X7	1
13	90232017000	SHIM	1
14	90236015001	SPECIAL WASHER	1
15	90232019000	NUT F. CLUTCH	1
16	90232048004	PULL ROD	1
17	90232006000	STOPPER PLATE	1
18	90232004000	SPRING SEAT	3
99	90232111010	CLUTCH KIT 390 DUKE 15	x

159023210

51436

* NEW PART

X ON DEMAND

TRANSMISSION I - MAIN SHAFT

Motor 390 Adventure 2023

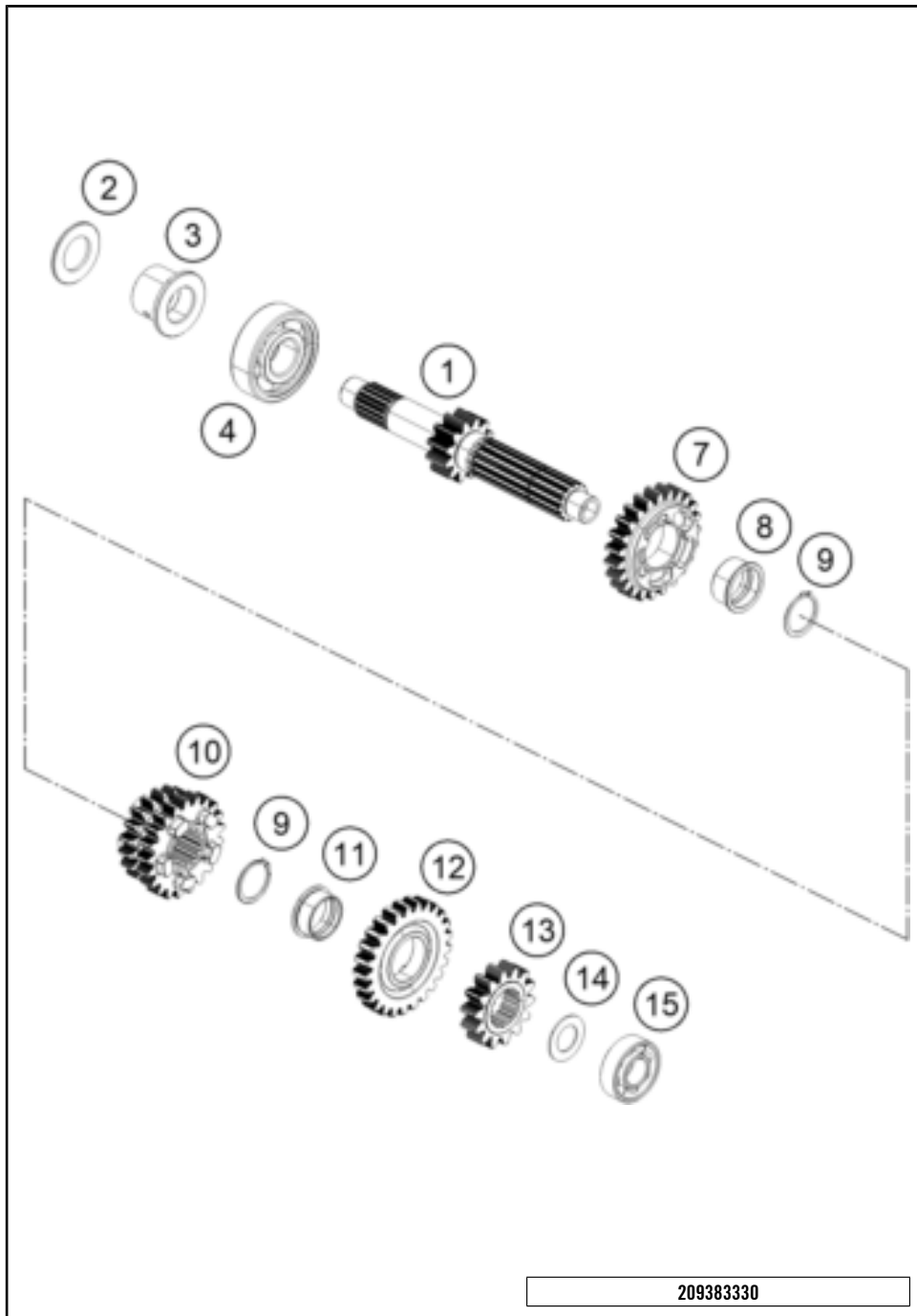

POS	PARTNUMBER		PIECE
1	90233001000	MAIN SHAFT	1
2	90232020000	WASHER	1
3	90232016000	COLLAR BUSH	1
4	J625063040	DEEP GROOVE BALL BEARING 6304	1
7	90233005000	GEAR 5TH DRIVE	1
8	90233005001	COLLAR BUSH	1
9	J471020123	CIRCLIP 20,5X1,2	2
10	90233003000	GEAR 3RD/4TH DRIVE	1
11	90233006001	COLLAR BUSH	1
12	90233006000	GEAR 6TH DRIVE	1
13	90233002000	GEAR 2ND DRIVE	1
14	90233036000	WASHER TRUST 2ND DRIVE	1
15	J625062122	BALL BEARING 15X35X11-C3-1	1

209383330

53996

* NEW PART X ON DEMAND

TRANSMISSION II - COUNTERSHAFT

Motor 390 Adventure 2023

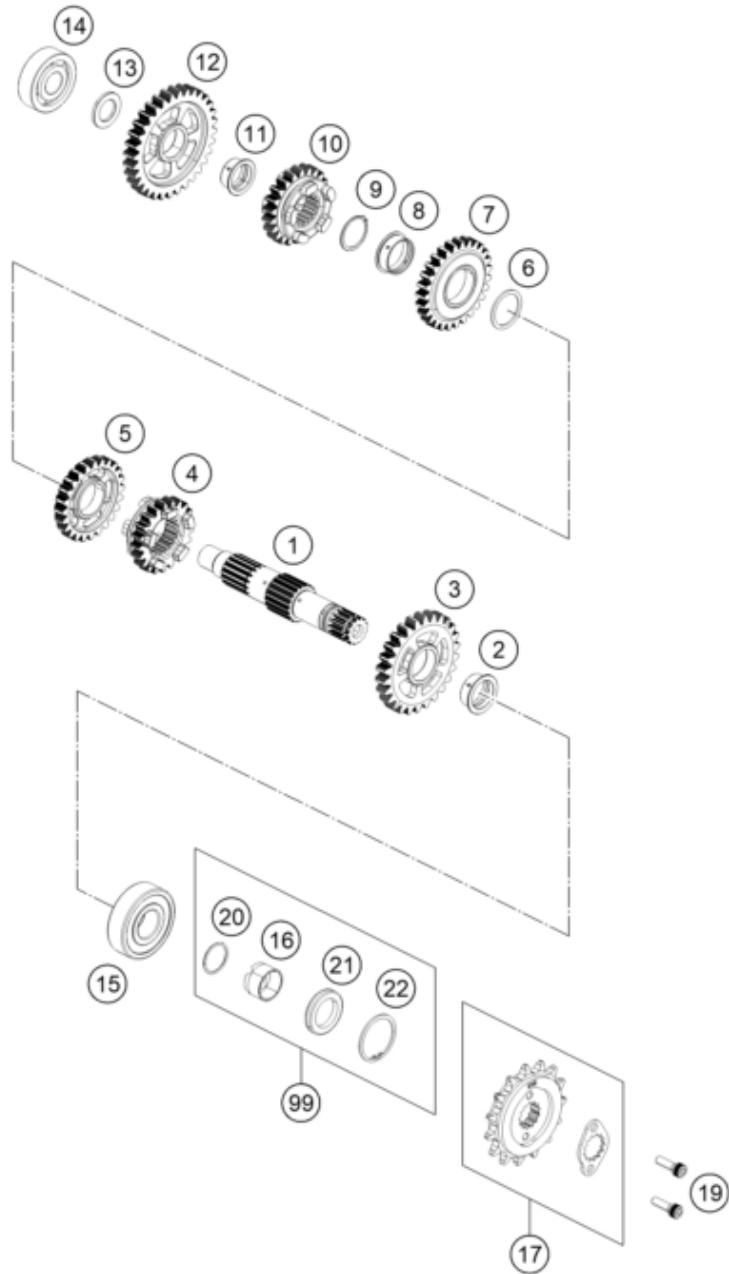

POS	PARTNUMBER		PIECE
1	90233010010	COUNTERSHAFT CPL.	1
2	90233012001	COLLAR BUSH	1
3	90233012000	GEAR 2ND DRIVEN	1
4	90233016000	GEAR 6TH DRIVEN	1
5	90233014000	GEAR 4TH DRIVEN	1
6	90233037000	THRUST WASHER	1
7	90233013000	GEAR 3RD DRIVEN	1
8	90233013001	COLLAR BUSH	1
9	J472023120	CIRCLIP 23,5X1,2	1
10	90233015000	GEAR 5TH DRIVEN	1
11	90233011001	COLLAR BUSH	1
12	90233011000	GEAR 1ST DRIVEN	1
13	90233038000	THRUST WASHER	1
14	90233010001	DEEP GROOVE BALL BEARING	1
15	J625063320	BALL BEARING 22X56X16-C3L-	1
16	90233030000	BUSHING SPROCKET	1
17	90833029044	SPROCKET 15T W. LOCKING PLATE	1
19	90110057000	BOLT M6X10	2
20	J770019515	O-RING 19,5X1,5	1
21	90230077000	OIL SEAL OUTPUT SHAFT	1
22	J472037150	CIRCLIP 37X1,5	1
99	90233030044	SEALING KIT COUNTERSHAFT	x

149023361

15574

* NEW PART

X ON DEMAND

SHIFTING MECHANISM

Motor 390 Adventure 2023

Skalierung: 50%, 75%

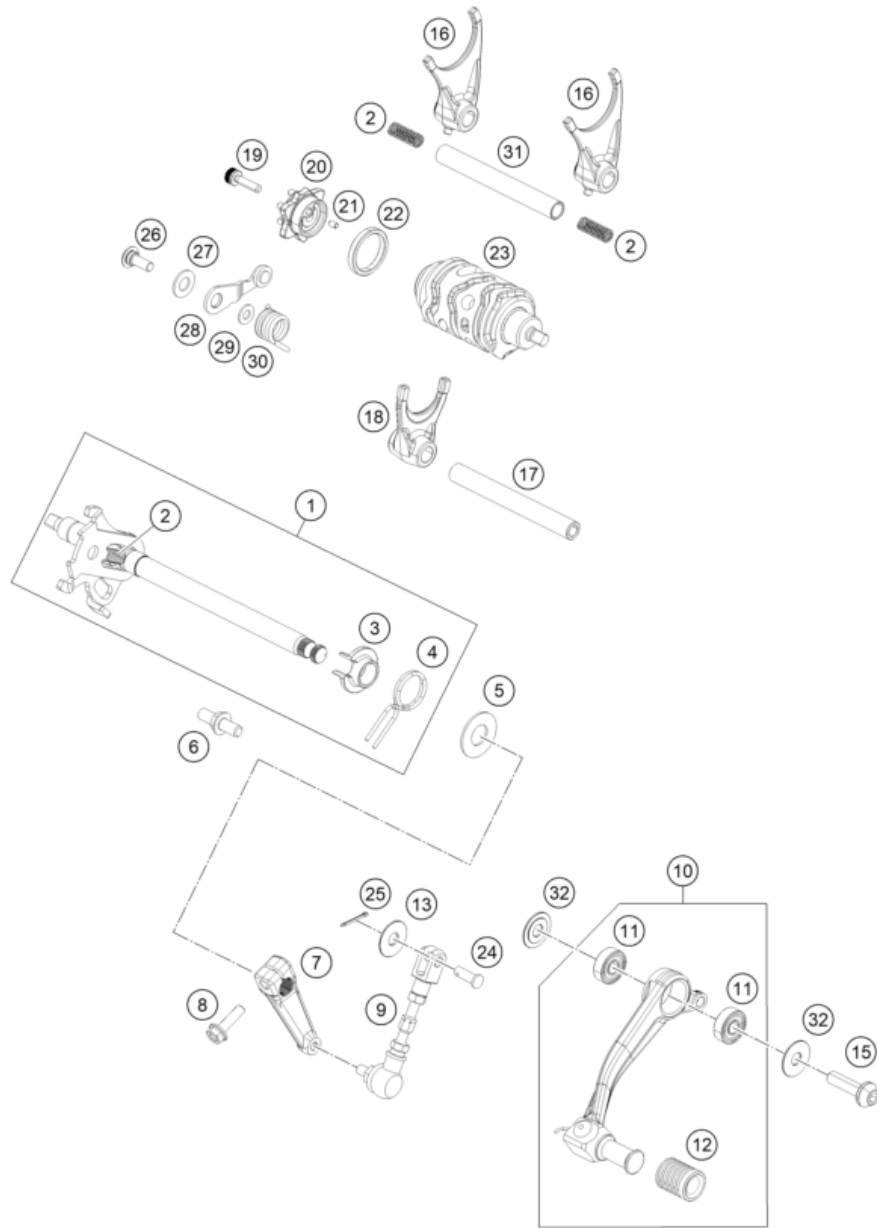

209583410

POS	PARTNUMBER		PIECE
1	94334005033	Shift shaft cmpl. With quick shifter	1
2	90134009000	TENSION SPRING	3
3	90134022000	SPRING BUSHING	1
4	90134014000	RETURN SPRING	1
5	90134050000	STOP DISK 14X30X1,5	1
6	90134016000	SPRING GUIDE	1
7	93034031010	Linkage gear shift lever	1
8	J025060221	Bolt-Flange-Kad ST-D DIA-06 L-22	1
9	95834036000	Shift linkage	1
10	95834031044	Gear shift lever, PREASSEMBLED	1
11	J625060800	BALL BEARING 608	2
12	95834035000	Pedal rubber	1
13	J125070001	Washer nylon 6.5X16X1	1
15	90134034300	BOLT SHIFT LEVER silver	1
15	90534034300	BOLT SHIFT LEVER black	1
16	90234002000	SHIFT FORK	2
17	90234019000	SHIFT RAIL	1
18	90234001000	SHIFT FORK	1
19	90134098000	Bolt socket head M6X1X20 L-precoated	1
20	94334015000	Detent	1
21	90134013000	Parallel pin	1
22	90134012002	SPACER	1
23	93834012000	DRUM GEAR SHIFT	1
24	J920000601600	Pin	1
25	J710000400600	circlip type e	1
26	90134025000	SCREW LOCKING LEVER	1
27	90134030000	WASHER LOCKING LEVER	1
28	90134024033	LOCKING LEVER CPL.	1
29	J125061416	Washer, 6x14x1.2	1
30	94334023000	Detent arm spring	1
31	93834020000	Gear shift rail	1
32	90534031020	WASHER SHIFTING LEVER	2

53188

* NEW PART

X ON DEMAND

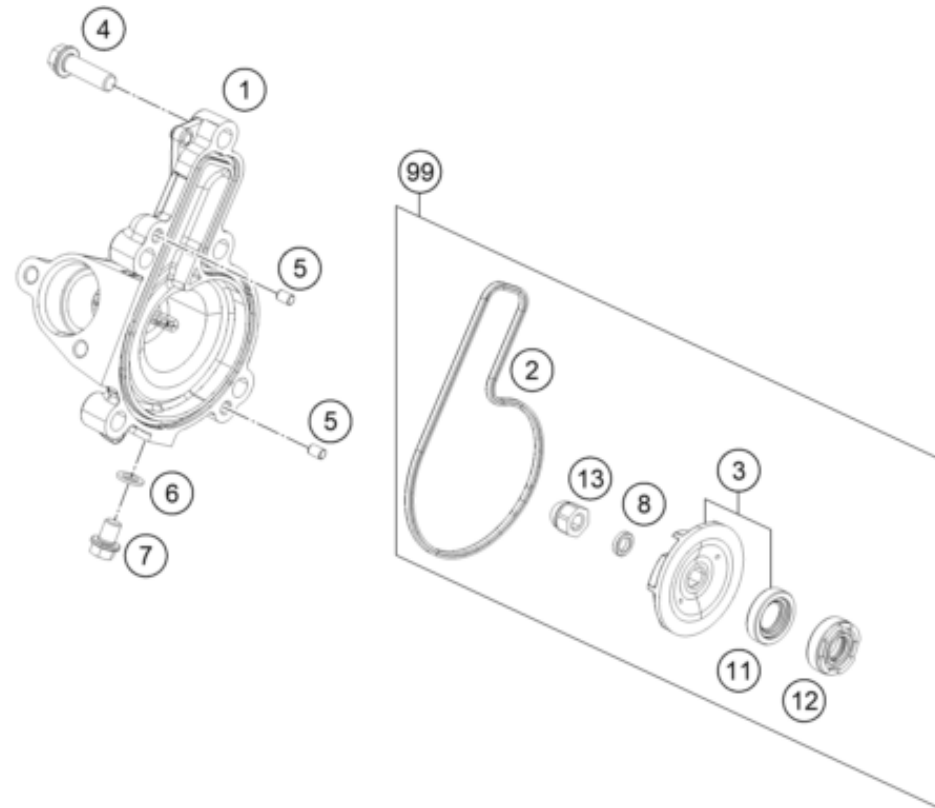

POS	PARTNUMBER		PIECE
1	91235052000	WATER PUMP COVER	1
2	90135053000	WATER PUMP COVER GASKET	1
3	90135055044	KIT WATER PUMP ROTOR & SEAL	1
4	J025060224	Hexagonal bolt M6x22	5
5	90134013000	Parallel pin	2
6	J603061001	COPPER GASKET	1
7	J025060104	Hex collar screw M6X10	1
8	90130055006	SPACER SHIM	1
11	J760122455	SHAFT SEALING RING 12X24X5,5	1
12	0760122406	Shaft seal ring 12x24x6	1
13	90135058000	DOME NUT WAPU-WHEEL	1
99	90135055210	Water pump rep. kit duke	x

179023510

53863

* NEW PART

X ON DEMAND

COOLING SYSTEM

Motor 390 Adventure 2023

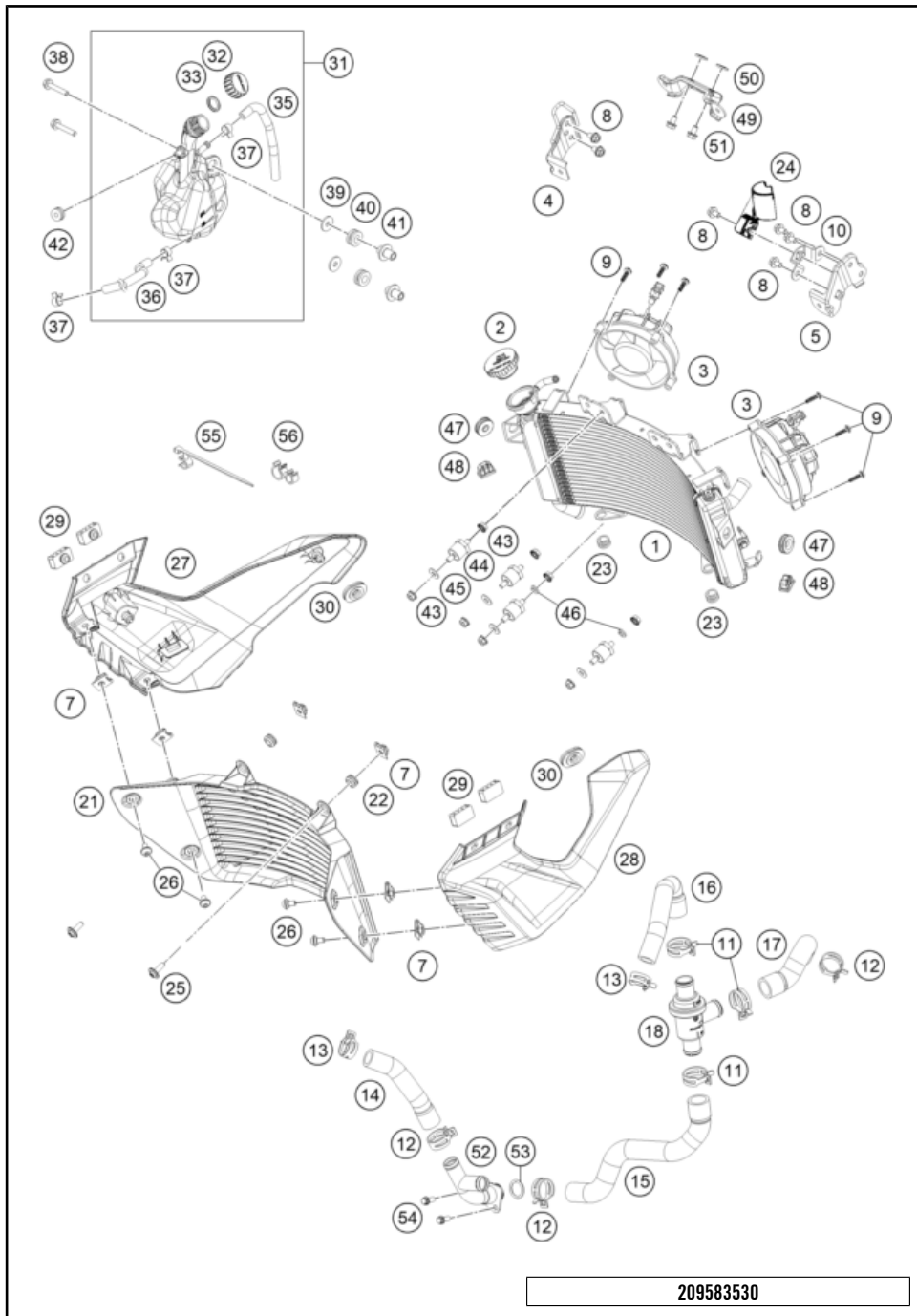

POS	PARTNUMBER		PIECE
1	95835010000	Radiator	1
2	90135016100	RADIATOR CAP	1
3	95835041044	Radiator fan, cmpl	2
4	95803006001	Radiator retaining plate, bottom right	1
5	95803005001	Radiator retaining plate, bottom left	1
7	93008084010	Range change metal nut M6	6
8	J025060103	HH COLLAR SCREW M6X10 SW10	6
10	95835013050	Bracket holder thermostat	1
11	90135020003	HOSE CLAMP D28	3
12	90135020001	hose clamp D26	3
13	90135020000	HOSE CLAMP D23	2
14	95835024030	Radiator hose, radiator hose for T-piece	1
15	94335026000	Pipe thermostat-joint t pcs.	1
16	95835026100	Radiator hose, radiator thermostat	1
17	93035025000	Pre-formed hose	1
18	90135017000	THERMOSTAT	1
21	95835040000	radiator protection	1
22	93014017000	Rubber bushing	2
23	95835016000	Rubber grommet	2
24	93035017050	THERMOSTAT HALTER	1
25	J031060101	screw butn hd-m6x1xl10xblkxstep	2
26	J031060143	screw truss-m6x1xl 14xblack	4
27	95808061000	cooler cover right	1
28	95808060000	cooler cover left	1
29	93007040010	Seat cowl pad	4
30	90108060003	GROMMET	2
31	95835065033	Reservoir cmpl.	1
32	90135066000	PLUG F. EXPANSION TANK	1
33	90102055000	COMPENSATING TANK O-RING	1
35	95835067010	Hose for reservoir	1
36	95835067000	Hose for reservoir	1
37	90107018011	CLAMP 10MM	2
38	J900000603300	HEX HD BOLT FLANGE M6	2
39	J126062020	WASHER 6,5X2 MM	2
40	93032060010	GROMMET CLUTCH CABLE GUIDE	2
41	95835065020	Collar bushing	2
42	90135065050	GROMMET EXPANSION TANK	1
43	J926060003	nut hex flange-m6x1xht.6xcl4xblk	8

* NEW PART

X ON DEMAND

COOLING SYSTEM

Motor 390 Adventure 2023

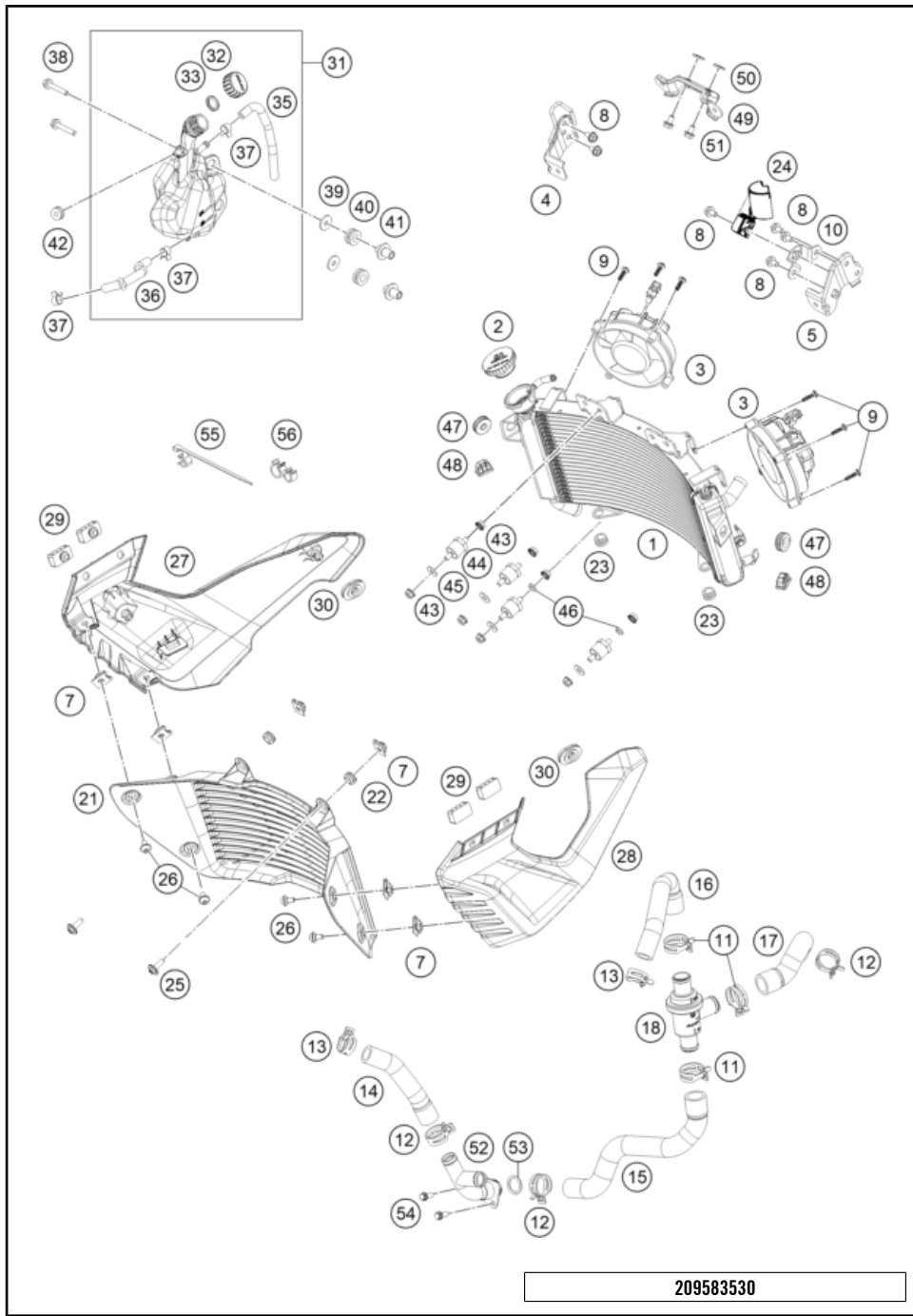

POS	PARTNUMBER		PIECE
44	93335001000	SILENTBLOCK M6	4
45	J125070004	washer plain-id6.5xod16xthk1xblk	4
46	J127060001	Spring ring B6	2
47	95808060020	Rubber grommet	2
48	95835037000	Rubber grommet, radiator spoiler	2
49	93035004000	Support	1
50	J125090006	Washer 9,2X16X2	2
51	J025060101	Hexagon screw M6X10	2
52	90635071033	COOLANT PIPE T	1
53	J770018530	O-RING 18,5X3	1
54	J025060141	Hex collar screw M6X14	2
55	95835068000	Strap-clip swivel	1
56	95835069000	Strap-clip swivel	1

209583530

18574

* NEW PART

X ON DEMAND

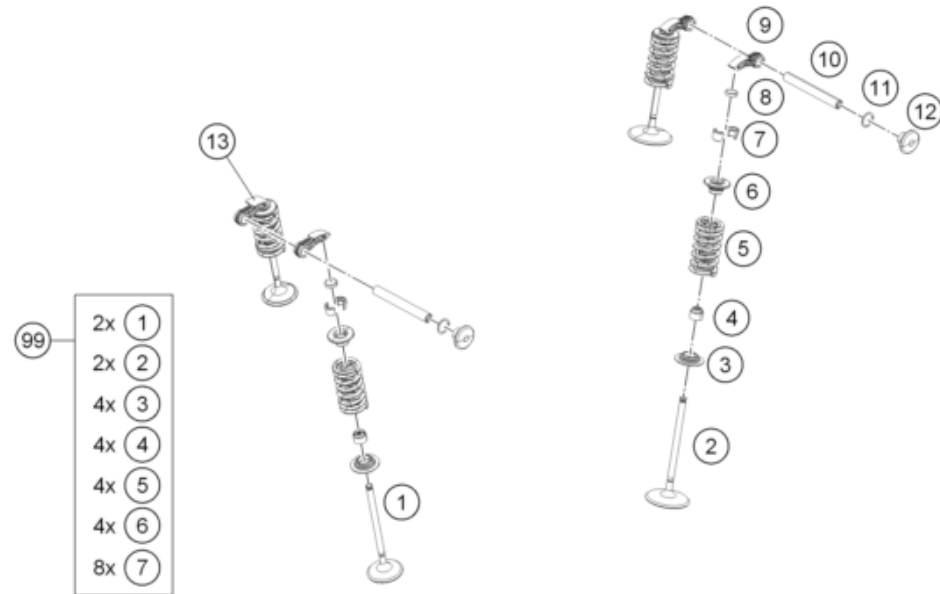

POS	PARTNUMBER		PIECE
1	93836031000	Exhaust valve	2
2	90236030000	INTAKE VALVE	2
3	90236036000	valve spring washer	4
4	90236027000	valve stem seal	4
5	90236028010	VALVE SPRING SET	4
6	90236032000	VALVE SPRING RETAINER	4
7	90236033000	VALVE COLLET	8
8	60036035185	SHIM D=10/1,85 03	x
8	60036035190	SHIM D=10/1,90 03	x
8	60036035195	SHIM D=10/1,95 03	x
8	60036035200	SHIM D=10/2,00 03	x
8	60036035205	SHIM D=10/2,05 03	x
8	60036035210	SHIM D=10/2,10 03	x
8	60036035215	SHIM D=10/2,15 03	x
8	60036035220	SHIM D=10/2,20 03	x
8	60036035225	SHIM D=10/2,25 03	x
8	60036035230	SHIM D=10/2,30 03	x
8	60036035235	SHIM D=10/2,35 03	x
8	60036035240	SHIM D=10/2,40 03	x
8	60036035245	SHIM D=10/2,45 03	x
8	60036035250	SHIM D=10/2,50 03	x
8	60036035255	SHIM D=10/2,55 03	x
8	60036035260	SHIM D=10/2,60 03	x
8	60036035265	SHIM D=10/2,65 03	x
8	60036035270	SHIM D=10/2,70 03	x
8	60036035275	SHIM D=10/2,75 03	x
8	60036035280	SHIM D=10/2,80 03	x
8	60036035285	SHIM D=10/2,85 03	x
8	60036035290	SHIM D=10/2,90 03	x
8	60036035295	SHIM D=10/2,95 03	x
8	60036035300	SHIM D=10/3,00 03	x
8	60036035305	SHIM D=10/3,05 03	x
8	60036035310	SHIM D=10/3,10 03	x
8	60036035315	SHIM D=10/3,15 03	x
8	60036035320	SHIM D=10/3,20 03	x
8	60036035330	SHIM D=10/3,3	x
9	90136060000	cam follower	3
10	90236056000	VALVE LEVER SHAFT	2

139023610

51788

* NEW PART

X ON DEMAND

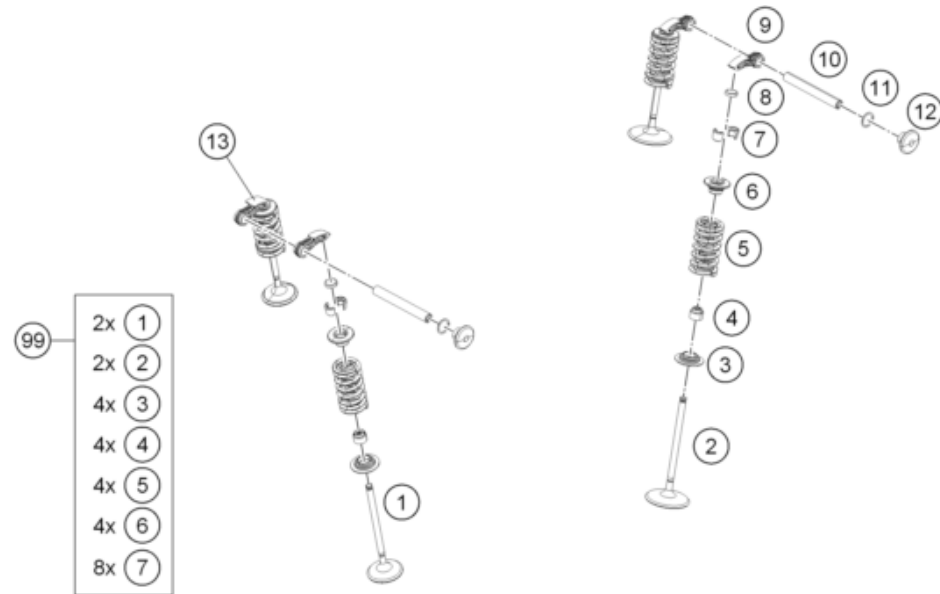

POS	PARTNUMBER		PIECE
11	J770010312	O-RING 10,3X1,2 MM	2
12	90136056001	SCREW PLUG	2
13	90236060000	VALVE LEVER	1
99	90236030010	VALVE KIT 390 DUKE	x

139023610

51788

* NEW PART

X ON DEMAND

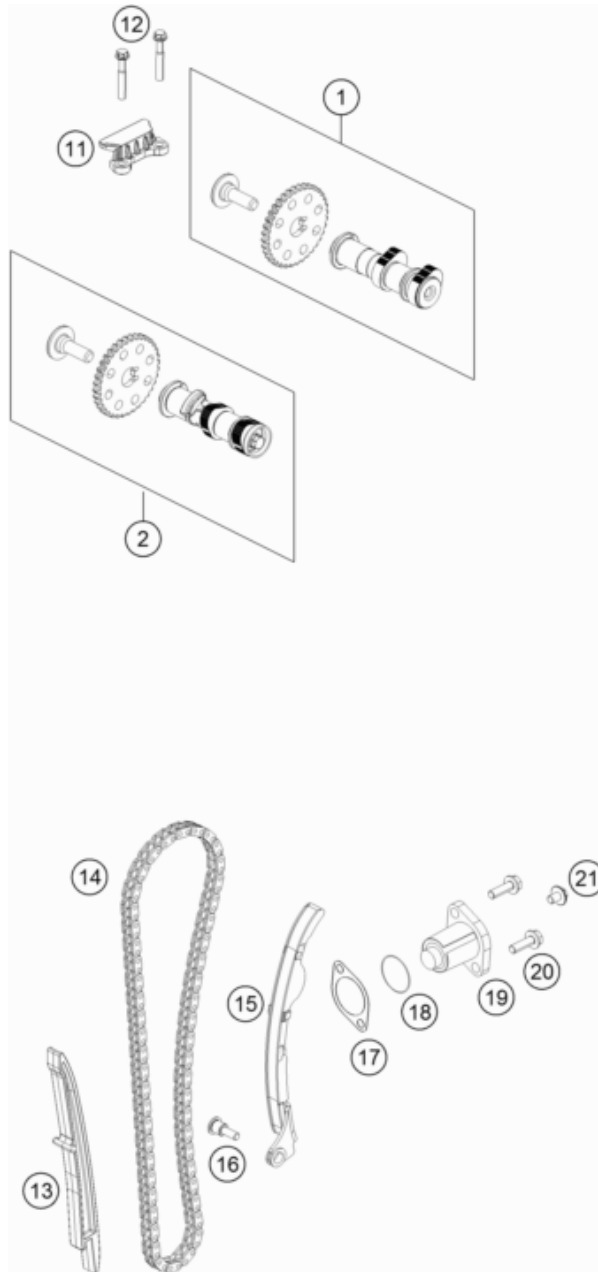

POS	PARTNUMBER		PIECE
1	93836009033	Camshaft inlet valve, complete	1
2	93836010033	Camshaft exhaust valve, complete	1
11	90236018000	CHAIN GUIDE TOP	1
12	J025060453	HH COLLAR SCREW M6X45	2
13	90236001000	TIMING CHAIN GUIDE	1
14	90236013000	TIMING CHAIN	1
15	90236002000	TENSIONER RAIL CPL.	1
16	90236002004	SCREW TENSIONER RAIL	1
17	90136003003	GASKET CHAIN ADJUSTER	1
18	J770010015	O-RING 10,15X1,5	1
19	90236003044	CHAIN ADJUSTER	1
20	J025060204	Hex collar screw M6X20	2
21	90136003002	SPECIAL SCREW 6X6	1

169383620

51628

* NEW PART

X ON DEMAND

CYLINDER HEAD

Motor 390 Adventure 2023

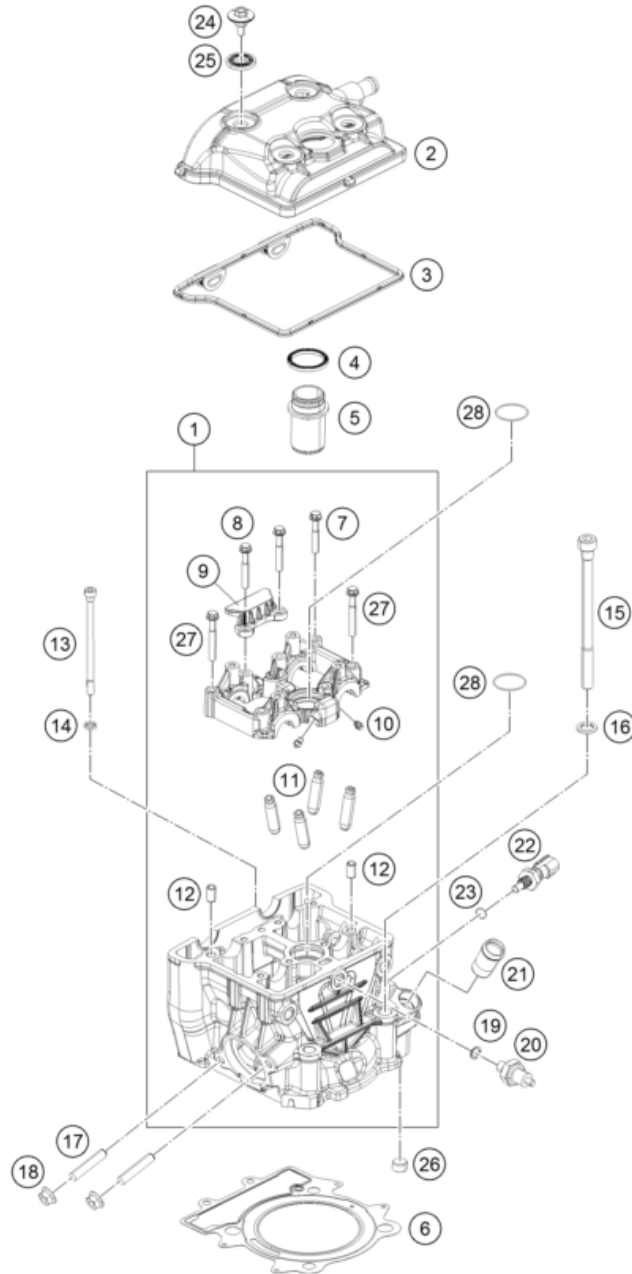

POS	PARTNUMBER		PIECE
1	93836020033	Head Cylinder with Camholder	1
2	93336052100	Valve mechanism cover compl.	1
3	93836053000	Gasket rubber	1
4	90236054000	GASKET SPARK PLUG SHAFT	1
5	90236074000	SPARK PLUG SHAFT	1
6	93830036000	Gasket Cylinder Head	1
7	J025060359	Hexagon screw M6X35	4
8	J025060453	HH COLLAR SCREW M6X45	2
9	90236018000	CHAIN GUIDE TOP	1
10	90130064000	OIL JET	4
11	90236025000	VALVE GUIDE	4
12	90130024000	PIN DOWEL 8X6,4X14MM	2
13	J912061026	intake funnel	2
14	J125070003	WASHER 7X11X2	2
15	J912101449	SOCKET HEAD SCREW M10X144	4
16	J125110003	WASHER 11,2X18X2	4
17	90136020001	STUD M8	2
18	J926080003	Hex collar nut M6	2
19	90138091001	O-RING	1
20	90138091000	OIL PRESSURE SENSOR	1
21	90235019000	PIPE COOLANT	1
22	90135047000	TEMPERATURE SENSOR	1
23	90135047001	O-RING	1
24	90136052020	VALVE COVER SCREW	4
25	90136052010	DECOUPLING ELEMENT	4
26	90236024000	PLUG	1
27	J025060401	HH COLLAR SCREW M6X40	2
28	J770029819	O-RING 29,8X1,9	2

179023630

53558

* NEW PART

X ON DEMAND

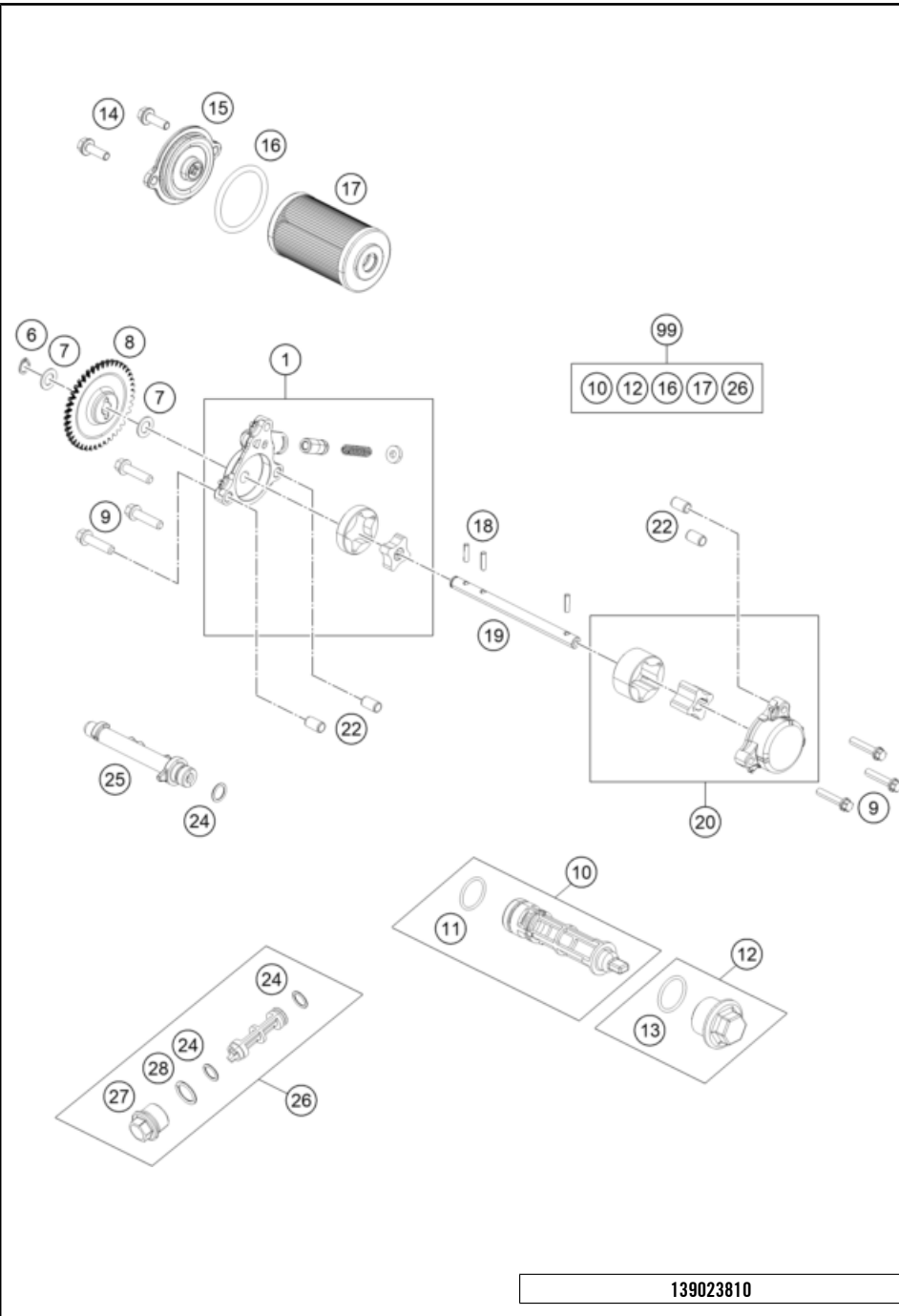

139023810

POS	PARTNUMBER		PIECE
1	90238010044	OIL PUMP CPL.	1
6	J471010100	Seeger ring 10X1,0	1
7	J125100006	WASHER 10,2X18X1	2
8	90238001000	GEAR OIL PUMP	1
9	J028060303S	HH COLLAR SCREW M6X30 WS8	6
10	90238015033	MESH STRAINER CPL.	1
11	J770017721	O-RING 17,7X2,1 MM	1
12	90138015050	CLOSURE CAP OIL SCREEN	1
13	90138015052	O-RING	1
14	J025060161	Hex collar screw M6X16	2
15	90138006000	OIL FILTER CAP	1
16	J770039326	O-RING 39,34X2,62	1
17	90138015000	OIL FILTER	1
18	90238003000	PARALLEL PIN	3
19	90238002000	SHAFT OIL PUMP	1
20	90238008044	OIL PUMP CPL.	1
22	90130024000	PIN DOWEL 8X6,4X14MM	4
24	J7700090151	O-RING 9X1,5	3
25	90238013000	OIL RAIL	1
26	90238016044	MESH STRAINER CPL.	1
27	90238017000	CAP STRAINER	1
28	J770012520	O-RING 12,5X2	1
99	90238015010	OILFILTER SERVICE KIT 390 DUKE	x

50781

* NEW PART

X ON DEMAND

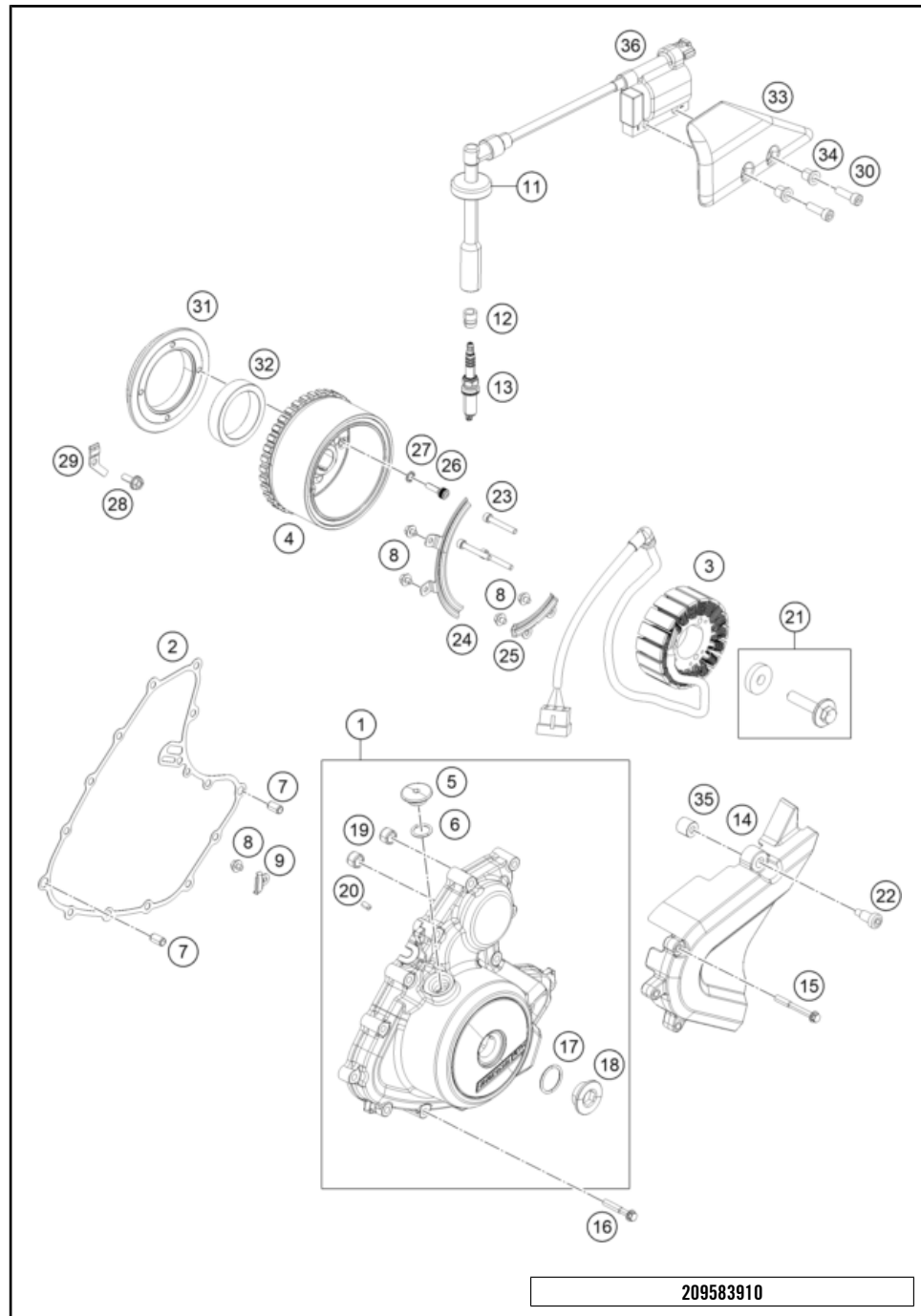

POS	PARTNUMBER		PIECE
1	93730002233	Ignition cover compl.	1
2	93830040000	Ignition cover gasket	1
3	94339004033	Stator compl.	1
4	94339005033	Rotor compl.	1
5	93839010100	Screw plug, OT marking	1
6	J770015824	O-RING 15,8X2,4	1
7	90130024000	PIN DOWEL 8X6,4X14MM	2
8	J025050081	Hex collar screw M5X8	5
9	90230062000	BRACKET HARNESS MAGNETO	1
11	90239090001	RUBBER GASKET SPARK PLUG	1
12	93839091000	Sealing boot spark plug	1
13	93839093000	Spark plug BOSCH VR6NEU M12X1.25	1
14	90230060002	front sprocket cover	1
15	J025060506	Hex collar screw M6X50	3
16	J025060353	Hex collar screw M6X35	12
17	J770024015	O-RING 24X2,5	1
18	90230094000	PLUG SCREW M24X1,5	1
19	90240018000	BUSH STARTER SHAFT	2
20	90230066300	OIL NOZZLE	1
21	90239005050	ROTOR SCREW CPL.	1
22	93003082000	Bolt socket M6X1XL22 BLK stepped	1
23	J912050353S	AH SCREW M5X35 SELF LOCKING	3
24	90230058000	PLATE HARNESS MAGNETO	1
25	93730059000	PLATE HARNESS 2	1
26	90130001001	SOCKET HEAD SCREW M6X20	4
27	J797060003	TOOTHED WASHER M6	4
28	J028060164	BOLT FLANGE M6X16	1
29	90240020002	RETAINER GEAR STARTER	1
30	J912060353	Hexagon screw M6X35	2
31	90130001000	SUPPORT FREEWHEEL CLUTCH	1
32	90140026000	FREEWHEEL CLUTCH	1
33	93039010000	cover ignition coil	1
34	93039011000	sleeve cover ignition coil	2
35	93003081000	Distance bushing sprocket cover	1
36	93339006033	Ignition coil compl.	1

209583910

57992

* NEW PART

X ON DEMAND

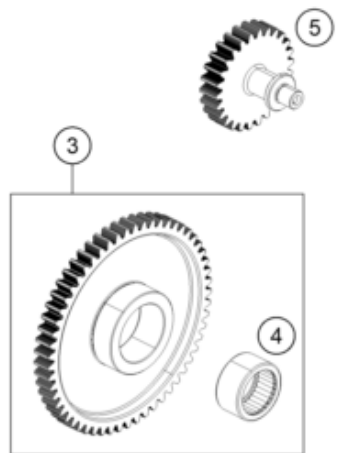
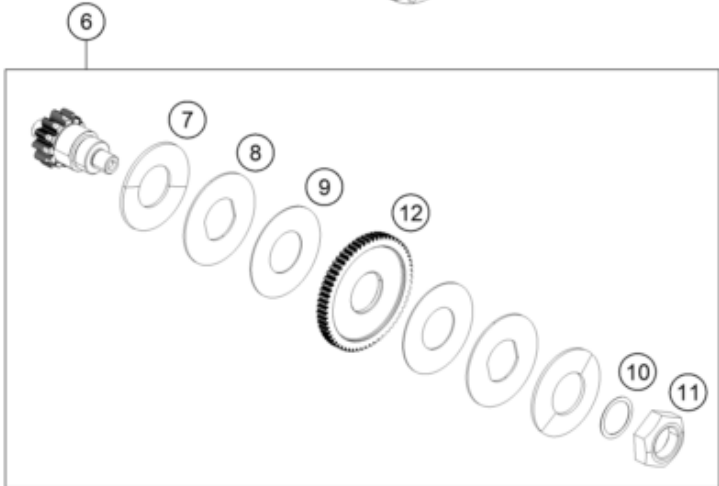
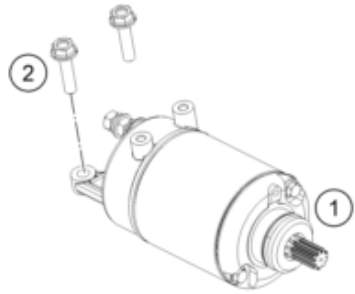

POS	PARTNUMBER		PIECE
1	94340001000	E-starter cmpl.	1
2	J025060256	HH COLLAR SCREW M6X25 SW10	2
3	90240020000	GEAR STARTER CLUTCH CPL.	1
4	J618253216	NEEDLE ROLLER BEARING HK2516	1
5	90240022000	GEAR STARTER COUNTER	1
6	90240023033	GEAR STARTER COUNTER CPL.	1
7	90240023006	CONICAL WASHER	2
8	90240023005	WASHER	2
9	90240023004	PAD FRICTION	2
10	90240023007	SHIM STARTER 0,30MM	x
10	90240023008	SHIM STARTER 0,45MM	x
10	90240023009	SHIM STARTER 0,60MM	x
10	90240023010	SHIM STARTER 0,75MM	x
11	90240023003	NUT STARTER COUNTER	1
12	90240023002	GEAR STARTER COUNTER	1

202814010

53559

* NEW PART

X ON DEMAND

THROTTLE BODY

Motor 390 Adventure 2023

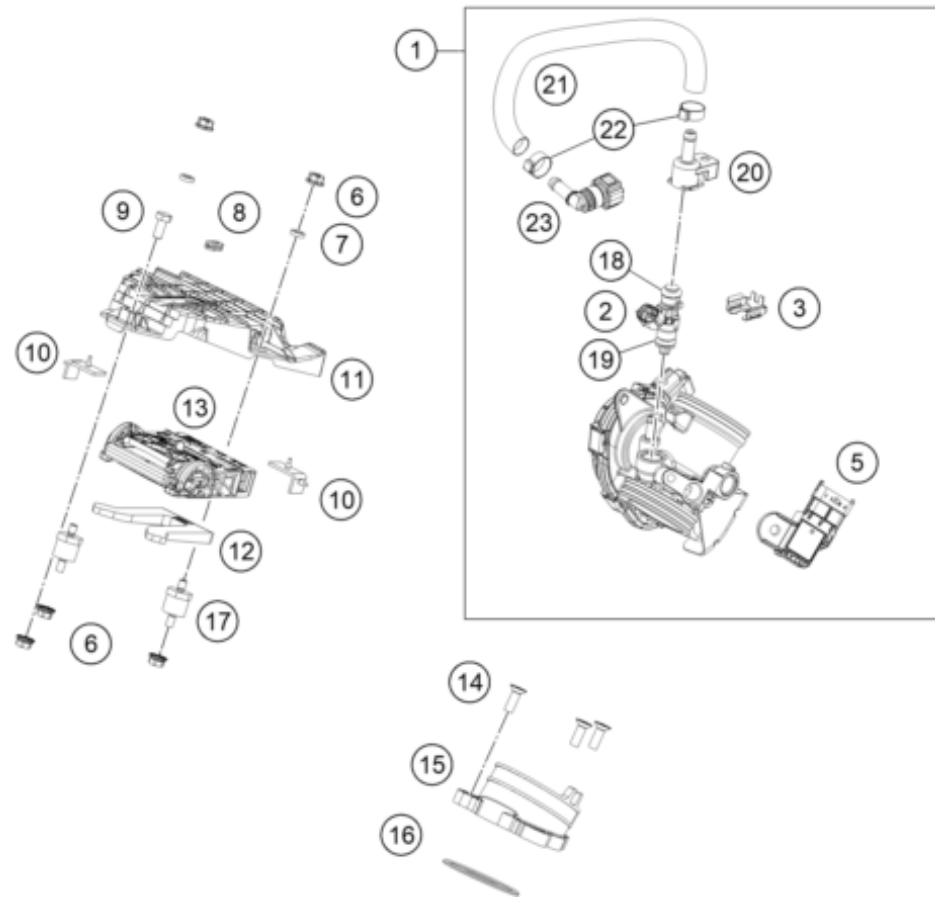

POS	PARTNUMBER		PIECE
1	95841001133	BODY THROTTLE ASSEMBLY	1
2	90241023000	FUEL INJECTOR	1
3	90141001001	INJECTOR CLIP	1
5	93041085000	Pressure sensor	1
6	J926060000	FLANGED NUT M6 WS10 SELF LOCK.	3
7	93041029020	Sleeve	2
8	93541034000	DAMPER ECU	1
9	J933060146	Hexagonal bolt M6x14	1
10	93841036000	rubber band, ECU	2
11	93041029000	Control unit bracket	1
12	93041030100	Rubber cowl pad	1
13	94341031000	Engine control unit	1
14	J991060203S	COUNTERSUNK SCREW M6X20	3
15	90241002000	PIPE INTAKE	1
16	J770053024	O-RING 53X2,4	1
17	93011038000	Bump rubber ECU support	2
18	55641023020	O-ring	1
19	55641023010	O-ring	1
20	95841037000	Connecting piece, fuel line	1
21	J600000823100	PIPE FUEL	1
22	J300000701600	Oetiker clamp D=14	2
23	28107028000	Angle piece	1

229584110

57991

* NEW PART

X ON DEMAND

A large, empty rectangular box with a thin black border, occupying the majority of the page. It is intended for the user to write their notes for the 'Motor 390 Adventure 2023'.

A large, empty rectangular box with a thin black border, occupying the majority of the page. It is intended for the user to write their notes for the 'Motor 390 Adventure 2023'.

KTM.COM



081290WEN

KTM Sportmotorcycle GmbH
5230 Mattighofen, Austria
www.ktm.com

KTM POWERPARTS

KTM POWERWEAR

KTM ORIGINAL SPARE PARTS



Art. Nr.: 081290WEN 11. Okt 2022