

Engine 450 SMR 2023

ART.-NR.: 089580WEN





All information contained is without obligation. KTM Sportmotorcycle GmbH particularly reserves the right to modify any equipment, technical specifications, prices, colors, shapes, materials, services, service work, constructions, equipment and the like so as to adapt them to local conditions or to cancel any of the above items, all without previous announcement and without giving reasons. KTM may stop manufacturing certain models without previous notice. KTM shall not be held liable for any deviations of availability and/or ability to deliver, illustrations, descriptions, printing and/or other errors. The illustrated models partly contain extra equipment, which is not applied to standard models.

© by KTM Sportmotorcycle GmbH, Mattighofen AUSTRIA; All rights reserved; Reprint, also in extracts, with written allowance of KTM Sportmotorcycle GmbH, Mattighofen only.

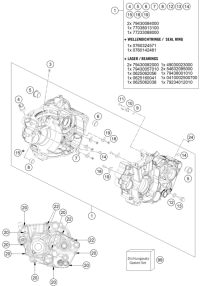
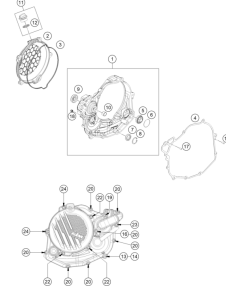
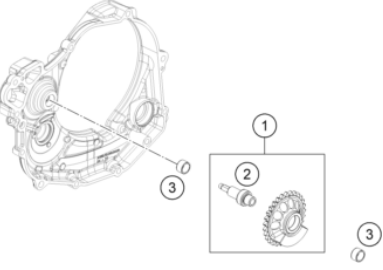
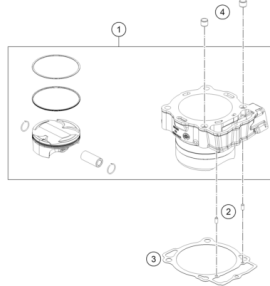
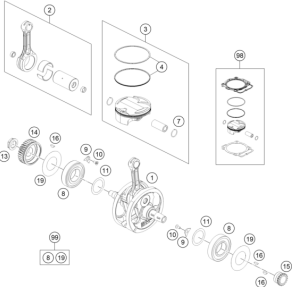
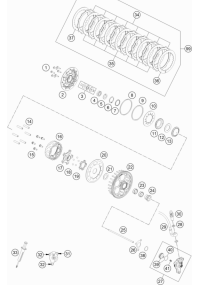
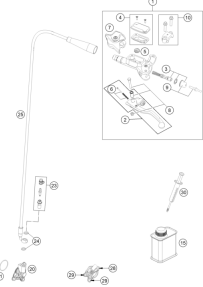
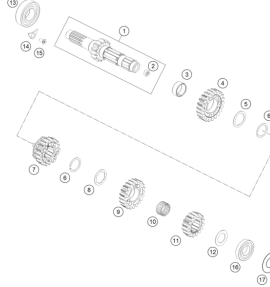
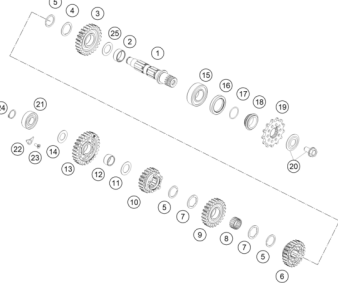
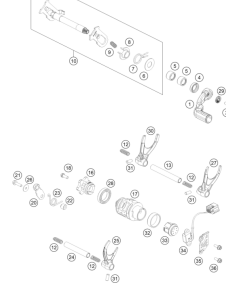
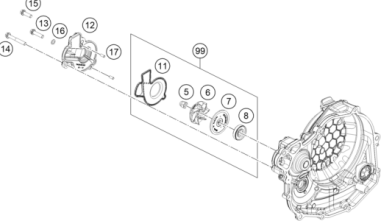
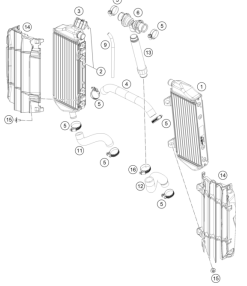
<p>ENGINE CASE</p>  <p>3</p>	<p>CLUTCH COVER</p>  <p>4</p>	<p>BALANCER SHAFT</p>  <p>5</p>	<p>CYLINDER</p>  <p>6</p>
<p>CRANKSHAFT, PISTON</p>  <p>7</p>	<p>CLUTCH</p>  <p>8</p>	<p>CLUTCH CONTROL</p>  <p>10</p>	<p>TRANSMISSION I - MAIN SHAFT</p>  <p>11</p>
<p>TRANSMISSION II - COUNTERSHAFT</p>  <p>12</p>	<p>SHIFTING MECHANISM</p>  <p>13</p>	<p>WATER PUMP</p>  <p>14</p>	<p>COOLING SYSTEM</p>  <p>15</p>

VALVE DRIVE

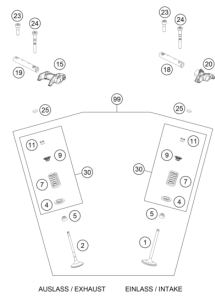

16

TIMING DRIVE

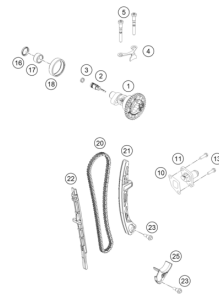

18

CYLINDER HEAD

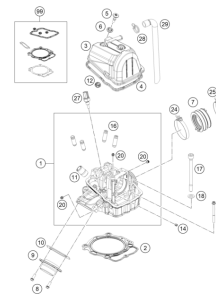

19

LUBRICATING SYSTEM

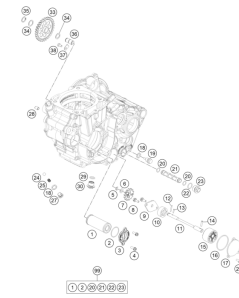

20

IGNITION SYSTEM

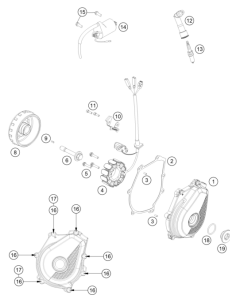

21

ELECTRIC STARTER

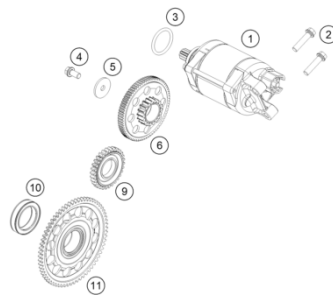

22

THROTTLE BODY

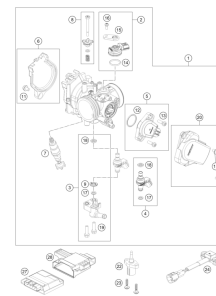

23

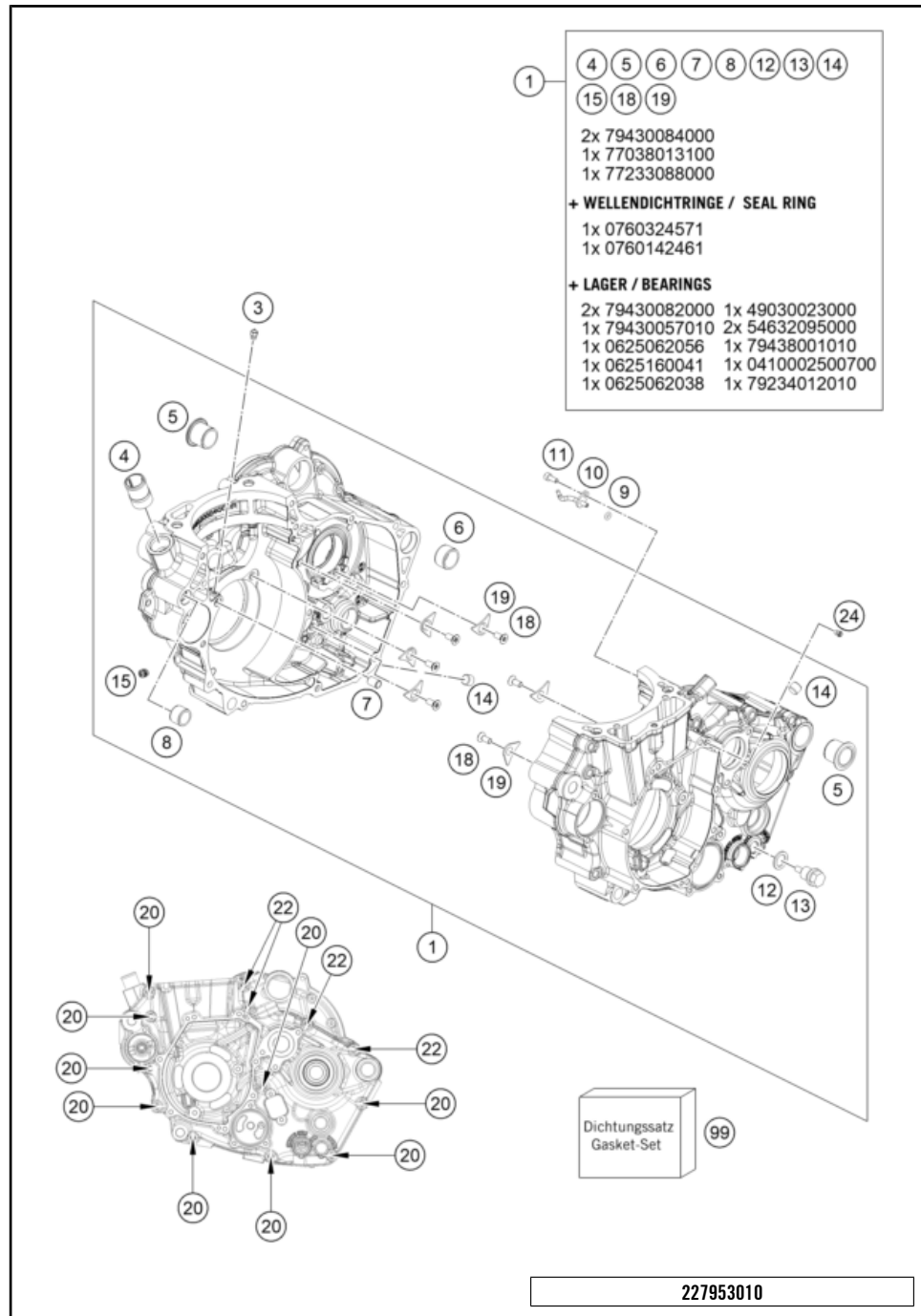

POS	PARTNUMBER	PARTNAME	PIECE
1	A48030000044	engine case cpl.	1
3	60030063070	oil jet 70 M5	1
4	58030010200	SCREW IN NOZZLE M20X1,5	1
5	79230010000	CASE BUSH	2
6	54830027100	Dowel, 21x12	1
7	59030023100	Dowel, 6x8x11.5	1
8	54630027000	DOWEL BUSHING 13,8X11X12	1
9	0770035020	O-RING 3,5X2,00 NBR	1
10	81230064000	OIL JET ANGLED 70	1
11	0912040103S	Cylinder screw DIN 912-M4x10-8.8 SS	1
12	58038022000	CU-SEAL RING DIN7603-12X18X1,5	1
13	58030021100	oil drain plug with magnet	1
14	0906100100	pipe plug DIN 906 M10x1	2
15	59030296000	SCREW PLUG	3
18	0019050121S	INT. TORX FLAT HEAD M5X12 T25	6
19	75030085100	Retaining bracket crankshaft bearing	6
20	0025060656	HH COLLAR SCREW M6X65 TX30	9
22	0025060806	HH COLLAR SCREW M6X80 TX30	4
24	59030058000	JET 100 BING(44-031/180) M4	1
99	A48030099000	engine gasket kit MX 450	x

58123

* NEW PART X ON DEMAND

CLUTCH COVER

Engine 450 SMR 2023

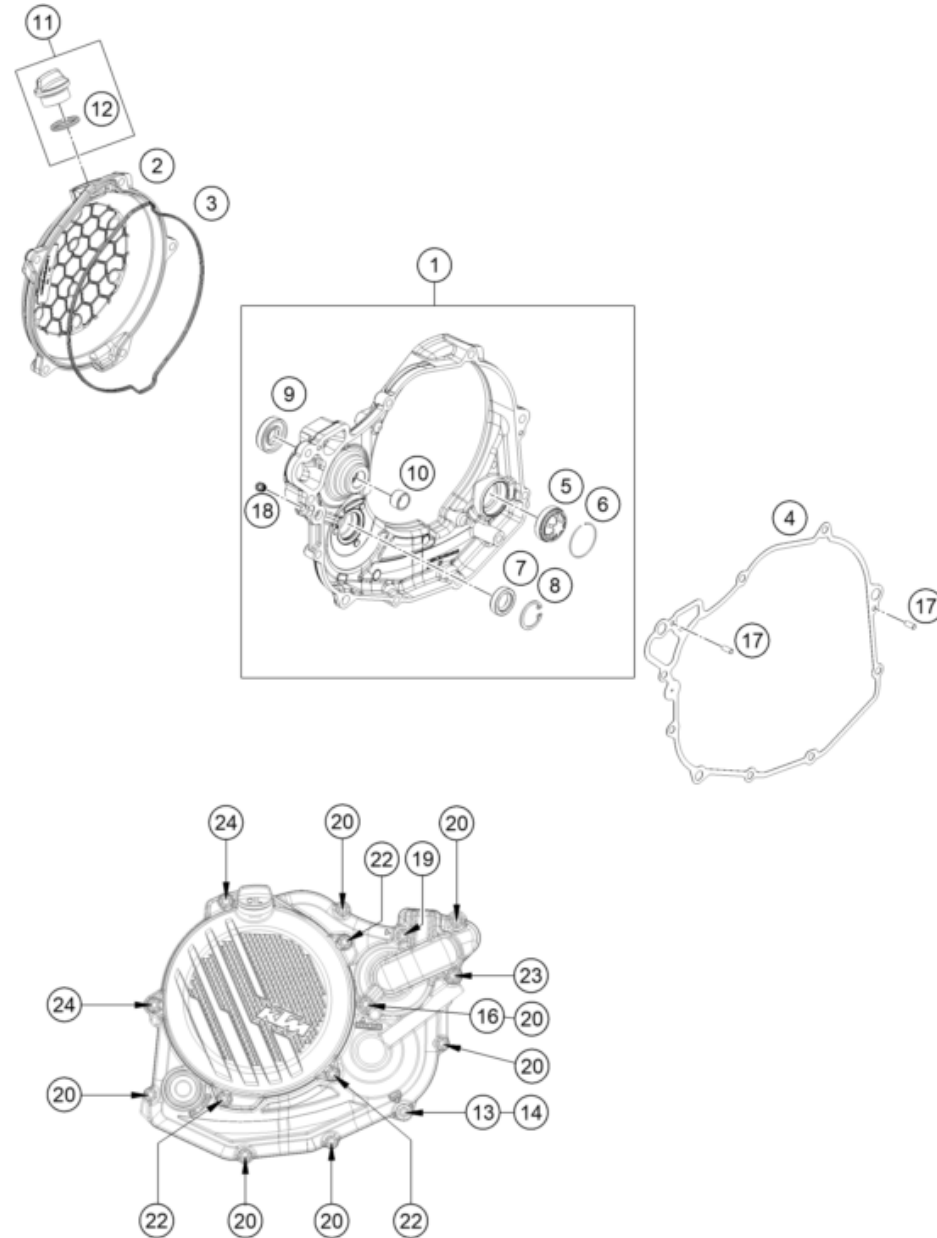

POS	PARTNUMBER	PARTNAME	PIECE
1	A48030001044	clutch cover cpl.	1
2	A48030026000C1	Clutch cover outside	1
3	A48030027000	Clutch cover gasket external	1
4	A48030025000	Inner clutch cover gasket	1
5	59030019200	OIL SIGHT GLASS	1
6	61030019050	CIRCLIP OIL LEVEL GLASS 03	1
7	0760142460	radial shaft seal 14x24x6 B	1
8	0472024120	CIRCLIP DIN0472-24X1.2	1
9	0760123073	SHAFT SEAL RING 12X30X7 PTFE	1
10	79430057010	FRICTION BEAR. BUSH BALANC.SH.	1
11	79430020033	OIL FILLER CAP M24x3 WITH O-R	1
12	0770191015	O-RING 19,00X3,00 NBR	1
13	0603082131	COPPER GASK.DIN7603- 8,2X13X1	1
14	0000150802000	Screw, M8x20 SW=8 8.8	1
16	0603061001	CU-SEAL RING DIN7603-6X10X1	1
17	0402040980	NEEDLE ROL.DIN5402 NRB 4X9,8	2
18	59030296000	SCREW PLUG	1
19	0025060206S	HH collar screw M6x20 TX30	1
20	0025060256	HH collar screw M6x25 TX30	7
22	0025060206	HH collar screw M6x20 TX30	3
23	0025060456	HH COLLAR SCREW M6X45 TX30	1
24	0025060556	HH collar screw M6x55 TX30	2

227953020

58153

* NEW PART

X ON DEMAND

BALANCER SHAFT

Engine 450 SMR 2023

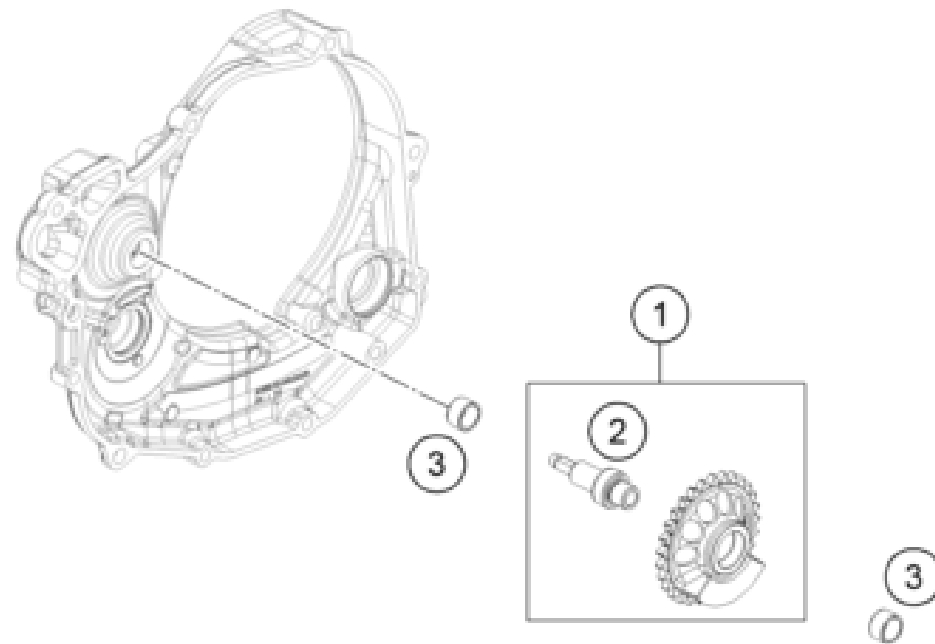

POS	PARTNUMBER	PARTNAME	PIECE
1	A48030057000	Balancer shaft	1
2	79430057101	Balancer shaft	1
3	79430057010	FRICION BEAR. BUSH BALANC.SH.	2

227953030

58177

* NEW PART

X ON DEMAND

CYLINDER

Engine 450 SMR 2023

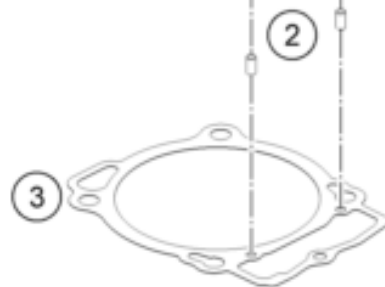
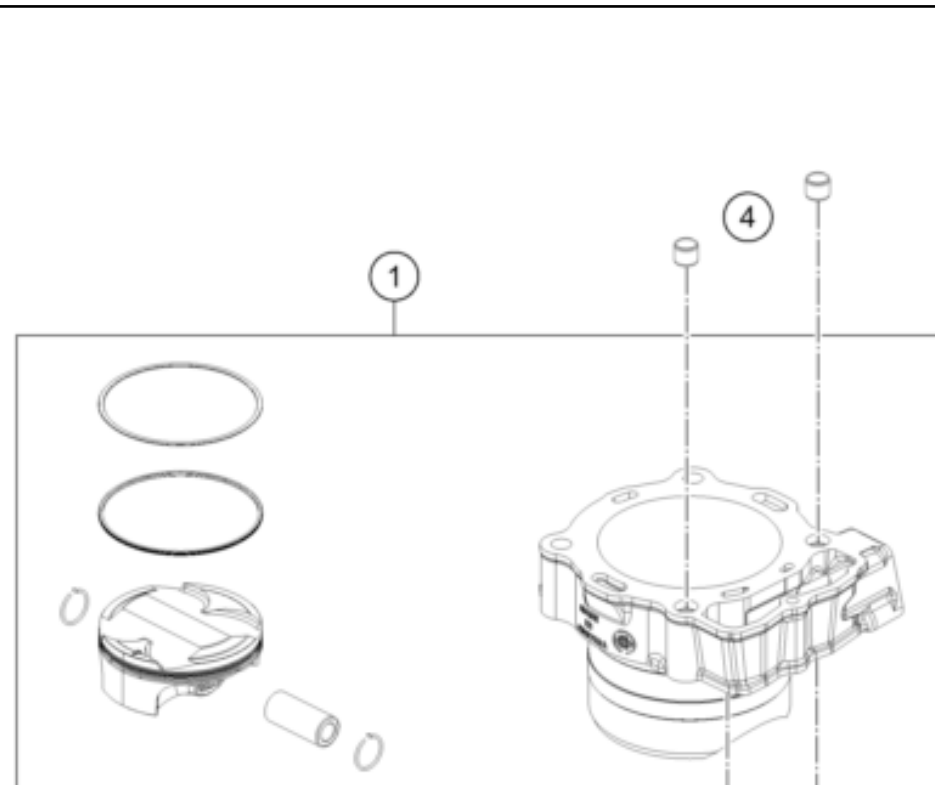

POS	PARTNUMBER	PARTNAME	PIECE
1	A48030038000	cylinder & piston	1
2	0402050980	needle roller DIN 5402 5x9.8	2
3	79430035000	CYLINDER BASE GASKET	1
4	58530014100	dowl sleeve 10.2x12.5x10	2

227953040

58161

* NEW PART

X ON DEMAND

CRANKSHAFT, PISTON

Engine 450 SMR 2023

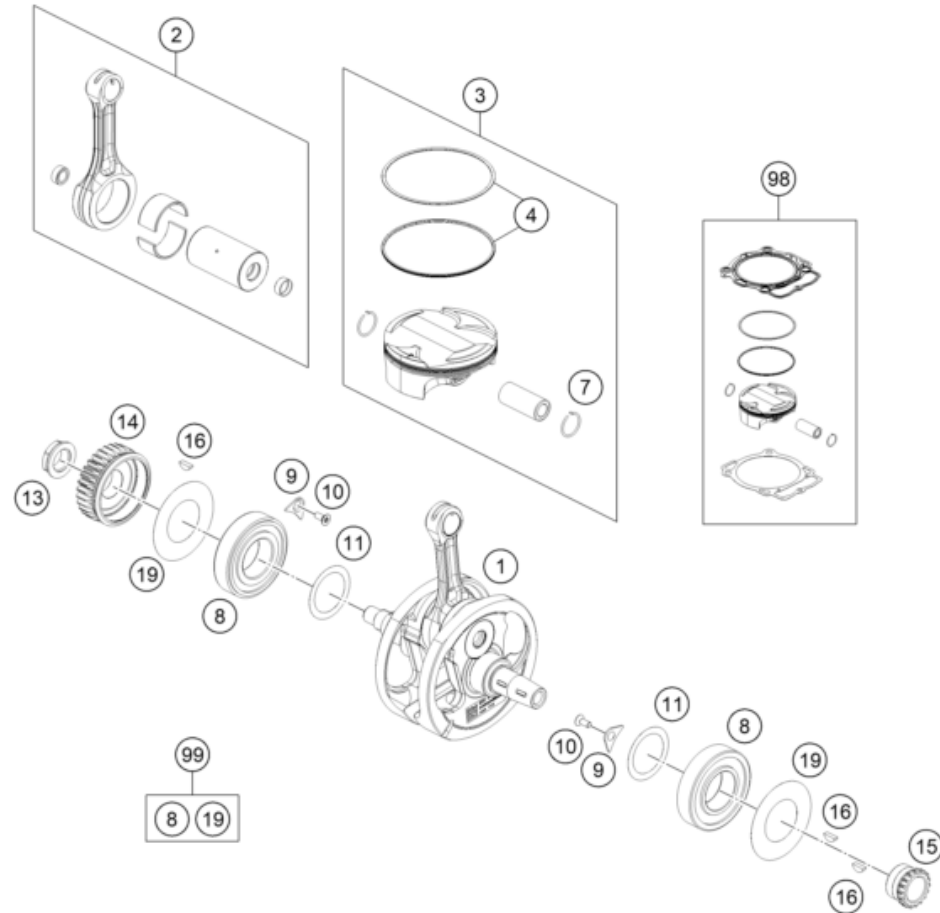

POS	PARTNUMBER	PARTNAME	PIECE
1	A48030018000	Crankshaft compl.	1
2	79530015044	Connecting rod repair kit	1
3	A48030007100 I	Piston gr.I kpl. MX 450	1
3	A48030007100 II	PISTON Gr. II CPL. MX 450	1
4	79430130044	PISTON RING KIT	1
7	79430174000	CIRCLIP	2
8	79430082000	CYLINDER ROLLER BEARING NJ207	2
9	75030085000	RETAINING PLATE F. CS BEARING	2
10	0019050121S	INT. TORX FLAT HEAD M5X12 T25	2
11	56530081000	SHIM WASHER 36X48X0,10	x
11	56530081100	SHIM WASHER 36X48X0,15	x
11	56530081200	SHIM WASHER 36X48X0,20 STEEL	x
11	56530081300	SHIM WASHER 36X48X0,30	x
13	0910001801000S	Nut M18x1.5 Precote	1
14	A48032023029	Primary gear 29 teeth	1
15	78036014400	Timing gear 18 teeth	1
16	0888030037	WOODRUFF KEY DIN6888-3X3,7	3
19	79430084000	BEARING SEAL	2
98	A48030007110 I	Piston Kit I MX 450	x
98	A48030007110 II	Piston Kit II MX 450	x
99	00050002315	CRANKSHAFT REP.KIT 450 SX-F 15	x

227953060

58160

* NEW PART

X ON DEMAND

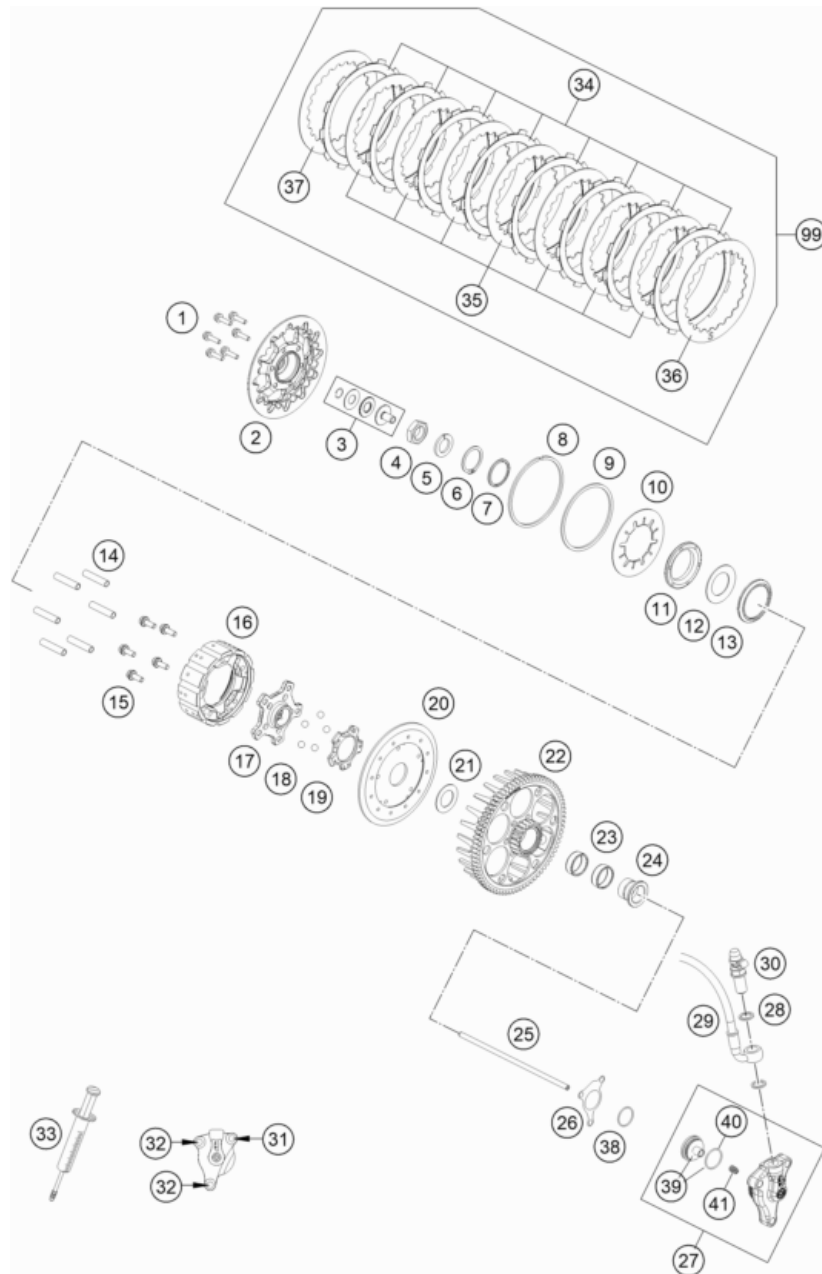

POS	PARTNUMBER	PARTNAME	PIECE
1	79532186000	Distance screw M5X19.5	6
2	79532103000	Pressure plate	1
3	78132057144	PRESSURE PIECE CPL.	1
4	0936181505	HEXAGON NUT DIN0936-M18X1,5 R.	1
5	58132072000	LOCK WASHER VSK 18	1
6	0471300152	Circlip	1
7	79532183000	Distance ring 30X36X2	1
8	0417900250	Circlip	1
9	79532185000	Locking ring 88	1
10	79532105000	Main spring 1235N	1
11	79532102050	Clamp hub 5mm	1
12	79532182000	Torque limiter spring 1100N	1
13	79532181000	Release ring	1
14	77232004000	DRIVING SLEEVE D=7,95 L=38	6
15	79532107000	Bolt M6X14	5
16	79532102010	Inner hub	1
17	79532102020	Hub carrier	1
18	79532168000	Ball	5
19	79532102030	Ramp insert 30°	1
20	79532102040	Back plate insert	1
21	79532120000	Thrust washer	1
22	79432101076	Clutch basket	1
23	0405252910	NEEDLE BEAR K 25X29X10	2
24	78132015100	COLLARSLEEVE	1
25	79432054000	PUSH ROD	1
26	59032065100	GASKET F. OUTPUT CYLINDER	1
27	54832061044	OUTPUT CYLINDER CPL. 06	1
28	0603100141	sealing ring DIN 7603 10x14x1	2
29	78132063000	CLUTCH PIPE	1
30	54732064000	BLEEDER SCREW WITH CAP	1
31	0025060306	HH collar screw M6x30 TX30	1
32	0025060206	HH collar screw M6x20 TX30	2
33	50329050000	VENT INJEKTION HYDR. CLUTCH	1
34	79532011000	Lining disc 1,95mm	8
35	59032010200	INTERMEDIATE DISC 1,4MM 2002	7
36	78932010000	INTERMEDIATE DISC 1MM	1
37	59032010100	INTERMEDIATE DISC 1MM 2002	1
38	0770300015	O-RING 30,00X1,50 NBR 70	1

217953210

55357

* NEW PART

X ON DEMAND

CLUTCH

Engine 450 SMR 2023

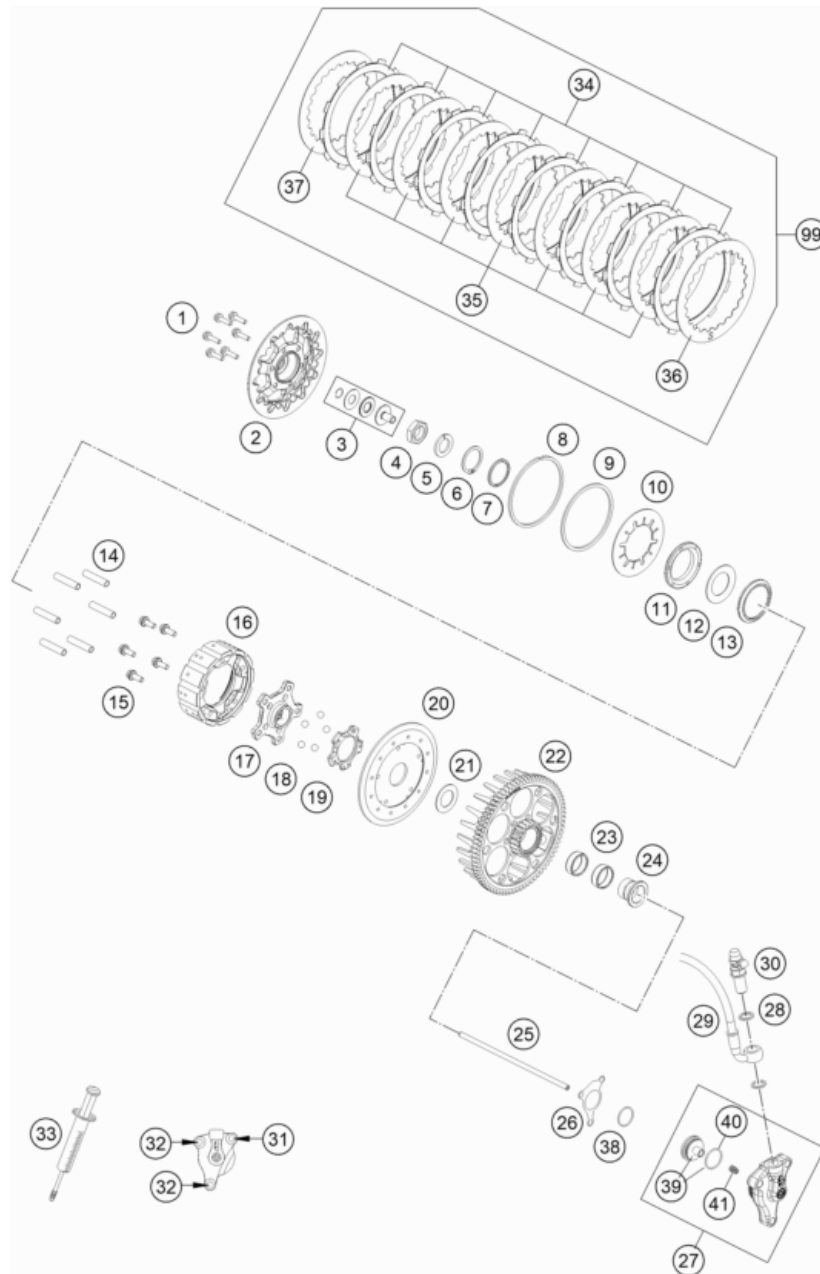

POS	PARTNUMBER	PARTNAME	PIECE
39	54832066000	PISTON CPL.	1
40	54832067000	O-RING	1
41	54832069000	PRESSURE SPRING	1
99	79532010033	CLUTCH DISC PACKAGE	1

217953210

55357

* NEW PART

X ON DEMAND

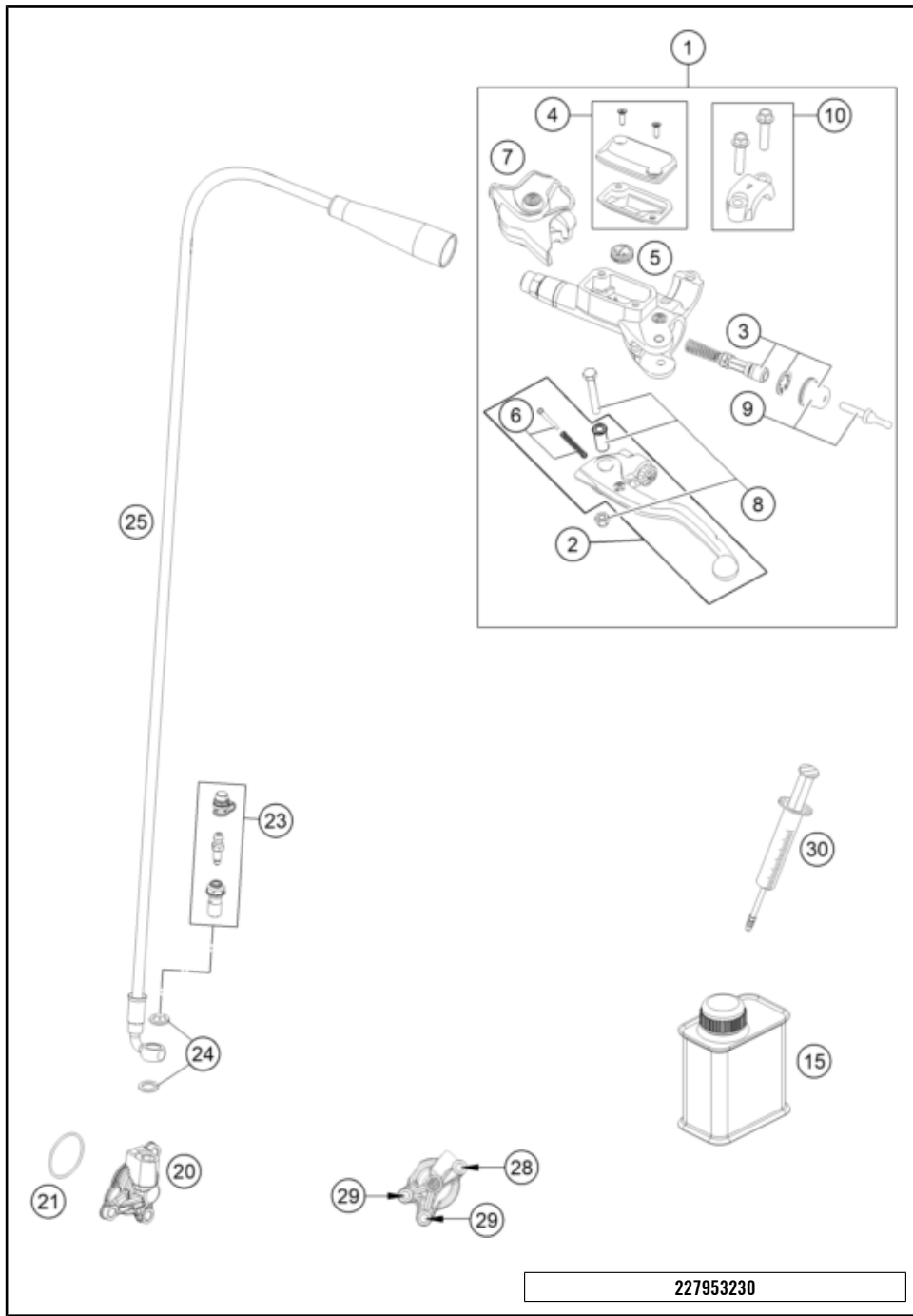

POS	PARTNUMBER	PARTNAME	PIECE
1	54802030144	MASTER CYLINDER CPL.	1
2	54802031000	CLUTCH LEVER CPL. BREMBO 06	2
3	54802032000	REP. KIT PISTON 06	1
4	5480200310030	COVER HYD. CLUTCH CPL. 2014	1
5	54802051000	VALVE	1
6	54802052000	BOLT KPL.	1
7	54802037000	PROTECTION CAP 06	1
8	54802038100	LEVER SCREW CPL. 06	6
9	54802046000	PUSH ROD CPL.	6
10	54802005100	CLAMP CPL. 06	6
15	00062030000	BRAKE FLUID DOT5.1 0,25L	1
20	79232061044	OUTPUT CYLINDER CPL.	1
21	0770300015	O-RING 30,00X1,50 NBR 70	1
23	79032064000	BLEEDER SCREW CPL.	1
24	0603082121	SEAL RING CU DIN7603- 8X12X1	2
25	A49032063000	clutch hose	1
28	0025060406	HH collar screw M6x40 TX30	1
29	0025060166	HH collar screw M6x16 TX30	2
30	50329050000	VENT INJEKTION HYDR. CLUTCH	1

227953230

58202

* NEW PART

X ON DEMAND

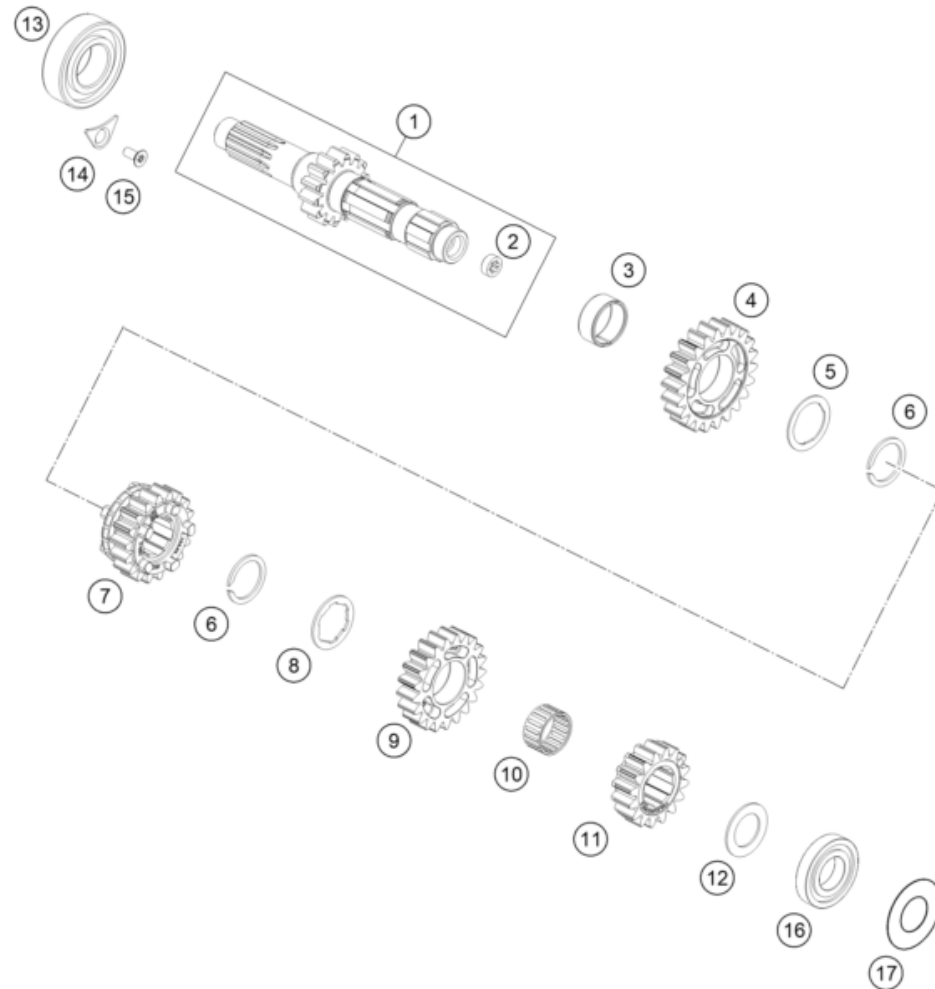

POS	PARTNUMBER	PARTNAME	PIECE
1	A47033001000	Main shaft compl.	1
2	79133001010	bushing	1
3	0405242812	NEEDLE BEAR. K24X28X11,9 DIV.	1
4	79333505000	Idle gear 5 th.	1
5	79333043000	Stop disk	1
6	77033022100	Retaining ring 25x1,65	2
7	79333503000	Sliding gear 3 rd.	1
8	54833044000	STOP DISC 25X31X1,5	1
9	79333504000	Idle gear 4 th	1
10	0405222613	NEEDLE BEAR. K 22X26X13 TN	1
11	79333002000	Fixed gear 2nd g/16 teeth	1
12	77233015000	DISK 20,2X32X1,3	1
13	0625062056	Groove ball bearing 6205 C4 NTN	1
14	75030085100	Retaining bracket crankshaft bearing	1
15	0019050121S	INT. TORX FLAT HEAD M5X12 T25	1
16	0625160041	BALL BEARING TM 16004 C4	1
17	77233088000	SPACER SHIM 21X42X0.2	1

227953330

58158

* NEW PART

X ON DEMAND

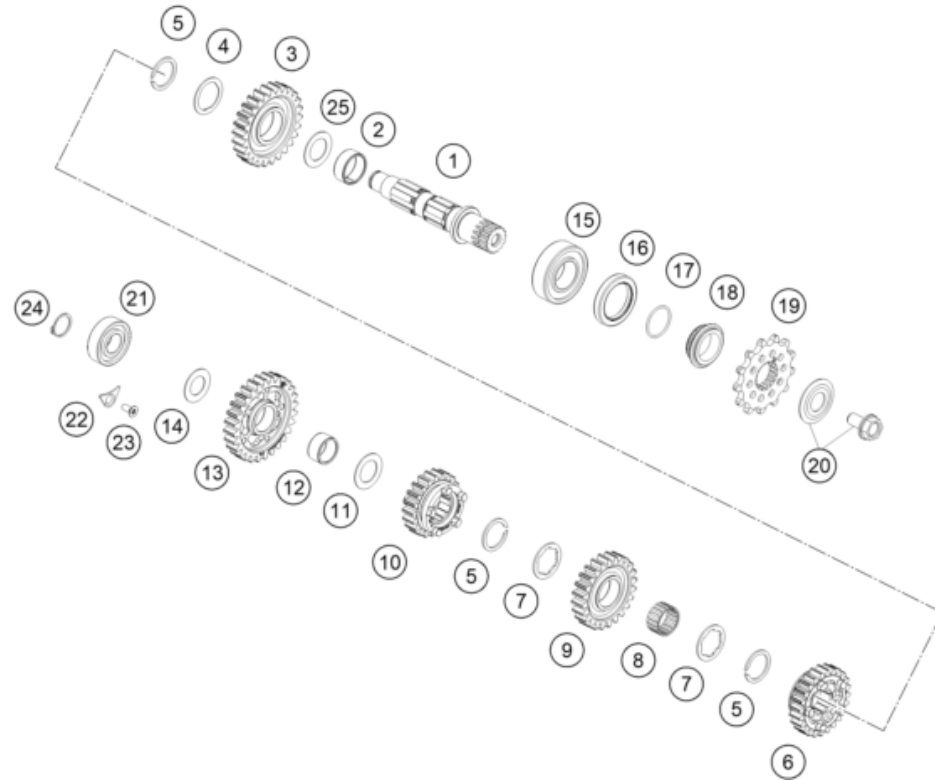

POS	PARTNUMBER	PARTNAME	PIECE
1	79333010000	Countershaft	1
2	0405242812	NEEDLE BEAR. K24X28X11,9 DIV.	1
3	79333512000	Idler gear 2nd.	1
4	79333043000	Stop disk	1
5	77033022100	Retaining ring 25x1,65	3
6	79333514000	Sliding gear 4th	1
7	59033030000	STOP DISC 25,2X32X1,5	2
8	0405222613	NEEDLE BEAR. K 22X26X13 TN	1
9	79333513000	Idler gear 3rd	1
10	79333515000	Sliding gear 5th	1
11	59033080000	SHIM 20X32X1	1
12	0405202413	NEEDLE BEAR. K20X24X13	1
13	79333511000	Idler gear 1 st.	1
14	56033030000	STOP DISC 17,2X30X1	1
15	49030023000	cylindrical roller bearing NJ205	1
16	0760324571	SHAFT SEAL RING 32X45X7 BSLNBR	1
17	0770020220	O-RING 25,12X1,78 NBR70	1
18	78133014000	SPACER SLEEVE COUNTER	1
19	79233029014	SPROCKET 14T	1
19	79233029013	SPROCKET 13T	x
20	59033034044	SCREW 10.9+SPRING WASHER	1
21	0625062038	Ballbearing NTN 6203JR2CM21	1
22	75030085100	Retaining bracket crankshaft bearing	1
23	0019050121S	INT. TORX FLAT HEAD M5X12 T25	1
24	0471170015	CIRCLIP DIN 0471-17X1, 5	1
25	56033030000	STOP DISC 17,2X30X1	1

227953360

58159

* NEW PART

X ON DEMAND

SHIFTING MECHANISM

Engine 450 SMR 2023

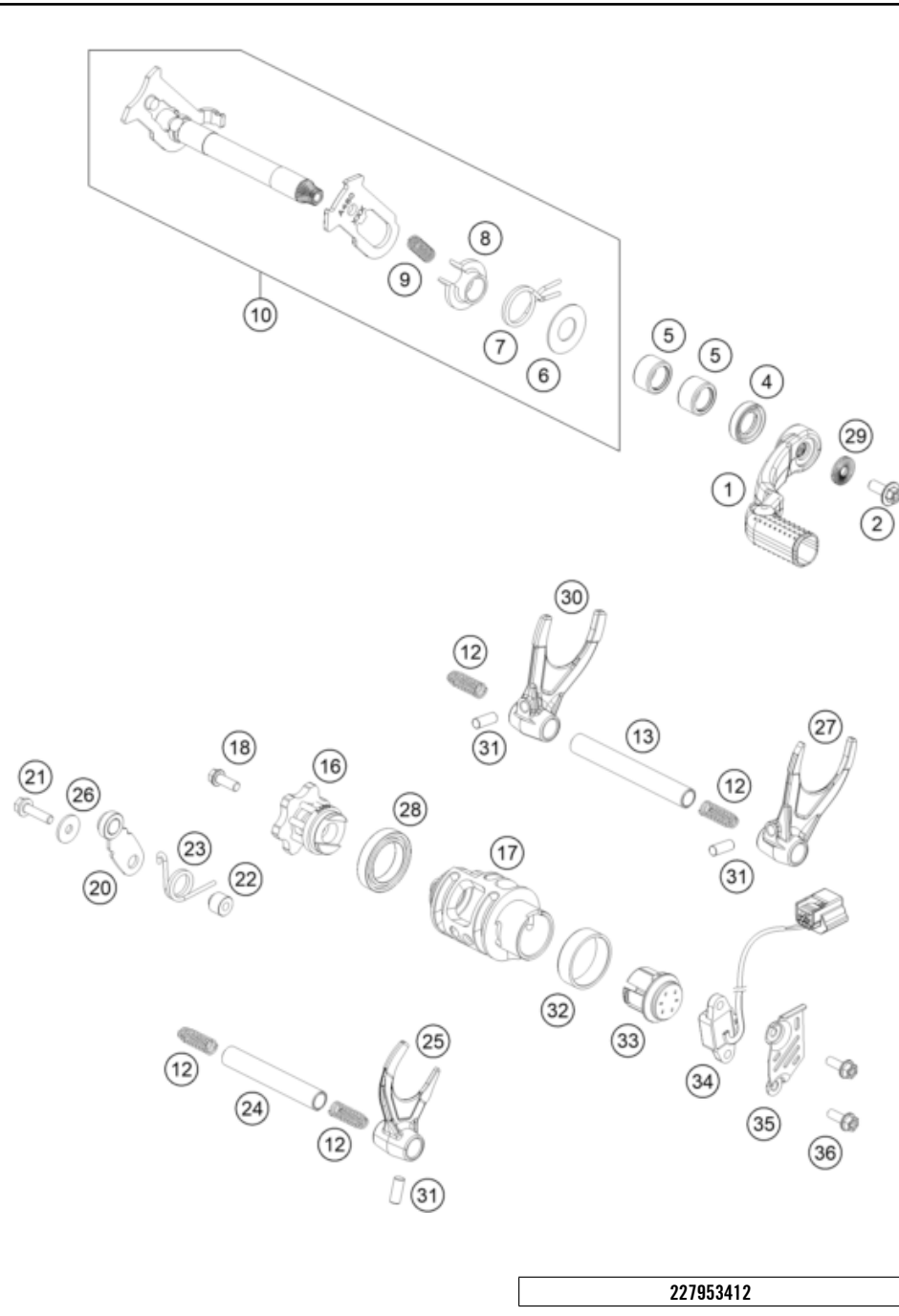

POS	PARTNUMBER	PARTNAME	PIECE
1	79234031100	SHIFT LEVER CPL.	1
2	0024060156S	HH collar screw M6x15 TX30	1
4	0760142461	SHAFT SEAL RING 14X24X6B VITON	1
5	54632095000	needle sleeve HK 1412 14x20x12	2
6	54634050000	STOP DISK 14X30X1	1
7	54834014000	RETURN SPRING 03	1
8	54634020000	SPRING GUIDE	1
9	56534013100	TENSIONING SPRING 0,8MM	1
10	A46034005033	Shift shaft cpl.	1
12	58038023400	Compression spring L=25mm D=0.9mm	4
13	A46034020000	Shift fork shaft (L=66 mm)	1
16	A46034015000	Shift star cpl.	1
17	A47034012000	Shift drum 5 gear	1
18	0025060306S	HH collar screw M6x30 TX30	1
20	A46034024044	Detent arm cpl.	1
21	0025050256S	HH collar screw M5x25 TX30	1
22	54634052300	SLEEVE FOR LOCKING LEVER	1
23	54834023000	LOCKING LEVER SPRING 03	1
24	A46034019000	Shift fork shaft (L=93 mm)	1
25	79234001000	SHIFTING FORK 4TH/5TH GEAR	1
26	0021050003	washer DIN 9021 A - 5.3	1
27	79234002000	SHIFTING FORK 2ND GEAR	1
28	0410002500700	Grooved ball bearing 6805 JR C3	1
29	50233041500	PAIR NORDLOCK WASHER M6	1
30	79234003000	SHIFTING FORK 1ST/3RD GEAR	1
31	0402061480	NEEDLE ROLLER DIN5402 6X14,8	3
32	79234012010	FRICTION BEARING CONTROLLER	1
33	79234012020	magnet holder cpl.	1
34	79211023000	gear position sensor	1
35	A46011024000	Shield gear position sensor	1
36	0025050146S	Hex coll. screw M5x14 ISA30 self-locking	2

227953412

58163

* NEW PART

X ON DEMAND

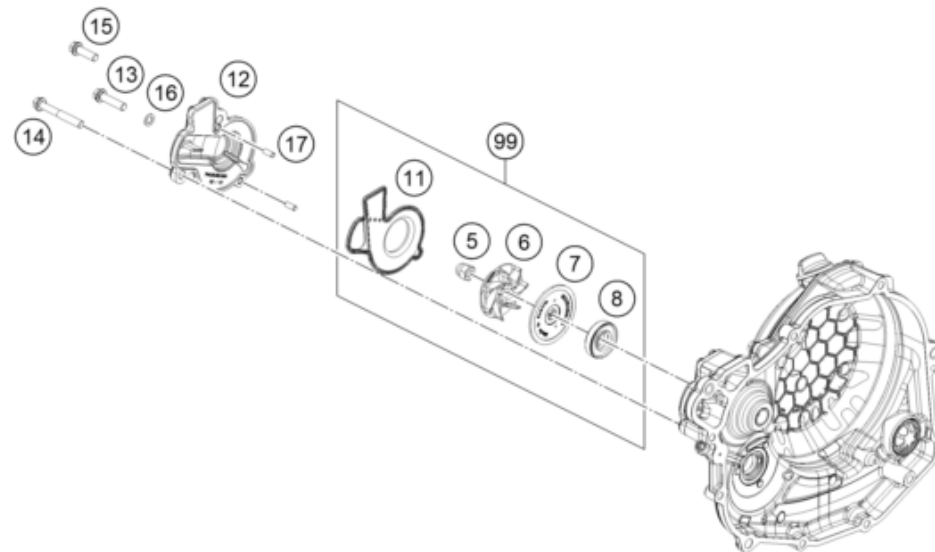

POS	PARTNUMBER	PARTNAME	PIECE
5	61230045000	CAP NUT M6 STAINLESS STEEL	1
6	81235055020	WATER PUMP ROTOR	1
7	81235055110	DISC WATER PUMP	1
8	0760123073	SHAFT SEAL RING 12X30X7 PTFE	1
11	79435053100	Gasket with carrier plate	1
12	79435052000	WATER PUMP COVER	1
13	0025060256	HH collar screw M6x25 TX30	1
14	0025060456	HH COLLAR SCREW M6X45 TX30	1
15	0025060206	HH collar screw M6x20 TX30	1
16	0603061001	CU-SEAL RING DIN7603-6X10X1	1
17	0402040980	NEEDLE ROL.DIN5402 NRB 4X9,8	2
99	79435055015	WATER PUMP REP. KIT	x

227953510

57522

* NEW PART

X ON DEMAND

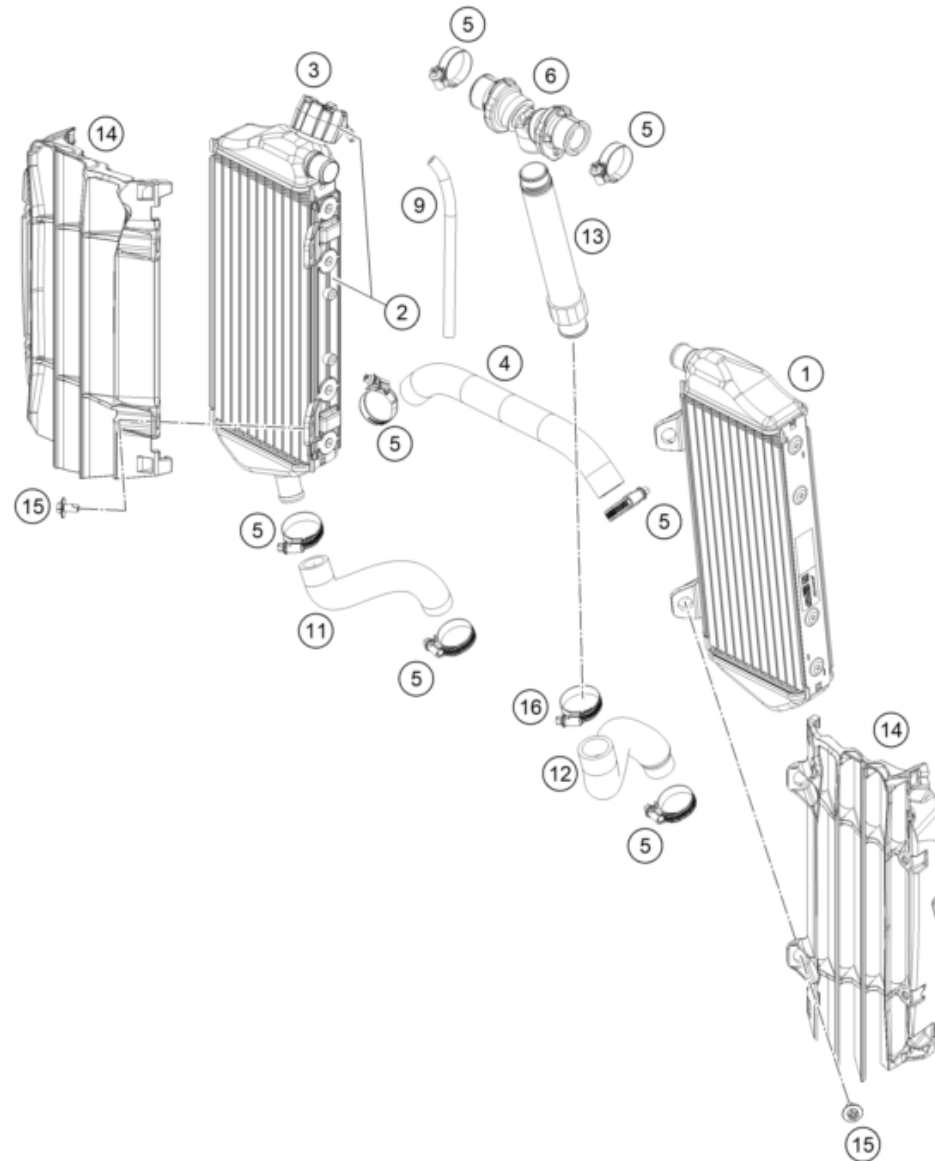

POS	PARTNUMBER	PARTNAME	PIECE
1	A46035007000	Radiator left	1
2	A46035008000	Radiator right	1
3	A46035009000	Radiator cap	1
4	A46035025000	Pre-formed hose radiator left/right	1
5	0310000902900	Hose clip 18-29	7
6	A46035071044	Y-piece cmpl.	1
9	50307000140	VENT HOSE 6X9 L=140	1
11	A48035024000	Pre-formed hose, engine/radiator, right	1
12	A48035023000	Pre-formed hose, engine/riser	1
13	A46035073033	Screw-in nozzle	1
14	A46035036044C1	Radiator protection set, black	1
15	0024060123	COLLAR SCREW M6X12 TX	4
16	0310000903200	Hose clip 20-32	1

227953530

58194

* NEW PART

X ON DEMAND

VALVE DRIVE

Engine 450 SMR 2023

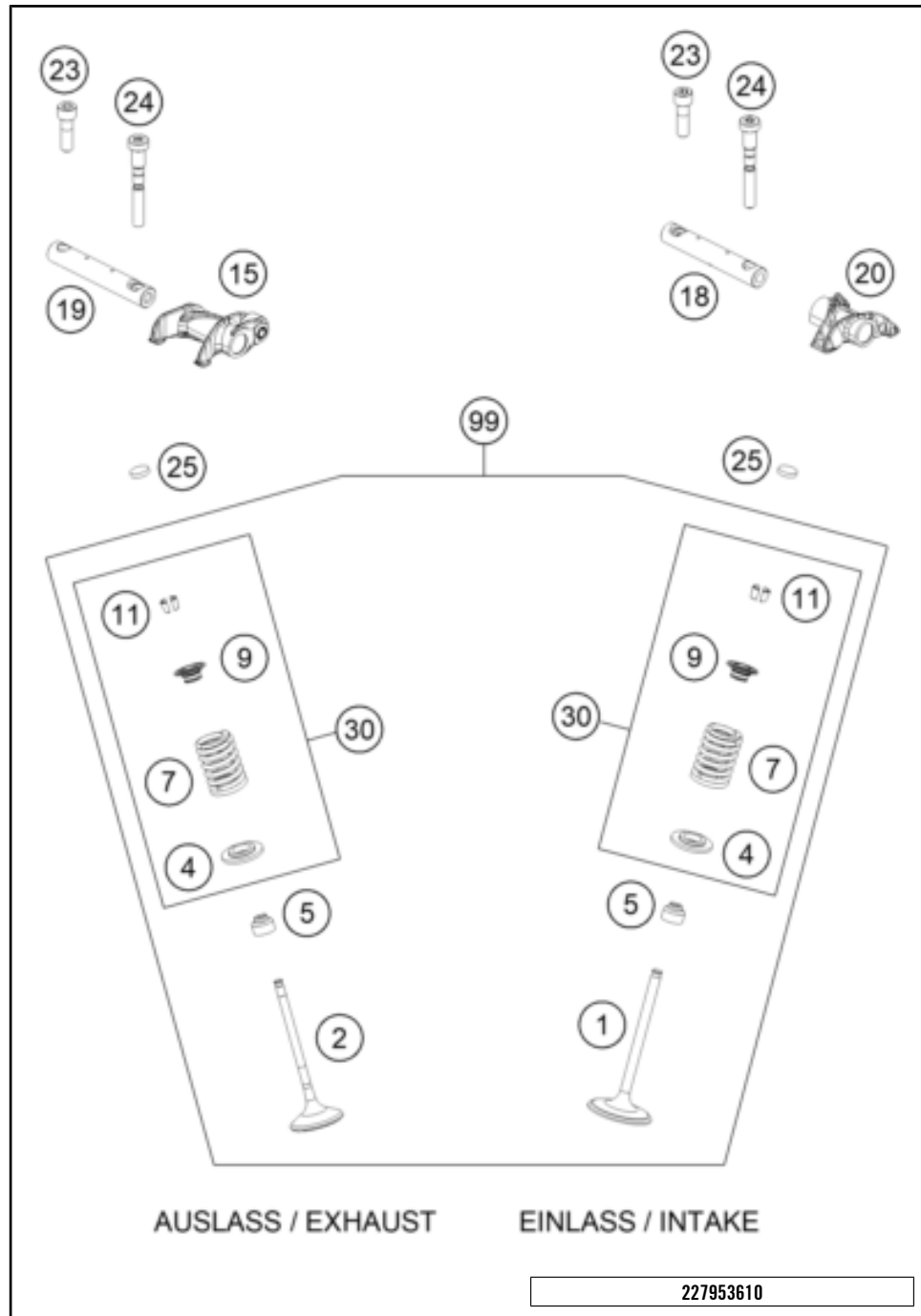

POS	PARTNUMBER	PARTNAME	PIECE
1	79536030000	Inlet valve	2
2	79536031000	Outlet valve	2
4	79536036100	Valve spring washer	4
5	59036027000	VALVE-STEM SEALING RACING	4
7	78936028000	VALVE SPRING	4
9	79536032100	Valve spring retainer	4
11	77336033100	VALVE COLLET 07	8
15	79536061144	Rocker arm outtake	1
18	79536056000	Rocker Arm Shaft Intake	1
19	79536057000	exhaust rocker arm shaft	1
20	79536060100	Rocker arm intake	1
23	79536085000	rocker arm shaft bolt	2
24	79536084000	rocker arm shaft bolt	2
25	77036035172	SHIM D=8,9/1,72	x
25	77036035176	SHIM D=8,9/1,76	x
25	77036035180	SHIM D=8,9/1,80	x
25	77036035184	SHIM D=8,9/1,84	x
25	77036035188	SHIM D=8,9/1,88	x
25	77036035192	SHIM D=8,9/1,92	x
25	77036035196	SHIM D=8,9/1,96	x
25	77036035200	SHIM D=8,9/2,00	x
25	77036035204	SHIM D=8,9/2,04	x
25	77036035208	SHIM D=8,9/2,08	x
25	77036035212	SHIM D=8,9/2,12	x
25	77036035216	SHIM D=8,9/2,16	x
25	77036035220	SHIM D=8,9/2,20	x
25	77036035224	SHIM D=8,9/2,24	x
25	77036035228	SHIM D=8,9/2,28	x
25	77036035232	SHIM D=8,9/2,32	x
25	77036035236	SHIM D=8,9/2,36	x
25	77036035240	SHIM D=8,9/2,40	x
25	77036035244	SHIM D=8,9/2,44	x
25	77036035248	SHIM D=8,9/2,48	x
25	77036035252	SHIM D=8,9/2,52	x
25	77036035256	SHIM D=8,9/2,56	x
25	77036035260	SHIM D=8,9/2,60	x
25	77036035201	shim 8.9	x

227953610

58176

* NEW PART

X ON DEMAND

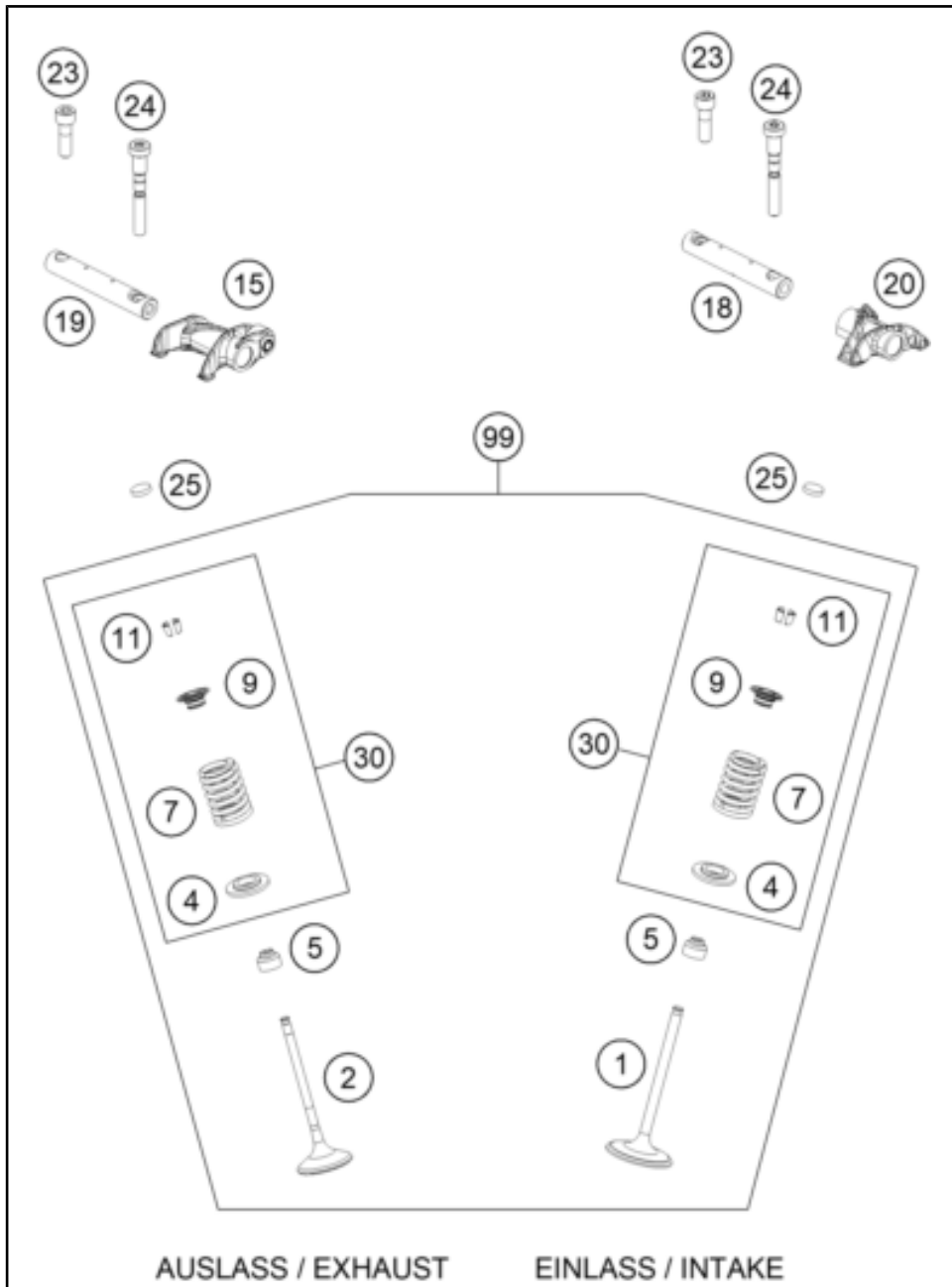

AUSLASS / EXHAUST

EINLASS / INTAKE

POS	PARTNUMBER	PARTNAME	PIECE
30	79536029010	Valve springs kit 450	x
99	79536030010	Valve Kit 450	x

227953610

58176

* NEW PART

X ON DEMAND

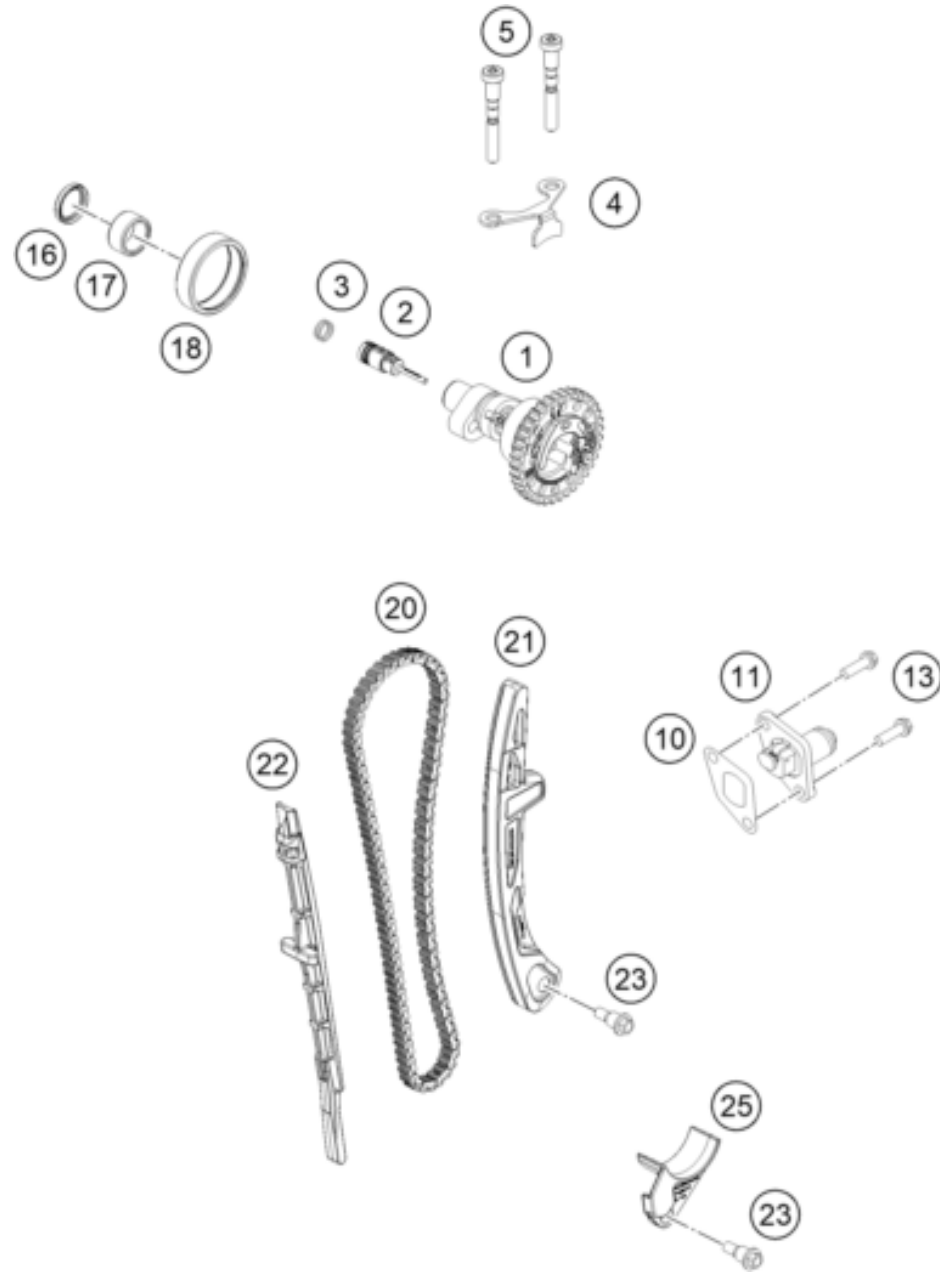

POS	PARTNUMBER	PARTNAME	PIECE
1	A48036010044	Camshaft, cmpl. with decal	1
2	79536010010	Breather centrifuge	1
3	0770010010	o-ring 10.00x1.00 NBR70	2
4	79536012100	Camshaft bracket	1
5	79536084000	rocker arm shaft bolt	2
10	59036003150	GASKET TIMING CHAIN TENSIONER	1
11	59036003000	TIMINGCHAIN TENSIONER CPL.RAC.	1
13	0025060166	HH collar screw M6x16 TX30	2
16	0760182442	SHAFT SEAL RING 18X24X4	1
17	0618182412	NEEDLE BEAR.HK1812 18/24/12 05	1
18	0618404712	NEEDLE SLEEVE HK4012B40X47X12	1
20	A46036013000	Timing chain	1
21	79536002100	Slide rail	1
22	79536001100	Slide bars	1
23	77236001160	BUSHING SCREW M6	2
25	79436018000	FAIL SAFE	1

227953621

58175

* NEW PART

X ON DEMAND

CYLINDER HEAD

Engine 450 SMR 2023

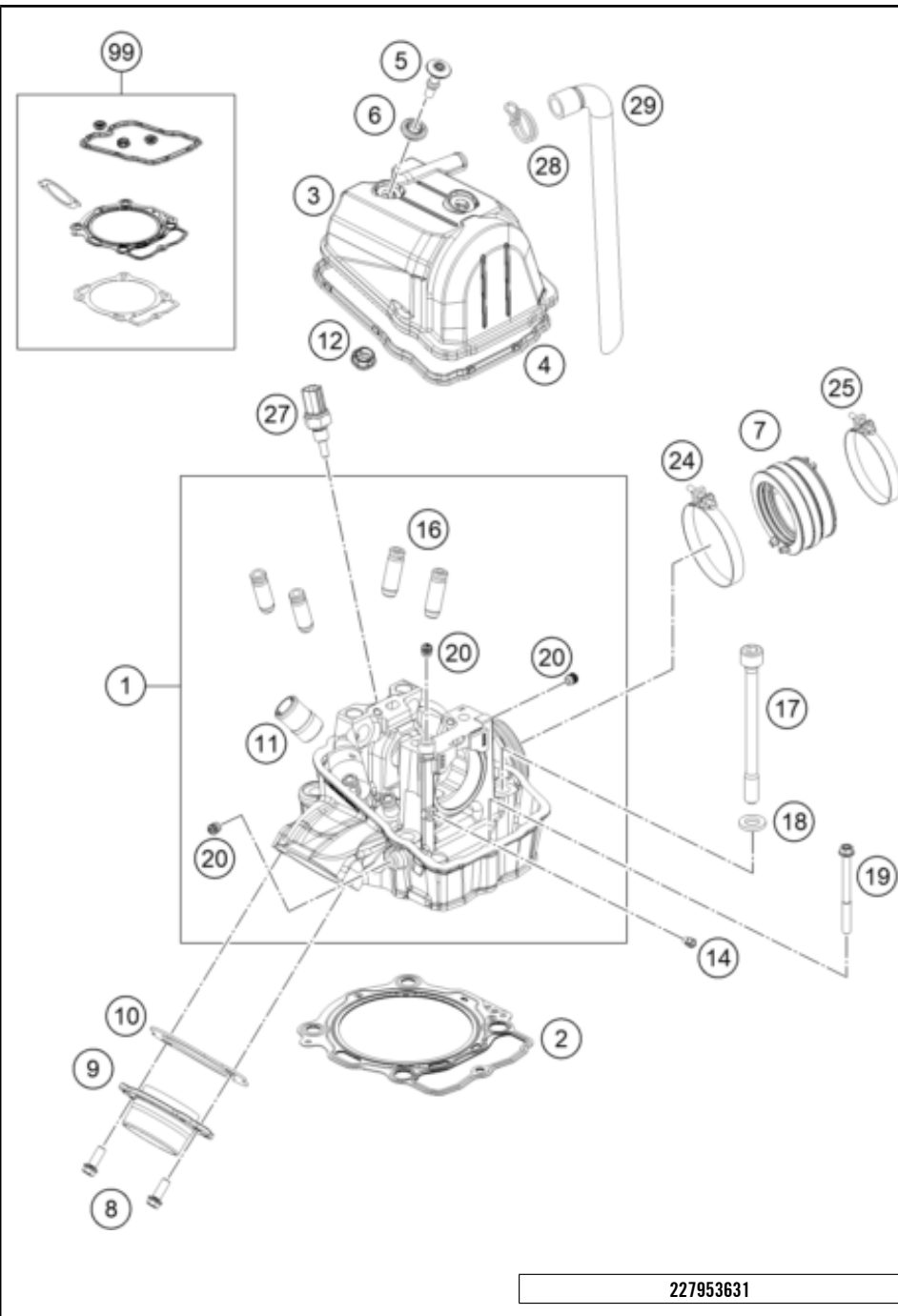

POS	PARTNUMBER	PARTNAME	PIECE
1	A48036020044	cylinder head cpl.	1
2	79430036010	CYLINDER HEAD GASKET (DN95)	1
3	A48036052000C1	Valve cover	1
4	A48036053000	Valve cover seal	1
5	79136054000	Valve cover screw	2
6	79136054050	Rubber seal for collar screw	2
7	79536044000	rubber sleeve	1
8	0025060166S	HH collar screw M6x16 TX30 SL	2
9	78136139100	Exhaust system flange	1
10	79536041000	Exhaust gasket	1
11	58030010200	SCREW IN NOZZLE M20X1,5	1
12	79536053150	valve cover gasket	1
14	60030063070	oil jet 70 M5	1
16	79536025001	Valve Guide intake	4
17	79530044000	Cylinder head bolt	4
18	77336089010	washer 19x10.5x2.5	4
19	0025060756	HH COLLAR SCREW M6X75 TX30	1
20	59030296000	SCREW PLUG	3
24	61036047000	HOSE CLAMP GEMI 63MM 05	1
25	77236048000	HOSE CLAMP GEMI 58MM	1
27	79435047000	water temperature sensor	1
28	58431082300	CLAMP YDNAC 10173 (18MM)	1
29	79030087000	ENGINE BREATHER TUBE	1
99	A48030097000	gasket kit cylinder MX 450	x

227953631

58190

* NEW PART

X ON DEMAND

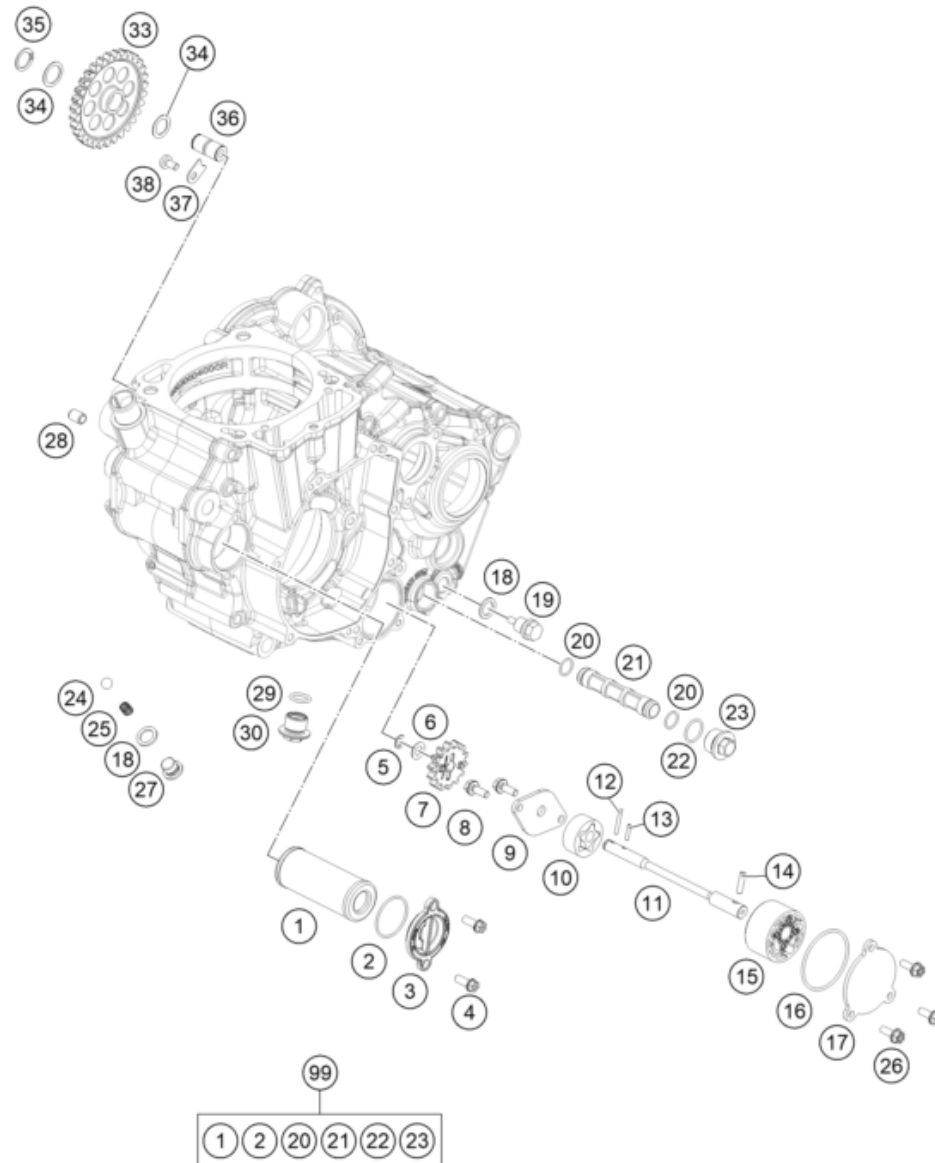

POS	PARTNUMBER	PARTNAME	PIECE
1	77338005100	OIL FILTER	1
2	07703305178	O-RING 33,05X1,78	1
3	77338041200	OIL FILTER COVER O8	1
4	0025060166	HH collar screw M6x16 TX30	2
5	0799060000	TAB WASHER DIN6799-RS 6,0	1
6	58038007755	STOP DISK 8,1 X 15 X 0,5	1
7	77038001200	Oil pump gear	1
8	0025050146S	Hex coll. screw M5x14 ISA30 self-locking	2
9	A48038003000	Oil pump cover	1
10	59038011112	OILPUMP ROTOR-SET 12MM CPL.	1
11	A48038002000	Oil pump shaft	1
12	0402251980	NEEDLEROL.DIN5402 NRA 2,5X19,8	1
13	0402251180	NEEDLE ROLLER DIN5402 2,5X11,8	1
14	0402041580	needle roller NRB 4x15.8 G2	1
15	61238011100	ROTOR SET 22MM	1
16	0770440020	O-RING 44,00X2,00 VITON	1
17	79238004000	OIL PUMP COVER LEFT	1
18	58038022000	CU-SEAL RING DIN7603-12X18X1,5	2
19	58030021100	oil drain plug with magnet	1
20	07701250151	O-RING 12,5X1,5 VITON V75	2
21	59038016200	Oil screen	1
22	0770020170	O-RING 17,17X1,78 GLO	1
23	59038017100	PLUG M20X1,5 WS=13	1
24	0401090003	BALL DIN5401-9	1
25	A48038026000	Compression spring	1
26	0025050146S	Hex coll. screw M5x14 ISA30 self-locking	3
27	78036024000	PLUG SCREW SAS M12X1,5	1
28	59030023100	Dowel, 6x8x11.5	1
29	0770012021	O-RING 12X2 VITON GREEN	1
30	0900001600200	Screw plug M16x1.5	1
33	A48038006033	Oil pump intermediate gear 31T	1
34	0988121805	SHIM WASHER DIN0988-12X18X0,50	2
35	0471120010	retaining ring DIN 471 12x1	1
36	77038013100	BUSHING PIN	1
37	77238061050	AXIAL-CIRCLIP	1
38	0018050103S	Oval head screw DIN 7985-M5x10-8.8	1
99	79438015010	OILFILTER SERVICEKIT SX-F	x

227953810

58168

* NEW PART

X ON DEMAND

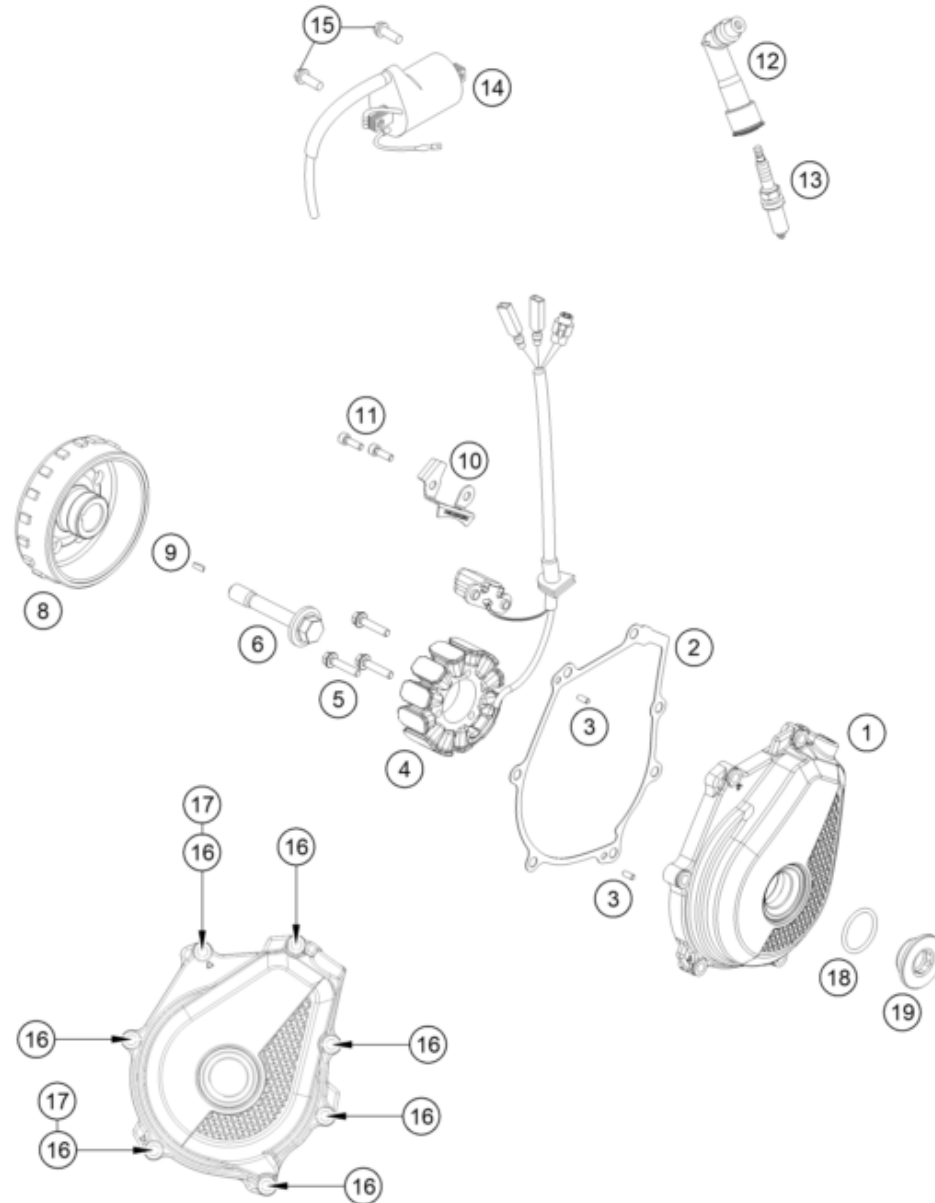

POS	PARTNUMBER	PARTNAME	PIECE
1	A48030002000C1	Ignition cover	1
2	A48030040000	Ignition cover gasket	1
3	0402040980	NEEDLE ROL.DIN5402 NRB 4X9,8	2
4	79239004200	Stator	1
5	0012050253S	Bolt DIN 6912 - M5x25 SS	3
6	77339010100	FLYWHEEL SCREW	1
8	79439005100	Rotor	1
9	0888030037	WOODRUFF KEY DIN6888-3X3,7	1
10	A46030002050	Cable retainer	1
11	0912050163S	Cap head screw DIN912 - M5x16 - 8.8	2
12	79539090000	Spark plug connector	1
13	77839093000	spark plug	1
14	58439006000	IGNITIONCOIL IG3826 KOKUSAN'96	1
15	0026060186	COLLAR SCREW M6X18 ISA30	2
16	0025060256	HH collar screw M6x25 TX30	7
17	0603061001	CU-SEAL RING DIN7603-6X10X1	2
18	07700240251	o-ring 24.00x2.50 Viton	1
19	7723000216030	SCREW PLUG M24X1,5	1

227953910

58188

* NEW PART

X ON DEMAND

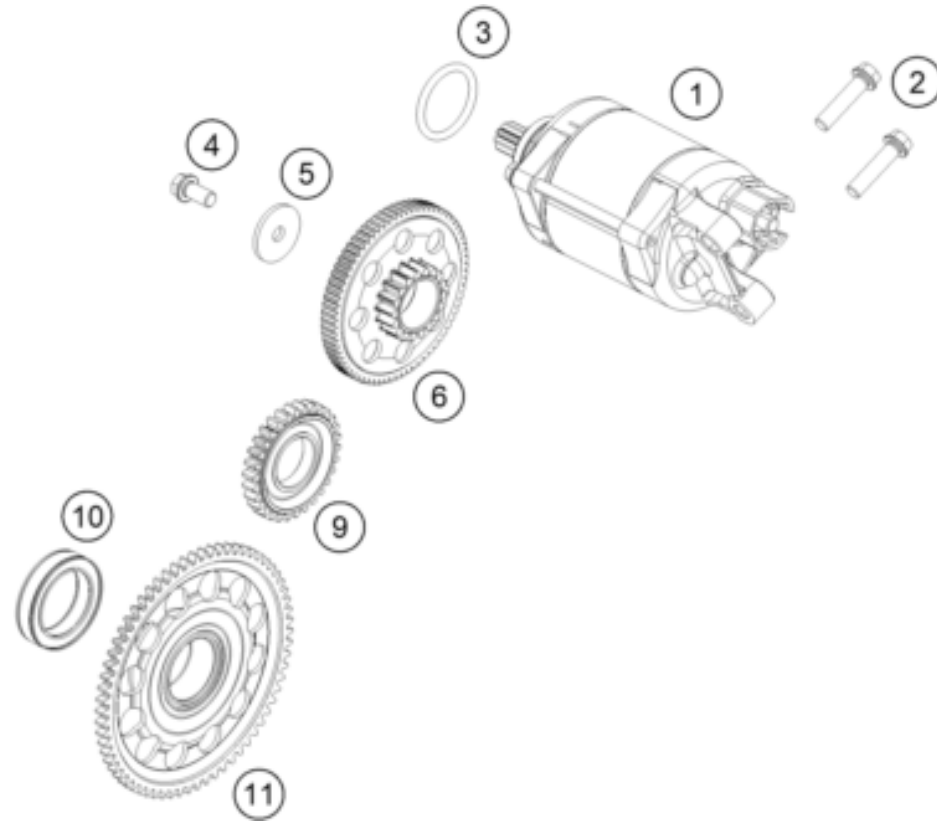

POS	PARTNUMBER	PARTNAME	PIECE
1	79440001000	E-STARTER CPL. 0,5KW	1
2	0025060256	HH collar screw M6x25 TX30	2
3	0770250030	O-RING 25,00X3,00 NBR 70	1
4	0025060126S	Hex collar screw M6x12 ISA30 self-lockin	1
5	78040016004	STOP DISC 6X23X2	1
6	79540016000	Torque limiter cml.	1
9	A48040022030	E. starter idler gear 30 teeth	1
10	75040026000	FREE WHEEL	1
11	79440020133	freewheel gear cpl.	1

227954010

58189

* NEW PART

X ON DEMAND

THROTTLE BODY

Engine 450 SMR 2023

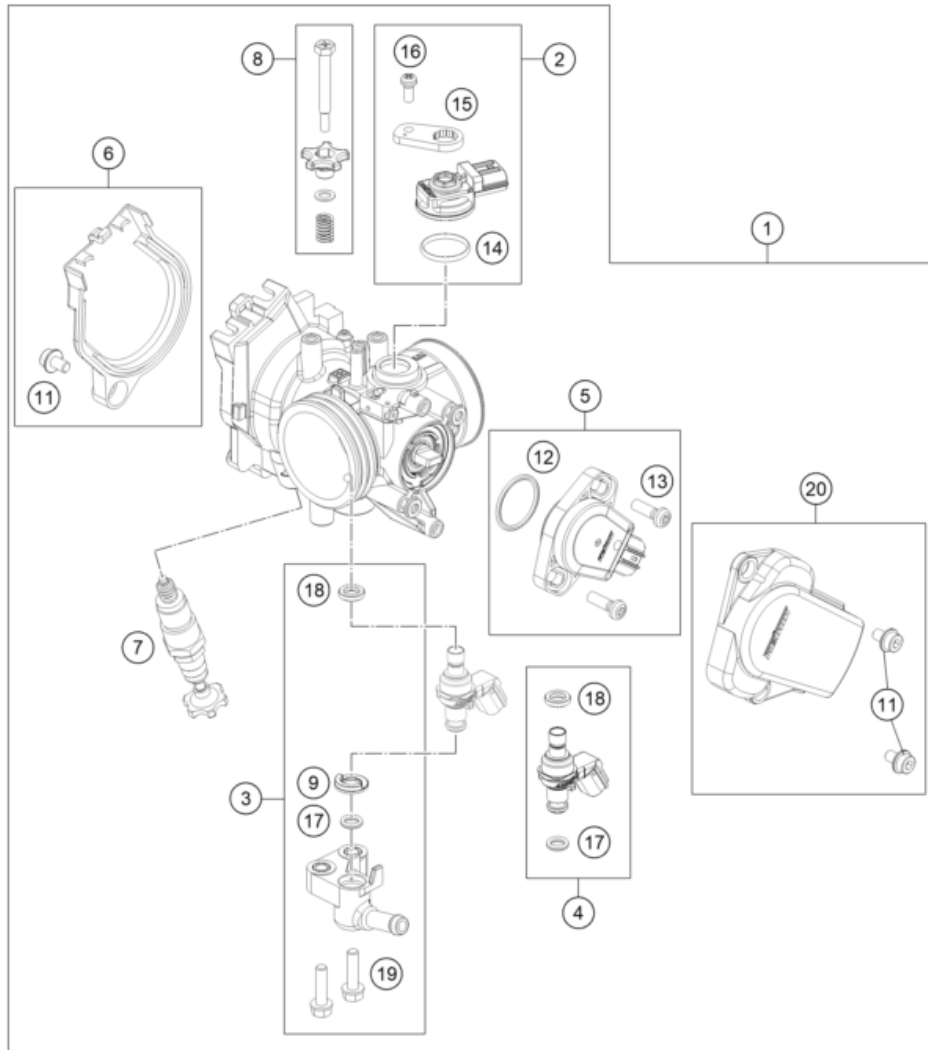

POS	PARTNUMBER	PARTNAME	PIECE
1	A46041001000	Throttle body	1
2	77741085044	MAP SENSOR CPL.	1
3	79041013044	FUEL PIPE CPL.	1
4	79041023144	Injector cmpl.	1
5	79041077044	TPS CPL.	1
6	79141056044	DKK Cover cpl.	1
7	79041070000	STARTER VALVE CPL.	1
8	77741060044	IDLING ADJUSTING SCREW CPL.	1
9	79041023030	SEAL RING	1
11	79041056020	SPECIAL SCREW	3
12	75041077110	O-RING	1
13	61041077020	SCREW THROTTLE POS. SENSOR	2
14	75041085010	O-RING	1
15	77741085020	PLATE	1
16	81241085030	SPECIAL SCREW	1
17	60341023020	O-RING	1
18	75041023010	SEAL RING	1
19	79041013060	SPECIAL SCREW M5X20	2
20	79141078044	TPS Cover cpl.	1
22	61041080000	AMBIENT-AIR TEMPERATURE SENSOR	1
23	0081050181	SCREW FOR PLASTIC K50X18 T20	2
24	A46041088000	Roll-over sensor	1
27	79641031000	ENGINE CONTROL UNIT EFI	1
28	A46041031050	ECU rubber strap	1

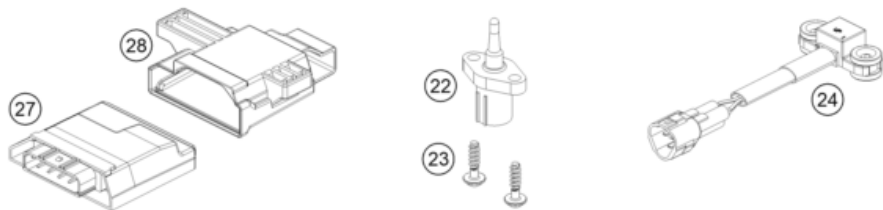

227954110

58204

* NEW PART

X ON DEMAND

A large, empty rectangular box with a thin black border, occupying the majority of the page. It is intended for the user to write their notes.

KTM.COM



089580WEN

KTM Sportmotorcycle GmbH
5230 Mattighofen, Austria
www.ktm.com

KTM POWERPARTS

KTM POWERWEAR

KTM ORIGINAL SPARE PARTS



Art. Nr.: 089580WEN 9. Mai 2022