

390 DUKE

ART. NO. 3214904EN



Perform the work described in these setup instructions before the vehicle is delivered to the customer.

Read the setup instructions in their entirety before beginning work.

These setup instructions were written to correspond to the latest state of this model series. We reserve the right to make modifications in the interest of technical advancement without at the same time updating these setup instructions.

We shall not provide a description of general workshop methods. Likewise, safety rules that apply in a workshop are not specified here. It is assumed that the work will be performed by a fully trained mechanic.

All specifications contained herein are non-binding. KTM Sportmotorcycle GmbH specifically reserves the right to modify or delete technical specifications, prices, colors, forms, materials, services, designs, equipment, etc., without prior notice and without specifying reasons, to adapt these to local conditions, as well as to stop production of a particular model without prior notice. KTM accepts no liability for delivery options, deviations from figures and descriptions, misprints, and other errors. The models portrayed partly contain special equipment that does not belong to the regular scope of supply.

© 2023 KTM Sportmotorcycle GmbH, Mattighofen Austria

All rights reserved

Reproduction, even in part, as well as copying of all kinds, is permitted only with the express written permission of the copyright owner.



ISO 9001(12 100 6061)

KTM applies quality assurance processes that lead to the highest possible product quality as defined in the ISO 9001 international quality management standard.

Issued by: TÜV Management Service

REG.NO. 12 100 6061

KTM Sportmotorcycle GmbH
Stallhofnerstraße 3
5230 Mattighofen, Austria

This document is valid for the following models:

390 DUKE EU (F4303W1, F4303W2)

390 DUKE B.D. EU (F4303W5, F4303W6)

390 DUKE B.D. 2 EU (F4303W7, F4303W8)

390 DUKE B.D. 3 EU (F4303WD, F4303WE)

390 DUKE B.D.4 EU (F4303WB, F4303WC)

390 DUKE JP (F4386W1, F4386W2)

390 DUKE UK (F4322W3, F4322W4)

390 DUKE US (F4375W1, F4375W2)

390 DUKE B.D. US (F4375W1L, F4375W2L)



1 MEANS OF REPRESENTATION

1.1 Symbols used

The meaning of specific symbols is described below.



Indicates an expected reaction (e.g. of a work step or a function).



Indicates an unexpected reaction (e.g. of a work step or a function).



Indicates a page reference (more information is provided on the specified page).



Indicates information with more details or tips.



Indicates the result of a testing step.



Indicates a voltage measurement.



Indicates a current measurement.



Indicates a resistance measurement.



Indicates the end of an activity including potential rework.

1.2 Formats used

The typographical formats used in this document are explained below.

Proprietary name

Indicates a proprietary name.

Name®

Indicates a protected name.

Brand™

Indicates a brand available on the open market.

Underlined terms

Refer to technical details of the vehicle or indicate technical terms, which are explained in the glossary.

2.1 Transport mode

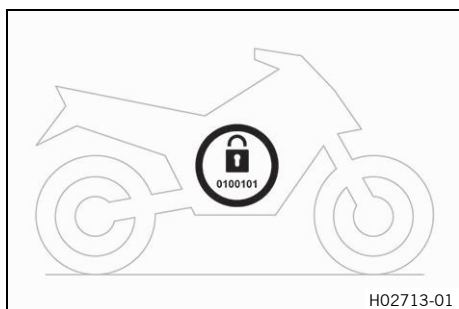

This vehicle was blocked for transport in the software. To operate the vehicle, the vehicle electronics must be enabled. This process is conducted during initial setup in KTM Dealer.net. Enabling ensures that the initial setup in KTM Dealer.net is documented.

Enabling can be performed either temporarily, e.g. for a test ride, or permanently for vehicle handover.

i Info

Make sure that the vehicle is permanently enabled before handing it over to the customer.

2.2 Diagnostics connector

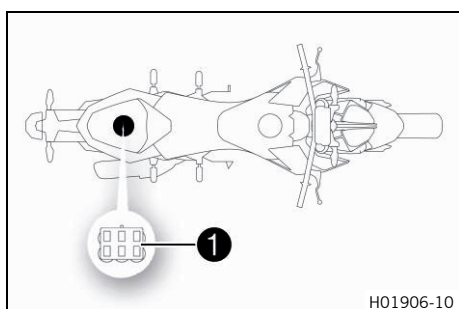

Diagnostics connector **1** is located under the passenger seat.

2.3 Unpacking and setting up the vehicle



- Remove the straps and the box.
- Remove the adhesive tape in the upper area of the motorcycle.



- Roll down the film at the sides.

i Info

To avoid damaging the motorcycle during unpacking, leave the other films on the vehicle until you have finished work on the vehicle.

- Remove the separate enclosure and unpack it. Check the separate enclosure for completeness.
- Check the vehicle for transport damage.

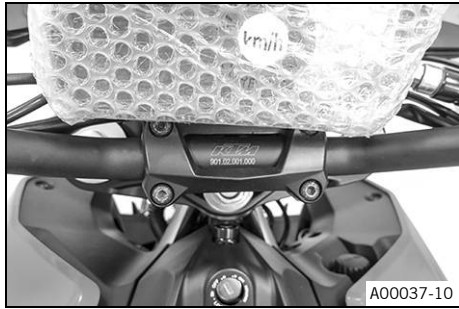

Warning

Danger of accidents A repaired handlebar poses a safety risk.

If the handlebar is bent or straightened, the material becomes fatigued. The handlebar may break as a result.

- Change the handlebar if the handlebar is damaged or bent.

- Position the handlebar.



Info

Make sure the cables and wiring are positioned correctly.

- Position the handlebar clamp. Mount and tighten the screws evenly.

Guideline

Screw, handlebar clamp	M8	19 Nm (14 lbf ft) Loctite®243™
------------------------	----	--

- ✓ The lettering on the handlebar is in the middle of the handlebar clamp.

- Position all controls in their exact positions on the handlebar. Tighten all screws.

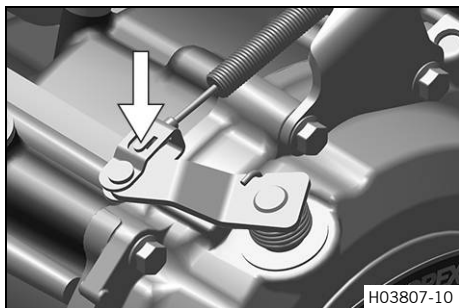

- Make sure that the clutch cable is attached to the clutch release lever and secured.
- Check the clutch lever play. (📖 p. 7)
- Mount and tighten the rear mirror on both sides.

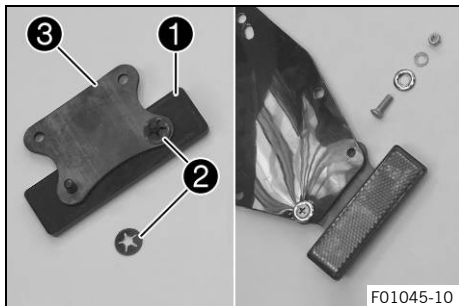

- Mount rear reflector **1** with spring washers **2** on holding plate **3**.
- Mount the retaining plate on the license plate holder.
- Mount the license plate holder.
- Carefully loosen and remove the tension belt over the link fork.



Info

An assistant prevents the motorcycle from falling over.

- Carefully loosen and remove the tension belts around the lower triple clamp.
- ✓ The vehicle is released at the front.
- Together with an assistant, take the vehicle off the pallet.

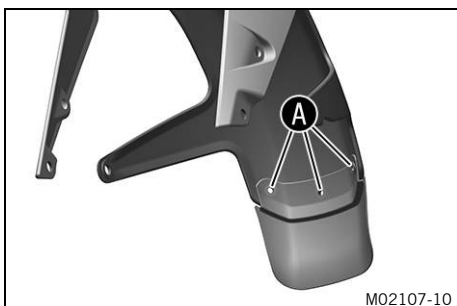

Condition

Fender extension available in the separate enclosure.

- Use fender extension as drilling template and drill holes in fender at locations **A**.
- Attach fender extension to fender with bolts, washers, and nuts.



- Remove the passenger seat. (📖 p. 8)
- Take tool set out of the separate enclosure and fasten onto the bottom of the passenger seat using the rubber straps provided in the tool set.
- Remove the front rider's seat. (📖 p. 8)
- Remove spare key and **KEYCODECARD** from under the seat and keep in a safe place for the handover.



Warning

Risk of injury Battery acid and battery gases cause serious chemical burns.

- Keep 12 V batteries out of the reach of children.
- Wear suitable protective clothing and safety glasses.
- Avoid contact with battery acid and battery gases.
- Keep sparks or open flames away from the 12 V battery.
- Only charge 12 V batteries in well-ventilated rooms.
- Rinse the affected area immediately with plenty of water in the event of contact with the skin.
- Rinse eyes with water for at least 15 minutes and consult a doctor immediately if battery acid and battery gases get into the eyes.

- Fill the 12 V battery.



Info

Read the notes in the 12 V battery accessory pack.

- Charge the 12-V battery. (📖 p. 9)
- Install the 12-V battery. (📖 p. 11)
- Remove the remaining film, padding, the corrugated cardboard, and the other packaging material.
- Refuel. (📖 p. 14)
- Check the headlight setting. (📖 p. 15)
- Prepare the vehicle according to the specifications in the **KTM Dealer.net** for handover to the customer.

**Info**

Transport mode must be deactivated to be able to start the motorcycle.



3.1 Checking the clutch lever play

Note

Clutch damage If there is no free travel by the clutch lever, the clutch will begin to slip.

- Check the free travel of the clutch lever each time before using the motorcycle.
- Adjust the free travel of the clutch lever when necessary in accordance with the specification.

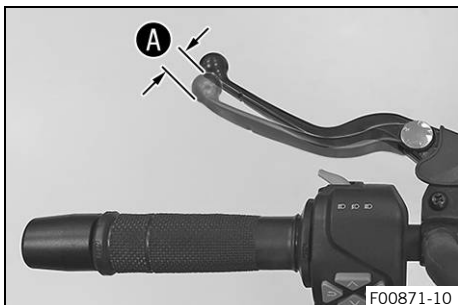

- Check the clutch lever for smooth operation.
- Move the handlebar to the straight-ahead position.
- Pull the clutch lever until resistance is perceptible, and determine the play in the clutch lever **A**.

Clutch lever play A	1 ... 3 mm (0.04 ... 0.12 in)
----------------------------	-------------------------------

- » If the clutch lever play does not meet the specified value:
 - Adjust play in the clutch lever. (📖 p. 7)
- Move the handlebar to and fro over the entire steering range.

The clutch lever play must not change.

- » If the clutch lever play changes:
 - Check the routing of the clutch cable.



3.2 Adjusting play in the clutch lever

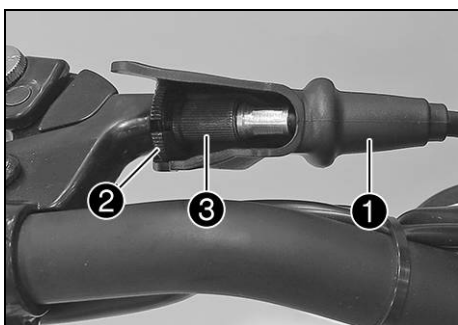

- Move the handlebar to the straight-ahead position.
- Push back sleeve **1**.
- Loosen lock nut **2**.
- Adjust the play in the clutch level **A** by turning adjusting screw **3**.

Guideline

Clutch lever play A	1 ... 3 mm (0.04 ... 0.12 in)
----------------------------	-------------------------------

- Tighten lock nut **2**.
- Position bellows **1**.

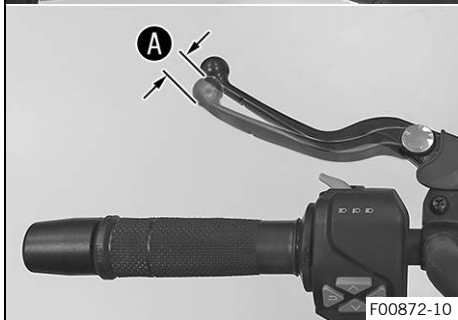

3.3 Removing the passenger seat

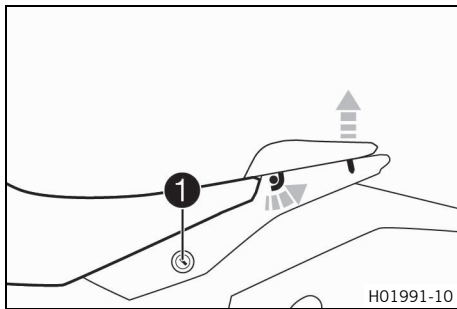

- Insert the ignition key in seat lock **1** and turn it clockwise.
- Raise the rear of the seat, push it towards the rear, and lift it off.
- Remove the ignition key from the seat lock.

3.4 Mounting the passenger seat

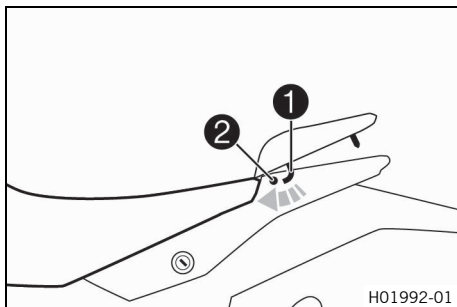

- Attach hooks **1** on the passenger seat to seat mounting **2** on the subframe, and lower it at the rear while pushing forward.
- Press the passenger seat downward until it clicks into place.



Warning

Danger of accidents The seat can come loose from the anchoring if it is not mounted correctly.

- After assembly, check whether the seat is correctly locked and cannot be pulled up.

- Finally, check that the passenger seat is correctly mounted.

3.5 Removing the front rider's seat

Preparatory work

- Remove the passenger seat. (📖 p. 8)

Main work

- Raise the rear of the front rider's seat, pull it towards the rear, and remove it upwards.

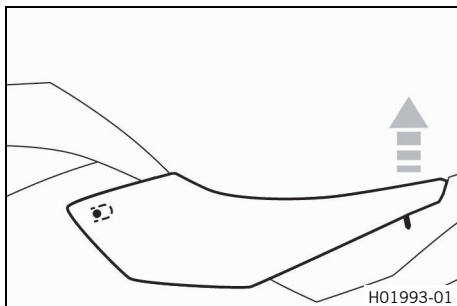

3.6 Mounting the front rider's seat

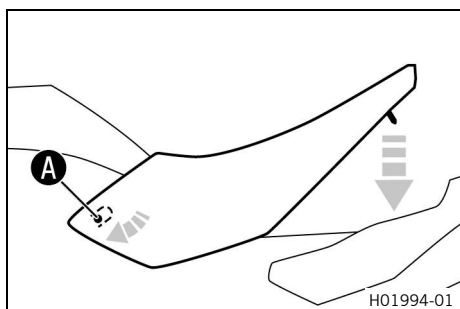

Main work

- Attach the front rider's seat in area **A** and lower at the rear.
- Finally, check that the front rider's seat is correctly mounted.

Finishing work

- Mount the passenger seat. (📖 p. 8)



3.7 Charging the 12-V battery



Warning

Risk of injury Battery acid and battery gases cause serious chemical burns.

- Keep 12 V batteries out of the reach of children.
- Wear suitable protective clothing and safety glasses.
- Avoid contact with battery acid and battery gases.
- Keep sparks or open flames away from the 12 V battery.
- Only charge 12 V batteries in well-ventilated rooms.
- Rinse the affected area immediately with plenty of water in the event of contact with the skin.
- Rinse eyes with water for at least 15 minutes and consult a doctor immediately if battery acid and battery gases get into the eyes.

Note

Danger of damage An incorrectly selected charging mode will damage the 12-V battery.

- Always select a charging mode that is compatible with the type of battery.



Note

Environmental hazard 12 V batteries contain environmentally hazardous materials.

- Do not dispose of 12 V batteries as household waste.
- Dispose of 12 V batteries at a collection point for used batteries.



Note

Environmental hazard Hazardous substances cause environmental damage.

- Dispose of oils, grease, filters, fuel, cleaning agents, brake fluid, etc., correctly and in compliance with the applicable regulations.



Info

Even when there is no load on the 12-V battery, it discharges steadily each day. The charging level and the method of charging are very important for the service life of the 12-V battery. Rapid recharging with a high charging current shortens the service life of the battery. If the charging current, charging voltage, or charging time is exceeded, electrolyte escapes through the safety valves. This reduces the capacity of the 12-V battery. If the 12-V battery is discharged by repeated starting, charge the 12-V battery immediately. If the 12-V battery is left in a discharged state for an extended period, it will become deeply discharged and sulfating occurs, thus destroying the battery. The 12-V battery is maintenance-free. The acid level does not have to be checked.

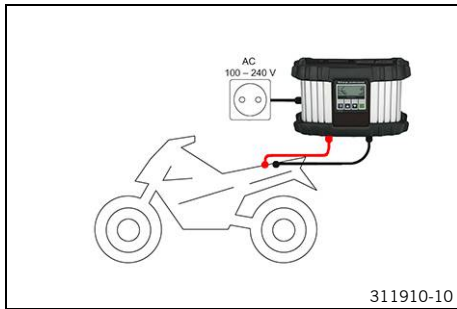

Preparatory work

- Remove the passenger seat. (📖 p. 8)
- Remove the front rider's seat. (📖 p. 8)
- Disconnect the negative cable of the 12-V battery. (📖 p. 10)

Main work

- Connect a battery charger to the 12-V battery. Adjust the battery charger.

EU battery charger **XCharge-professional** (00029095050)

Alternative 1

US battery charger **XCharge-professional** (00029095051)

Alternative 2

UK battery charger **XCharge-professional** (00029095052)



Info

Follow the instructions of the charger and the manual.

- Disconnect the battery charger after charging the 12-V battery.

Guideline

The charging current, charging voltage, and charging time must not be exceeded.

Recharge the 12-V battery regularly when the motorcycle is not being used

6 months

Finishing work

- Connect the negative cable of the 12-V battery. (📖 p. 11)
- Mount the front rider's seat. (📖 p. 9)
- Mount the passenger seat. (📖 p. 8)
- Set time and date. (📖 p. 12)

3.8 Disconnecting the negative cable of the 12-V battery

Preparatory work

- Remove the passenger seat. (📖 p. 8)
- Remove the front rider's seat. (📖 p. 8)

Main work

- Disconnect negative cable **1** of the 12-V battery.

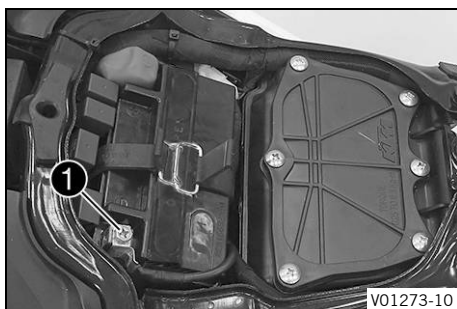

3.9 Connecting the negative cable of the 12-V battery

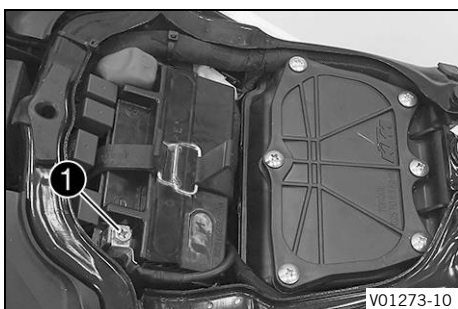

V01273-10

Main work

- Connect negative cable ❶ of the 12-V battery.

Finishing work

- Mount the front rider's seat. (📖 p. 9)
- Mount the passenger seat. (📖 p. 8)
- Set time and date. (📖 p. 12)



3.10 Installing the 12-V battery

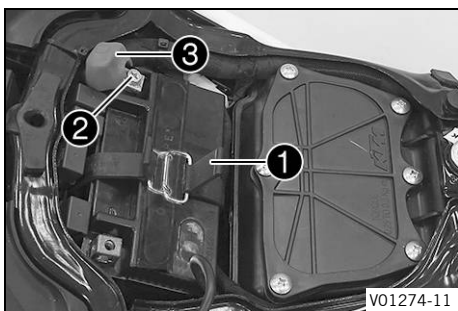

V01274-11

Main work

- Position the 12-V battery in the battery compartment.

12-V battery (ETZ-9-BS)

- Attach rubber strap ❶.
- Position positive cable ❷ and mount and tighten the screw.
- Position positive terminal cover ❸.
- Position negative cable ❹; mount and tighten the screw.

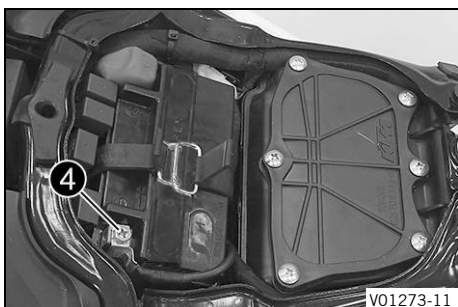

V01273-11

Finishing work

- Mount the front rider's seat. (📖 p. 9)
- Mount the passenger seat. (📖 p. 8)
- Set time and date. (📖 p. 12)



3.11 Setting the time and date

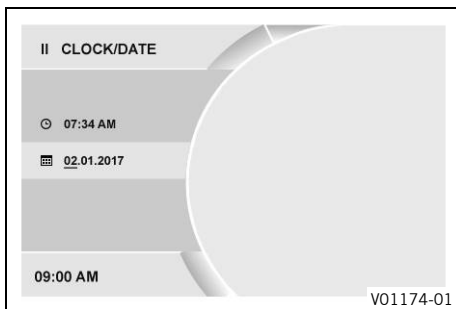
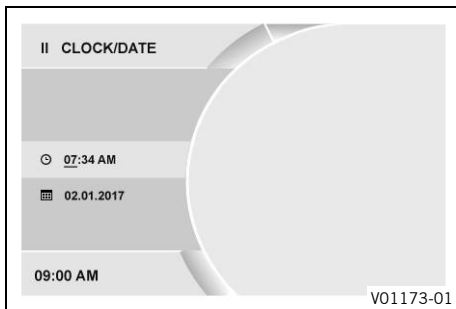
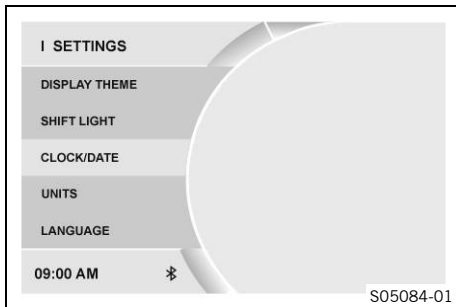

Condition

The motorcycle is stationary.

- Press the **SET** button when the menu is closed.
- Press **UP** or **DOWN** button until **Settings** appears. Press the **SET** button to open the menu.
- Press the **UP** or **DOWN** button until **Time/Date** is highlighted. Press the **SET** button to open the menu.

Setting the clock

- Press **UP** or **DOWN** button until the time is marked.
- Press the **SET** button.
 - ✓ The hour flashes and is underlined.
- Press **UP** or **DOWN** button until the current hour is set.
- Press the **SET** button.
 - ✓ The minutes flash and are underlined.
- Press **UP** or **DOWN** button until the current minute is set.
- Press the **SET** button.
 - ✓ The time is stored.

Setting the date

- Press **UP** or **DOWN** button until the date is marked.
- Press the **SET** button.
 - ✓ The day flashes and is underlined.
- Press **UP** or **DOWN** button until the current day is set.
- Press the **SET** button.
 - ✓ The month flashes and is underlined.
- Press **UP** or **DOWN** button until the current month is set.
- Press the **SET** button.
 - ✓ The year flashes and is underlined.
- Press **UP** or **DOWN** button until the current year is set.
- Press the **SET** button.
 - ✓ The date is stored.

3.12 Opening fuel tank filler cap



Danger

Fire hazard Fuel is highly flammable.

The fuel in the fuel tank expands when warm and can escape if overfilled.

- Do not fuel the vehicle in the vicinity of open flames or lit cigarettes.
- Switch off the engine for refueling.
- Make sure that no fuel is spilled; particularly not on hot parts of the vehicle.
- If any fuel is spilled, wipe it off immediately.
- Observe the specifications for refueling.



Warning

Danger of poisoning Fuel is harmful to health.

- Avoid skin, eye and clothing contact with fuel.
- Immediately consult a doctor if you swallow fuel.
- Do not inhale fuel vapors.
- Rinse the affected area immediately with plenty of water in the event of contact with the skin.
- Rinse the eyes thoroughly with water, and consult a doctor in case of fuel contact with the eyes.
- Change your clothing if fuel spills on them.
- Keep fuels correctly in a suitable canister, and out of the reach of children.



Note

Environmental hazard Improper handling of fuel is a danger to the environment.

- Do not allow fuel to enter the groundwater, the soil, or the sewage system.

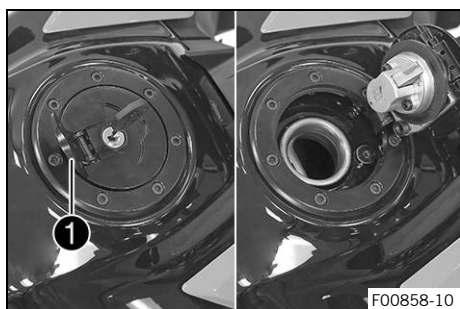

- Lift cover **1** of the fuel tank filler cap and insert the ignition key into the lock.

Note

Danger of damage The ignition key may break if overloaded.

Damaged ignition keys must be replaced.

- Push down on the fuel tank filler cap to take pressure off the ignition key.
- Turn the ignition key 90° clockwise.
- Lift the fuel tank filler cap.



3.13 Closing the fuel tank filler cap

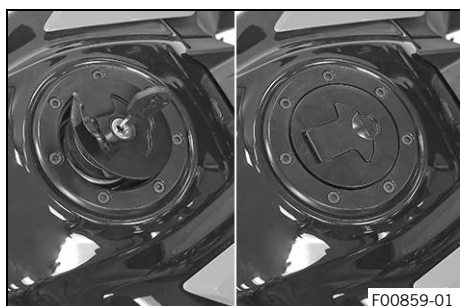

Warning

Fire hazard Fuel is highly flammable and a health hazard.

- Check that the fuel tank filler cap is locked correctly after closing.
- Change your clothing if fuel spills on them.
- Rinse the affected area immediately with plenty of water in the event of contact with the skin.

- Fold down the fuel tank filler cap.
- Turn the ignition key 90° clockwise.
- Push down the fuel tank filler cap and turn the ignition key counterclockwise until the fuel tank filler cap lock engages.
- Remove the ignition key and close the cover.



3.14 Refueling



Danger

Fire hazard Fuel is highly flammable.

The fuel in the fuel tank expands when warm and can escape if overfilled.

- Do not fuel the vehicle in the vicinity of open flames or lit cigarettes.
- Switch off the engine for refueling.
- Make sure that no fuel is spilled; particularly not on hot parts of the vehicle.
- If any fuel is spilled, wipe it off immediately.
- Observe the specifications for refueling.



Warning

Danger of poisoning Fuel is harmful to health.

- Avoid skin, eye and clothing contact with fuel.
- Immediately consult a doctor if you swallow fuel.
- Do not inhale fuel vapors.
- Rinse the affected area immediately with plenty of water in the event of contact with the skin.
- Rinse the eyes thoroughly with water, and consult a doctor in case of fuel contact with the eyes.
- Change your clothing if fuel spills on them.

Note

Material damage Inadequate fuel quality causes the fuel filter to quickly become clogged.

In some countries and regions, the available fuel quality and cleanliness may not be sufficient. This will result in problems with the fuel system.

- Refuel only with clean fuel that meets the specified standards.



Note

Environmental hazard Improper handling of fuel is a danger to the environment.

- Do not allow fuel to enter the groundwater, the soil, or the sewage system.

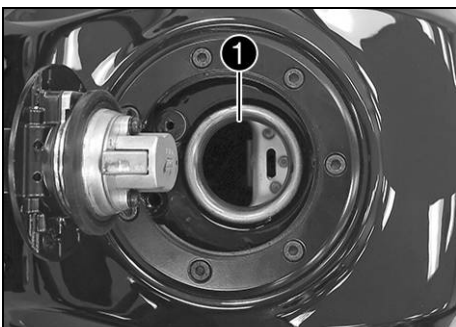

- Switch off the engine.
- Open fuel tank filler cap. (📖 p. 12)
- Fill the fuel tank with fuel up to the lower edge **1** of the fuel filler.

Total fuel tank capacity, approx.	13.5 l (3.57 US gal)	Super unleaded (ROZ 95) (📖 p. 19)
-----------------------------------	-------------------------	---

- Close the fuel tank filler cap. (📖 p. 13)



V01516-10

3.15 Checking the headlight setting

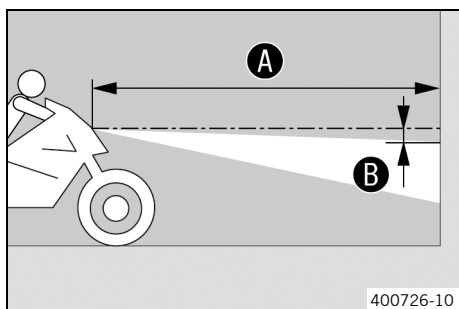

400726-10

- Park the vehicle on a horizontal surface in front of a light-colored wall and make a mark at the height of the center of the low beam headlight.

- Make another mark at a distance **B** under the first marking.

Guideline

Distance B	5 cm (2 in)
-------------------	-------------

- Position the vehicle vertical to the wall at distance **A** from the wall and switch on the low beam.

Guideline

Distance A	5 m (16 ft)
-------------------	-------------

- The rider now mounts the motorcycle with luggage and passenger if applicable.
- Check the headlight setting.

The light-dark boundary must be exactly on the lower marking when the motorcycle is ready to be operated with the rider mounted along with any luggage and a passenger if applicable.

- » If the boundary between light and dark does not meet specifications:

- Adjust the headlight range. (📖 p. 15)



3.16 Adjusting the headlight range

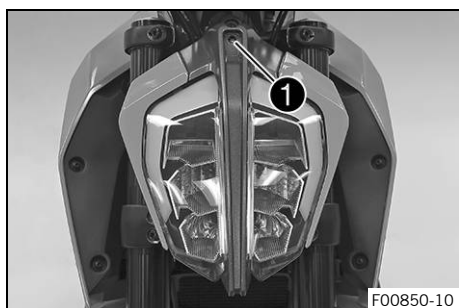

F00850-10

Preparatory work

- Check the headlight setting. (📖 p. 15)

Main work

- Turn adjusting screw **1** to adjust the headlight range.



Info

Turn clockwise to increase the headlight range; turn counterclockwise to reduce the headlight range. If you have a payload, you may have to correct the headlight range.

Screw **1** also secures the headlight. Ensure the screw is always screwed in far enough.

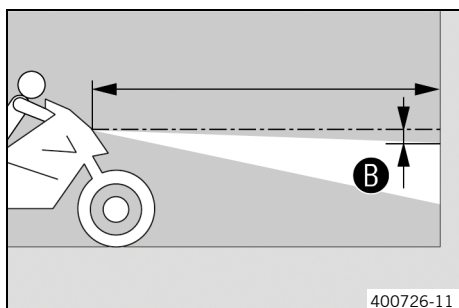

400726-11

- Set the headlight to marking **B**.

Guideline

The light-dark boundary must lie exactly on lower marking **B** when the motorcycle is ready to operate with the rider mounted along with any luggage and a passenger if applicable.



4 TECHNICAL SPECIFICATIONS

4.1 chassis tightening torques

Screw, chain guard	EJOT PT® K60x30	Tightening to hand-tight
Remaining screws, chassis	M4	4 Nm (3 lbf ft)
Remaining nuts, chassis	M5	5 Nm (3.7 lbf ft)
Remaining screws, chassis	M5	5 Nm (3.7 lbf ft)
Screw, chain guard	M5	7 Nm (5.2 lbf ft) Loctite®243™
Screw, chain guard on link fork	M5	7 Nm (5.2 lbf ft)
Screw, compensating tank cap lock, rear brake	M5	9 Nm (6.6 lbf ft)
Screw, front spoiler on engine	M5	5 Nm (3.7 lbf ft)
Screw, fuel tank cover	M5	4 Nm (3 lbf ft)
Screw, outer clutch cable guide	M5	5 Nm (3.7 lbf ft) Loctite®243™
Screw, side stand sensor	M5	5 Nm (3.7 lbf ft) Loctite®243™
Screw, tail light	M5	5 Nm (3.7 lbf ft)
Nut, foot brake lever adjustment	M6	9 Nm (6.6 lbf ft)
Remaining nuts, chassis	M6	15 Nm (11.1 lbf ft)
Remaining screws, chassis	M6	9 Nm (6.6 lbf ft)
Screw, ABS hose clamp	M6	7 Nm (5.2 lbf ft)
Screw, ABS module	M6	6 Nm (4.4 lbf ft)
Screw, ABS module retaining bracket on frame	M6	7 Nm (5.2 lbf ft)
Screw, air filter box	M6	6 Nm (4.4 lbf ft)
Screw, brake fluid reservoir for rear brake	M6	7 Nm (5.2 lbf ft) Loctite®243™
Screw, brake hose clamp	M6	7 Nm (5.2 lbf ft)
Screw, chain sliding guard	M6	7 Nm (5.2 lbf ft)
Screw, combination instrument	M6	7 Nm (5.2 lbf ft)
Screw, compensating tank	M6	5 Nm (3.7 lbf ft)
Screw, damper block	M6	8 Nm (5.9 lbf ft)
Screw, engine sprocket cover	M6	8 Nm (5.9 lbf ft)
Screw, front fender	M6	7 Nm (5.2 lbf ft)
Screw, front seat fixing	M6	9 Nm (6.6 lbf ft)
Screw, front spoiler	M6x12	5 Nm (3.7 lbf ft)
Screw, front spoiler lower part	M6x9	6 Nm (4.4 lbf ft)
Screw, front spoiler on engine	M6	7 Nm (5.2 lbf ft)
Screw, fuel pump	M6	9 Nm (6.6 lbf ft)
Screw, fuel tank trim	M6	5 Nm (3.7 lbf ft)
Screw, fuel tank trim	M6	7 Nm (5.2 lbf ft)
Screw, headlight	M6	7 Nm (5.2 lbf ft)
Screw, holder of fuel vapor valve	M6	9 Nm (6.6 lbf ft)
Screw, ignition coil	M6	8 Nm (5.9 lbf ft)

Screw, ignition lock (tamper-proof screw)	M6	Tighten until the head tears off.
Screw, license plate holder	M6	10 Nm (7.4 lbf ft) Loctite®243™
Screw, lower rear panel	M6	7 Nm (5.2 lbf ft)
Screw, magnetic holder on side stand	M6	5 Nm (3.7 lbf ft) Loctite®243™
Screw, main silencer	M6	12 Nm (8.9 lbf ft)
Screw, main silencer retaining bracket	M6	9 Nm (6.6 lbf ft)
Screw, protective plate	M6	7 Nm (5.2 lbf ft)
Screw, radiator holder	M6	10 Nm (7.4 lbf ft)
Screw, radiator shield	M6	7 Nm (5.2 lbf ft)
Screw, rear brake cylinder	M6	7 Nm (5.2 lbf ft) Loctite®243™
Screw, rear splash protector	M6	9 Nm (6.6 lbf ft)
Screw, rear wheel speed sensor	M6	8 Nm (5.9 lbf ft) Loctite®243™
Screw, shift lever linkage	M6	11 Nm (8.1 lbf ft) Loctite®243™
Screw, side stand sensor cable holder	M6	9 Nm (6.6 lbf ft) Loctite®243™
Screw, silent block	M6	7 Nm (5.2 lbf ft)
Screw, tilt sensor	M6	6 Nm (4.4 lbf ft) Loctite®243™
Screw, wheel speed sensor holder	M6	8 Nm (5.9 lbf ft)
Nut, rear sprocket	M8	27 Nm (19.9 lbf ft)
Remaining nuts, chassis	M8	30 Nm (22.1 lbf ft)
Remaining screws, chassis	M8	25 Nm (18.4 lbf ft)
Screw, bottom triple clamp	M8	15 Nm (11.1 lbf ft)
Screw, engine bearer	M8	22 Nm (16.2 lbf ft)
Screw, foot brake lever	M8	16 Nm (11.8 lbf ft) Loctite®243™
Screw, fork stub	M8	15 Nm (11.1 lbf ft)
Screw, front brake disc	M8	30 Nm (22.1 lbf ft) Loctite®243™
Screw, front seat fixing	M8	25 Nm (18.4 lbf ft)
Screw, front wheel spindle	M8	25 Nm (18.4 lbf ft)
Screw, fuel tank	M8	16 Nm (11.8 lbf ft)
Screw, grab handle	M8	22 Nm (16.2 lbf ft)
Screw, handlebar clamp	M8	19 Nm (14 lbf ft) Loctite®243™
Screw, horn	M8	12 Nm (8.9 lbf ft)
Screw, main silencer	M8	23 Nm (17 lbf ft)
Screw, passenger footrest unit	M8	21 Nm (15.5 lbf ft) Loctite®243™
Screw, rear brake disc	M8	21 Nm (15.5 lbf ft) Loctite®243™

4 TECHNICAL SPECIFICATIONS

Screw, rear seat fixing	M8	18 Nm (13.3 lbf ft)
Screw, seat support plate	M8	18 Nm (13.3 lbf ft)
Screw, subframe	M8	25 Nm (18.4 lbf ft) Loctite® 620™
Screw, top triple clamp	M8	15 Nm (11.1 lbf ft)
Screw, front brake caliper	M8x1	29 Nm (21.4 lbf ft) Loctite®243™
Banjo bolt, brake line	M10	24 Nm (17.7 lbf ft)
Fitting side stand	M10	35 Nm (25.8 lbf ft) Loctite®243™
Remaining nuts, chassis	M10	50 Nm (36.9 lbf ft)
Remaining screws, chassis	M10	46 Nm (33.9 lbf ft)
Screw, engine bearer	M10	49 Nm (36.1 lbf ft) Loctite®243™
Fitting, handlebar support	M10x1.25	21 Nm (15.5 lbf ft)
Fitting, shock absorber, bottom	M10x1.25	50 Nm (36.9 lbf ft) Loctite®243™
Nut, left rear mirror	M10x1.25	27 Nm (19.9 lbf ft)
Nut, right rear mirror	M10LHx1.25	27 Nm (19.9 lbf ft)
Nut, side stand bracket	M10x1.25	35 Nm (25.8 lbf ft)
Screw, front footrest bracket	M10x1.25	47 Nm (34.7 lbf ft) Loctite®243™
Screw, front footrest bracket / engine bearer	M10x1.25	47 Nm (34.7 lbf ft)
Screw, top shock absorber	M10x1.25	50 Nm (36.9 lbf ft) Loctite®243™
Stud, rear sprocket	M10x1.25	50 Nm (36.9 lbf ft)
Nut, rear wheel spindle	M14x1.5	98 Nm (72.3 lbf ft)
Nut, swingarm pivot	M14x1.5	98 Nm (72.3 lbf ft)
Screw, steering head, top	M16x1.5	47 Nm (34.7 lbf ft) Loctite®243™
Lambda sensor	M18x1.5	19 Nm (14 lbf ft)
Adjusting ring, link fork bearing	M22x1	7 Nm (5.2 lbf ft)
Nut, steering head	M30x1	1st stage 45 Nm (33.2 lbf ft) 2nd stage (loosen, counterclockwise) 2 turns 3rd stage 5 Nm (3.7 lbf ft)

Super unleaded (ROZ 95)

Standard/classification

- DIN EN 228 (ROZ 95)

Guideline

- Only use super unleaded fuel that matches or is equivalent to the specified standard.
- Fuel with an ethanol content of up to 10% (E10 fuel) is safe to use.



Info

Do **not** use fuel containing methanol (e.g., M15, M85, M100) or more than 10% ethanol (e.g., E15, E25, E85, E100).



3214904en

06.06.2023

