

125 DUKE

ART. NO. 3214956EN



Congratulations on your decision to purchase a KTM motorcycle. You are now the owner of a state-of-the-art sports vehicle which, with appropriate care, will bring you pleasure for a long time to come.

We wish you good and safe riding at all times!

Enter the serial numbers of your vehicle below.

Vehicle identification number (📖 p. 12)	Dealer's stamp
Engine number (📖 p. 12)	
Key number (📖 p. 12)	

The Owner's Manual contained the latest information for this model series at the time of publication. However, minor differences due to further developments in design cannot be ruled out completely.

All specifications contained herein are non-binding. KTM Sportmotorcycle GmbH specifically reserves the right to modify or delete technical specifications, prices, colors, forms, materials, services, designs, equipment, etc., without prior notice and without specifying reasons, to adapt these to local conditions, as well as to stop production of a particular model without prior notice. KTM accepts no liability for delivery options, deviations from figures and descriptions, misprints, and other errors. The models portrayed partly contain special equipment that does not belong to the regular scope of supply.

© 2023 KTM Sportmotorcycle GmbH, Mattighofen Austria

All rights reserved

Reproduction, even in part, as well as copying of all kinds, is permitted only with the express written permission of the copyright owner.



ISO 9001(12 100 6061)

KTM applies quality assurance processes that lead to the highest possible product quality as defined in the ISO 9001 international quality management standard.

Issued by: TÜV Management Service

REG.NO. 12 100 6061

KTM Sportmotorcycle GmbH
Stallhofnerstraße 3
5230 Mattighofen, Austria

This document is valid for the following models:

125 DUKE EU (F4003X1, F4003X2)

125 DUKE B.D. EU (F4003X3, F4003X4)

125 DUKE JP (F4086X3, F4086X4)

125 DUKE UK (F4022X3, F4022X4)



3214956en

02.11.2023

TABLE OF CONTENTS

1	MEANS OF REPRESENTATION	5	6.18	Closing the fuel tank filler cap.....	18
1.1	Symbols used	5	6.19	Seat lock.....	19
1.2	Formats used.....	5	6.20	Tool set.....	19
2	SAFETY ADVICE.....	6	6.21	Supporting strap	19
2.1	Use definition.....	6	6.22	Passenger foot pegs	19
2.2	Misuse.....	6	6.23	Shift lever	20
2.3	Safety advice.....	6	6.24	Foot brake lever	20
2.4	Degrees of risk and symbols.....	6	6.25	Side stand.....	20
2.5	Tampering warning.....	7	7	COMBINATION INSTRUMENT	21
2.6	Safe operation	7	7.1	Combination instrument	21
2.7	Protective clothing	7	7.2	Activation and test	21
2.8	Work rules.....	8	7.3	Warnings.....	22
2.9	Environment.....	8	7.4	Indicator lamps.....	23
2.10	Owner's Manual	8	7.5	Display	24
3	IMPORTANT NOTES.....	9	7.6	Track display	25
3.1	Manufacturer warranty, implied warranty.....	9	7.7	Engine speed.....	26
3.2	Fuel, auxiliary substances.....	9	7.8	Shift warning light	26
3.3	Spare parts, technical accessories	9	7.9	Speedometer	26
3.4	Service	9	7.10	Speed limiter display (optional)	27
3.5	Figures	9	7.11	Time.....	27
3.6	Customer service.....	9	7.12	Ride-Mode display	27
4	VIEW OF VEHICLE	10	7.13	ABS display.....	27
4.1	View of vehicle, front left (example) ...	10	7.14	Coolant temperature indicator	28
4.2	View of vehicle, rear right (example).....	11	7.15	Fuel level display	28
5	SERIAL NUMBERS	12	7.16	Heated grip (optional).....	29
5.1	Vehicle identification number.....	12	7.17	Favorites display	29
5.2	Type label	12	7.18	Quick Selector 1 display	29
5.3	Engine number	12	7.19	Quick Selector 2 display	29
5.4	Key number.....	12	7.20	Navigation display (optional)	30
6	CONTROLS.....	13	7.21	Call display	30
6.1	Clutch lever.....	13	7.22	Remote Control Mode (optional) (RCM)	30
6.2	Hand brake lever.....	13	7.23	Menu.....	31
6.3	Foot brake lever	13	7.23.1	Lap Timer	31
6.4	Throttle grip	13	7.23.2	Alle Runden Löschen	31
6.5	Combination switch.....	14	7.23.3	Motorcycle	32
6.6	Hazard warning flasher switch.....	14	7.23.4	Ride Mode	32
6.7	Menu buttons	14	7.23.5	ABS.....	32
6.8	Horn button.....	15	7.23.6	Bike Info.....	33
6.9	Light switch	15	7.23.7	Bike Info.....	33
6.10	Turn signal switch.....	15	7.23.8	Warning.....	34
6.11	Emergency OFF switch	15	7.23.9	Trip Info	34
6.12	Start button.....	16	7.23.10	Trip 1	34
6.13	Ignition and steering lock.....	16	7.23.11	Trip 2	35
6.14	USB socket	16	7.23.12	Geschwindigkeitsbegrenzer (optional)	35
6.15	Locking the steering.....	16	7.23.13	Geschwindigkeitsbegrenzer State (optional)	35
6.16	Unlocking the steering.....	17	7.23.14	Navigation (optional)	36
6.17	Opening fuel tank filler cap.....	17	7.23.15	Volume (optional)	36
			7.23.16	State (optional).....	36
			7.23.17	Heating (optional)	37
			7.23.18	Heated Grips (function optional)....	37















7.23.19	Audio	37	12	SERVICE WORK ON THE CHASSIS.....	64
7.23.20	Settings	38	12.1	Raising the motorcycle with rear lifting gear	64
7.23.21	Favorites	38	12.2	Removing the rear of the motorcycle from the lifting gear	64
7.23.22	Favorites-Anzeige 1-4.....	38	12.3	Lifting the motorcycle with the front lifting gear	64
7.23.23	Quick Selector 1	39	12.4	Taking the motorcycle off the front lifting gear	65
7.23.24	Quick Selector 2	39	12.5	Cleaning the dust boots of the fork legs	65
7.23.25	Konnektivität.....	39	12.6	Removing the passenger seat	66
7.23.26	Bluetooth.....	40	12.7	Mounting the passenger seat.....	66
7.23.27	Pairing a cellphone	40	12.8	Removing the front rider's seat	67
7.23.28	Pairing a headset.....	41	12.9	Mounting the front rider's seat.....	67
7.23.29	Headset Type	42	12.10	Checking for chain dirt accumulation.....	67
7.23.30	QUICKSHIFTER+ (optional)	42	12.11	Cleaning the chain	67
7.23.31	Shift Light	43	12.12	Checking the chain tension	68
7.23.32	Shift Light State	43	12.13	Adjusting the chain tension.....	69
7.23.33	RPM1	43	12.14	Checking the chain, rear sprocket, and engine sprocket	70
7.23.34	RPM2.....	44	12.15	Adjusting the basic position of the clutch lever	71
7.23.35	Setting the time and date	44	12.16	Checking the clutch lever play.....	72
7.23.36	Clock Format.....	45	12.17	Adjusting play in the clutch lever  ...	72
7.23.37	Date Format	45	13	BRAKE SYSTEM	73
7.23.38	Units	46	13.1	Anti-lock braking system (ABS)	73
7.23.39	Distance	46	13.2	Adjusting the basic position of the hand brake lever	74
7.23.40	Temperature.....	46	13.3	Checking the brake discs	74
7.23.41	Consumption	47	13.4	Checking the front brake fluid level ...	75
7.23.42	Language	47	13.5	Adding front brake fluid 	75
7.23.43	Heating (function optional)	47	13.6	Checking that the brake linings of the front brake are secured	77
7.23.44	Extra Functions	48	13.7	Checking the rear brake fluid level....	77
8	PREPARING FOR USE.....	49	13.8	Adding rear brake fluid 	78
8.1	Advice on preparing for first use	49	13.9	Checking that the brake linings of the rear brake are secured.....	79
8.2	Running in the engine	50	14	WHEELS, TIRES	81
8.3	Loading the vehicle	50	14.1	Removing the front wheel 	81
9	RIDING INSTRUCTIONS.....	51	14.2	Installing the front wheel 	81
9.1	Checks and maintenance measures when preparing for use	51	14.3	Removing the rear wheel 	82
9.2	Starting.....	51	14.4	Installing the rear wheel 	83
9.3	Starting off.....	52	14.5	Checking the rear hub damping rubber pieces 	84
9.4	Quickshifter+ (optional).....	52	14.6	Checking the tire condition	85
9.5	Shifting, riding	53	14.7	Checking tire pressure	86
9.6	Applying the brakes.....	55	15	ELECTRICAL SYSTEM	87
9.7	Stopping, parking.....	56	15.1	Removing the 12-V battery 	87
9.8	Transport	57	15.2	Installing the 12-V battery 	87
9.9	Towing in the event of a breakdown ...	57	15.3	Charging the 12-V battery 	88
9.10	Refueling	58			
10	SERVICE SCHEDULE	60			
10.1	Additional information.....	60			
10.2	Service work	60			
11	TUNING THE CHASSIS	62			
11.1	Adjusting the spring preload of the shock absorber 	62			
11.2	Adjusting the shift lever.....	62			

TABLE OF CONTENTS

15.4	Changing the main fuse.....	89	23	DECLARATIONS OF CONFORMITY	122
15.5	Changing the ABS fuses	91	23.1	Declarations of conformity	122
15.6	Changing the fuses of individual electrical power consumers	92	23.2	Country-specific declarations of conformity.....	122
15.7	Checking the headlight setting	94	24	SUBSTANCES	123
15.8	Adjusting the headlight range.....	94	25	AUXILIARY SUBSTANCES	125
15.9	Diagnostics connector	95	26	STANDARDS	126
15.10	Front ACC1 and ACC2	95	27	INDEX OF SPECIAL TERMS	127
15.11	Rear ACC1 and ACC2	96	28	LIST OF ABBREVIATIONS.....	128
16	COOLING SYSTEM	97	29	LIST OF SYMBOLS.....	129
16.1	Cooling system	97	29.1	Red symbols.....	129
16.2	Checking the antifreeze and coolant level	97	29.2	Yellow and orange symbols.....	129
16.3	Checking the coolant level	98	29.3	Green and blue symbols.....	129
16.4	Draining the coolant 	99	INDEX.....		130
16.5	Filling/bleeding the cooling system 	100			
16.6	Changing the coolant.....	102			
17	TUNING THE ENGINE.....	104			
17.1	Ride Mode	104			
18	SERVICE WORK ON THE ENGINE	105			
18.1	Checking the engine oil level.....	105			
18.2	Changing the engine oil and oil filter, cleaning the oil screen 	105			
18.3	Adding engine oil	107			
19	CLEANING, CARE	108			
19.1	Cleaning the motorcycle	108			
19.2	Checks and maintenance steps for winter operation	109			
20	STORAGE.....	110			
20.1	Storage	110			
20.2	Preparing for use after storage.....	111			
21	TROUBLESHOOTING	112			
22	TECHNICAL SPECIFICATIONS	114			
22.1	Engine	114			
22.2	Engine tightening torques	115			
22.3	Capacities	116			
22.3.1	Engine oil	116			
22.3.2	Coolant	116			
22.3.3	Fuel	116			
22.4	Chassis	117			
22.5	Electrical system.....	118			
22.6	Tires	118			
22.7	Fork.....	118			
22.8	Shock absorber	118			
22.9	Chassis tightening torques	119			

1.1 Symbols used

The meaning of specific symbols is described below.



Indicates an expected reaction (e.g., of a work step or a function).



Indicates an unexpected reaction (e.g., of a work step or a function).



Indicates work that requires expert knowledge and technical understanding. In the interest of your own safety, have these jobs performed by an authorized KTM workshop! Your motorcycle will be cared for there to the highest degree by specially trained experts using the special tools required.



Indicates a page reference (more information is provided on the specified page).



Indicates information with more details or tips.



Indicates the result of a testing step.



Indicates the end of an activity, including potential reworking.

1.2 Formats used

The typographical formats used in this document are explained below.

Proprietary name	Indicates a proprietary name.
Name®	Indicates a protected name.
Brand™	Indicates a brand available on the open market.
<u>Underlined terms</u>	Refer to technical details of the vehicle or indicate technical terms, which are explained in the glossary.

2.1 Use definition

KTM sport motorcycles are designed and constructed to meet the normal demands of regular road operation but not for use on race courses or offroad.



Info

The motorcycle is authorized for public road traffic in the homologous version only.

2.2 Misuse

The vehicle must only be used as intended.

Dangers can arise for people, property and the environment through use not as intended.

Any use of the vehicle beyond the intended and defined use constitutes misuse.

Misuse also includes the use of operating and auxiliary fluids which do not meet the required specification for the respective use.

2.3 Safety advice

A number of safety instructions need to be followed to operate the product described safely. Therefore read this instruction and all further instructions included carefully. The safety instructions are highlighted in the text and are referred to at the relevant passages.



Info

Various information and warning labels are attached in prominent locations on the product described. Do not remove any information or warning labels. If they are missing, you or others may not recognize dangers and may therefore be injured.

2.4 Degrees of risk and symbols



Danger

Identifies a danger that will immediately and invariably lead to fatal or serious permanent injury if the appropriate measures are not taken.



Warning

Identifies a danger that is likely to lead to fatal or serious injury if the appropriate measures are not taken.



Caution

Identifies a danger that may lead to minor injuries if the appropriate measures are not taken.

Note

Identifies a danger that will lead to considerable machine and material damage if the appropriate measures are not taken.



Note

Indicates a danger that will lead to environmental damage if the appropriate measures are not taken.

2.5 Tampering warning

Tampering with the noise control system is prohibited. Federal law prohibits the following acts or the causing thereof:

- 1 The removal or rendering inoperative by any person other than for purposes of servicing, repair, or replacement, of any device or element of design incorporated into any new vehicle for the purpose of noise control prior to its sale or delivery to the ultimate purchaser or while it is in use, or
- 2 the use of the vehicle after such device or element of design has been removed or rendered inoperative by any person.

Among those acts presumed to constitute tampering are the acts listed below:

- 1 Removal or puncturing of the main silencers, baffles, header pipes or any other components which conduct exhaust gases.
- 2 Removal or puncturing of parts of the intake system.
- 3 Lack of proper maintenance.
- 4 Replacing moving parts of the vehicle, or parts of the exhaust system or intake system, with parts other than those specified by the manufacturer.

2.6 Safe operation



Danger

Danger of accidents A rider who is not fit to ride poses a danger to him or herself and others.

- Do not operate the vehicle if you are not fit to ride due to alcohol, drugs or medication.
- Do not operate the vehicle if you are physically or mentally impaired.



Danger

Danger of poisoning Exhaust gases are toxic and inhaling them may result in unconsciousness and death.

- Always make sure there is sufficient ventilation when running the engine.
- Use effective exhaust extraction when starting or running the engine in an enclosed space.



Warning

Danger of burns Some vehicle components become hot when the vehicle is operated.

- Do not touch any parts such as the exhaust system, radiator, engine, damper, or brake system before the vehicle parts have cooled down.
- Let the vehicle parts cool down before you perform any work on the vehicle.

Only operate the vehicle when it is in perfect technical condition, in accordance with its intended use, and in a safe and environmentally compatible manner.

An appropriate driver's license is needed to ride the vehicle on public roads.

Have malfunctions that impair safety promptly eliminated by an authorized KTM workshop.

Adhere to the information and warning labels on the vehicle.

2.7 Protective clothing



Warning

Risk of injury Missing or poor protective clothing presents an increased safety risk.

- Wear appropriate protective clothing such as helmet, boots, gloves as well as trousers and a jacket with protectors on all rides.
- Always wear protective clothing that is in good condition and meets the legal regulations.

In the interest of your own safety, KTM recommends that you only operate the vehicle while wearing protective clothing.

2.8 Work rules

Unless specified otherwise, the ignition must be turned off during all work (models with ignition lock, models with transponder key) or the motor must be at a standstill (models without ignition lock or transponder key). Special tools are necessary for certain tasks. The tools are not a component of the vehicle, but can be ordered using the number in parentheses. Example: bearing puller (15112017000)
Unless otherwise noted, normal conditions apply to all tasks and descriptions.

Ambient temperature	20 °C (68 °F)
Ambient air pressure	1,013 mbar (14.69 psi)
Relative air humidity	60 ± 5 %

During assembly, use new parts to replace parts which cannot be reused (e.g. self-locking screws and nuts, expansion screws, seals, sealing rings, O-rings, pins, and lock washers).

In the case of certain screws, a screw adhesive (e.g. **Loctite**[®]) is required. Observe the manufacturer's instructions.

If thread locker (e.g., **Precote**[®]) has already been applied to a new part, do not apply any additional thread locker. After disassembly, clean the parts that are to be reused and check them for damage and wear. Change damaged or worn parts.

After completing a repair or service work, check the operating safety of the vehicle.

2.9 Environment

If you use your motorcycle responsibly, you can ensure that problems and conflicts do not occur. To protect the future of the motorcycle sport, make sure that you use your motorcycle legally, display environmental consciousness, and respect the rights of others.

When disposing of used oil, other operating and auxiliary fluids, and used components, comply with the laws and regulations of the respective country.

Because motorcycles are not subject to the EU regulations governing the disposal of used vehicles, there are no legal regulations that pertain to the disposal of an end-of-life motorcycle. Your authorized KTM dealer will be glad to advise you.

2.10 Owner's Manual

Read this owner's manual carefully and completely before making your first trip. The Owner's Manual contains useful information and many tips on how to operate, handle, and service your motorcycle. This is the only way to find out how best to customize the vehicle for your own use and how you can protect yourself from injury.



Tip

Store the Owner's Manual on your terminal device, for example, so that you can read it whenever you need to.

If you would like to know more about the vehicle or have questions on the material you read, please contact an authorized KTM dealer.

The Owner's Manual is an important component of the vehicle. If the vehicle is sold, the Owner's Manual must be downloaded again by the new owner.

The Owner's Manual can be downloaded several times using the QR code or the link on the delivery certificate.

The Owner's Manual is also available for download from your authorized KTM dealer and on the KTM website. A printed copy can also be ordered from your authorized KTM dealer.

International KTM Website: KTM.COM

3.1 Manufacturer warranty, implied warranty

The work prescribed in the service schedule must only be carried out in an authorized KTM workshop and confirmed in the **KTM Dealer.net**, as otherwise all warranty claims will be void. Damage or secondary damage caused by tampering with and/or conversions on the vehicle are not covered by the manufacturer warranty.

3.2 Fuel, auxiliary substances



Note

Environmental hazard Improper handling of fuel is a danger to the environment.

- Do not allow fuel to enter the groundwater, the soil, or the sewage system.

Use fuels and auxiliary substances in accordance with the Owner's Manual and specification.

3.3 Spare parts, technical accessories

For your own safety, only use spare parts and accessory products that are approved and/or recommended by KTM and have them installed by an authorized KTM workshop. KTM accepts no liability for other products and any resulting damage or loss.

Certain spare parts and accessory products are specified in parentheses in the descriptions. Your authorized KTM dealer will be glad to advise you.

The latest news **KTM PowerParts** on your vehicle can be found on the KTM website.

International KTM Website: KTM.COM

3.4 Service

A prerequisite for perfect operation and prevention of premature wear is that the service, care, and tuning work on the engine and chassis is properly carried out as described in the Owner's Manual. An incorrect suspension setting can lead to damage and breakage of chassis components.

Use of the vehicle under difficult conditions, such as dusty environments, heavy rain, high heat or with a heavy load, can lead to considerably more rapid wear of components such as the air filter, drive train, brake system, or suspension components. For this reason, it may be necessary to inspect or replace parts before the next scheduled service.

It is imperative that you adhere to the stipulated run-in times and service intervals. If you observe these exactly, you will ensure a much longer service life for your motorcycle.

The relevant mileage or time interval is whichever occurs first.

3.5 Figures

The figures contained in the manual may depict special equipment.

In the interest of clarity, some components may be shown disassembled or may not be shown at all. It is not always necessary to disassemble the component to perform the activity in question. Please follow the instructions in the text.

3.6 Customer service

Your authorized KTM dealer will be happy to answer any questions you may have on your vehicle and KTM.

A list of authorized KTM dealers can be found on the KTM website.

International KTM Website: KTM.COM

4 VIEW OF VEHICLE

4.1 View of vehicle, front left (example)



A01440-10

- ❶ Combination instrument
- ❷ Clutch lever (📖 p. 13)
- ❸ Front rider's seat
- ❹ Passenger seat
- ❺ Seat lock (📖 p. 19)
- ❻ Side stand (📖 p. 20)
- ❼ Shift lever (📖 p. 20)
- ❽ Engine number (📖 p. 12)

4.2 View of vehicle, rear right (example)

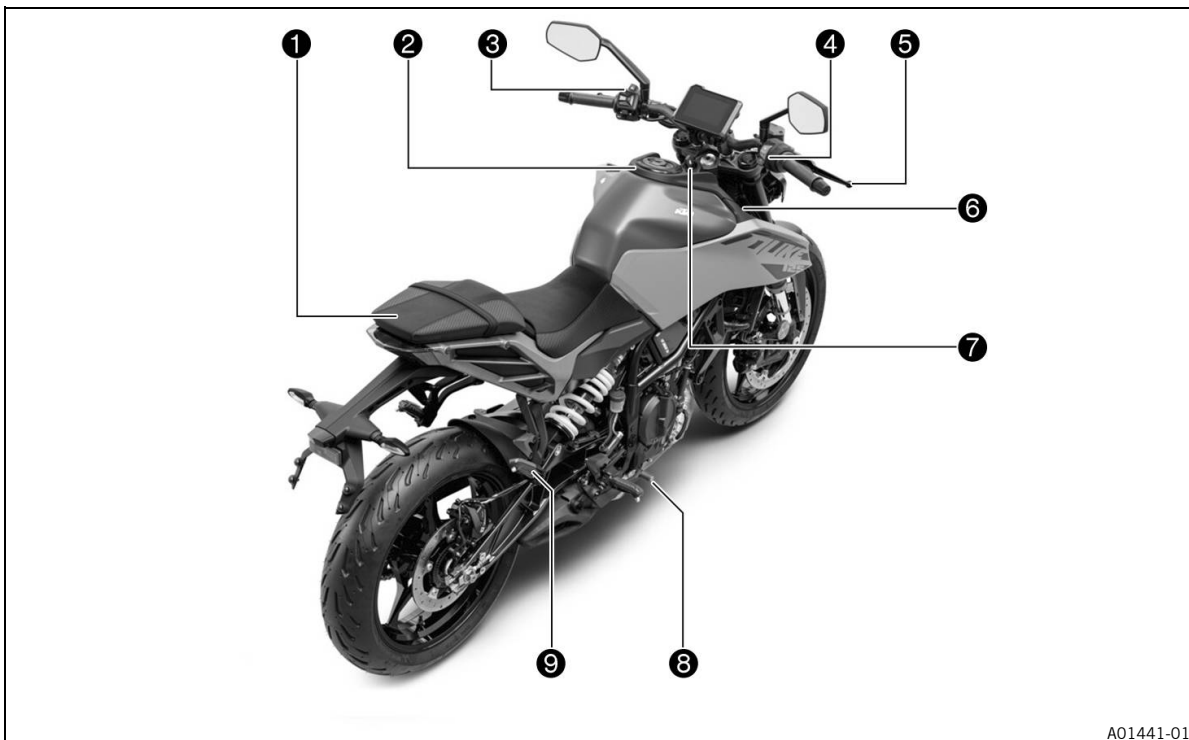

A01441-01

- ① Tool set (📖 p. 19)
- ② Fuel tank filler cap
- ③ Light switch (📖 p. 15)
- ③ Menu buttons (📖 p. 14)
- ③ Turn signal switch (📖 p. 15)
- ③ Horn button (📖 p. 15)
- ④ Start button (📖 p. 16)
- ④ Emergency OFF switch (📖 p. 15)
- ⑤ Hand brake lever (📖 p. 13)
- ⑥ Vehicle identification number (📖 p. 12)
- ⑦ Type label (📖 p. 12)
- ⑦ Ignition and steering lock (📖 p. 16)
- ⑧ Foot brake lever (📖 p. 20)
- ⑨ Passenger foot pegs (📖 p. 19)

5.1 Vehicle identification number

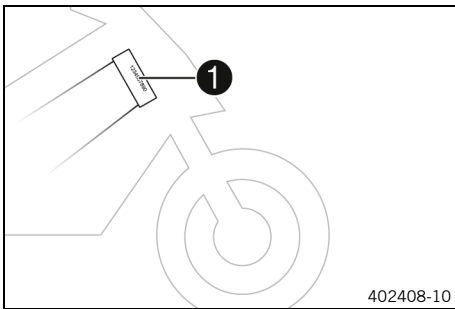

The vehicle identification number ❶ is stamped on the right side of the steering head.

5.2 Type label

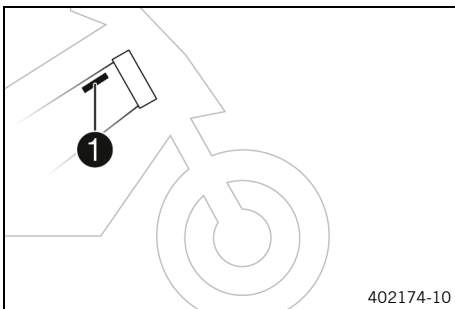

The type label ❶ is on the right of the frame behind the steering head.

5.3 Engine number

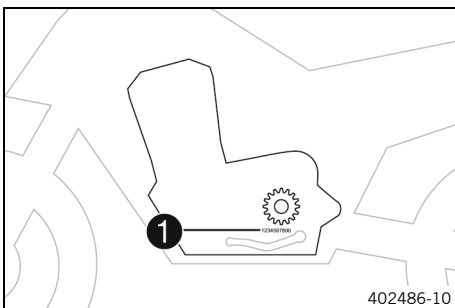

The engine number ❶ is stamped on the left side of the engine under the engine sprocket.

5.4 Key number

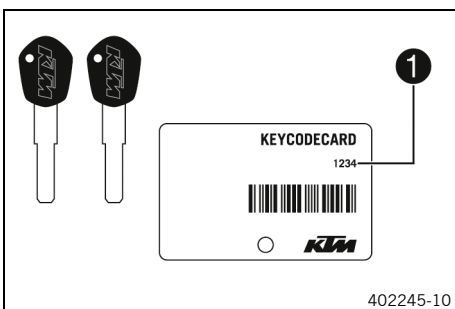

The key number ❶ can be found on the **KEYCODECARD**.



Info

The key number is needed to order a replacement key. Keep the **KEYCODECARD** in a safe place.

If at least one ignition key is still available, a spare key can be produced. If an ignition key is no longer present, the entire lock system must be replaced.

6.1 Clutch lever

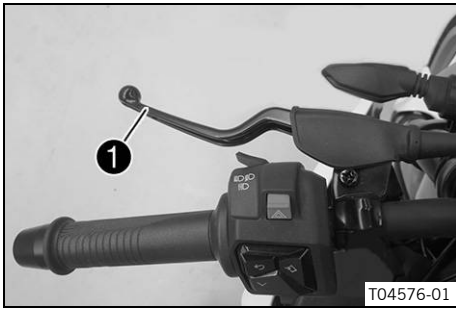

The clutch lever ① is fitted on the left side of the handlebar.

6.2 Hand brake lever

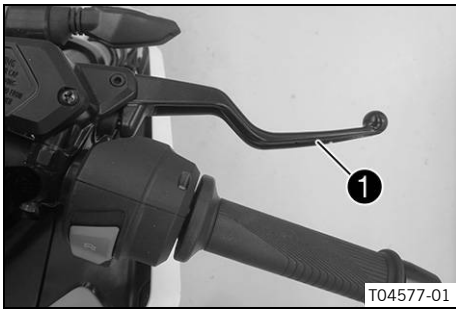

The hand brake lever ① is fitted on the right side of the handlebar.
The front brake is engaged using the hand brake lever.

6.3 Foot brake lever

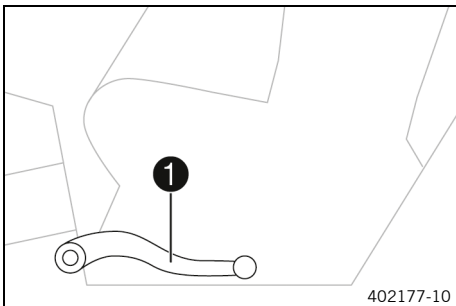

Foot brake lever ① is located in front of the right footrest.

i Info
The basic position of the foot brake lever is set at the factory and must not be changed.

The rear brake is engaged with the foot brake lever.

6.4 Throttle grip

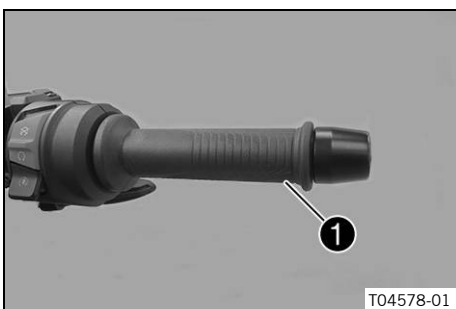

The throttle grip ① is fitted on the right side of the handlebar.

6.5 Combination switch

The combination switch is fitted on the left side of the handlebar.

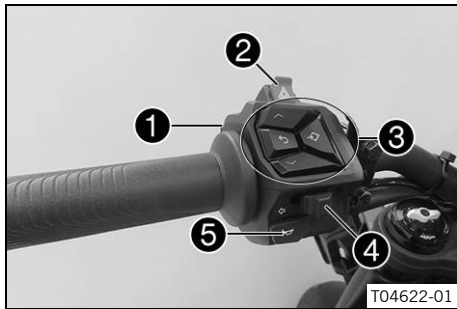

Overview of the left combination switch

- ❶ Light switch (📖 p. 15)
- ❷ Hazard warning flasher switch (📖 p. 14)
- ❸ Menu buttons (📖 p. 14)
- ❹ Turn signal switch (📖 p. 15)
- ❺ Horn button (📖 p. 15)

6.6 Hazard warning flasher switch

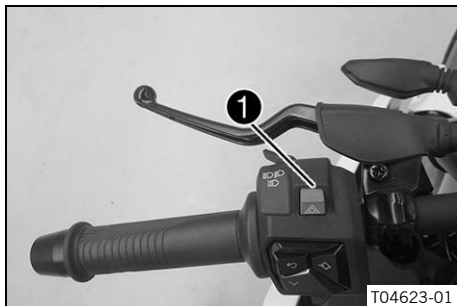

The hazard warning flasher switch ❶ is fitted on the top of the combination switch.

The hazard warning flasher is used to indicate emergency situations.

i Info

The hazard warning flasher can be activated or deactivated while the ignition is switched on or up to 60 seconds after the ignition is switched off.

Only keep the hazard warning flasher activated as long as necessary as it depletes the 12-V battery.

Possible states



Hazard warning flasher on – All four turn signals and the green turn signal indicator lights in the combination instrument flash.

6.7 Menu buttons

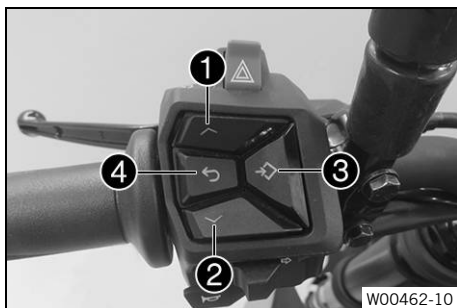

The menu buttons are fitted in the middle of the left combination switch.

The menu buttons are used to control the display on the combination instrument.

- Button ❶ is the **UP** button.
- Button ❷ is the **DOWN** button.
- Button ❸ is the **SET** button.
- Button ❹ is the **BACK** button.

6.8 Horn button

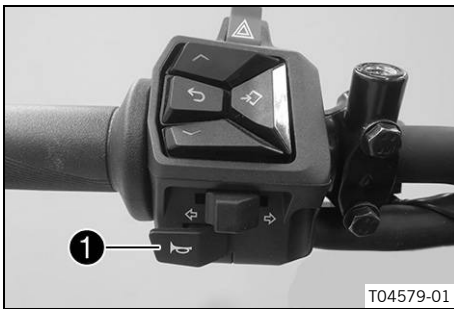

Horn button **1** is fitted on the left side of the handlebar.

Possible states

- The horn button **1** is in the basic position
- The horn button **1** is pressed – The horn is operated in this position.

6.9 Light switch

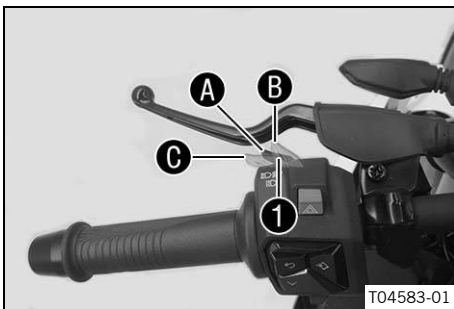

Light switch **1** is fitted on the left side of the handlebar.

Possible states

	Low beam on – Light switch in position A . In this position, the low beam and the tail light are switched on.
	High beam on – Push the light switch to position B . In this position, the high beam and the tail light are switched on.
	Headlight flasher – Push the light switch into position C .

6.10 Turn signal switch

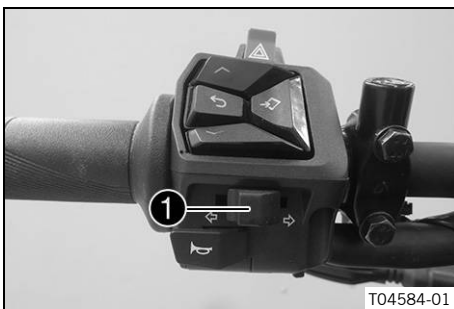

Turn signal switch **1** is fitted on the left side of the handlebar.

Possible states

	Turn signal off – Turn signal switch pushed toward the switch housing.
	Left turn signal, on – Turn signal switch pressed to the left. The turn signal switch returns automatically to the central position after use.
	Right turn signal, on – Turn signal switch pressed to the right. The turn signal switch returns automatically to the central position after use.

6.11 Emergency OFF switch



The emergency OFF switch **1** is fitted on the right side of the handlebar.

Possible states

	Emergency OFF switch off – In this position, the ignition circuit is interrupted, a running engine stops, and a non-running engine cannot be started.
	Emergency OFF switch on – This position is required for operation; the ignition circuit is closed.

6.12 Start button



Start button **1** is fitted on the right side of the handlebar.

Possible states

- The start button **1** is in the basic position
- The start button **1** is pressed – In this position, the starter motor is actuated.

6.13 Ignition and steering lock



The ignition and steering lock is located in front of the upper triple clamp.

Possible states

	Ignition off OFF – In this position, the ignition circuit is interrupted, a running engine stops, and a non-running engine will not start. The ignition key can be removed.
	Ignition on ON – In this position, the ignition circuit is closed and the engine can be started.
	Steering locked LOCK – In this position, the ignition circuit is interrupted and the steering locked. The ignition key can be removed.

6.14 USB socket



USB socket **1** for the power supply to external devices is mounted on the left side of the mask support.

The USB socket is activated when the ignition is switched on.

USB socket	
Voltage	5 V
Maximum current consumption	2.1 A

6.15 Locking the steering

Note

Danger of damage The parked vehicle can roll away or fall over.

- Park the vehicle on a firm and level surface.



- Park the vehicle.
- Turn the handlebar all the way to the left.
- Insert the ignition key into the ignition and steering lock, press in, and turn to the left. Remove the ignition key.
- ✓ Steering is no longer possible.



6.16 Unlocking the steering

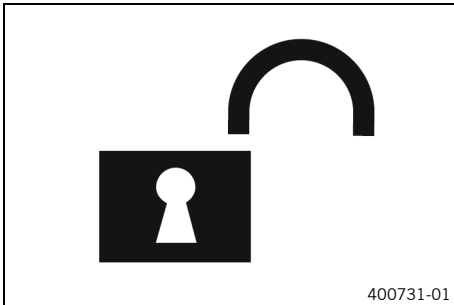

- Insert the ignition key into the ignition and steering lock, press in, and turn to the right. Remove the ignition key.
- ✓ The handlebar can now be moved again.



6.17 Opening fuel tank filler cap



Danger

Fire hazard Fuel is highly flammable.

The fuel in the fuel tank expands when warm and can escape if overfilled.

- Do not fuel the vehicle in the vicinity of open flames or lit cigarettes.
- Switch off the engine for refueling.
- Make sure that no fuel is spilled; particularly not on hot parts of the vehicle.
- If any fuel is spilled, wipe it off immediately.
- Observe the specifications for refueling.



Warning

Danger of poisoning Fuel is harmful to health.

- Avoid skin, eye and clothing contact with fuel.
- Immediately consult a doctor if you swallow fuel.
- Do not inhale fuel vapors.
- Rinse the affected area immediately with plenty of water in the event of contact with the skin.
- Rinse the eyes thoroughly with water, and consult a doctor in case of fuel contact with the eyes.
- Change your clothing if fuel spills on them.
- Keep fuels correctly in a suitable canister, and out of the reach of children.



Note

Environmental hazard Improper handling of fuel is a danger to the environment.

- Do not allow fuel to enter the groundwater, the soil, or the sewage system.

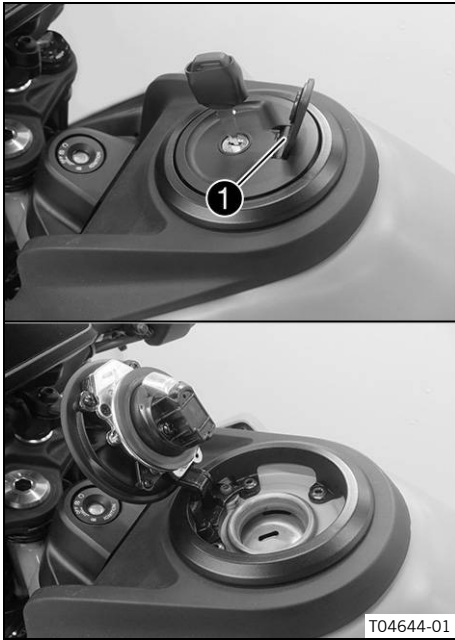

- Lift cover **1** of the fuel tank filler cap and insert the ignition key into the lock.

Note

Danger of damage The ignition key may break if overloaded.

Damaged ignition keys must be replaced.

- Push down on the fuel tank filler cap to take pressure off the ignition key.
- Turn the ignition key 90° clockwise.
- Lift the fuel tank filler cap.
- Remove the ignition key.

6.18 Closing the fuel tank filler cap

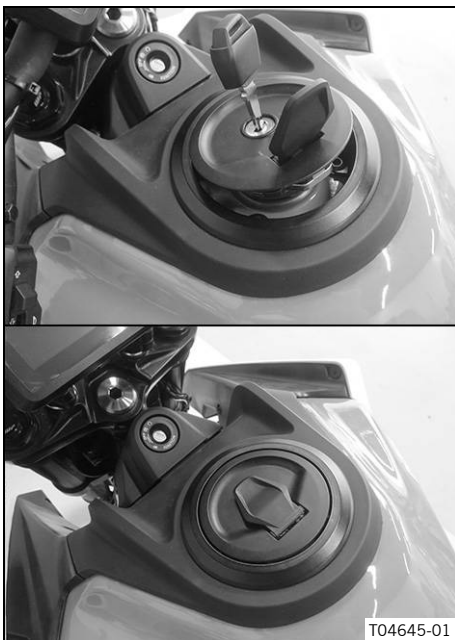

Warning

Fire hazard Fuel is highly flammable and a health hazard.

- Check that the fuel tank filler cap is locked correctly after closing.
- Change your clothing if fuel spills on them.
- Rinse the affected area immediately with plenty of water in the event of contact with the skin.
- Close the fuel tank filler cap.
- Push down the fuel tank filler cap until the lock engages.

6.19 Seat lock

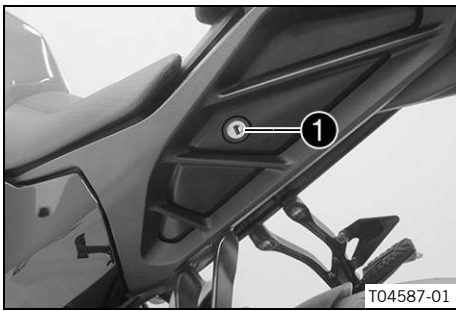

The seat lock ❶ is located to the left of the seat. The seat lock can be unlocked using the ignition key.

6.20 Tool set

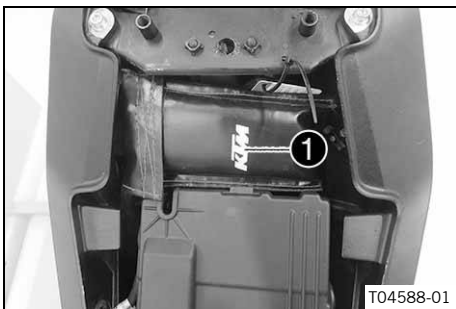

Tool set ❶ is located under seat.

6.21 Supporting strap



Supporting strap ❶ is used for maneuvering the motorcycle. If you carry a passenger, the passenger can hold onto the grab handles during the trip.

6.22 Passenger foot pegs

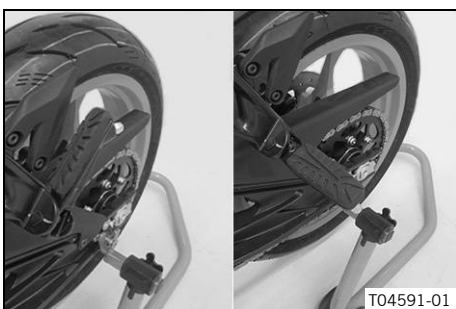

The passenger foot pegs can be folded up and down.

Possible states

- Passenger foot pegs folded up – For operation without a passenger.
- Passenger foot pegs folded down – For operation with a passenger.

6.23 Shift lever

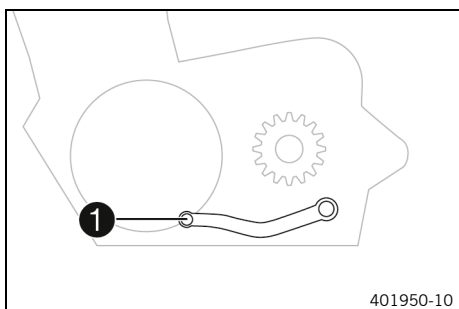

Shift lever ❶ is mounted on the left side of the engine.

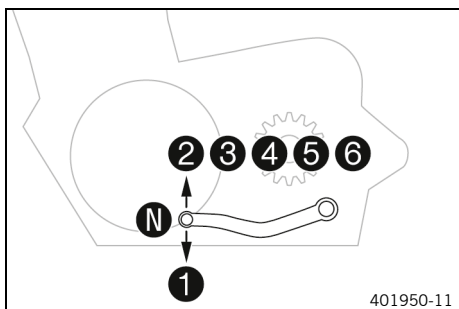

The gear positions can be seen in the photograph. The neutral or idle position is between the first and second gears.

6.24 Foot brake lever

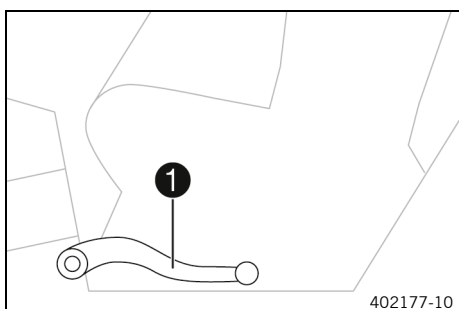

Foot brake lever ❶ is located in front of the right footrest. The foot brake lever is used to activate the rear brake.

6.25 Side stand

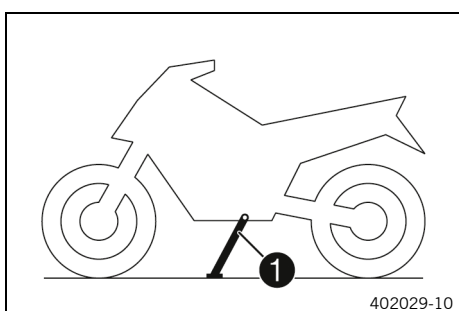

The side stand ❶ is located on the left of the vehicle. The side stand is used for parking the motorcycle.

i Info

The side stand must be folded up during motorcycle use. The side stand is coupled with the safety starting system; follow the riding instructions.

Possible states

- Side stand folded out – The vehicle can be supported on the side stand. The safety starting system is active.
- Side stand folded in – This position is mandatory when riding the motorcycle. The safety starting system is inactive.

7.1 Combination instrument



I00492-10

The combination instrument is attached in front of the handlebar.
The combination instrument is divided into two function areas.

① indicator lamps

Display ②



Caution

Danger of burns Parts of the combination instrument become hot in certain situations.

In particular, the display gets hot in ambient temperatures above 55 °C (131 °F), during extended stationary periods, for example, at a traffic light, or in direct sunlight.

- Do not touch the combination instrument with bare hands in the situations referred to.
- Where appropriate protective clothing.
- If you have been burned, hold the area affected under lukewarm water immediately.

7.2 Activation and test



I00195-01

Activation

The combination instrument is activated when the ignition is switched on.





Info



The brightness of the displays is controlled by an ambient light sensor in the combination instrument.



Test

The welcome text appears on the display and all indicator lamps are briefly activated for a function check.

i Info

The malfunction indicator lamp  always lights up as long as the engine is not running. If the engine is running and the malfunction indicator lamp  lights up, stop (taking care not to endanger yourself or other road users in the process) and contact an authorized KTM workshop.

The oil pressure warning lamp  always lights up as long as the engine is not running. If the engine is running and the oil pressure warning lamp  lights up, stop immediately (taking care not to endanger yourself or other road users in the process) and switch off the engine.

The ABS warning lamp  and TC indicator lamp  light up until a speed of approx. 6 km/h (approx. 4 mph) or faster has been reached.

7.3 Warnings

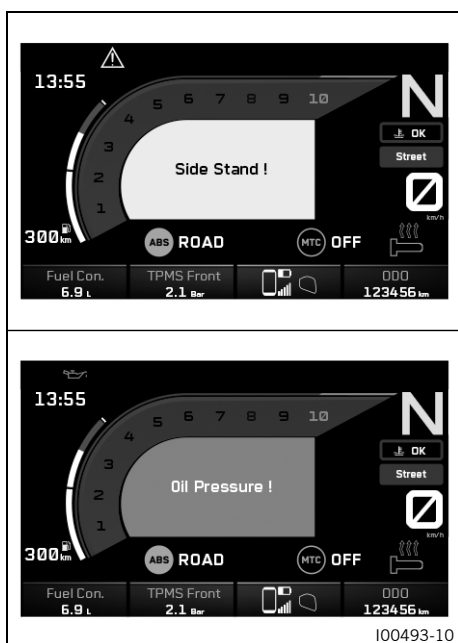

Warnings appear in the middle of the display; these are marked yellow or red depending on their relevance.

Yellow warnings indicate a malfunction or information which requires prompt intervention or an adjustment to the riding style.

Red warnings indicate a malfunction or information which requires immediate intervention.

i Info

Warnings can be hidden by pressing any button.

All the existing warnings are displayed in the **Warning** sub-menu until they are no longer active.

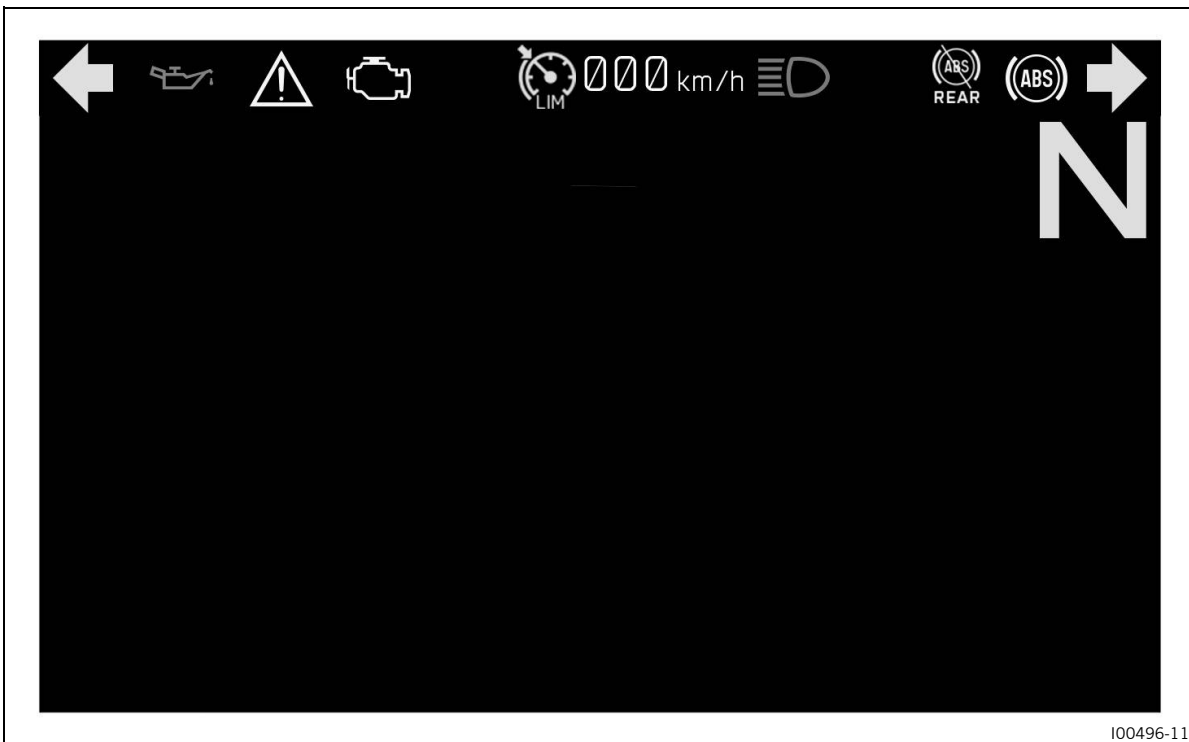

7.4 Indicator lamps





I00496-11

The indicator lamps offer additional information about the operating state of the motorcycle.







i Info

The malfunction indicator lamp  always lights up as long as the engine is not running. If the engine is running and the malfunction indicator lamp  lights up, stop (taking care not to endanger yourself or other road users in the process) and contact an authorized KTM workshop.





The oil pressure warning lamp  always lights up as long as the engine is not running. If the engine is running and the oil pressure warning lamp  lights up, stop immediately (taking care not to endanger yourself or other road users in the process) and switch off the engine.

The ABS warning lamp  lights up until a speed of approx. 6 km/h (approx. 4 mph) or more has been reached.

Possible states

	The turn signal indicator lamp flashes green with a steady rhythmic flash – The turn signal is switched on.
	The malfunction indicator lamp lights up yellow – The OBD has detected a malfunction in the vehicle electronics. Come safely to a halt, and contact an authorized KTM workshop.
	ABS warning lamp lights up yellow – Status or error messages relating to <u>ABS</u> .
	The ABS rear warning lamp lights up yellow – <u>ABS</u> is deactivated on the rear wheel.
	The idle indicator lamp lights up green – The transmission is in neutral.
	The oil pressure warning lamp lights up red – The oil pressure is too low. Stop immediately, taking care not to endanger yourself or other road users in the process, and switch off the engine.

7 COMBINATION INSTRUMENT

	The alarm system indicator lamp lights up or flashes red – Status or error message of the alarm system.
	Speed limiter indicator lamp (optional) lights up yellow – The speed limiter function is switched on, but the speed limiter is not active.
	Speed limiter indicator lamp (optional) lights up green – The speed limiter function is switched on and the speed limiter is active.
	The high beam indicator lamp lights up blue – The high beam is switched on.
	The general warning lamp lights up yellow – A note/warning note on operating safety has been detected. This is also shown in the display.

7.5 Display

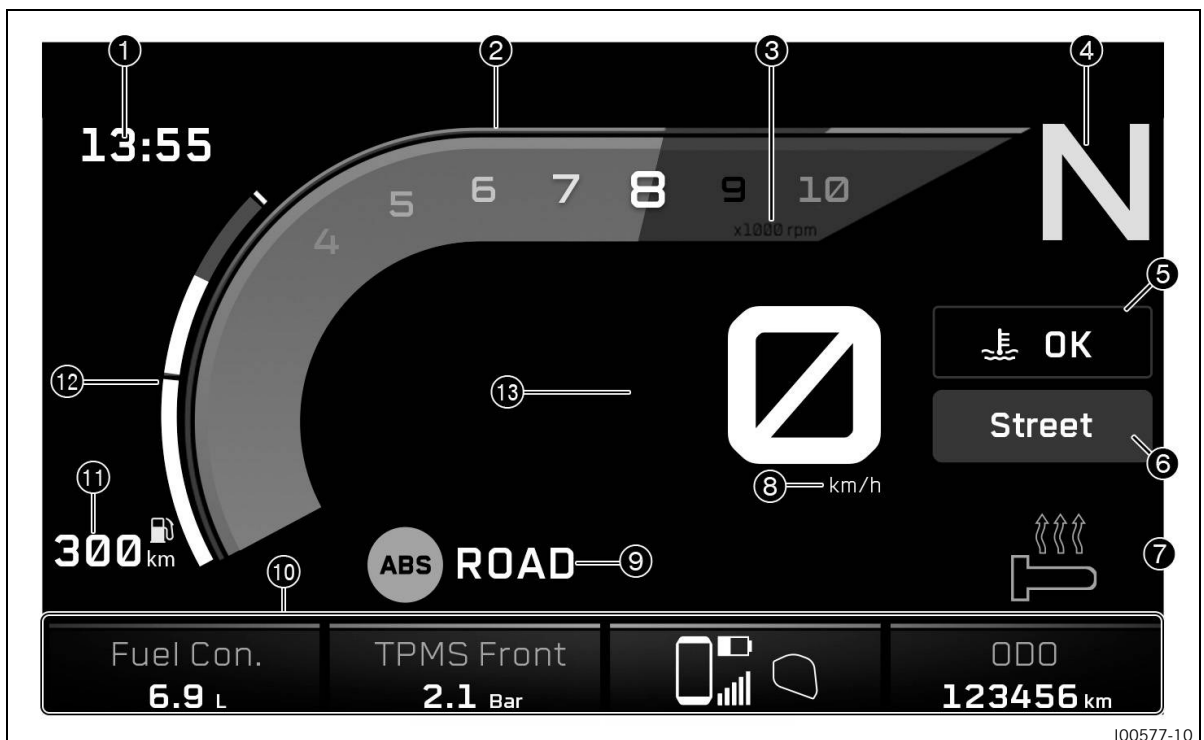

I00577-10

- ❶ Time (📖 p. 27)
- ❷ Engine speed (📖 p. 26)
- ❷ Shift warning light (📖 p. 26)
The shift warning light is integrated in the tachometer display.
- ❸ Unit for the engine speed display
- ❹ Gear display
- ❺ Coolant temperature indicator (📖 p. 28)
- ❻ **Ride-Mode** display (📖 p. 27)
- ❼ Heated grip (optional) (📖 p. 29)
- ❽ Unit for the speedometer
- ❾ **ABS** display (📖 p. 27)
- ❿ **Favorites** display (📖 p. 29)
- ⓫ Fuel range display

- 12 Fuel level display (📖 p. 28)
- 13 Speedometer (📖 p. 26)

7.6 Track display

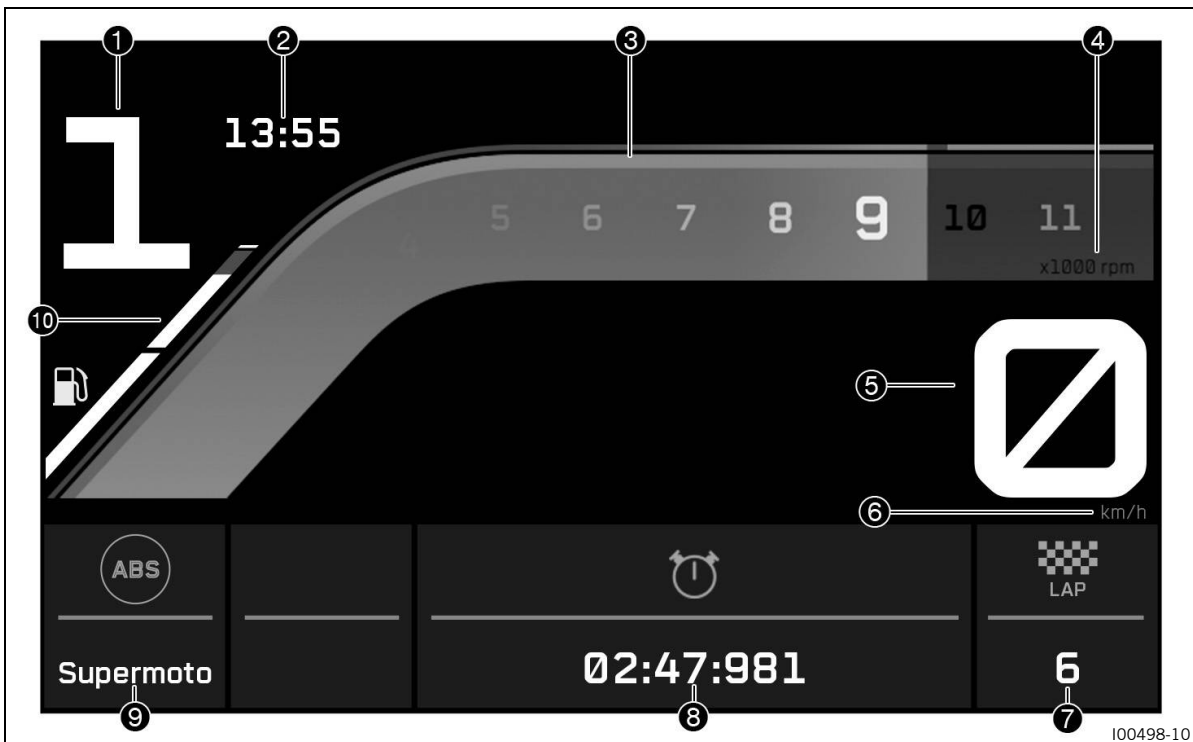

i Info The figure shows the start screen of the combination instrument in active riding mode **Track**. If the menu is open, the speed and the selected gear are still displayed.

- 1 Gear display
- 2 Time (📖 p. 27)
- 3 Engine speed (📖 p. 26)
- 4 Shift warning light (📖 p. 26)
The shift warning light is integrated in the tachometer display.
- 5 Speedometer (📖 p. 26)
- 6 Unit for the speedometer
- 7 Lap indicator
- 8 Lap time
- 9 ABS display (📖 p. 27)
- 10 Fuel level display (📖 p. 28)

7.7 Engine speed

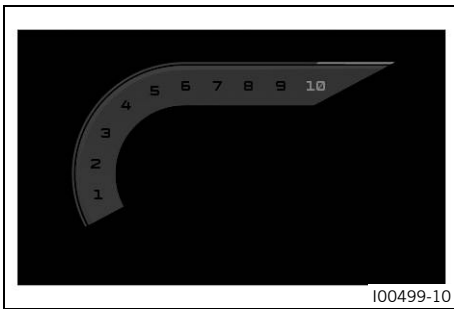

The engine speed is displayed in revolutions per minute.

7.8 Shift warning light

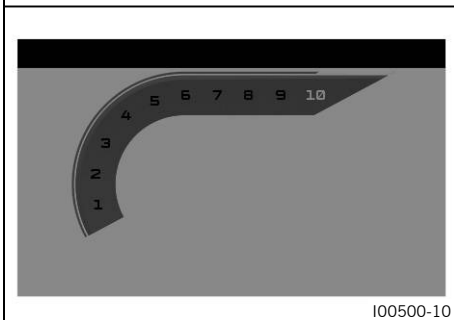
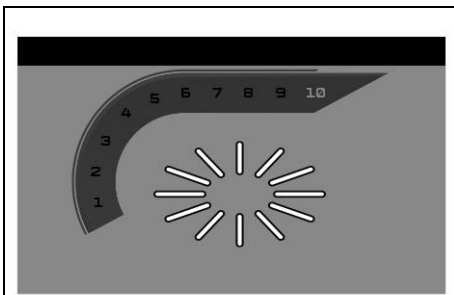

The shift warning light is integrated in the display. In the **Shift Light** submenu, the engine speed for the shift warning light can be set. The shift warning light is always active during the running-in time (up to 1000 km / 621 mi). The shift warning light can only be deactivated, and the values for **RPM1** and **RPM2** can only be adjusted after this. At **RPM1**, the display flashes and at **RPM2**, the entire display is continuously red/orange.

i Info

After the first service, the shift warning light is deactivated when the engine is warm and in sixth-gear.

Coolant temperature	$\leq 35\text{ }^{\circ}\text{C}$ ($\leq 95\text{ }^{\circ}\text{F}$)
ODO	< 1,000 km (< 620 mi)
The shift warning light always flashes at	6,500 rpm
Coolant temperature	$> 35\text{ }^{\circ}\text{C}$ ($> 95\text{ }^{\circ}\text{F}$)
ODO	> 1,000 km (> 620 mi)
RPM1 shift warning light	flashes
RPM2 shift warning light	Lights up continuously

7.9 Speedometer



The speed is shown in area **1** of the display.

Speed is shown in kilometers per hour **km/h** or in miles per hour **mph**.

The unit of speed can be configured in the **Distance** submenu.

7.10 Speed limiter display (optional)

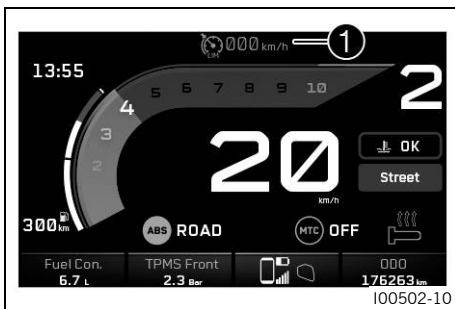

The operating status of the activated speed limiter is shown in display area ①.

The speed limiter is controlled using the combination switch.

i Info

If the speed limiter function is switched on but the speed limiter is not active, the speed limiter indicator lamp lights up yellow.

When the speed limiter function is switched on and the speed limiter is active, the speed limiter indicator lamp lights up green.

7.11 Time

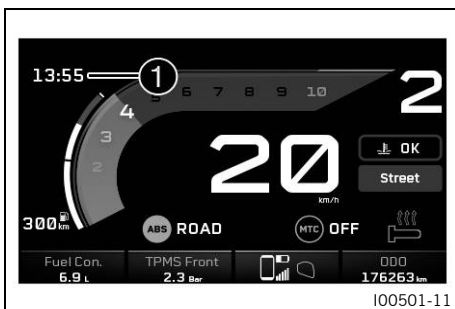

The time is shown in area ① of the display.

The time can be displayed in 24-hour format or 12-hour format in all languages.

The format of the time can be configured in the **Clock Format** menu.

i Info

The time must be reset if the 12-V battery was disconnected from the vehicle or the fuse was removed.

7.12 Ride-Mode display

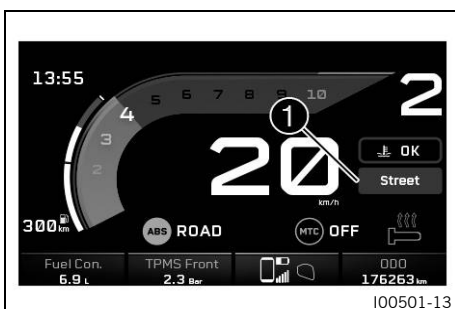

The **Ride Mode** (📖 p. 104) setting is shown in area ① of the display.

The drive mode can be configured in the **Ride Mode** submenu.

7.13 ABS display



The ABS mode setting is shown in the ① area of the display. ABS can be configured separately in the **ABS** submenu.

i Info

When the ABS mode **Road** is active, ABS controls both wheels.

When the **Supermoto** ABS mode is active, ABS only controls the front wheel. The rear wheel is not controlled by ABS and may lock during braking maneuvers.

7.14 Coolant temperature indicator

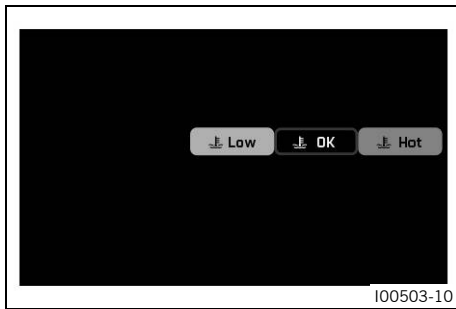

The coolant temperature is displayed by a symbol. The symbol changes between **LOW**, **OK** and **HOT** depending on the temperature.

Note

Engine failure Overheating damages the engine.

- If the coolant temperature warning is displayed, stop immediately and take care not to endanger yourself or other traffic participants in the process.
- Allow the engine and cooling system to cool down.
- Check and, if necessary, correct the coolant level on the cooling system while it is in a cooled state.

i Info

If the coolant temperature indicator shows **HOT**, the indicator also starts to flash.

If the cooling system overheats, the maximum engine speed is limited.

Possible states

- The engine is cold – The coolant temperature indicator shows **LOW**.
- Engine warm – The coolant temperature indicator shows **OK**.
- Engine hot – The coolant temperature indicator shows **HOT**.

7.15 Fuel level display

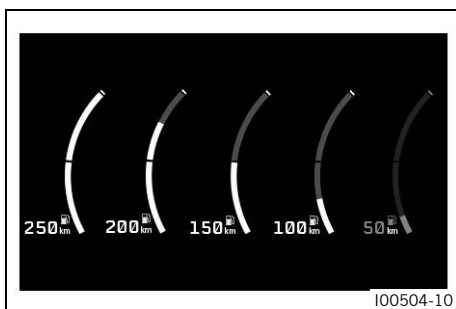

The fuel level display consists of the fuel range display and a bar. The higher the bar is filled, the more fuel is in the fuel tank

i Info

If the fuel level is getting low, the last segment flashes red and the following warning **LOW FUEL** also appears.

The fuel level is displayed with a slight delay to prevent the indicator from constantly moving while riding.

The fuel level display is not updated while the side stand is folded out or the emergency OFF switch is switched off.

Once the side stand is folded up and the emergency OFF switch is switched on, the fuel level display is next updated after 2 minutes.

The fuel level display flashes if the combination instrument does not receive a signal from the fuel level sensor.

7.16 Heated grip (optional)

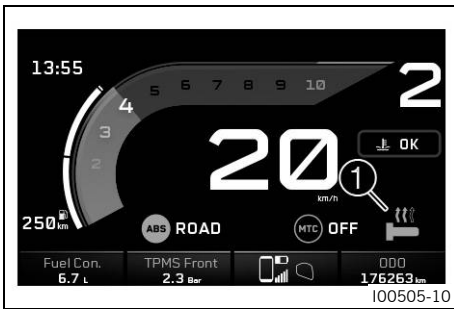

The status of the heated grip is shown in area **1** of the display. The heated grip can be configured in the **Heated Grip** menu.

7.17 Favorites display

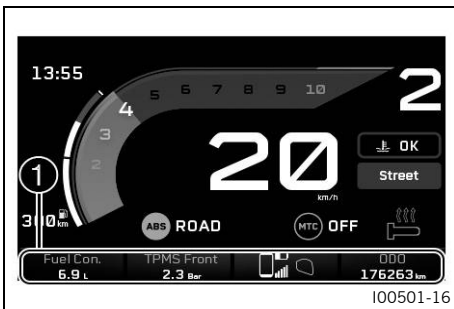

Up to four items of information are displayed in the **Favorites** display **1**. The **Favorites** indicator can be freely configured in the **Favorites** submenu.

7.18 Quick Selector 1 display



When the menu is closed, the **Quick Selector 1** display is opened by pressing the **UP** button. Press the **BACK** button to close the **Quick Selector 1** display.

Info
The **Quick Selector 1** display can be configured in the **Settings** menu under **Quick Selector 1**. Any information can be selected.

7.19 Quick Selector 2 display



When the menu is closed, the **Quick Selector 2** display is opened by pressing the **DOWN** button. Press the **BACK** button to close the **Quick Selector 2** display.

Info
The **Quick Selector 2** display can be configured in the **Settings** menu under **Quick Selector 2**. Any information can be selected.

7.20 Navigation display (optional)

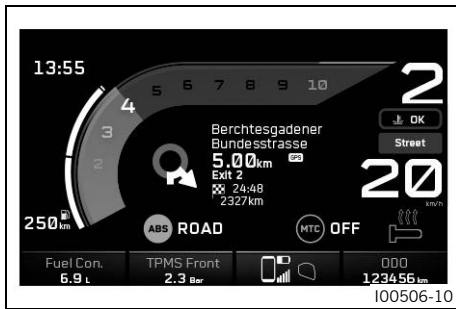

The **Navigation** indicator (optional) appears when the navigation function is activated.

In the **Navigation** display (optional), the direction arrow, the distance from the destination, the estimated arrival time of the cellphone, the distance to the next waypoint, and the street name are displayed.

The **Navigation** display (optional) can be switched on or off in the **Navigation** submenu (optional).

Conditions for use:

- The combination instrument is connected to a suitable phone.
- The **KTMconnect** app (optional) is installed and connected on a suitable cellphone (Android devices Version 7.0 and higher, iOS devices Version 14 and higher).

7.21 Call display

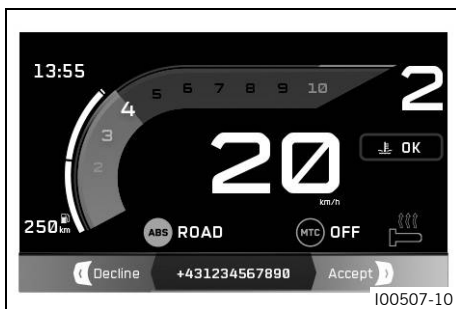

Warning

Danger of accidents Headphone volume which is too high distracts attention from traffic activity.

- Always select headphone volume which is low enough for you to still clearly hear acoustic signals.

The **Call** indicator appears for incoming or active calls.

Press the **SET** button to accept an incoming call.

Press the **BACK** button to reject an incoming call.

Press the **UP** button to increase the audio volume.

Press the **DOWN** button to reduce the audio volume.

Info

It is not possible to change the audio volume using the combination switch with every cellphone.

The call duration and contact are displayed. Depending on the cellphone settings, the contact is shown by name.

You cannot navigate in the menu during an active phone conversation.

Conditions for use:

- The combination instrument is connected to a suitable phone.

7.22 Remote Control Mode (optional) (RCM)

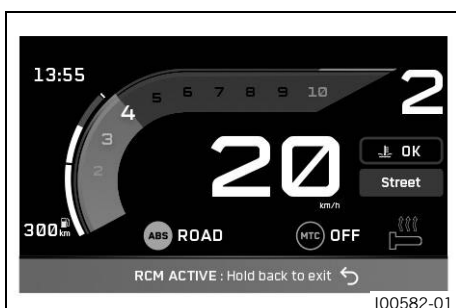

The **Remote Control Mode** indicator (optional) appears when **Remote Control Mode** is activated.

Pressing the **BACK** button for approx. 3 seconds activates the **Remote Control Mode** (optional).

Pressing the **BACK** button for approx. 3 seconds exits the **Remote Control Mode** (optional).

If **Remote Control Mode** is activated (optional), you can navigate using the combination switch in the app on your cellphone.

i Info

In **Remote Control Mode** (optional), you can only navigate within the app.

If **Remote Control Mode** (optional) is active, you cannot navigate in the combination instrument.

Remote Control Mode (optional) cannot be activated when a menu is open.

Conditions for use:

- The combination instrument must be connected to a suitable cellphone.
- The **KTMconnect** app (optional) must be installed, connected, and opened on a suitable cellphone (Android devices Version 7.0 and higher, iOS devices Version 14 and higher).

7.23 Menu

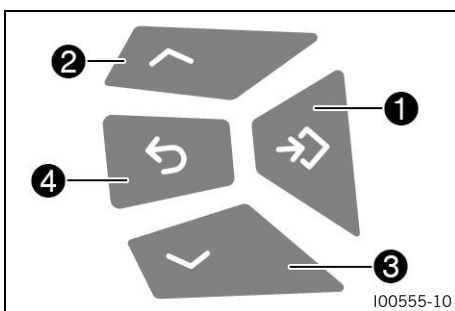

i Info

Press **SET** button **1** in the start screen to open the menu.

Navigate through the menu using the **UP** button **2** or the **DOWN** button **3**.

By pressing the **BACK** button **4**, the menu structure jumps one step back, or the menu is closed.

7.23.1 Lap Timer

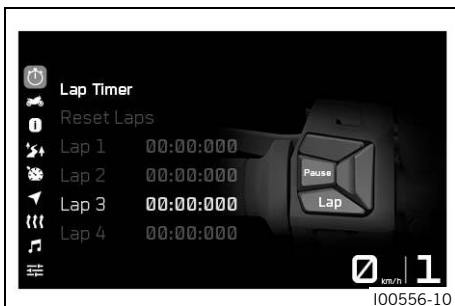

Condition

- Ride mode **Track** activated.
- Press the **SET** button when the menu is closed.
- Press the **UP** or **DOWN** button until **Lap Timer** is highlighted. Press the **SET** button to open the menu.

The timed laps can be displayed in the **Lap Timer** menu.

7.23.2 Alle Runden Löschen

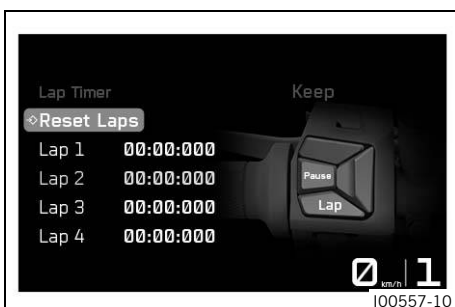

Condition

- Ride mode **Track** activated.
- Press the **SET** button when the menu is closed.
- Press the **UP** or **DOWN** button until **Lap Timer** is highlighted. Press the **SET** button to open the menu.
- Press the **UP** or **DOWN** button until **Reset Laps** is highlighted. Press the **SET** button to delete all saved laps.

7.23.3 Motorcycle

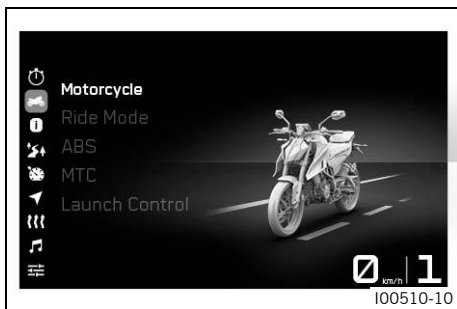

- Press the **SET** button when the menu is closed.
- Press the **UP** or **DOWN** button until **Motorcycle** is highlighted. Press the **SET** button to open the menu.

The riding mode and ABS can be set in **Motorcycle**.

7.23.4 Ride Mode

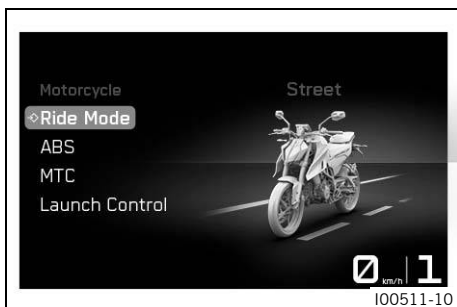

- Press the **SET** button when the menu is closed.
- Press the **UP** or **DOWN** button until **Motorcycle** is highlighted. Press the **SET** button to open the menu.



Warning

Danger of accidents An incorrectly selected riding mode makes control of the vehicle considerably more difficult.

The riding modes are each only suitable for certain conditions.

- Always select a riding mode that suits the surface on which you are riding, the weather and the riding situation.

- Press the **UP** or **DOWN** button until **Ride Mode** is highlighted. Press the **SET** button to open the menu.
- Activate the menu item using the **UP** or **DOWN** button.
- Press **SET** button to select the riding mode, which changes coordinated settings for the engine and motorcycle traction control.
 - ✓ **Street** - Homologated performance with balanced response.
 - ✓ **Rain** - Homologated performance with soft response for better rideability.
 - ✓ **Track** - Setting with homologated performance and balanced response.

The riding mode of the vehicle can be configured in the **Ride Mode** menu.

7.23.5 ABS

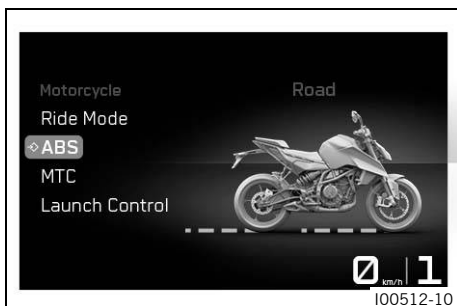

- Press the **SET** button when the menu is closed.
- Press the **UP** or **DOWN** button until **Motorcycle** is highlighted. Press the **SET** button to open the menu.
- Press the **UP** or **DOWN** button until **ABS** is highlighted. Press the **SET** button to open the submenu.
- Activate the menu item using the **UP** or **DOWN** button.



Warning

Danger of accidents An incorrectly selected ABS mode makes control of the vehicle considerably more difficult.

The ABS modes are each only suitable for certain conditions.

- Always select an ABS mode that is compatible with the surface of the ground.

- Press the **SET** button to select the desired ABS mode.



Info

The ABS mode can be switched during the journey. Do not open the throttle during the selection.

When the ABS mode **Road** is active, ABS controls both wheels.

When the **Supermoto** ABS mode is active, ABS only controls the front wheel. The rear wheel is no longer controlled by ABS and may lock during braking maneuvers. The indicator lamp **ABS REAR** lights up.

7.23.6 Bike Info



- Press the **SET** button when the menu is closed.
- Press the **UP** or **DOWN** button until **Bike Info** is highlighted. Press the **SET** button to open the menu.

General information and warnings that may be present can be called up in **Bike Info**.

7.23.7 Bike Info



- Press the **SET** button when the menu is closed.
- Press the **UP** or **DOWN** button until **Bike Info** is highlighted. Press **SET** button to open the menu.

Water displays the coolant temperature.

Fuel Range displays the possible distance you can cover with the fuel reserve.

Battery displays the battery voltage.

Odometer displays the total distance covered.

Service displays when the next service is due.

Warnings displays warnings that have occurred until they are no longer active.

7.23.8 Warning



Condition

- Message or warning is present.
- Press the **SET** button when the menu is closed.
- Press the **UP** or **DOWN** button until **Bike Info** is highlighted. Press the **SET** button to open the menu.
- Press the **UP** or **DOWN** button until **Warning** is highlighted. Press the **SET** button to open the submenu.
- Use the **UP** or **DOWN** button to navigate through the warnings.



Info

The warnings that have occurred are saved in the display until they are no longer active.

7.23.9 Trip Info

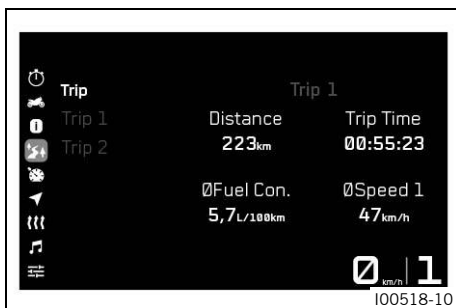

- Press the **SET** button when the menu is closed.
- Press the **UP** or **DOWN** button until **Trip** is highlighted. Press the **SET** button to open the menu.

General information on the odometer, riding time, average fuel consumption, and average speed can be accessed in the menu **Trip**.

7.23.10 Trip 1

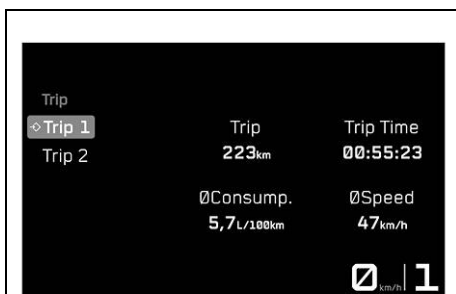

- Press the **SET** button when the menu is closed.
- Press the **UP** or **DOWN** button until **Trip** is highlighted. Press **SET** button to open the menu.
- Press the **UP** or **DOWN** button until **Trip 1** is highlighted. Press the **SET** button to open the submenu.

Information on **Trip 1** can be viewed in the **Trip 1** submenu.



Info

Trip displays the distance since the last reset, e.g. between two refueling stops. **Trip** is running and counts up to **9999**.

Trip Time shows the riding time on the basis of **Trip** and runs as soon as a speed signal is received.

ØConsump. indicates the average fuel consumption based on **Trip**.

ØSpeed indicates the average speed based on **Trip** and **Trip Time**.

Press **Reset Trip** to reset all entries in the **Trip 1** menu.

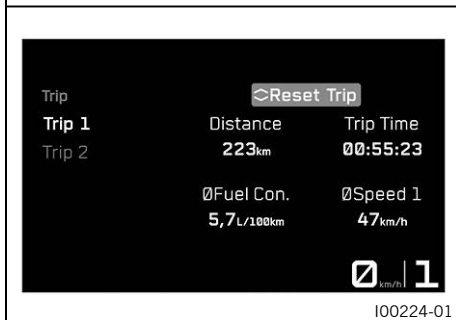

7.23.11 Trip 2

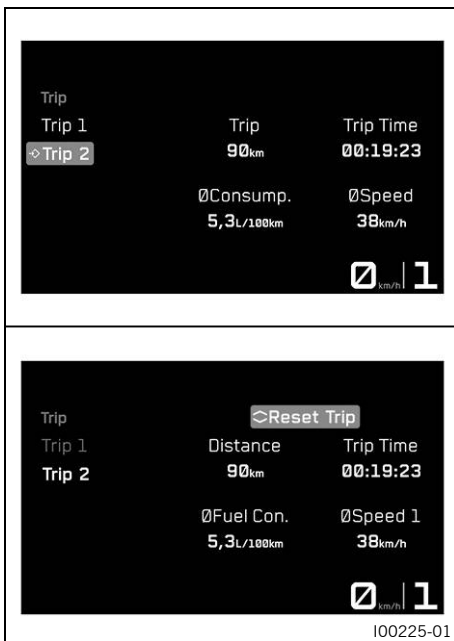

- Press the **SET** button when the menu is closed.
- Press the **UP** or **DOWN** button until **Trip** is highlighted. Press **SET** button to open the menu.
- Press the **UP** or **DOWN** button until **Trip 2** is highlighted. Press the **SET** button to open the submenu.

Information on **Trip 2** can be viewed in the **Trip 2** submenu.

- i Info**
- Trip** displays the distance since the last reset, e.g. between two refueling stops. **Trip** is running and counts up to **9999**. **Trip Time** shows the riding time on the basis of **Trip** and runs as soon as a speed signal is received.
 - ØConsump.** indicates the average fuel consumption based on **Trip**.
 - ØSpeed** indicates the average speed based on **Trip** and **Trip Time**.
- Press **Reset Trip** to reset all entries in the **Trip 2** menu.

7.23.12 Geschwindigkeitsbegrenzer (optional)

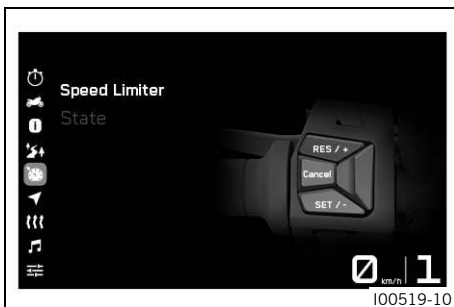

- Press the **SET** button when the menu is closed.
 - Press the **UP** or **DOWN** button until **Geschwindigkeitsbegrenzer** (optional) is marked. Press the **SET** button to open the menu.
- Geschwindigkeitsbegrenzer** (optional) can be activated and deactivated in the **Geschwindigkeitsbegrenzer** menu (optional).

7.23.13 Geschwindigkeitsbegrenzer State (optional)



- Press the **SET** button when the menu is closed.
- Press the **UP** or **DOWN** button until **Geschwindigkeitsbegrenzer** (optional) is marked. Press the **SET** button to open the menu.
- Press the **UP** or **DOWN** button until **State** is highlighted. Press the **SET** button to open the menu.
- Activate the menu item using the **UP** or **DOWN** button.
- Switch the **Geschwindigkeitsbegrenzer** on or off by pressing the **SET** button (optional).

7.23.14 Navigation (optional)

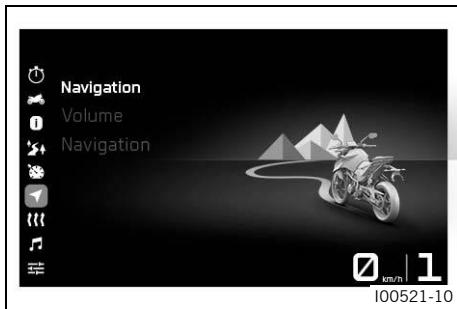

Condition

- **Bluetooth®** function is activated.
- The **KTMconnect** app (optional) is installed and connected on a suitable cellphone (Android devices Version 7.0 and higher, iOS devices Version 14 and higher).
- The combination instrument is connected to a suitable phone.
- The GPS function is activated on the connected phone.
- For voice navigation: The combination instrument is connected to a suitable headset and an appropriate language package has been downloaded in the **KTMconnect Navigation** app (optional).
 - Press the **SET** button when the menu is closed.
 - Press **UP** or **DOWN** button until **Navigation** is highlighted. Press the **SET** button to open the submenu.

7.23.15 Volume (optional)



Condition

- The **KTMconnect** app (optional) is installed and connected on a suitable cellphone (Android devices Version 7.0 and higher, iOS devices Version 14 and higher).
- The combination instrument is connected to a suitable phone.
- For voice navigation: The combination instrument is connected to a suitable headset and an appropriate language package has been downloaded in the **KTMconnect** app (optional).
 - Press the **SET** button when the menu is closed.
 - Press **UP** or **DOWN** button until **Navigation** is highlighted. Press the **SET** button to open the submenu.



Warning

Danger of accidents Headphone volume which is too high distracts attention from traffic activity.

- Always select headphone volume which is low enough for you to still clearly hear acoustic signals.

- Press **UP** or **DOWN** button until **Volume** is highlighted. Press the **SET** button to open the submenu.
- Press the **UP** button to increase the volume of the activated voice navigation.
- Press the **DOWN** button to reduce the volume of the activated voice navigation.

7.23.16 State (optional)

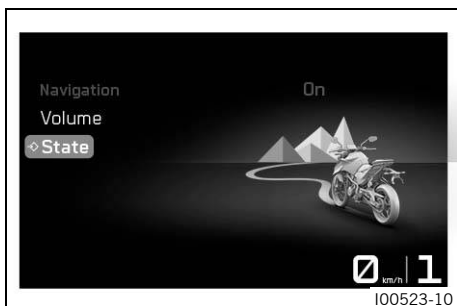

Condition

- **Bluetooth®** function is activated.
- The **KTMconnect** app (optional) is installed and opened on a suitable cellphone (Android devices Version 7.0 and higher, iOS devices Version 14 and higher).
- The combination instrument is connected to a suitable phone.
 - Press the **SET** button when the menu is closed.
 - Press **UP** or **DOWN** button until **Navigation** is highlighted. Press the **SET** button to open the submenu.

- Press **UP** or **DOWN** button until **State** is highlighted. Press the **SET** button to confirm the selection.
- Press the **SET** button to switch the visual navigation on or off.

i Info

Voice navigation remains switched on if it has been activated.

The volume of the activated voice navigation is identical to the volume of the audio player on the cellphone. If the volume on the cellphone is changed, the volume of the activated voice navigation also changes.

7.23.17 Heating (optional)

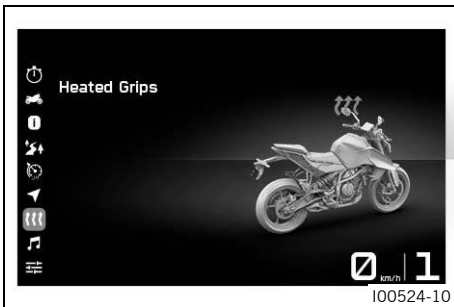

- Press the **SET** button when the menu is closed.
- Press the **UP** or **DOWN** button until **Heating** (optional) is marked. Press the **SET** button to open the menu.

Heated Grip (optional) can be activated and deactivated in the **Heating** menu (optional).

7.23.18 Heated Grips (function optional)

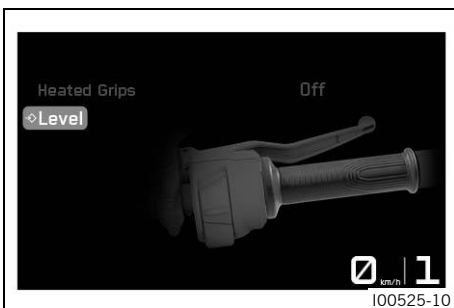

Condition

- Model with heated grip.
- The motorcycle is stationary.
- Press the **SET** button when the menu is closed.
- Press the **UP** or **DOWN** button until **Settings** is highlighted. Press **SET** button to open the menu.
- Press the **UP** or **DOWN** button until **Heating** is highlighted. Press the **SET** button to open the submenu.
- Press **UP** or **DOWN** button until **Heated Grips** is highlighted. Press the **SET** button to open the submenu.
- Activate the menu item using the **UP** or **DOWN** button.
- Press the **SET** button to switch the heated grip on or off.

7.23.19 Audio



Condition

- **Bluetooth®** function is activated.
- The combination instrument is connected to a suitable phone.
- The combination instrument is connected to a suitable headset or the **Headset Type Coded** is selected.
- Press the **SET** button when the menu is closed.



Warning

Danger of accidents Headphone volume which is too high distracts attention from traffic activity.

- Always select headphone volume which is low enough for you to still clearly hear acoustic signals.

- Press the **UP** or **DOWN** button until **Audio** is highlighted. Press the **SET** button to open the submenu.
- Press and hold **UP** button to increase the audio volume.
- Press and hold **DOWN** button to reduce the audio volume.
- Press **UP** button briefly to change to the next audio track.
- Briefly pressing **DOWN** button twice changes to the previous audio title or plays the current audio title from the start, depending on the cellphone model.
- Press **SET** button to play or pause the audio track.



Info

With some cellphones, the audio player needs to be started before playback is possible. The audio function can be added to **Quick Selector 1** or **Quick Selector 2** for easier operation.

7.23.20 Settings

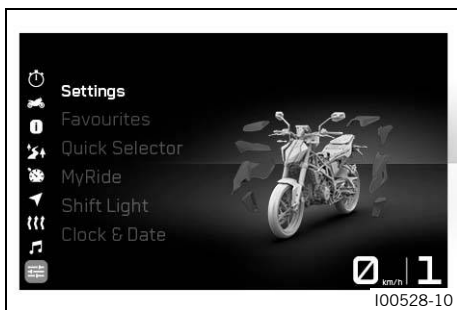

Condition

- The motorcycle is stationary.
- Press the **SET** button when the menu is closed.
- Press the **UP** or **DOWN** button until **Settings** is highlighted. Press the **SET** button to open the menu.

In the **Settings** menu, favorites, quick selections, **Connectivity** (optional), and the shift warning light can be configured. Settings can be made for units or various values. Several functions can be enabled or disabled.

7.23.21 Favorites

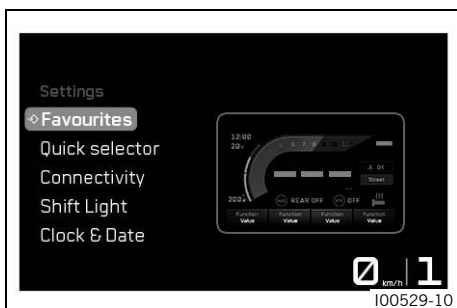

Condition

- The motorcycle is stationary.
- Press the **SET** button when the menu is closed.
- Press the **UP** or **DOWN** button until **Settings** is highlighted. Press the **SET** button to open the menu.
- Press the **UP** or **DOWN** button until “Favorites” is highlighted. Press the **SET** button to open the submenu.
- Access menu item with the **UP** or **DOWN** button, and add the selected information to the Favorites display using the **SET** button.

Up to four sets of information can be selected in the **Favorites** menu.

7.23.22 Favorites-Anzeige 1-4

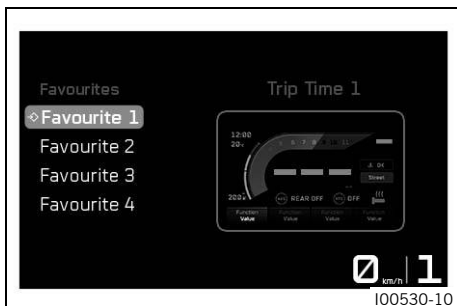

Condition

- The motorcycle is stationary.
- Press the **SET** button when the menu is closed.
- Press the **UP** or **DOWN** button until **Settings** is highlighted. Press the **SET** button to open the menu.
- Press the **UP** or **DOWN** button until **Favorites** is highlighted. Press the **SET** button to open the menu.

- Press the **UP** or **DOWN** button to select **Favorite 1**, **Favorite 2**, **Favorite 3**, or **Favorite 4**. Press **SET** button to open the menu.
- Press the **UP** or **DOWN** button to select the desired information. Press the **SET** button to confirm the selection.

7.23.23 Quick Selector 1



Condition

- The motorcycle is stationary.
- Press the **SET** button when the menu is closed.
- Press the **UP** or **DOWN** button until **Settings** is highlighted.
- Press the **SET** button to open the menu.
- Press the **UP** or **DOWN** button until **Quick Selector 1** is highlighted. Press **SET** button to open the menu.
- Activate the menu item using the **UP** or **DOWN** button.
- Press the **SET** button to set a direct selection submenu for **Quick Selector 1**.



Info

When the menu is closed, the submenu defined in **Quick Selector 1** is opened by pressing the **UP** button.

7.23.24 Quick Selector 2

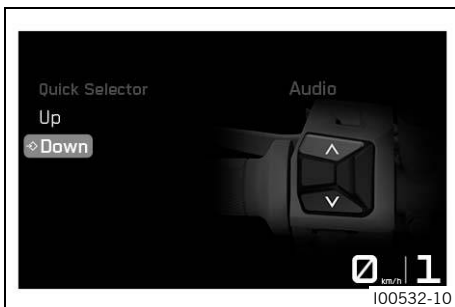

Condition

- The motorcycle is stationary.
- Press the **SET** button when the menu is closed.
- Press the **UP** or **DOWN** button until **Settings** is highlighted.
- Press the **SET** button to open the menu.
- Press the **UP** or **DOWN** button until **Quick Selector 2** is highlighted. Press **SET** button to open the menu.
- Activate the menu item using the **UP** or **DOWN** button.
- Press the **SET** button to set a direct selection submenu for **Quick Selector 2**.



Info

When the menu is closed, the submenu defined in **Quick Selector 2** is opened by pressing the **DOWN** button.

7.23.25 Konnektivität

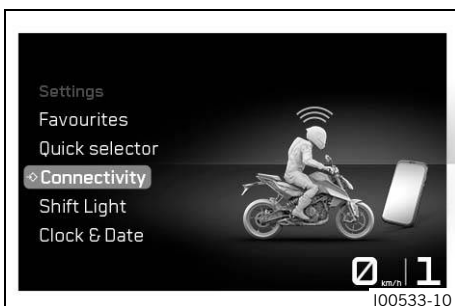

Condition

- The motorcycle is stationary.
- **Bluetooth®** function is activated.
- Press the **SET** button when the menu is closed.
- Press the **UP** or **DOWN** button until **Connectivity** is highlighted. Press the **SET** button to open the menu.

In the **Connectivity** menu, a suitable cellphone or headset can be paired with the combination instrument via **Bluetooth®** and the audio function and navigation function can be configured.

i Info

Not every cellphone or headset is suitable for pairing with the combination instrument.
The standard **Bluetooth®** 4.0 must be supported.

7.23.26 Bluetooth

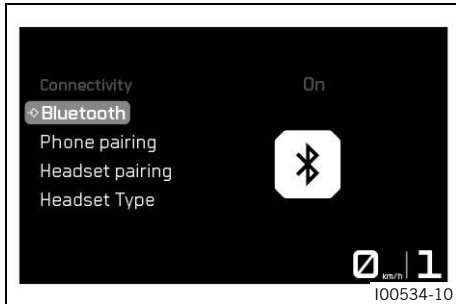

Condition

- The motorcycle is stationary.
- Press the **SET** button when the menu is closed.
- Press the **UP** or **DOWN** button until **Settings** is highlighted.
- Press the **SET** button to open the menu.
- Press the **UP** or **DOWN** button until **Connectivity** is highlighted. Press the **SET** button to open the menu.
- Press the **UP** or **DOWN** button until **Bluetooth** is highlighted. Press the **SET** button to open the submenu.
- Activate the menu item using the **UP** or **DOWN** button.
- Press the **SET** button to switch the **Bluetooth®** function on or off.

i Info

The **Bluetooth®** function must be activated to pair a suitable phone or headset with the vehicle.
Not every phone and headset is suitable for pairing with the vehicle.

7.23.27 Pairing a cellphone

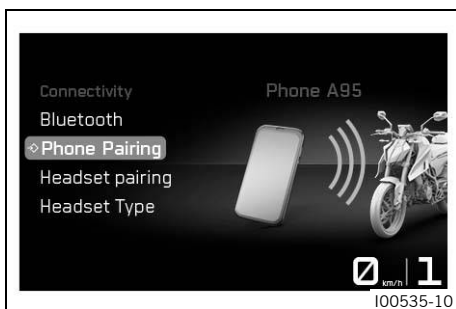

Condition

- The motorcycle is stationary.
- **Bluetooth®** function is activated.
- The **Bluetooth®** function should also be activated in the device to be paired.
- Press the **SET** button when the menu is closed.
- Press the **UP** or **DOWN** button until **Settings** is highlighted. Press **SET** button to open the menu.
- Press the **UP** or **DOWN** button until **Connectivity** is highlighted. Press the **SET** button to open the menu.
- Press the **UP** or **DOWN** button until "Pair phone" is highlighted. Press the **SET** button to open the submenu.

i Info

Only one cellphone can be paired with the vehicle.

- Press the **UP** or **DOWN** button until **New Pairing** is marked. Press the **SET** button to open the menu.
- The vehicle starts searching for a suitable cellphone. If the search was successful, the name of the cell phone is displayed again in the Pairing menu. Press the **SET** button to start the pairing.

**Info**

The cellphone must be visible via **Bluetooth®** for the vehicle to find the cellphone.
Not every cellphone is suitable for pairing with the vehicle.

- A message appears on the combination instrument indicating that the vehicle is now ready for pairing. The pairing is completed successfully by confirming the **Passkey** on the cellphone and on the combination instrument.

**Info**

Follow the instructions in the app when connecting with **KTMconnect**. Confirmation may be required on the combination instrument.

- Press the **UP** or **DOWN** button until "Delete pairing" is highlighted. The paired device can be deleted by pressing the **SET** button.
- Move the previously paired device into the range of the vehicle while the **Bluetooth®** function is active.
 - ✓ The device is automatically connected with the vehicle.
 - ✗ If the device is not automatically connected with the vehicle after approx. 30 seconds:
 - Switch on the vehicle again or repeat the **New Pairing** procedure.

A suitable cellphone can be paired with the combination instrument in the **Phone Pairing** submenu via **Bluetooth®**.

**Info**

Not every cellphone or headset is suitable for pairing with the combination instrument.

Make sure that the end device is in the correct pairing mode for call management. If the end device is only paired for media playback, the call function may not work.

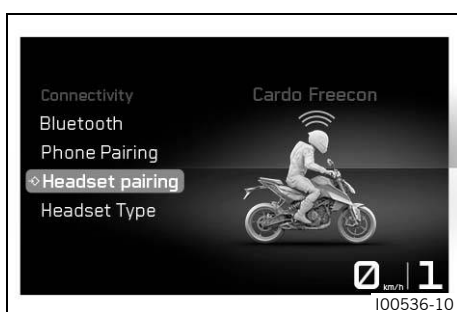
7.23.28 Pairing a headset**Condition**

- The motorcycle is stationary.
- **Bluetooth®** function is activated.
- The **Bluetooth®** function should also be activated in the device to be paired.
- Press the **SET** button when the menu is closed.
- Press the **UP** or **DOWN** button until **Settings** is highlighted. Press **SET** button to open the menu.
- Press the **UP** or **DOWN** button until **Connectivity** is highlighted. Press the **SET** button to open the menu.
- Press the **UP** or **DOWN** button until **Riders Headset** is highlighted. Press the **SET** button to open the menu.
- Press the **UP** or **DOWN** button until **New Pairing** is marked. Press the **SET** button to open the menu.
- The vehicle starts searching for a suitable headset. If the search was successful, the name of the rider's headset is displayed in the **New Pairing** submenu. Press the **SET** button to start the pairing.

i Info

The headset must be in pairing mode for the vehicle to find the headset. Follow the instructions in the headset owner's manual.

Press the **UP** or **DOWN** button until **Delete Pairing** is highlighted. The paired device can be deleted by pressing the **SET** button.

Not every headset is suitable for pairing with the vehicle.

- Move the previously paired device into the range of the vehicle while the **Bluetooth®** function is active.
- ✓ The device is automatically connected with the vehicle.
- ✗ If the device is not automatically connected with the vehicle after approx. 30 seconds:
 - Switch on the vehicle again or repeat the **New Pairing** procedure.

In the **Riders Headset** menu, a suitable rider headset can be paired with the vehicle.

7.23.29 Headset Type

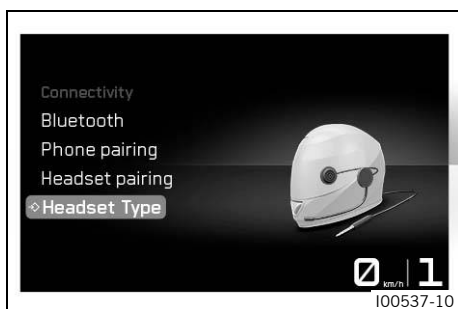

Condition

- The motorcycle is stationary.
- Press the **SET** button when the menu is closed.
- Press the **UP** or **DOWN** button until **Settings** is highlighted. Press **SET** button to open the menu.
- Press the **UP** or **DOWN** button until **Connectivity** is highlighted. Press the **SET** button to open the menu.
- Press the **UP** or **DOWN** button until **Headset Type** is highlighted.
- Activate the menu item using the **UP** or **DOWN** button.
- Press the **SET** button to change the rider headset type.

The connection mode for the rider headset can be selected in the **Headset Type** menu.

The headset is connected to the vehicle wirelessly via **Bluetooth®** in **Bluetooth Headset** mode.

The headset is connected directly to the smartphone in **Corded Headset** mode.

i Info

The **Riders Headset** menu item is only available in **Headset Type Bluetooth**.

7.23.30 QUICKSHIFTER+ (optional)

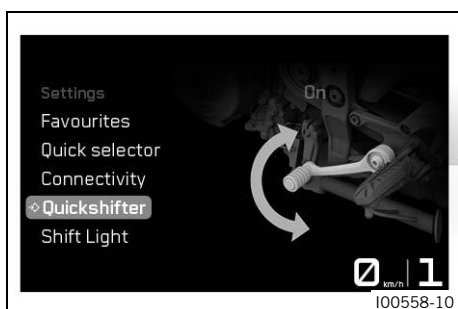

- Press the **SET** button when the menu is closed.
- Press the **UP** or **DOWN** button until **Settings** is highlighted. Press the **SET** button to open the menu.
- Press the **UP** or **DOWN** button until **QUICKSHIFTER+** (optional) is marked. Press the **SET** button to open the menu.
- Press **UP** or **DOWN** button to activate or deactivate **QUICKSHIFTER+** (optional).

7.23.31 Shift Light

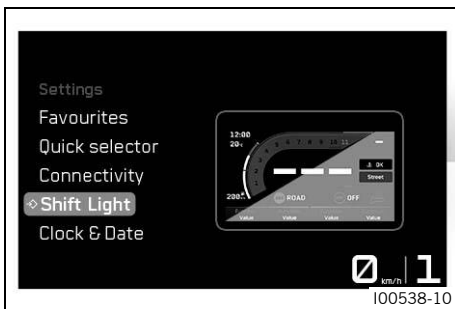

Condition

- The motorcycle is stationary.
- **ODO** > 1,000 km (621 mi).
- Press the **SET** button when the menu is closed.
- Press the **UP** or **DOWN** button until **Settings** is highlighted. Press **SET** button to open the menu.
- Press the **UP** or **DOWN** button until **Shift Light** is highlighted. Press the **SET** button to open the submenu.

The shift warning light can be configured in the **Shift Light** submenu.

7.23.32 Shift Light State

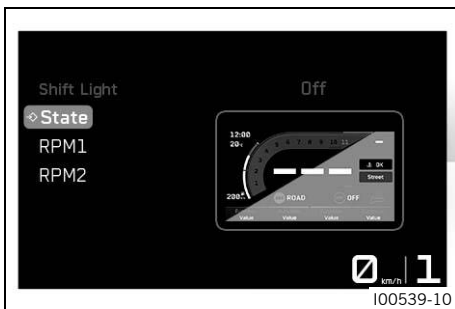

Condition

- The motorcycle is stationary.
- **ODO** > 1,000 km (621 mi).
- Press the **SET** button when the menu is closed.
- Press the **UP** or **DOWN** button until **Settings** is highlighted. Press **SET** button to open the menu.
- Press the **UP** or **DOWN** button until **Shift Light** is highlighted. Press the **SET** button to open the submenu.
- Activate the menu item using the **UP** or **DOWN** button.
- Press the **SET** button to switch the shift warning light on or off.

7.23.33 RPM1

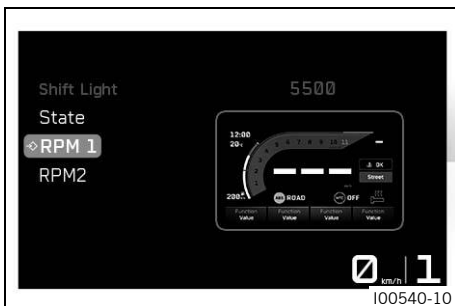

Condition

- The motorcycle is stationary.
- **ODO** > 1,000 km (621 mi).
- Press the **SET** button when the menu is closed.
- Press the **UP** or **DOWN** button until **Settings** is highlighted. Press **SET** button to open the menu.
- Press the **UP** or **DOWN** button until **Shift Light** is highlighted. Press the **SET** button to open the submenu.
- Press the **UP** or **DOWN** button until **RPM1** is highlighted. Press the **SET** button to open the submenu.
- Activate the menu item using the **UP** or **DOWN** button.
- Set the value for **SET** by pressing the **RPM1** button.



Info

RPM1 can be set in intervals of 500 between 5,500 and 10,000 rpm.

RPM1 must not be larger than **RPM2**.

If the engine speed reaches the set value **RPM1**, the shift warning light flashes.

7.23.34 RPM2



Condition

- The motorcycle is stationary.
- **ODO** > 1,000 km (621 mi).
- Press the **SET** button when the menu is closed.
- Press the **UP** or **DOWN** button until **Settings** is highlighted. Press **SET** button to open the menu.
- Press the **UP** or **DOWN** button until **Shift Light** is highlighted. Press the **SET** button to open the submenu.
- Press the **UP** or **DOWN** button until **RPM2** is highlighted. Press the **SET** button to open the submenu.
- Activate the menu item using the **UP** or **DOWN** button.
- Set the value for **SET** by pressing the **RPM2** button.



Info

RPM2 can be set in intervals of 500 between 7,000 and 10,000 rpm.

RPM2 must not be smaller than **RPM1**.

If the engine speed reaches the set value **RPM2**, the shift warning light flashes and the color changes.

7.23.35 Setting the time and date

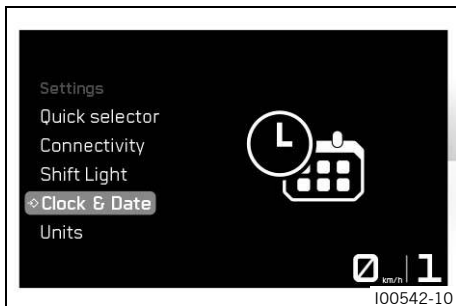

Condition

The motorcycle is stationary.

- Press the **SET** button when the menu is closed.
- Press **UP** or **DOWN** button until **Settings** appears. Press the **SET** button to open the menu.
- Press the **UP** or **DOWN** button until **Clock & Date** is highlighted. Press the **SET** button to open the submenu.

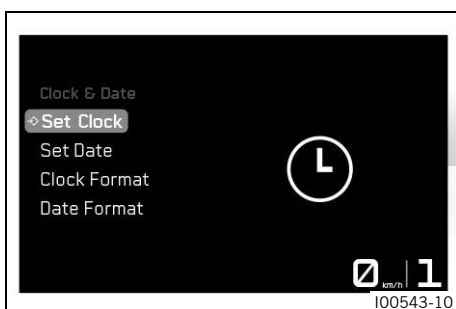

Setting the clock

- Press **UP** or **DOWN** button until **Set Clock** is highlighted.
- Press the **SET** button to open the menu.
- Press the **UP** or **DOWN** button until the current hour is set. Press the **SET** button to select the hour.
- Press the **UP** or **DOWN** button until the current minute is set. Press the **SET** button to select the minute.
- Press the **BACK** button to exit the menu.

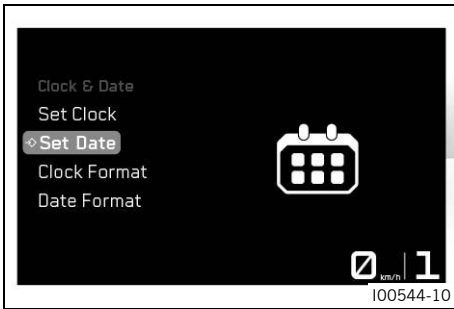

Setting the date

- Press **UP** or **DOWN** button until **Set Date** is highlighted.
- Press the **SET** button to open the menu.
- Press the **UP** or **DOWN** button until the current day is set. Press the **SET** button to select the day.
- Press the **UP** or **DOWN** button until the current month is set. Press the **SET** button to select the month.
- Press the **UP** or **DOWN** button until the current year is set. Press the **SET** button to select the year.
- Press the **BACK** button to exit the menu.



7.23.36 Clock Format

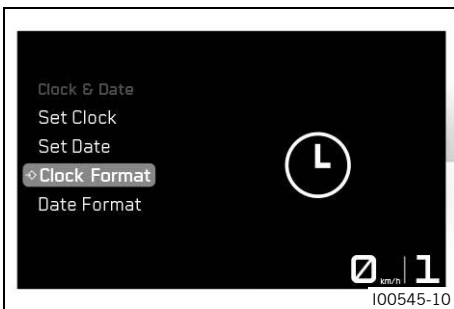

Condition

- The motorcycle is stationary.
- Press the **SET** button when the menu is closed.
- Press the **UP** or **DOWN** button until **Settings** is highlighted. Press **SET** button to open the menu.
- Press the **UP** or **DOWN** button until **Clock & Date** is highlighted. Press the **SET** button to open the submenu.
- Press the **UP** or **DOWN** button until **Clock Format** is highlighted. Press the **SET** button to open the menu.
- Activate the menu item using the **UP** or **DOWN** button.
- Press the **SET** button to select the time format.



Info

The possible settings are 24h and 12h.

7.23.37 Date Format

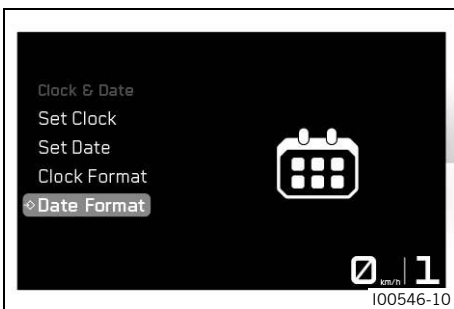

Condition

- The motorcycle is stationary.
- Press the **SET** button when the menu is closed.
- Press the **UP** or **DOWN** button until **Settings** is highlighted. Press **SET** button to open the menu.
- Press the **UP** or **DOWN** button until **Clock & Date** is highlighted. Press the **SET** button to open the submenu.
- Press the **UP** or **DOWN** button until **Date Format** is highlighted. Press the **SET** button to open the menu.
- Activate the menu item using the **UP** or **DOWN** button.
- Press the **SET** button to select the date format.



Info

The setting options are DD.MM.YYYY, MM.DD.YYYY and YYYY.MM.DD.

7.23.38 Units

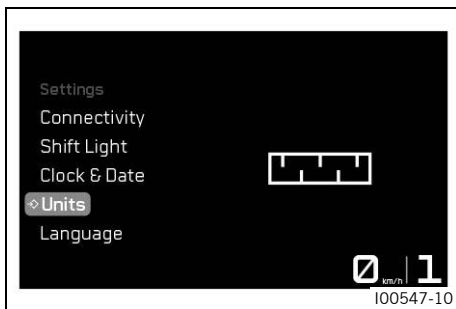

Condition

- The motorcycle is stationary.
- Press the **SET** button when the menu is closed.
- Press the **UP** or **DOWN** button until **Settings** is highlighted. Press **SET** button to open the menu.
- Press the **UP** or **DOWN** button until **Units** is highlighted. Press the **SET** button to open the submenu.

The **Units** submenu allows settings to be made for units or various values.

7.23.39 Distance

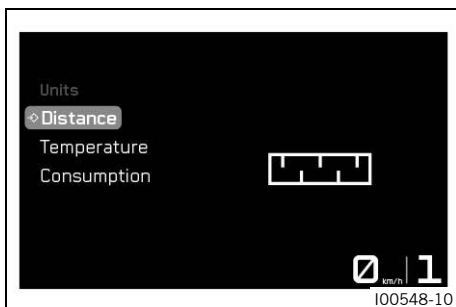

Condition

- The motorcycle is stationary.
- Press the **SET** button when the menu is closed.
- Press the **UP** or **DOWN** button until **Settings** is highlighted. Press **SET** button to open the menu.
- Press the **UP** or **DOWN** button until **Units** is highlighted. Press the **SET** button to open the submenu.
- Press **UP** or **DOWN** button until **Distance** is highlighted. Press the **SET** button to open the submenu.
- Activate the menu item using the **UP** or **DOWN** button.
- Press the **SET** button to confirm the desired unit.



Info

The setting options are kilometers or miles.

7.23.40 Temperature

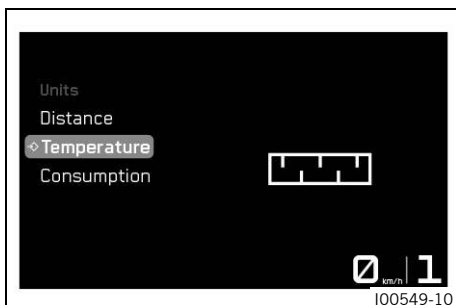

Condition

- The motorcycle is stationary.
- Press the **SET** button when the menu is closed.
- Press the **UP** or **DOWN** button until **Settings** is highlighted. Press **SET** button to open the menu.
- Press the **UP** or **DOWN** button until **Units** is highlighted. Press the **SET** button to open the submenu.
- Press **UP** or **DOWN** button until **Temperature** is highlighted. Press the **SET** button to open the submenu.
- Activate the menu item using the **UP** or **DOWN** button.
- Press the **SET** button to confirm the desired unit.



Info

The setting options are Celsius or Fahrenheit.

7.23.41 Consumption

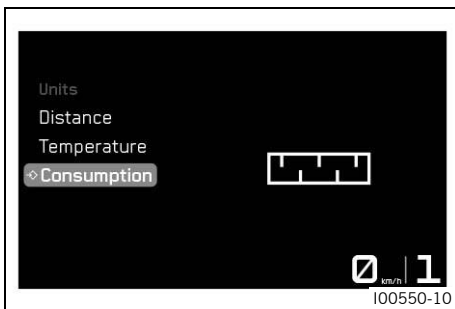

Condition

- The motorcycle is stationary.
- Press the **SET** button when the menu is closed.
- Press the **UP** or **DOWN** button until **Settings** is highlighted. Press **SET** button to open the menu.
- Press the **UP** or **DOWN** button until **Units** is highlighted. Press the **SET** button to open the submenu.
- Press **UP** or **DOWN** button until **Consumption** is highlighted. Press the **SET** button to open the submenu.
- Activate the menu item using the **UP** or **DOWN** button.
- Press the **SET** button to confirm the desired unit.



Info

The setting options are l/100km, km/l, USG/100mi, mi/USG, malfunction indicator lamp, UKG/100mi and mi/UKG.

7.23.42 Language

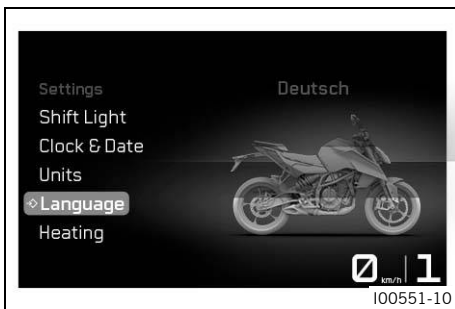

Condition

- The motorcycle is stationary.
- Press the **SET** button when the menu is closed.
- Press the **UP** or **DOWN** button until **Settings** is highlighted.
- Press the **SET** button to open the menu.
- Press the **UP** or **DOWN** button until **Language** is highlighted. Press the **SET** button to open the submenu.
- Activate the menu item using the **UP** or **DOWN** button.
- Press the **SET** button to confirm the desired language.



Info

The menu languages are US English, UK English, German, Italian, French, and Spanish.

7.23.43 Heating (function optional)

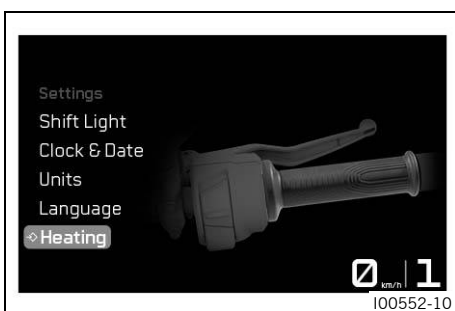

Condition

- The motorcycle is stationary.
- Press the **SET** button when the menu is closed.
- Press the **UP** or **DOWN** button until **Settings** is highlighted. Press **SET** button to open the menu.
- Press the **UP** or **DOWN** button until **Heating** is highlighted. Press the **SET** button to open the submenu.

The heated grip can be configured in the **Heating** submenu.



Info

In the **Settings** menu, the **Heating** submenu only controls the visibility of **Heated Grips** in the menu.

7.23.44 Extra Functions

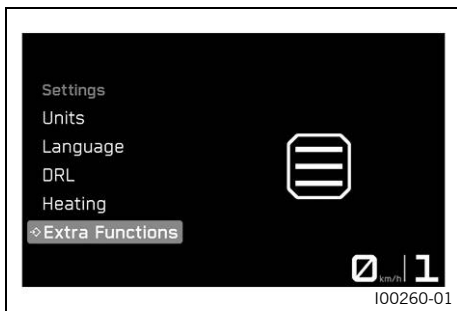

Condition

- The motorcycle is stationary.
- Motorcycle with optional supplementary function.
- Press the **SET** button when the menu is closed.
- Press the **UP** or **DOWN** button until **Settings** is highlighted.
- Press the **SET** button to open the menu.
- Press the **UP** or **DOWN** button until **Extra Functions** is highlighted. Press the **SET** button to open the submenu.
- Use the **UP** or **DOWN** button to navigate through the extra functions.

Info

The optional extra functions are listed.
The current **KTM PowerParts** and available software are listed on the KTM website.

8.1 Advice on preparing for first use



Danger

Danger of accidents A rider who is not fit to ride poses a danger to him or herself and others.

- Do not operate the vehicle if you are not fit to ride due to alcohol, drugs or medication.
- Do not operate the vehicle if you are physically or mentally impaired.



Warning

Risk of injury Missing or poor protective clothing presents an increased safety risk.

- Wear appropriate protective clothing such as helmet, boots, gloves as well as trousers and a jacket with protectors on all rides.
- Always wear protective clothing that is in good condition and meets the legal regulations.



Warning

Danger of crashing Different tire tread patterns on the front and rear wheel impair the handling characteristic.

Different tire tread patterns can make the vehicle significantly more difficult to control.

- Make sure that only tires with a similar tire tread pattern are fitted to the front and rear wheel.



Warning

Danger of accidents Non-approved or non-recommended tires and wheels impact the handling characteristic.

- Only use tires/wheels approved by KTM with the corresponding speed index.



Warning

Danger of accidents New tires have reduced road grip.

The contact surface on new tires is not yet roughened.

- Run in new tires with moderate riding and only gradually increase the lean angle.
- | | |
|-----------------|-----------------|
| Run-in distance | 200 km (124 mi) |
|-----------------|-----------------|



Info

When using the vehicle, remember that others may feel disturbed by excessive noise.

- Ensure that the pre-sales inspection work has been carried out by an authorized KTM workshop.
 - ✓ The delivery certificate is transferred upon vehicle handover.
- Read the entire Owner's Manual before riding for the first time.
- Get to know the controls.
- Get used to the handling characteristic of the motorcycle on suitable terrain before undertaking a more challenging ride. Also, ride as slowly as possible to get a better feeling for the motorcycle.
- Hold the handlebar firmly with both hands and keep your feet on the footrests when riding.
- Run the engine in. (📖 p. 50)



8.2 Running in the engine

- During the running-in time, do not exceed the specified engine speed.

Guideline

Maximum engine speed	
During first: 1,000 km (620 mi)	7,500 rpm



Info

During the running-in phase, the shift warning light is set to a specified value and cannot be changed.

- Avoid fully opening the throttle.

8.3 Loading the vehicle



Warning

Danger of accidents Total weight and axle loads influence the handling characteristic.

The total weight consists of: operational motorcycle with a full tank, rider and, if necessary, a passenger with protective clothing and helmet, and, if necessary, mounted luggage.

- Do not exceed the maximum permissible overall weight or the axle loads.



Warning

Danger of accidents Improper mounting of cases, tank rucksacks or other luggage impairs the handling characteristics.

Luggage mounted incorrectly can slip while the vehicle is in motion.

- Mount and secure all luggage according to the manufacturer's instructions.
- Check that your luggage is fixed properly at regular intervals.



Warning

Danger of accidents The luggage system will be damaged if it is overloaded.

- Read the manufacturer information on maximum payload when mounting cases.



Warning

Danger of accidents Luggage which has slipped impairs visibility.

If the tail light is covered, you are less visible to traffic behind you, especially when it is dark.

- Check that your luggage is fixed properly at regular intervals.



Warning

Danger of accidents A high payload alters the handling characteristic and increases the stopping distance.

- Adapt your speed to your payload.

- If luggage is carried, ensure it is fixed firmly as close as possible to the center of the vehicle and ensure even weight distribution between the front and rear wheels.
- Do not exceed the maximum permissible weight and maximum permissible axle loads.

Guideline

Maximum permissible overall weight	355 kg (783 lb.)
Maximum permissible front axle load	127 kg (280 lb.)
Maximum permissible rear axle load	228 kg (503 lb.)

9.1 Checks and maintenance measures when preparing for use

i Info

Before every trip, check the condition of the vehicle and ensure that it is roadworthy. The vehicle must be in perfect technical condition when it is being operated.

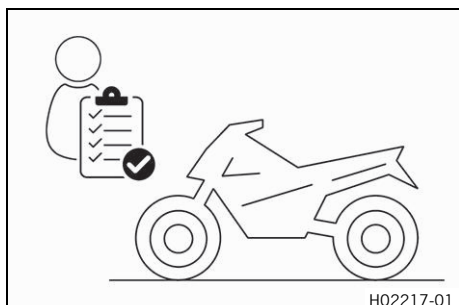

- Check the engine oil level. (📖 p. 105)
- Check the front brake fluid level. (📖 p. 75)
- Check the rear brake fluid level. (📖 p. 77)
- Check that the brake linings of the front brake are secured. (📖 p. 77)
- Check that the brake linings of the rear brake are secured. (📖 p. 79)
- Check that the brake system is functioning properly.
- Check the coolant level. (📖 p. 98)
- Check for chain dirt accumulation. (📖 p. 67)
- Check the chain tension. (📖 p. 68)
- Check the tire condition. (📖 p. 85)
- Check tire pressure. (📖 p. 86)
- Check the settings of all controls and ensure that they can be operated smoothly.
- Check that the electrical system is functioning properly.
- Check that luggage is properly secured.
- Sit on the motorcycle and check the rear mirror setting.
- Check the fuel level.



9.2 Starting



Danger

Danger of poisoning Exhaust gases are toxic and inhaling them may result in unconsciousness and death.

- Always make sure there is sufficient ventilation when running the engine.
- Use effective exhaust extraction when starting or running the engine in an enclosed space.



Caution

Danger of accidents Electronic components and safety devices will be damaged if the 12-V battery is discharged or missing.

If the 12-V battery is discharged or defective, malfunctions in the vehicle electronics can occur, especially when starting.

- Never operate the vehicle with a discharged 12-V battery or without a 12-V battery.

Note

Engine damage Unfiltered intake air has a negative effect on the service life of the engine.

Dust and dirt will enter the engine without an air filter.

- Only operate the vehicle if it is equipped with an air filter.

Note

Engine damage High revving speed with a cold engine negatively impacts the lifespan of the engine.

- Always run the engine warm at a low speed.

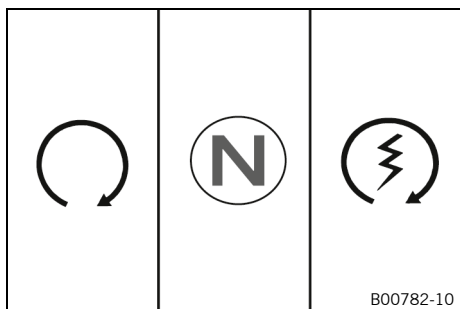

- Unlock the steering. (📖 p. 17)
- Sit on the vehicle, take the weight off of the side stand, and move it all the way up with your foot.
- Turn the emergency OFF switch to the position ○.
- Switch on the ignition by turning the ignition key to the position ○.

Guideline

To avoid malfunctions in the control unit communication, do not switch the ignition off and on in rapid succession.

- ✓ After you switch on the ignition, you can hear the fuel pump working for about two seconds. The function check of the combination instrument is run at the same time.
- Shift the transmission into neutral.
- ✓ The green idle indicator lamp **N** lights up.
- ✓ The **ABS** warning light lights up and goes out again after starting off.
- Briefly press the start button (🔌).

i Info

Do not press the start button until the combination instrument function check has finished.
Do not open the throttle to start.
Start continuously for a maximum of 5 seconds. Wait for at least five seconds before trying again.
This motorcycle is equipped with a safety starting system. You can only start the engine if the transmission is in neutral or if the clutch lever is pulled when a gear is engaged. If the side stand is folded out and you shift into gear and release the clutch lever, the engine stops.

9.3 Starting off

- Pull the clutch lever, shift into first-gear, release the clutch lever slowly and at the same time open the throttle carefully.

i Tip

If the engine stalls while starting off, only pull the clutch lever and press the start button. The transmission must not be shifted into neutral.

9.4 Quickshifter+ (optional)

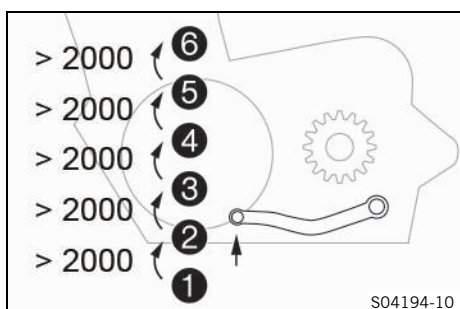

If the **QUICKSHIFTER+** is activated, you can shift up and down without actuating the clutch. Because there is no need to close the throttle grip, uninterrupted gear shifts are possible. The **QUICKSHIFTER+** uses the shift shaft position to check whether or not a shift should be initiated, and sends a corresponding signal to the engine control unit. If the **QUICKSHIFTER+** is disabled in the combination instrument, the clutch needs to be actuated in the normal way for each shift.

9.5 Shifting, riding



Warning

Danger of accidents Abrupt load alterations can cause the vehicle to get out of control.

- Avoid abrupt load alterations and sudden braking actions.
- Adapt your speed to the road conditions.



Warning

Danger of accidents If you change down at high engine speed, the rear wheel blocks and the engine races.

- Do not change into a low gear at high engine speed.



Warning

Danger of accidents An incorrect ignition key position causes malfunctions.

- Do not change the ignition key position while driving.



Warning

Danger of accidents Adjustments to the vehicle distract attention from traffic activity.

- Make all adjustments when the vehicle is at a standstill.



Warning

Risk of injury The passenger may fall from the motorcycle if they conduct themselves incorrectly.

- Ensure that the passenger sits correctly on the passenger seat, places his or her feet on the passenger foot pegs and holds on to the rider or the grab handles.
- Note the regulations governing the minimum age of passengers in your country.



Warning

Danger of accidents A risky riding style constitutes a major risk.

- Comply with traffic regulations and ride defensively and with foresight to detect sources of danger as early as possible.



Warning

Danger of accidents Cold tires have reduced road grip.

- Ride the first miles carefully on every journey at moderate speed until the tires reach operating temperature.



Warning

Danger of accidents New tires have reduced road grip.

The contact surface on new tires is not yet roughened.

- Run in new tires with moderate riding and only gradually increase the lean angle.
- | | |
|-----------------|-----------------|
| Run-in distance | 200 km (124 mi) |
|-----------------|-----------------|



Warning

Danger of accidents Improper mounting of cases, tank rucksacks or other luggage impairs the handling characteristics.

Luggage mounted incorrectly can slip while the vehicle is in motion.

- Mount and secure all luggage according to the manufacturer's instructions.
- Check that your luggage is fixed properly at regular intervals.



Warning

Danger of accidents A fall can damage the vehicle more seriously than it may first appear.

- Check the vehicle after a fall as you do when preparing for use.

Note

Engine failure Overheating damages the engine.

- If the coolant temperature warning is displayed, stop immediately and take care not to endanger yourself or other traffic participants in the process.
- Allow the engine and cooling system to cool down.
- Check and, if necessary, correct the coolant level on the cooling system while it is in a cooled state.



Info

If unusual noises occur while riding, stop immediately (taking care not to endanger yourself or other road users in the process), switch off the engine and contact an authorized KTM workshop.

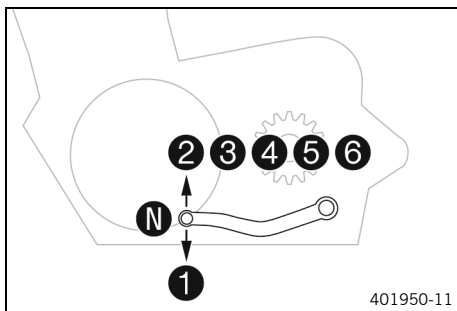



- Shift into a higher gear when conditions allow (incline, road situation, etc.).
- Release the throttle while simultaneously pulling the clutch lever, shift into the next gear, release the clutch lever, and open the throttle.



Info

The gear positions can be seen in the figure. The neutral or idle position is between the first and second gears. First gear is used for starting off or for steep inclines.

- Only open the throttle as much as the engine can handle – abrupt throttle grip opening increases fuel consumption. Accelerate only up to a speed suitable for the road surface and weather conditions. Particularly in bends, do not shift, and accelerate very carefully.
- Brake if necessary and close the throttle at the same time in order to shift down.
- Pull clutch lever and shift into a lower gear, release the clutch lever slowly, and open the throttle or shift again.
- Switch off the engine if you are likely to be running at idle speed or stationary for a long time.
- If the malfunction indicator lamp lights up while riding, stop immediately taking care not to endanger yourself or other road users in the process.
- After reaching maximum speed by fully opening the throttle grip, turn the throttle back so it is $\frac{3}{4}$ open. This will barely reduce the speed, but fuel consumption will be considerably lower.
- If the engine stalls (e.g. at an intersection), just pull the clutch lever and press the start button. The transmission must not be shifted into neutral.
- If the oil pressure warning lamp  lights up during a trip, stop as soon as it is safe to do so and switch off the engine. Contact an authorized KTM workshop.
- If the malfunction indicator lamp  lights up during a trip, please contact an authorized KTM workshop as soon as possible.

- If the general warning lamp  lights up during a trip, an operating safety (warning) message was detected.



Info

All warnings which have occurred are displayed and stored in the **Warning** menu until these are no longer active.

- If the QUICKSHIFTER+ (optional) is activated in the combination instrument, you can shift up in the engine speed range indicated without pulling the clutch lever.



Info

The minimum engine speed before shifting up is shown in the figure in revolutions per minute.

Pull the shift lever to the stop quickly without changing the throttle twist grip position.

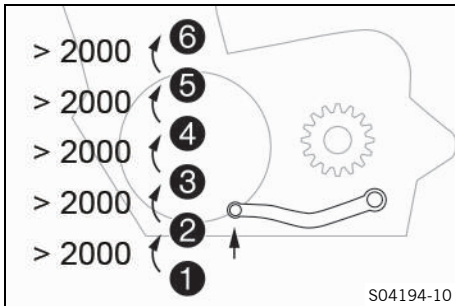

- If the QUICKSHIFTER+ is activated in the combination instrument, you can shift down in the engine speed range shown without pulling the clutch lever.



Info

The maximum engine speed before shifting down is shown in the figure in revolutions per minute.

Press the shift lever to the stop quickly without changing the throttle twist grip position.

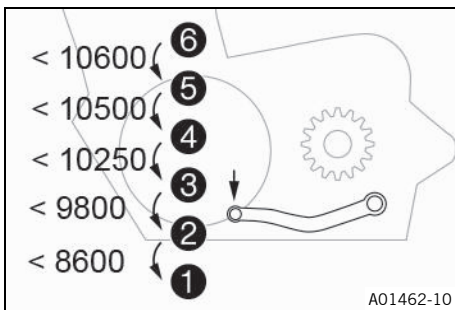

9.6 Applying the brakes



Warning

Danger of accidents Moisture and dirt impair the brake system.

- Brake carefully several times to dry out and remove dirt from the brake linings and the brake discs.



Warning

Danger of accidents A spongy pressure point on the front or rear brake reduces braking efficiency.

- Check the brake system and do not continue riding until the problem is eliminated. (Your authorized KTM workshop will be glad to help.)



Warning

Danger of accidents The brake system fails in the event of overheating.

If the foot brake lever is not released, the brake linings drag continuously.

- Take your foot off the foot brake lever if you do not want to brake.



Warning

Danger of accidents Higher total weight increases the stopping distance.

- Take the longer stopping distance into account when carrying a passenger or luggage with you.



Warning

Danger of accidents Salt on the roads impairs the brake system.

- Brake carefully several times to remove salt from the brake linings and the brake discs.



Warning

Danger of accidents ABS may increase the stopping distance in certain situations.

- Adjust application of the brakes to the respective riding situation and riding surface conditions.

- When braking, release the throttle and apply the front and rear brakes at the same time.



Info

When the ABS is enabled, you can achieve maximum braking power even on low grip surfaces such as sandy, wet, or slippery terrain without locking of the wheels.



Warning

Danger of accidents The rear wheel can lock due to the engine braking effect.

- Pull in the clutch, if you perform emergency or full braking, or if you brake on a slippery ground.



Warning

Danger of accidents Banked or laterally sloping ground reduces the maximum possible delay.

- If possible finish braking before going into a bend.

- Always finish braking before you go into a bend. Shift down to a lower gear appropriate to your speed.
- Use the braking effect of the engine on long downhill stretches. Shift back one or two gears, but do not over-rev the engine when doing so. This means that significantly less braking is required and the brake system does not overheat.

9.7 Stopping, parking



Warning

Risk of injury People who act without authorization endanger themselves and others.

- Do not leave the vehicle unattended if the engine is running.
- Protect the vehicle against access by unauthorized persons.
- Lock the steering and remove the ignition key if you leave the vehicle unattended.



Warning

Danger of burns Some vehicle components become hot when the vehicle is operated.

- Do not touch any parts such as the exhaust system, radiator, engine, damper, or brake system before the vehicle parts have cooled down.
- Let the vehicle parts cool down before you perform any work on the vehicle.

Note

Material damage The vehicle may be damaged by incorrect procedure when parking.

Significant damage may be caused if the vehicle rolls away or falls over.

The components for parking the vehicle are designed only for the weight of the vehicle.

- Park the vehicle on a firm and level surface.
- Ensure that nobody sits on the vehicle when the vehicle is parked on a stand.

Note

Fire hazard Hot vehicle components pose a fire hazard and explosion risk.

- Do not park the vehicle near to materials which are highly flammable or explosive.
- Allow the vehicle to cool down before covering it.

- Apply the brakes on the motorcycle.
- Shift the transmission into neutral.
- Switch off the ignition by turning the ignition key to the position ☒.



Info

If the engine is switched off with the emergency OFF switch and the ignition remains switched on in the ignition lock, the power supply to most electrical power consumers remains uninterrupted and this discharges the 12-V battery. You should therefore always switch off the engine with the ignition lock – the emergency OFF switch is intended for emergencies only.

- Park the motorcycle on a firm surface.
- Swing side stand forward with your foot as far as it will go and lean the vehicle on it.
- Lock the steering. (📖 p. 16)



9.8 Transport

Note

Danger of damage The parked vehicle can roll away or fall over.

- Park the vehicle on a firm and level surface.

Note

Fire hazard Hot vehicle components pose a fire hazard and explosion risk.

- Do not park the vehicle near to materials which are highly flammable or explosive.
- Allow the vehicle to cool down before covering it.

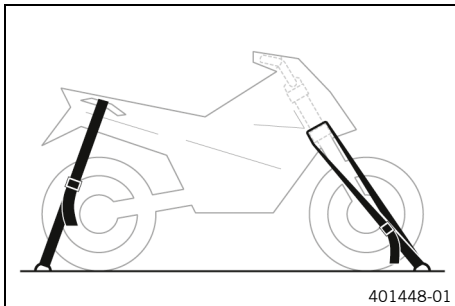

- Switch off the engine and remove the ignition key.
- Use tension belts or other suitable devices to secure the motorcycle against accidents or falling over.

9.9 Towing in the event of a breakdown

Note

Danger of damage Towing away using a towing vehicle is not an appropriate vehicle recovery method.

Damage to the drive train or transmission may occur during towing.

- Do not use towing equipment where the wheels of the broken down vehicle remain on the road and rotate as it is towed.
- Always transport a broken down vehicle on a trailer or on the loading area of a transport vehicle.

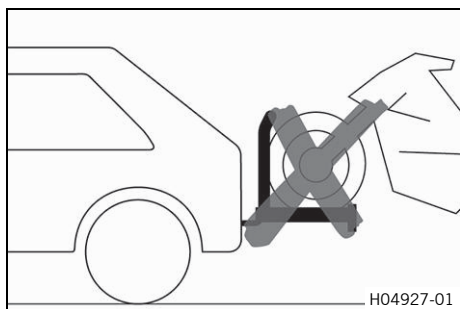

- Ensure that the broken down vehicle is properly secured on the trailer or transport vehicle.
- Observe local regulations for the recovery of broken down vehicles.

9.10 Refueling



Danger

Fire hazard Fuel is highly flammable.

The fuel in the fuel tank expands when warm and can escape if overfilled.

- Do not fuel the vehicle in the vicinity of open flames or lit cigarettes.
- Switch off the engine for refueling.
- Make sure that no fuel is spilled; particularly not on hot parts of the vehicle.
- If any fuel is spilled, wipe it off immediately.
- Observe the specifications for refueling.



Warning

Danger of poisoning Fuel is harmful to health.

- Avoid skin, eye and clothing contact with fuel.
- Immediately consult a doctor if you swallow fuel.
- Do not inhale fuel vapors.
- Rinse the affected area immediately with plenty of water in the event of contact with the skin.
- Rinse the eyes thoroughly with water, and consult a doctor in case of fuel contact with the eyes.
- Change your clothing if fuel spills on them.

Note

Material damage Inadequate fuel quality causes the fuel filter to quickly become clogged.

In some countries and regions, the available fuel quality and cleanliness may not be sufficient. This will result in problems with the fuel system.

- Refuel only with clean fuel that meets the specified standards. (Your authorized KTM workshop will be glad to help.)



Note

Environmental hazard Improper handling of fuel is a danger to the environment.

- Do not allow fuel to enter the groundwater, the soil, or the sewage system.

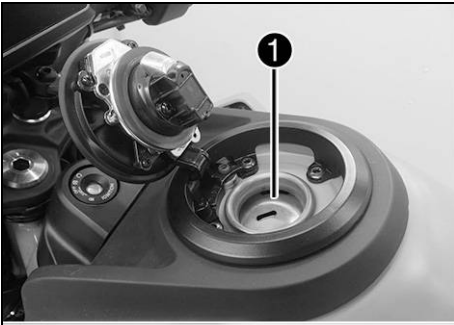

- Switch off the engine.
- Open the fuel tank filler cap. (📖 p. 17)
- Fill the fuel tank with fuel up to the lower edge ① of the fuel filler.

Total fuel tank capacity, approx.	15 l (4 US gal)	Super unleaded (ROZ 95) (📖 p. 124)
-----------------------------------	--------------------	--

- Close the fuel tank filler cap. (📖 p. 18)



T04646-01

10.1 Additional information

Any further work that results from the service work must be ordered separately and invoiced separately. Different service intervals may apply in your country, depending on the local operating conditions. Individual service intervals and scopes may change in the course of technical developments. The most up-to-date service schedule can always be found on KTM Dealer.net. Your authorized KTM dealer will be happy to advise you.

10.2 Service work

	every 48 months	every 24 months	every 12 months	every 15,000 km (9,300 mi)	every 7,500 km (4,650 mi)	after 1,000 km (620 mi)
Read out the fault memory using the KTM diagnostics tool. 🛠️	○	●	●	●	●	●
Program the shift shaft sensor. 🛠️	○	●	●			
Check that the electrical system is functioning properly. 🛠️	○	●	●	●	●	●
Check that the brake linings of the front brake are secured. (📖 p. 77)	○	●	●	●	●	●
Check that the brake linings of the rear brake are secured. (📖 p. 79)	○	●	●	●	●	●
Check the brake discs. (📖 p. 74)	○	●	●	●	●	●
Check the brake lines for damage and leakage. 🛠️	○	●	●	●	●	●
Check the front brake fluid level. (📖 p. 75)	○	●	●	●		
Change the front brake fluid. 🛠️						● ●
Check the rear brake fluid level. (📖 p. 77)	○	●	●	●		
Change the rear brake fluid. 🛠️						● ●
Change the engine oil and oil filter, clean the oil screen. 🛠️ (📖 p. 105)	○	●	●	●	●	●
Check all hoses (e.g. fuel, cooling, bleeder, drainage hoses, etc.) and sleeves for cracking, tightness, and correct routing. 🛠️	○	●	●	●	●	●
Empty the drainage hoses. 🛠️	○	●	●	●	●	●
Check the cables for damage and routing without sharp bends. 🛠️	○	●	●	●	●	●
Check the frame. 🛠️				●		
Check the link fork. 🛠️				●		
Check the fork bearing for play. 🛠️		●	●			
Check the steering head bearing for play. 🛠️	○	●	●			
Check the wheel bearing for play. 🛠️		●	●			
Check the shock absorber and fork for leaks. 🛠️	○	●	●	●	●	●
Check the tire condition. (📖 p. 85)	○	●	●	●	●	●
Check tire pressure. (📖 p. 86)	○	●	●	●	●	●
Check the chain, rear sprocket, and engine sprocket. (📖 p. 70)		●	●	●	●	●
Check the chain tension. (📖 p. 68)	○	●	●	●	●	●
Grease all moving parts (e.g. side stand, hand lever, chain, etc.) and check for smooth operation. 🛠️	○	●	●	●	●	●
Check that the throttle cables are undamaged, routed without sharp bends, and set correctly. 🛠️	○	●	●	●	●	●
Check the valve clearance, change the spark plug. 🛠️				●		
Change the air filter, clean the air filter box. 🛠️		●	●			

	every 48 months					
	every 24 months			every 12 months		
	every 15,000 km (9,300 mi)		every 7,500 km (4,650 mi)		after 1,000 km (620 mi)	
Check the headlight setting. (📖 p. 94)	○	●	●			
Check the tightness of the safety-relevant screws and nuts which are easily accessible. 🛠️	○	●	●	●	●	●
Clean the dust boots of the fork legs. (📖 p. 65)		●	●			
Check that the radiator fan is functioning properly. 🛠️	○	●	●	●	●	●
Check the coolant level. (📖 p. 98)	○	●	●	●	●	
Checking the antifreeze. 🛠️		●	●		●	
Change the coolant. (📖 p. 102)						●
Final check: Check the vehicle is roadworthy and take a test ride. 🛠️	○	●	●	●	●	●
Read out the error memory after the test ride using the KTM diagnostics tool. 🛠️	○	●	●	●	●	●
Set the service interval display. 🛠️	○	●	●	●	●	●
Make a service entry in KTM Dealer.net . 🛠️	○	●	●	●	●	●

- One-time interval
- Periodic interval

11.1 Adjusting the spring preload of the shock absorber ↗



Warning

Danger of accidents Modifications to the suspension setting may seriously alter the handling characteristic.

- Ride slowly to start with after making adjustments to get the feel of the new handling characteristic.



Info

The spring preload defines the initial status of the spring operation on the shock absorber. The best spring preload setting is achieved when it is set for the weight of the rider and that of any luggage and a passenger, thus ensuring an ideal compromise between handling and stability.



- Adjust the spring preload by turning adjusting ring **1**.

Guideline

Spring preload	
Standard	3 clicks
Hook wrench, shock absorber (90529077000)	
Extension for hook wrench (90129099025)	



Info

The spring preload can be set to 10 different positions.

11.2 Adjusting the shift lever



Info

The adjustment range of the shift lever is limited.

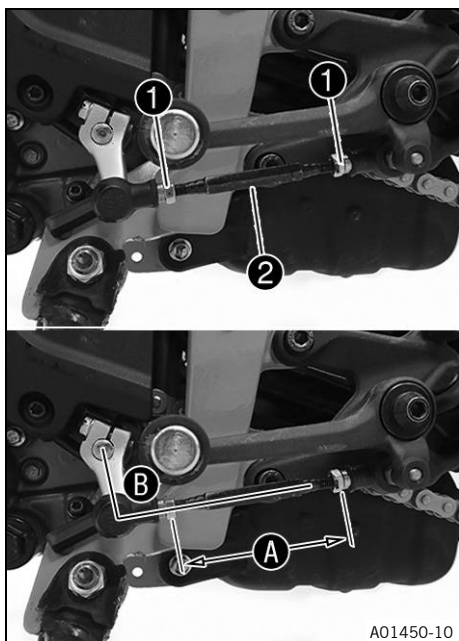

- Loosen nuts **1**.
- Adjust the shift lever by turning shift rod **2**.

Guideline

Shift rod adjustment range A	90 ... 102 mm (3.54 ... 4.02 in)
-------------------------------------	----------------------------------



Info

Make the same adjustments on both sides. At least five screw threads must be screwed into the seating.

- Check adjusting angle **B**.

Guideline

Adjusting angle B shift rod - bell crank - shift lever	90°
---	-----

- Tighten nuts **1**.

**Info**

After the nuts have been tightened, the bearings of the shift rod must be central and aligned identically to each other in order to ensure freedom of movement in the bearing shells.

- Check the shift lever to ensure it is functioning properly and can move freely.



12.1 Raising the motorcycle with rear lifting gear

Note

Danger of damage The parked vehicle can roll away or fall over.

- Park the vehicle on a firm and level surface.

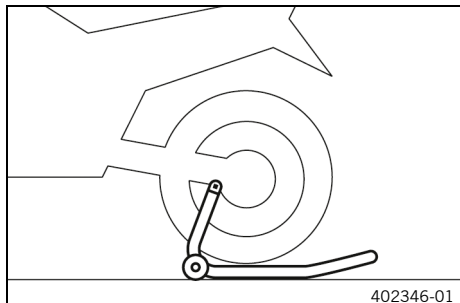

- Mount the supports of the lifting gear.
- Insert the adapter in the rear lifting gear.

Retaining adapter (61029955244)

Rear wheel work stand (69329955000)

- Stand the motorcycle upright, align the lifting gear to the link fork and the adapters, and raise the motorcycle.

12.2 Removing the rear of the motorcycle from the lifting gear

Note

Danger of damage The parked vehicle can roll away or fall over.

- Park the vehicle on a firm and level surface.

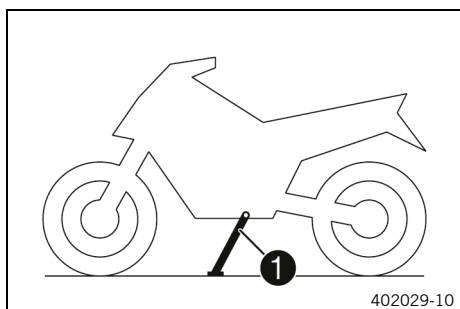

- Secure the motorcycle against falling over.
- Remove the rear lifting gear and lean the vehicle on side stand ①.
- Remove bushings kit.

12.3 Lifting the motorcycle with the front lifting gear

Note

Danger of damage The parked vehicle can roll away or fall over.

- Park the vehicle on a firm and level surface.

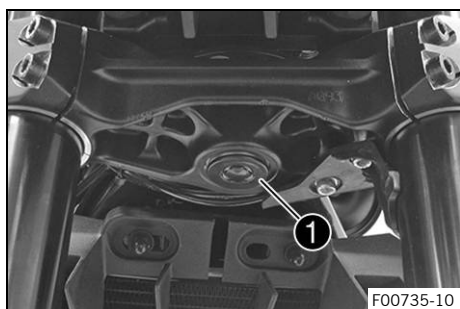

Preparatory work

- Raise the motorcycle with the rear lifting gear. (📖 p. 64)

Condition

- Remove protection cap ①.

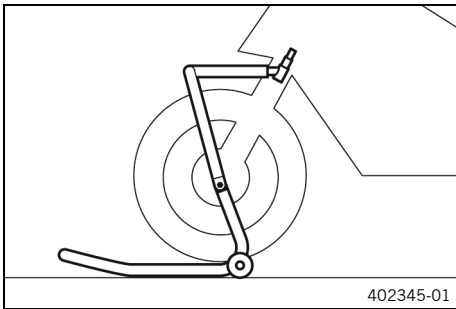

- Move the handlebar to the straight-ahead position. Position the lifting gear.

Mounting pin (69329965030)

Front wheel work stand, large (69329965100)

i Info

Always raise the motorcycle at the rear first.

- Lift the motorcycle at the front.



12.4 Taking the motorcycle off the front lifting gear

Note

Danger of damage The parked vehicle can roll away or fall over.

- Park the vehicle on a firm and level surface.

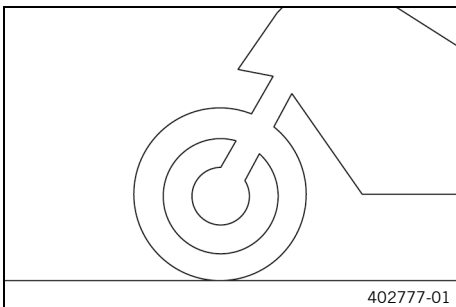

Main work

- Secure the motorcycle against falling over.
- Remove the front lifting gear.

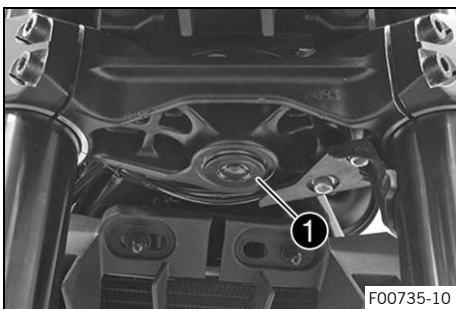

- Mount protection cap **1**.

Finishing work

- Remove the rear of the motorcycle from the lifting gear. (📖 p. 64)



12.5 Cleaning the dust boots of the fork legs

Preparatory work

- Raise the motorcycle with the rear lifting gear. (📖 p. 64)
- Lift the motorcycle with the front lifting gear. (📖 p. 64)

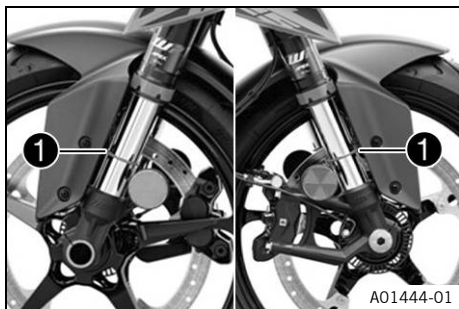

Main work

- Push dust boots ① of both fork legs downward.



Info

The dust boots remove dust and coarse dirt particles from the inside fork tubes. Over time, dirt can accumulate behind the dust boots. If this dirt is not removed, the oil seals behind can start to leak.



Warning

Danger of accidents Oil or grease on the brake discs reduces the braking effect.

- Always keep the brake discs free of oil and grease.
- Clean the brake discs with brake cleaner when necessary.

- Clean and oil the dust boots and inner fork tubes of both fork legs.

Universal oil spray (📖 p. 125)

- Press the dust boots back into the installation position.
- Remove the excess oil.

Finishing work

- Take the motorcycle off the front lifting gear. (📖 p. 65)
- Remove the rear of the motorcycle from the lifting gear. (📖 p. 64)

12.6 Removing the passenger seat

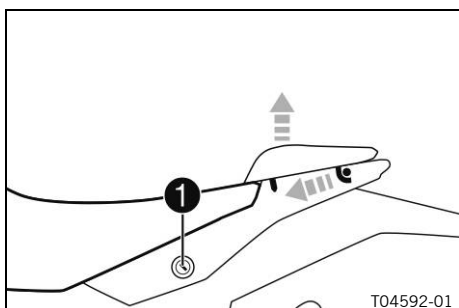

- Insert the ignition key in seat lock ① and turn it clockwise.
- Lift the front of the seat and push it towards the fuel tank.
- Remove the ignition key from the seat lock.

12.7 Mounting the passenger seat

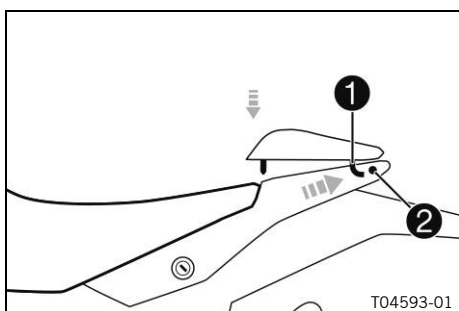

- Attach hooks ① on the passenger seat to hangers ② on the subframe, and push it to the rear.
- Press the passenger seat downward until it clicks into place.



Warning

Danger of accidents The seat can come loose from the anchoring if it is not mounted correctly.

- After assembly, check whether the seat is correctly locked and cannot be pulled up.

- Finally, check that the passenger seat is correctly mounted.

12.8 Removing the front rider's seat

Preparatory work

- Remove the passenger seat. (📖 p. 66)

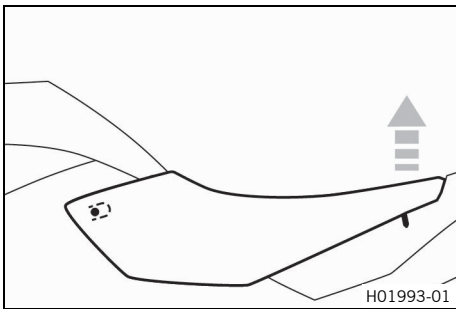

Main work

- Raise the rear of the front rider's seat, pull it towards the rear, and remove it upwards.

12.9 Mounting the front rider's seat

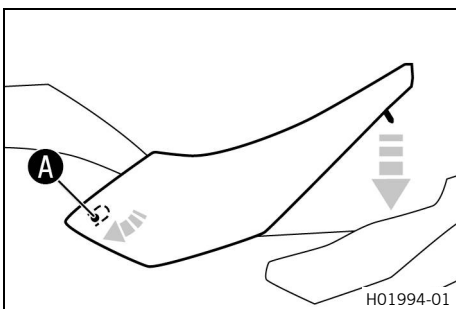

Main work

- Attach the front rider's seat in area **A** and lower at the rear.
- Finally, check that the front rider's seat is correctly mounted.

Finishing work

- Mount the passenger seat. (📖 p. 66)

12.10 Checking for chain dirt accumulation

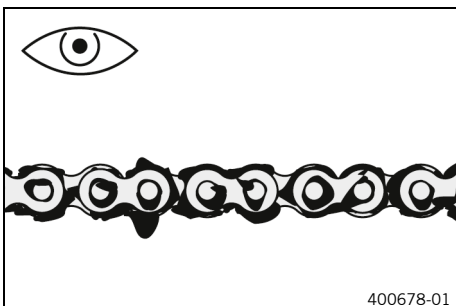

- Check the chain for coarse dirt accumulation.
 - » If the chain is very dirty:
 - Clean the chain. (📖 p. 67)

12.11 Cleaning the chain



Warning

Danger of accidents Lubricants on the tires reduces the road grip.

- Remove lubricants from the tires using a suitable cleaning agent.



Warning

Danger of accidents Oil or grease on the brake discs reduces the braking effect.

- Always keep the brake discs free of oil and grease.
- Clean the brake discs with brake cleaner when necessary.



Note

Environmental hazard Hazardous substances cause environmental damage.

- Dispose of oils, grease, filters, fuel, cleaning agents, brake fluid, etc., correctly and in compliance with the applicable regulations.



Info

The service life of the chain depends largely on its maintenance.

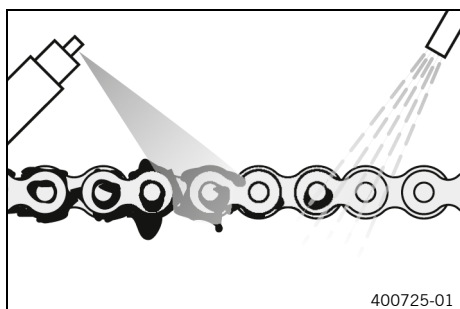

Preparatory work

- Raise the motorcycle with the rear lifting gear. (📖 p. 64)

Main work

- Clean the chain regularly.
- Rinse off the loose dirt with a gentle jet of water.
- Remove grease residue with chain cleaner.

Chain cleaner (📖 p. 125)

- After drying, apply chain spray.

Street chain spray (📖 p. 125)

Finishing work

- Remove the rear of the motorcycle from the lifting gear. (📖 p. 64)

12.12 Checking the chain tension



Warning

Danger of accidents Incorrect chain tension damages components and results in accidents.

If the chain is tensioned too much, the chain, engine sprocket, rear sprocket, transmission and rear wheel bearings wear more quickly. Some components may break if overloaded.

If the chain is too loose, the chain may fall off the engine sprocket or the rear sprocket. As a result, the rear wheel locks or the engine will be damaged.

- Check the chain tension regularly.
- Set the chain tension in accordance with the specification.

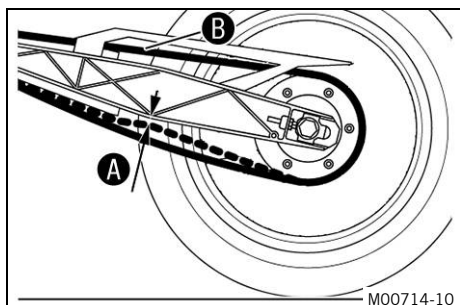

Preparatory work

- Raise the motorcycle with the rear lifting gear. (📖 p. 64)

Main work

- Shift the transmission into neutral.
- In the area after the chain sliding guard, press the chain upward toward the link fork and measure chain tension **A**.



Info

Top chain section **B** must be taut.

Chain wear is not always even, so you should repeat this measurement at different chain positions.

Chain tension	5 ... 7 mm (0.2 ... 0.28 in)
---------------	------------------------------

- » If the chain tension does not meet the specification:
 - Adjust the chain tension. (📖 p. 69)

- Remove the rear of the motorcycle from the lifting gear. (📖 p. 64)

12.13 Adjusting the chain tension



Warning

Danger of accidents Incorrect chain tension damages components and results in accidents.

If the chain is tensioned too much, the chain, engine sprocket, rear sprocket, transmission and rear wheel bearings wear more quickly. Some components may break if overloaded.

If the chain is too loose, the chain may fall off the engine sprocket or the rear sprocket. As a result, the rear wheel locks or the engine will be damaged.

- Check the chain tension regularly.
- Set the chain tension in accordance with the specification.

Preparatory work

- Raise the motorcycle with the rear lifting gear. (📖 p. 64)
- Check the chain tension. (📖 p. 68)

Main work

- Loosen nut ①.
- Loosen nuts ②.
- Adjust the chain tension by turning adjusting screws ③ left and right.

Guideline

Chain tension	5 ... 7 mm (0.2 ... 0.28 in)
Turn adjusting screws ③ on the left and right so that the markings on left and right chain adjusters ④ are in the same position relative to reference marks A. The rear wheel is then correctly aligned.	

i Info

The upper part of the chain must be taut. Chains do not always wear evenly, so you should check the setting at different chain positions.

- Tighten nuts ②.
- Make sure that chain adjusters ④ are fitted correctly on adjusting screws ③.
- Tighten nut ①.

Guideline

Nut, rear wheel spindle	M16	100 Nm (73.8 lbf ft)
-------------------------	-----	----------------------

Finishing work

- Remove the rear of the motorcycle from the lifting gear. (📖 p. 64)

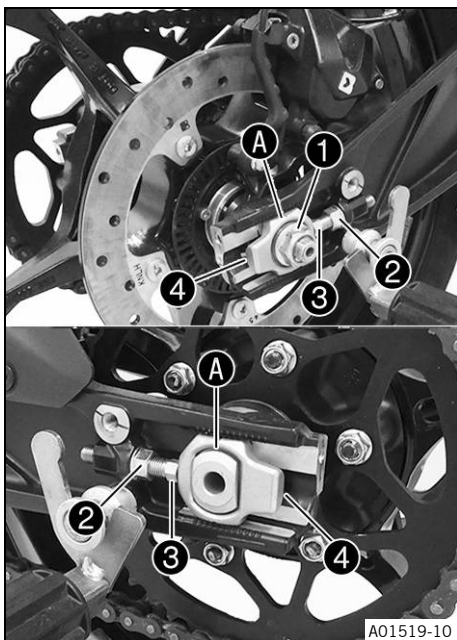

12.14 Checking the chain, rear sprocket, and engine sprocket

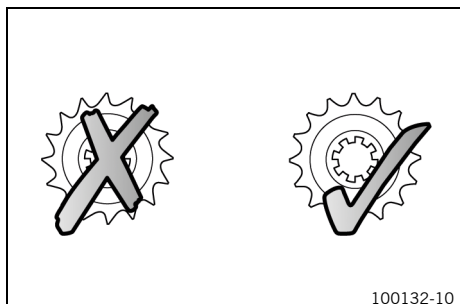

100132-10

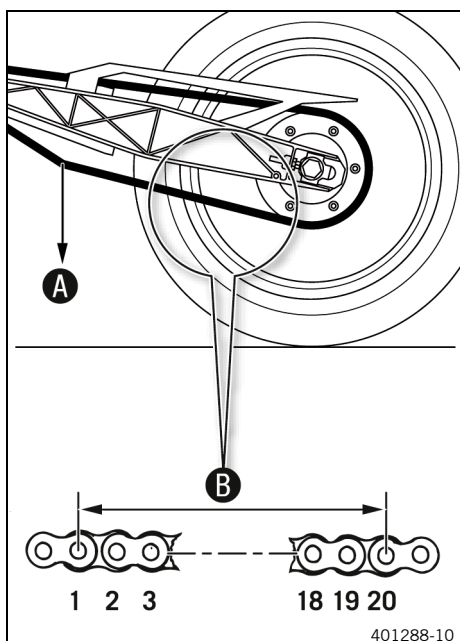

401288-10

Preparatory work

- Raise the motorcycle with the rear lifting gear. (📖 p. 64)

Main work

- Check the rear sprocket and the engine sprocket for wear.
 - » If the rear sprocket and engine sprocket are worn:
 - Change the drivetrain kit. 🛠️



Info

The engine sprocket, rear sprocket and chain should always be replaced together.

- Shift the transmission into neutral.
- Pull on the lower chain section with specified weight **A**.

Guideline

Weight, chain wear measurement	15 kg (33 lb.)
--------------------------------	----------------

- Measure distance **B** of 20 chain rollers in the lower chain section.



Info

Chain wear is not always even, so repeat this measurement at different positions on the chain.

Maximum distance B from 20 chain rollers at the longest chain section	301.6 mm (11.874 in)
--	----------------------

- » If distance **B** is greater than the specified measurement:
 - Change the drivetrain kit. 🛠️



Info

When a new chain is mounted, the rear sprocket and the engine sprocket should also be changed.
New chains wear out faster on old, worn sprockets.

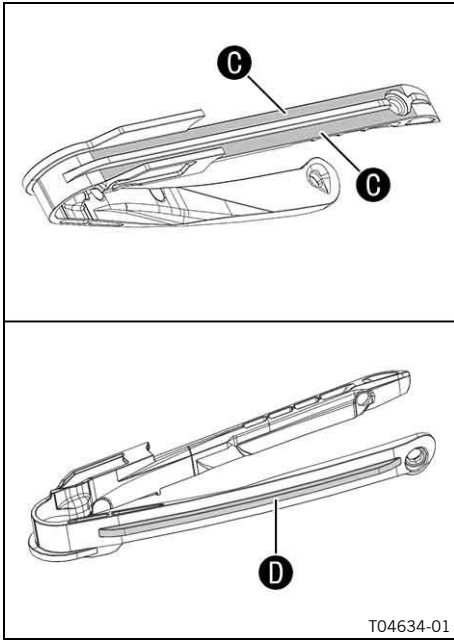

- Check the chain sliding guard for wear.
 - » If continuous signs of wear to the chain are visible on the chain sliding guard in the area **C** marked:
 - Change the chain sliding guard. 🛠️
 - » If the chain sliding guard is highly worn on the underside in the marked area **D**:
 - Change the chain sliding guard. 🛠️
- Check that the chain sliding guard is firmly fitted.
 - » If the chain sliding guard is loose:
 - Tighten the screw of the chain sliding guard.

Guideline

Screw, chain guard	M5	7 Nm (5.2 lbf ft)
--------------------	----	-------------------

Finishing work

- Remove the rear of the motorcycle from the lifting gear. (📖 p. 64)



12.15 Adjusting the basic position of the clutch lever

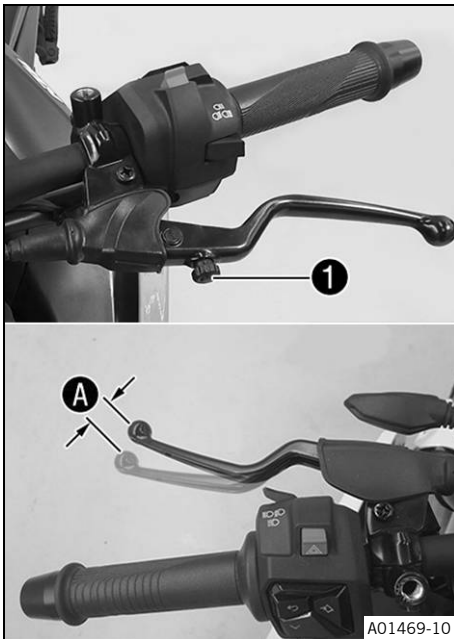

- Adjust the basic position of the clutch lever to your hand size by turning adjusting wheel **1**.
- Push the clutch lever forward and turn the adjusting wheel until a suitable position is reached in area **A**.



Info

Do not make any adjustments while riding.



12.16 Checking the clutch lever play

Note

Clutch damage If there is no free travel by the clutch lever, the clutch will begin to slip.

- Check the free travel of the clutch lever each time before using the motorcycle.
- Adjust the free travel of the clutch lever when necessary in accordance with the specification.

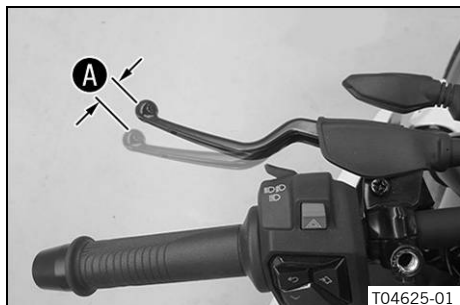

- Check the clutch lever for smooth operation.
- Move the handlebar to the straight-ahead position.
- Pull the clutch lever until resistance is perceptible, and determine the play in the clutch lever **A**.

Clutch lever play A	1 ... 3 mm (0.04 ... 0.12 in)
----------------------------	-------------------------------

- » If the clutch lever play does not meet the specified value:
 - Adjust play in the clutch lever. (🔧 p. 72)
- Move the handlebar to and fro over the entire steering range.

The clutch lever play must not change.

- » If the clutch lever play changes:
 - Check the routing of the clutch cable.

12.17 Adjusting play in the clutch lever 🛠️

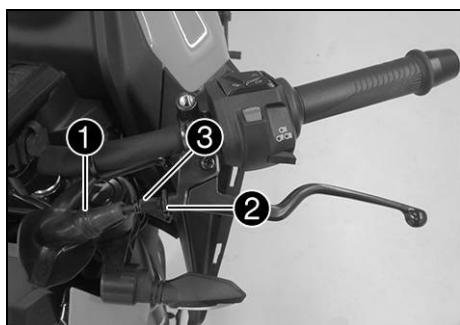

- Move the handlebar to the straight-ahead position.
- Push back sleeve **1**.
- Loosen lock nut **2**.
- Adjust the play in the clutch level **A** by turning adjusting screw **3**.

Guideline

Clutch lever play A	1 ... 3 mm (0.04 ... 0.12 in)
----------------------------	-------------------------------

- Tighten lock nut **2**.
- Position bellows **1**.

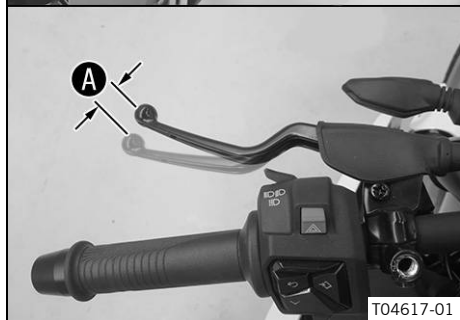

13.1 Anti-lock braking system (ABS)

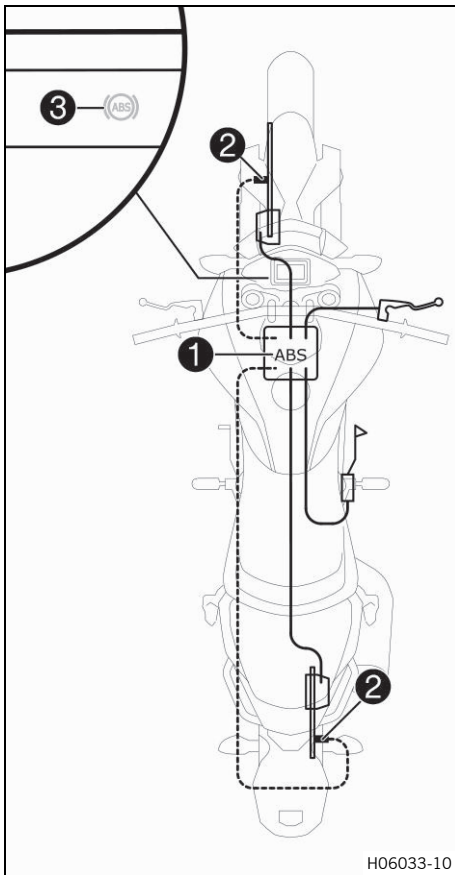

The ABS module **1**, which consists of a hydraulic unit, ABS control unit, and return pump, is installed under the fuel tank. One wheel speed sensor **2** is located in each case on the front and the rear wheel.



Warning

Danger of accidents Changes to the vehicle impair the function of the ABS.

- Do not make any changes to the suspension travel.
- Only use spare parts on the brake system which have been approved and recommended by KTM.
- Only use tires/wheels approved by KTM with the corresponding speed index.
- Maintain the specified tire pressure.
- Ensure that service work and repairs are performed professionally. (Your authorized KTM workshop will be glad to help.)

The ABS is a safety system that prevents the wheels locking when driving straight ahead or when cornering (within the limits of physics).



Warning

Danger of accidents Driving aids can reduce the probability of a fall only within physical limits.

It is not always possible to compensate for certain riding situations, for example with luggage loaded with a high center of gravity, varying road surfaces, steep descents or full braking without disengaging the gear.

- Adapt your riding style to the road conditions and your driving ability.



Warning

Danger of accidents An incorrectly selected ABS mode makes control of the vehicle considerably more difficult.

The ABS modes are each only suitable for certain conditions.

- Always select an ABS mode that is compatible with the surface of the ground.

The ABS operates with two independent brake circuits (front and rear brakes). When the ABS control unit detects a locking tendency in a wheel, ABS begins regulating the brake pressure. The control function causes a slight pulsing of the hand and foot brake levers.

The ABS warning lamp **3** must light up after the ignition is switched on and go out after starting off. If it does not go out after starting off or if it is lit while riding, this indicates a fault in the ABS. In this case, the ABS is no longer enabled and the wheels may lock during braking. The brake system itself stays functional; only ABS control is not available.

The ABS warning lamp may also light up if the rotating speeds of the front and rear wheels differ greatly under extreme riding conditions, for example when making "wheelies" or if the rear wheel spins. This causes the ABS to switch off.

To reactivate the ABS, stop the vehicle and switch off the ignition. The ABS is reactivated when the vehicle is switched on again. The ABS warning lamp goes out after starting off.

13.2 Adjusting the basic position of the hand brake lever

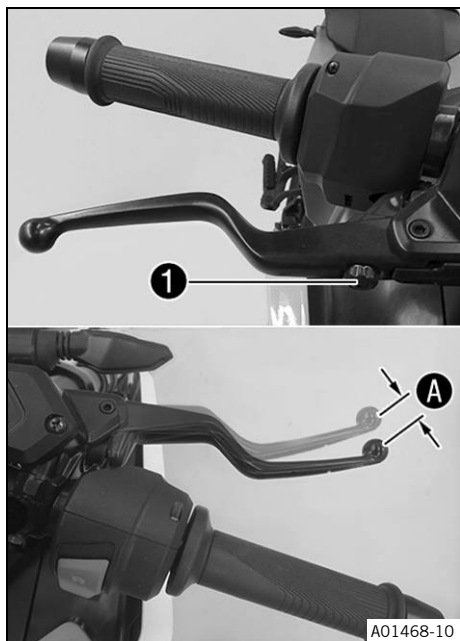

- Adjust the basic position of the hand brake lever to your hand size by turning adjusting wheel **1**.
- Push the hand brake lever forward and turn the adjusting wheel until a suitable position is reached in area **A**.



Info

Do not make any adjustments while riding.

13.3 Checking the brake discs



Warning

Danger of accidents Worn-out brake discs reduce the braking effect.

- Make sure that worn-out brake discs are replaced immediately. (Your authorized KTM workshop will be glad to help.)

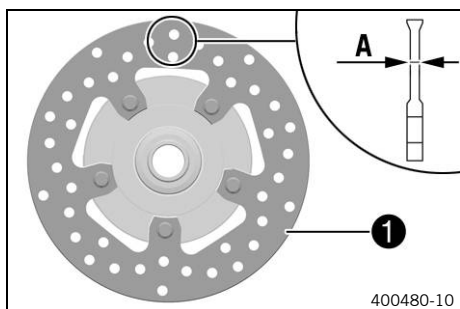

- Check the front and rear brake disc thickness at multiple points for the dimension **A**.



Info

Wear will reduce the thickness of the brake disc at contact surface **1** of the brake linings.

Brake discs - wear limit	
Front	4.5 mm (0.177 in)
Rear	4.5 mm (0.177 in)

- » If the brake disc thickness is less than the specified value.
 - Change the front brake disc. 🛠️
 - Change the rear brake disc. 🛠️
- Check the front and rear brake discs for damage, cracking, and deformation.

- » If the brake disc exhibits damage, cracking, or deformation:
 - Change the front brake disc. 🛠️
 - Change the rear brake disc. 🛠️



13.4 Checking the front brake fluid level



Warning

Danger of accidents An insufficient brake fluid level will cause the brake system to fail.

If the brake fluid level drops below the **MIN** marking, the brake system is leaking or the brake linings are worn down.

- Check the brake system and do not continue riding until the problem is eliminated. (Your authorized KTM workshop will be glad to help.)



Warning

Danger of accidents Brake fluid which is too old or of the wrong type impairs the function of the brake system.

- Make sure that brake fluid for the front and rear brake is changed in accordance with the service schedule. (Your authorized KTM workshop will be glad to help.)
- Make sure that only clean, approved brake fluid from a tightly sealed container is used. (Your authorized KTM workshop will be glad to help.)

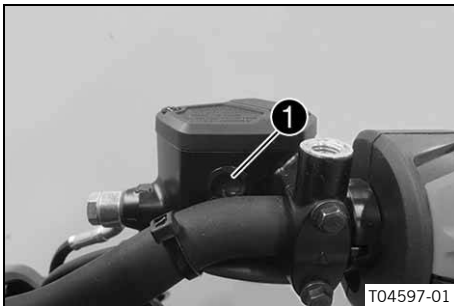

- Move the brake reservoir mounted on the handlebar into a horizontal position.
- Check the brake fluid level in the level viewer ①.
 - » If the brake fluid level is below the **MIN** marking:
 - Add front brake fluid. 🛠️ (📖 p. 75)



13.5 Adding front brake fluid 🛠️



Warning

Danger of accidents An insufficient brake fluid level will cause the brake system to fail.

If the brake fluid level drops below the **MIN** marking, the brake system is leaking or the brake linings are worn down.

- Check the brake system and do not continue riding until the problem is eliminated. (Your authorized KTM workshop will be glad to help.)



Warning

Skin irritation Brake fluid is a harmful substance.

- Keep brake fluid out of the reach of children.
- Wear suitable protective clothing and safety glasses.
- Do not allow brake fluid to come into contact with the skin, the eyes or clothing.
- Consult a doctor immediately if brake fluid has been swallowed.
- Rinse the affected area with plenty of water in the event of contact with the skin.
- Rinse eyes thoroughly with water immediately and consult a doctor if brake fluid comes into contact with the eyes.
- If brake fluid spills on to your clothing, change the clothing.



Warning

Danger of accidents Brake fluid which is too old or of the wrong type impairs the function of the brake system.

- Make sure that brake fluid for the front and rear brake is changed in accordance with the service schedule. (Your authorized KTM workshop will be glad to help.)
- Make sure that only clean, approved brake fluid from a tightly sealed container is used. (Your authorized KTM workshop will be glad to help.)



Note

Environmental hazard Hazardous substances cause environmental damage.

- Dispose of oils, grease, filters, fuel, cleaning agents, brake fluid, etc., correctly and in compliance with the applicable regulations.



Info

Avoid contact between brake fluid and painted parts. Brake fluid corrodes paint.

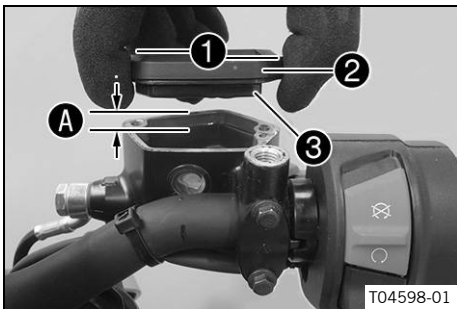

Preparatory work

- Check that the brake linings of the front brake are secured. (📖 p. 77)

Main work

- Move the brake fluid reservoir mounted on the handlebar to a horizontal position.
- Remove screws ①.
- Take off cover ② with membrane ③.
- Add brake fluid to level A.

Guideline

Dimension A	5 mm (0.2 in)
-------------	---------------

Brake fluid DOT 4 / DOT 5.1 (📖 p. 123)
--

- Position the cover with the membrane. Mount and tighten the screws.



Info

Use water to immediately clean up any brake fluid that has overflowed or spilled.

13.6 Checking that the brake linings of the front brake are secured



Warning

Danger of accidents Worn-out brake linings reduce the braking effect.

- Ensure that worn-out brake linings are replaced immediately. (Your authorized KTM workshop will be glad to help.)



Warning

Danger of accidents Damaged brake discs reduce the braking effect.

If the brake linings are not changed in time, the brake lining carriers grind against the brake disc. As a consequence, the braking effect is greatly reduced and the brake discs are destroyed.

- Check the brake linings regularly.

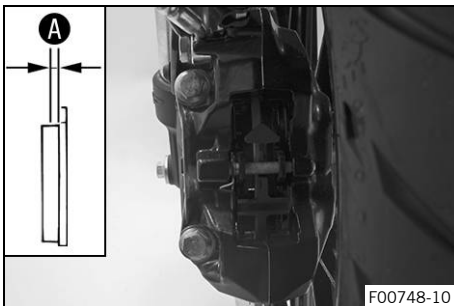

- Check the brake linings for lining thickness **A**.

Minimum thickness A	$\geq 1 \text{ mm } (\geq 0.04 \text{ in})$
----------------------------	---

- » If it is less than the minimum thickness:
 - Change the brake linings of the front brake. 🛠️
- Check the brake linings for damage and cracking.
 - » If there is damage or cracking:
 - Change the brake linings of the front brake. 🛠️
- Check that the brake linings are secured.
 - » If the brake linings are not secured correctly:
 - Secure brake linings, replace with new parts if necessary.



13.7 Checking the rear brake fluid level



Warning

Danger of accidents An insufficient brake fluid level will cause the brake system to fail.

If the brake fluid level drops below the **MIN** marking, the brake system is leaking or the brake linings are worn down.

- Check the brake system and do not continue riding until the problem is eliminated. (Your authorized KTM workshop will be glad to help.)



Warning

Danger of accidents Brake fluid which is too old or of the wrong type impairs the function of the brake system.

- Make sure that brake fluid for the front and rear brake is changed in accordance with the service schedule. (Your authorized KTM workshop will be glad to help.)
- Make sure that only clean, approved brake fluid from a tightly sealed container is used. (Your authorized KTM workshop will be glad to help.)

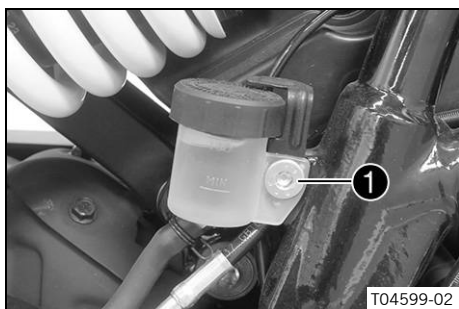

- Position the vehicle vertically.
- Check the brake fluid level in the brake fluid reservoir.
 - » If the fluid level reaches the **MIN** marking ①:
 - Add rear brake fluid. 🛠️ (📖 p. 78)

13.8 Adding rear brake fluid 🛠️



Warning

Danger of accidents An insufficient brake fluid level will cause the brake system to fail.

If the brake fluid level drops below the **MIN** marking, the brake system is leaking or the brake linings are worn down.

- Check the brake system and do not continue riding until the problem is eliminated. (Your authorized KTM workshop will be glad to help.)



Warning

Skin irritation Brake fluid is a harmful substance.

- Keep brake fluid out of the reach of children.
- Wear suitable protective clothing and safety glasses.
- Do not allow brake fluid to come into contact with the skin, the eyes or clothing.
- Consult a doctor immediately if brake fluid has been swallowed.
- Rinse the affected area with plenty of water in the event of contact with the skin.
- Rinse eyes thoroughly with water immediately and consult a doctor if brake fluid comes into contact with the eyes.
- If brake fluid spills on to your clothing, change the clothing.



Warning

Danger of accidents Brake fluid which is too old or of the wrong type impairs the function of the brake system.

- Make sure that brake fluid for the front and rear brake is changed in accordance with the service schedule. (Your authorized KTM workshop will be glad to help.)
- Make sure that only clean, approved brake fluid from a tightly sealed container is used. (Your authorized KTM workshop will be glad to help.)



Note

Environmental hazard Hazardous substances cause environmental damage.

- Dispose of oils, grease, filters, fuel, cleaning agents, brake fluid, etc., correctly and in compliance with the applicable regulations.



Info

Avoid contact between brake fluid and painted parts. Brake fluid corrodes paint.

Preparatory work

- Check that the brake linings of the rear brake are secured. (📖 p. 79)

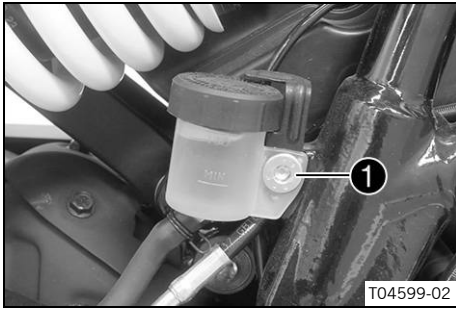

Condition

The screw cap is locked.

- Remove screw ① and take off the screw cap lock.

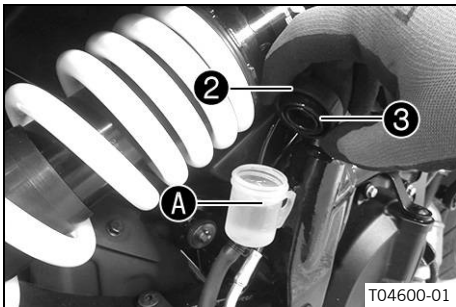

- Stand the vehicle upright.
- Remove screw cap ② with membrane ③.
- Add brake fluid up to the marking A.

Brake fluid DOT 4 / DOT 5.1 (📖 p. 123)

- Mount the screw cover with the membrane.

i Info
Use water to immediately clean up any brake fluid that has overflowed or spilled.

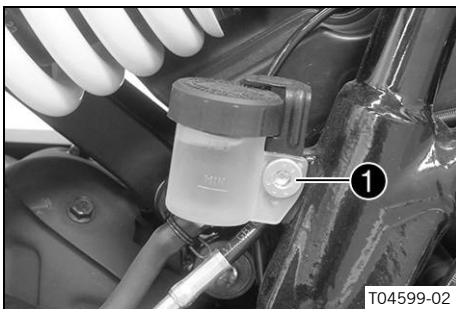

Condition

The screw cap is locked.

- Position the screw cap lock and mount and tighten screw ①.

Guideline

Screw, compensating tank cap lock, rear brake	M6	7 Nm (5.2 lbf ft)
---	----	-------------------

13.9 Checking that the brake linings of the rear brake are secured

Warning
Danger of accidents Worn-out brake linings reduce the braking effect.
- Ensure that worn-out brake linings are replaced immediately. (Your authorized KTM workshop will be glad to help.)

Warning
Danger of accidents Damaged brake discs reduce the braking effect.
If the brake linings are not changed in time, the brake lining carriers grind against the brake disc. As a consequence, the braking effect is greatly reduced and the brake discs are destroyed.
- Check the brake linings regularly.

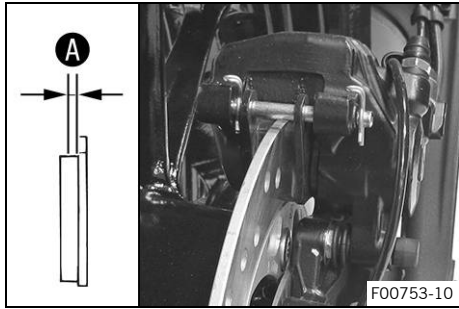

- Check the brake linings for lining thickness **A**.

Minimum thickness A	$\geq 1 \text{ mm } (\geq 0.04 \text{ in})$
----------------------------	---

- » If it is less than the minimum thickness:
 - Change the rear brake linings. 🛠️
- Check the brake linings for damage and cracking.
 - » If there is damage or cracking:
 - Change the rear brake linings. 🛠️
- Check that the brake linings are secured.
 - » If the brake linings are not secured correctly:
 - Secure brake linings, replace with new parts if necessary.

14.1 Removing the front wheel ↘

Preparatory work

- Raise the motorcycle with the rear lifting gear. (📖 p. 64)
- Lift the motorcycle with the front lifting gear. (📖 p. 64)

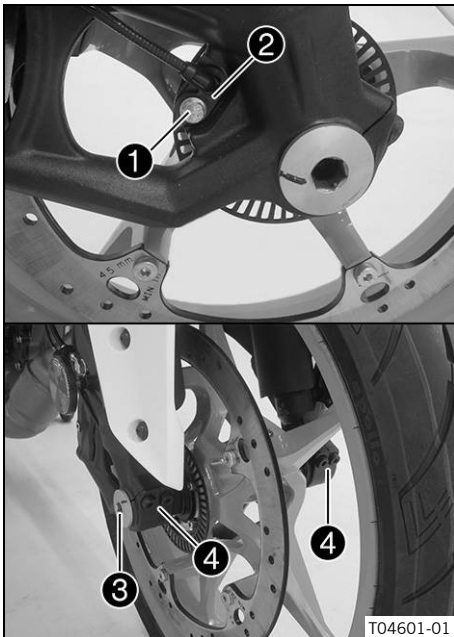

Main work

- Remove screw ① and pull wheel speed sensor ② out of the hole.
- Loosen screw ③ by several rotations.
- Loosen screws ④.
- Press on screw ③ to push the wheel spindle out of the axle clamp.
- Remove screw ③.



Warning

Danger of accidents Damaged brake discs reduce the braking effect.

- Always lay the wheel down in such a way that the brake disc is not damaged.

- Hold front wheel and remove wheel spindle. Take the front wheel out of the fork.



Info

Do not actuate the hand brake lever when the front wheel is removed.

14.2 Installing the front wheel ↘



Warning

Danger of accidents Oil or grease on the brake discs reduces the braking effect.

- Always keep the brake discs free of oil and grease.
- Clean the brake discs with brake cleaner when necessary.

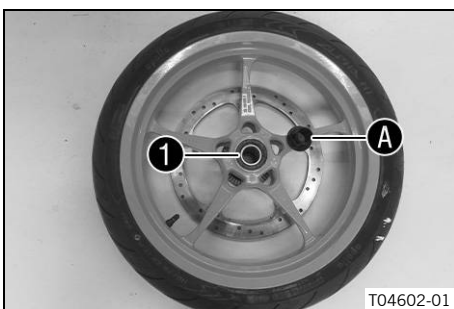

- Check the wheel bearing for damage and wear.
 - » If the wheel bearing is damaged or worn:
 - Change front wheel bearing. ↘
- Remove the spacers.
- Clean and grease shaft seal rings ① and contact surfaces A of the spacers.

Long-life grease (📖 p. 125)

- Insert the spacers.

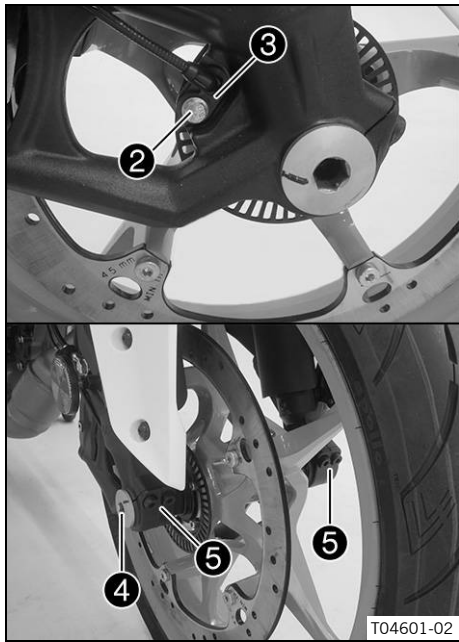

- Clean the thread of the wheel spindle and screw ②.
- Clean and grease wheel spindle.

Long-life grease (📖 p. 125)

- Position the front wheel and insert the wheel spindle.
 - ✓ The brake linings are correctly positioned.
- Mount and tighten screw ④.

Guideline

Screw, wheel spindle, front	M24	45 Nm (33.2 lbf ft)
-----------------------------	-----	---------------------

- Position wheel speed sensor ③ in the hole.
- Mount and tighten screw ②.

Guideline

Screw, wheel speed sensor holder	M6	9 Nm (6.6 lbf ft)
----------------------------------	----	-------------------

- Operate the hand brake lever repeatedly until the brake linings are in contact with the brake disc and there is a pressure point.
- Take the motorcycle off the front lifting gear. (📖 p. 65)
- Remove the rear of the motorcycle from the lifting gear. (📖 p. 64)
- Operate the front brake and compress the fork a few times firmly.
 - ✓ The fork legs straighten.
- Tighten screws ⑤.

Guideline

Screw, fork shoe	M8	16 Nm (11.8 lbf ft)
------------------	----	---------------------

14.3 Removing the rear wheel ↩

Preparatory work

- Raise the motorcycle with the rear lifting gear. (📖 p. 64)

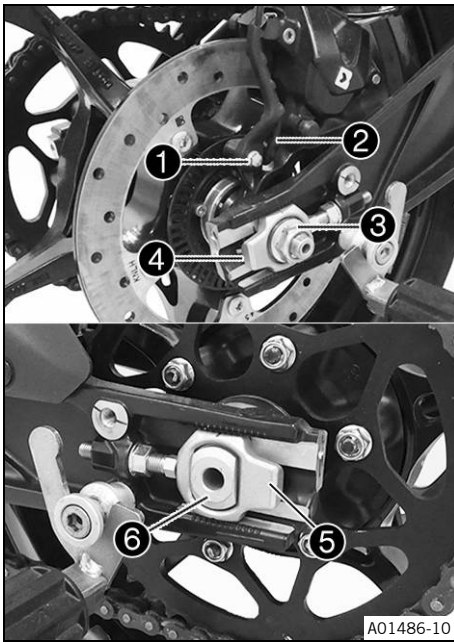

Main work

- Remove screw ① and pull wheel speed sensor ② out of the hole.
- Remove nut ③ and washer.
- Take off chain adjuster ④.
- Holding the rear wheel, withdraw wheel spindle ⑥ with the washer and chain adjuster ⑤.
- Push the rear wheel forward as far as possible and take the chain off the rear sprocket.
- Carefully push the brake caliper support to the side, do not damage the brake line.



Warning

Danger of accidents Damaged brake discs reduce the braking effect.

- Always lay the wheel down in such a way that the brake disc is not damaged.

- Pull the rear wheel back and take it out of the link fork.



Info

Do not operate the foot brake lever when the rear wheel is removed.



14.4 Installing the rear wheel



Warning

Danger of accidents Oil or grease on the brake discs reduces the braking effect.

- Always keep the brake discs free of oil and grease.
- Clean the brake discs with brake cleaner when necessary.



Warning

Danger of accidents There is no braking effect to start with at the rear brake after installing the rear wheel.

- Actuate the foot brake several times before going on a ride until you can feel a firm pressure point.

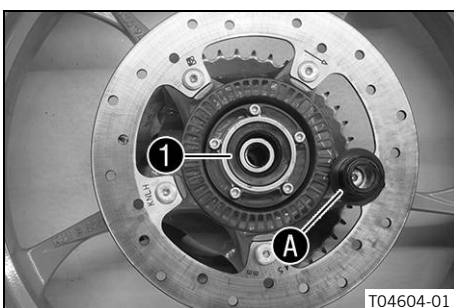

Main work

- Check the wheel bearing for damage and wear.
 - » If the wheel bearing is damaged or worn:
 - Change the rear wheel bearing. 🛠️
- Clean and grease shaft seal rings ① and contact surfaces A of the spacers.

Long-life grease (📖 p. 125)

- Clean the thread of the wheel spindle and axle nut.
- Clean and grease wheel spindle.

Long-life grease (📖 p. 125)

- Clean the contact areas on the brake caliper bracket and link fork.

- Mount the damping rubber and rear sprocket carrier on the rear wheel.
- Position the rear wheel.
 - ✓ Brake pads and brake caliper supports are correctly positioned.
- Push the rear wheel forward as far as possible and lay the chain on the rear sprocket.
- Pull the rear wheel back and mount wheel spindle ③ with the washer and chain adjuster ④.

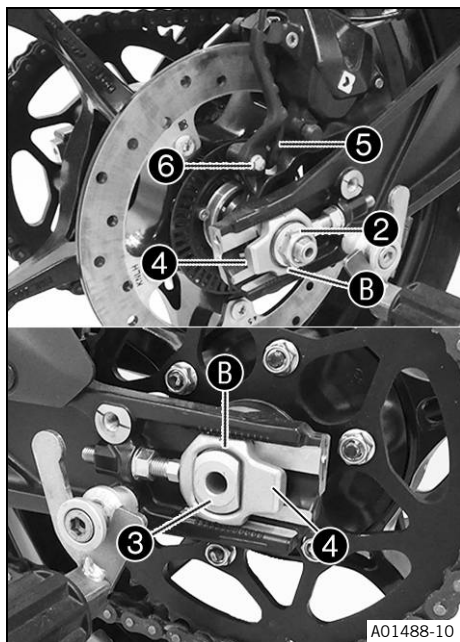

Guideline

Mount left and right chain adjusters ④ in the same position.

- Mount nut ② and the washer.
- Push the rear wheel forward so that the chain adjusters are in contact with the screws, and tighten nut ②.

Guideline

In order for the rear wheel to be correctly aligned, the markings on the left and right chain adjusters must be in the same position relative to reference markings B.

Nut, rear wheel spindle	M16	100 Nm (73.8 lbf ft)
-------------------------	-----	----------------------

- Position wheel speed sensor ⑤ in the hole.
- Mount and tighten screw ⑥.

Guideline

Screw, wheel speed sensor holder	M6	9 Nm (6.6 lbf ft)
----------------------------------	----	-------------------

Finishing work

- Remove the rear of the motorcycle from the lifting gear. (📖 p. 64)
- Check the chain tension. (📖 p. 68)

14.5 Checking the rear hub damping rubber pieces 🛠️

i Info

The engine power is transmitted from the rear sprocket to the rear wheel via the six damping rubber pieces. They eventually wear out during operation. If the damping rubber pieces are not changed in time, the rear sprocket carrier and the rear hub will be damaged.

Preparatory work

- Raise the motorcycle with the rear lifting gear. (📖 p. 64)
- Remove the rear wheel. 🛠️ (📖 p. 82)

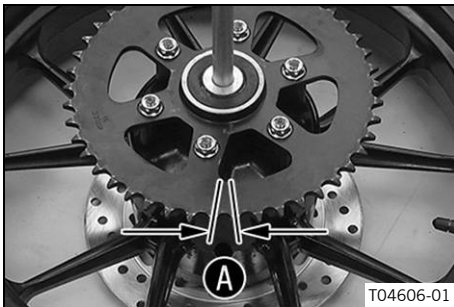
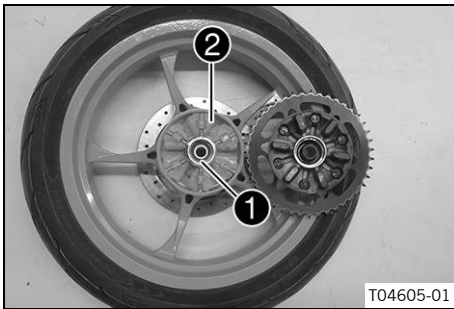

Main work

- Check bearing ①.
 - » If the bearing is damaged or worn:
 - Change the bearing. 🛠️
- Check damping rubber pieces ② of the rear hub for damage and wear.
 - » If the damping rubber pieces of the rear hub are damaged or worn:
 - Change all the damping rubber pieces of the rear hub.
- Lay the rear wheel on a workbench with the rear sprocket facing upward and insert the wheel spindle in the hub.
- To check play A, hold the rear wheel tight and try to rotate the rear sprocket.



Info

Measure the play on the outside of the rear sprocket.

Play of damping rubber pieces on rear wheel	≤ 5 mm (≤ 0.2 in)
---	-------------------

- » If clearance A is larger than the specified value:
 - Change all the damping rubber pieces of the rear hub.

Finishing work

- Install the rear wheel. 🛠️ (📖 p. 83)
- Remove the rear of the motorcycle from the lifting gear. (📖 p. 64)
- Check the chain tension. (📖 p. 68)



14.6 Checking the tire condition



Warning

Danger of accidents If a tire bursts while riding, the vehicle becomes uncontrollable.

- Ensure that damaged or worn tires are replaced immediately. (Your authorized KTM workshop will be glad to help.)



Warning

Danger of crashing Different tire tread patterns on the front and rear wheel impair the handling characteristic.

Different tire tread patterns can make the vehicle significantly more difficult to control.

- Make sure that only tires with a similar tire tread pattern are fitted to the front and rear wheel.



Warning

Danger of accidents Non-approved or non-recommended tires and wheels impact the handling characteristic.

- Only use tires/wheels approved by KTM with the corresponding speed index.



Info

The type, condition, and pressure of the tires all have a major impact on the handling characteristic of the motorcycle.

Worn tires have a negative effect on handling characteristics, especially on wet surfaces.

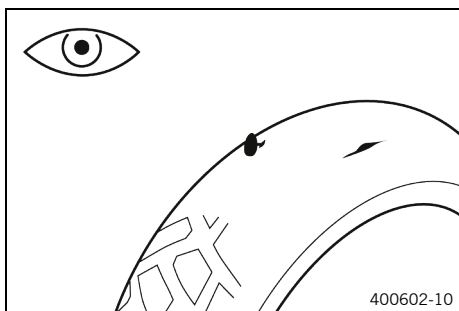

- Check the front and rear tires for cuts, run-in objects, and other damage.
 - » If the tires have cuts, run-in objects, or other damage:
 - Change the tires. 🛠️
- Check the tread depth.

i Info
Observe the minimum tread depth required by national law.

Minimum tread depth	≥ 2 mm (≥ 0.08 in)
---------------------	--------------------

- » If the tread depth is less than the minimum tread depth:
 - Change the tires. 🛠️
- Check the tire age.

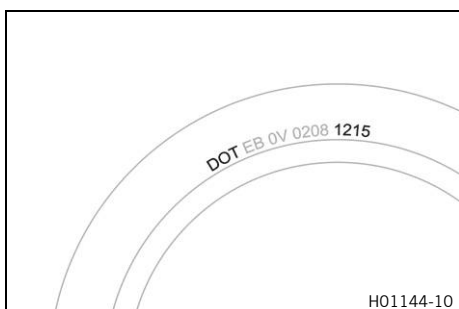

i Info
The tire date of manufacture is usually contained in the tire label and is indicated by the last four digits of the **DOT** number. The first two digits indicate the week of manufacture and the last two digits the year of manufacture.
KTM recommends that the tires be changed after 5 years at the latest, regardless of the actual state of wear.

- » If the tires are more than 5 years old:
 - Change the tires. 🛠️

14.7 Checking tire pressure

i Info
Low tire pressure leads to abnormal wear and overheating of the tire.
Correct tire pressure ensures optimal riding comfort and maximum tire service life.

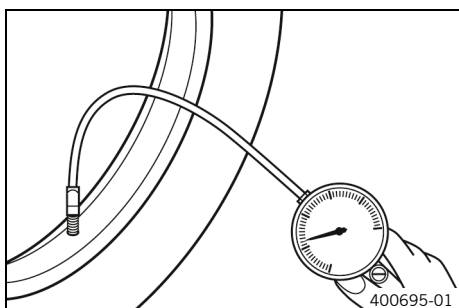

- Remove the protection cap.
- Check the tire pressure when the tires are cold.

Tire pressure when solo	
front	2.0 bar (29 psi)
Rear	2.0 bar (29 psi)

Tire pressure with passenger / full payload	
front	2.0 bar (29 psi)
rear	2.2 bar (32 psi)

- » If the tire pressure does not meet specifications:
 - Correct the tire pressure.
- Mount the protection cap.

15.1 Removing the 12-V battery ↗



Warning

Risk of injury Battery acid and battery gases cause serious chemical burns.

- Keep 12 V batteries out of the reach of children.
- Wear suitable protective clothing and safety glasses.
- Avoid contact with battery acid and battery gases.
- Keep sparks or open flames away from the 12 V battery.
- Only charge 12 V batteries in well-ventilated rooms.
- Rinse the affected area immediately with plenty of water in the event of contact with the skin.
- Rinse eyes with water for at least 15 minutes and consult a doctor immediately if battery acid and battery gases get into the eyes.

Preparatory work

- Remove the passenger seat. (📖 p. 66)
- Remove the front rider's seat. (📖 p. 67)

Main work

- Remove battery cover **A**.

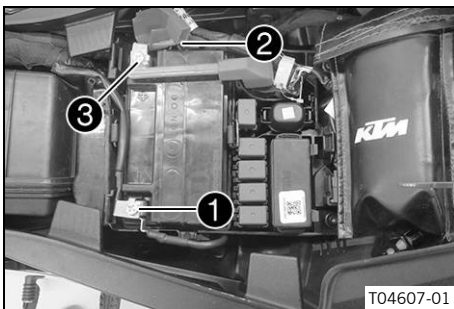
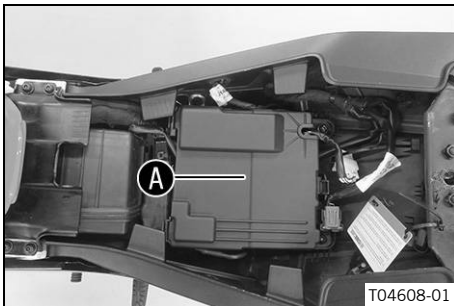

- Disconnect negative cable **1** from the 12-V battery.
- Pull back positive terminal cover **2**.
- Disconnect positive cable **3** from the 12-V battery.
- Pull the 12-V battery upwards and out of the battery compartment.



Info

Never operate the motorcycle with a discharged 12-V battery or without a 12-V battery. In both cases, electrical components and safety devices can be damaged. The vehicle will therefore no longer be roadworthy.

15.2 Installing the 12-V battery ↗

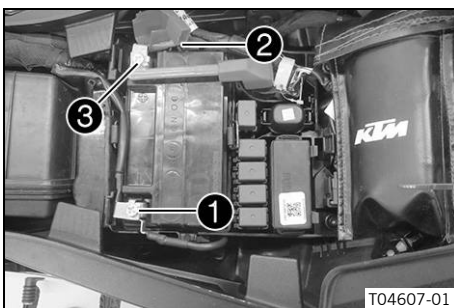

Main work

- Position the 12-V battery in the battery compartment.

12-V battery (ETZ-9-BS) (📖 p. 118)

- Position positive cable **2** and mount and tighten the screw.
- Position positive terminal cover **3**.
- Position negative cable **1** and mount and tighten the screw.

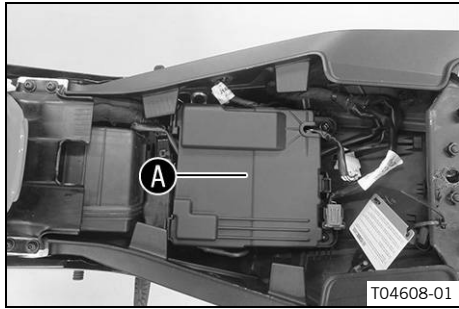

- Mount battery cover **A**.

Finishing work

- Mount the front rider's seat. (📖 p. 67)
- Mount the passenger seat. (📖 p. 66)
- Set time and date. (📖 p. 44)

15.3 Charging the 12-V battery ↗



Warning

Risk of injury Battery acid and battery gases cause serious chemical burns.

- Keep 12 V batteries out of the reach of children.
- Wear suitable protective clothing and safety glasses.
- Avoid contact with battery acid and battery gases.
- Keep sparks or open flames away from the 12 V battery.
- Only charge 12 V batteries in well-ventilated rooms.
- Rinse the affected area immediately with plenty of water in the event of contact with the skin.
- Rinse eyes with water for at least 15 minutes and consult a doctor immediately if battery acid and battery gases get into the eyes.



Note

Environmental hazard 12 V batteries contain environmentally hazardous materials.

- Do not dispose of 12 V batteries as household waste.
- Dispose of 12 V batteries at a collection point for used batteries.



Note

Environmental hazard Hazardous substances cause environmental damage.

- Dispose of oils, grease, filters, fuel, cleaning agents, brake fluid, etc., correctly and in compliance with the applicable regulations.



Info

Even when there is no load on the 12-V battery, it discharges steadily each day.

The charging level and the method of charging are very important for the service life of the 12-V battery. Rapid recharging with a high charging current shortens the service life of the battery.

If the charging current, charging voltage, or charging time is exceeded, electrolyte escapes through the safety valves. This reduces the capacity of the 12-V battery.

If the 12-V battery is discharged by repeated starting, charge the 12-V battery immediately.

If the 12-V battery is left in a discharged state for an extended period, it will become deeply discharged and sulfating occurs, destroying the battery.

The 12-V battery is maintenance-free. The acid level does not have to be checked.

Preparatory work

- Remove the passenger seat. (📖 p. 66)
- Remove the front rider's seat. (📖 p. 67)

- Disconnect the negative cable of the 12-V battery to avoid damage to the onboard electronics.

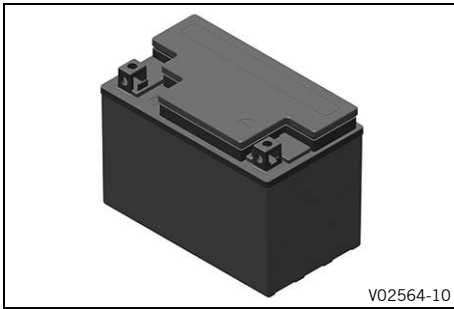

Main work

- Connect a battery charger to the 12-V battery. Connect the battery charger to the mains connection.

Battery charger (58429074200)

It is impossible to overcharge the 12-V battery using this battery charger.

This battery charger is not suitable for lithium-ion batteries.



Info

Charge the 12-V battery to a maximum of 10 % of the capacity specified on the battery housing.

- Switch off the battery charger after charging and disconnect from the 12-V battery.

Guideline

The charging current, charging voltage, and charging time must not be exceeded.

Recharge the 12-V battery regularly when the motorcycle is not being used	3 months
---	----------

- Position the negative cable and mount and tighten the screw.
- Position the negative terminal cover.

Finishing work

- Mount the front rider's seat. (🔧 p. 67)
- Mount the passenger seat. (🔧 p. 66)
- Set time and date. (🔧 p. 44)



15.4 Changing the main fuse



Warning

Fire hazard Incorrect fuses overload the electrical system.

- Only use fuses with the required ampere value.
- Do not bypass or repair fuses.



Info

The main fuse protects all electrical power consumers of the vehicle. The main fuse is under the seat.

Preparatory work

- Remove the passenger seat. (🔧 p. 66)
- Remove the front rider's seat. (🔧 p. 67)

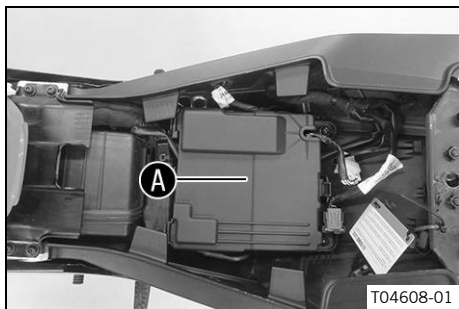

Main work

- Remove battery cover **A**.

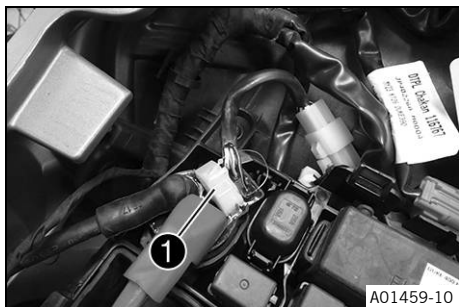

- Remove protection cap **1**.

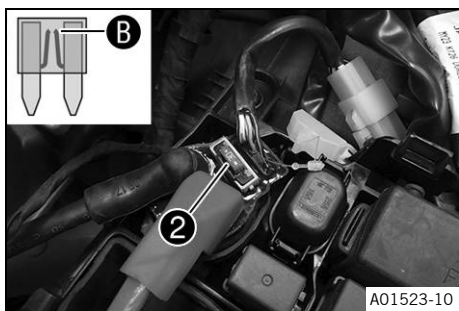

- Remove faulty main fuse **2**.



Info

A faulty fuse has a burned-out fuse wire **B**.
A spare fuse is located in the fuse box.

- Insert a new main fuse.

Fuse (75011088030) (📖 p. 118)



Tip

Put a spare fuse in the fuse box so that it is available if needed.

- Mount protection cap **1**.

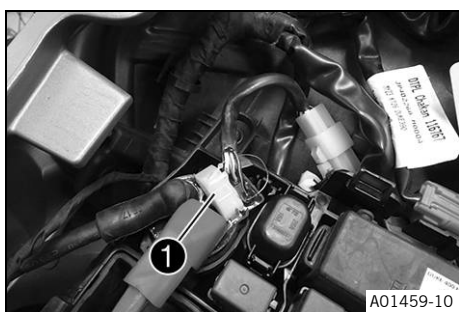

- Mount battery cover **A**.

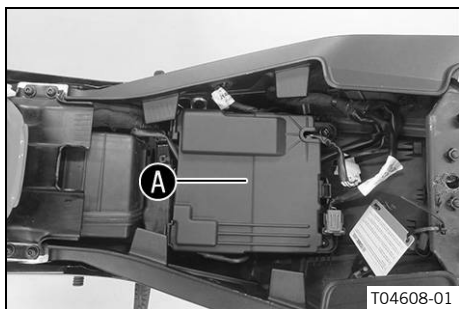

Finishing work

- Mount the front rider's seat. (📖 p. 67)
- Mount the passenger seat. (📖 p. 66)
- Set time and date. (📖 p. 44)

**15.5 Changing the ABS fuses****Warning**

Fire hazard Incorrect fuses overload the electrical system.

- Only use fuses with the required ampere value.
- Do not bypass or repair fuses.

**Info**

Two fuses for the ABS are located under the passenger seat. These fuses protect the return pump and the hydraulic unit of the ABS. The third fuse, which protects the ABS control unit, is located in the fuse box.

Preparatory work

- Remove the passenger seat. (📖 p. 66)
- Remove the front rider's seat. (📖 p. 67)

Main work

- Remove battery cover **A**.

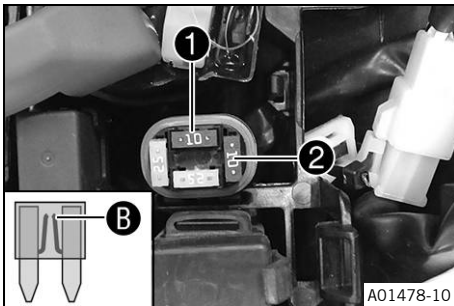
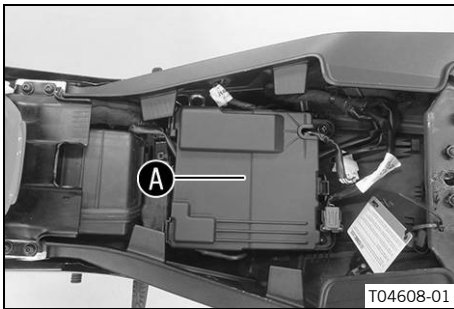
**To change the fuse of the ABS hydraulic unit:**

- Take off the protection cap and remove fuse **1**.

**Info**

A faulty fuse has a burned-out fuse wire **B**.

**Warning**

Fire hazard Incorrect fuses overload the electrical system.

- Only use fuses with the required ampere value.
- Do not bypass or repair fuses.

- Insert the spare fuse with the correct rating.

Fuse (75011088010) (📖 p. 118)

**Tip**

Insert spare fuse **2** in the fuse box so that it is available if needed.

- Mount the protection cap.

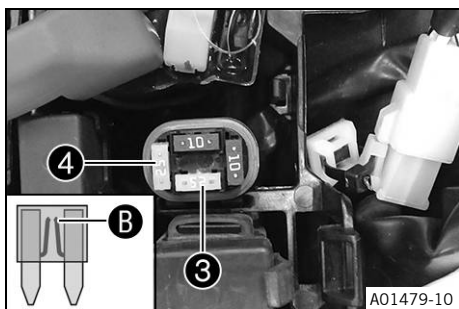

To change the fuse of the ABS return pump:

- Take off the protection cap and remove fuse **3**.

i Info
A faulty fuse has a burned-out fuse wire **B**.

! Warning
Fire hazard Incorrect fuses overload the electrical system.

- Only use fuses with the required ampere value.
- Do not bypass or repair fuses.

- Insert the spare fuse with the correct rating.

Fuse (75011088020) (📖 p. 118)

i Tip
Insert spare fuse **4** in the fuse box so that it is available if needed.

- Mount the protection cap.
- Mount battery cover **A**.

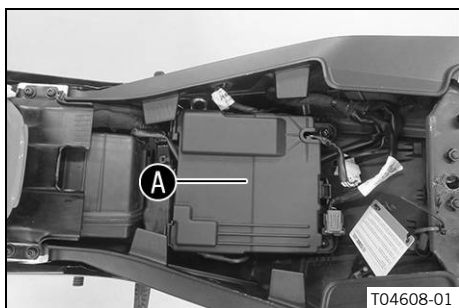

Finishing work

- Mount the front rider's seat. (📖 p. 67)
- Mount the passenger seat. (📖 p. 66)

15.6 Changing the fuses of individual electrical power consumers

i Info
The fuse box with the main fuse and the fuses of the individual electrical power consumers is located under the passenger seat.

Preparatory work

- Remove the passenger seat. (📖 p. 66)
- Remove the front rider's seat. (📖 p. 67)

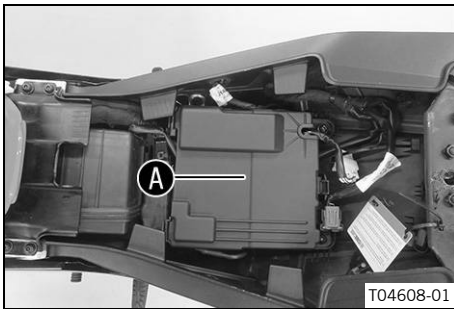

Main work

- Remove battery cover **A**.

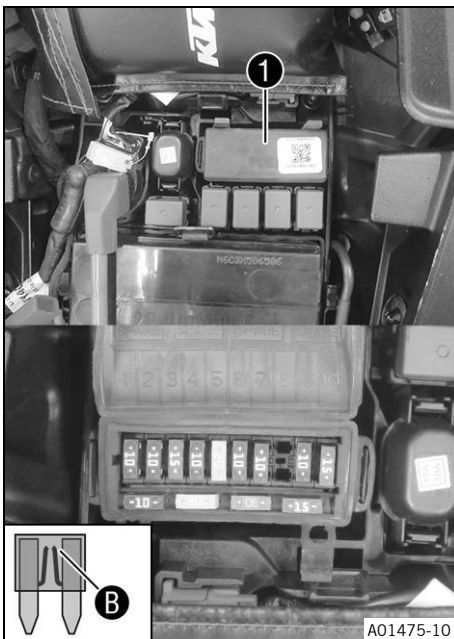

- Open fuse box cover **1**.
- Remove the faulty fuse.

Guideline

Fuse 1 - 10 A - combination instrument, brake light, high beam, tail light
Fuse 2 - 10 A - combination instrument
Fuse 3 - 15 A - power relay
Fuse 4 - 10 A - start auxiliary relay, horn
Fuse 5 - 20 A - radiator fan
Fuse 6 - 10 A - headlight unit, parking light, license plate lamp
Fuse 7 - 10 A - engine control unit, ABS control unit, Connectivity Unit
Fuse 8 - not assigned
Fuse 9 - 10 A - permanent positive for accessories (ACC1)
Fuse 10 - 10 A - ignition positive for accessories (ACC2), USB
Fuse SPARE - 10 A/15 A/20 A/30 A - spare fuses



Info

A faulty fuse has a burned-out fuse wire **B**.



Warning

Fire hazard Incorrect fuses overload the electrical system.

- Only use fuses with the required ampere value.
- Do not bypass or repair fuses.

- Insert the spare fuse with the correct rating.

Fuse (75011088010) (📖 p. 118)
Fuse (75011088015) (📖 p. 118)
Fuse (75011088020) (📖 p. 118)
Fuse (75011088030) (📖 p. 118)



Tip

Put a spare fuse in the fuse box so that it is available if needed.

- Check the function of the electrical power consumer.
- Close the fuse box cover **1**.

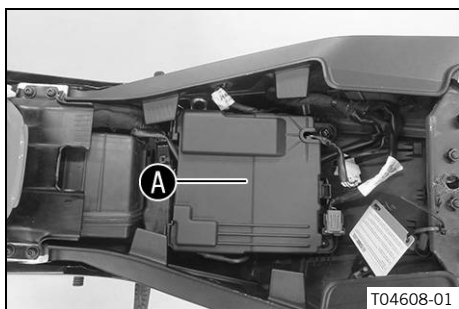

- Mount battery cover **A**.

Finishing work

- Mount the front rider's seat. (📖 p. 67)
- Mount the passenger seat. (📖 p. 66)

15.7 Checking the headlight setting

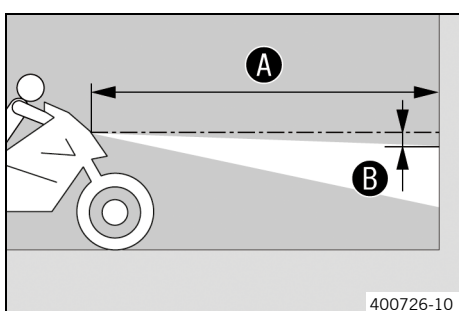

- Park the vehicle on a horizontal surface in front of a light-colored wall and make a mark at the height of the center of the low beam headlight.
- Make another mark at a distance **B** under the first marking.
Guideline

Distance B	5 cm (2 in)
-------------------	-------------

- Position the vehicle vertical to the wall at distance **A** from the wall and switch on the low beam.

Guideline

Distance A	5 m (16 ft)
-------------------	-------------

- The rider now mounts the motorcycle with luggage and passenger if applicable.
- Check the headlight setting.

The light-dark boundary must be exactly on the lower marking when the motorcycle is ready to be operated with the rider mounted along with any luggage and a passenger if applicable.

- » If the boundary between light and dark does not meet specifications:
 - Adjust the headlight range. (📖 p. 94)

15.8 Adjusting the headlight range

Preparatory work

- Check the headlight setting. (📖 p. 94)

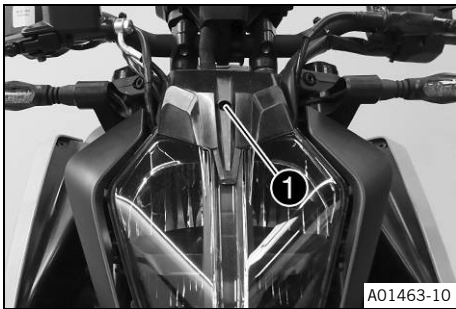

Main work

- Turn adjusting screw 1 to adjust the headlight range.



Info

Turn clockwise to increase the headlight range; turn counterclockwise to reduce the headlight range. If you have a payload, you may have to correct the headlight range.

Screw 1 also secures the headlight. Ensure the screw is always screwed in far enough.

- Set the headlight to marking B.

Guideline

The light-dark boundary must lie exactly on lower marking B when the motorcycle is ready to operate with the rider mounted along with any luggage and a passenger if applicable.

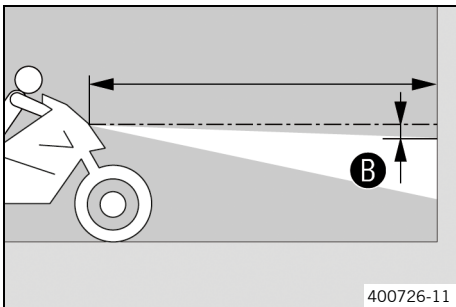

15.9 Diagnostics connector

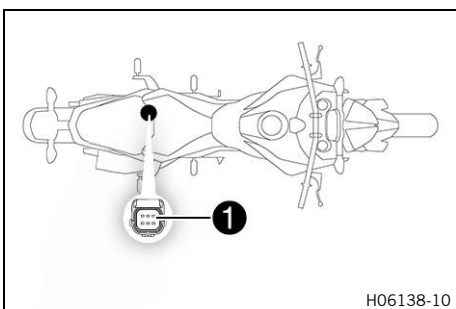

Diagnostics connector 1 is located under the passenger seat.

15.10 Front ACC1 and ACC2

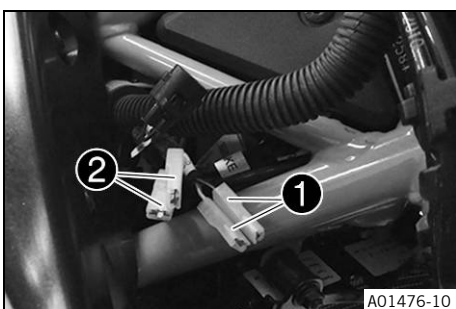

Installation location

- The ACC1 1 and ACC2 2 power supplies are located on the right of the vehicle at the front, behind the steering head cover.

15.11 Rear ACC1 and ACC2

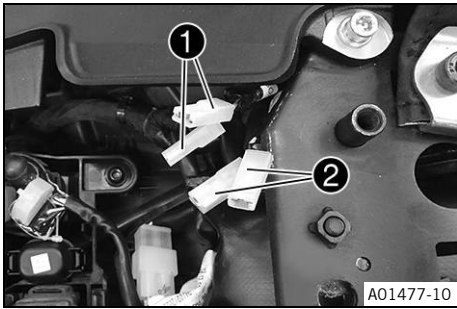

Installation location

- The ACC1 ① and ACC2 ② power supplies are located at the rear below the seat.

16.1 Cooling system

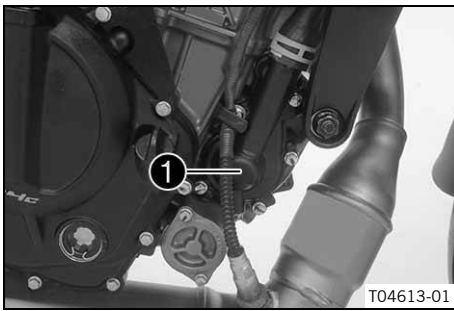

Water pump ① in the engine ensures forced circulation of the coolant.

The pressure resulting from the warming of the cooling system is regulated by a valve in radiator cap ②. Heat expansion causes excess coolant to flow into compensating tank ③. When the temperature falls, this surplus coolant is sucked back into the cooling system. This ensures that operating the vehicle at the specified coolant temperature will not result in a risk of malfunctions.

110 °C (230 °F)

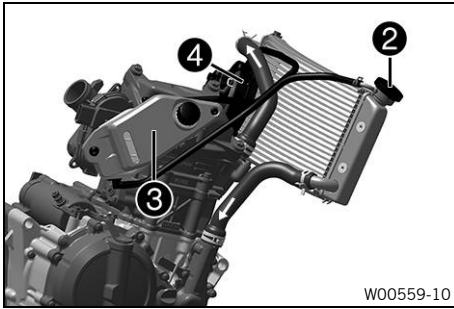

The coolant is cooled by the air stream and a radiator fan ④, which is activated at high temperature.

The lower the speed, the less the cooling effect. Dirty cooling fins also reduce the cooling effect.

i Info

If the cooling system overheats, the maximum engine speed is limited.

16.2 Checking the antifreeze and coolant level



Warning

Danger of scalding During motorcycle operation, the coolant gets hot and is under pressure.

- Do not open the radiator, the radiator hoses or other cooling system components if the engine or the cooling system are at operating temperature.
- Allow the cooling system and the engine to cool down before you open the radiator, the radiator hoses or other components of the cooling system.
- In the event of scalding, rinse the area affected immediately with lukewarm water.



Warning

Danger of poisoning Coolant is harmful to health.

- Keep coolant out of the reach of children.
- Do not allow coolant to come into contact with the skin, the eyes and clothing.
- Consult a doctor immediately if coolant is swallowed.
- Rinse the affected area immediately with plenty of water in the event of contact with the skin.
- Rinse eyes thoroughly with water and consult a doctor immediately if coolant gets into the eyes.
- Change clothing if coolant spills onto your clothing.

Condition

The engine is cold.

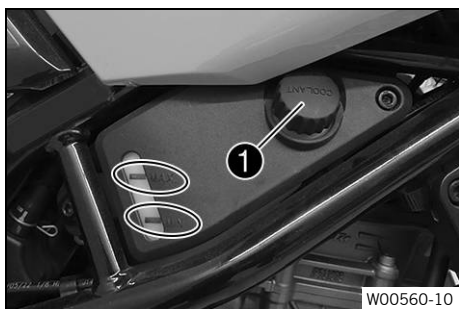

- Stand the motorcycle upright on a horizontal surface.
- Remove cap ① of the compensating tank.
- Check the antifreeze in the coolant.

-25 ... -45 °C (-13 ... -49 °F)

- » If the antifreeze in the coolant does not match the specified value:

- Correct the antifreeze in the coolant.

- Check the coolant level in the compensating tank.

The coolant level must be between the two markings.

- » If the coolant level does not match the specified value:

- Correct the coolant level.

Coolant (📖 p. 123)

- Mount the cap of the compensating tank.

- Remove radiator cap ②.

- Check the antifreeze in the coolant.

-25 ... -45 °C (-13 ... -49 °F)

- » If the antifreeze in the coolant does not match the specified value:

- Correct the antifreeze in the coolant.

- Check the coolant level in the radiator.

The radiator must be filled completely.

- » If the coolant level does not match the specified value:

- Check the coolant level and the reason for the loss.

Coolant (📖 p. 123)

- » If you had to add more coolant than the specified amount:
> 0.20 l (> 0.21 qt.)

- Fill/bleed the cooling system. 🛠️ (📖 p. 100)

- Mount the radiator cap.

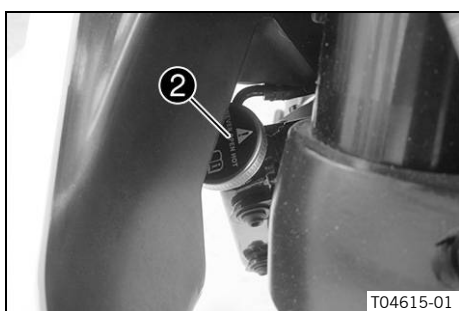

16.3 Checking the coolant level



Warning

Danger of scalding During motorcycle operation, the coolant gets hot and is under pressure.

- Do not open the radiator, the radiator hoses or other cooling system components if the engine or the cooling system are at operating temperature.
- Allow the cooling system and the engine to cool down before you open the radiator, the radiator hoses or other components of the cooling system.
- In the event of scalding, rinse the area affected immediately with lukewarm water.



Warning

Danger of poisoning Coolant is harmful to health.

- Keep coolant out of the reach of children.
- Do not allow coolant to come into contact with the skin, the eyes and clothing.
- Consult a doctor immediately if coolant is swallowed.
- Rinse the affected area immediately with plenty of water in the event of contact with the skin.
- Rinse eyes thoroughly with water and consult a doctor immediately if coolant gets into the eyes.
- Change clothing if coolant spills onto your clothing.

Condition

The engine is cold.

- Stand the motorcycle upright on a horizontal surface.
- Check the coolant level in compensating tank ①.

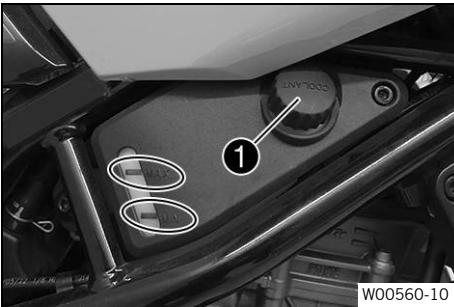

The coolant level must be between the two markings.

- » If the coolant level does not match the specified value:
 - Correct the coolant level.

Coolant (📖 p. 123)

- Remove radiator cap ② and check the coolant level in the radiator.



The radiator must be filled completely.

- » If the coolant level does not match the specified value:
 - Check the coolant level and the reason for the loss.
- » If you had to add more coolant than the specified amount:
 - > 0.20 l (> 0.21 qt.)
 - Fill/bleed the cooling system. 🛠️ (📖 p. 100)

- Mount the radiator cap.



16.4 Draining the coolant 🛠️



Warning

Danger of scalding During motorcycle operation, the coolant gets hot and is under pressure.

- Do not open the radiator, the radiator hoses or other cooling system components if the engine or the cooling system are at operating temperature.
- Allow the cooling system and the engine to cool down before you open the radiator, the radiator hoses or other components of the cooling system.
- In the event of scalding, rinse the area affected immediately with lukewarm water.



Warning

Danger of poisoning Coolant is harmful to health.

- Keep coolant out of the reach of children.
- Do not allow coolant to come into contact with the skin, the eyes and clothing.
- Consult a doctor immediately if coolant is swallowed.
- Rinse the affected area immediately with plenty of water in the event of contact with the skin.
- Rinse eyes thoroughly with water and consult a doctor immediately if coolant gets into the eyes.
- Change clothing if coolant spills onto your clothing.

Condition

The engine is cold.

- Position the motorcycle upright.
- Position an appropriate container under the engine.
- Remove screw ❶ with the seal ring.
- Remove the radiator cap.
- Completely drain the coolant.
- Mount and tighten screw ❶ with a new seal ring.

Guideline

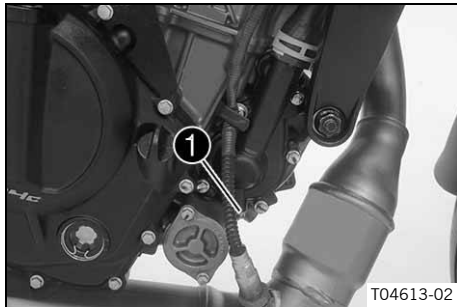

T04613-02

Screw plug, water pump drain hole	M6	11 Nm (8.1 lbf ft) Loctite®243™
---	----	---

16.5 Filling/bleeding the cooling system ↻



Warning

Danger of poisoning Coolant is harmful to health.

- Keep coolant out of the reach of children.
- Do not allow coolant to come into contact with the skin, the eyes and clothing.
- Consult a doctor immediately if coolant is swallowed.
- Rinse the affected area immediately with plenty of water in the event of contact with the skin.
- Rinse eyes thoroughly with water and consult a doctor immediately if coolant gets into the eyes.
- Change clothing if coolant spills onto your clothing.

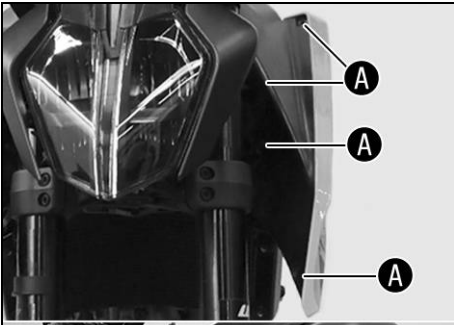

- Remove screws **A** on the left fuel tank cover. Slide tank cover forward and remove it.

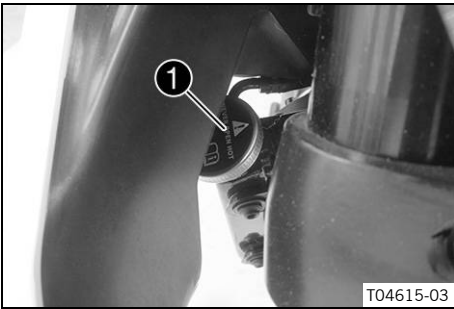
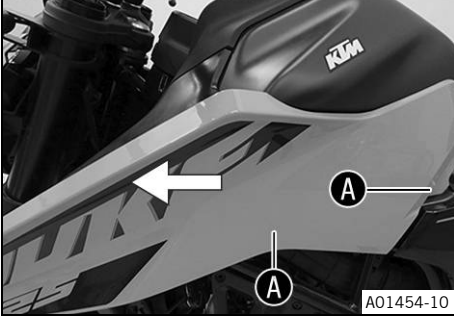

- Remove radiator cap **1**.

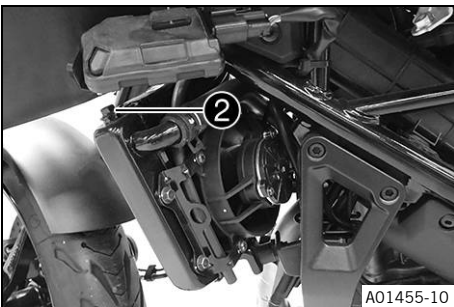

- Loosen bleeder screw **2**.

Guideline

3 turns

- Tilt the vehicle slightly to the right.
- Pour in the coolant until it emerges without bubbles at the bleeder screw, and then mount and tighten the bleeder screw immediately.

Coolant (📖 p. 123)

- Completely fill the radiator with coolant. Mount the radiator cap.
- Rest the vehicle on the side stand.



Danger

Danger of poisoning Exhaust gases are toxic and inhaling them may result in unconsciousness and death.

- Always make sure there is sufficient ventilation when running the engine.
- Use effective exhaust extraction when starting or running the engine in an enclosed space.

- Start the engine and allow it to warm up.

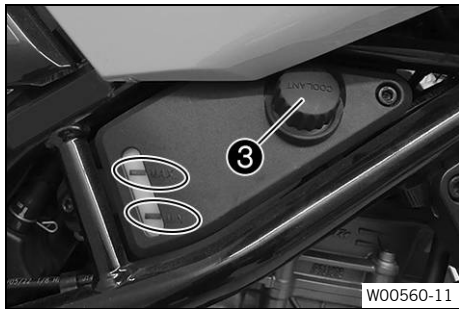

- Stop the engine and allow it to cool down.
- When the engine is cool, check the coolant level in the radiator and, if necessary, add coolant.
- Remove cap **3** of the compensating tank and top up the coolant level up to the **MAX** marking.
- Mount the cap of the compensating tank.
- Install left tank cover in reverse order to removal.

16.6 Changing the coolant



Warning

Danger of scalding During motorcycle operation, the coolant gets hot and is under pressure.

- Do not open the radiator, the radiator hoses or other cooling system components if the engine or the cooling system are at operating temperature.
- Allow the cooling system and the engine to cool down before you open the radiator, the radiator hoses or other components of the cooling system.
- In the event of scalding, rinse the area affected immediately with lukewarm water.



Warning

Danger of poisoning Coolant is harmful to health.

- Keep coolant out of the reach of children.
- Do not allow coolant to come into contact with the skin, the eyes and clothing.
- Consult a doctor immediately if coolant is swallowed.
- Rinse the affected area immediately with plenty of water in the event of contact with the skin.
- Rinse eyes thoroughly with water and consult a doctor immediately if coolant gets into the eyes.
- Change clothing if coolant spills onto your clothing.

Condition

The engine is cold.

- Remove screws **A** on the left fuel tank cover. Slide tank cover forward and remove it.

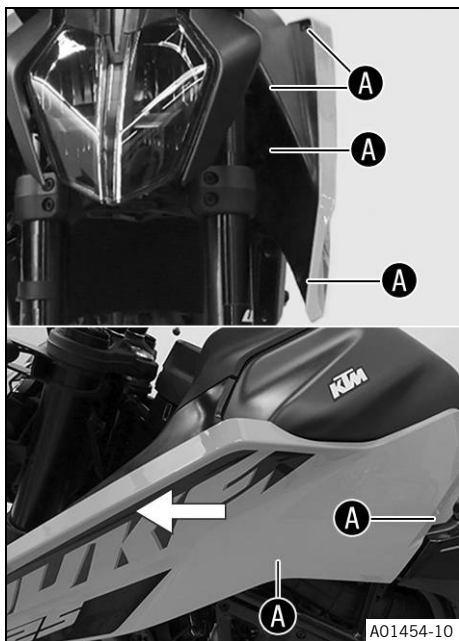

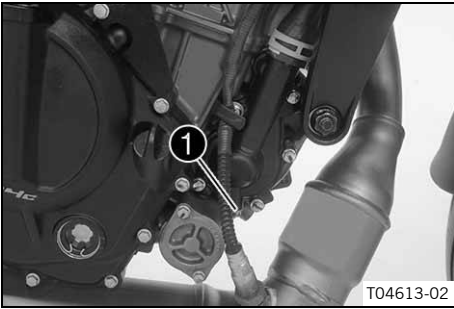

- Position the motorcycle upright.
- Position an appropriate container under the engine.
- Remove screw ① with the seal ring.



- Remove radiator cap ②.
- Completely drain the coolant.
- Mount and tighten screw ① with a new seal ring.

Guideline

Screw plug, water pump drain hole	M6	11 Nm (8.1 lbf ft) Loctite®243™
-----------------------------------	----	---

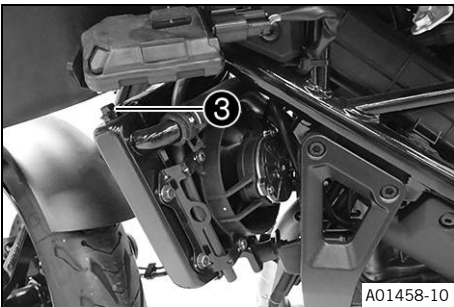

- Loosen bleeder screw ③.

Guideline

3 turns

- Tilt the vehicle slightly to the right.
- Pour in the coolant until it emerges without bubbles at the bleeder screw, and then mount and tighten the bleeder screw immediately.

Coolant (📖 p. 123)

- Completely fill the radiator with coolant. Mount the radiator cap.
- Rest the vehicle on the side stand.



Danger

Danger of poisoning Exhaust gases are toxic and inhaling them may result in unconsciousness and death.

- Always make sure there is sufficient ventilation when running the engine.
- Use effective exhaust extraction when starting or running the engine in an enclosed space.

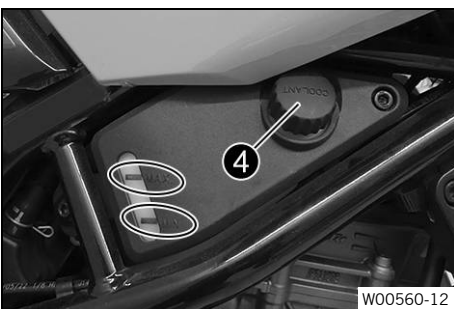

- Start the engine and allow it to warm up.
- Stop the engine and allow it to cool down.
- When the engine is cool, check the coolant level in the radiator and, if necessary, add coolant.
- Remove cap ④ of the compensating tank and top up the coolant level up to the **MAX** marking.
- Mount the cap of the compensating tank.
- Install left tank cover in reverse order to removal.



17.1 Ride Mode



Possible states

- **Street** – Homologated performance with balanced response.
- **Rain** – Homologated performance with soft response for better rideability.
- **Track** – Setting with homologated performance and balanced response.



Warning

Danger of accidents An incorrectly selected riding mode makes control of the vehicle considerably more difficult.

The riding modes are each only suitable for certain conditions.

- Always select a riding mode that suits the surface on which you are riding, the weather and the riding situation.

Various vehicle tunings can be selected in the combination instrument in the **Ride Mode** submenu. **Street**, **Rain**, and **Track** are available.

The last selected riding mode appears in the display.

The riding mode can also be changed while riding with the throttle grip closed.

18.1 Checking the engine oil level

Condition

The engine is at operating temperature.

Preparatory work

- Stand the motorcycle upright on a horizontal surface.

Main work

- Check the engine oil level.

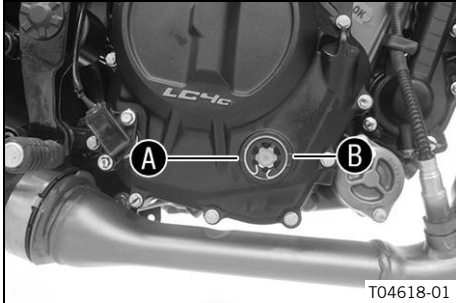

Info

After switching off the engine, wait one minute before checking the level.

The engine oil must be between the markings **A** and **B**.

- » If the engine oil is below the marking **A** :
 - Add engine oil. (📖 p. 107)
- » If the engine oil is above the marking **B** :
 - Correct the engine oil level.



18.2 Changing the engine oil and oil filter, cleaning the oil screen 🛠️



Warning

Danger of scalding Engine and gear oil get hot when the motorcycle is operated.

- Wear suitable protective clothing and safety gloves.
- In the event of scalding, rinse the area affected immediately with lukewarm water.



Note

Environmental hazard Hazardous substances cause environmental damage.

- Dispose of oils, grease, filters, fuel, cleaning agents, brake fluid, etc., correctly and in compliance with the applicable regulations.



Info

Drain the engine oil while the engine is at operating temperature.

Preparatory work

- Stand the motorcycle on a level surface using the side stand.

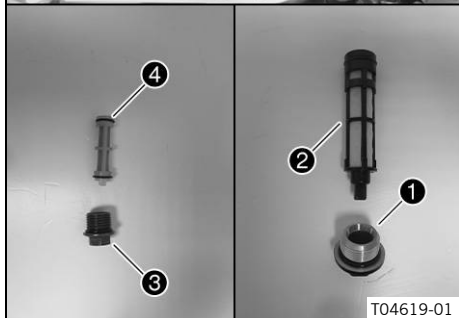
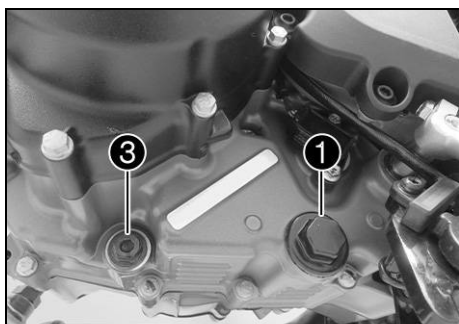

T04619-01

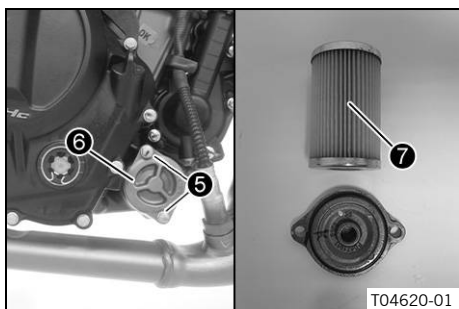

T04620-01

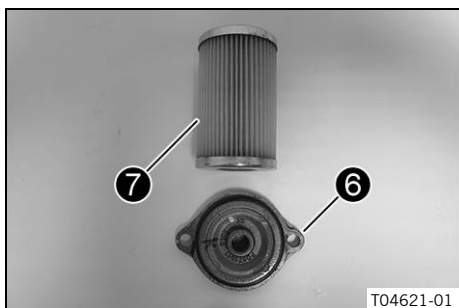

T04621-01

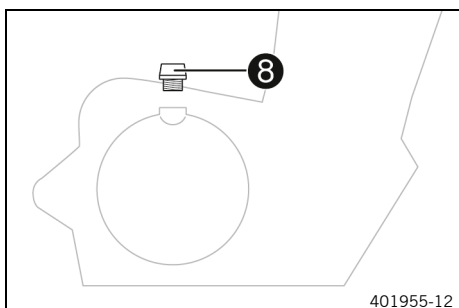

401955-12

Main work

- Place an appropriate container under the engine.
- Remove oil drain plug ① with the O-ring.
- Remove oil screen ② with the O-ring.
- Remove screw plug ③ with oil screen ④.
- Allow the engine oil to drain completely.
- Clean the oil drain plug and the oil screen thoroughly.
- Position oil screen ② and mount and tighten oil drain plug ① with the O-ring.

Guideline

Oil drain plug	M24x1.5	12.5 Nm (9.22 lbf ft)
----------------	---------	--------------------------

- Mount and tighten screw plug ③ with oil screen ④ and the O-ring.

Guideline

Oil drain plug	M24x1.5	12.5 Nm (9.22 lbf ft)
----------------	---------	--------------------------

- Remove screws ⑤. Take off oil filter cover ⑥ with the O-ring.
- Pull oil filter ⑦ out of the oil filter housing.
- Allow the engine oil to drain completely.
- Thoroughly clean the parts and the sealing surface.

- Insert oil filter ⑦.
- Oil the O-ring of the oil filter cover. Mount oil filter cover ⑥.
- Mount and tighten screws ⑤.

Guideline

Screw, oil filter cover	M6	9 Nm (6.6 lbf ft)
-------------------------	----	-------------------

i Info

Too little engine oil or poor-quality engine oil will result in premature wear of the engine.

- Remove filler plug ⑧ with the O-ring, and fill up with engine oil.

Engine oil	1.2 l (1.3 qt.)	Engine oil (SAE 15W/50) (p. 123)
------------	-----------------	--

- Mount and tighten the filler plug together with the O-ring.



Danger

Danger of poisoning Exhaust gases are toxic and inhaling them may result in unconsciousness and death.

- Always make sure there is sufficient ventilation when running the engine.
- Use effective exhaust extraction when starting or running the engine in an enclosed space.

- Start the engine and check it for leaks.

Finishing work

- Check the engine oil level. (📖 p. 105)



18.3 Adding engine oil



Info

Too little engine oil or poor-quality engine oil will result in premature wear of the engine.

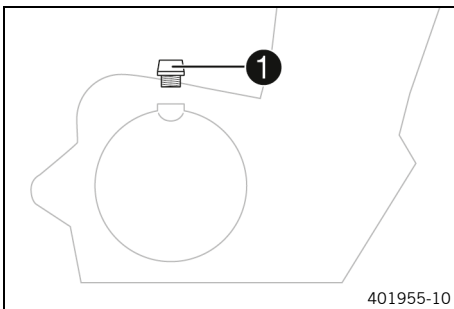

Main work

- Remove filler plug ① with the O-ring, and fill up with engine oil.

Engine oil (SAE 15W/50) (📖 p. 123)



Info

In order to achieve optimal engine oil performance, it is not advisable to mix different engine oils. KTM recommends changing the engine oil where necessary.

- Mount and tighten the filler plug together with the O-ring.



Danger

Danger of poisoning Exhaust gases are toxic and inhaling them may result in unconsciousness and death.

- Always make sure there is sufficient ventilation when running the engine.
- Use effective exhaust extraction when starting or running the engine in an enclosed space.

- Start the engine and check it for leaks.

Finishing work

- Check the engine oil level. (📖 p. 105)



19.1 Cleaning the motorcycle

Note

Material damage Components become damaged or destroyed if a pressure cleaner is used incorrectly.

The high pressure forces water into the electrical components, connectors, throttle cables, and bearings, etc. Pressure which is too high causes malfunctions and destroys components.

- Do not direct the water jet directly on to electrical components, connectors, throttle cables or bearings.
- Maintain a minimum distance between the nozzle of the pressure cleaner and the component.

Minimum clearance 60 cm (23.6 in)



Note

Environmental hazard Hazardous substances cause environmental damage.

- Dispose of oils, grease, filters, fuel, cleaning agents, brake fluid, etc., correctly and in compliance with the applicable regulations.



Info

Clean the motorcycle regularly to maintain its value and appearance over a long period. Avoid direct sunshine when cleaning the motorcycle.

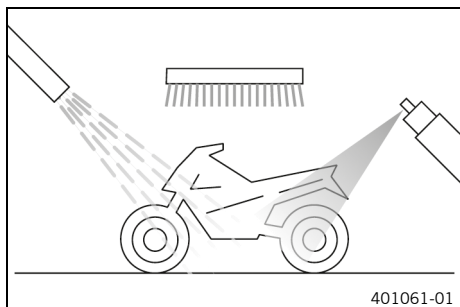

- Close off exhaust system to keep water from entering.
- Remove loose dirt first with a soft jet of water.
- Spray the heavily soiled parts with a normal commercial motorcycle cleaner and clean using a brush.

Motorcycle cleaner (🗉 p. 125)



Info

Use warm water containing normal motorcycle cleaner and a soft sponge.

Never apply motorcycle cleaner to a dry motorcycle; always rinse the vehicle with water first.

Clean the motorcycle with cold water if it has been used on salted roads. Warm water enhances the corrosive effects of salt.

- After rinsing the motorcycle with a gentle spray of water, allow it to dry thoroughly.
- Remove the closure of the exhaust system.



Warning

Danger of accidents Moisture and dirt impair the brake system.

- Brake carefully several times to dry out and remove dirt from the brake linings and the brake discs.

- After cleaning, ride the vehicle a short distance until the engine warms up.



Info

The heat produced causes water at inaccessible locations in the engine and on the brake system to evaporate.

- Push back the sleeves of the handlebar controls to allow any water that has penetrated to evaporate.
- After the motorcycle has cooled down, lubricate all moving parts and pivot points.
- Clean the chain. (📖 p. 67)
- Treat bare metal (except for brake discs and the exhaust system) with a corrosion inhibitor.

Preserving materials for paints, metal and rubber (📖 p. 125)

- Treat all painted parts with a mild paint care product.

Shine spray for paint, plastic and chromium (📖 p. 125)

i Info
Do not polish parts that were matte when delivered as this would strongly impair the material quality.

- Treat all plastic parts and powder-coated parts with a mild cleaning and care product.

Special cleaner for glossy and matte paint finishes, metal and plastic surfaces (📖 p. 125)

- Lubricate the ignition and steering lock.

Universal oil spray (📖 p. 125)



19.2 Checks and maintenance steps for winter operation

i Info
If you use the motorcycle in winter, you must expect salt on the roads. You should therefore take precautions against aggressive road salt.
Clean the motorcycle with cold water if it has been used on salted roads. Warm water enhances the corrosive effects of salt.

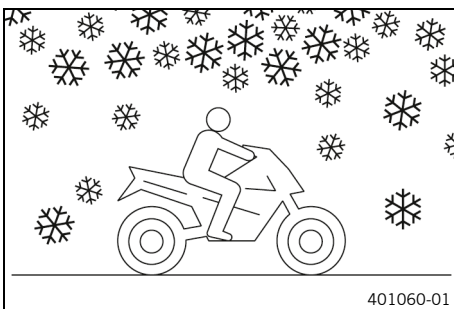

- Clean the motorcycle. (📖 p. 108)
- Clean the brakes.

i Info
After **EVERY** trip on salted roads, thoroughly clean the motorcycle and, in particular, the brake calipers and brake linings, after they have cooled down and without removing them, with cold water and dry carefully.

- Treat the engine, the link fork, and all other bare or zinc-plated parts (except the brake discs) with a wax-based corrosion inhibitor.

i Info
Corrosion inhibitor must not come in contact with the brake discs as this would greatly reduce the braking force.

- Clean the chain. (📖 p. 67)



20.1 Storage

i Info

If you plan to garage the motorcycle for a longer period, perform the following steps or have them performed.

Before storing the motorcycle, check all parts for function and wear. If service, repairs, or replacements are necessary, you should do this during the storage period (less workshop overload). In this way, you can avoid long workshop waiting times at the start of the new season.

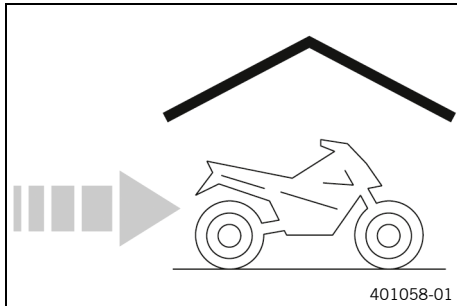

- When refueling for the last time before taking the motorcycle out of service, add fuel additive.

Fuel additive (📖 p. 125)

- Refuel. (📖 p. 58)

i Tip

Fill the fuel tank completely as specified, using fuel with the lowest possible ethanol content.

- Clean the motorcycle. (📖 p. 108)
- Change the engine oil and oil filter, clean the oil screen. 🛠️ (📖 p. 105)
- Check the antifreeze and coolant level. (📖 p. 97)
- Check tire pressure. (📖 p. 86)
- Remove the 12-V battery. 🛠️ (📖 p. 87)
- Charge the 12-V battery. 🛠️ (📖 p. 88)

Guideline

Storage temperature of the 12-V battery without direct sunlight	0 ... 35 °C (32 ... 95 °F)
---	----------------------------

- Store the vehicle in a dry location that is not subject to large fluctuations in temperature.

i Info

KTM recommends jacking up the motorcycle.

- Raise the motorcycle with the rear lifting gear. (📖 p. 64)
- Lift the motorcycle with the front lifting gear. (📖 p. 64)
- Cover the motorcycle with a tarp or cover that is permeable to air.

i Info

Do not use non-porous materials since they prevent humidity from escaping, thus causing corrosion. Avoid running the engine for a short time only. Since the engine cannot warm up properly, the water vapor produced during combustion condenses and causes valves and the exhaust system to rust.

20.2 Preparing for use after storage

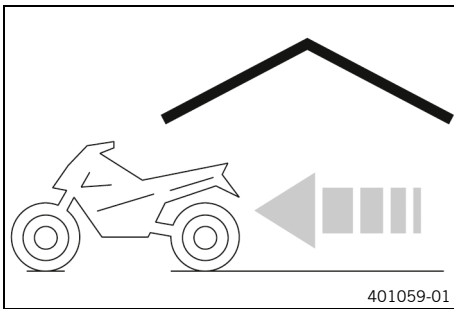

- Take the motorcycle off the front lifting gear. (📖 p. 65)
- Remove the rear of the motorcycle from the lifting gear. (📖 p. 64)
- Install the 12-V battery. 🛠️ (📖 p. 87)
- Set time and date. (📖 p. 44)
- Perform checks and maintenance measures when preparing for use. (📖 p. 51)
- Take a test ride.



Faults	Possible cause	Action
The engine does not turn when the start button is pressed	Operating error	– Carry out start procedure. (📖 p. 51)
	12-V battery discharged	– Charge the 12-V battery. 🛠️ (📖 p. 88)
	Fuse 1 , 3 , 4 , or 7 is blown	– Change the fuses of individual electrical power consumers. (📖 p. 92)
	No ground connection present on the starter motor	– Check the ground connection.
Engine turns only if the clutch lever is drawn	The vehicle is in gear	– Shift the transmission into neutral.
	The vehicle is in gear and the side stand is folded out	– Shift the transmission into neutral.
The engine turns but does not start	Operating error	– Carry out start procedure. (📖 p. 51)
	Quick release coupling not joined	– Join the quick release coupling.
	Malfunction in the electronic fuel injection	– Read out the fault memory using the KTM diagnostics tool. 🛠️
Engine has too little power	Air filter is very dirty	– Change the air filter.
	Fuel filter is very dirty	– Check the fuel pressure. 🛠️
	Malfunction in the electronic fuel injection	– Read out the fault memory using the KTM diagnostics tool. 🛠️
Engine overheats	Too little coolant in cooling system	– Check the cooling system for leakage. – Check the coolant level. (📖 p. 98)
	Radiator fins very dirty	– Clean the radiator fins.
	Foam formation in cooling system	– Drain the coolant. 🛠️ (📖 p. 99) – Fill/bleed the cooling system. 🛠️ (📖 p. 100)
	Thermostat defective	– Check the thermostat. 🛠️
	Fuse 5 blown	– Change the fuses of individual electrical power consumers. (📖 p. 92)
	Defect in radiator fan system	– Check the radiator fan system. 🛠️
Malfunction indicator lamp lights up yellow	Malfunction in the electronic fuel injection	– Read out the fault memory using the KTM diagnostics tool. 🛠️
Engine dies during the trip	Lack of fuel	– Refuel. (📖 p. 58)
	Fuse 1 , 3 , 4 , or 7 is blown	– Change the fuses of individual electrical power consumers. (📖 p. 92)
The ABS warning lamp lights up	ABS fuse blown	– Change the ABS fuses. (📖 p. 91)
	Large difference in wheel speeds of the front and rear wheels	– Stop the vehicle, switch off the ignition, and start it again.
	Malfunction in ABS	– Read out the fault memory using the KTM diagnostics tool. 🛠️
High oil consumption	Engine vent hose bent	– Route the vent hose without bends or change it if necessary.
	Engine oil level too high	– Check the engine oil level. (📖 p. 105)
	Engine oil too thin (low viscosity)	– Change the engine oil and oil filter, clean the oil screen. 🛠️ (📖 p. 105)
Headlight and position light are not functioning	Fuse 6 blown	– Change the fuses of individual electrical power consumers. (📖 p. 92)
Turn signal, brake light, and horn are not functional	Fuse 4 or 6 blown	– Change the fuses of individual electrical power consumers. (📖 p. 92)

Faults	Possible cause	Action
Time is not displayed or not correctly displayed	Fuse 2 is blown	– Change the fuses of individual electrical power consumers. (📖 p. 92)
12 V battery discharged	Ignition was not switched off when vehicle was parked	– Charge the 12-V battery. 🔧 (📖 p. 88)
	The 12-V battery is not being charged by the alternator	– Check the charging voltage. 🔧 – Check the open-circuit current. 🔧
The combination instrument shows nothing on the display	Fuse 2 is blown	– Change the fuses of individual electrical power consumers. (📖 p. 92)
Speedometer in combination instrument not functioning	Speedometer wiring harness is damaged or plug-in connector is oxidized	– Check the wiring harness and plug-in connector.

22.1 Engine

Design	1-cylinder 4-stroke engine, water-cooled
Displacement	125 cm ³ (7.63 cu in)
Stroke	47.3 mm (1.862 in)
Bore	58 mm (2.28 in)
Compression ratio	12.3:1
Control	SOHC, four valves controlled via rocker arm, chain drive
Valve diameter, intake	22.5 mm (0.886 in)
Valve diameter, exhaust	19 mm (0.75 in)
Valve clearance, intake, cold	0.08 ... 0.12 mm (0.0031 ... 0.0047 in)
Valve clearance, exhaust, cold	0.13 ... 0.17 mm (0.0051 ... 0.0067 in)
Crankshaft bearing	Slide bearing
Conrod bearing	Slide bearing
Pistons	Forged aluminum
Piston rings	One compression ring, one tapered compression piston ring, one oil scraper ring
Engine lubrication	Pressure circulation lubrication
Primary transmission	23:80
Clutch	Clutch in oil bath/mechanically activated
Transmission	Sixth-gear manual transmission
Transmission ratio	
First-gear	11:33
second-gear	15:29
third-gear	18:26
fourth-gear	21:24
fifth-gear	23:22
sixth-gear	24:21
Mixture preparation	Electronic fuel injection
Ignition	Contactless controlled fully electronic ignition with digital ignition adjustment
Alternator	12 V, 230 W
Spark plug	Champion REK6ZMC
Spark plug electrode gap	1 mm (0.04 in)
Cooling	Water cooling, permanent circulation of coolant by water pump
Idle speed	1,650 ± 50 rpm
Starting aid	Starter motor

22.2 Engine tightening torques

Screw, gear position sensor	M5	5.5 Nm (4.06 lbf ft) Loctite®243™
Screw, retaining bracket	M5	6 Nm (4.4 lbf ft) Loctite®243™
Oil nozzle	M5x0.8	5.5 Nm (4.06 lbf ft) Loctite®243™
Screw, retaining bracket, stator cable	M5x0.8	5.5 Nm (4.06 lbf ft) Loctite®243™
Screw, stator	M5x0.8	7.5 Nm (5.53 lbf ft) Loctite®243™
Nut, water pump impeller	M6	8 Nm (5.9 lbf ft) Loctite®243™
Screw plug, water pump drain hole	M6	11 Nm (8.1 lbf ft) Loctite®243™
Screw, alternator cover	M6	11 Nm (8.1 lbf ft)
Screw, bearing retainer	M6	11 Nm (8.1 lbf ft) Loctite®243™
Screw, camshaft bearing bridge	M6	10 Nm (7.4 lbf ft)
Screw, camshaft gear wheel	M6	11 Nm (8.1 lbf ft) Loctite®243™
Screw, chain securing guide	M6	5.5 Nm (4.06 lbf ft) Loctite®243™
Screw, clutch cable retaining bracket	M6	6 Nm (4.4 lbf ft) Loctite®243™
Screw, clutch cover	M6	11 Nm (8.1 lbf ft)
Screw, cylinder head	M6	11 Nm (8.1 lbf ft)
Screw, engine case	M6x40	12 Nm (8.9 lbf ft)
Screw, engine case	M6x60	12 Nm (8.9 lbf ft) Loctite®243™
Screw, engine sprocket	M6	12 Nm (8.9 lbf ft)
Screw, engine vent plate	M6	11 Nm (8.1 lbf ft) Loctite®243™
Screw, freewheel gear retaining bracket	M6	11 Nm (8.1 lbf ft) Loctite®243™
Screw, locking lever	M6	11 Nm (8.1 lbf ft) Loctite®243™
Screw, oil filter cover	M6	9 Nm (6.6 lbf ft)
Screw, oil pump	M6	11 Nm (8.1 lbf ft) Loctite®243™
Screw, retaining bracket, radial shaft seal ring, clutch cover	M6	12 Nm (8.9 lbf ft) Loctite®243™
Screw, shift drum locating unit	M6	11 Nm (8.1 lbf ft) Loctite®243™
Screw, starter motor	M6	11 Nm (8.1 lbf ft)
Screw, timing chain tensioner	M6	11 Nm (8.1 lbf ft)
Screw, timing chain tensioning rail	M6	11 Nm (8.1 lbf ft) Loctite®243™

Screw, valve cover	M6	11 Nm (8.1 lbf ft)
Screw, water pump cover	M6	11 Nm (8.1 lbf ft)
Screw, conrod bearing	M7x1	1st stage 9.8 Nm (7.23 lbf ft) 2nd stage 60°
Nut, exhaust flange	M8	21 Nm (15.5 lbf ft)
Screw, balancer shaft gear wheel	M8	39 Nm (28.8 lbf ft) Loctite®243™
Stud, exhaust flange	M8	21 Nm (15.5 lbf ft)
Screw, spring thrust bearing of the shift shaft	M8x1.25	20.5 Nm (15.12 lbf ft) Loctite®243™
Oil pressure sensor	M10x1	12.5 Nm (9.22 lbf ft)
Screw plug, cam lever shaft	M10x1	11 Nm (8.1 lbf ft) Loctite®243™
Spark plug	M10x1	11 Nm (8.1 lbf ft)
Screw, cylinder head	M10x1.25	43 Nm (31.7 lbf ft) Thread is oiled, head flat is greased
Coolant temperature sensor	M10x1.5	13 Nm (9.6 lbf ft)
Screw, rotor	M12x1.5	119 Nm (87.8 lbf ft)
Nut, inner clutch hub	M14LHx1	66 Nm (48.7 lbf ft) Loctite®243™
Nut, primary gear wheel/timing chain sprocket	M16x1.5	109 Nm (80.4 lbf ft) Loctite®243™
Oil drain plug	M24x1.5	12.5 Nm (9.22 lbf ft)
Nut, drive gear wheel for balancer shaft	M28	65 Nm (47.9 lbf ft) Loctite®243™

22.3 Capacities

22.3.1 Engine oil

Engine oil	1.2 l (1.3 qt.)	Engine oil (SAE 15W/50) (📖 p. 123)
------------	-----------------	---------------------------------------

22.3.2 Coolant

Coolant	1 l (1 qt.)	Coolant (📖 p. 123)
---------	-------------	--------------------

22.3.3 Fuel

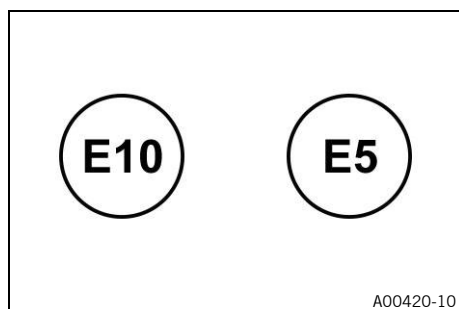

Please observe the labels on EU fuel pumps.

Total fuel tank capacity, approx.	15 l (4 US gal)	Super unleaded (ROZ 95) ( p. 124)
-----------------------------------	-----------------	--

Fuel reserve, approx.	1.5 l (1.6 qt.)
-----------------------	-----------------

22.4 Chassis

Frame	Lattice frame of steel tubes, powder-coated
Fork	WP Suspension
Shock absorber	WP Suspension
Brake system	
front	Disc brake with 4-piston brake caliper
rear	Disc brake with single-pot brake caliper, floating
Suspension travel	
Front	150 mm (5.91 in)
Rear	150 mm (5.91 in)
Brake discs - diameter	
Front	320 mm (12.6 in)
Rear	240 mm (9.45 in)
Brake discs - wear limit	
Front	4.5 mm (0.177 in)
Rear	4.5 mm (0.177 in)
Tire pressure when solo	
front	2.0 bar (29 psi)
Rear	2.0 bar (29 psi)
Tire pressure with passenger / full payload	
front	2.0 bar (29 psi)
rear	2.2 bar (32 psi)
Secondary ratio	14:45
Chain	5/8 x 1/4" (520) X-ring
Steering head angle	66°
Wheelbase	1,370 mm (53.94 in)
Seat height, unloaded	800 mm (31.5 in)
Ground clearance, unloaded	175 mm (6.89 in)
Dry weight	154 kg (340 lb.)
Maximum permissible front axle load	127 kg (280 lb.)
Maximum permissible rear axle load	228 kg (503 lb.)
Maximum permissible overall weight	355 kg (783 lb.)

22.5 Electrical system

12-V battery	ETZ-9-BS	Battery voltage: 12 V Nominal capacity: 8 Ah Maintenance-free
Fuse	75011088010	10 A
Fuse	75011088015	15 A
Fuse	75011088020	20 A
Fuse	75011088030	30 A
Headlight	LED	
Position light	LED	
Combination instrument lighting and indicator lamps	LED	
Turn signal	LED	
Brake/tail light	LED	
License plate lamp	LED	

22.6 Tires

Front tire	Rear tire
110/70 ZR 17 M/C 54W TL Michelin Road 5	150/60 ZR 17 M/C 66W TL Michelin Road 5
110/70 ZR 17 M/C 54W TL Metzeler Sportec M9	150/60 ZR 17 M/C 66W TL Metzeler Sportec M9
<p>The tires specified represent one of the possible series production tires. For alternative manufacturers, if any, contact an authorized dealer or qualified tire dealership. If local road approval regulations apply, these and the respective technical specifications must be observed. Additional information is available in the Service section under: KTM.COM</p>	

22.7 Fork

Fork article number	96001001000 / 96001002000	
Fork	WP Suspension	
Spring length with preload spacer(s)	360 mm (14.17 in)	
Spring rate		
Weight of rider: 75 ... 85 kg (165 ... 187 lb.)	7.0 N/mm (40 lb/in)	
Fork length	753 mm (29.65 in)	
Fork oil	425 ± 5 ml (14.37 ± 0.17 fl. oz.)	Fork oil (SAE 5) (📖 p. 124)

22.8 Shock absorber

Shock absorber article number	96004010033
Shock absorber	WP Suspension
Spring preload	
Standard	3 clicks
Static sag	12 mm (0.47 in)
Riding sag	51 mm (2.01 in)
Fitted length	326 mm (12.83 in)

22.9 Chassis tightening torques

Remaining screws, chassis	M4	4 Nm (3 lbf ft)
Remaining nuts, chassis	M5	5 Nm (3.7 lbf ft)
Remaining screws, chassis	M5	5 Nm (3.7 lbf ft)
Screw, chain guard	M5	7 Nm (5.2 lbf ft)
Screw, combination instrument	M5	4 Nm (3 lbf ft)
Screw, fuel tank lid	M5	5 Nm (3.7 lbf ft)
Screw, outer clutch cable guide	M5	5 Nm (3.7 lbf ft)
Screw, tail light	M5	5 Nm (3.7 lbf ft)
Remaining nuts, chassis	M6	15 Nm (11.1 lbf ft)
Remaining screws, chassis	M6	9 Nm (6.6 lbf ft)
Screw, ABS hose clamp	M6	7 Nm (5.2 lbf ft)
Screw, ABS module	M6	7 Nm (5.2 lbf ft)
Screw, ABS module retaining bracket on frame	M6	7 Nm (5.2 lbf ft)
Screw, air filter box	M6	7 Nm (5.2 lbf ft)
Screw, bell crank shift lever	M6	16 Nm (11.8 lbf ft) Loctite®243™
Screw, bracket of fuel vapor valve	M6	9 Nm (6.6 lbf ft)
Screw, brake fluid reservoir for rear brake	M6	7 Nm (5.2 lbf ft)
Screw, brake hose clamp	M6	7 Nm (5.2 lbf ft)
Screw, chain guard	M6	9 Nm (6.6 lbf ft)
Screw, chain guard on link fork	M6	9 Nm (6.6 lbf ft)
Screw, chain sliding guard	M6	9 Nm (6.6 lbf ft)
Screw, compensating tank cap lock, rear brake	M6	7 Nm (5.2 lbf ft)
Screw, damper block	M6	9 Nm (6.6 lbf ft)
Screw, engine sprocket cover	M6	11 Nm (8.1 lbf ft)
Screw, front brake disc	M6	18 Nm (13.3 lbf ft)
Screw, front fender	M6	6 Nm (4.4 lbf ft)
Screw, front seat fixing	M6	6 Nm (4.4 lbf ft)
Screw, fuel pump	M6	9 Nm (6.6 lbf ft)
Screw, fuel tank	M6	11 Nm (8.1 lbf ft)
Screw, fuel tank cover	M6	6 Nm (4.4 lbf ft)
Screw, headlight mask	M6	11 Nm (8.1 lbf ft) Loctite®243™
Screw, ignition coil	M6	8 Nm (5.9 lbf ft)
Screw, ignition lock (tamper-proof screw)	M6	13 Nm (9.6 lbf ft)
Screw, license plate holder	M6	7 Nm (5.2 lbf ft)
Screw, lower rear panel	M6	5 Nm (3.7 lbf ft)
Screw, magnetic holder on side stand	M6	5 Nm (3.7 lbf ft) Loctite®243™
Screw, protective plate	M6	9 Nm (6.6 lbf ft)
Screw, radiator holder	M6	6 Nm (4.4 lbf ft)

22 TECHNICAL SPECIFICATIONS

Screw, radiator shield	M6	8 Nm (5.9 lbf ft)	
Screw, rear brake cylinder	M6	7 Nm (5.2 lbf ft)	
Screw, rear splash protector	M6	9 Nm (6.6 lbf ft)	
Screw, side stand sensor	M6	5 Nm (3.7 lbf ft)	
Screw, side stand sensor cable holder	M6	5 Nm (3.7 lbf ft)	Loctite®243™
Screw, silent block	M6	7 Nm (5.2 lbf ft)	
Screw, tilt sensor	M6	9 Nm (6.6 lbf ft)	
Screw, top presilencer	M6	11 Nm (8.1 lbf ft)	
Screw, wheel speed sensor - rear wheel	M6	7 Nm (5.2 lbf ft)	Loctite®243™
Screw, wheel speed sensor holder	M6	9 Nm (6.6 lbf ft)	
Nut, rear sprocket	M8	30 Nm (22.1 lbf ft)	Loctite®243™
Remaining nuts, chassis	M8	30 Nm (22.1 lbf ft)	
Remaining screws, chassis	M8	25 Nm (18.4 lbf ft)	
Screw, bottom presilencer	M8	21 Nm (15.5 lbf ft)	
Screw, bottom triple clamp	M8	12 Nm (8.9 lbf ft)	
Screw, crash bar on engine bearer	M8	19 Nm (14 lbf ft)	
Screw, engine bearer on frame	M8	26 Nm (19.2 lbf ft)	
Screw, foot brake lever	M8	16 Nm (11.8 lbf ft)	Loctite®243™
Screw, footpeg bracket	M8	21 Nm (15.5 lbf ft)	
Screw, fork shoe	M8	16 Nm (11.8 lbf ft)	
Screw, front brake caliper	M8	29 Nm (21.4 lbf ft)	
Screw, front brake disc	M8	30 Nm (22.1 lbf ft)	
Screw, front seat fixing	M8	20 Nm (14.8 lbf ft)	
Screw, handlebar clamp	M8	20 Nm (14.8 lbf ft)	
Screw, horn	M8	16 Nm (11.8 lbf ft)	
Screw, passenger footpeg bracket	M8	21 Nm (15.5 lbf ft)	
Screw, rear brake disc	M8	30 Nm (22.1 lbf ft)	
Screw, rear seat fixing	M8	18 Nm (13.3 lbf ft)	
Screw, seat support plate	M8	18 Nm (13.3 lbf ft)	
Screw, supporting strap	M8	21 Nm (15.5 lbf ft)	
Screw, top triple clamp	M8	17 Nm (12.5 lbf ft)	
Banjo bolt, brake line	M10	24 Nm (17.7 lbf ft)	
Fitting, bottom shock absorber	M10	50 Nm (36.9 lbf ft)	Loctite®243™
Fitting, handlebar support	M10	21 Nm (15.5 lbf ft)	
Fitting, side stand	M10	32 Nm (23.6 lbf ft)	
Nut, rear mirror	M10	23 Nm (17 lbf ft)	
Remaining nuts, chassis	M10	50 Nm (36.9 lbf ft)	
Remaining screws, chassis	M10	46 Nm (33.9 lbf ft)	
Screw, bottom subframe	M10	43 Nm (31.7 lbf ft)	Loctite® 620™
Screw, engine bearer on engine	M10	44 Nm (32.5 lbf ft)	

Screw, engine on frame	M10	44 Nm (32.5 lbf ft) Loctite®243™
Screw, top shock absorber	M10	50 Nm (36.9 lbf ft) Loctite®243™
Top subframe screw	M10	43 Nm (31.7 lbf ft)
Stud, rear sprocket	M10x1.25	50 Nm (36.9 lbf ft)
Swingarm pivot nut	M14	100 Nm (73.8 lbf ft)
Nut, rear wheel spindle	M16	100 Nm (73.8 lbf ft)
Adjusting ring, fork bearing	M22	9 Nm (6.6 lbf ft)
Screw, steering head, top	M22	74 Nm (54.6 lbf ft)
Screw, wheel spindle, front	M24	45 Nm (33.2 lbf ft)
Nut, steering head	M30	1st stage 45 Nm (33.2 lbf ft) 2nd stage (loosen, counterclockwise) 2 turns 3rd stage 5 Nm (3.7 lbf ft)

23.1 Declarations of conformity

i Info

The functional and equipment scope is model-dependent and may not include all wireless systems and application areas referred to.

COBO SpA hereby declares that the **BT-ROUTER** wireless system conforms with the relevant guidelines. The full text of the Declaration of Conformity is available at the following Internet address.

Certification website: <http://www.ktm.com/btrouter>

JNS Instruments Ltd. hereby declares that the **210M1100** wireless system conforms with the relevant guidelines. The full text of the Declaration of Conformity is available at the following Internet address.

Certification website: <http://www.ktm.com/210m1100>

23.2 Country-specific declarations of conformity

CE EAC **ICA-SA** **Norom Sertifikat (Norom PLG ID)** **1111/SDPPI/2016 22**

R-R-03C-bCCU **CC XX xx YY yyy Zz W** **R! C-29916**

R 220-JP6477 **Complies with IMDA Standards(N2608-23)** **Type Accepted NO.ESD-RCE-2333720**

CMIIT ID : XXXXYZNNNN **FCC ID: 2AKR7-320T1100** **ANATEL HHHHH-AA-FFFFF**

IFT: XXXXXXXX-XXXXX **UK CA**

04/12-1234

ICCU ICT

TRCSL APPROVED
Ref No. TRC/SM/TA/0041/23-9018

AGREE PAR L'ANRT MAROC
Numéro d'agrément: MR00039589ANRT2023
Date d'agrément: 08/08/2023

Peru Instructions:
 *En el Perú, este equipo diseñado para la banda de 902-928 MHz, debe ser configurado para operar sólo en la banda 915-928 MHz con una PIRE de hasta 1W (30 dBm) y sujeto a las Condiciones de Operación que establezca el MTC. *
 *En el Perú, este equipo diseñado para la banda de 902-928 MHz, debe ser configurado para operar sólo en la banda 916-928 MHz con una PIRE de hasta 4W (36 dBm) y sujeto a las Condiciones de Operación que establezca el MTC. *
 *En el Perú, este equipo diseñado para la banda de 5925-7125 MHz, debe ser configurado para operar sólo en la banda 915-928 MHz con una PIRE de hasta 1W (30 dBm) y sujeto a las Condiciones de Operación que establezca el MTC. *

A01510-01

Brake fluid DOT 4 / DOT 5.1**Standard/classification**

- DOT

Guideline

- Use only brake fluid that complies with the specified standard (see specifications on the container) and that exhibits the corresponding properties.

Recommended supplier**Castrol**

- REACT PERFORMANCE DOT 4

MOTOREX®

- Brake Fluid DOT 5.1

Coolant**Guideline**

- Only use high-grade, silicate-free coolant with corrosion inhibitor additive for aluminum motors. Low grade and unsuitable antifreeze causes corrosion, deposits and frothing.
- Do not use pure water as only coolant is able to meet the requirements needed in terms of corrosion protection and lubrication properties.
- Only use coolant that complies with the requirements stated (see specifications on the container) and that has the relevant properties.

Antifreeze protection to at least	-25 °C (-13 °F)
-----------------------------------	-----------------

The mixture ratio must be adjusted to the necessary antifreeze protection. Use distilled water if the coolant needs to be diluted.

The use of premixed coolant is recommended.

Observe the coolant manufacturer specifications for antifreeze protection, dilution and miscibility (compatibility) with other coolants.

Recommended supplier**MOTOREX®**

- COOLANT M3.0

Engine oil (SAE 15W/50)**Standard/classification**

- JASO T903 MA2 (📖 p. 126)
- SAE (📖 p. 126) (SAE 15W/50)

Guideline

- Use only engine oils that comply with the specified standards (see specifications on the container) and that exhibit the corresponding properties.

Partially synthetic engine oil

Recommended supplier**MOTOREX®**

- Formula 4T

Fork oil (SAE 5)

Standard/classification

- SAE (📖 p. 126) (SAE 5)

Guideline

- Use only oils that comply with the specified standards (see specifications on the container) and that possess the corresponding properties.

Recommended supplier

MOTOREX®

- Racing Fork Oil

Super unleaded (ROZ 95)

Standard/classification

- DIN EN 228 (ROZ 95)

Guideline

- Only use super unleaded fuel that matches or is equivalent to the specified standard.
- Fuel with an ethanol content of up to 10% (E10 fuel) is safe to use.



Info

Do **not** use fuel containing methanol (e.g., M15, M85, M100) or more than 10% ethanol (e.g., E15, E25, E85, E100).

Chain cleaner

Recommended supplier

MOTOREX®

- Chain Clean

Fuel additive

Recommended supplier

MOTOREX®

- Fuel Stabilizer

Long-life grease

Recommended supplier

MOTOREX®

- Bike Grease 2000

Motorcycle cleaner

Recommended supplier

MOTOREX®

- Moto Clean

Preserving materials for paints, metal and rubber

Recommended supplier

MOTOREX®

- Moto Protect

Shine spray for paint, plastic and chromium

Recommended supplier

MOTOREX®

- Moto Shine

Special cleaner for glossy and matte paint finishes, metal and plastic surfaces

Recommended supplier

MOTOREX®

- Quick Cleaner

Street chain spray

Guideline

Recommended supplier

MOTOREX®

- Chainlube Road Strong

Universal oil spray

Recommended supplier

MOTOREX®

- Joker 440 Synthetic

JASO T903 MA2

Different technical development directions required a separate specification for motorcycles – the **JASO T903 MA2** standard.

Earlier, engine oils from the automobile industry were used for motorcycles because there was no separate motorcycle specification.

Whereas long service intervals are demanded for automobile engines, the focus for motorcycle engines is on high performance at high engine speeds.

In most motorcycle engines, the transmission and clutch are lubricated with the same oil.

The **JASO T903 MA2** standard meets these special requirements.

SAE

The SAE viscosity classes were defined by the Society of Automotive Engineers and are used for classifying oils according to their viscosity. The viscosity describes only one property of oil and says nothing about quality.

ABS	Anti-lock braking system	Safety system that prevents locking of the wheels when driving straight ahead without the influence of lateral forces
-	KTMconnect	System for wireless communication with suitable cell-phones and communication systems for telephony and audio
OBD	On-board diagnosis	Vehicle system, which monitors the specified parameters of the vehicle electronics
-	QUICKSHIFTER+	Engine electronics function for shifting up and down without clutch actuation

28 LIST OF ABBREVIATIONS

Art. no.	Article number
ca.	circa
cf.	compare
e.g.	for example
etc.	et cetera
i.a.	inter alia
no.	number
poss.	possibly





29.1 Red symbols

Red symbols indicate an error condition that requires immediate intervention.

	The oil pressure warning lamp lights up red – The oil pressure is too low. Stop immediately, taking care not to endanger yourself or other road users in the process, and switch off the engine.
---	--





29.2 Yellow and orange symbols

Yellow and orange symbols indicate an error condition that requires prompt intervention. Active driving aids are also represented by yellow or orange symbols.

	The malfunction indicator lamp lights up yellow – The OBD has detected a malfunction in the vehicle electronics. Come safely to a halt, and contact an authorized KTM workshop.
	ABS warning lamp lights up yellow – Status or error messages relating to ABS.
	The ABS rear warning lamp lights up yellow – ABS is deactivated on the rear wheel.
	Speed limiter indicator lamp (optional) lights up yellow – The speed limiter function is switched on, but the speed limiter is not active.
	The general warning lamp lights up yellow – A note/warning note on operating safety has been detected. This is also shown in the display.

29.3 Green and blue symbols

Green and blue symbols reflect information.

	The turn signal indicator lamp flashes green with a steady rhythmic flash – The turn signal is switched on.
	The idle indicator lamp lights up green – The transmission is in neutral.
	Speed limiter indicator lamp (optional) lights up green – The speed limiter function is switched on and the speed limiter is active.
	The high beam indicator lamp lights up blue – The high beam is switched on.

1	
12-V battery	
charging	88
installing	87
removing	87
A	
ABS	73
ABS fuses	
changing	91
ACC1	
front	95
ACC1 and ACC2	
rear	96
ACC2	
front	95
Antifreeze	
checking	97
Anti-lock braking system	73
Applying the brakes	55
Auxiliary substances	9
B	
Brake discs	
checking	74
Brake fluid	
front brake, adding	75
rear brake, adding	78
Brake fluid level	
front brake, checking	75
rear brake, checking	77
Brake lining retainers	
of front brake, checking	77
of rear brake, checking	79
Brake linings	
of front brake, checking	77
of rear brake, checking	79
Brakes	55
Breakdown	
towing	57
C	
Capacity	
coolant	116
engine oil	106, 116
fuel	59, 117
Chain	
chain dirt accumulation, checking	67
checking	70
cleaning	67
Chain tension	
checking	68
setting	69
Clutch lever	13
basic position, adjusting	71
Clutch lever play	
checking	72
Combination instrument	21-48
ABS	32
ABS display	27
activation and test	21
Alle Runden löschen	31
Audio	37
Bike Info	33
Bluetooth	40
Call display	30
Clock Format	45
connectivity	39
coolant temperature indicator	28
Date Format	45
display	24
Distance	46
engine speed	26
Extra Functions	48
Favoriten	38
Favorites display	29
Favorites-Anzeige 1-4	38
fuel level display	28
Fuel Cons	47
Geschwindigkeitsbegrenzer (optional)	35
Geschwindigkeitsbegrenzer State (optional)	35
headset pairing	41
Headset Type	42
heated grip (optional)	29
Heated Grips (function optional)	37
"heating" (function optional)	47
Heating (optional)	37
indicator lamps	23
Language	47
Lap Timer	31
menu	31
Motorcycle	32
navigation	36
Navigation display (optional)	30
overview	21
pairing a cellphone	40
Quick Selector 1	39
Quick Selector 1 display	29
Quick Selector 2	39
Quick Selector 2 display	29
QUICKSHIFTER+ (optional)	42
Remote Control Mode (optional)	30
Ride Mode	32, 104

Ride-Mode display	27	Foot brake lever	13, 20
Settings	38	Fork legs	
shift warning light	26	dust boots, cleaning	65
speed limiter display (optional)	27	Front rider's seat	
speedometer	26	mounting	67
state	36	Front rider's seat	
Temperature	46	removing	67
time	27	Front wheel	
track display	25	installing	81
Trip	34	removing	81
Trip 1	34	Fuel tank filler cap	
Trip 2	35	closing	18
Units	46	opening	17
volume	36	Fuel, oils, etc.	9
Warning	34	Fuse	
warnings	22	of the individual electrical power consumers, changing	92
Combination switch	14		
overview	14	H	
Coolant		Hand brake lever	13
draining	99	basic position, adjusting	74
Coolant level		Hazard warning flasher	14
checking	97-98	Hazard warning flasher switch	14
Cooling system	97	Headlight	
filling/bleeding	100	range, adjusting	94
Customer service	9	Headlight setting	
		checking	94
D		Horn button	15
Date		I	
setting	44	Ignition lock	16
Declarations of conformity	122	Implied warranty	9
country-specific	122	Indicator lamps	23
Diagnostics connector	95	K	
		Key number	12
E		L	
Emergency OFF switch	15	Light switch	15
Engine		Load the vehicle	50
running in	50	Luggage	50
Engine number	12	M	
Engine oil		Main fuse	
adding	107	changing	89
changing	105	Manufacturer warranty	9
Engine oil level		Misuse	6
checking	105	Motorcycle	
Engine sprocket		cleaning	108
checking	70	lifting with front lifting gear	64
Environment	8	rear lifting gear, raising with	64
		removing the rear from the lifting gear	64
F			
Figures	9		
Filling up			
fuel	58		

taking off front lifting gear	65	Steering	
O		locking	16
Oil filter		unlocking	17
changing	105	Steering lock	16
Oil screens		Stopping	56
cleaning	105	Storage	110
Owner's Manual	8	Storage compartment	
P		USB socket	16
Parking	56	Supporting strap	19
Passenger foot pegs	19	T	
Passenger seat		Technical accessories	9
mounting	66	Technical specifications	
removing	66	capacities	116
Play in the clutch lever		chassis	117
adjusting	72	chassis tightening torques	119
Preparing for use		electrical system	118
advice on preparing for first use	49	engine	114
after storage	111	engine tightening torques	115
checks and maintenance measures when		fork	118
preparing for use	51	shock absorber	118
Protective clothing	7	tires	118
Q		Throttle grip	13
QUICKSHIFTER+	52	Time	
R		setting	44
Rear hub damping rubbers		Tire condition	
checking	84	checking	85
Rear sprocket		Tire pressure	
checking	70	checking	86
Rear wheel		Tool set	19
installing	83	Towing	57
removing	82	Transport	57
Riding	53	Troubleshooting	112-113
starting off	52	Turn signal switch	15
S		Type label	12
Safe operation	7	U	
Seat lock	19	USB socket	16
Service	9	Use definition	6
Service schedule	60-61	V	
Shift lever	20	Vehicle identification number	12
adjusting	62	View of vehicle	
Shifting	53	front left	10
Shock absorber		rear right	11
spring preload, adjusting	62	W	
Side stand	20	Winter operation	
Spare parts	9	checks and maintenance steps	109
Start button	16	Work rules	8
Starting	51		



3214956en

02.11.2023

