

# Engine 150 EXC 2025 2025

ART.-NR.: 081535YEN





All information contained is without obligation. KTM Sportmotorcycle GmbH particularly reserves the right to modify any equipment, technical specifications, prices, colors, shapes, materials, services, service work, constructions, equipment and the like so as to adapt them to local conditions or to cancel any of the above items, all without previous announcement and without giving reasons. KTM may stop manufacturing certain models without previous notice. KTM shall not be held liable for any deviations of availability and/or ability to deliver, illustrations, descriptions, printing and/or other errors. The illustrated models partly contain extra equipment, which is not applied to standard models.

© by KTM Sportmotorcycle GmbH, Mattighofen AUSTRIA; All rights reserved; Reprint, also in extracts, with written allowance of KTM Sportmotorcycle GmbH, Mattighofen only.

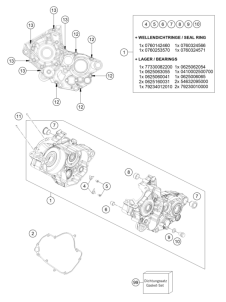
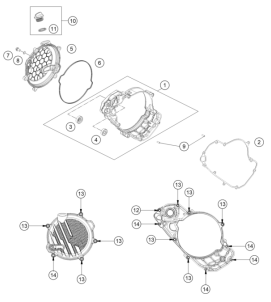
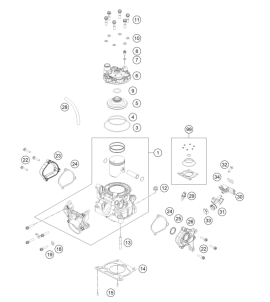
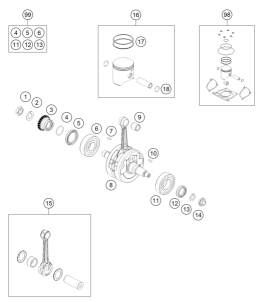
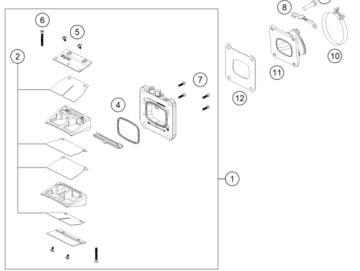
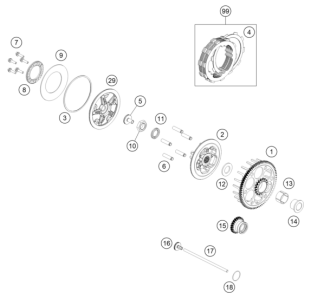
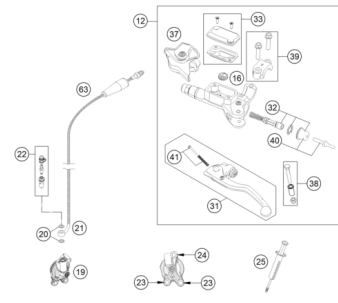
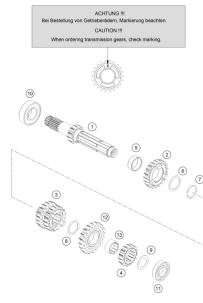
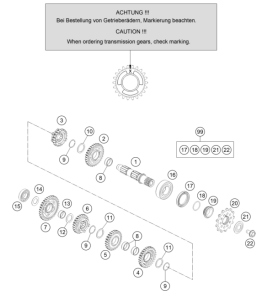
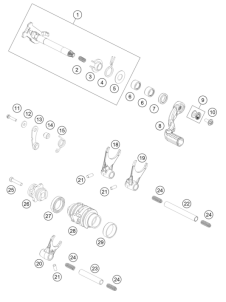
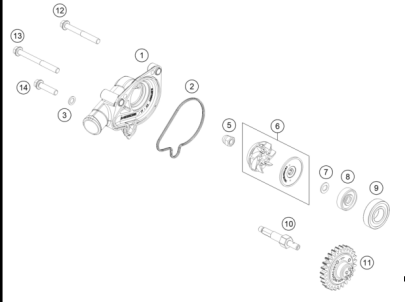
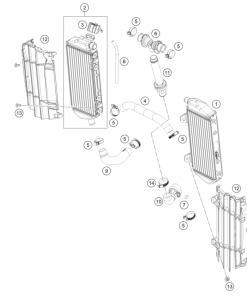
<p><b>ENGINE CASE</b></p>  <p><b>3</b></p>	<p><b>CLUTCH COVER</b></p>  <p><b>4</b></p>	<p><b>CYLINDER, CYLINDER HEAD</b></p>  <p><b>5</b></p>	<p><b>CRANKSHAFT, PISTON</b></p>  <p><b>6</b></p>
<p><b>REED VALVE CASE</b></p>  <p><b>7</b></p>	<p><b>CLUTCH</b></p>  <p><b>8</b></p>	<p><b>CLUTCH CONTROL</b></p>  <p><b>9</b></p>	<p><b>TRANSMISSION I - MAIN SHAFT</b></p> <p>ACHTUNG !! Bei Montage von Getriebschächten, Markierung beachten. CAUTION !! When ordering transmission gears, check marking.</p>  <p><b>10</b></p>
<p><b>TRANSMISSION II - COUNTERSHAFT</b></p> <p>ACHTUNG !! Bei Montage von Getriebschächten, Markierung beachten. CAUTION !! When ordering transmission gears, check marking.</p>  <p><b>11</b></p>	<p><b>SHIFTING MECHANISM</b></p>  <p><b>12</b></p>	<p><b>WATER PUMP</b></p>  <p><b>13</b></p>	<p><b>COOLING SYSTEM</b></p>  <p><b>14</b></p>

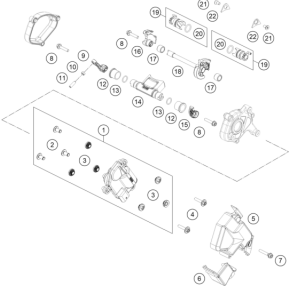
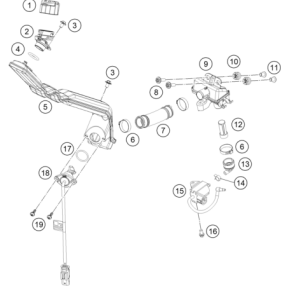
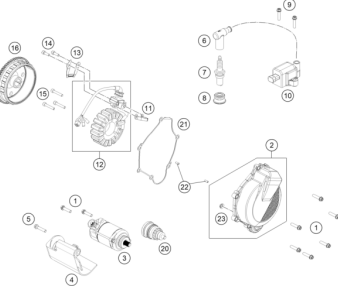
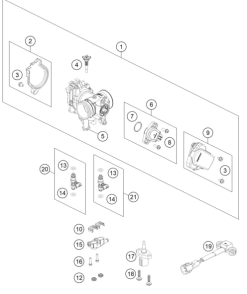
<p><b>EXHAUST CONTROL</b></p>  <p><b>15</b></p>	<p><b>LUBRICATING SYSTEM</b></p>  <p><b>16</b></p>	<p><b>IGNITION SYSTEM</b></p>  <p><b>17</b></p>	<p><b>THROTTLE BODY</b></p>  <p><b>18</b></p>

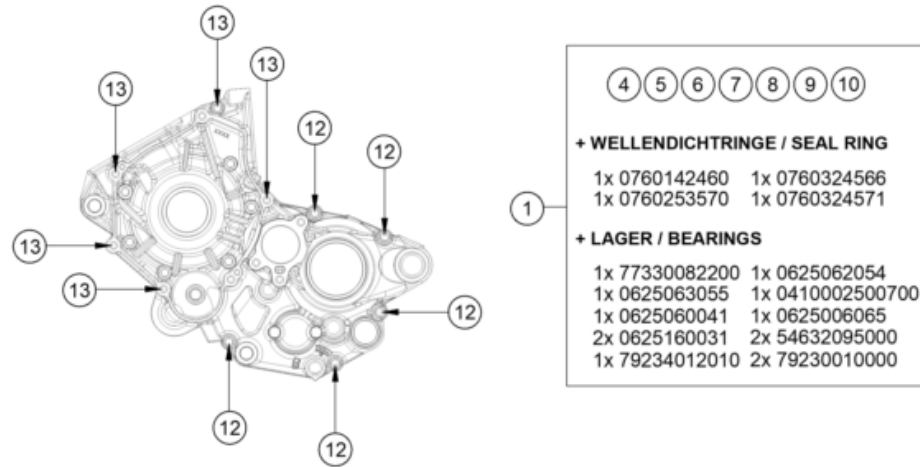

4 5 6 7 8 9 10	
<b>+ WELLENDICHRINGE / SEAL RING</b>	
1x 0760142460	1x 0760324566
1x 0760253570	1x 0760324571
<b>+ LAGER / BEARINGS</b>	
1x 77330082200	1x 0625062054
1x 0625063055	1x 0410002500700
1x 0625060041	1x 0625006065
2x 0625160031	2x 54632095000
1x 79234012010	2x 79230010000

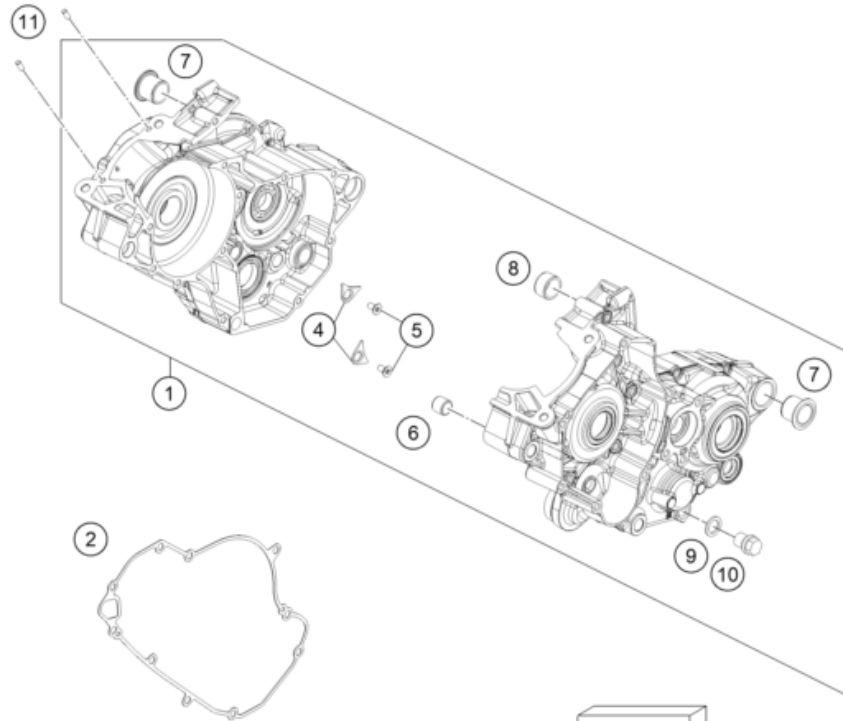

24A4203010

POS	PARTNUMBER		PIECE
1	A42030000144	Engine case cpl.	1
2	A42030025000	Clutch cover gasket, inner	1
4	75030085100	Retaining bracket crankshaft bearing	2
5	0019050106S	hex lobe countersunc screw M5x10 - 10.9	2
6	54630027000	DOWEL BUSHING 13,8X11X12	1
7	79230010000	Housing bush	1
8	54830027100	Dowel, 21x12	1
9	58038022000	CU-seal ring DIN7603-12X18X1.5	1
10	58030021000	OILDRAIN PLUG W.MAG. M 12X1,5	1
11	0402040980	NEEDLE ROL.DIN5402 NRB 4X9,8	2
12	0025060506	HH collar screw M6x50 TX30	5
13	0025060606	HH collar screw M6x60 TX30	5
99	A42030099100	gasket kit engine 125/150	x

64087

\* NEW PART

X ON DEMAND

# CLUTCH COVER

Engine 150 EXC 2025 2025

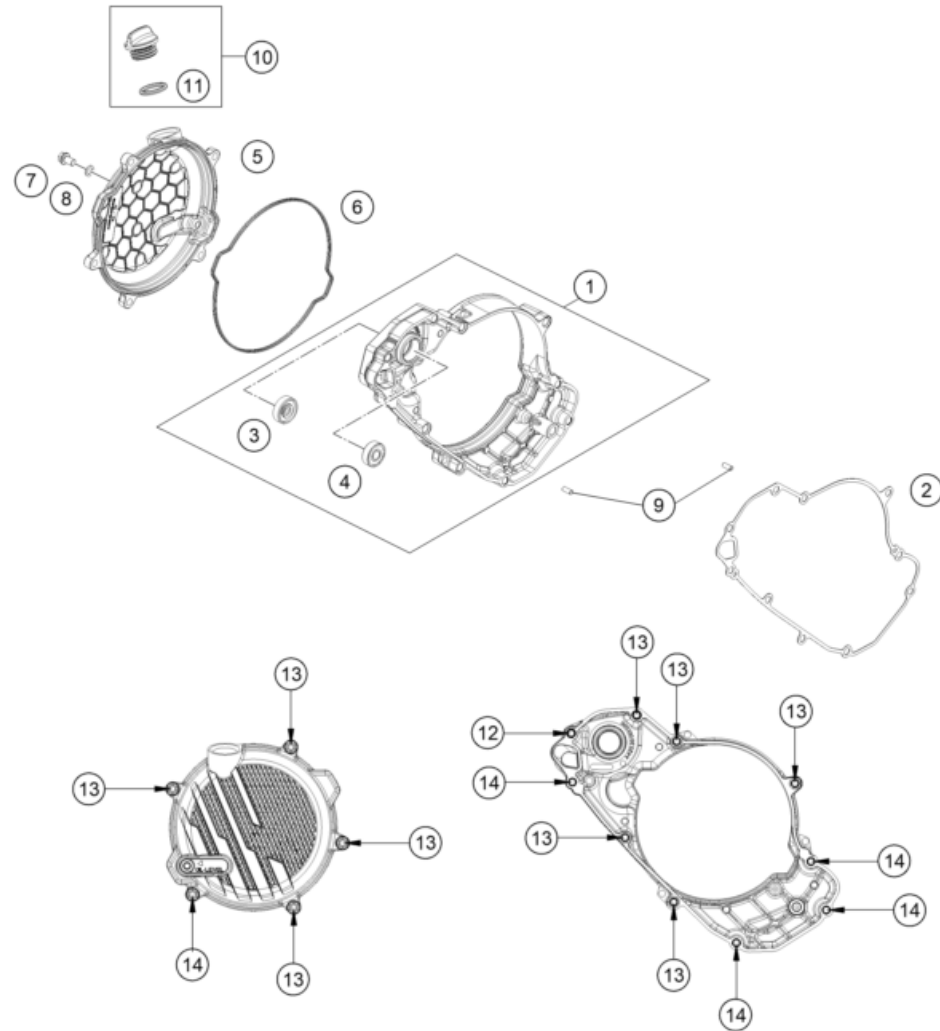

POS	PARTNUMBER		PIECE
1	A42030001044	Inner clutch cover compl.	1
2	A42030025000	Clutch cover gasket, inner	1
3	0760082472	SHAFT SEAL RING 8X24X7 A DUO	1
4	0625006087	GROOVED BALL BEAR. 608 2RS C3	1
5	A42030026000C1	clutch cover	1
6	A42030027000	Clutch cover gasket, external	1
7	0025060106	HH collar screw M6x10 TX30	1
8	0603061001	CU-seal ring DIN7603-6X10X1	1
9	0402040980	NEEDLE ROL.DIN5402 NRB 4X9,8	2
10	79430020033	OIL FILLER CAP M24x3 WITH O-R	1
11	0770191015	O-RING 19,00X3,00 NBR	1
12	0025060606	HH collar screw M6x60 TX30	1
13	0025060506	HH collar screw M6x50 TX30	5
14	0025060256	HH collar screw M6x25 TX30	4

23A4603020

60249

\* NEW PART

X ON DEMAND

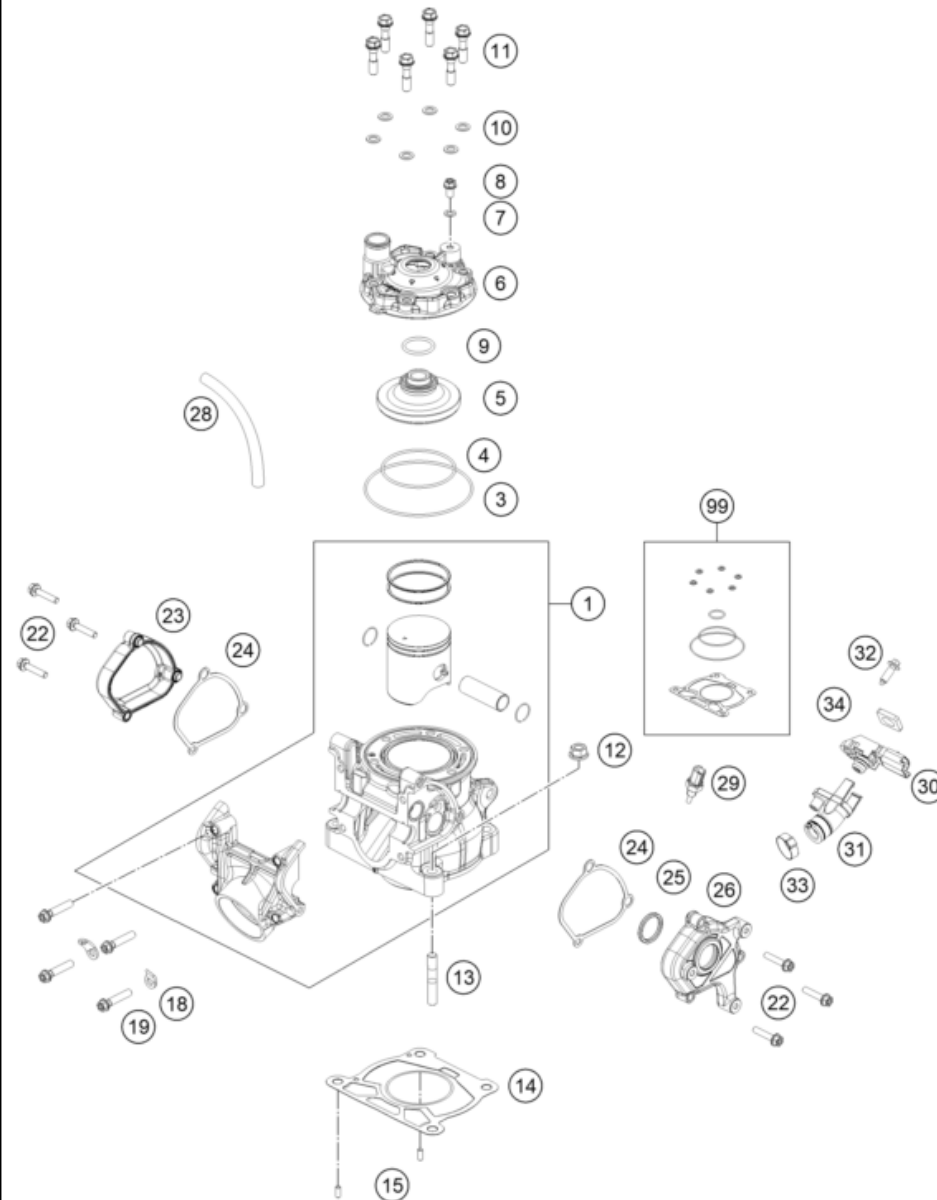

POS	PARTNUMBER		PIECE
1	A43030138000	Cylinder + Piston cpl. 150 Enduro	1
3	0770890200	O-RING 89X2 NBR 70 SH	1
4	0770600200	O-RING 60X2 FPM 75SH	1
5	A43030060000	Combustion chamber insert	1
6	A42030006100	Cylinder head	1
7	0603061001	CU-seal ring DIN7603-6X10X1	2
8	0025060106	HH collar screw M6x10 TX30	1
9	07702300251	O-RING 23,00X2,5 NBR 70 SH	1
10	0603070121	CU-SEAL RING DIN7603- 7,3X12X1	6
11	50430079000	CYLINDER HEAD SCREW	6
12	50330045000	HH COLLAR NUT M 8 WS=12	4
13	0835080326	STUD DIN 835 M8X32	4
14	A42030035020	Cylinder base gasket	x
14	A42030035025	Cylinder base gasket	x
14	A42030035030	Cylinder base gasket	x
14	A42030035040	Cylinder base gasket	x
14	A42030035050	Cylinder base gasket	x
15	0402040980	NEEDLE ROL.DIN5402 NRB 4X9,8	4
18	51005074000	RETAINING PLATE	2
19	0025060256	HH collar screw M6x25 TX30	4
22	0025050256	HH COLLAR SCREW M5X25 ISA30	6
23	A42037007000	exhaust regulation cover rh	1
24	A42037006000	Gasket, control lid left	2
25	0770002226200	X-ring 21.89x2.62 FKM 70	1
26	A42037005000	exhaust regulation cover lh	1
28	A44030087000	Engine vent hose	x
29	79435047000	water temperature sensor	1
30	A45041075000	Crank case pressure sensor	1
31	A44041087000	Pressure sensor flange	1
32	0017060206	SCREW F. PLASTIC K60X20AL SW6	1
33	00050210706	VARIABLE ONE-EAR CLAMP 21,0MM	1
34	A45041075050	Pressure sensor EPDM plate	1
99	A42030097000	Sealkit Cylinder MX 125	x

24A4303050

64081

\* NEW PART

X ON DEMAND

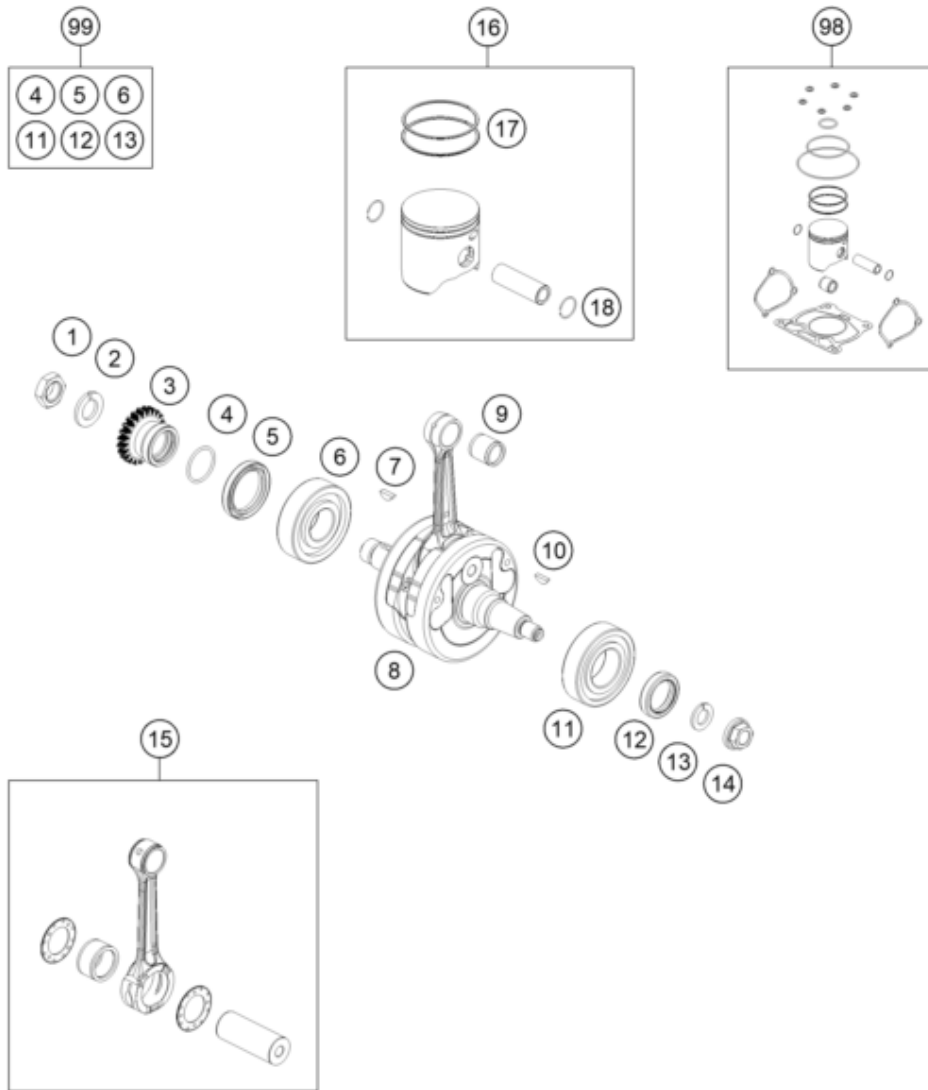

POS	PARTNUMBER		PIECE
1	0910001801000S	Nut M18x1.5 Precote	1
2	50230029016	LOCKING RING VSK 16	1
3	A42032023023	Primary gear wheel 23 teeth.	1
4	0770250020	O-RING 25,00X2,00 NBR 70	1
5	0760324566	Shaft seal ring 32x45x6.5	1
6	0625063055	BALL BEARING 6305 JR2 CS36	1
7	0888040050	woodruff key DIN 6888 4x5x13	1
8	A42030118000	Crankshaft	1
9	51030034000	NEEDLE BEARING KBK 15X19X20	1
10	0888030050	WOODRUFF KEY DIN6888-3X5X13	1
11	77330082200	BEARING NJ 206 ECP/HN3C4HVA624	1
12	0760253570	SHAFT SEAL RING 25X35X7 BTSL	1
13	0710001324300	Locking ring	1
14	49030021100	Collar nut, M12x1, right	1
15	50430015044	CON-ROD REPAIR KIT	1
16	51730007000 I	Piston I cpl. 150 Enduro	x
16	51730007000 II	Piston II cpl. 150 Enduro	x
17	51630032044	PISTON RING SET 150	1
18	50330074500	WIRE LOCK RING 15X1	2
98	A43030007010 I	Pistonkit Gr.I 150 Enduro 2024	x
98	A43030007010 II	Pistonkit Gr.II 150 Enduro 2024	x
99	A42030018010	Repkit crankshaft bearing 2024	x

24A4303060

64053

\* NEW PART

X ON DEMAND

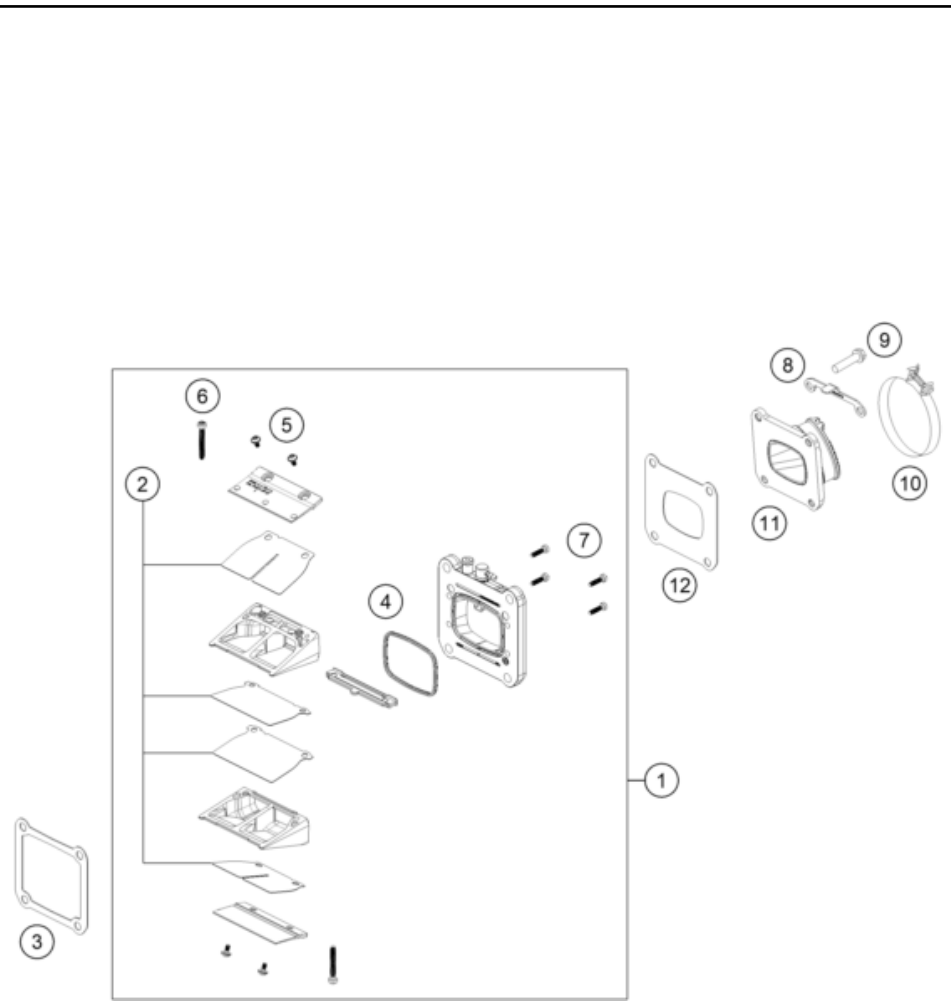

POS	PARTNUMBER		PIECE
1	A45030051044	Membrane Box cpl.	1
2	50530152044	Reed Valve Set	1
3	50430098050	GASKET REED VALVE CASE	1
4	54830153050	GASKET SUPPORTING PLATE	1
5	00810300553	EJOT DELTA PT SCREW 30X5,5	4
6	0081035253	EJOT DELTA PT SCREW 35X25	2
7	0081030124	EJOT DELTA PT SCREW 30X12	4
8	A44038065010	retaining bracket angle valve	1
9	0025060256	HH collar screw M6x25 TX30	4
10	54330061000	CLAMP 52/12 GEMI	1
11	50430050000	Intake flange	1
12	50430098060	Gasket intake flange	1

24A4303070

64077

\* NEW PART

X ON DEMAND

# CLUTCH

Engine 150 EXC 2025 2025

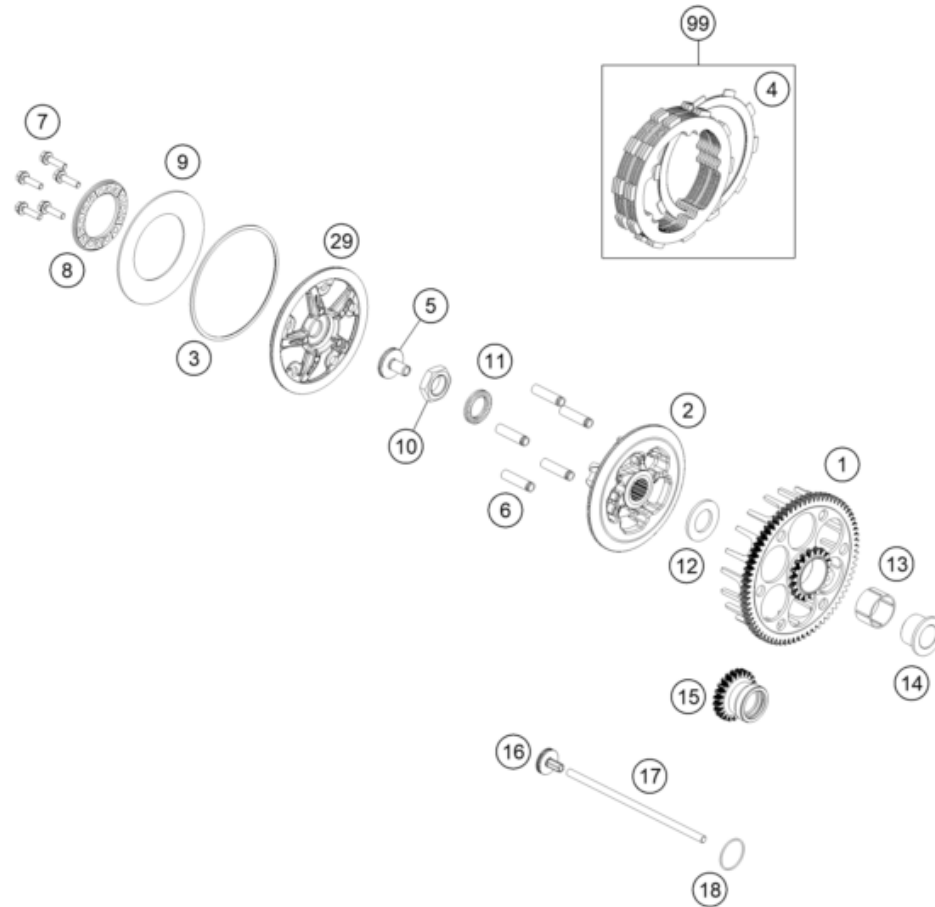

POS	PARTNUMBER		PIECE
1	50532001173	clutch basket	1
2	50532002000	Inner clutch hub	1
3	50532013000	Inner ring	1
4	50532011000	Friction plate 1.95 mm	7
5	78132057144	PRESSURE PIECE CPL.	1
6	50532004100	Sleeve 7.95x31.65	5
7	0025050206	HH collar screw M5x20 TX30	5
8	50532006000	Spring plate	1
9	50532005000	Clutch spring	1
10	0936181506	Hex nut DIN0936-M18x1.5 right	1
11	0252012002900	Wedge lock washer 19.5x29x3.4	1
12	50532017000	Supporting plate 20x36x2.5	1
13	0405263017	Needle cage K263017	1
14	50532015000	Collar 20x26x19,5	1
15	A42032023023	Primary gear wheel 23 teeth.	1
16	78032057044	PRESSURE PIECE CPL. 08	1
17	A42032054000	Push rod	1
18	0770300015	O-RING 30,00X1,50 NBR 70	1
29	50532003000	Pressure plate	1
99	50532010033	Clutch disc pack	1

24A4303210

64071

\* NEW PART

X ON DEMAND



**ACHTUNG !!!**  
 Bei Bestellung von Getrieberädern, Markierung beachten.  
**CAUTION !!!**  
 When ordering transmission gears, check marking.

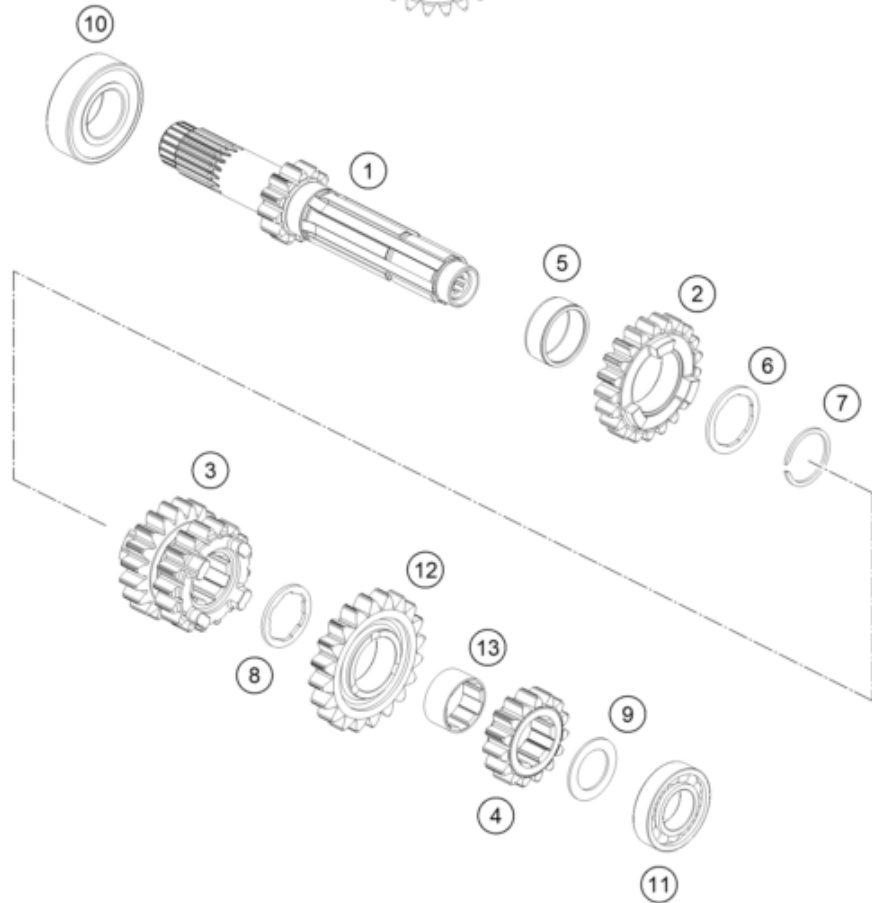
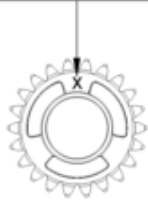

195053331

POS	PARTNUMBER		PIECE
1	50533101000	Drive shaft assy. not=12	1
2	50533105000	Idler gear, 5th gear, teeth=21	1
3	50533103000	Sliding gear, 3rd/4th gear, teeth=17/19	1
4	50533102000	Fixed gear, 2nd gear, teeth=15	1
5	0405222611	NEEDLE BEAR.K 22X26X10 DIVIDED	1
6	50533034000	Thrust washer	1
7	50133090000	LOCK RING 22X1,2	1
8	50533033000	Thrust washer	1
9	50333041000	STOP DISC 17,2X26X1 B	1
10	0625060041	BALL BEARING 6004 TNH C3	1
11	0625160031	GROOVED BALL B. 16003 C4 J1	1
12	50533106000	Idler gear, 6th gear, teeth=20	1
13	50533024000	bushing	1

53025

\* NEW PART

X ON DEMAND

**ACHTUNG !!!**  
 Bei Bestellung von Getrieberädern, Markierung beachten.  
**CAUTION !!!**  
 When ordering transmission gears, check marking.

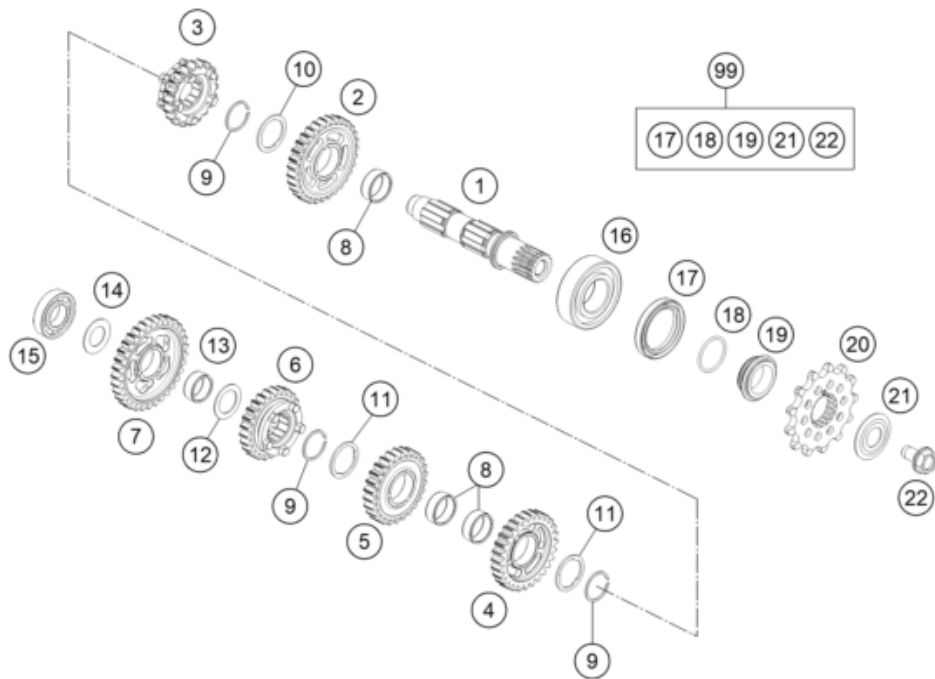
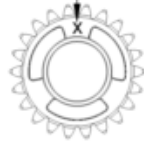

24A4303360

POS	PARTNUMBER		PIECE
1	50533010100	pinion shaft	1
2	50533112000	Idler gear, 2nd gear, teeth=31	1
3	50533116000	Sliding gear, 6th gear, teeth=20	1
4	50533013000	Idler gear, 3rd gear, not=28	1
5	50533114000	Idler gear, 4th gear, teeth=26	1
6	50533115000	Sliding gear, 5th gear, teeth=25	1
7	50533111000	Idler gear, 1st gear, teeth=33	1
8	0405222611	NEEDLE BEAR.K 22X26X10 DIVIDED	3
9	0417024000	CIRCLIP WS24	3
10	77733044000	STOP DISC 24X32X1,5	1
11	77733043000	STOP DISC 23,4X31X1,5	2
12	54833080000	STOP DISC 20,2X30X1	1
13	0405202410	NEEDLE BEARING K20X24X10	1
14	56033030000	STOP DISC 17,2X30X1	1
15	0625160031	GROOVED BALL B. 16003 C4 J1	1
16	0625062054	BALL BEARING 6205 C3 NTN	1
17	0760324571	SHAFT SEAL RING 32X45X7 BSLNBR	1
18	0770020220	O-RING 25,12X1,78 NBR70	1
19	78133014000	SPACER SLEEVE COUNTER	1
20	A46033029013	Front sprocket 13 teeth	1
21	59033034000	SPRING WASHER 17,2X40X1,5	1
22	59033029000	HH COLLAR SCREW M10X18 10.9	1
99	50533010110	Counter shaft repair kit 125/150cc	1

72559

\* NEW PART

X ON DEMAND

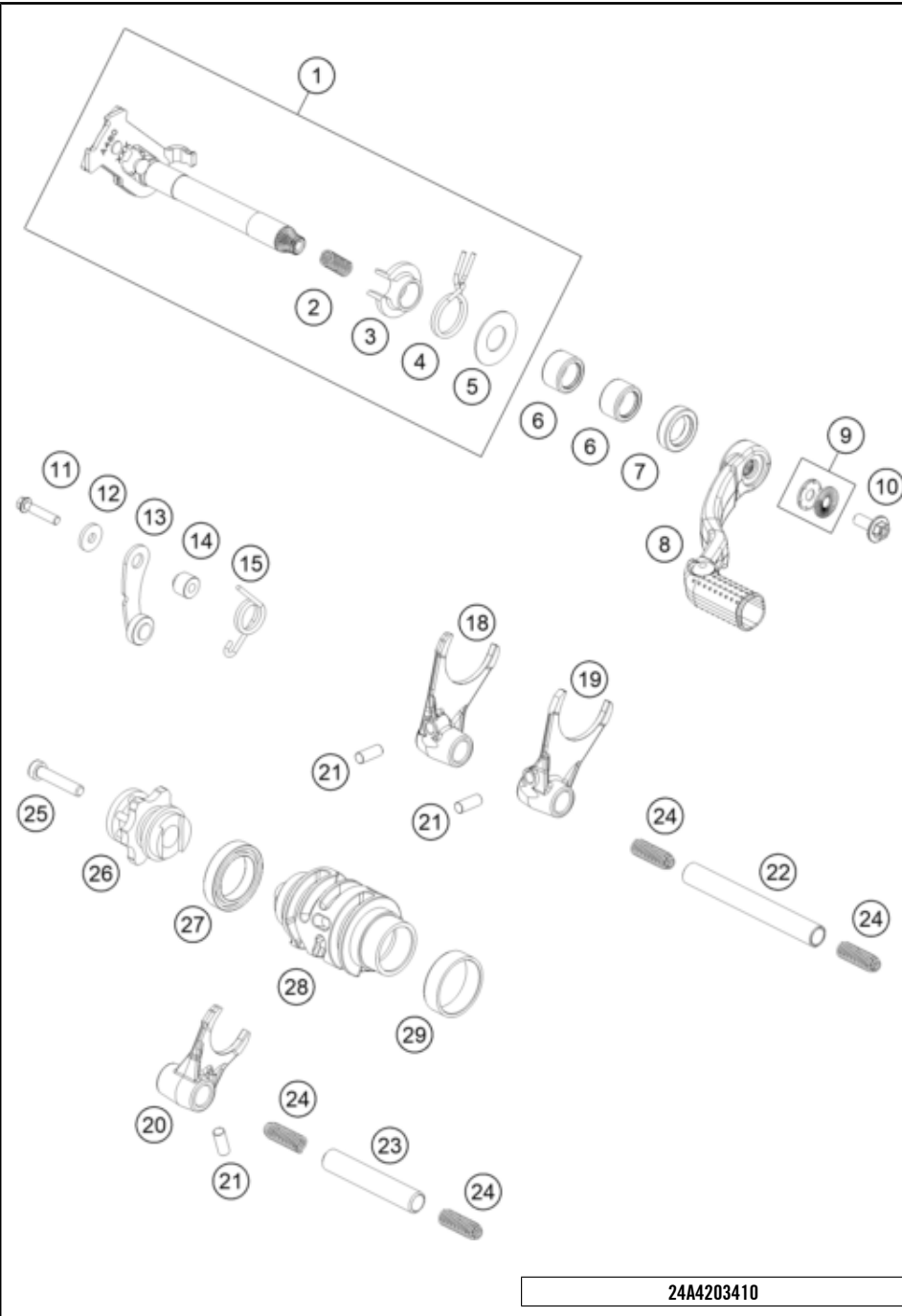

POS	PARTNUMBER		PIECE
1	A46034005033	Shift shaft cpl.	1
2	56534013100	TENSIONING SPRING 0,8MM	1
3	54634020000	SPRING GUIDE	1
4	54834014000	RETURN SPRING 03	1
5	54634050000	STOP DISK 14X30X1	1
6	54632095000	needle sleeve HK 1412 14x20x12	2
7	0760142460	radial shaft seal 14x24x6 B	1
8	A42034031000	Gear shift lever complete	1
9	50233041500	PAIR NORDLOCK WASHER M6	1
10	0024060156S	HH collar screw M6x15 TX30	1
11	0025050256S	HH collar screw M5x25 TX30	1
12	0021050003	washer DIN 9021 A - 5.3	1
13	A46034024044	Detent arm cpl.	1
14	54634052300	SLEEVE FOR LOCKING LEVER	1
15	54834023000	LOCKING LEVER SPRING 03	1
18	50434003000	SHIFTING FORK 1ST/3RD GEAR	1
19	50534002000	shifting fork 2/4 gear	1
20	A42034001000	Shift fork 5/-6 gear	1
21	0402061480	NEEDLE ROLLER DIN5402 6X14,8	3
22	A46034020000	Shift fork shaft (L=66 mm)	1
23	A46034019000	Shift fork shaft (L=93 mm)	1
24	58038023400	Compression spring L=25mm D=0.9mm	4
25	0025060306S	HH collar screw M6x30 TX30	1
26	A46034015000	Shift star cpl.	1
27	0410002500700	Grooved ball bearing 6805 JR C3	1
28	A42034012000	Shift drum	1
29	79234012010	FRICTION BEARING CONTROLLER	1

24A4203410

63882

\* NEW PART

X ON DEMAND

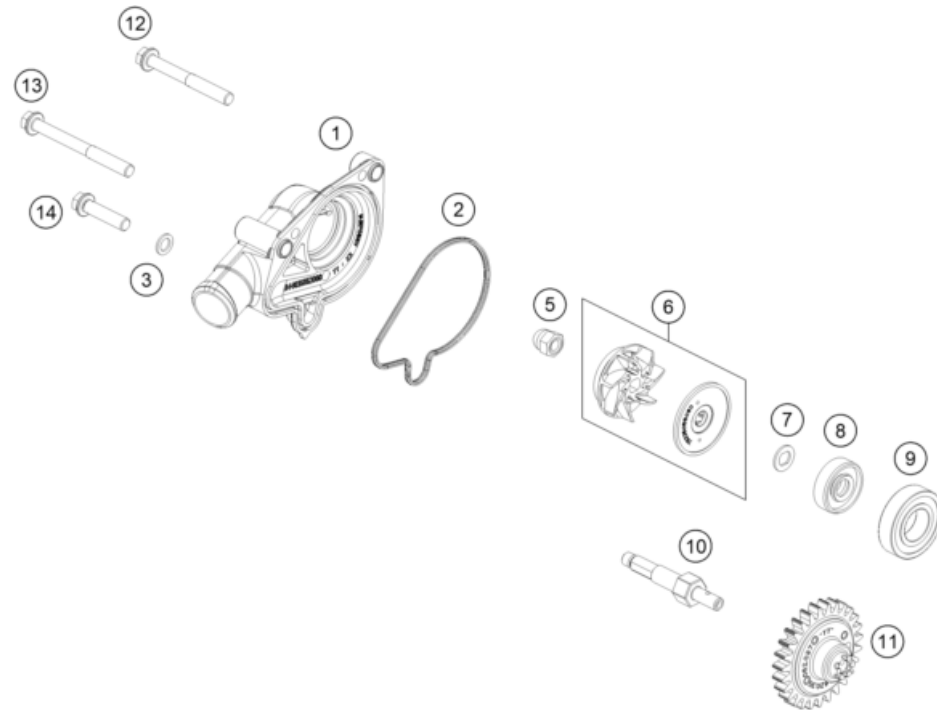

POS	PARTNUMBER		PIECE
1	A44035052000	Water pump cover	1
2	A44035052010	Water pump cover seal	1
3	0603061001	CU-seal ring DIN7603-6X10X1	1
5	61230045000	CAP NUT M6 STAINLESS STEEL	1
6	79235055044	WATER PUMP WHEEL CPL.	1
7	50435049000	PREFORMED WASHER	1
8	0760082472	SHAFT SEAL RING 8X24X7 A DUO	1
9	0625006087	GROOVED BALL BEAR. 608 2RS C3	1
10	A44035054000	Water pump shaft	1
11	A42035062027	Drive gear wheel	1
12	0025060506	HH collar screw M6x50 TX30	1
13	0025060606	HH collar screw M6x60 TX30	1
14	0025060256	HH collar screw M6x25 TX30	1

24A4303510

64064

\* NEW PART

X ON DEMAND

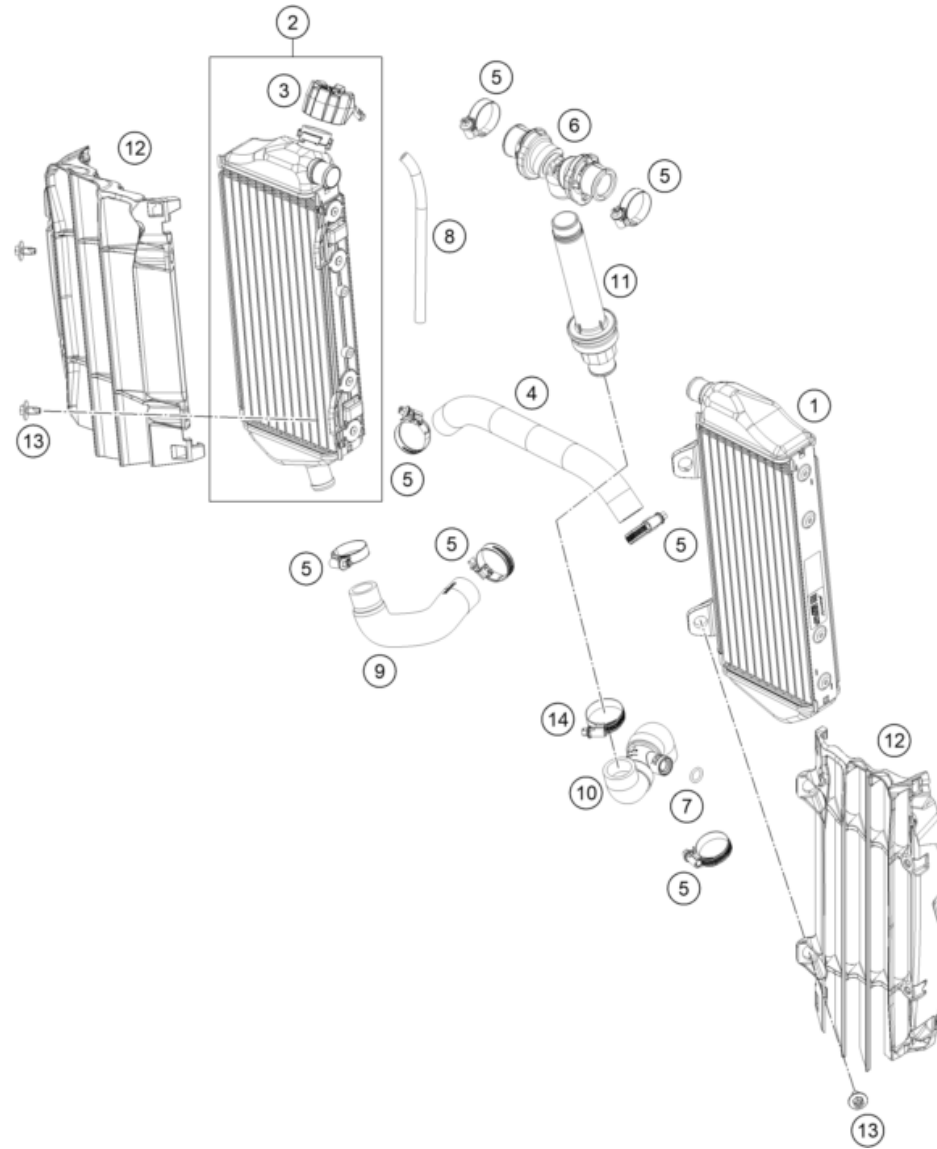

POS	PARTNUMBER		PIECE
1	A46035007000	Radiator left	1
2	A46035008000	Radiator right	1
3	A46035009000	Radiator cap	1
4	A46035025000	Pre-formed hose radiator left/right	1
5	0310000902900	Hose clip 18-29	7
6	A46035071044	Y-piece compl.	1
7	0770100020	o-ring 10.00x2.00 silicone	1
8	50335030001	PVC-HOSE 6X9	x
9	A44035024000	Pre-formed hose engine/radiator right	1
10	A42035020044	Hose system, temperature sensor 150	1
11	A49035073033	Screw-in nozzle with thermo.re	1
12	A46035036044C1	Radiator protection set, black	1
13	0900000601203	HH ISR collar screw M6x12-10.9 ISA30	4
14	0310000903200	Hose clip 20-32	1

24A4303530

64089

\* NEW PART

X ON DEMAND

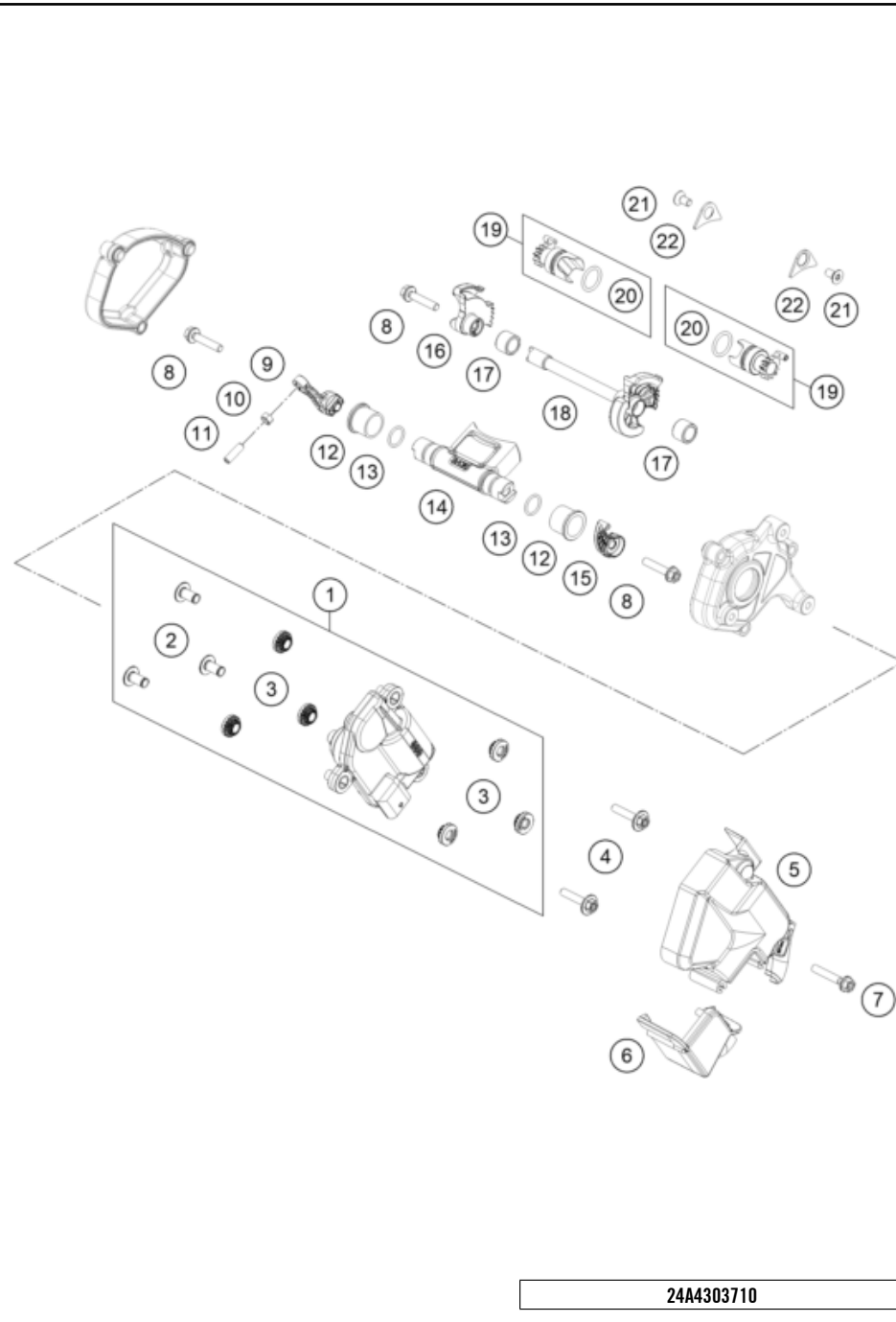

POS	PARTNUMBER		PIECE
1	A45041072033	Exhaust control actuator cpl.	1
2	A45041072010	Actuator bushing	3
3	A45041072005	Damper actuator	6
4	0000240502500S	HH collar screw, M5x25, ISA 30	2
5	A42037096000	Actuator protection cap	1
6	A42037096020	Actuator protection cap	1
7	0025050306	HH COLLAR SCREW M5X30 TX30	1
8	0025050256S	HH collar screw M5x25 TX30	3
9	A42037057000	Control lever	1
10	0934050040	Nut M5 SW7	1
11	0913050160	Grub screw M5x16 with AH	1
12	50437023100	exhaust flap bushing	2
13	07700120151	O-ring 12x1.5 FPM75	2
14	A43037020000	Control flap	1
15	A42037080000	Control flap lever	1
16	A42037065000	Slotted lever rh	1
17	0618101410	needle sleeve HK 1010 10x14x10	2
18	A42037070033	Idler shaft cpl.	1
19	A42037063000	Exhaust roller rh	2
20	0770140201	O-RING 14X2 FPM 75SH	2
21	0019050106S	hex lobe countersunc screw M5x10 - 10.9	2
22	75030085100	Retaining bracket crankshaft bearing	2

24A4303710

64062

\* NEW PART

X ON DEMAND

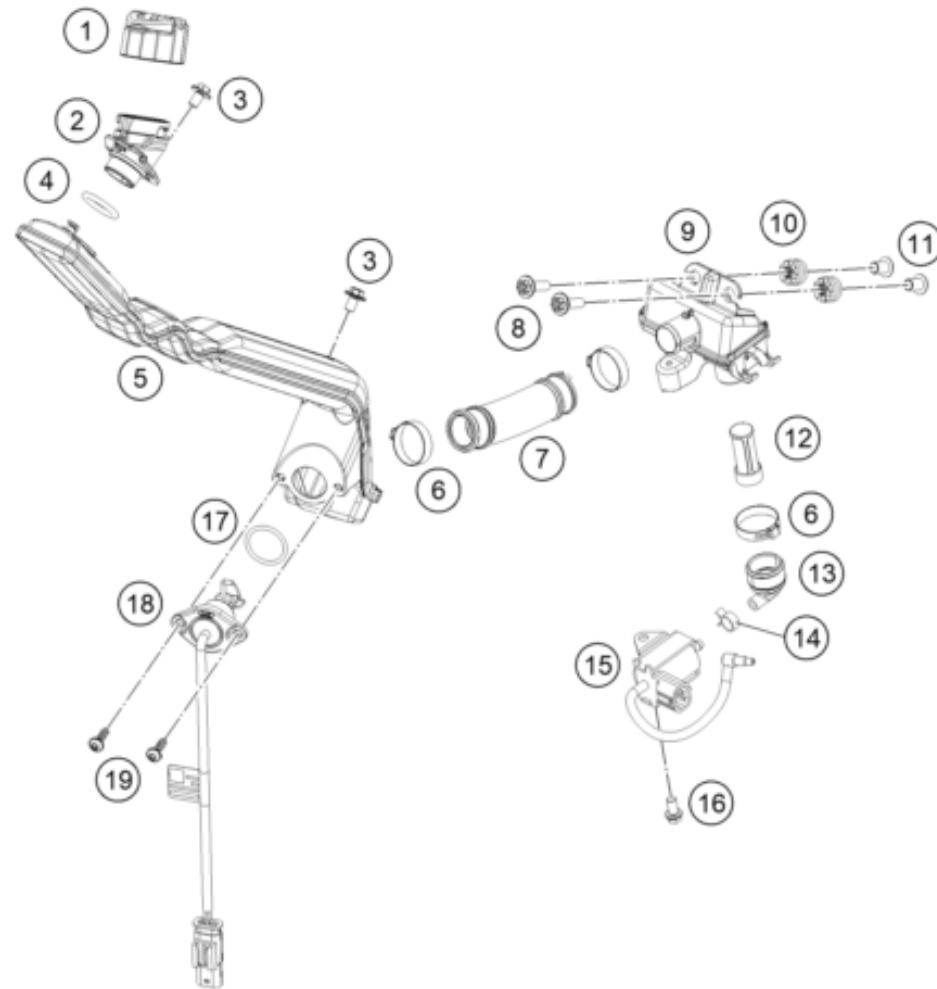

POS	PARTNUMBER		PIECE
1	55638070033	Oilfillercap cpl.	1
2	A45038061030	Oil tank filler neck	1
3	0024060106S	Hex collar screw M6x10 ISA30	2
4	0770202353	O-RING 20,22X3,53 NBR70	1
5	A45038061205	Oil tank breast pipe	1
6	00050271708	VARIABLE ONE-EAR CLAMP 27,1MM	3
7	A45038061210	Hose oil tank	1
8	0024060206	HH collar screw M6x20 TX30	2
9	A45038061020	Oil tank, shock absorber seat	1
10	76014069051	RUBBER SLEEVE 7X10,8X16MM	2
11	76014062000	COLLAR BUSHING 6,2X7,5X13X12	2
12	61238016200	Oil screen	1
13	A45038061060	Angle piece, oil tank	1
14	59007017000	CLAMP YDNAC 10096F (9,6MM)	1
15	55638064000	Oil pump	1
16	0025060126S	Hex collar screw M6x12 ISA30 self-lockin	1
17	07700240251	o-ring 24.00x2.50 Viton	1
18	A45038062000	Oil lever sensor	1
19	0081050181	SCREW FOR PLASTIC K50X18 T20	2

24A4303810

64093

\* NEW PART

X ON DEMAND

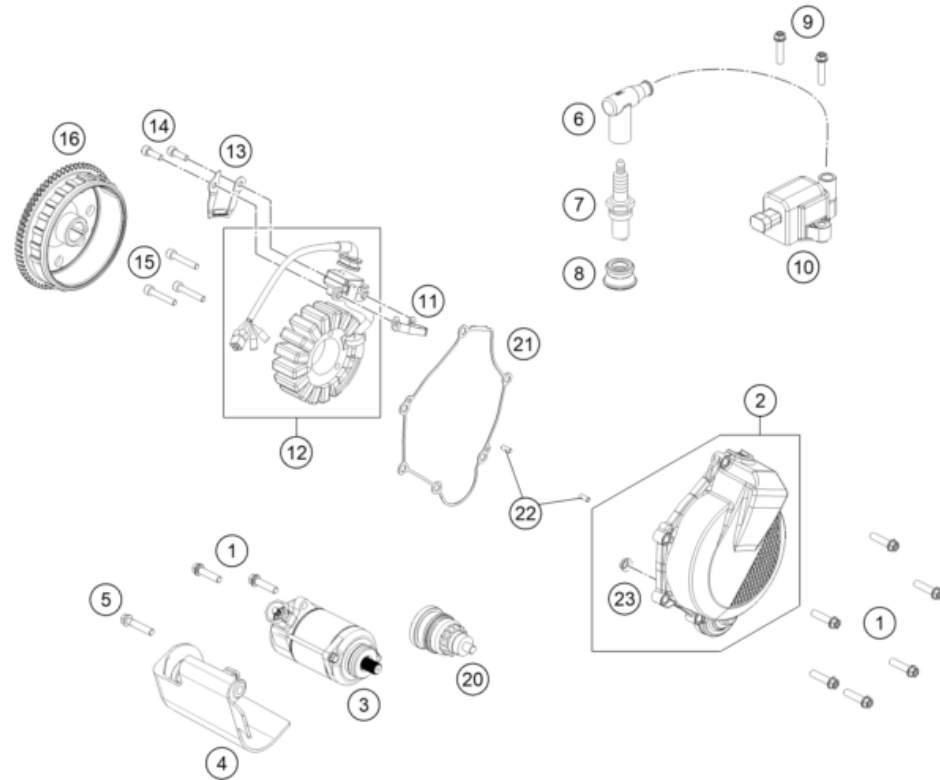

POS	PARTNUMBER		PIECE
1	0025060256	HH collar screw M6x25 TX30	8
2	A43030102044C1	Generator Cover	1
3	A42040001000	Starter motor	1
4	A42040040000	Starter motor cover	1
5	0025060306	HH collar screw M6x30 TX30	1
6	A44039007100	Ignition cable	1
7	51539093000	SPARK PLUG	1
8	51739091000	Sealing boot	1
9	0025060256	HH collar screw M6x25 TX30	2
10	55639006000	Ignition coil	1
11	A42039004010	Pick UP hanger	1
12	79239304000	Stator	1
13	A46030502050	Cable retainer	1
14	0014050163	HH COLLAR SCREW M 5X16 WS=6	2
15	0912050303	AH SCREW DIN0912-M 5X30	3
16	A43039305000	Rotor	1
20	50440026000	Bendix	1
21	A42030040000	Ignition cover gasket	1
22	0402040980	NEEDLE ROL.DIN5402 NRB 4X9,8	2
23	55540031000	Collar bushing	1

24A4303910

64052

\* NEW PART

X ON DEMAND

# THROTTLE BODY

Engine 150 EXC 2025 2025

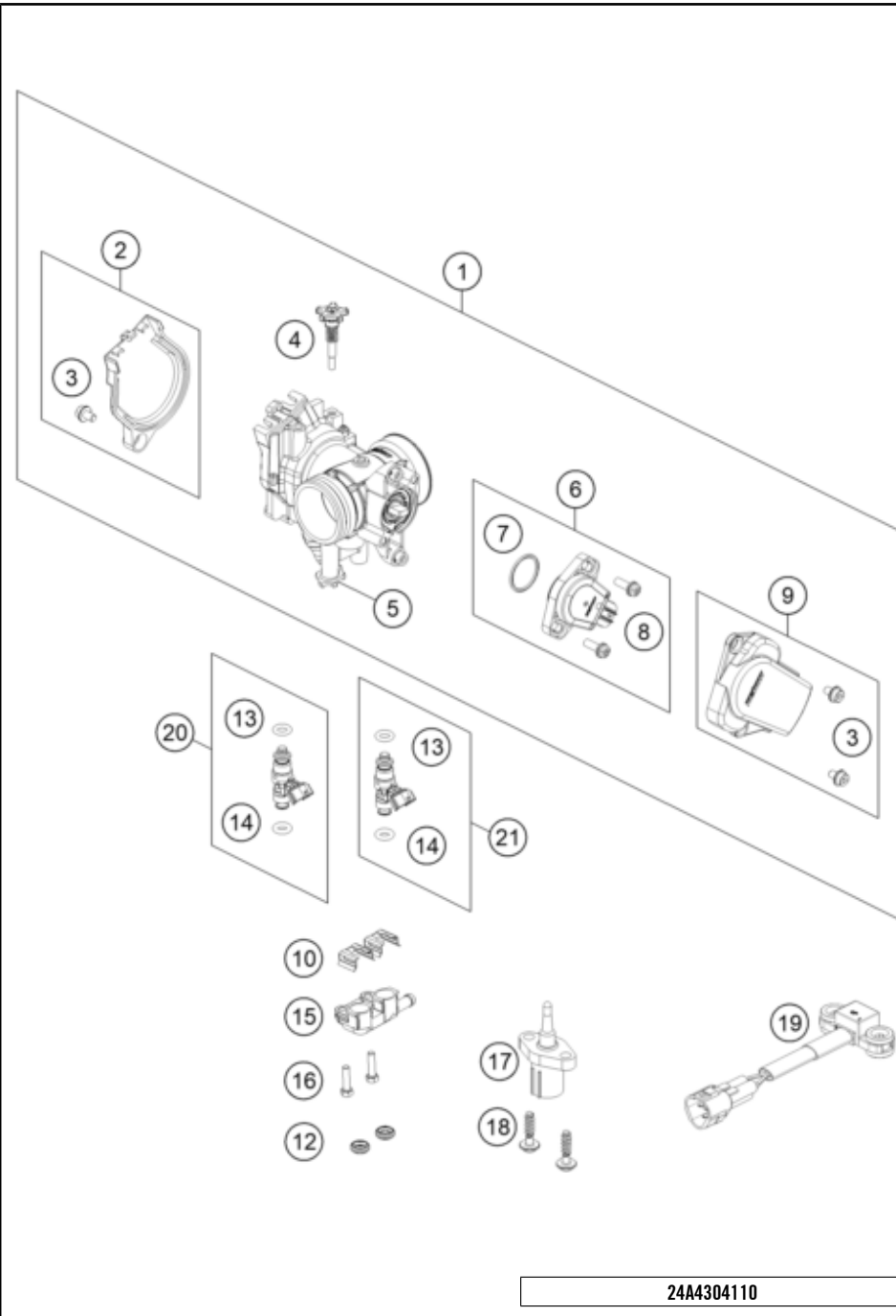

POS	PARTNUMBER		PIECE
1	A44041101000	Throttle body	1
2	79141056044	DKK Cover cpl.	1
3	79041056020	SPECIAL SCREW	3
4	A44041060044	STOP SCREW SET	1
5	79041070000	STARTER VALVE CPL.	1
6	79041077044	TPS CPL.	1
7	75041077110	O-RING	1
8	61041077020	SCREW THROTTLE POS. SENSOR	2
9	79141078044	TPS Cover cpl.	1
10	55441017000	Injector clip	2
12	55441024000	Protective ring	2
13	55641023020	O-ring	2
14	55641023010	O-ring	2
15	A42041006000	Fuel manifold	1
16	0025050166	HH collar screw M5x16 TX30	2
17	61041080000	Ambient-air temperature sensor	1
18	0081050181	SCREW FOR PLASTIC K50X18 T20	2
19	A46041088000	Roll-over sensor	1
20	A43041023044	Injector	1
21	A44041023044	Injector	1

24A4304110

68577

\* NEW PART

X ON DEMAND

A large, empty rectangular box with a thin black border, occupying the majority of the page. It is intended for handwritten or typed notes.

A large, empty rectangular box with a thin black border, occupying the majority of the page. It is intended for handwritten or typed notes.



# KTM.COM



081535YEN

KTM Sportmotorcycle GmbH  
5230 Mattighofen, Austria  
[www.ktm.com](http://www.ktm.com)



Art. Nr.: 081535YEN 4. Mär. 2024