



# SPAREPARTSCATALOG

## Engine 125 XC-W 2026 2026

ART.-NR.: 081568ZEN



All information contained is without obligation. WP Suspension GmbH particularly reserves the right to modify any equipment, technical specifications, prices, colors, shapes, materials, services, service work, constructions, equipment and the like so as to adapt them to local conditions or to cancel any of the above items, all without previous announcement and without giving reasons. WP Suspension GmbH may stop manufacturing certain models without previous notice. WP Suspension GmbH shall not be held liable for any deviations of availability and/or ability to deliver, illustrations, descriptions, printing and/or other errors. The illustrated models partly contain extra equipment, which is not applied to standard models.

© by WP Suspension GmbH, Mattighofen AUSTRIA; All rights reserved; Reprint, also in extracts, with written allowance of WP Suspension GmbH, Mattighofen only.

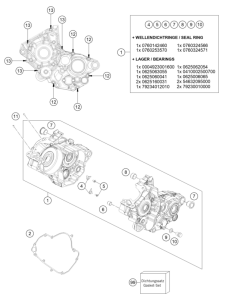
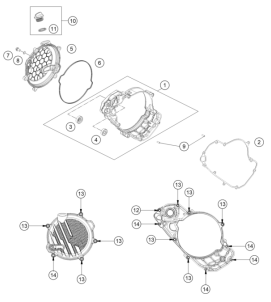
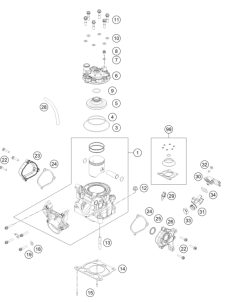
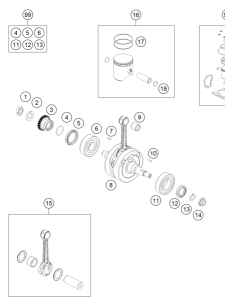
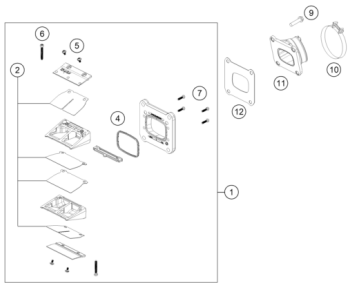
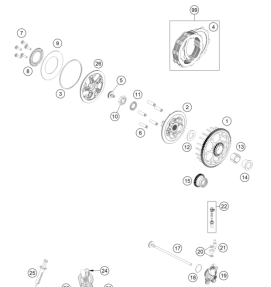
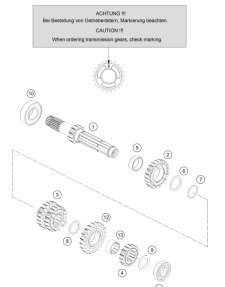
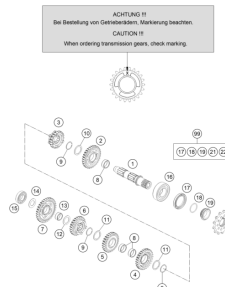
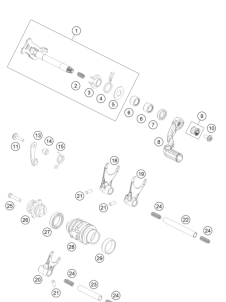
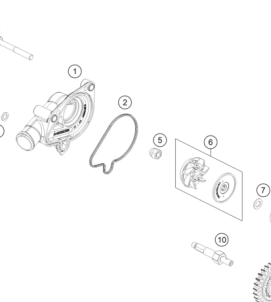
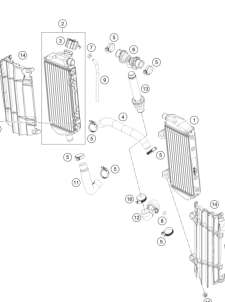
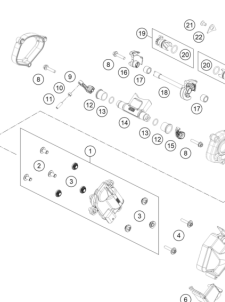
<p><b>ENGINE CASE</b></p>  <p><b>3</b></p>	<p><b>CLUTCH COVER</b></p>  <p><b>4</b></p>	<p><b>CYLINDER, CYLINDER HEAD</b></p>  <p><b>5</b></p>	<p><b>CRANKSHAFT, PISTON</b></p>  <p><b>6</b></p>
<p><b>REED VALVE CASE</b></p>  <p><b>7</b></p>	<p><b>CLUTCH</b></p>  <p><b>8</b></p>	<p><b>TRANSMISSION I - MAIN SHAFT</b></p> <p>ACHTUNG !! Bei Bestellung von Getriebeteilen, Markierung beachten. CAUTION !! When ordering transmission parts, check marking.</p>  <p><b>9</b></p>	<p><b>TRANSMISSION II - COUNTERSHAFT</b></p> <p>ACHTUNG !! Bei Bestellung von Getriebeteilen, Markierung beachten. CAUTION !! When ordering transmission parts, check marking.</p>  <p><b>10</b></p>
<p><b>SHIFTING MECHANISM</b></p>  <p><b>11</b></p>	<p><b>WATER PUMP</b></p>  <p><b>12</b></p>	<p><b>COOLING SYSTEM</b></p>  <p><b>13</b></p>	<p><b>EXHAUST CONTROL</b></p>  <p><b>14</b></p>

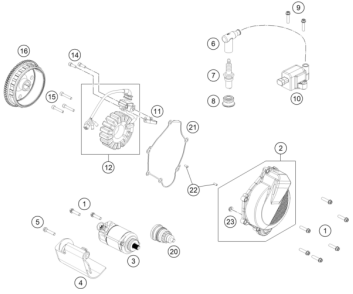
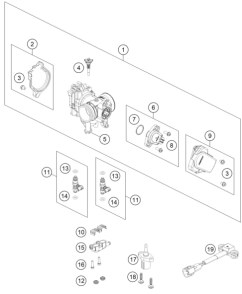
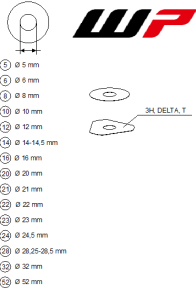
<p><b>IGNITION SYSTEM</b></p>  <p style="text-align: right;"><b>15</b></p>	<p><b>THROTTLE BODY</b></p>  <p style="text-align: right;"><b>16</b></p>	<p><b>WP SHIMS FOR SETTING</b></p>  <p style="text-align: right;"><b>17</b></p>	

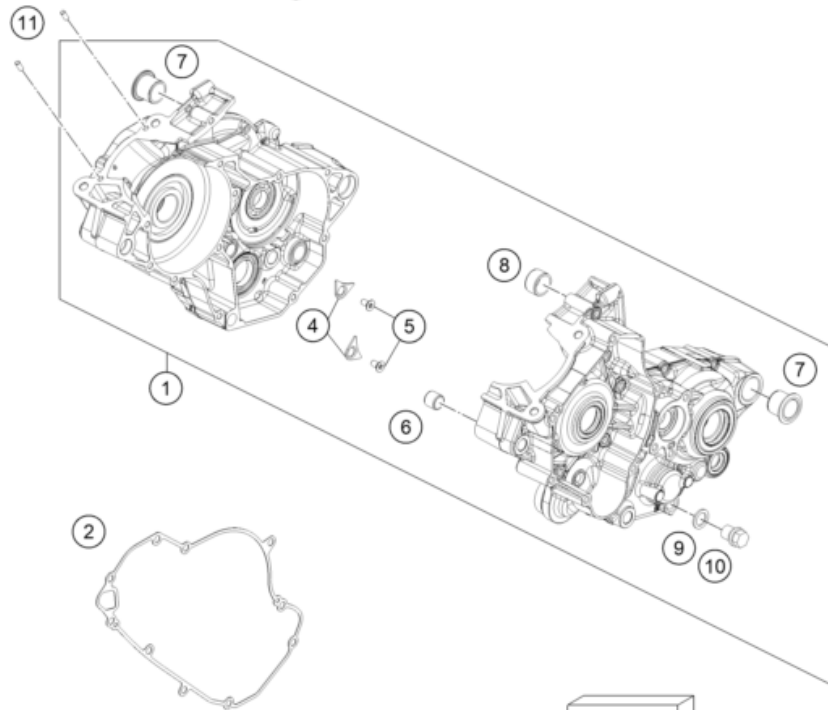
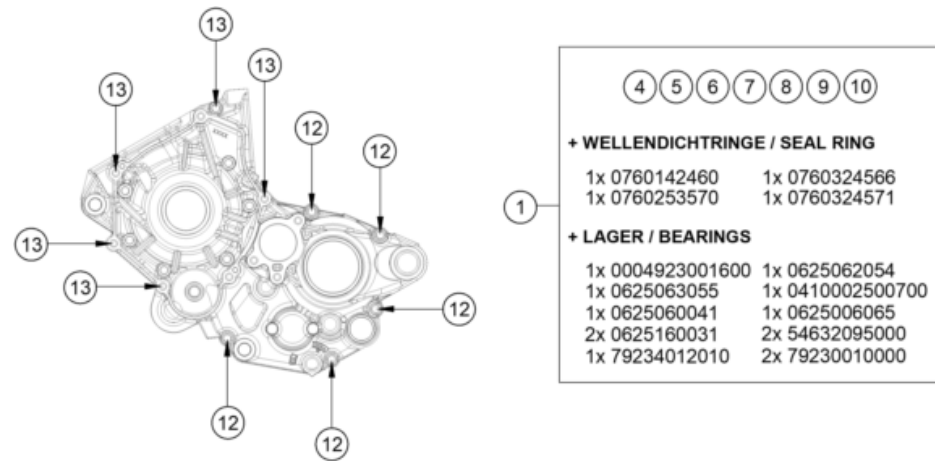

99 Dichtungssatz  
Gasket-Set

26A4203010

POS	PARTNUMBER		PIECE
1	A42030000244	Engine case cpl.	1
2	A42030025000	Clutch cover gasket, inner	1
4	75030085100	Retaining bracket crankshaft bearing	2
5	0019050106S	hex lobe countersunc screw M5x10 - 10.9	2
6	54630027000	DOWEL BUSHING 13,8X11X12	1
7	79230010000	Housing bush	2
8	54830027100	Dowel, 21x12	1
9	58038022000	CU-seal ring DIN7603-12X18X1.5	1
10	58030021000	OILDRAIN PLUG W.MAG. M 12X1,5	1
11	0402040980	Needle roll.DIN5402 NRB 4X9.8	2
12	0025060506	HH collar screw M6x50 TX30	5
13	0025060256	HH collar screw M6x25 TX30	5
99	A42030099000	Gsket kit Engine MX 125	x

79243

\* NEW PART

X ON DEMAND

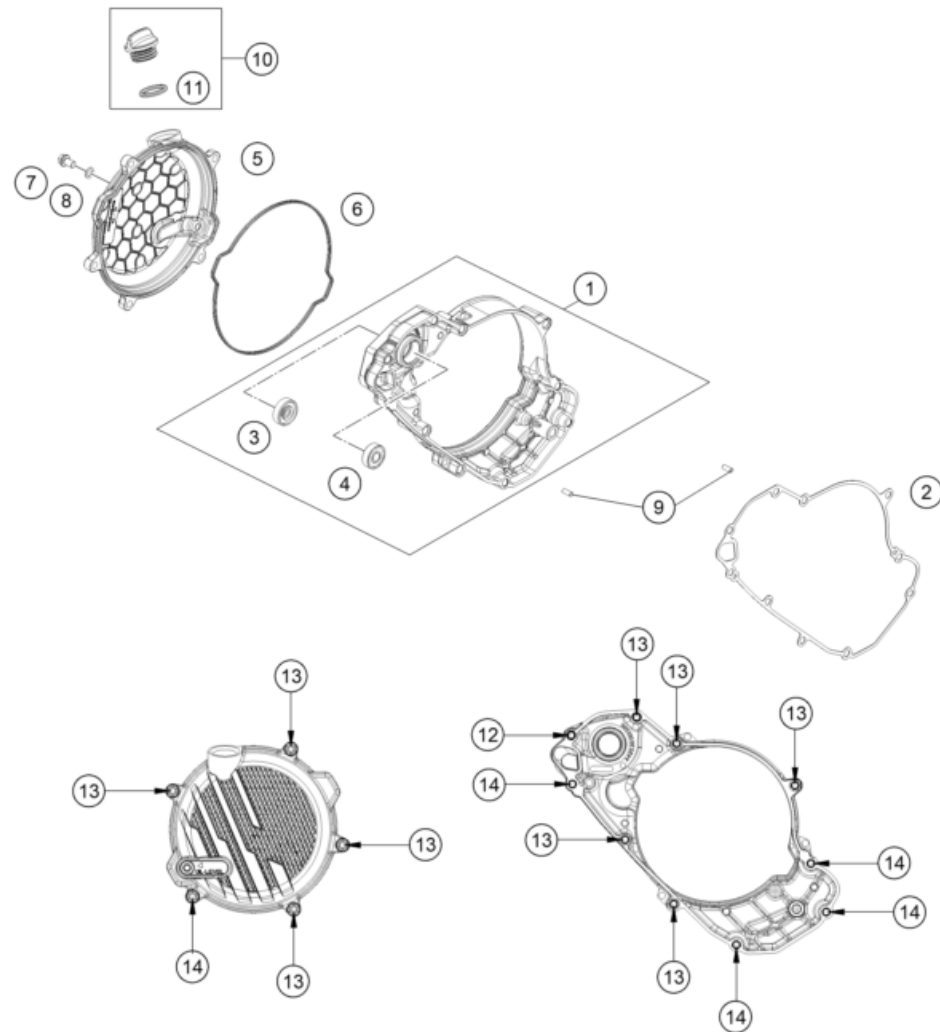

POS	PARTNUMBER		PIECE
1	A42030001044	Inner clutch cover compl.	1
2	A42030025000	Clutch cover gasket, inner	1
3	0760082472	SHAFT SEAL RING 8X24X7 A DUO	1
4	0625006087	Grooved ball bearing 608 2RS C3	1
5	A42030026000C1	Clutch cover	1
6	A42030027000	Clutch cover gasket, external	1
7	0025060106	HH collar screw M6x10 TX30	1
8	0603061001	CU-seal ring DIN7603-6X10X1	1
9	0402040980	Needle roll.DIN5402 NRB 4X9.8	2
10	79430020033	Oil filler cap compl. M24x3	1
11	0770191015	O-RING 19,00X3,00 NBR	1
12	0025060606	HH collar screw M6x60 TX30	1
13	0025060506	HH collar screw M6x50 TX30	5
14	0025060256	HH collar screw M6x25 TX30	4

23A4603020

60249

\* NEW PART

X ON DEMAND

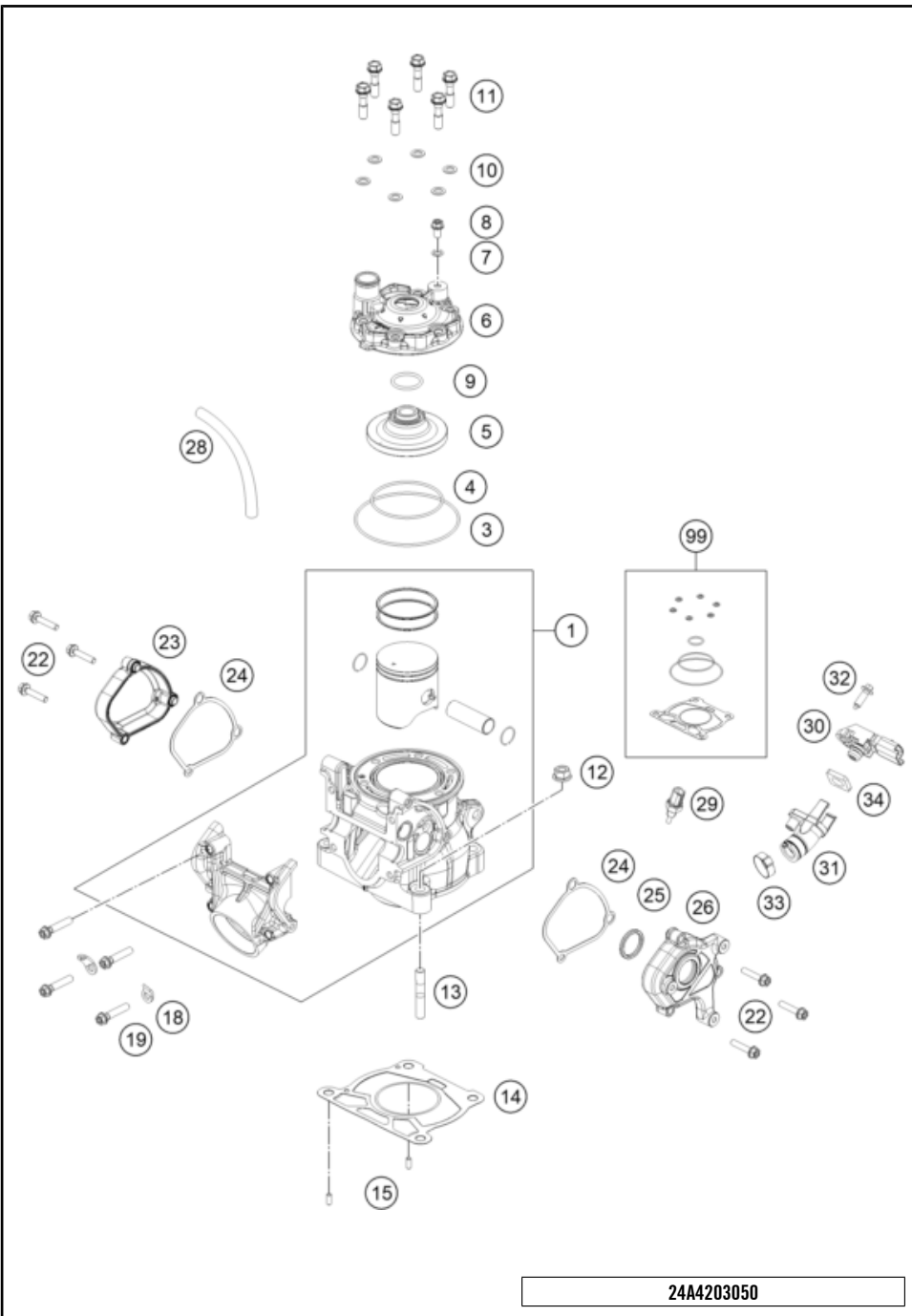

24A4203050

POS	PARTNUMBER		PIECE
1	A42030038000	cylinder + piston kpl. 125 MX	1
3	0770890200	O-ring 89X2 NBR 70 SH	1
4	0770600200	O-ring 60X2 FPM 75SH	1
5	A42030060000	Combustion chamber insert	1
6	A42030006100	Cylinder head	1
7	0603061001	CU-seal ring DIN7603-6X10X1	2
8	0025060106	HH collar screw M6x10 TX30	1
9	07702300251	O-ring 23.00X2.5 NBR 70 SH	1
10	0603070121	CU-SEAL RING DIN7603- 7,3X12X1	6
11	50430079100	Cylinder head bolt	6
12	50330045000	HH COLLAR NUT M 8 WS=12	4
13	0835080326	STUD DIN 835 M8X32	4
14	A42030035020	Cylinder base gasket	x
14	A42030035025	Cylinder base gasket	x
14	A42030035030	Cylinder base gasket	x
14	A42030035040	Cylinder base gasket	x
14	A42030035040	Cylinder base gasket	x
14	A42030035050	Cylinder base gasket	x
15	0402040980	Needle roll.DIN5402 NRB 4X9.8	4
18	51005074000	RETAINING PLATE	2
19	0025060256	HH collar screw M6x25 TX30	4
22	0025050256	HH COLLAR SCREW M5X25 ISA30	6
23	A42037007000	exhaust regulation cover rh	1
24	A42037006000	Gasket, control lid left	2
25	0770002226200	X-ring 21.89x2.62 FKM 70	1
26	A42037005000	exhaust regulation cover lh	1
28	A42030087000	Engine vent hose	x
29	79435047000	Water temperature sensor	1
30	A45041075000	Crank case pressure sensor	1
31	A44041087000	Pressure sensor flange	1
32	0017060206	SCREW F. PLASTIC K60X20AL SW6	1
33	00050210706	VARIABLE ONE-EAR CLAMP 21,0MM	1
34	A45041075050	Pressure sensor EPDM plate	1
99	A42030097000	Sealkit Cylinder MX 125	x

79249

\* NEW PART

X ON DEMAND

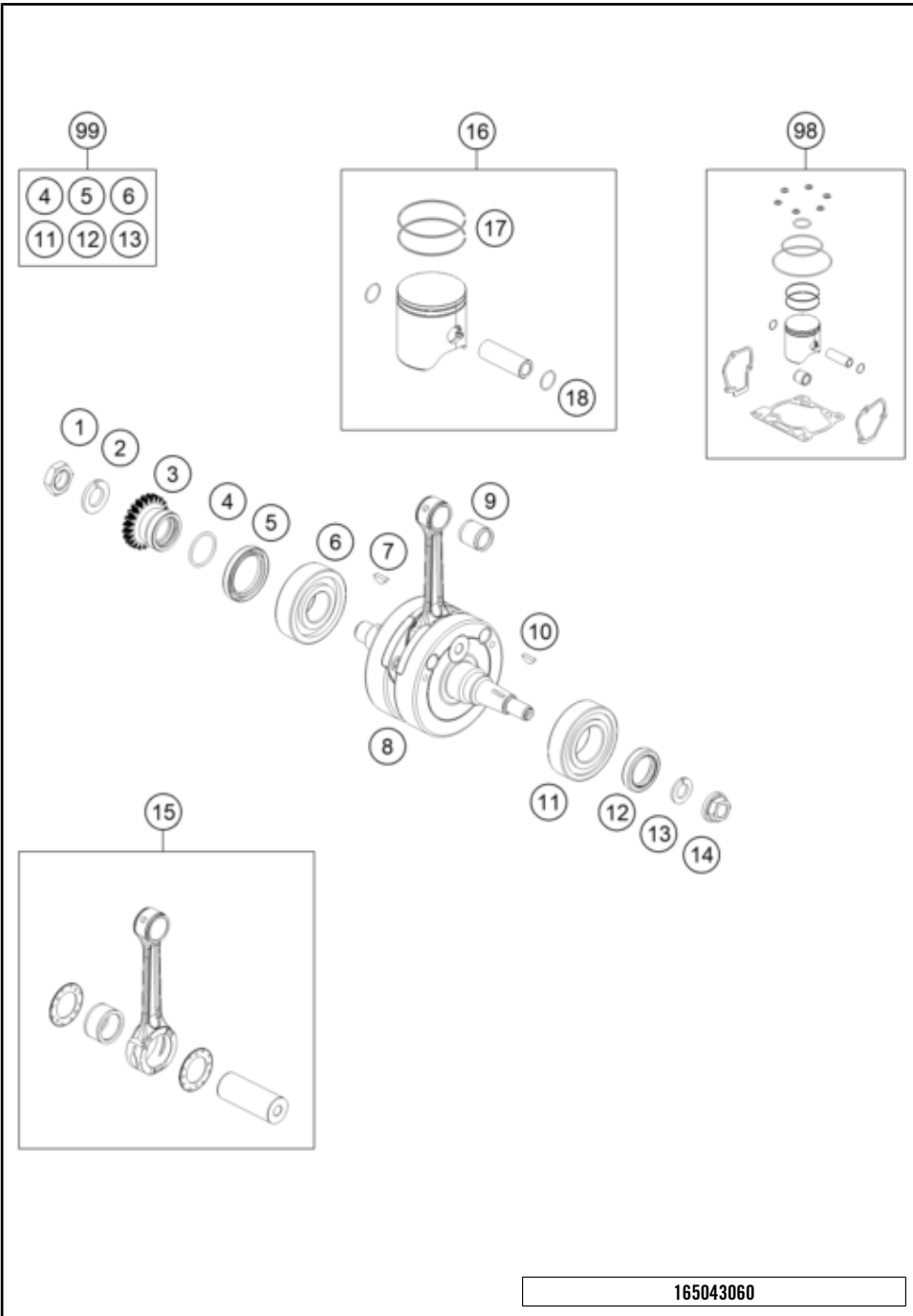

POS	PARTNUMBER		PIECE
1	0910001801001S	Nut M18x1.5 Precote LH thread	1
2	50230029016	LOCKING RING VSK 16	1
3	A42032023023	Primary gear wheel 23 teeth.	1
4	0770250020	O-RING 25,00X2,00 NBR 70	1
5	0760324564	SHAFT SEAL RING 32X45X6,5 BT	1
6	0625063055	BALL BEARING 6305 JR2 CS36	1
7	0888040050	woodruff key DIN 6888 4x5x13	1
8	A42030118000	Crankshaft	1
9	51030034000	NEEDLE BEARING KBK 15X19X20	1
10	0888030050	WOODRUFF KEY DIN6888-3X5X13	1
11	0004923001600	Roller bearing	1
12	0760253570	SHAFT SEAL RING 25X35X7 BTSL	1
13	0710001324300	Locking ring	1
14	49030021000	COLLAR NUT M12X1 R/S	1
15	50430015044	CON-ROD REPAIR KIT	1
16	50530007000 I	Piston I cpl. 125 MX	x
16	50530007000 II	Piston II cpl. 125 MX	x
17	50330032600	TRAPEZOID RING 125 2008	2
18	50330074500	WIRE LOCK RING 15X1	2
98	A42030007010 I	Pistonkit Gr.I MX 125	x
98	A42030007010 II	Pistonkit Gr.II MX 125	x
99	A42030018010	Repkit crankshaft bearing 2024	x

165043060

79250

\* NEW PART X ON DEMAND

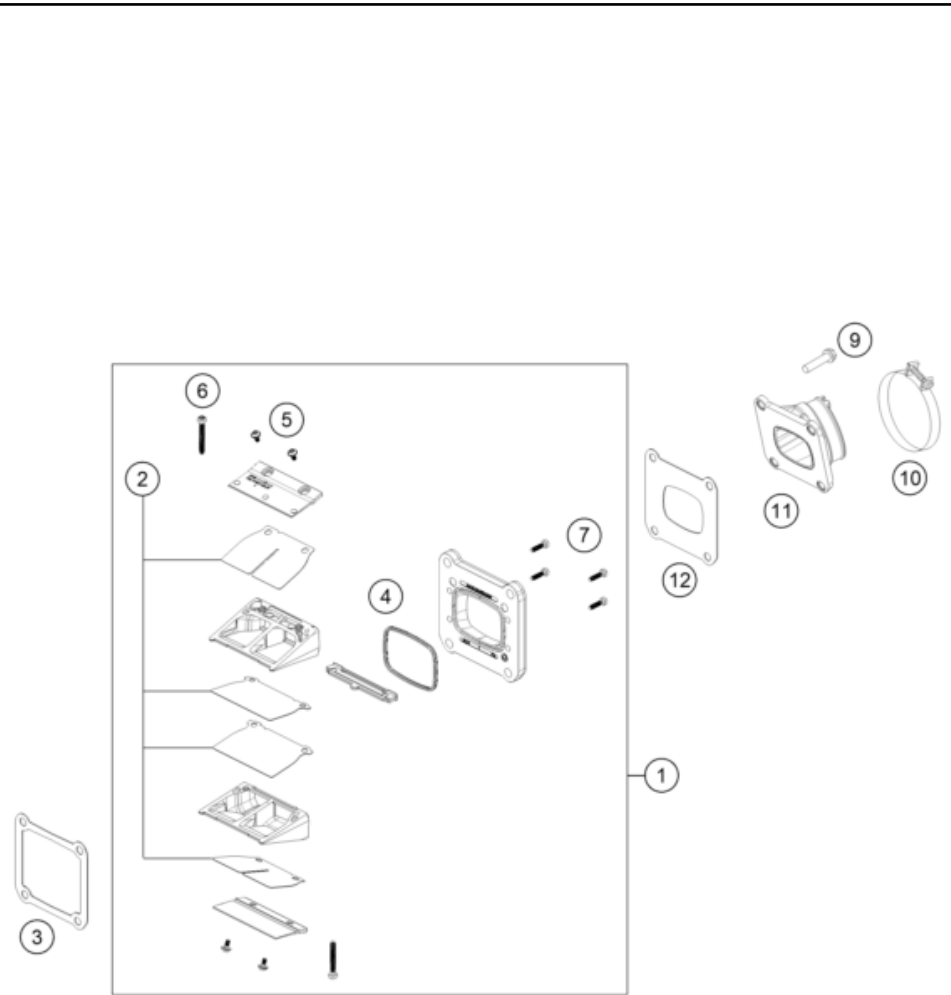

POS	PARTNUMBER		PIECE
1	A44030051044	Reed valve case compl.	1
2	50530152044	Reed Valve Set	1
3	50430098050	GASKET REED VALVE CASE	1
4	54830153050	GASKET SUPPORTING PLATE	1
5	00810300553	EJOT DELTA PT SCREW 30X5,5	4
6	0081035253	EJOT DELTA PT SCREW 35X25	2
7	0081030124	EJOT DELTA PT SCREW 30X12	4
9	0025060256	HH collar screw M6x25 TX30	4
10	54330061000	Hose clip GEMI 52mm	1
11	50430050000	Intake flange	1
12	50430098060	Gasket intake flange	1

23A4603070

60197

\* NEW PART

X ON DEMAND

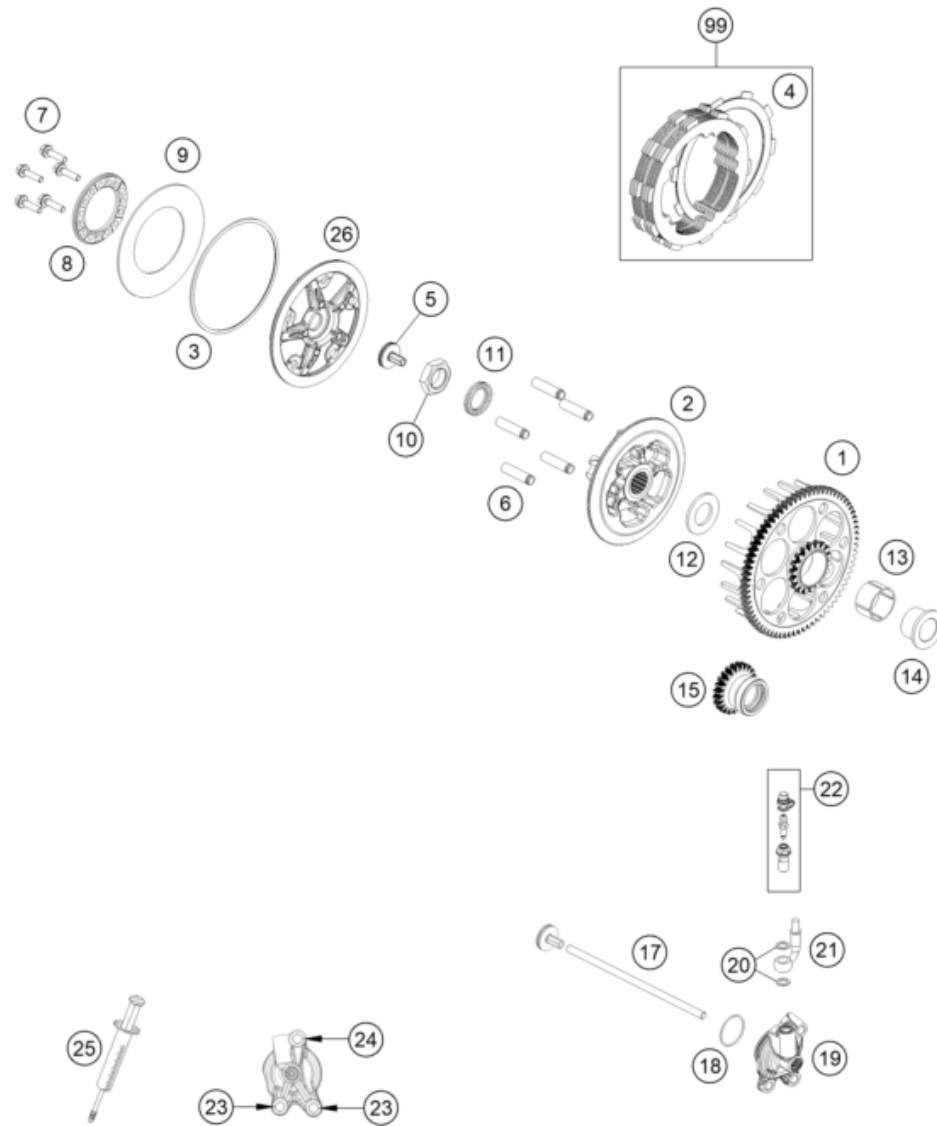

POS	PARTNUMBER		PIECE
1	50532001073	clutch basket SX	1
2	50532002000	Inner clutch hub	1
3	50532013000	Inner ring	1
4	50532011000	Friction plate 1.95 mm	7
5	78132057144	PRESSURE PIECE CPL.	1
6	50532004000	Sleeve 7.95x31.65	5
7	0025050206	HH collar screw M5x20 TX30	5
8	50532006000	Spring plate	1
9	50532005000	Clutch spring	1
10	0936181506	Hex nut DIN0936-M18x1.5 right	1
11	0252012002900	Wedge lock washer 19.5x29x3.4	1
12	50532017000	Supporting plate 20x36x2.5	1
13	0405263017	Needle cage K263017	1
14	50532015000	Collar 20x26x19,5	1
15	50532023023	gear primary drive	1
17	A42032054000	Push rod	1
18	0770300015	O-ring 30x1.5 NBR 70	1
19	79232061044	OUTPUT CYLINDER CPL.	1
20	0603082121	SEAL RING CU DIN7603- 8X12X1	2
21	79232063000	CLUTCH PIPE	1
22	79032064000	BLEEDER SCREW CPL.	1
23	0025060166	HH collar screw M6x16 TX30	2
24	0025060256	HH collar screw M6x25 TX30	1
25	50329050000	Vent injektion hydr. clutch	1
26	50532003000	Pressure plate	1
99	50532110033	Clutch disc pack	1

25A4603210

72590

\* NEW PART

X ON DEMAND

**ACHTUNG !!!**  
 Bei Bestellung von Getrieberädern, Markierung beachten.  
**CAUTION !!!**  
 When ordering transmission gears, check marking.

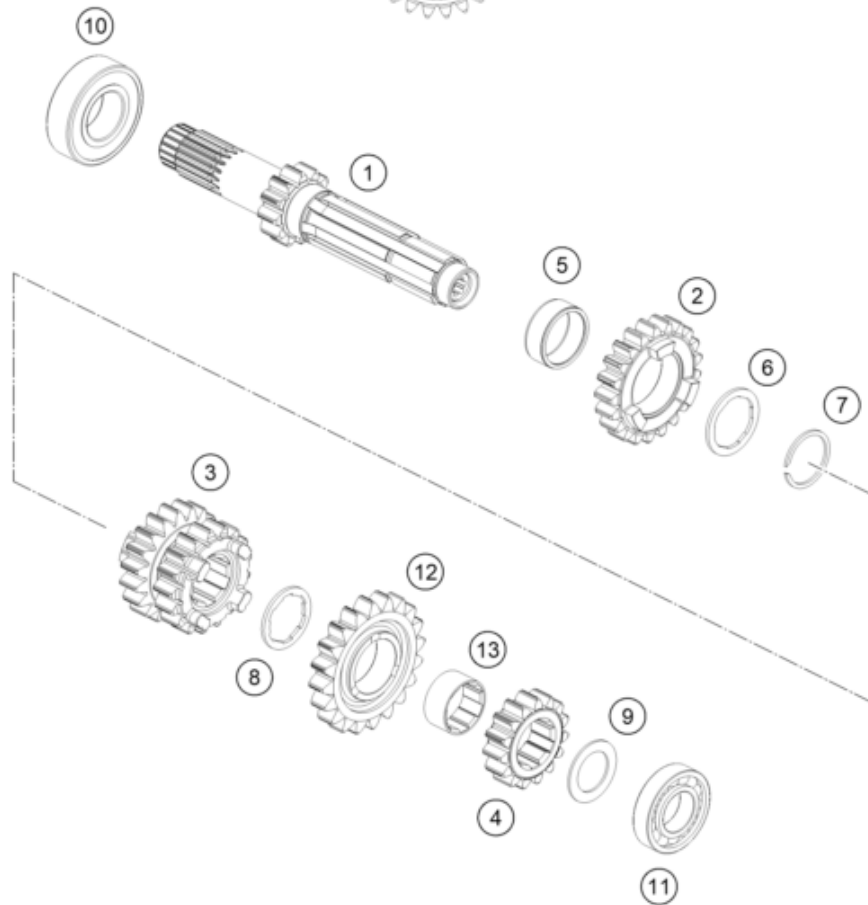
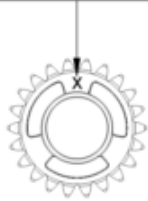

195053331

POS	PARTNUMBER		PIECE
1	50533101000	Drive shaft assy. not=12	1
2	50533105000	Idler gear, 5th gear, teeth=21	1
3	50533103000	Sliding gear, 3rd/4th gear, teeth=17/19	1
4	50533102000	Fixed gear, 2nd gear, teeth=15	1
5	0405222611	NEEDLE BEAR.K 22X26X10 DIVIDED	1
6	50533034000	Thrust washer	1
7	50133090000	LOCK RING 22X1,2	1
8	50533033000	Thrust washer	1
9	50333041000	STOP DISC 17,2X26X1 B	1
10	0625060041	BALL BEARING 6004 TNH C3	1
11	0625160031	GROOVED BALL B. 16003 C4 J1	1
12	50533106000	Idler gear, 6th gear, teeth=20	1
13	50533024000	bushing	1

53025

\* NEW PART

X ON DEMAND

**ACHTUNG !!!**  
 Bei Bestellung von Getrieberädern, Markierung beachten.  
**CAUTION !!!**  
 When ordering transmission gears, check marking.

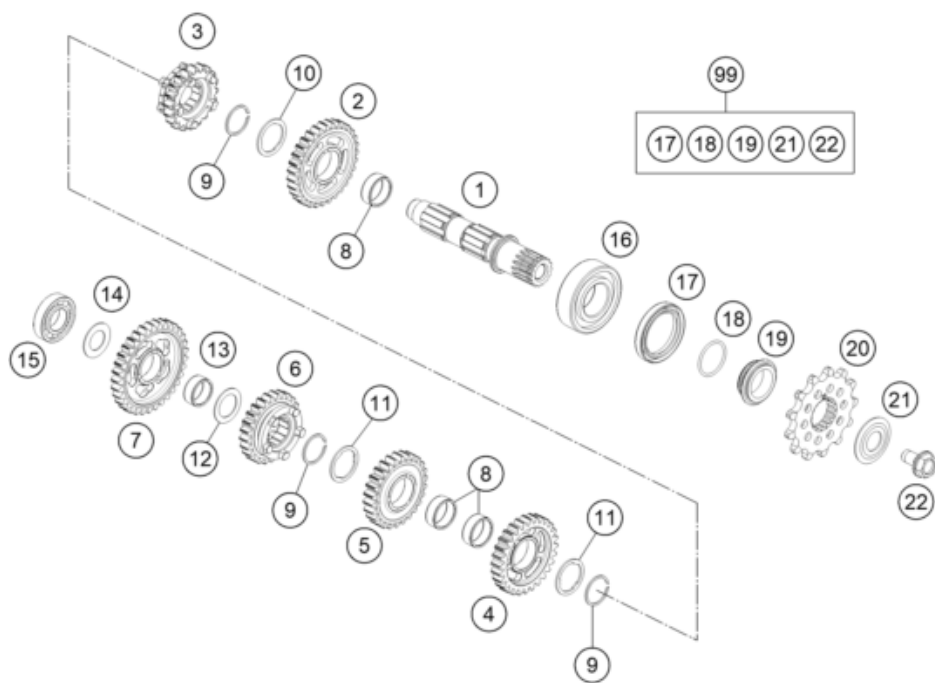
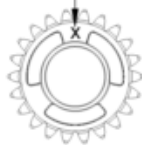

24A4303360

POS	PARTNUMBER		PIECE
1	50533010100	pinion shaft	1
2	50533112000	Idler gear, 2nd gear, teeth=31	1
3	50533116000	Sliding gear, 6th gear, teeth=20	1
4	50533013000	Idler gear, 3rd gear, not=28	1
5	50533114000	Idler gear, 4th gear, teeth=26	1
6	50533115000	Sliding gear, 5th gear, teeth=25	1
7	50533111000	Idler gear, 1st gear, teeth=33	1
8	0405222611	NEEDLE BEAR.K 22X26X10 DIVIDED	3
9	0417024000	CIRCLIP WS24	3
10	77733044000	STOP DISC 24X32X1,5	1
11	77733043000	STOP DISC 23,4X31X1,5	2
12	54833080000	STOP DISC 20,2X30X1	1
13	0405202410	NEEDLE BEARING K20X24X10	1
14	56033030000	STOP DISC 17,2X30X1	1
15	0625160031	GROOVED BALL B. 16003 C4 J1	1
16	0625062054	BALL BEARING 6205 C3 NTN	1
17	0760324571	SHAFT SEAL RING 32X45X7 BSLNBR	1
18	0770020220	O-ring 25,12X1,78 NBR70	1
19	78133014000	SPACER SLEEVE COUNTER	1
20	A46033029013	Front sprocket 13 teeth	1
21	59033034000	Spring washer 17.2X40X1.5	1
22	59033029000	HH COLLAR SCREW M10X18 10.9	1
99	50533010110	Counter shaft repair kit 125/150cc	1

72559

\* NEW PART

X ON DEMAND

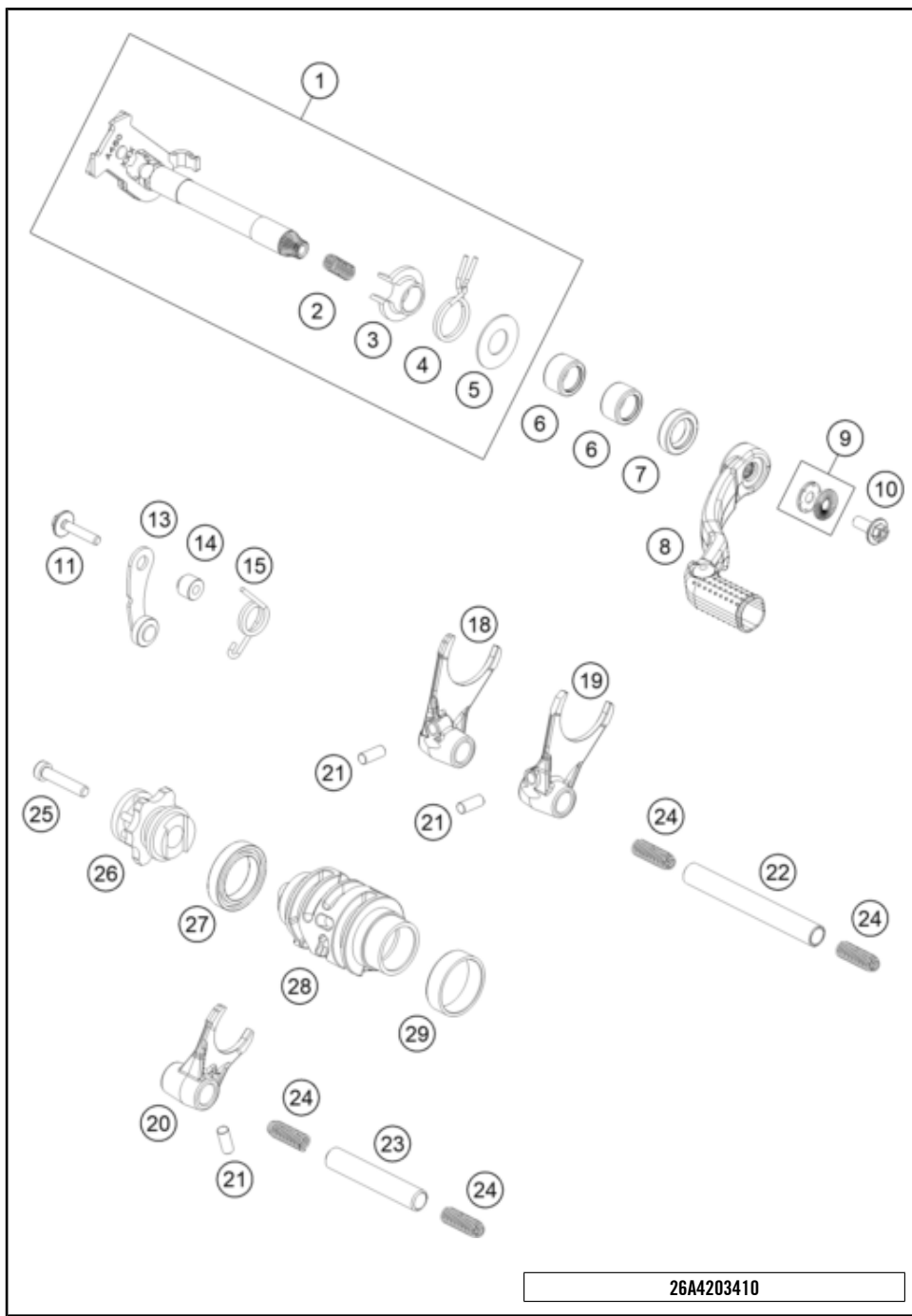

POS	PARTNUMBER		PIECE
1	A46034005033	Shift shaft cpl.	1
2	56534013100	TENSIONING SPRING 0,8MM	1
3	54634020000	SPRING GUIDE	1
4	54834014000	RETURN SPRING 03	1
5	54634050000	STOP DISK 14X30X1	1
6	54632095000	needle sleeve HK 1412 14x20x12	2
7	0760142460	radial shaft seal 14x24x6 B	1
8	A42034031000	Gear shift lever cpl.	1
9	50233041500	Pair nordlock washer M6	1
10	0024060156S	HH collar screw M6x15 TX30	1
11	0000240502500S	HH collar screw, M5x25, ISA 30	1
13	A46034024044	Detent arm cpl.	1
14	54634052300	SLEEVE FOR LOCKING LEVER	1
15	54834023000	LOCKING LEVER SPRING 03	1
18	50434003000	SHIFTING FORK 1ST/3RD GEAR	1
19	50534002000	shifting fork 2/4 gear	1
20	A42034001000	Shift fork 5/-6 gear	1
21	0402061480	NEEDLE ROLLER DIN5402 6X14,8	3
22	A46034020000	Shift fork shaft (L=66 mm)	1
23	A46034019000	Shift fork shaft (L=93 mm)	1
24	58038023400	Compression spring L=25mm D=0.9mm	4
25	0025060306S	HH collar screw M6x30 TX30	1
26	A46034115000	Shift star	1
27	0410002500700	Grooved ball bearing 6805 JR C3	1
28	A42034012000	Shift drum	1
29	79234012010	FRICION BEARING CONTROLLER	1

26A4203410

81167

\* NEW PART

X ON DEMAND

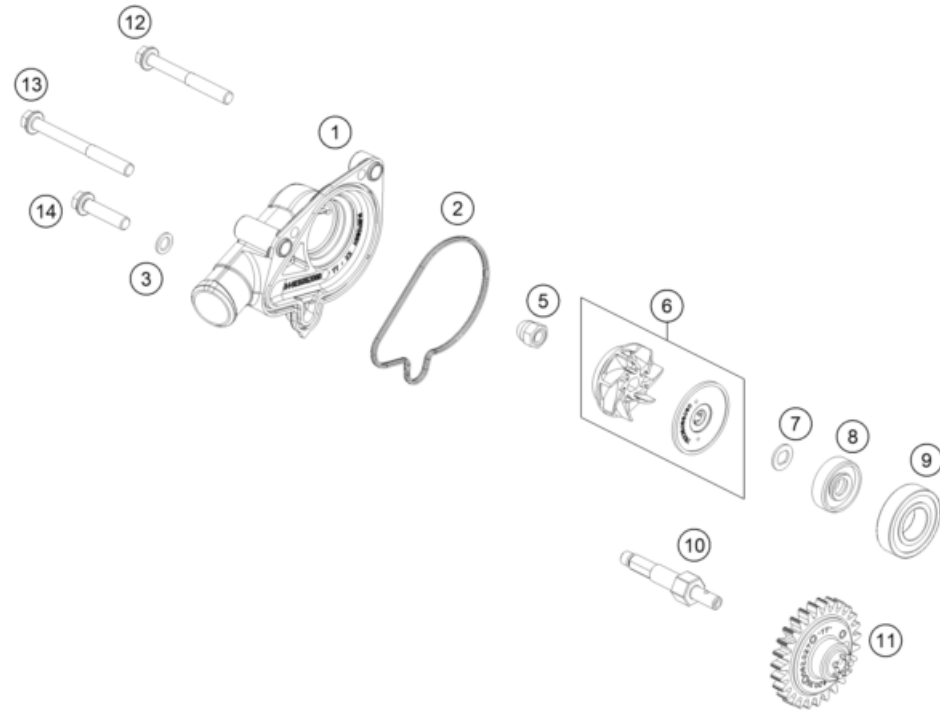

POS	PARTNUMBER		PIECE
1	A44035052000	Water pump cover	1
2	A44035052010	Water pump cover seal	1
3	0603061001	CU-seal ring DIN7603-6X10X1	1
5	61230045000	CAP NUT M6 STAINLESS STEEL	1
6	79235055044	WATER PUMP WHEEL CPL.	1
7	50435049000	PREFORMED WASHER	1
8	0760082472	SHAFT SEAL RING 8X24X7 A DUO	1
9	0625006087	Grooved ball bearing 608 2RS C3	1
10	A44035054000	Water pump shaft	1
11	A42035062027	Drive gear wheel	1
12	0025060506	HH collar screw M6x50 TX30	1
13	0025060606	HH collar screw M6x60 TX30	1
14	0025060256	HH collar screw M6x25 TX30	1

23A4603510

60270

\* NEW PART

X ON DEMAND

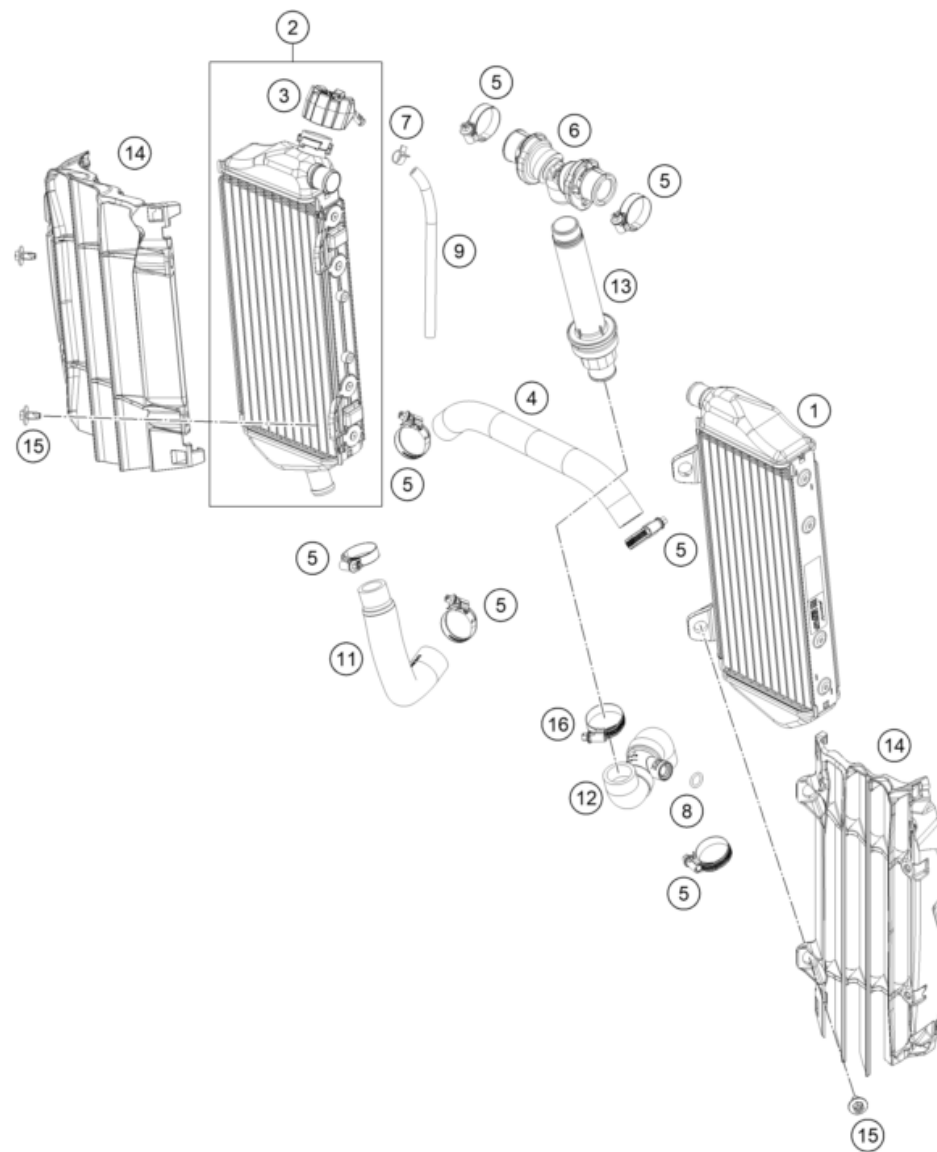

POS	PARTNUMBER		PIECE
1	A46035007000	Radiator left	1
2	A46035008100	Right radiator	1
3	72035016000	RADIATOR CAP 1,8 BAR	1
4	A46035025000	Pre-formed hose radiator left/right	1
5	10001020000	HOSE CLAMP GEMI 18-29	7
6	A46035071044	Y-piece cmpl.	1
7	59007017000	CLAMP YDNAC 10096F (9,6MM)	1
8	0770100020	o-ring 10.00x2.00 silicone	1
9	50335030001	PVC-hose 6X9	x
11	A42035024000	Pre-formed hose, engine/radiator, right	1
12	A42035020044	Hose system, temperature sensor 150	1
13	A44035073033	Threaded bushing w. thermo.	1
14	A46035036044C1	Radiator protection set, black	1
15	0900000601203	HH ISR collar screw M6x12-10.9 ISA30	4
16	0310000903200	Hose clip 20-32	1

23A4603530

79252

\* NEW PART

X ON DEMAND

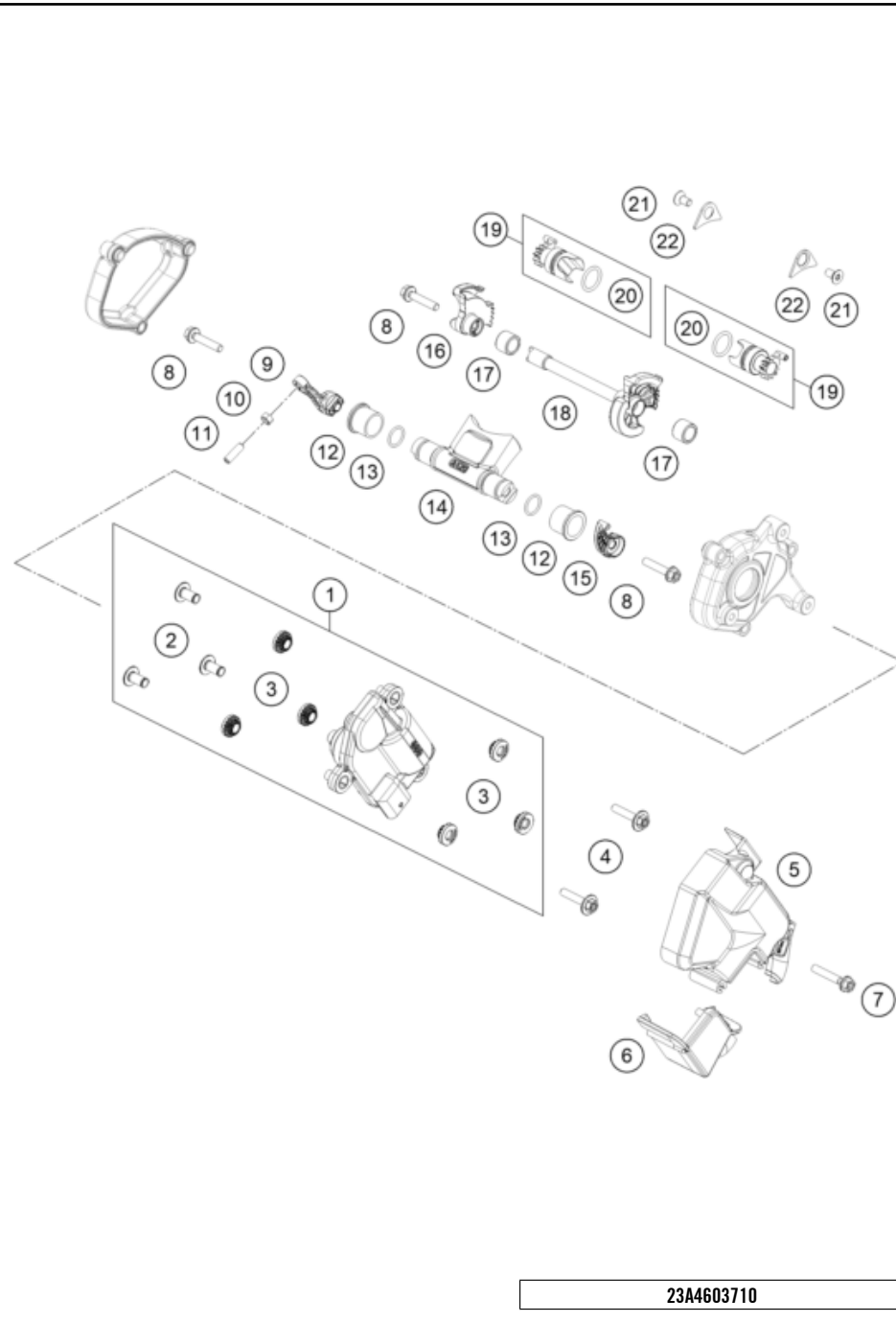

POS	PARTNUMBER		PIECE
1	A45041072033	Exhaust control actuator cpl.	1
2	A45041072010	Actuator bushing	3
3	A45041072005	Damper actuator	6
4	0000240502500S	HH collar screw, M5x25, ISA 30	2
5	A42037096000	Actuator protection cap	1
6	A42037096020	Actuator protection cap	1
7	0025050306	HH COLLAR SCREW M5X30 TX30	1
8	0025050256S	HH collar screw M5x25 TX30	3
9	A42037057000	Control lever	1
10	0934050040	Nut M5 SW7	1
11	0913050160	Grub screw M5x16 with AH	1
12	50437023100	exhaust flap bushing	2
13	07700120151	O-ring 12x1.5 FPM75	2
14	A42037020000	Control flap	1
15	A42037080000	Control flap lever	1
16	A42037065100	Right control gate	1
17	0618101410	needle sleeve HK 1010 10x14x10	2
18	A42037070033	Idler shaft cpl.	1
19	A42037063000	Exhaust roller rh	2
20	0770140201	O-RING 14X2 FPM 75SH	2
21	0019050106S	hex lobe countersunc screw M5x10 - 10.9	2
22	75030085100	Retaining bracket crankshaft bearing	2

23A4603710

79253

\* NEW PART

X ON DEMAND

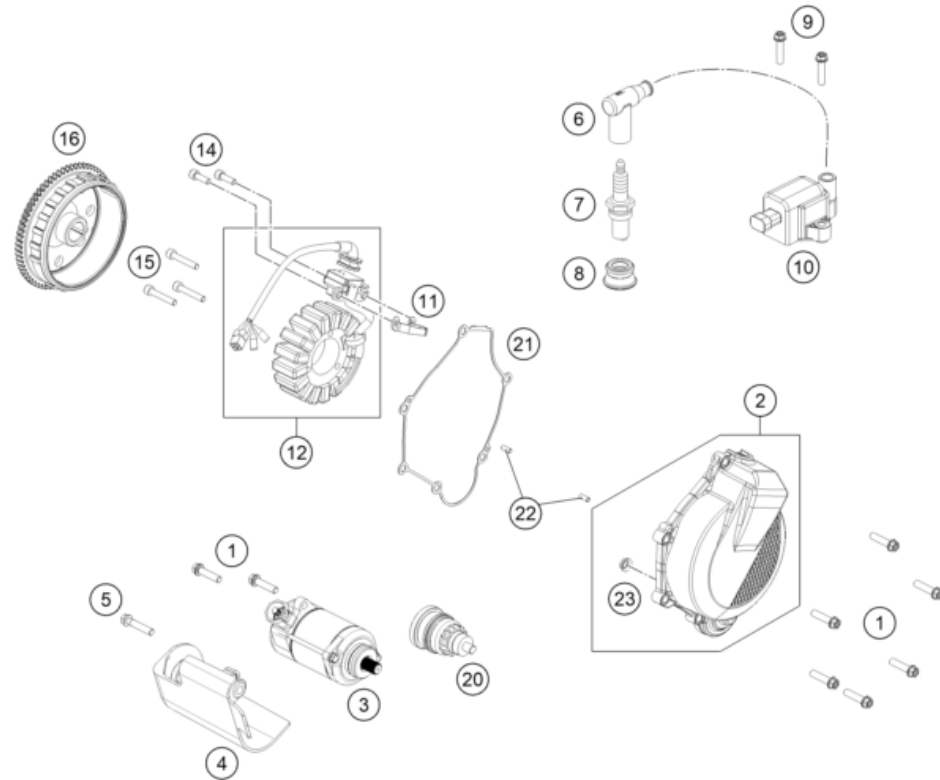

POS	PARTNUMBER		PIECE
1	0025060256	HH collar screw M6x25 TX30	8
2	A43030102044C1	Generator Cover	1
3	A42040001000	Starter motor	1
4	A42040040000	Starter motor cover	1
5	0025060306	HH collar screw M6x30 TX30	1
6	A44039007100	Ignition cable	1
7	51539093000	SPARK PLUG	1
8	51739091000	Sealing boot	1
9	0025060256	HH collar screw M6x25 TX30	2
10	55639006000	Ignition coil	1
11	A42039004010	Pick UP hanger	1
12	79239304000	Stator	1
14	0014050163	HH COLLAR SCREW M 5X16 WS=6	2
15	0912050303	AH SCREW DIN0912-M 5X30	3
16	A43039305000	Rotor	1
20	50440026000	Bendix	1
21	A42030040000	Ignition cover gasket	1
22	0402040980	Needle roll..DIN5402 NRB 4X9.8	2
23	55540031000	Collar bushing	1

24A4303911

64052

\* NEW PART

X ON DEMAND

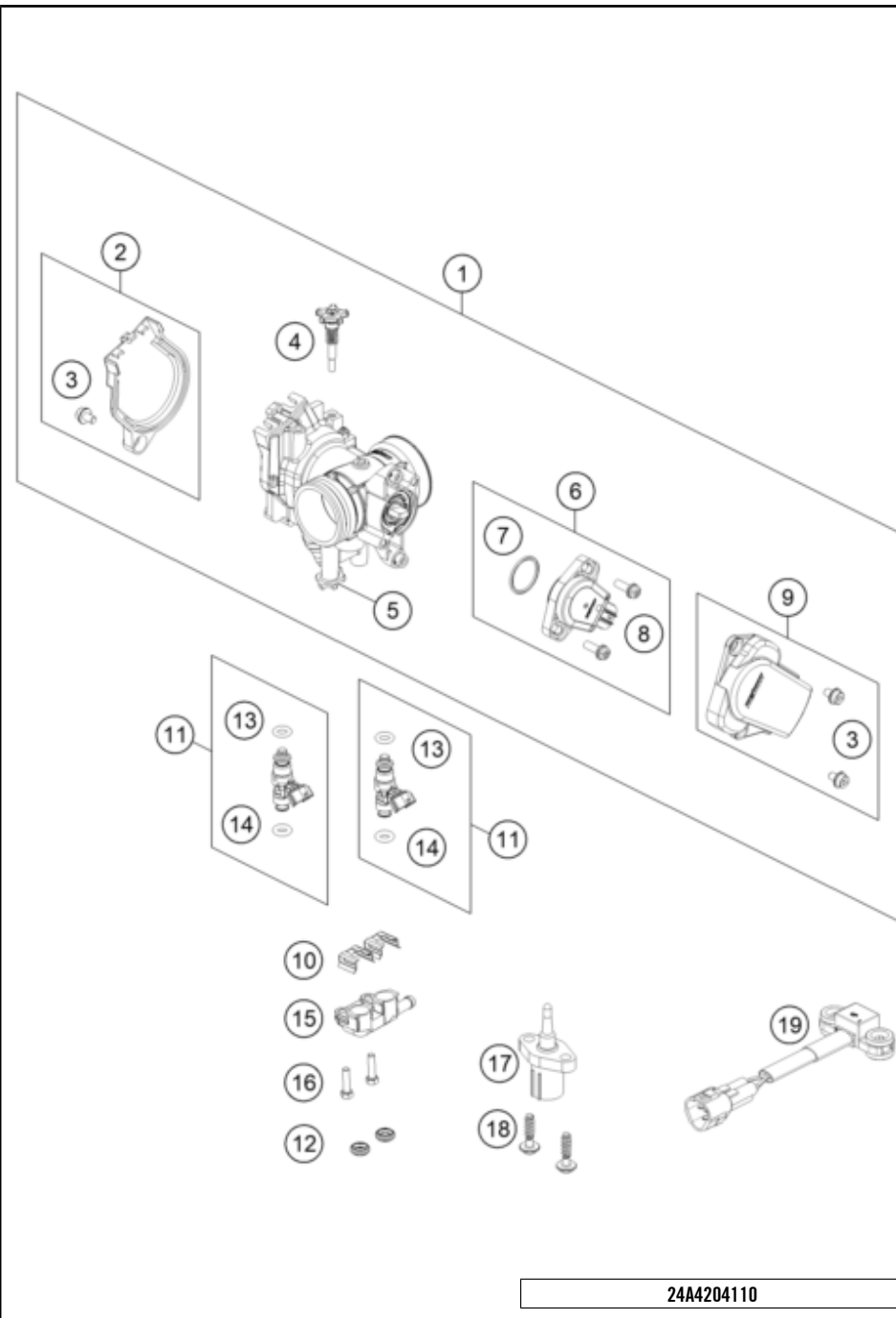

POS	PARTNUMBER		PIECE
1	A44041101000	Throttle body	1
2	79141056044	DKK Cover cpl.	1
3	79041056020	SPECIAL SCREW	3
4	A44041060044	STOP SCREW SET	1
5	79041070000	STARTER VALVE CPL.	1
6	79041077044	TPS CPL.	1
7	75041077110	O-RING	1
8	61041077020	SCREW THROTTLE POS. SENSOR	2
9	79141078044	TPS Cover cpl.	1
10	55441017000	Injector clip	2
11	A44041023044	Injector	2
12	55441024000	Protective ring	2
13	55641023020	O-ring	2
14	55641023010	O-ring	2
15	A42041006000	Fuel manifold	1
16	0025050166	HH collar screw M5x16 TX30	2
17	61041080000	Ambient-air temperature sensor	1
18	0081050181	SCREW FOR PLASTIC K50X18 T20	2
19	A46041088000	Roll-over sensor	1

24A4204110

63885

\* NEW PART

X ON DEMAND

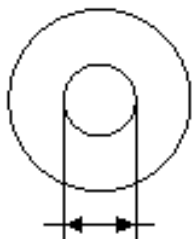

- ⑤ Ø 5 mm
- ⑥ Ø 6 mm
- ⑧ Ø 8 mm
- ⑩ Ø 10 mm
- ⑫ Ø 12 mm
- ⑭ Ø 14-14,5 mm
- ⑯ Ø 16 mm
- ⑳ Ø 20 mm
- ㉑ Ø 21 mm
- ㉒ Ø 22 mm
- ㉓ Ø 23 mm
- ㉔ Ø 24,5 mm
- ㉘ Ø 28,25-28,5 mm
- ㉚ Ø 32 mm
- ㉜ Ø 52 mm

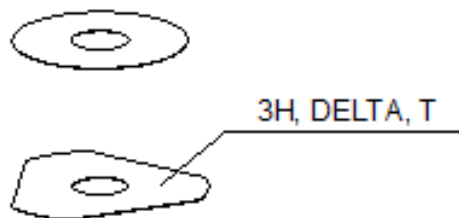

POS	PARTNUMBER		PIECE
1	48600611	Spring (10,2) l5 check valve	X
5	44906890	Washer 5X15X2	X
6	40540400	Shim 6x12x0,10	X
6	40540401	Shim 6x14x0,10	X
6	40540402	Shim 6x16x0,10	X
6	40540403	Shim 6x18x0,10	X
6	40540404	Shim 6x12x0,15	X
6	40540405	Shim 6x14x0,15	X
6	40540406	Shim 6x16x0,15	X
6	40540407	SHIM 6X18X0,15	X
6	40540408	Shim 6x12x0,20	X
6	40540409	Shim 6x14x0,20	X
6	40540410	Shim 6x16x0,20	X
6	40540411	Shim 6x18x0,20	X
6	48600095	SHIM 6X20X0,20	X
6	40540412	Shim 6x12x0,25	X
6	40540413	Shim 6x14x0,25	X
6	40540414	Shim 6x16x0,25	X
6	40540415	Shim 6x18x0,25	X
6	40540417	SHIM 6X8,5X0,10	X
6	40540418	SHIM 6X9X0,10	X
6	40540419	SHIM 6X9,5X0,10	X
6	40540423	SHIM 6X9,5X0,15	X
6	40540425	SHIM 6X8,5X0,20	X
6	40540426	SHIM 6X9X0,20	X
6	40540427	SHIM 6X9,5X0,20	X
6	40540447	Shim 6x10x0,30	X
6	40540449	Shim 6x9x0,30	X
6	40540450	Shim 6x9,5x0,30	X
6	40540494	Shim 6x18x0,40	X
6	40540774	Shim 6x18x0,10 delta	X
6	40541383	Shim 6X11X0,10	X
6	40541391	Shim 6x11x0,30	X
6	40541402	Shim 6x11x0,20	X
6	40541403	SHIM 6X10X0,20	X
6	40541404	Shim 6x10x0,10	X
6	40541405	Shim 6x10x0,15	X
6	40541406	SHIM 6X11X0,15	X

080000190

4668

\* NEW PART

X ON DEMAND

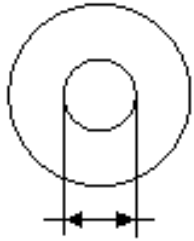

5 Ø 5 mm

6 Ø 6 mm

8 Ø 8 mm

10 Ø 10 mm

12 Ø 12 mm

14 Ø 14-14,5 mm

16 Ø 16 mm

20 Ø 20 mm

21 Ø 21 mm

22 Ø 22 mm

23 Ø 23 mm

24 Ø 24,5 mm

28 Ø 28,25-28,5 mm

32 Ø 32 mm

52 Ø 52 mm

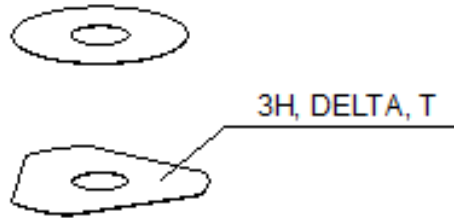

3H, DELTA, T

POS	PARTNUMBER		PIECE
6	40541408	SHIM 6X8,0X0,30	X
6	40541414	Shim 6x8x0,1	X
6	40541416	SHIM 6X8X0,3	X
6	40541417	SHIM 6X11X0,25	X
6	48600102	SHIM 6X24X0,25	X
6	48600063	Shim 6x24x0,10	X
6	48600064	Shim 6x22x0,10	X
6	48600065	Shim 6x20x0,10	X
6	48600069	Shim 6x20x0,15	X
6	48600100	Shim 6x24x0,15	X
6	48600116	Shim 6x24x0,10 delta	X
6	48600139	Shim 6x22x0,1 delta	X
6	48600217	Shim 6x10x0,25	X
6	48600325	Shim 6x13x0,10	X
6	48600327	SHIM 6X15X0,1	X
6	48600329	Shim 6x17x0,10	X
6	48600331	Shim 6x19x0,10	X
6	48600096	Shim 6x20x0,25	X
6	48600097	Shim 6x22x0,15	X
6	48600099	Shim 6x22x0,25	X
6	40540448	Shim 6x8,5x0,30	X
6	48600479	Shim 6x20x0,10 DELTA	X
6	48600332	SHIM 6X21X0,1	X
6	48600333	SHIM 6X23X0,1	X
6	40541393	Shim 6x12x0,30	X
6	48600330	SHIM 6X17X0,15	X
6	48600988	Shim 6x28x0,10	X
6	48600989	Shim 6x26x0,10	X
6	48601091	Shim 6x28x0,15	X
6	48601093	Shim 6x26x0,15	X
6	48600328	Shim 6x15x0,15	X
6	48600326	Shim 6x13x0,15	X
6	48601548	Shim 6x17x1,5	X
6	48601693	Washer 6x18x3	X
6	48600098	Shim 6x22x0,20	X
6	48601300	Washer 6x25x1,5	X
6	48601692	Shim 6x30x0,15	X
6	48601550	Shim 6x30x0,10	X

080000190

4668

\* NEW PART

X ON DEMAND

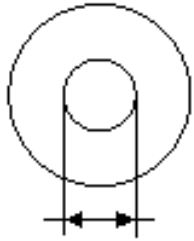

5 Ø 5 mm

6 Ø 6 mm

8 Ø 8 mm

10 Ø 10 mm

12 Ø 12 mm

14 Ø 14-14,5 mm

16 Ø 16 mm

20 Ø 20 mm

21 Ø 21 mm

22 Ø 22 mm

23 Ø 23 mm

24 Ø 24,5 mm

28 Ø 28,25-28,5 mm

32 Ø 32 mm

52 Ø 52 mm

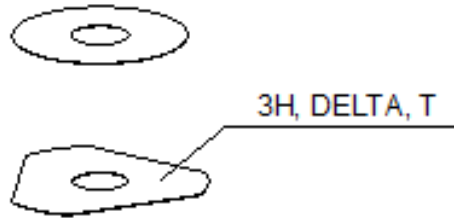

POS	PARTNUMBER		PIECE
6	40541392	Shim 6x8x0,2	X
6	48601917	Washer 6x25x4	X
6	48601916	Washer 6x18x4	X
6	40540399	Shim 6x16x0,30	X
6	48601584	Spring shim 6x30x0.4	X
6	48601459	Washer check valve 6x31x0,4	X
6	48601849	Check valve plate 2,5mm hub	X
6	48600101	SHIM 6X24X0,20	X
6	48601094	Shim 6x26x0,20	X
6	40540422	Shim 6X9X0,15	X
6	48601841	Washer check valve 6x31x0,4	X
6	48601850	Shim 6x30x0,4 spring shim	X
6	48601092	Shim 6x28x0,20	X
6	48601264	Shim 6x25x0,10	X
6	48600967	Shim 6x20x0,2 DELTA	X
6	48601847	Washer 6x25x1,5	X
6	48601707	Sinus shim plate 6X30	X
6	S64060000400000	Shim 6x14x0.3	X
6	S64060000500000	Shim 6x13x0.25	X
6	S64060000600000	Shim 6x17x0,2	X
6	40540421	Shim 6x8.5x0.15	X
6	48601262	Washer 6x18x1,5	X
6	S64060001500000	Shim 6x8x0.15	X
8	40540477	Shim 8x18x0,40	X
8	43570120	Shim 8x18x0,10	X
8	44916098	washer 8,4X16X0,8	X
8	44916130	washer 8,2X15X1	X
8	44916180	Washer 8.2X11X1	X
8	48600214	Shim 8x16x0,10	X
8	48600385	SHIM 8x14x0.25	X
8	48600346	Shim 8x11x0,20	X
8	48600215	Shim 8x20x0,10	X
8	48600485	washer 8X10X0,10	X
8	48601402	SHIM 8X13X0,10	X
8	48600350	Shim 8x16x0,15	X
8	48600061	Shim 8x24x0,40	X
8	48600062	CHECK VALVE 8X24X0,1	X
8	48600216	Shim 8x22x0,10	X

080000190

4668

\* NEW PART

X ON DEMAND

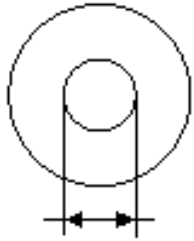

5 Ø 5 mm

6 Ø 6 mm

8 Ø 8 mm

10 Ø 10 mm

12 Ø 12 mm

14 Ø 14-14,5 mm

16 Ø 16 mm

20 Ø 20 mm

21 Ø 21 mm

22 Ø 22 mm

23 Ø 23 mm

24 Ø 24,5 mm

28 Ø 28,25-28,5 mm

32 Ø 32 mm

52 Ø 52 mm

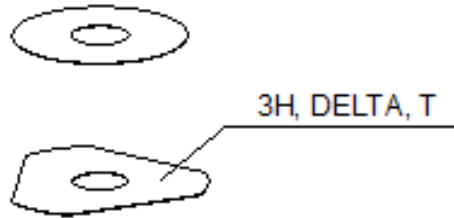

POS	PARTNUMBER		PIECE
8	48600480	Shim 8x10x0,20	X
8	48600555	SHIM 8X16X0,20	X
8	48600213	SHIM 8X14X0,10	X
8	48600357	Shim 8x11x0,10	X
8	48600351	Shim 8x12x0,10	X
8	48600607	Shim 8x20x0,40	X
8	48601095	Shim 8x17x0,10	X
8	48600352	check valve 8X11X0,4	X
8	48601860	Washer 8x11x0,15	X
8	48601266	Shim 8x26x0,40	X
8	46180640	Shim 8x16x0,3	X
8	43578166	Washer 8x20x1	X
8	48601113	Shim 8x15x0,1	X
8	48600218	Shim 8X11X0,40	X
8	48600964	Shim 8x20x0,15	X
8	89080008	Shim 8x30x0,10	X
8	48601859	Shim 8x10x0,15	X
8	48601863	Shim 8x14x0,15	X
8	89080001	Shim 8x18x0,15	X
8	89080002	Shim 8x22x0,15	X
8	89080003	Shim 8x24x0,15	X
8	89080005	Shim 8x26x0,15	X
8	89080007	Shim 8x28x0,15	X
8	89080009	Shim 8x30x0,15	X
8	48600386	Shim 8X12X0,25	X
8	48601862	Shim 8x13x0,15	X
8	89080004	Shim 8x26x0,10	X
8	89080006	Shim 8x28x0,10	X
8	S64080000000000	Shim 8x24x0,2	X
8	48601864	Shim 8x15x0,15	X
8	48600965	SHIM 8X20X0,2	X
8	S64080000300000	Shim 8x18x0,2	X
8	S64080000100000	Shim 8x12x0,2	X
8	S64080000900000	shim 8x14x0,2	X
8	S64080000100000	Shim 8x12x0,2	X
8	S64080000400000	Shim 8x22x0,2	X
8	48600384	Shim 8x22x0,30	X
8	S25080000300000	Trägerscheibe Sinus Shim 8x30	X

080000190

4668

\* NEW PART

X ON DEMAND

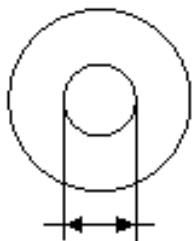

5 Ø 5 mm

6 Ø 6 mm

8 Ø 8 mm

10 Ø 10 mm

12 Ø 12 mm

14 Ø 14-14,5 mm

16 Ø 16 mm

20 Ø 20 mm

21 Ø 21 mm

22 Ø 22 mm

23 Ø 23 mm

24 Ø 24,5 mm

28 Ø 28,25-28,5 mm

32 Ø 32 mm

52 Ø 52 mm



3H, DELTA, T

POS	PARTNUMBER		PIECE
8	S25080000500000	Scheibe 8x25x2,5	X
10	36120284	SHIM 10X16X0,10	X
10	36120298	SHIM 10X16X0,2	X
10	36120312	SHIM 10X16X0,30	X
10	36120314	SHIM 10X18X0,30	X
10	36120325	SHIM 10X19X0,15	X
10	36120327	SHIM 10X23X0,15	X
10	36120328	SHIM 10X25X0,15	X
10	36120329	SHIM 10X27X0,15	X
10	36120330	SHIM 10X29X0,15	X
10	36120331	SHIM 10X31X0,15	X
10	36120332	SHIM 10X33X0,15	X
10	36120334	SHIM 10X21X0,20	X
10	36120335	SHIM 10X23X0,20	X
10	36120336	SHIM 10X25X0,20	X
10	36120337	SHIM 10X27X0,20	X
10	36120338	SHIM 10X29X0,20	X
10	36120339	SHIM 10X31X0,20	X
10	36120340	SHIM 10X33X0,20	X
10	36120342	SHIM 10X21X0,25	X
10	36120343	SHIM 10X23X0,25	X
10	36120344	SHIM 10X25X0,25	X
10	36120345	SHIM 10X27X0,25	X
10	36120349	SHIM 10X19X0,30	X
10	36120350	SHIM 10X21X0,30	X
10	36120313	SHIM 10X17X0,30	X
10	36120354	SHIM 10X29X0,30	X
10	40140275	WASHER 10x35X0,15	X
10	48601708	Shim 10x30x0,40	X
10	36120346	SHIM 10X29X0,25	X
10	36120355	SHIM 10X31X0,30	X
10	36120348	SHIM 10X33X0,25	X
10	36120311	SHIM 10X15X0,30	X
10	36120292	SHIM 10X17X0,15	X
10	36120326	SHIM 10X21X0,15	X
10	36120286	SHIM 10X18X0,10	X
10	36120347	SHIM 10X31X0,25	X
10	36120333	SHIM 10X19X0,20	X

080000190

4668

\* NEW PART

X ON DEMAND

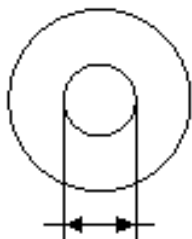

- ⑤ Ø 5 mm
- ⑥ Ø 6 mm
- ⑧ Ø 8 mm
- ⑩ Ø 10 mm
- ⑫ Ø 12 mm
- ⑭ Ø 14-14,5 mm
- ⑯ Ø 16 mm
- ⑳ Ø 20 mm
- ㉑ Ø 21 mm
- ㉒ Ø 22 mm
- ㉓ Ø 23 mm
- ㉔ Ø 24,5 mm
- ㉘ Ø 28,25-28,5 mm
- ㉚ Ø 32 mm
- ㉜ Ø 52 mm

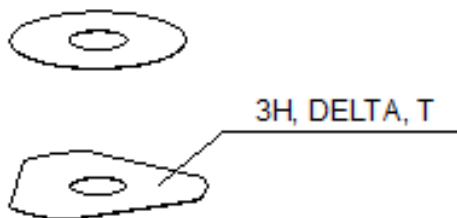

POS	PARTNUMBER		PIECE
10	36120351	SHIM 10X23X0,30	X
10	36120352	SHIM 10X25X0,30	X
10	36120353	SHIM 10X27X0,30	X
10	36120356	SHIM 10X33X0,30	X
10	50180395	Washer 10x16x1	X
10	36120291	SHIM 10X16X0,15	X
10	36120308	Shim 10x13x0,30	X
10	36120604	Washer 10x22x2,5	X
10	36120299	SHIM 10X17X0,20	X
12	46810605	SHIM 12X21X0,10	X
12	46810490	SHIM 12X24X0,20	X
12	46810491	Shim 12x26x0,20	X
12	46810492	Shim 12x28x0,20	X
12	46810493	SHIM 12X30X0,20	X
12	46810494	Shim 12x32x0,20	X
12	46810495	Shim 12x34x0,20	X
12	46810496	SHIM 12X36X0,20	X
12	46810497	SHIM 12X38X0,20	X
12	46810498	Shim 12x40x0,20	X
12	46810499	Shim 12x24x0,25	X
12	46810500	SHIM 12X26X0,25	X
12	46810501	SHIM 12X28X0,25	X
12	46810502	Shim 12x30x0,25	X
12	46810504	SHIM 12X34X0,25	X
12	46810505	SHIM 12X36X0,25	X
12	46810507	Shim 12x40x0,25	X
12	46810508	SHIM 12X24X0,30	X
12	46810509	SHIM 12X26X0,30	X
12	46810510	SHIM 12X28X0,30	X
12	46810512	SHIM 12X32X0,30	X
12	46810513	SHIM 12X34X0,30	X
12	46810518	SHIM 12X26X0,15	X
12	46810519	SHIM 12X28X0,15	X
12	46810520	SHIM 12X30X0,15	X
12	46810521	SHIM 12X32X0,15	X
12	46810522	SHIM 12X34X0,15	X
12	46810523	SHIM 12X36X0,15	X
12	46810524	SHIM 12X38X0,15	X

080000190

4668

\* NEW PART

X ON DEMAND

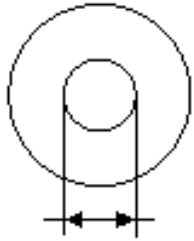

5 Ø 5 mm

6 Ø 6 mm

8 Ø 8 mm

10 Ø 10 mm

12 Ø 12 mm

14 Ø 14-14,5 mm

16 Ø 16 mm

20 Ø 20 mm

21 Ø 21 mm

22 Ø 22 mm

23 Ø 23 mm

24 Ø 24,5 mm

28 Ø 28,25-28,5 mm

32 Ø 32 mm

52 Ø 52 mm

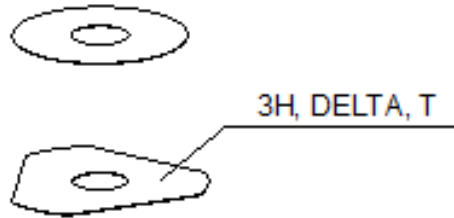

3H, DELTA, T

POS	PARTNUMBER		PIECE
12	46810525	SHIM 12X40X0,15	X
12	46810604	SHIM 12X20X0,10	X
12	46810606	SHIM 12X22X0,10	X
12	46810607	SHIM 12X23X0,10	X
12	46810608	SHIM 12X24X0,10	X
12	46810610	Shim 12x17x0,15	X
12	46810611	SHIM 12X18X0,15	X
12	46810612	SHIM 12X19X0,15	X
12	46810615	SHIM 12X22X0,15	X
12	46810636	BACKPLATE 12X16X0,30	X
12	46810637	Shim 12x17x0,30	X
12	46810638	Shim 12x18x0,30	X
12	46810639	SHIM 12X19X0,30	X
12	46810641	Shim 12X21X0,30	X
12	46811582	Shim 12x30x0,10	X
12	46810631	SHIM 12X20X0,25	X
12	46810633	SHIM 12X22X0,25	X
12	46811580	Shim 12x32x0,10	X
12	46810503	SHIM 12X32X0,25	X
12	46810517	SHIM 12X24X0,15	X
12	46810856	Shim 12x20x0,30	X
12	46811258	Washer 12x24x2,5	X
12	46812018	Shim 12x42x0,25	X
12	46812015	Shim 12x44x0,20	X
12	46810613	SHIM 12X20X0,15	X
12	46810623	SHIM 12X21X0,20	X
12	46810624	SHIM 12X22X0,20	X
12	46810642	SHIM 12X22X0,30	X
12	46810643	SHIM 12X23X0,30	X
12	46811629	Shim 12x28x0,10	X
12	46810511	SHIM 12X30X0,30	X
12	46810514	SHIM 12X36X0,30	X
12	46810506	SHIM 12X38X0,25	X
12	46810515	SHIM 12X38X0,30	X
12	46812017	Shim 12x42x0,20	X
12	46812016	Shim 12x44x0,25	X
12	46810622	SHIM 12X20X0,20	X
12	46811635	Shim 12x26x0,10	X

080000190

4668

\* NEW PART

X ON DEMAND

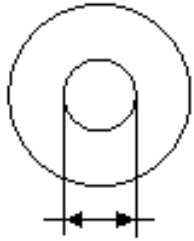

5 Ø 5 mm

6 Ø 6 mm

8 Ø 8 mm

10 Ø 10 mm

12 Ø 12 mm

14 Ø 14-14,5 mm

16 Ø 16 mm

20 Ø 20 mm

21 Ø 21 mm

22 Ø 22 mm

23 Ø 23 mm

24 Ø 24,5 mm

28 Ø 28,25-28,5 mm

32 Ø 32 mm

52 Ø 52 mm

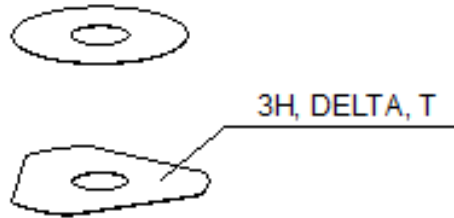

POS	PARTNUMBER		PIECE
12	50181296	Shim 12x45x0,20	X
12	46810620	Shim 12x18x0,2	X
12	46810616	Shim 12x23x0,15	X
12	46810625	SHIM 12X23X0,20	X
12	50181297	Adjustment 12x45x0,25	X
12	46810603	SHIM 12X19X0,10	X
12	46180712	SHIM 12X36X0,10	X
12	46810614	SHIM 12X21X0,15	X
12	46810628	SHIM 12X17X0,25	X
12	46810634	SHIM 12X23X0,25	X
12	S64120000000000	Shim 12x25x0.15	X
12	46810516	SHIM 12X40X0,30	X
12	S64120000800000	Shim 12x34x0,1	X
12	46810627	SHIM 12X16X0,25	X
12	46810632	SHIM 12X21X0,25	X
12	46810602	SHIM 12X18X0,10	X
14	35480479	Shim 14x26x0,40	X
14	46811046	Washer 14,5x35,4x1,25	X
16	50180023	SHIM 16X23X0,20	X
16	50180030	Shim 16x23x0,25	X
16	50180006	Shim 16x20x0,10	X
16	50180007	SHIM 16X21X0,10	X
16	50180028	SHIM 16X21X0,25	X
16	50180210	Washer 16x21x1	X
16	50180008	SHIM 16X22X0,10	X
16	50180022	Shim 16x22x0,20	X
16	50180037	SHIM 16X23X0,30	X
16	50180038	SHIM 16X24X0,30	X
16	50180032	Shim 16x25x0,25	X
16	50180039	SHIM 16X25X0,30	X
16	50180012	SHIM 16X26X0,10	X
16	50180019	SHIM 16X26X0,15	X
16	50180026	SHIM 16X26X0,20	X
16	50180040	SHIM 16X26X0,30	X
16	50180041	SHIM 16X28X0,10	X
16	50180045	Shim 16x28x0,15	X
16	50180054	Shim 16x28x0,2	X
16	50180063	SHIM 16X28X0,25	X

080000190

4668

\* NEW PART

X ON DEMAND

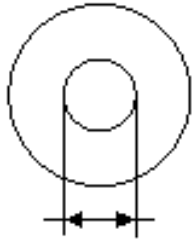

5 Ø 5 mm

6 Ø 6 mm

8 Ø 8 mm

10 Ø 10 mm

12 Ø 12 mm

14 Ø 14-14,5 mm

16 Ø 16 mm

20 Ø 20 mm

21 Ø 21 mm

22 Ø 22 mm

23 Ø 23 mm

24 Ø 24,5 mm

28 Ø 28,25-28,5 mm

32 Ø 32 mm

52 Ø 52 mm



3H, DELTA, T

POS	PARTNUMBER		PIECE
16	50180072	SHIM 16X28X0,30	X
16	50180046	SHIM 16X30X0,15	X
16	50180055	SHIM 16X30X0,20	X
16	50180064	Shim 16x30x0,25	X
16	50180073	SHIM 16X30X0,30	X
16	50180047	Shim 16X32X0,15	X
16	50180056	Shim 16x32x0,2	X
16	50180065	SHIM 16X32X0,25	X
16	50180074	SHIM 16X32X0,30	X
16	50180044	SHIM 16X34X0,10	X
16	50180048	SHIM 16X34X0,15	X
16	50180057	Shim 16x34x0,2 y5	X
16	50180066	SHIM 16X34X0,25	X
16	50180075	SHIM 16X34X0,30	X
16	50180049	Shim 16x36x0,15	X
16	50180058	Shim 16x36x0,20	X
16	50180067	SHIM 16X36X0,25	X
16	50180076	SHIM 16X36X0,30	X
16	50180050	SHIM 16X38X0,15	X
16	50180059	SHIM 16X38X0,20	X
16	50180068	SHIM 16X38X0,25	X
16	50180077	SHIM 16X38X0,30	X
16	50180051	Shim 16x40x0,15	X
16	50180060	Shim 16x40x0,2	X
16	50180069	SHIM 16X40X0,25	X
16	50180078	SHIM 16X40X0,30	X
16	50180052	SHIM 16X42X0,15	X
16	50180061	Shim 16x42x0,2	X
16	50180070	SHIM 16X42X0,25	X
16	50180079	SHIM 16X42X0,30	X
16	50180053	SHIM 16X44X0,15	X
16	50180062	Shim 16X44X0,20	X
16	50180071	SHIM 16X44X0,25	X
16	50180080	SHIM 16X44X0,30	X
16	50180177	spring washer 8,2x16x0,6	X
16	50180033	Shim 16x26x0,25	X
16	50180034	Shim 16x20x0,30	X
16	50180035	Shim 16x21x0,30	X

080000190

4668

\* NEW PART

X ON DEMAND

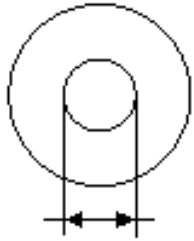

5 Ø 5 mm

6 Ø 6 mm

8 Ø 8 mm

10 Ø 10 mm

12 Ø 12 mm

14 Ø 14-14,5 mm

16 Ø 16 mm

20 Ø 20 mm

21 Ø 21 mm

22 Ø 22 mm

23 Ø 23 mm

24 Ø 24,5 mm

28 Ø 28,25-28,5 mm

32 Ø 32 mm

52 Ø 52 mm

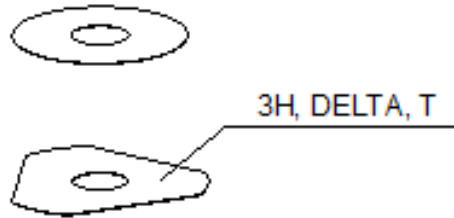

POS	PARTNUMBER		PIECE
16	50180036	Shim 16x22x0,30	X
16	50180043	SHIM 16X32X0,10	X
16	50180024	Shim 16x24x0,20	X
16	50180027	SHIM 16X20X0,25	X
16	50180031	Shim 16x24x0,25	X
16	50180029	SHIM	X
16	50180010	SHIM 16X24X0,10	X
16	50180021	SHIM 16X21X0,20	X
16	50180025	SHIM 16X25X0,20	X
16	50180383	Washer 16x19x0,3	X
16	50180014	SHIM	X
16	50180013	SHIM 16X20X0,15	X
16	50180015	DISTANCER PLATE 16X22X0,15	X
16	50180017	Shim 16x24x0,15	X
16	50180009	DISTANCER PLATE 16X23X0,10	X
16	50180016	SHIM 16X23X0,15	X
16	50180020	SHIM 16X20X0,20	X
20	48600212	pressure ring 20X16,25X0,20	X
20	50180666	SHIM 20X24X0,30	X
20	50180654	SHIM 20X36X0,20	X
20	50180655	SHIM 20X38X0,20	X
20	50180656	SHIM 20X40X0,20	X
20	50180665	SHIM 20X40X0,25	X
20	50180662	SHIM 20X34X0,25	X
20	50180657	SHIM 20X24X0,25	X
20	50180653	SHIM 20X34X0,20	X
20	50180634	RING 20X22,9X1	X
20	50180650	Shim 20x28x0,2	X
20	50180663	SHIM 20X36X0,25	X
20	50180664	SHIM 20X38X0,25	X
20	50180659	SHIM 20,2X28X0,25	X
21	50180209	Shim 21x36x0,25	X
22	50180330	Shim 18x22x0,3	X
23	50180635	SHUTTLE VALVE 23X38X0,25	X
23	50180578	SHIM D23XD16X2	X
24	40541061	Washer 24.5X34X2	X
28	36120469	SHIM 28,5X14X2	X
28	36120471	washer 28,5X14X5	X

080000190

4668

\* NEW PART

X ON DEMAND

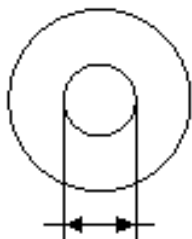

- ⑤ Ø 5 mm
- ⑥ Ø 6 mm
- ⑧ Ø 8 mm
- ⑩ Ø 10 mm
- ⑫ Ø 12 mm
- ⑭ Ø 14-14,5 mm
- ⑮ Ø 16 mm
- ⑳ Ø 20 mm
- ㉑ Ø 21 mm
- ㉒ Ø 22 mm
- ㉓ Ø 23 mm
- ㉔ Ø 24,5 mm
- ㉘ Ø 28,25-28,5 mm
- ㉚ Ø 32 mm
- ㉜ Ø 52 mm

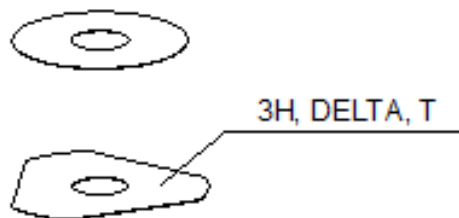

POS	PARTNUMBER		PIECE
28	89000001	Shim 28,25x34x0,30	X
28	46811636	Shim 28,25x32x0,30	X
32	48600460	washer 32X42X2,5	X
32	50600065	washer 32X45X2	X
32	46811637	Shim 32,25x36x0,30	X
52	50600002	washer 52x59x2,2	X

080000190

4668

\* NEW PART

X ON DEMAND

A large, empty rectangular box with a thin black border, occupying the majority of the page. It is intended for handwritten notes.



**WP Suspension GmbH**  
A 5230 Mattighofen, [www.wp-suspension.com](http://www.wp-suspension.com)



081568ZEN



Art. Nr.: 081568ZEN 30. Jul 2025