

# Engine 250 SX 2025 2025

ART.-NR.: 083630YEN





All information contained is without obligation. KTM Sportmotorcycle GmbH particularly reserves the right to modify any equipment, technical specifications, prices, colors, shapes, materials, services, service work, constructions, equipment and the like so as to adapt them to local conditions or to cancel any of the above items, all without previous announcement and without giving reasons. KTM may stop manufacturing certain models without previous notice. KTM shall not be held liable for any deviations of availability and/or ability to deliver, illustrations, descriptions, printing and/or other errors. The illustrated models partly contain extra equipment, which is not applied to standard models.

© by KTM Sportmotorcycle GmbH, Mattighofen AUSTRIA; All rights reserved; Reprint, also in extracts, with written allowance of KTM Sportmotorcycle GmbH, Mattighofen only.

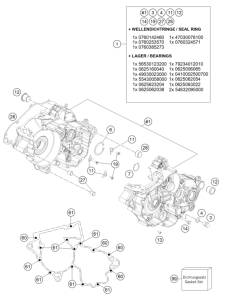
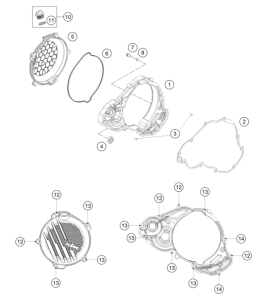
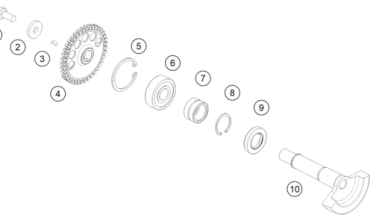
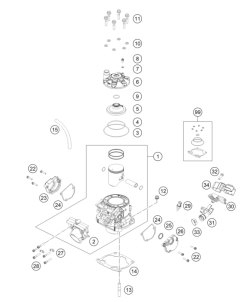
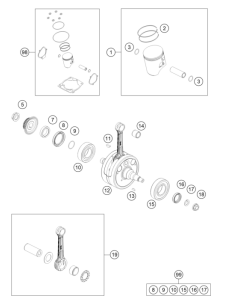
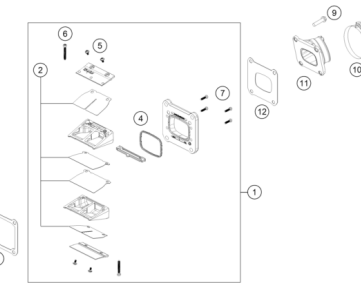
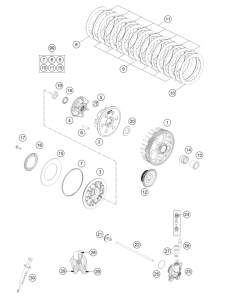
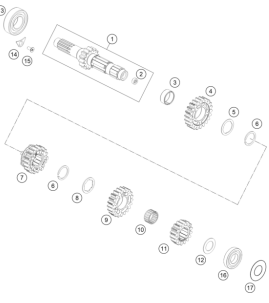
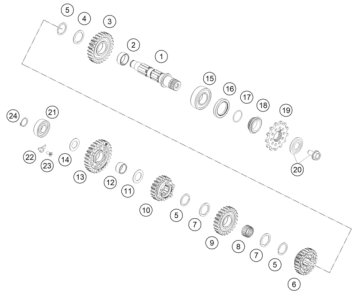
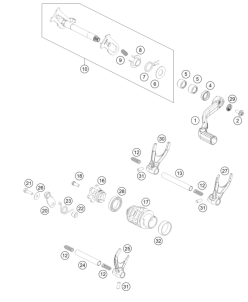
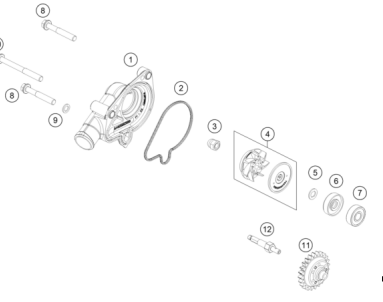
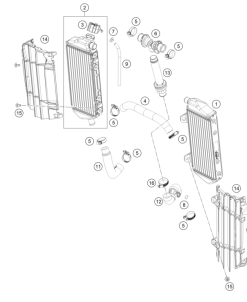
<p><b>ENGINE CASE</b></p>  <p><b>3</b></p>	<p><b>CLUTCH COVER</b></p>  <p><b>4</b></p>	<p><b>BALANCER SHAFT</b></p>  <p><b>5</b></p>	<p><b>CYLINDER, CYLINDER HEAD</b></p>  <p><b>6</b></p>
<p><b>CRANKSHAFT, PISTON</b></p>  <p><b>7</b></p>	<p><b>REED VALVE CASE</b></p>  <p><b>8</b></p>	<p><b>CLUTCH</b></p>  <p><b>9</b></p>	<p><b>TRANSMISSION I - MAIN SHAFT</b></p>  <p><b>10</b></p>
<p><b>TRANSMISSION II - COUNTERSHAFT</b></p>  <p><b>11</b></p>	<p><b>SHIFTING MECHANISM</b></p>  <p><b>12</b></p>	<p><b>WATER PUMP</b></p>  <p><b>13</b></p>	<p><b>COOLING SYSTEM</b></p>  <p><b>14</b></p>

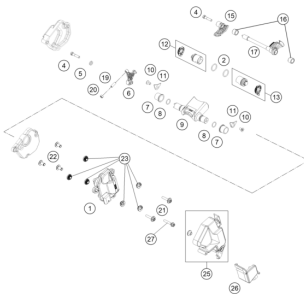
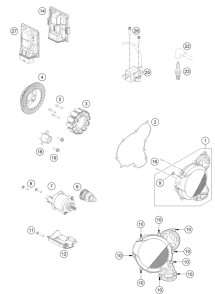
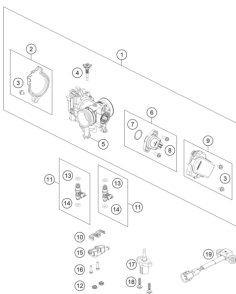
<p><b>EXHAUST CONTROL</b></p>  <p><b>15</b></p>	<p><b>IGNITION SYSTEM</b></p>  <p><b>16</b></p>	<p><b>THROTTLE BODY</b></p>  <p><b>17</b></p>	

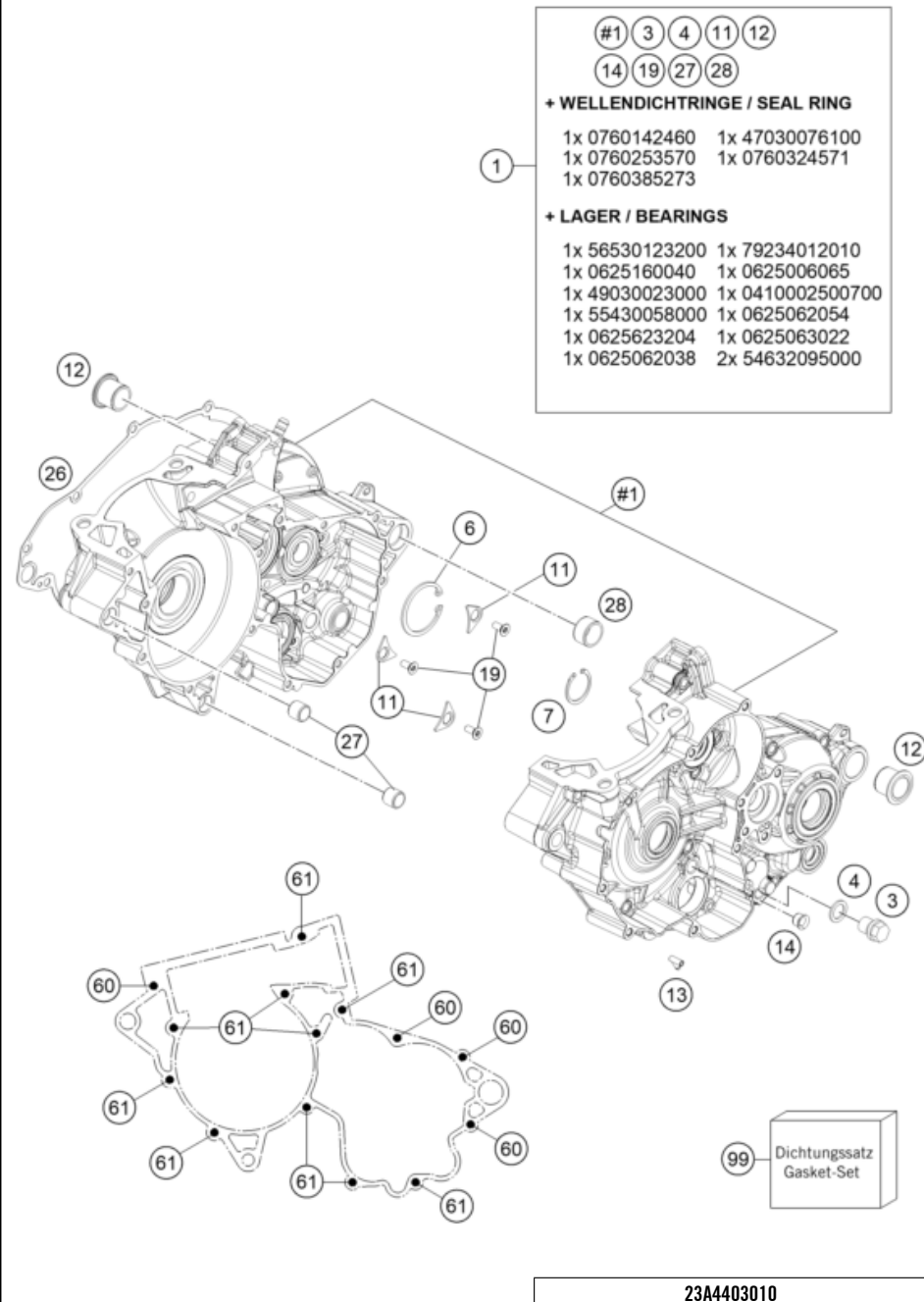

POS	PARTNUMBER	PIECE
1	A4403000044	Engine case compl.
3	58030021100	oil drain plug with magnet
4	58038022000	CU-SEAL RING DIN7603-12X18X1,5
6	0472042175	CIRCLIP DIN0472-42X1,75
7	55430059100	CIRCLIP DIN0472-28X1,2
11	75030085100	Retaining bracket crankshaft bearing
12	79230010000	Housing bush
13	45130022000	ANGLE PIECE 50CCM LC 2001
14	55540031000	Collar bushing
19	0019050121S	INT. TORX FLAT HEAD M5X12 T25
26	A44030025000	Clutch cover gasket, inner
27	54630027000	DOWEL BUSHING 13,8X11X12
28	54830027100	Dowel, 21x12
60	0025060606	HH collar screw M6x60 TX30
61	0025060406	HH collar screw M6x40 TX30
99	A44030099000	Gasket kit Engine MX 250/300

60193

\* NEW PART      X ON DEMAND

# CLUTCH COVER

Engine 250 SX 2025 2025

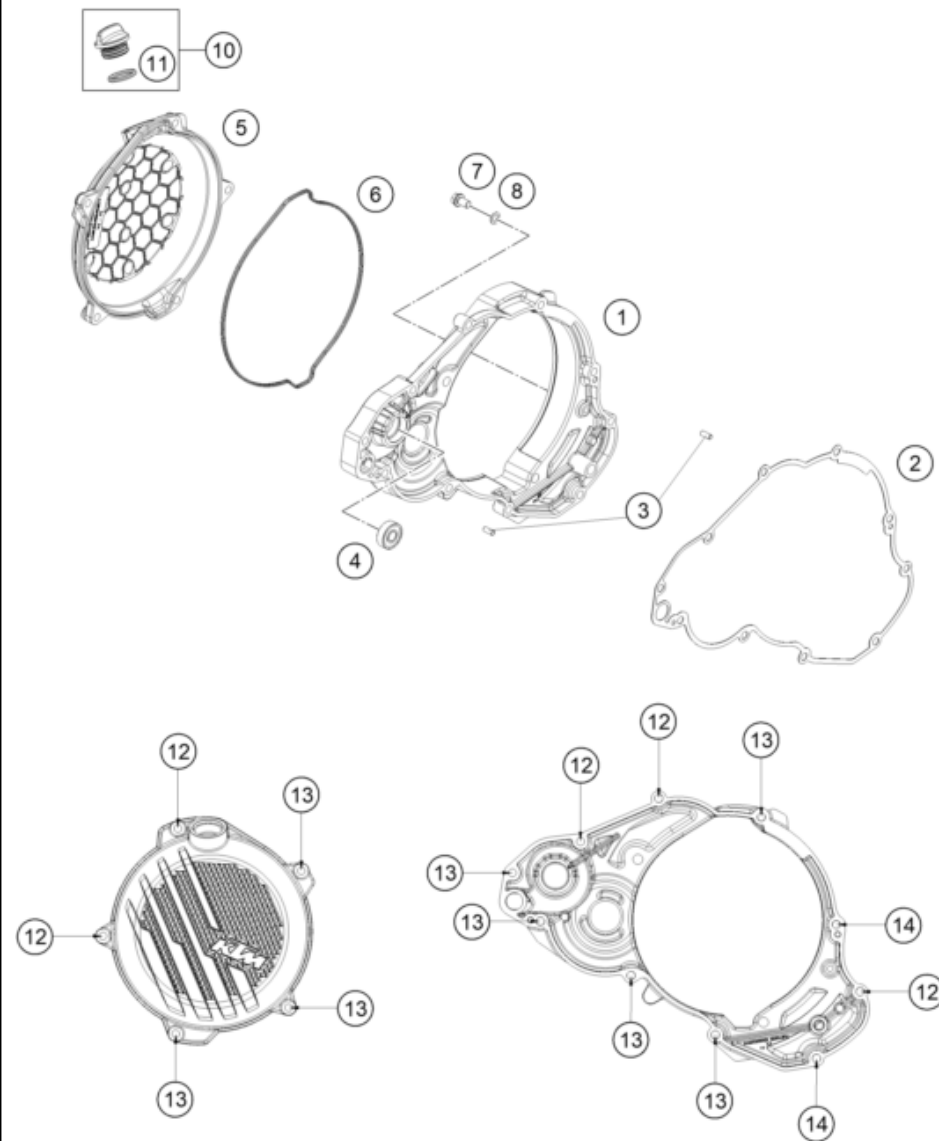

POS	PARTNUMBER		PIECE
1	A44030001044	Clutch cover, inner, cmpl.	1
2	A44030025000	Clutch cover gasket, inner	1
3	0402040980	NEEDLE ROL.DIN5402 NRB 4X9,8	2
4	0625006087	GROOVED BALL BEAR. 608 2RS C3	1
5	A48030026000C1	Clutch cover outside	1
6	A48030027000	Clutch cover gasket external	1
7	0025060106	HH collar screw M6x10 TX30	1
8	0603061001	CU-SEAL RING DIN7603-6X10X1	1
10	79430020033	OIL FILLER CAP M24x3 WITH O-R	1
11	0770191015	O-RING 19,00X3,00 NBR	1
12	0025060606	HH collar screw M6x60 TX30	5
13	0025060256	HH collar screw M6x25 TX30	8
14	0025060406	HH collar screw M6x40 TX30	2

23A4403020

60199

\* NEW PART

X ON DEMAND

# BALANCER SHAFT

Engine 250 SX 2025 2025

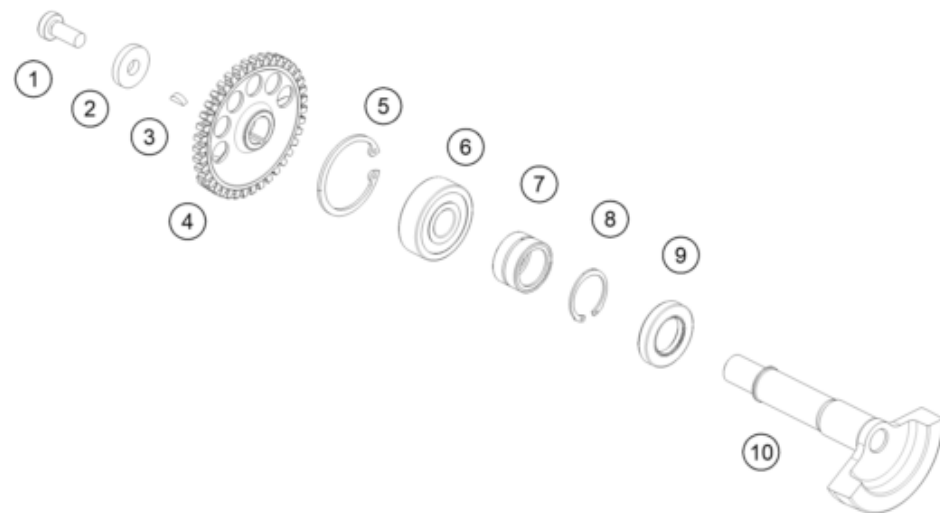

POS	PARTNUMBER		PIECE
1	0035080206S	SHCS M8x20 TX45	1
2	0340084234	WASHER DIN 6340 8,4X23X4	1
3	0888030037	WOODRUFF KEY DIN6888-3X3,7	1
4	55430056000	AGW-GEAR WHEEL	1
5	0472042175	CIRCLIP DIN0472-42X1,75	1
6	0625063022	GROOVED BALL BEARING 6302 C3	1
7	55430058000	NEEDLE BEARING NK20X16XL	1
8	55430059100	CIRCLIP DIN0472-28X1,2	1
9	47030076100	SEAL SHAFT RING 20X35X6 BTSL	1
10	A44030057000	Balancer shaft	1

175543030

60195

\* NEW PART

X ON DEMAND

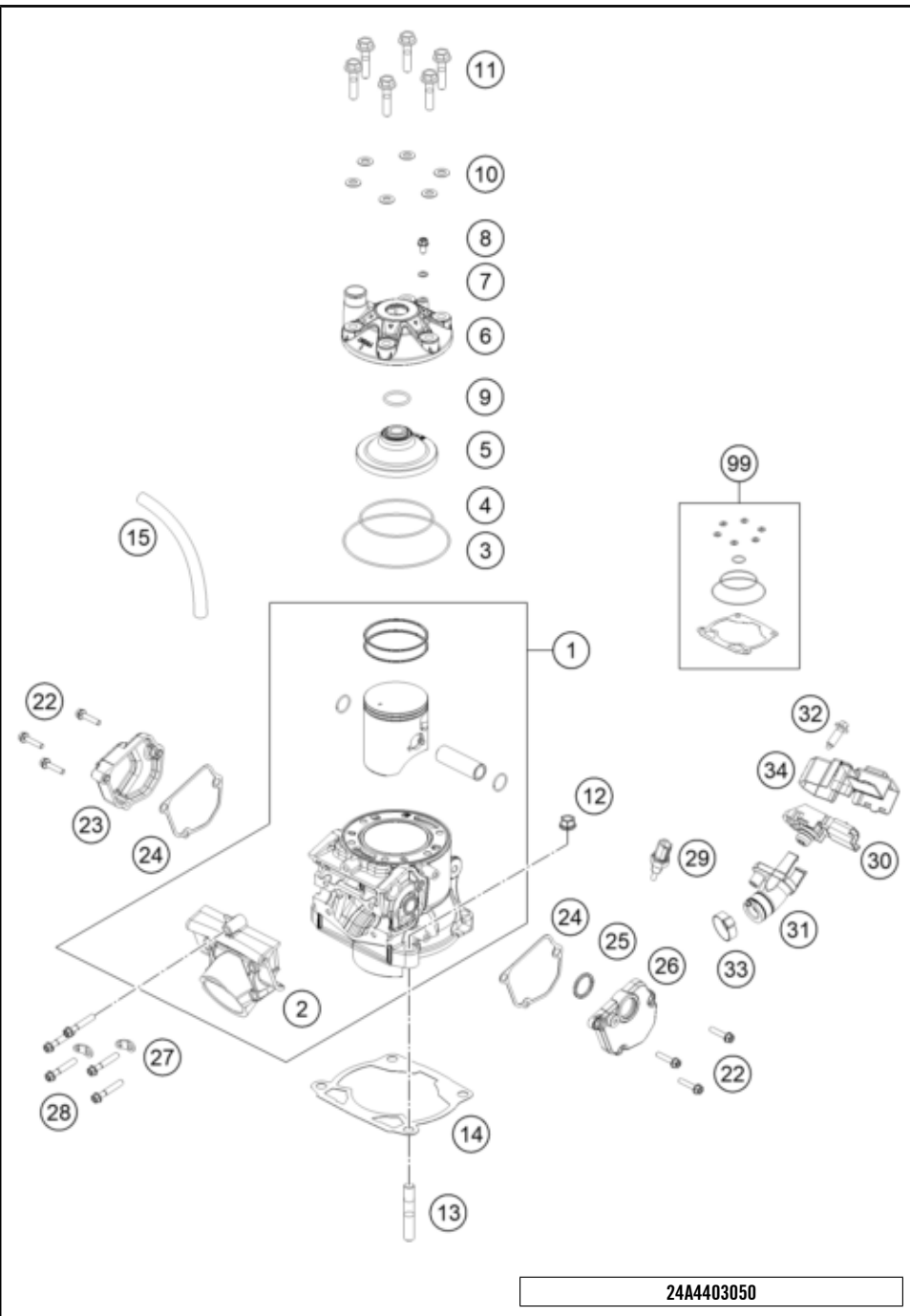

24A4403050

POS	PARTNUMBER	PIECE	
1	A44030238000	Cylinder + Piston MX 250 2023	1
2	A44037201000	Intermediate flange	1
3	0770107020	O-Ring 107x2	1
4	0770730020	O-RING 73,00X2,00 VITON	1
5	A44030060000	Combustion chamber insert KTM 250 SX	1
6	A45030006100	Cylinder head	1
7	0603061001	CU-SEAL RING DIN7603-6X10X1	1
8	0025060106	HH collar screw M6x10 TX30	1
9	0770023025	O-ring 23x2,5 Viton 75SH	1
10	56530080000	CU-SEAL RING 8 X 16 X 1	6
11	54830079000	COLLAR SCREW M 8X35 WS=13	6
12	55530044000	Collar nut M10-SW13 ZnNi	4
13	0835100300	Stud bolt M10x30	4
14	A44030035020	Cylinder base gasket	x
14	A44030035025	Cylinder base gasket	x
14	A44030035030	Cylinder base gasket	x
14	A44030035040	Cylinder base gasket	x
14	A44030035050	Cylinder base gasket	x
14	A44030035070	Cylinder base gasket	x
14	A44030035080	Cylinder base gasket	x
15	A42030087000	Engine vent hose	x
22	0025050256	HH COLLAR SCREW M5X25 ISA30	6
23	A44037007000	exhaust control cover right	1
24	A44037006000	Control cover seal, left	2
25	0770002226200	X-ring 21.89x2.62 FKM 70	1
26	A44037005000	exhaust control cover left	1
27	51005074000	RETAINING PLATE	2
28	0025060356	HH collar screw M6x35 TX30	5
29	79435047000	water temperature sensor	1
30	A45041075000	crank case pressure sensor	1
31	A44041087000	Pressure sensor flange	1
32	0017060206	SCREW F. PLASTIC K60X20AL SW6	1
33	00050210706	VARIABLE ONE-EAR CLAMP 21,0MM	1
34	A45041075060	Pressure sensor cover	1
99	A44030097000	Sealkit cylinder MX 250/300	x

63968

\* NEW PART

X ON DEMAND

# CRANKSHAFT, PISTON

Engine 250 SX 2025 2025

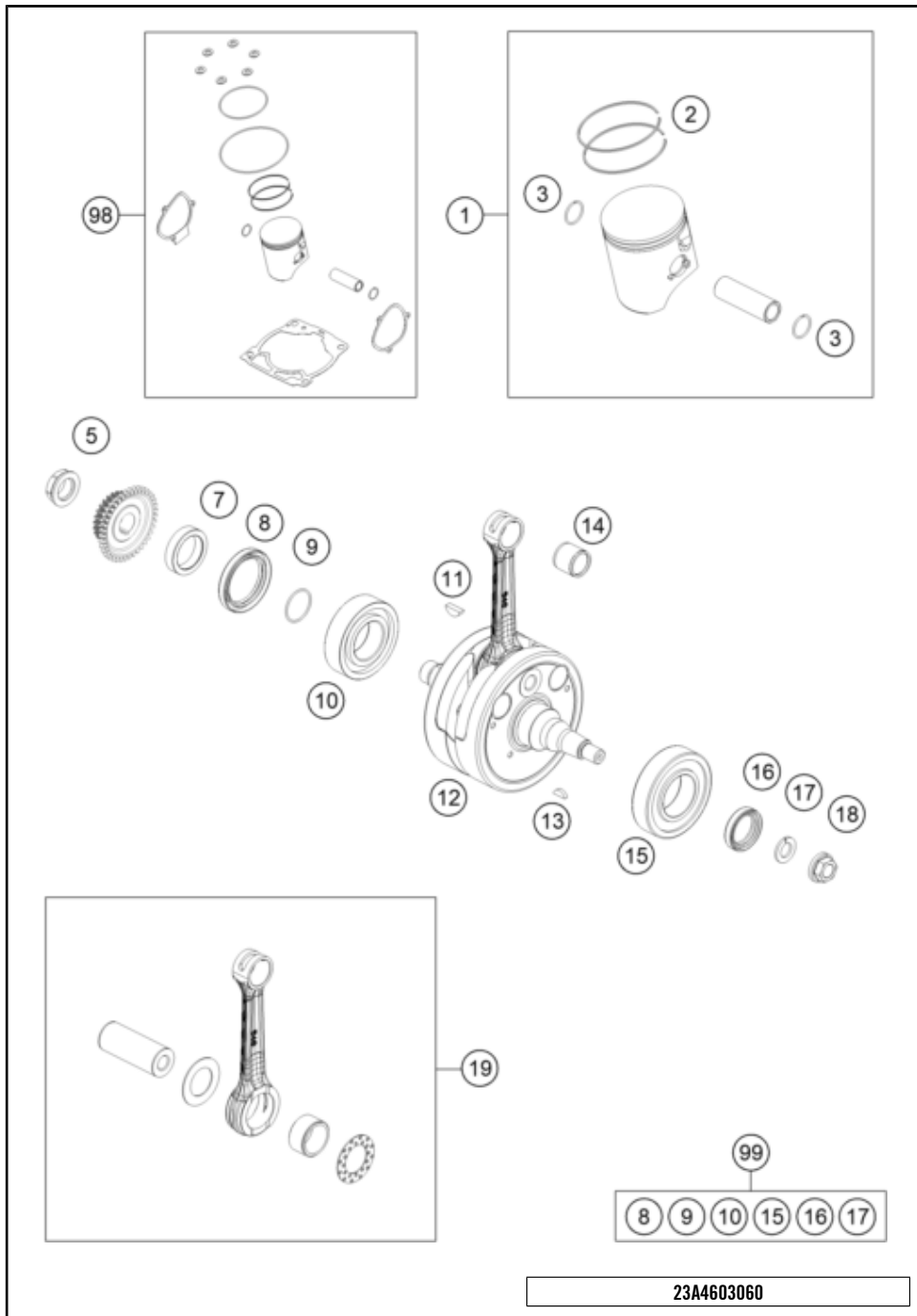

POS	PARTNUMBER		PIECE
1	55430007000 I	Piston cpl. I	1
1	55430007000 II	Piston cpl. II	1
2	54830232000	TRAPEZOID RING 250 66,4 MM	2
3	54030074000	WIRE LOCK RING C18X1,5	2
5	54630029000	HEX.NUT L/SH M18X1,5	1
7	55430016000	DISTANCE SLEEVE	1
8	0760385273	SHAFT SEAL RING 38X52X7BTSL	1
9	0770250015	O-RING 25,00X1,50 NBR 70	1
10	0625623204	BALL BEARING 32X65X17 NTN	1
11	6946005	WOODRUFF KEY 5X6,5 HARDED	1
12	55430118100	CRANKSHAFT EXC	1
13	0888030050	WOODRUFF KEY DIN6888-3X5X13	1
14	54430034000	NEEDLE BEARING KBK 18X22X20	1
15	56530123200	CYLIND.ROL.BEAR. NJ207ET2XCS42	1
16	0760253570	SHAFT SEAL RING 25X35X7 BTSL	1
17	50230029012	LOCKING RING VSK 12	1
18	49030021000	COLLAR NUT M12X1 R/S	1
19	54830015244	CON.ROD REP.SET 250/300	x
98	A44030007010 I	Pistonkit Gr.I MX 250	x
98	A44030007010 II	Pistonkit Gr.II MX 250	x
99	54830018488	Crankshaft repair kit	x

23A4603060

62302

\* NEW PART X ON DEMAND

# REED VALVE CASE

Engine 250 SX 2025 2025

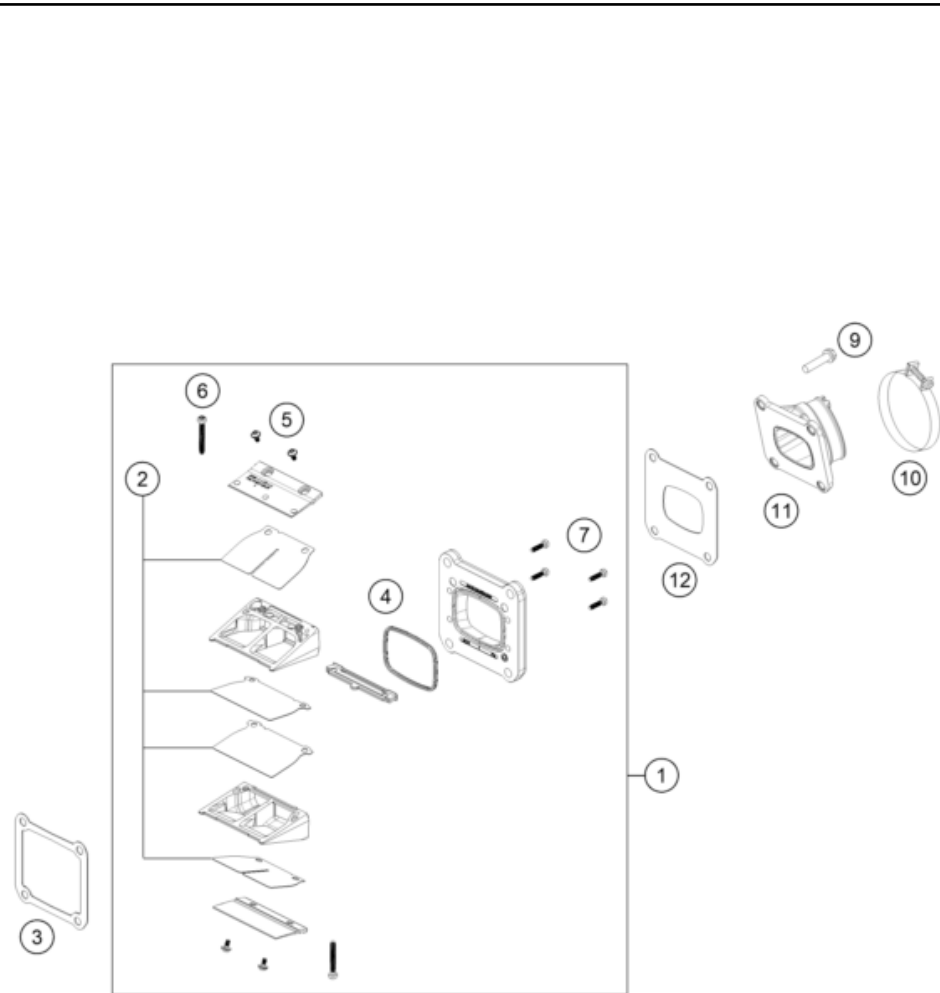

POS	PARTNUMBER		PIECE
1	A44030051044	Reed valve case cpl.	1
2	50530152044	Reed Valve Set	1
3	50430098050	GASKET REED VALVE CASE	1
4	54830153050	GASKET SUPPORTING PLATE	1
5	00810300553	EJOT DELTA PT SCREW 30X5,5	4
6	0081035253	EJOT DELTA PT SCREW 35X25	2
7	0081030124	EJOT DELTA PT SCREW 30X12	4
9	0025060256	HH collar screw M6x25 TX30	4
10	54330061000	CLAMP 52/12 GEMI	1
11	50430050000	INTAKE FLANGE	1
12	50430098060	GASKET INTAKE FLANGE	1

23A4603070

60197

\* NEW PART

X ON DEMAND

# CLUTCH

Engine 250 SX 2025 2025

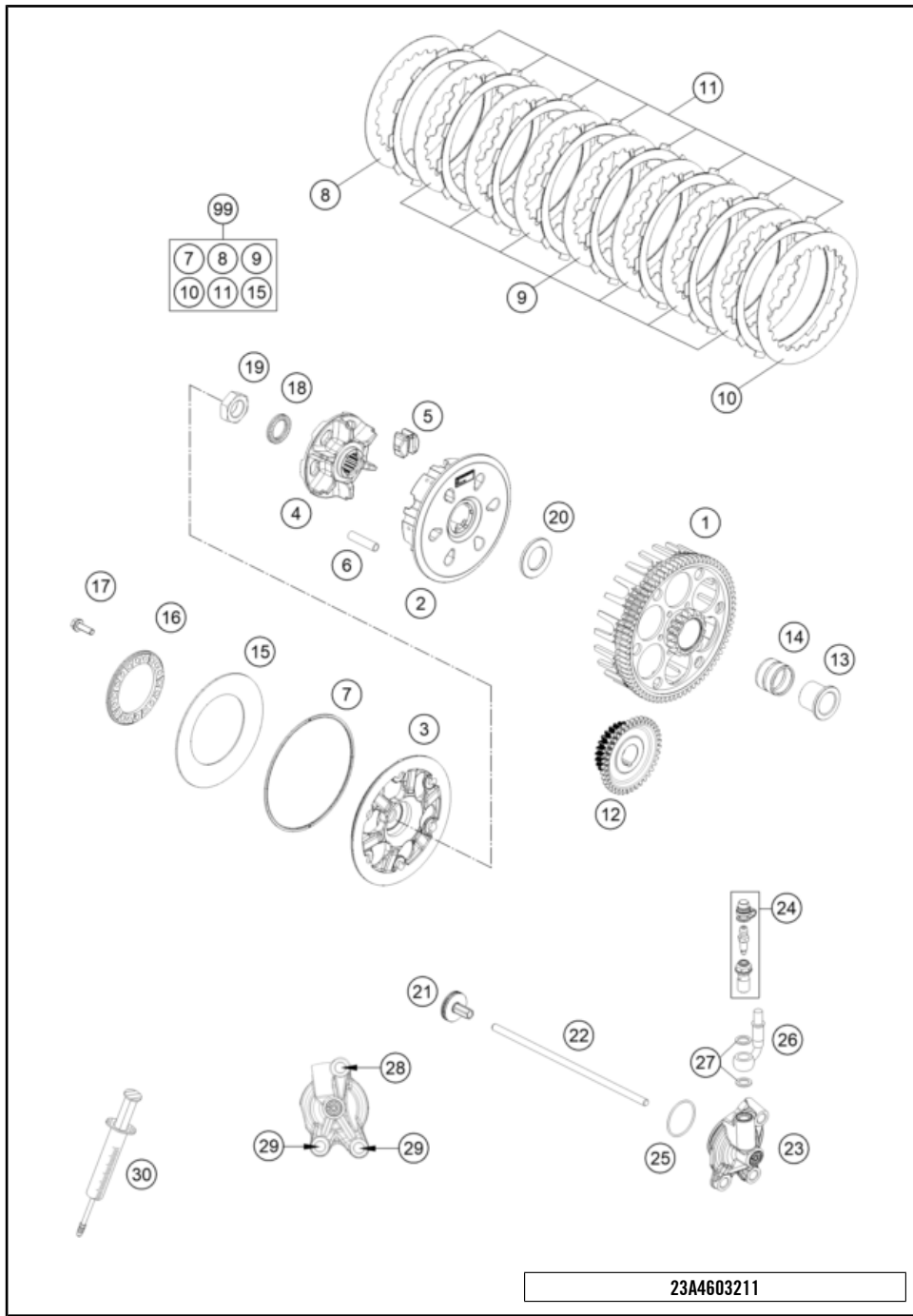

POS	PARTNUMBER		PIECE
1	A46032001072	Outer clutch hub	1
2	78132002400	Inner clutch hub	1
3	79432003100	Clutch pressure plate	1
4	78132002211	Clutch center	1
5	78132025100	DAMPING RUBBER	6
6	77232104000	Sleeve, 7.95x38	6
7	78132013000	WASHER 112X118X1.5	1
8	59032010100	INTERMEDIATE DISC 1MM 2002	1
9	59032010200	INTERMEDIATE DISC 1,4MM 2002	7
10	78932010000	INTERMEDIATE DISC 1MM	1
11	54832011100	LINING DISC 1,95 MM	8
12	55432024026	PRIMARY GEAR	1
13	A46032015000	Collar sleeve	1
14	0405252910	NEEDLE BEAR K 25X29X10	1
15	78132005000	BELLEVILLE SPRING 71X115X1,5 l	1
16	78132006200	Spring retainer	1
17	0025050166	HH collar screw M5x16 TX30	6
18	0252012002900	Wedge lock washer 19.5x29x3.4	1
19	0936181506	Hex nut DIN0936-M18x1.5 right	1
20	78932009000	WASHER 22 X 36,5 X 3	1
21	78132057144	PRESSURE PIECE CPL.	1
22	A48032054000	Push rod	1
23	79232061044	OUTPUT CYLINDER CPL.	1
24	79032064000	BLEEDER SCREW CPL.	1
25	0770300015	O-RING 30,00X1,50 NBR 70	1
26	79232063000	CLUTCH PIPE	1
27	0603082121	SEAL RING CU DIN7603- 8X12X1	2
28	0025060256	HH collar screw M6x25 TX30	1
29	0025060166	HH collar screw M6x16 TX30	2
30	50329050000	VENT INJEKTION HYDR. CLUTCH	1
99	54832011110	CLUTCH KIT 250/300 13-15	x

23A4603211

60314

\* NEW PART

X ON DEMAND

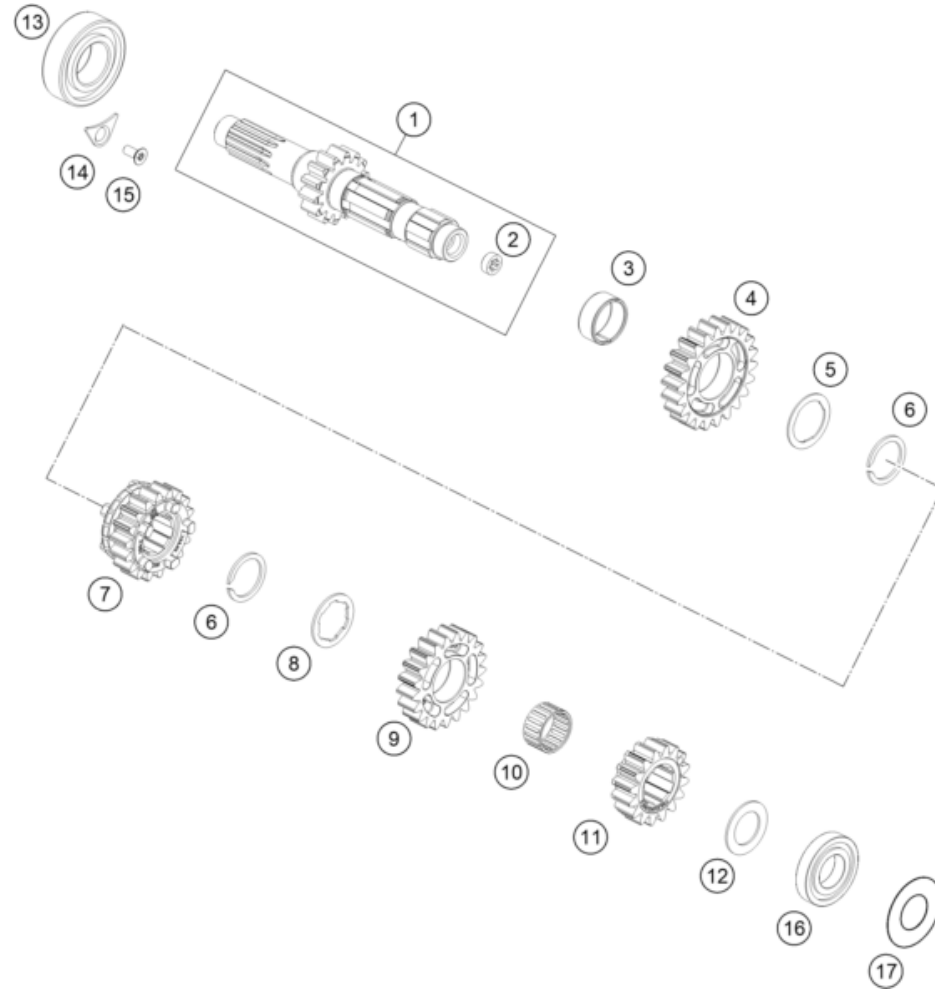

POS	PARTNUMBER		PIECE
1	A47033001000	Main shaft compl.	1
2	79133001010	bushing	1
3	0405242812	NEEDLE BEAR. K24X28X11,9 DIV.	1
4	79333505000	Idle gear 5 th.	1
5	79333043000	Stop disk	1
6	77033022100	Retaining ring 25x1,65	2
7	79333503000	Sliding gear 3 rd.	1
8	79333030000	Trust washer	1
9	79333504000	Idle gear 4 th	1
10	0405222613	NEEDLE BEAR. K 22X26X13 TN	1
11	79333002000	Fixed gear 2nd g/16 teeth	1
12	77233015000	DISK 20,2X32X1,3	1
13	0625062056	Groove ball bearing 6205 C4 NTN	1
14	75030085100	Retaining bracket crankshaft bearing	1
15	0019050121S	INT. TORX FLAT HEAD M5X12 T25	1
16	0625160041	BALL BEARING TM 16004 C4	1
17	77233088000	SPACER SHIM 21X42X0.2	1

227953330

58158

\* NEW PART

X ON DEMAND

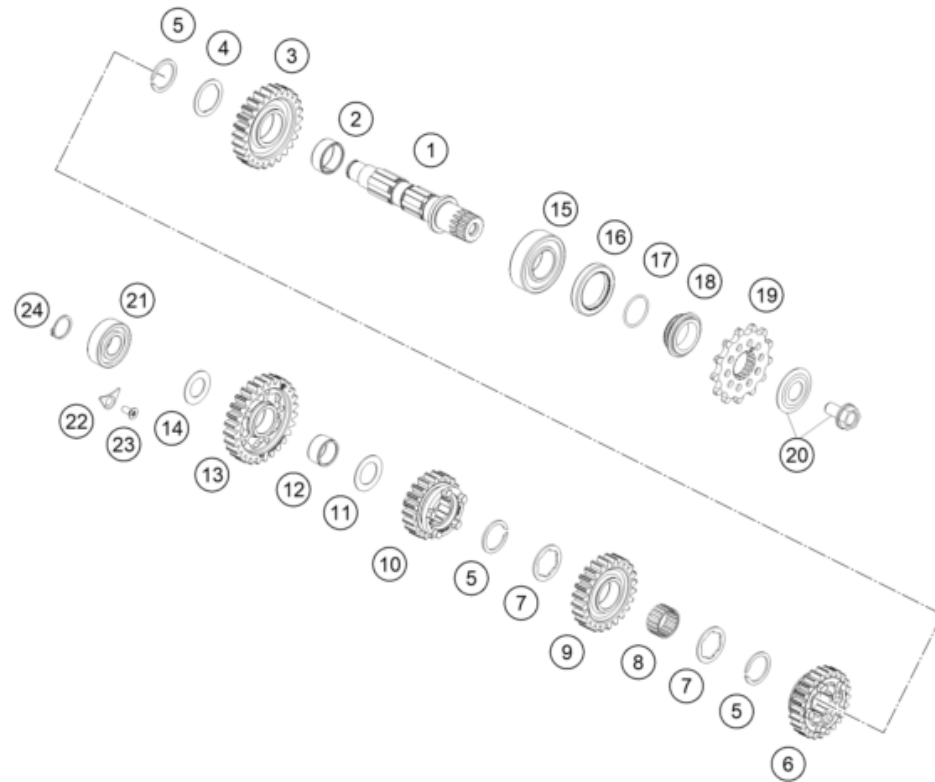

POS	PARTNUMBER		PIECE
1	79333010000	Countershaft	1
2	0405242812	NEEDLE BEAR. K24X28X11,9 DIV.	1
3	79333512000	Idler gear 2nd.	1
4	79333043000	Stop disk	1
5	77033022100	Retaining ring 25x1,65	3
6	79333514000	Sliding gear 4th	1
7	59033030000	STOP DISC 25,2X32X1,5	2
8	0405222613	NEEDLE BEAR. K 22X26X13 TN	1
9	79333513000	Idler gear 3rd	1
10	79333515000	Sliding gear 5th	1
11	59033080000	SHIM 20X32X1	1
12	0405202413	NEEDLE BEAR. K20X24X13	1
13	79333511000	Idler gear 1 st.	1
14	56033030000	STOP DISC 17,2X30X1	1
15	49030023000	cylindrical roller bearing NJ205	1
16	0760324571	SHAFT SEAL RING 32X45X7 BSLNBR	1
17	0770020220	O-RING 25,12X1,78 NBR70	1
18	78133014000	SPACER SLEEVE COUNTER	1
19	79233029014	SPROCKET 14T	1
19	79233029013	SPROCKET 13T	x
20	59033034044	SCREW 10.9+SPRING WASHER	1
21	0625062038	Ballbearing NTN 6203JR2CM21	1
22	75030085100	Retaining bracket crankshaft bearing	1
23	0019050121S	INT. TORX FLAT HEAD M5X12 T25	1
24	0471170015	CIRCLIP DIN 0471-17X1, 5	1

227953360

58159

\* NEW PART

X ON DEMAND

# SHIFTING MECHANISM

Engine 250 SX 2025 2025

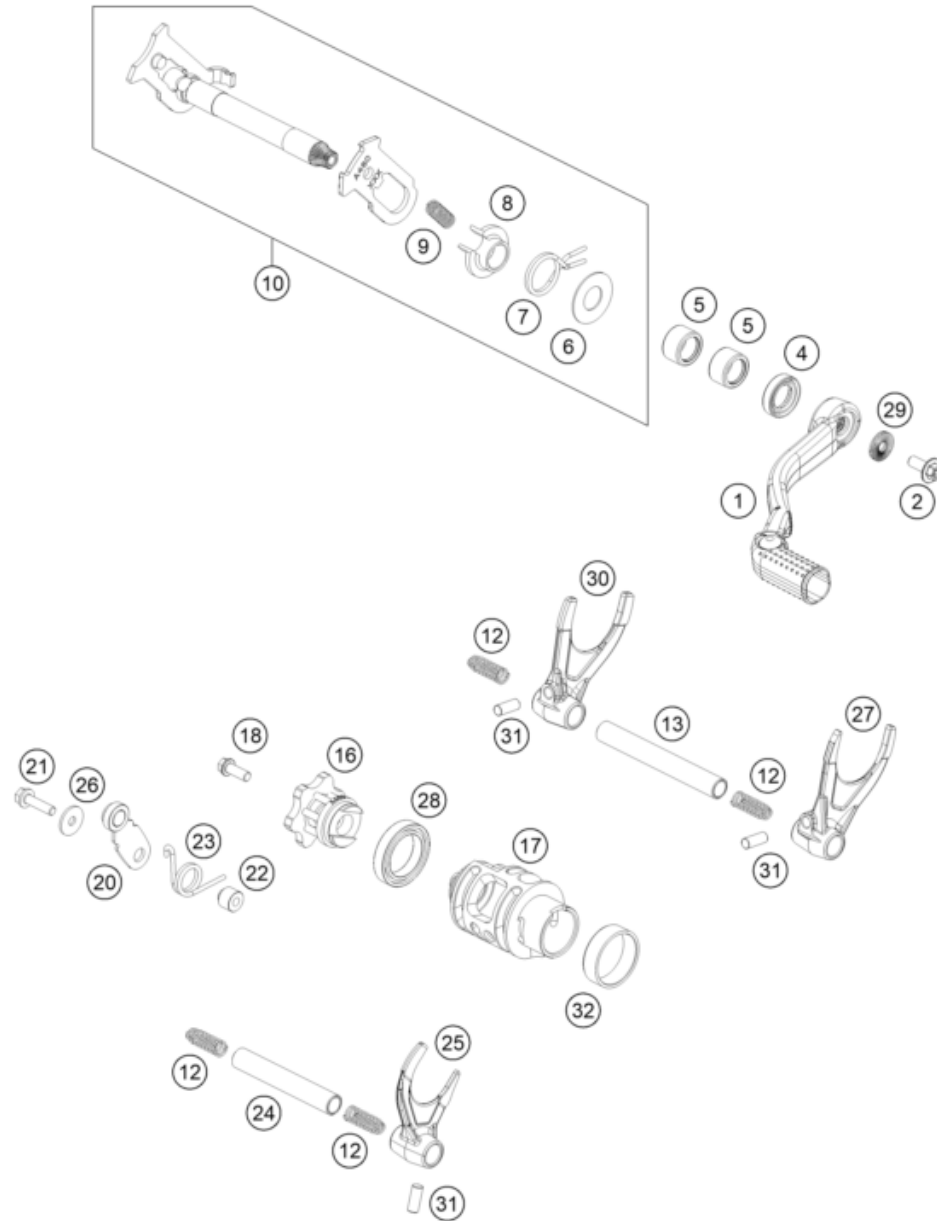

POS	PARTNUMBER		PIECE
1	A42034031000	Gear shift lever complete	1
2	0024060156S	HH collar screw M6x15 TX30	1
4	0760142460	radial shaft seal 14x24x6 B	1
5	54632095000	needle sleeve HK 1412 14x20x12	2
6	54634050000	STOP DISK 14X30X1	1
7	54834014000	RETURN SPRING 03	1
8	54634020000	SPRING GUIDE	1
9	56534013100	TENSIONING SPRING 0,8MM	1
10	A46034005033	Shift shaft cpl.	1
12	58038023400	Compression spring L=25mm D=0.9mm	4
13	A46034020000	Shift fork shaft (L=66 mm)	1
16	A46034015000	Shift star cpl.	1
17	A47034012000	Shift drum 5 gear	1
18	0025060306S	HH collar screw M6x30 TX30	1
20	A46034024044	Detent arm cpl.	1
21	0025050206S	Hex collar screw, M5x20 ISA30 SS	1
22	54634052300	SLEEVE FOR LOCKING LEVER	1
23	54834023000	LOCKING LEVER SPRING 03	1
24	A46034019000	Shift fork shaft (L=93 mm)	1
25	79234001000	SHIFTING FORK 4TH/5TH GEAR	1
26	0349000050	WASHER DIN7349-5X15X2	1
27	79234002000	SHIFTING FORK 2ND GEAR	1
28	0410002500700	Grooved ball bearing 6805 JR C3	1
29	50233041500	PAIR NORDLOCK WASHER M6	1
30	79234003000	SHIFTING FORK 1ST/3RD GEAR	1
31	0402061480	NEEDLE ROLLER DIN5402 6X14,8	3
32	79234012010	FRICTION BEARING CONTROLLER	1

23A4603411

60438

\* NEW PART

X ON DEMAND

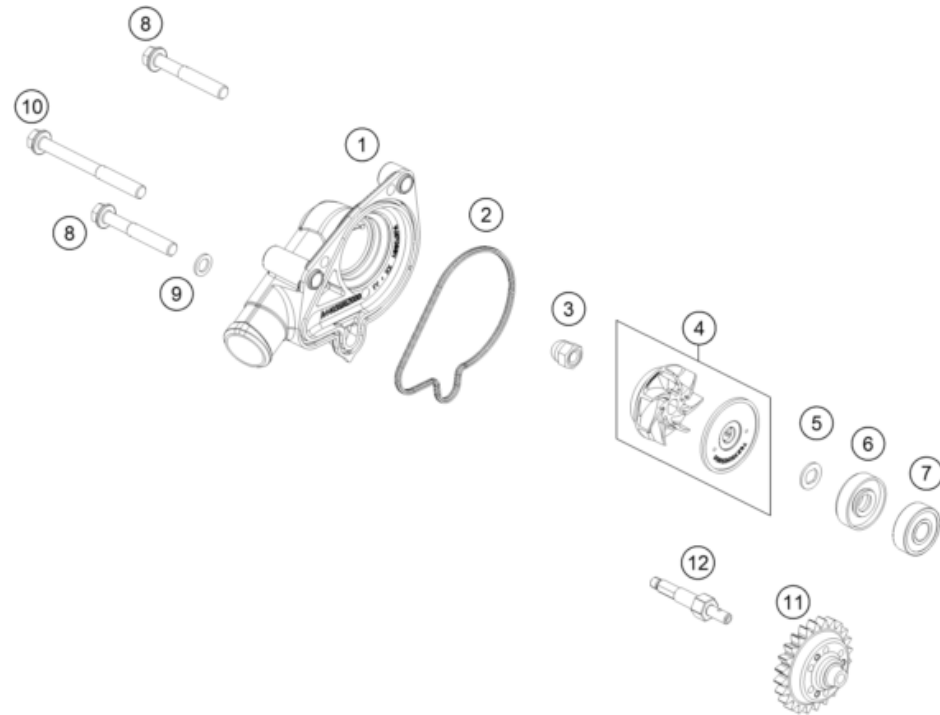

POS	PARTNUMBER		PIECE
1	A44035052000	Water pump cover	1
2	A44035052010	Water pump cover seal	1
3	61230045000	CAP NUT M6 STAINLESS STEEL	1
4	79235055044	WATER PUMP WHEEL CPL.	1
5	50435049000	PREFORMED WASHER	1
6	0760082472	SHAFT SEAL RING 8X24X7 A DUO	1
7	0625006087	GROOVED BALL BEAR. 608 2RS C3	1
8	0025060406	HH collar screw M6x40 TX30	2
9	0603061001	CU-SEAL RING DIN7603-6X10X1	1
10	0025060606	HH collar screw M6x60 TX30	1
11	A44035062024	Drive gear wheel	1
12	A44035054000	Water pump shaft	1

23A4603511

60439

\* NEW PART

X ON DEMAND

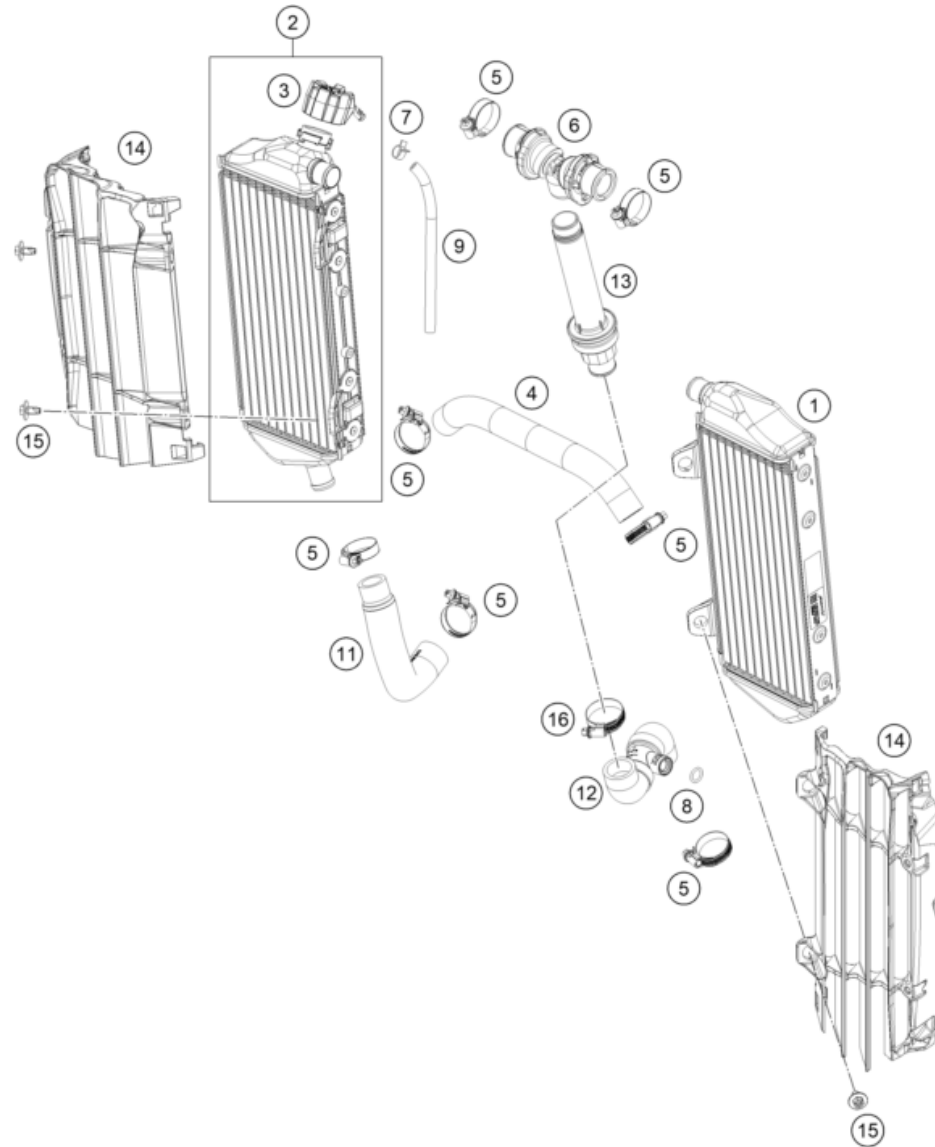

POS	PARTNUMBER		PIECE
1	A46035007000	Radiator left	1
2	A46035008000	Radiator right	1
3	A46035009000	Radiator cap	1
4	A46035025000	Pre-formed hose radiator left/right	1
5	10001020000	HOSE CLAMP GEMI 18-29	7
6	A46035071044	Y-piece cmpl.	1
7	59007017000	CLAMP YDNAC 10096F (9,6MM)	1
8	0770100020	o-ring 10.00x2.00 silicone	1
9	50335030001	PVC-HOSE 6X9	x
11	A44035024000	Pre-formed hose engine/radiator right	1
12	A44035020044	Hose system, temperature sensor 250/300	1
13	A44035073033	Threaded bushing w. thermo.	1
14	A46035036044C1	Radiator protection set, black	1
15	0900000601203	HH ISR collar screw M6x12-10.9 ISA30	4
16	0310000903200	Hose clip 20-32	1

23A4603530

63972

\* NEW PART

X ON DEMAND

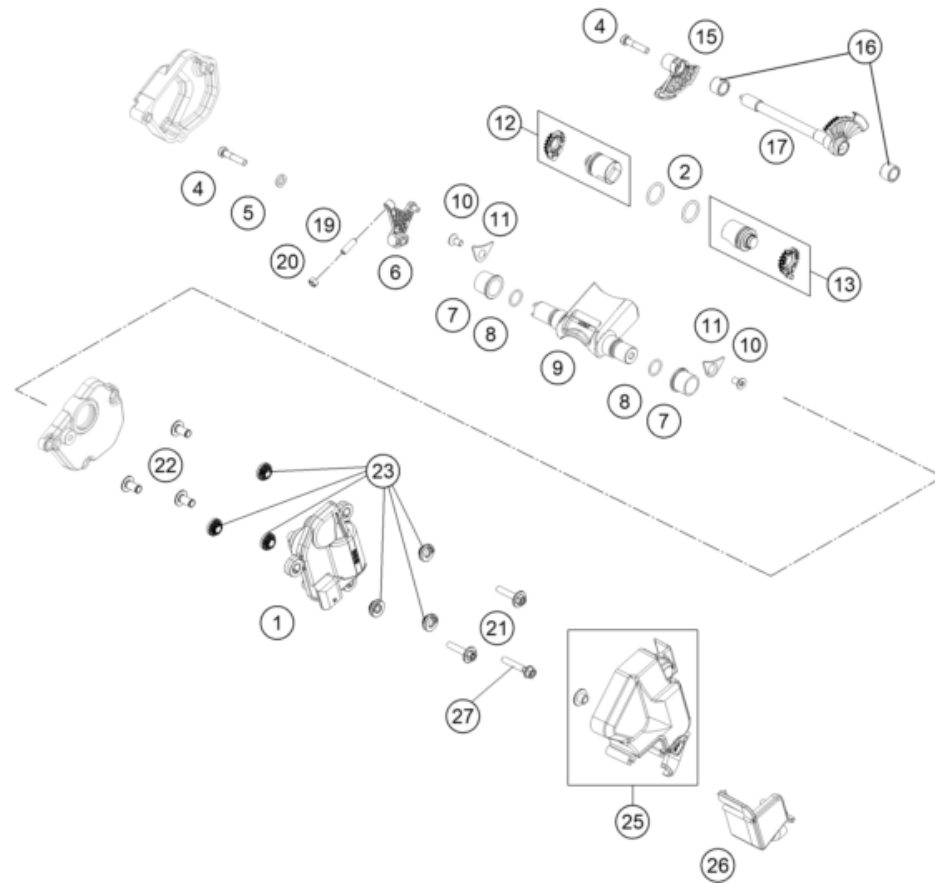

POS	PARTNUMBER		PIECE
1	A45041072033	Exhaust control actuator cpl.	1
2	0770160021	O-RING 16,00X2,00 VITON	2
4	0012050253S	Bolt DIN 6912 - M5x25 SS	2
5	50233041000	PAIR OF WASHERS M 6 NORDLOCK	1
6	A44037380000	control flap lever	1
7	50437023100	exhaust flap bushing	2
8	07700120151	O-ring 12x1.5 FPM75	2
9	A44037020000	Control flap 250	1
10	0019050106S	hex lobe countersunc screw M5x10 - 10.9	2
11	75030085000	RETAINING PLATE F. CS BEARING	2
12	A44037362044	Power valve right cmpl.	1
13	A44037361044	Power valve left cmpl.	1
15	A44037365000	controlgate right	1
16	0618101410	needle sleeve HK 1010 10x14x10	2
17	A44037370033	Intermediate shaft cmpl.	1
19	0913050160	Grub screw M5x16 with AH	1
20	0934050040	Nut M5 SW7	1
21	0000240502500S	HH collar screw, M5x25, ISA 30	2
22	A45041072010	Actuator bushing	3
23	A45041072005	Damper actuator	6
25	A42037096000	Actuator protection cap	1
26	A42037096020	Actuator protection cap	1
27	0025050306	HH COLLAR SCREW M5X30 TX30	1

23A4403710

70673

\* NEW PART

X ON DEMAND

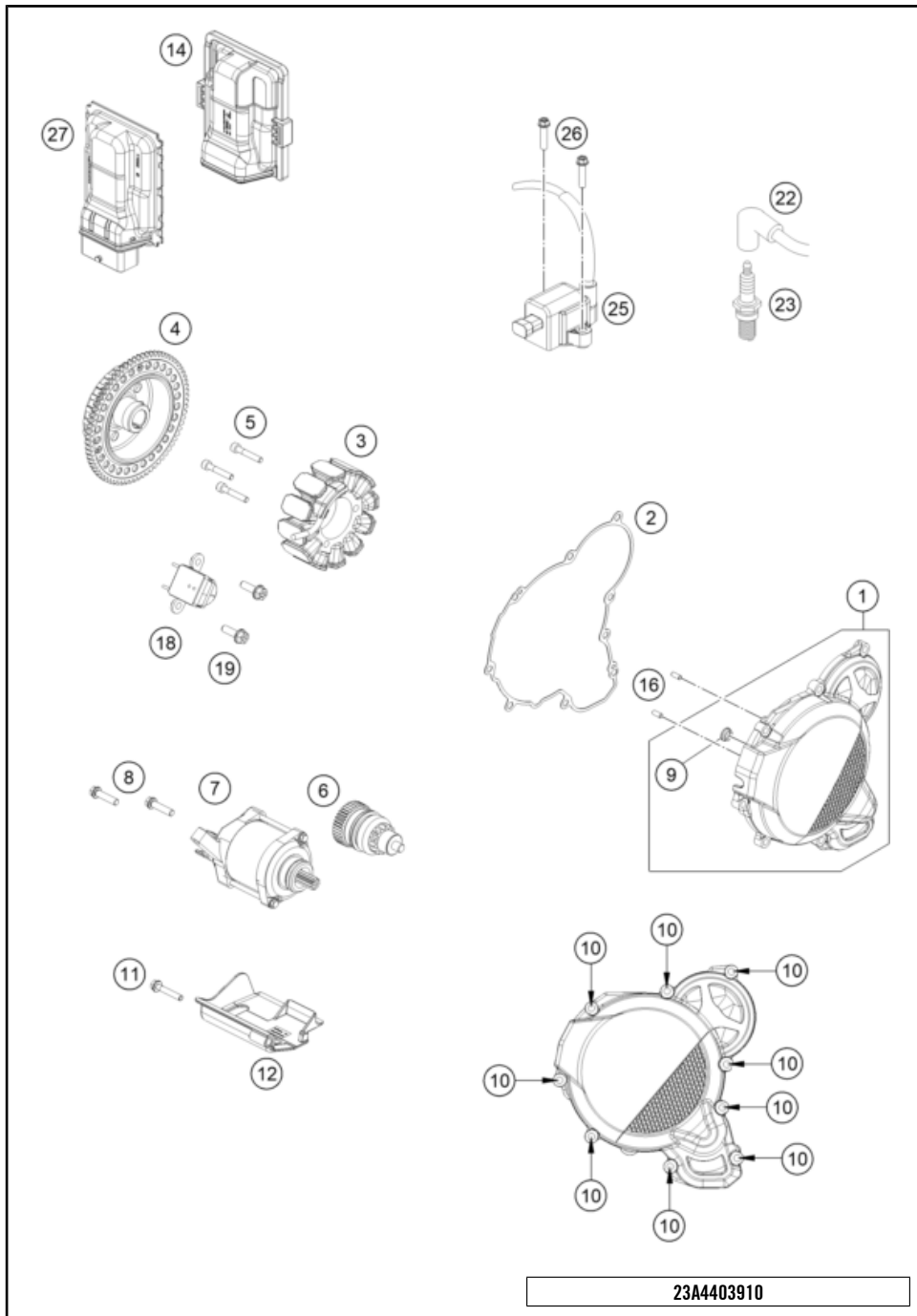

POS	PARTNUMBER		PIECE
1	A44030002044C1	Ignition cover cpl.	1
2	A44030040000	Ignition cover gasket	1
3	A44039404000	Stator	1
4	A44039405000	Rotor	1
5	0012050253S	Bolt DIN 6912 - M5x25 SS	3
6	55440126000	BENDIX	1
7	A44040201000	Starter motor	1
8	0025060256	HH collar screw M6x25 TX30	2
9	55540031000	Collar bushing	1
10	0025060206	HH collar screw M6x20 TX30	9
11	0025060306	HH collar screw M6x30 TX30	1
12	A44040040000	Starter motor cover	1
14	A45041031050	Engine control unit rubber	1
16	0402040980	NEEDLE ROL.DIN5402 NRB 4X9,8	2
18	55539034000	Pulse generator cpl.	1
19	0014050163S	Hex collar screw M 5x16 SW=6	2
22	A44039007100	Ignition cable	1
23	A44039093000	Spark plug	1
25	55639006000	Ignition coil	1
26	0025060256	HH collar screw M6x25 TX30	2
27	A45041031000	Engine control unit	1

63971

\* NEW PART X ON DEMAND

# THROTTLE BODY

Engine 250 SX 2025 2025

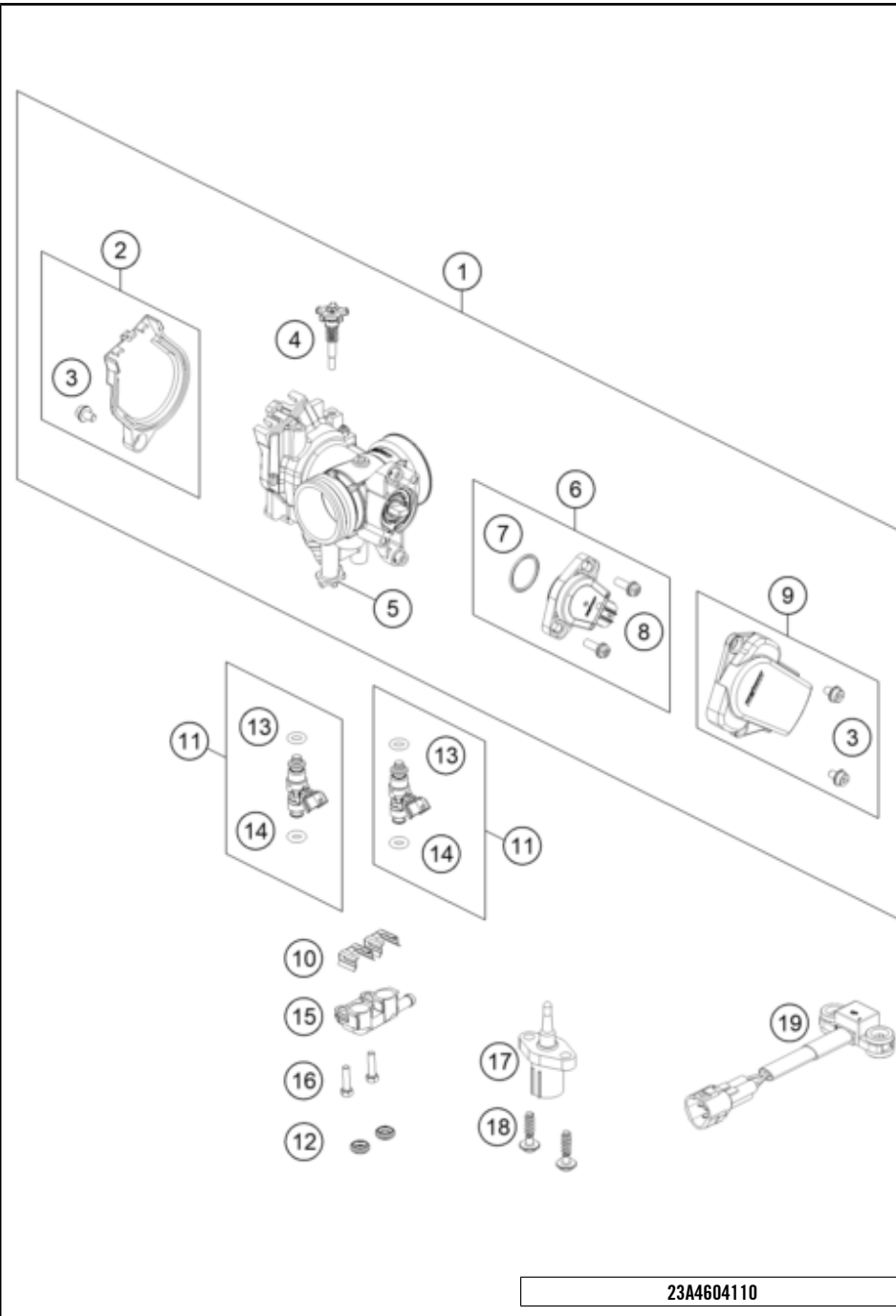

POS	PARTNUMBER		PIECE
1	A44041101000	Throttle body	1
2	79141056044	DKK Cover cpl.	1
3	79041056020	SPECIAL SCREW	3
4	A44041060044	STOP SCREW SET	1
5	79041070000	STARTER VALVE CPL.	1
6	79041077044	TPS CPL.	1
7	75041077110	O-RING	1
8	61041077020	SCREW THROTTLE POS. SENSOR	2
9	79141078044	TPS Cover cpl.	1
10	55441017000	Injector clip	2
11	A45041023044	Injector fuel rail	2
12	55441024000	Protective ring	2
13	55641023020	O-ring	2
14	55641023010	O-ring	2
15	A42041006000	Fuel manifold	1
16	0025050166	HH collar screw M5x16 TX30	2
17	61041080000	AMBIENT-AIR TEMPERATURE SENSOR	1
18	0081050181	SCREW FOR PLASTIC K50X18 T20	2
19	A46041088000	Roll-over sensor	1

23A4604110

63970

\* NEW PART

X ON DEMAND

A large, empty rectangular box with a thin black border, occupying the majority of the page. It is intended for the user to write notes related to the engine specifications mentioned in the header.

A large, empty rectangular box with a thin black border, occupying the majority of the page. It is intended for handwritten or typed notes.

A large, empty rectangular box with a thin black border, occupying the majority of the page. It is intended for handwritten or typed notes related to the engine specifications mentioned in the header.



# KTM.COM



083630YEN

KTM Sportmotorcycle GmbH  
5230 Mattighofen, Austria  
[www.ktm.com](http://www.ktm.com)

**KTM** POWERPARTS

**KTM** POWERWEAR

**KTM** ORIGINAL SPARE PARTS



Art. Nr.: 083630YEN 13. Feb 2024