



SPAREPARTSCATALOG

Engine 250 SX 2026 2026

ART.-NR.: 083630ZEN



All information contained is without obligation. WP Suspension GmbH particularly reserves the right to modify any equipment, technical specifications, prices, colors, shapes, materials, services, service work, constructions, equipment and the like so as to adapt them to local conditions or to cancel any of the above items, all without previous announcement and without giving reasons. WP Suspension GmbH may stop manufacturing certain models without previous notice. WP Suspension GmbH shall not be held liable for any deviations of availability and/or ability to deliver, illustrations, descriptions, printing and/or other errors. The illustrated models partly contain extra equipment, which is not applied to standard models.

© by WP Suspension GmbH, Mattighofen AUSTRIA; All rights reserved; Reprint, also in extracts, with written allowance of WP Suspension GmbH, Mattighofen only.

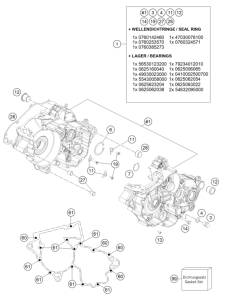
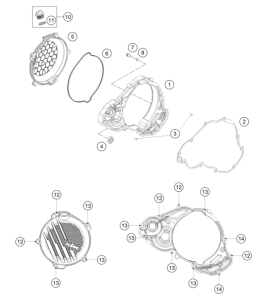
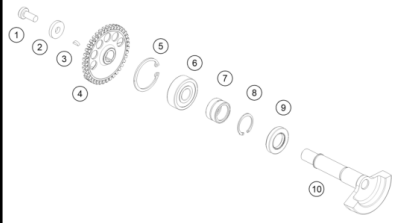
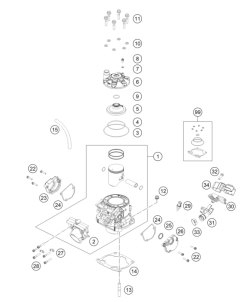
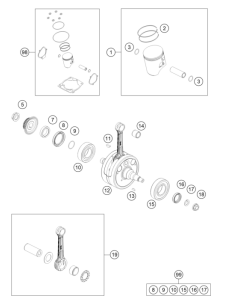
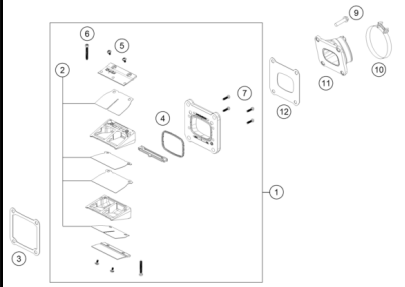
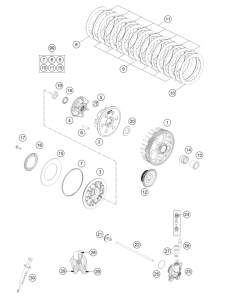
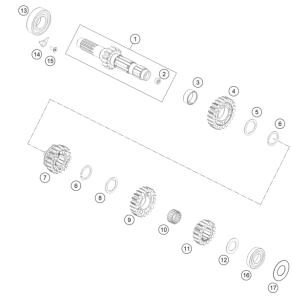
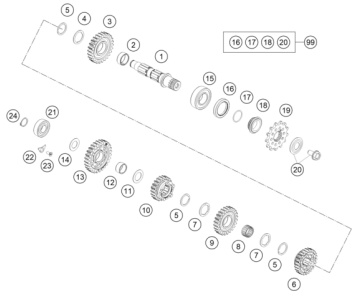
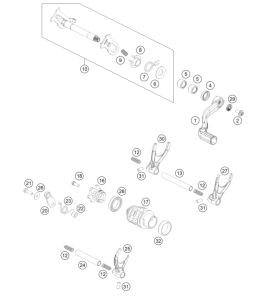
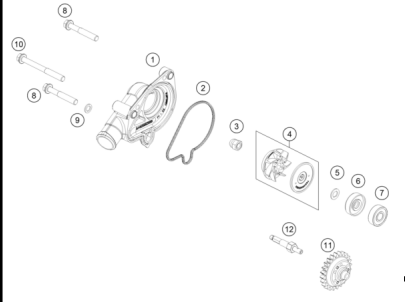
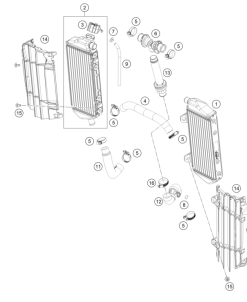
<p>ENGINE CASE</p>  <p>3</p>	<p>CLUTCH COVER</p>  <p>4</p>	<p>BALANCER SHAFT</p>  <p>5</p>	<p>CYLINDER, CYLINDER HEAD</p>  <p>6</p>
<p>CRANKSHAFT, PISTON</p>  <p>7</p>	<p>REED VALVE CASE</p>  <p>8</p>	<p>CLUTCH</p>  <p>9</p>	<p>TRANSMISSION I - MAIN SHAFT</p>  <p>10</p>
<p>TRANSMISSION II - COUNTERSHAFT</p>  <p>11</p>	<p>SHIFTING MECHANISM</p>  <p>12</p>	<p>WATER PUMP</p>  <p>13</p>	<p>COOLING SYSTEM</p>  <p>14</p>

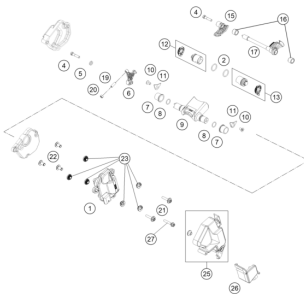
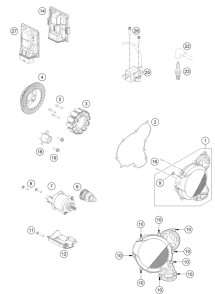
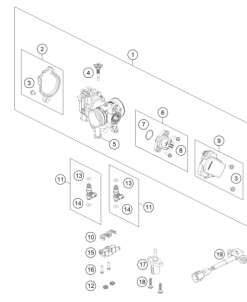
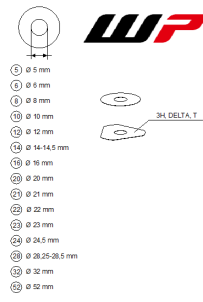
<p>EXHAUST CONTROL</p>  <p style="text-align: right;">15</p>	<p>IGNITION SYSTEM</p>  <p style="text-align: right;">16</p>	<p>THROTTLE BODY</p>  <p style="text-align: right;">17</p>	<p>WP SHIMS FOR SETTING</p>  <ul style="list-style-type: none"> ① Ø 5 mm ② Ø 6 mm ③ Ø 8 mm ④ Ø 10 mm ⑤ Ø 12 mm ⑥ Ø 14-14.5 mm ⑦ Ø 16 mm ⑧ Ø 20 mm ⑨ Ø 21 mm ⑩ Ø 22 mm ⑪ Ø 22 mm ⑫ Ø 24.5 mm ⑬ Ø 26.25-28.5 mm ⑭ Ø 32 mm ⑮ Ø 32 mm <p style="text-align: right;">18</p>

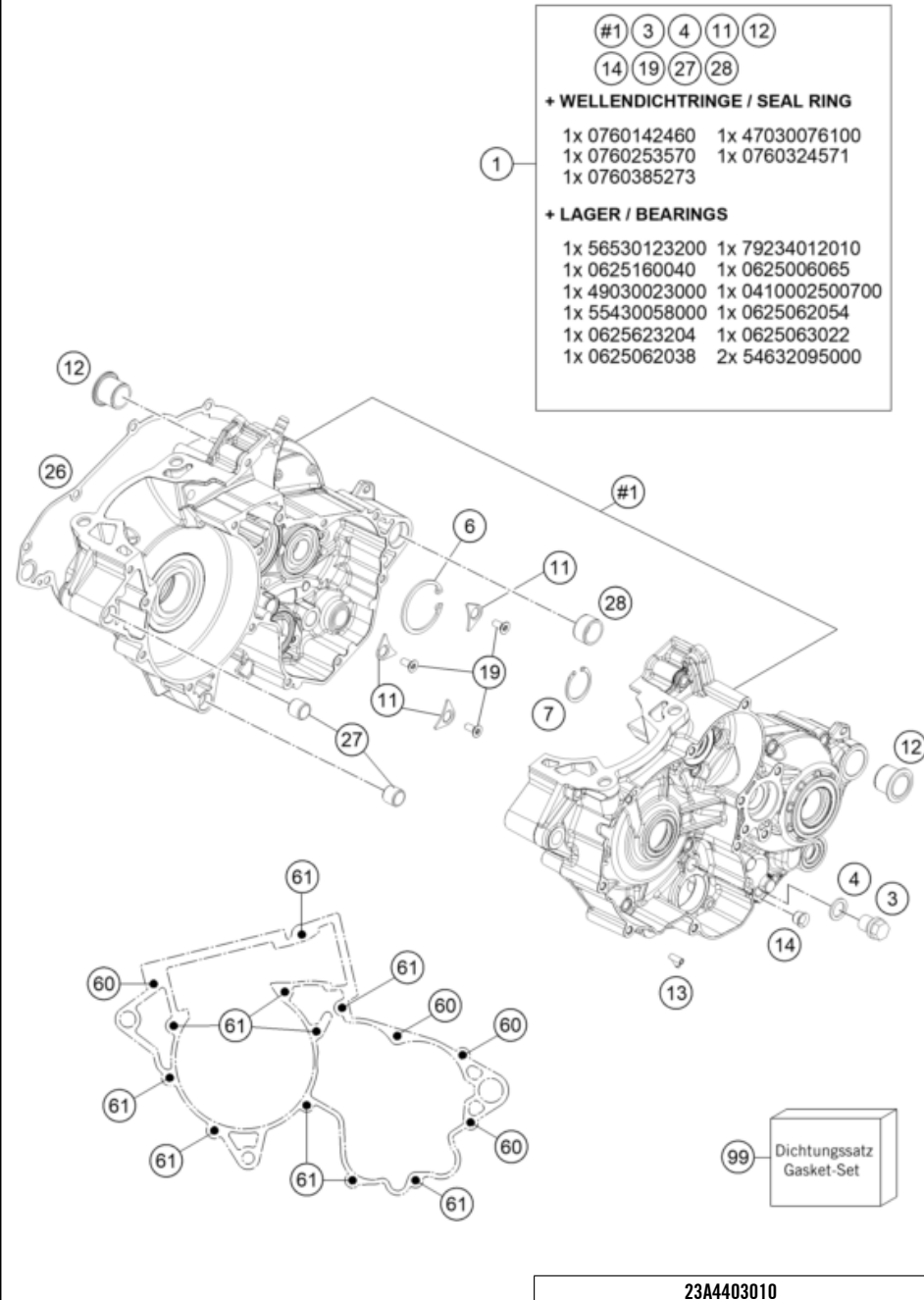

POS	PARTNUMBER	PIECE
1	A4403000044	Engine case compl.
3	58030021100	oil drain plug with magnet
4	58038022000	CU-seal ring DIN7603-12X18X1.5
6	0472042175	CIRCLIP DIN0472-42X1,75
7	55430059100	CIRCLIP DIN0472-28X1,2
11	75030085100	Retaining bracket crankshaft bearing
12	79230010000	Housing bush
13	45130022000	ANGLE PIECE 50CCM LC 2001
14	55540031000	Collar bushing
19	0019050121S	INT. TORX FLAT HEAD M5X12 T25
26	A44030025000	Clutch cover gasket, inner
27	54630027000	DOWEL BUSHING 13,8X11X12
28	54830027100	Dowel, 21x12
60	0025060606	HH collar screw M6x60 TX30
61	0025060456	HH COLLAR SCREW M6X45 TX30
99	A44030099000	Gasket kit Engine MX 250/300

60193

* NEW PART

X ON DEMAND

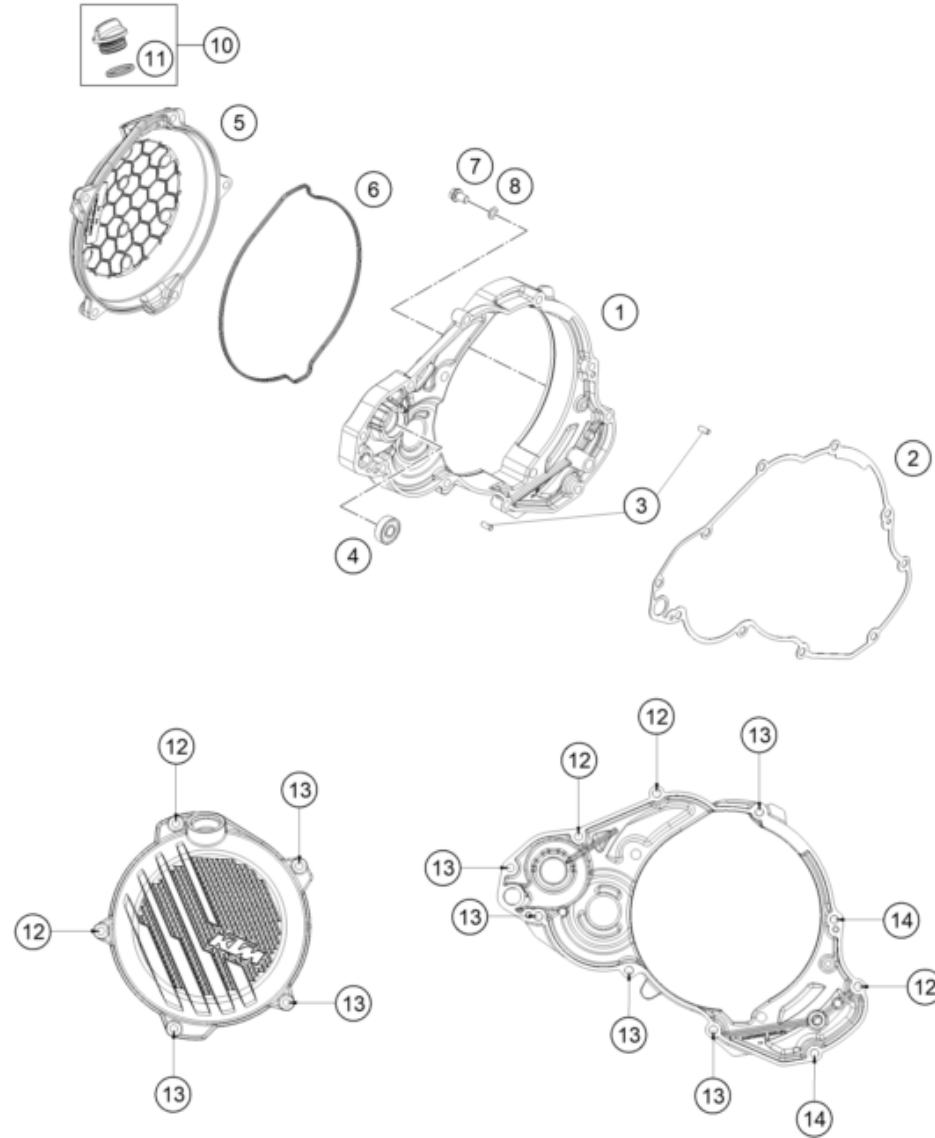

POS	PARTNUMBER		PIECE
1	A44030001044	Clutch cover, inner, cmpl.	1
2	A44030025000	Clutch cover gasket, inner	1
3	0402040980	Needle roll.DIN5402 NRB 4X9.8	2
4	0625006087	Grooved ball bearing 608 2RS C3	1
5	A48030026000C1	Clutch cover outside	1
6	A48030027000	Clutch cover gasket external	1
7	0025060106	HH collar screw M6x10 TX30	1
8	0603061001	CU-seal ring DIN7603-6X10X1	1
10	79430020033	Oil filler cap cmpl. M24x3	1
11	0770191015	O-RING 19,00X3,00 NBR	1
12	0025060606	HH collar screw M6x60 TX30	5
13	0025060256	HH collar screw M6x25 TX30	8
14	0025060406	HH collar screw M6x40 TX30	2

23A4403020

60199

* NEW PART

X ON DEMAND

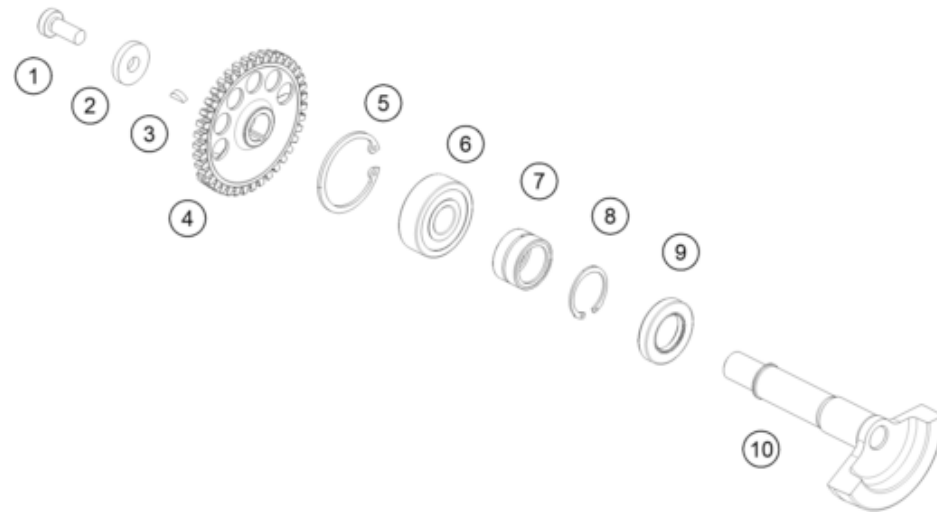

POS	PARTNUMBER		PIECE
1	0035080206S	SHCS M8x20 TX45	1
2	0340084234	WASHER DIN 6340 8,4X23X4	1
3	0888030037	WOODRUFF KEY DIN6888-3X3,7	1
4	55430056000	AGW-GEAR WHEEL	1
5	0472042175	CIRCLIP DIN0472-42X1,75	1
6	0625063022	GROOVED BALL BEARING 6302 C3	1
7	55430058000	NEEDLE BEARING NK20X16XL	1
8	55430059100	CIRCLIP DIN0472-28X1,2	1
9	47030076100	SEAL SHAFT RING 20X35X6 BTSL	1
10	A44030057000	Balancer shaft	1

175543030

60195

* NEW PART

X ON DEMAND

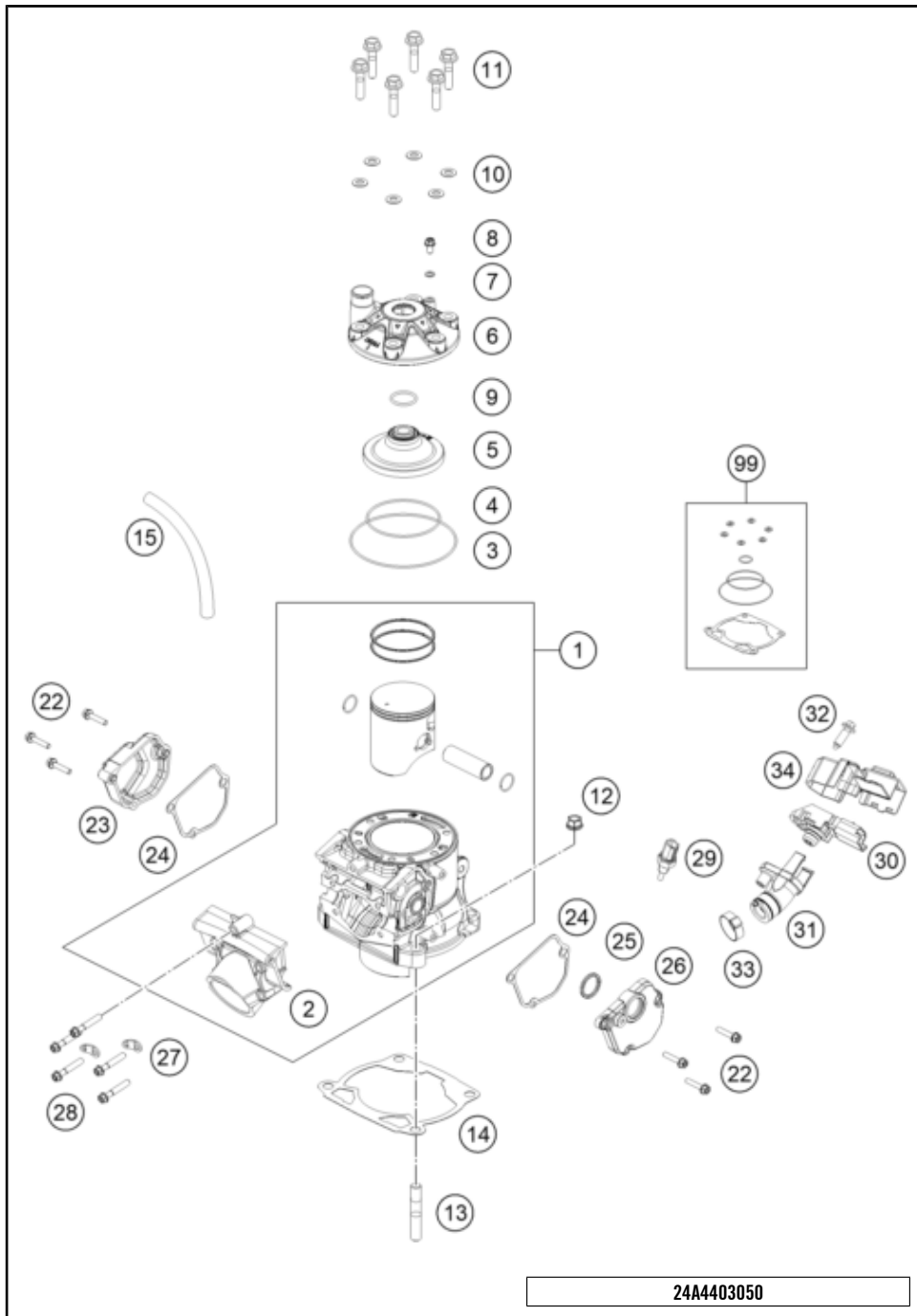

24A4403050

POS	PARTNUMBER		PIECE
1	A44030238000	Cylinder + Piston MX 250 2023	1
2	A44037201000	Intermediate flange	1
3	0770107020	O-Ring 107x2	1
4	0770730020	O-RING 73,00X2,00 VITON	1
5	A44030060000	Combustion chamber insert KTM 250 SX	1
6	A45030006100	Cylinder head	1
7	0603061001	CU-seal ring DIN7603-6X10X1	1
8	0025060106	HH collar screw M6x10 TX30	1
9	0770023025	O-ring 23x2,5 Viton 75SH	1
10	56530080000	CU-SEAL RING 8 X 16 X 1	6
11	54830079000	COLLAR SCREW M 8X35 WS=13	6
12	55530044000	Collar nut M10-SW13 ZnNi	4
13	0835100300	Stud bolt M10x30	4
14	A44030035020	Cylinder base gasket	x
14	A44030035025	Cylinder base gasket	x
14	A44030035030	Cylinder base gasket	x
14	A44030035040	Cylinder base gasket	x
14	A44030035050	Cylinder base gasket	x
14	A44030035070	Cylinder base gasket	x
14	A44030035080	Cylinder base gasket	x
15	A42030087000	Engine vent hose	x
22	0025050256	HH COLLAR SCREW M5X25 ISA30	6
23	A44037007000	exhaust control cover right	1
24	A44037006000	Control cover seal, left	2
25	0770002226200	X-ring 21.89x2.62 FKM 70	1
26	A44037005000	exhaust control cover left	1
27	51005174000	Retaining cap	2
28	0025060356	HH collar screw M6x35 TX30	5
29	79435047000	Water temperature sensor	1
30	A45041075000	Crank case pressure sensor	1
31	A44041087000	Pressure sensor flange	1
32	0017060206	SCREW F. PLASTIC K60X20AL SW6	1
33	00050210706	VARIABLE ONE-EAR CLAMP 21,0MM	1
34	A45041075060	Pressure sensor cover	1
99	A44030097000	Sealkit cylinder MX 250/300	x

79223

* NEW PART

X ON DEMAND

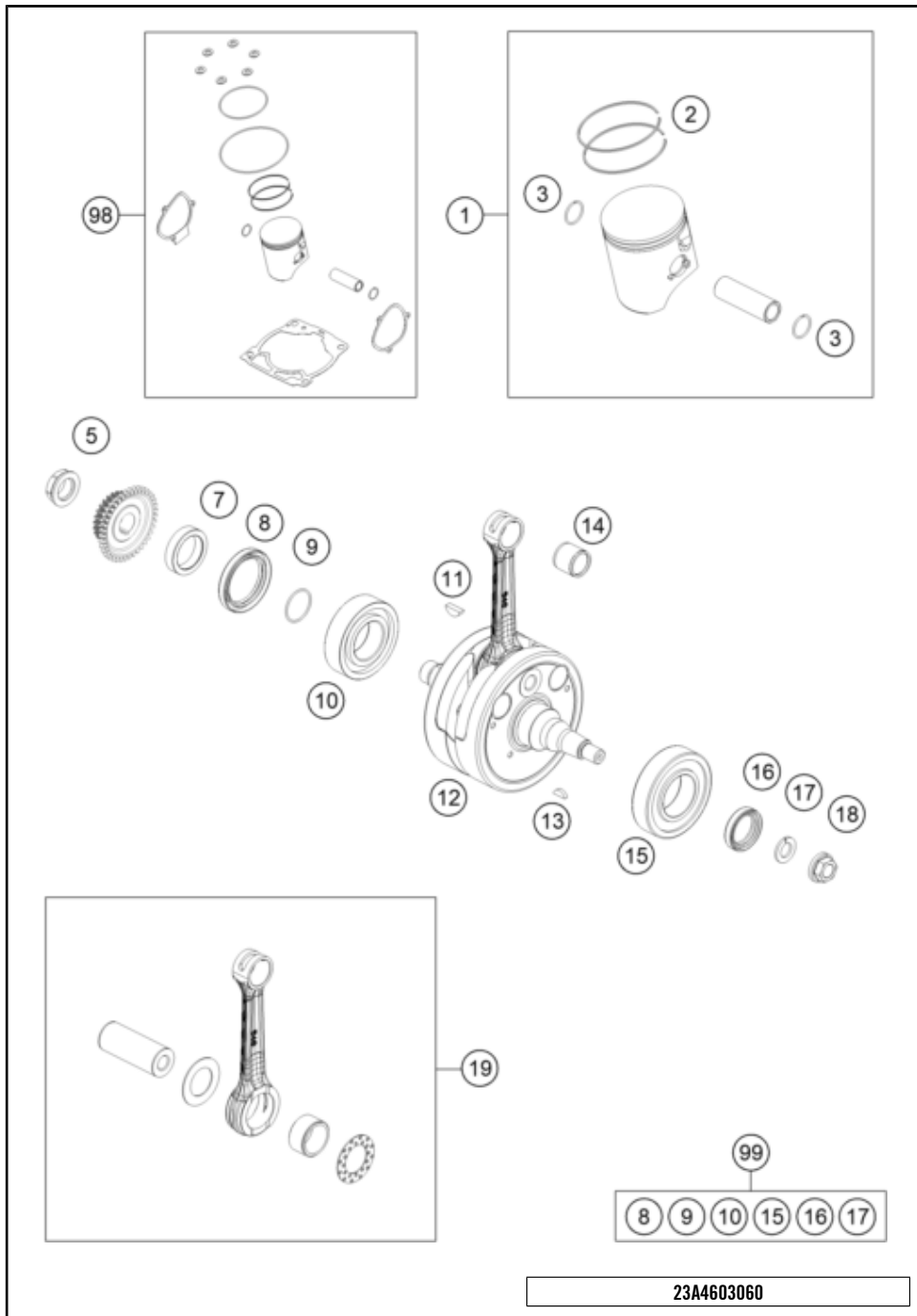

POS	PARTNUMBER		PIECE
1	55430007000 I	Piston cpl. I	1
1	55430007000 II	Piston cpl. II	1
2	54830232000	TRAPEZOID RING 250 66,4 MM	2
3	54030074000	WIRE LOCK RING C18X1,5	2
5	0910001801000S	Nut M18x1.5 Precote	1
7	55430016000	DISTANCE SLEEVE	1
8	0760385273	SHAFT SEAL RING 38X52X7BTSL	1
9	0770250015	O-RING 25,00X1,50 NBR 70	1
10	0625623204	BALL BEARING 32X65X17 NTN	1
11	6946005	WOODRUFF KEY 5X6,5 HARDED	1
12	55430118100	CRANKSHAFT EXC	1
13	0888030050	WOODRUFF KEY DIN6888-3X5X13	1
14	54430034000	NEEDLE BEARING KBK 18X22X20	1
15	56530123200	CYLIND.ROL.BEAR. NJ207ET2XCS42	1
16	0760253570	SHAFT SEAL RING 25X35X7 BTSL	1
17	50230029012	LOCKING RING VSK 12	1
18	49030021000	COLLAR NUT M12X1 R/S	1
19	54830015244	CON.ROD REP.SET 250/300	x
98	A44030007010 I	Pistonkit Gr.I MX 250	x
98	A44030007010 II	Pistonkit Gr.II MX 250	x
99	54830018488	Crankshaft repair kit	x

23A4603060

72581

* NEW PART X ON DEMAND

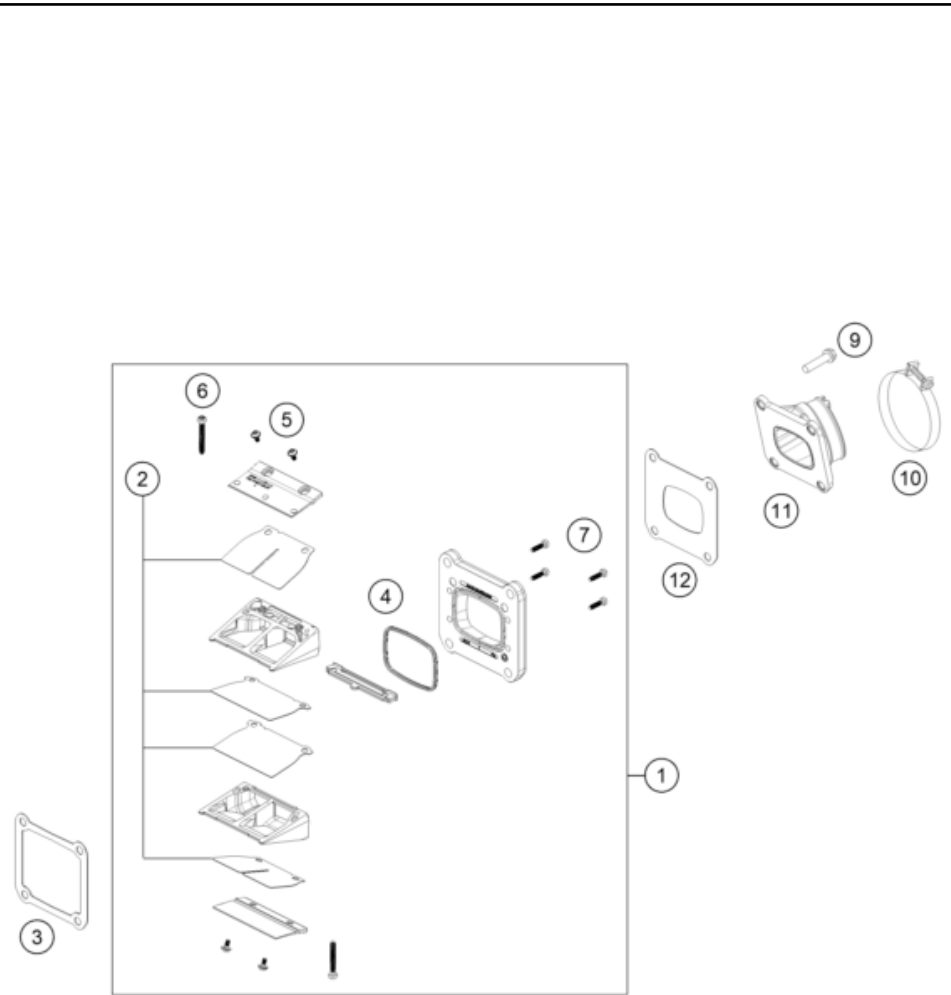

POS	PARTNUMBER		PIECE
1	A44030051044	Reed valve case compl.	1
2	50530152044	Reed Valve Set	1
3	50430098050	GASKET REED VALVE CASE	1
4	54830153050	GASKET SUPPORTING PLATE	1
5	00810300553	EJOT DELTA PT SCREW 30X5,5	4
6	0081035253	EJOT DELTA PT SCREW 35X25	2
7	0081030124	EJOT DELTA PT SCREW 30X12	4
9	0025060256	HH collar screw M6x25 TX30	4
10	54330061000	Hose clip GEMI 52mm	1
11	50430050000	Intake flange	1
12	50430098060	Gasket intake flange	1

23A4603070

60197

* NEW PART

X ON DEMAND

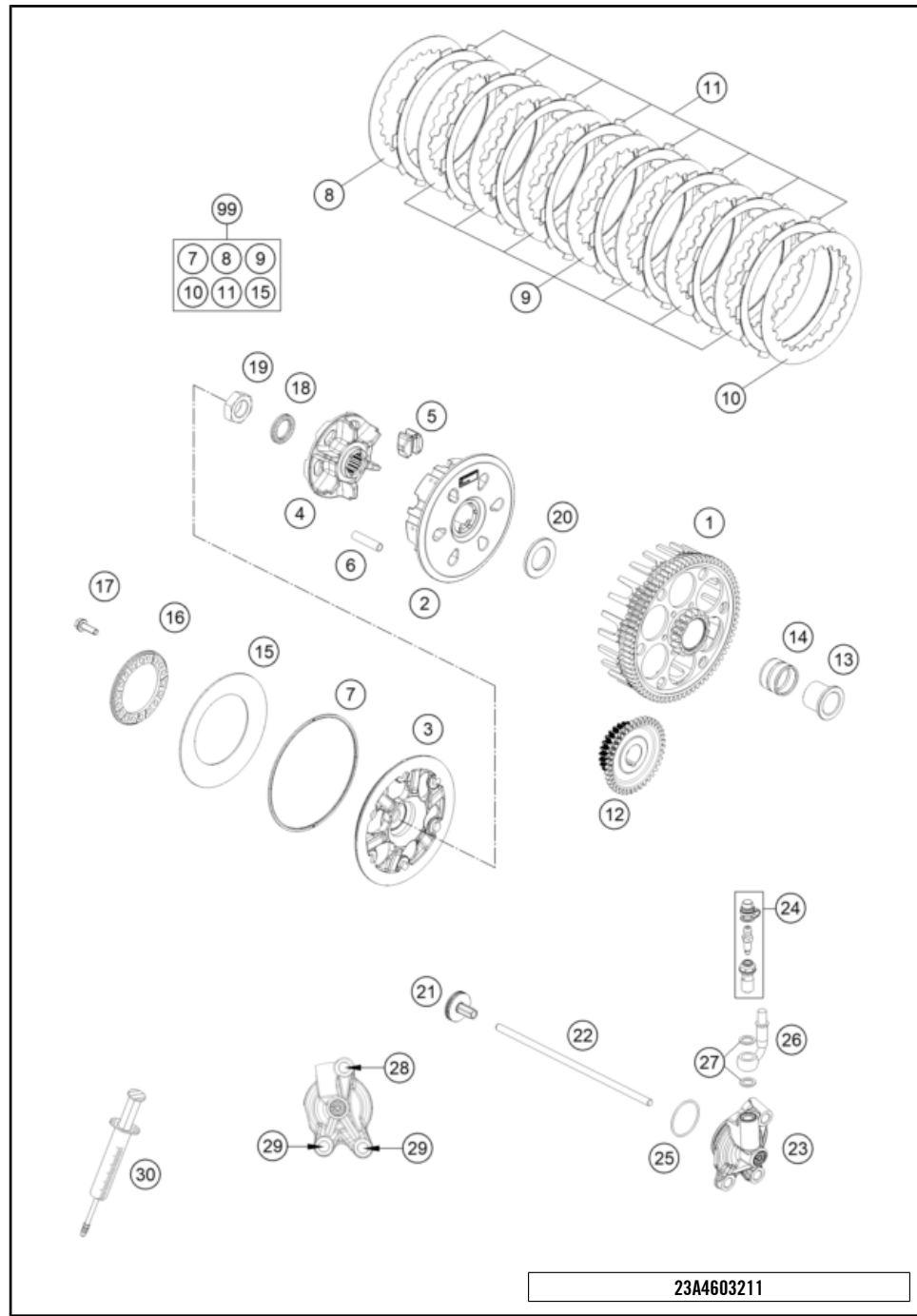

POS	PARTNUMBER		PIECE
1	A44032101072	Outer clutch hub	1
2	78132002400	Inner clutch hub	1
3	79432003100	Clutch pressure plate	1
4	78132002211	Clutch center	1
5	78132025100	DAMPING RUBBER	6
6	77232104000	Sleeve, 7.95x38	6
7	78132013000	WASHER 112X118X1.5	1
8	59032010100	INTERMEDIATE DISC 1MM 2002	1
9	59032010200	INTERMEDIATE DISC 1,4MM 2002	7
10	78932010000	INTERMEDIATE DISC 1MM	1
11	54832011100	LINING DISC 1,95 MM	8
12	55432024026	PRIMARY GEAR	1
13	A46032015000	Collar sleeve	1
14	0405252910	NEEDLE BEAR K 25X29X10	1
15	78132005000	BELLEVILLE SPRING 71X115X1,5 l	1
16	78132006200	Spring retainer	1
17	0025050166	HH collar screw M5x16 TX30	6
18	0252012002900	Wedge lock washer 19.5x29x3.4	1
19	0936181506	Hex nut DIN0936-M18x1.5 right	1
20	78932009000	WASHER 22 X 36,5 X 3	1
21	78132057144	PRESSURE PIECE CPL.	1
22	A48032054000	Push rod	1
23	79232061044	OUTPUT CYLINDER CPL.	1
24	79032064000	BLEEDER SCREW CPL.	1
25	0770300015	O-ring 30x1.5 NBR 70	1
26	79232063000	CLUTCH PIPE	1
27	0603082121	SEAL RING CU DIN7603- 8X12X1	2
28	0025060256	HH collar screw M6x25 TX30	1
29	0025060166	HH collar screw M6x16 TX30	2
30	50329050000	Vent injektion hydr. clutch	1
99	54832011110	CLUTCH KIT 250/300 13-15	x

79224

* NEW PART

X ON DEMAND

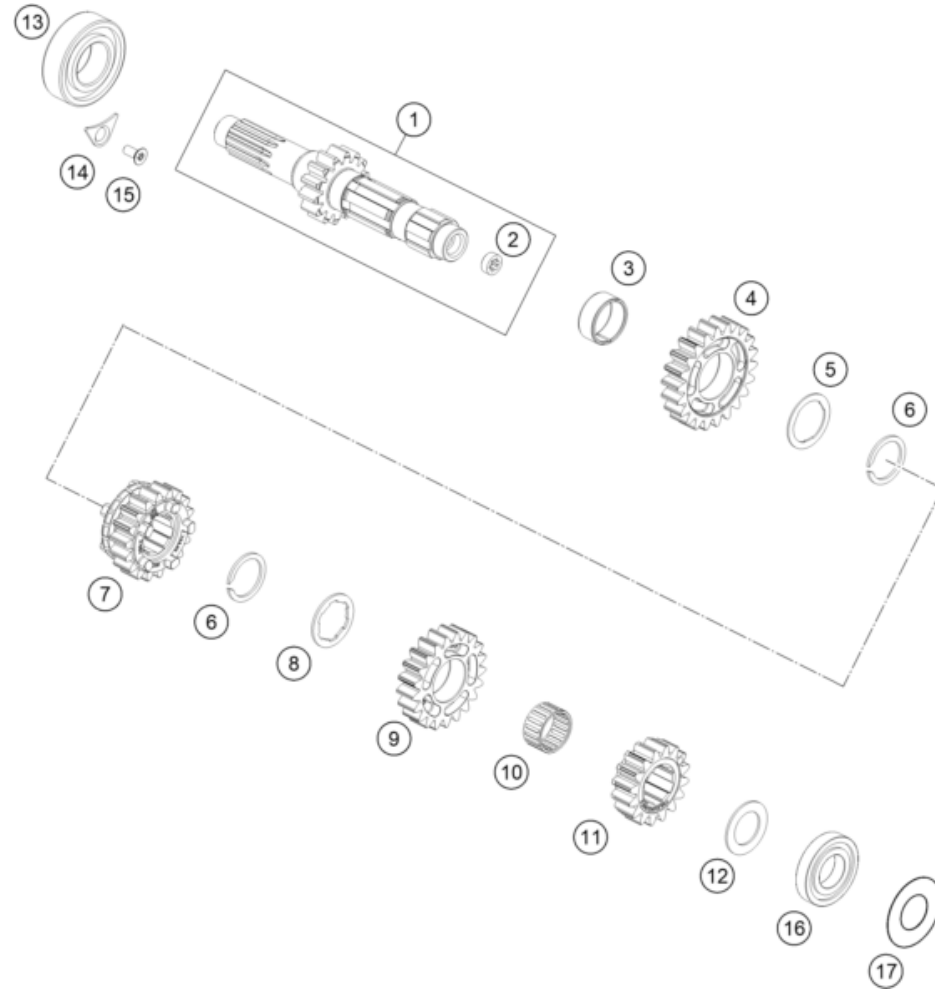

POS	PARTNUMBER		PIECE
1	A47033001000	Main shaft compl.	1
2	79133001010	bushing	1
3	0405242812	NEEDLE BEAR. K24X28X11,9 DIV.	1
4	79333505000	Idle gear 5 th.	1
5	79333043000	Stop disk	1
6	77033022100	Retaining ring 25x1,65	2
7	79333503000	Sliding gear 3 rd.	1
8	79333030000	Trust washer	1
9	79333504000	Idle gear 4 th	1
10	0405222613	NEEDLE BEAR. K 22X26X13 TN	1
11	79333002000	Fixed gear 2nd g/16 teeth	1
12	77233015000	DISK 20,2X32X1,3	1
13	0625062056	Groove ball bearing 6205 C4 NTN	1
14	75030085100	Retaining bracket crankshaft bearing	1
15	0019050121S	INT. TORX FLAT HEAD M5X12 T25	1
16	0625160041	BALL BEARING TM 16004 C4	1
17	77233088000	SPACER SHIM 21X42X0.2	1

227953330

58158

* NEW PART

X ON DEMAND

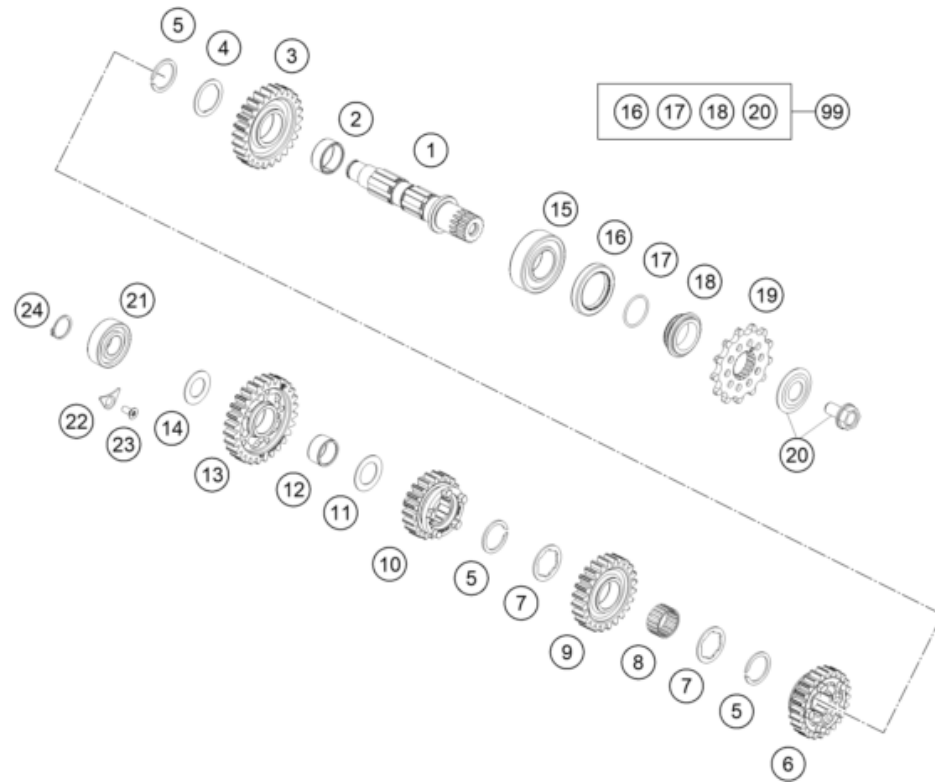

POS	PARTNUMBER		PIECE
1	79333010000	Countershaft	1
2	0405242812	NEEDLE BEAR. K24X28X11,9 DIV.	1
3	79333512000	Idler gear 2nd.	1
4	79333043000	Stop disk	1
5	77033022100	Retaining ring 25x1,65	3
6	79333514000	Sliding gear 4th	1
7	59033030000	STOP DISC 25,2X32X1,5	2
8	0405222613	NEEDLE BEAR. K 22X26X13 TN	1
9	79333513000	Idler gear 3rd	1
10	79333515000	Sliding gear 5th	1
11	59033080000	Shim 20x31.9x1	1
12	0405202413	NEEDLE BEAR. K20X24X13	1
13	79333511000	Idler gear 1 st.	1
14	56033030000	STOP DISC 17,2X30X1	1
15	49030023000	cylindrical roller bearing NJ205	1
16	0760324571	SHAFT SEAL RING 32X45X7 BSLNBR	1
17	0770020220	O-ring 25,12X1,78 NBR70	1
18	78133014000	SPACER SLEEVE COUNTER	1
19	79233029014	Sprocket 14-t	1
19	79233029013	Sprocket 13-t	x
20	59033034044	SCREW 10.9+SPRING WASHER	1
21	0625062038	Ballbearing NTN 6203JR2CM21	1
22	75030085100	Retaining bracket crankshaft bearing	1
23	0019050121S	INT. TORX FLAT HEAD M5X12 T25	1
24	0471170015	CIRCLIP DIN 0471-17X1, 5	1
99	00050000941	COUNTER SHAFT REP.KIT 4 STROKE	x

227953360

58159

* NEW PART

X ON DEMAND

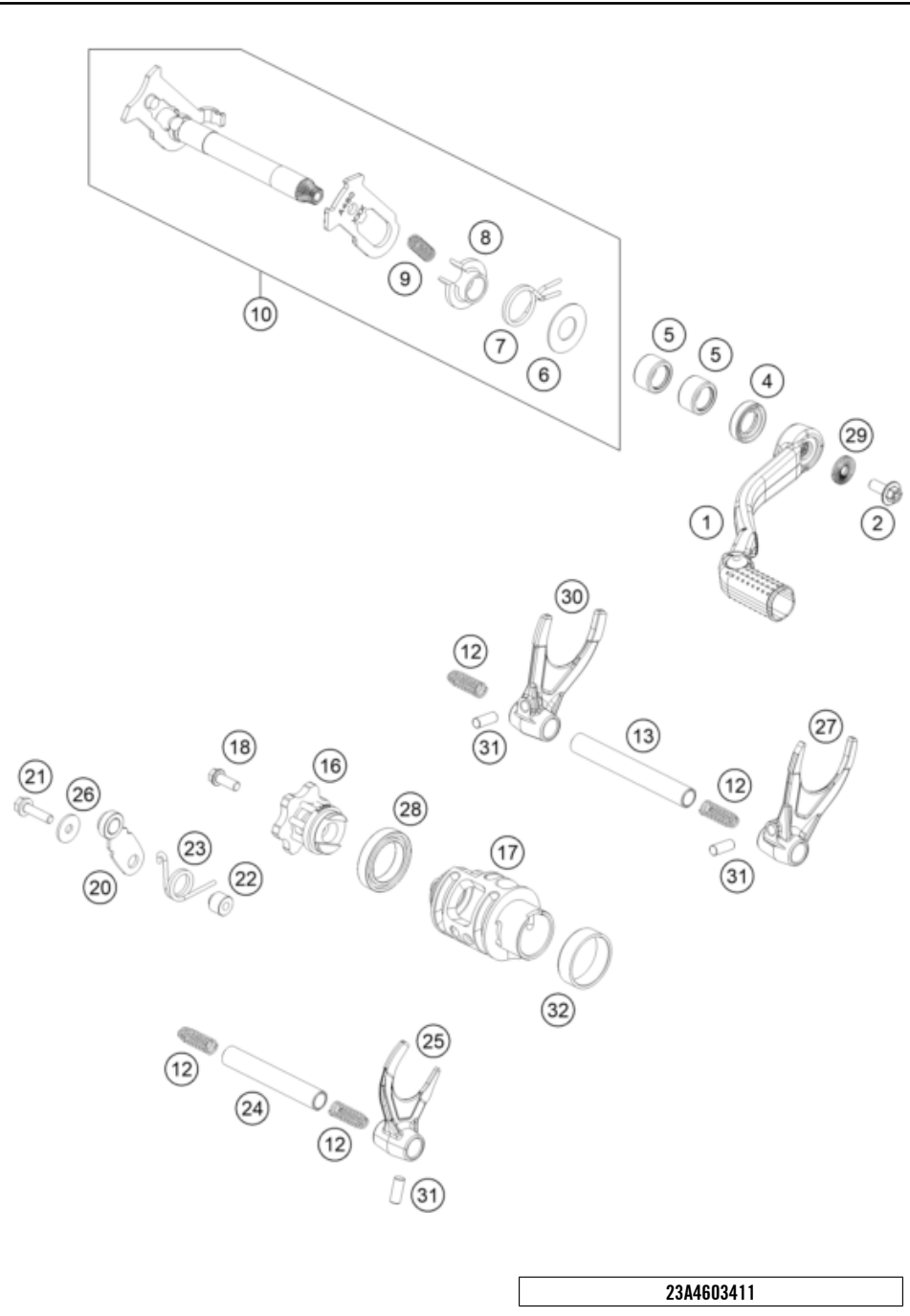

POS	PARTNUMBER		PIECE
1	A42034031000	Gear shift lever cpl.	1
2	0024060156S	HH collar screw M6x15 TX30	1
4	0760142460	radial shaft seal 14x24x6 B	1
5	54632095000	needle sleeve HK 1412 14x20x12	2
6	54634050000	STOP DISK 14X30X1	1
7	54834014000	RETURN SPRING 03	1
8	54634020000	SPRING GUIDE	1
9	56534013100	TENSIONING SPRING 0,8MM	1
10	A46034005033	Shift shaft cpl.	1
12	58038023400	Compression spring L=25mm D=0.9mm	4
13	A46034020000	Shift fork shaft (L=66 mm)	1
16	A46034015000	Shift star cpl.	1
17	A47034012000	Shift drum 5 gear	1
18	0025060306S	HH collar screw M6x30 TX30	1
20	A46034024044	Detent arm cpl.	1
21	0025050206S	Hex collar screw, M5x20 ISA30 SS	1
22	54634052300	SLEEVE FOR LOCKING LEVER	1
23	54834023000	LOCKING LEVER SPRING 03	1
24	A46034019000	Shift fork shaft (L=93 mm)	1
25	79234001000	SHIFTING FORK 4TH/5TH GEAR	1
26	0349000050	WASHER DIN7349-5X15X2	1
27	79234002000	SHIFTING FORK 2ND GEAR	1
28	0410002500700	Grooved ball bearing 6805 JR C3	1
29	50233041500	Pair nordlock washer M6	1
30	79234003000	SHIFTING FORK 1ST/3RD GEAR	1
31	0402061480	NEEDLE ROLLER DIN5402 6X14,8	3
32	79234012010	FRICTION BEARING CONTROLLER	1

23A4603411

60438

* NEW PART X ON DEMAND

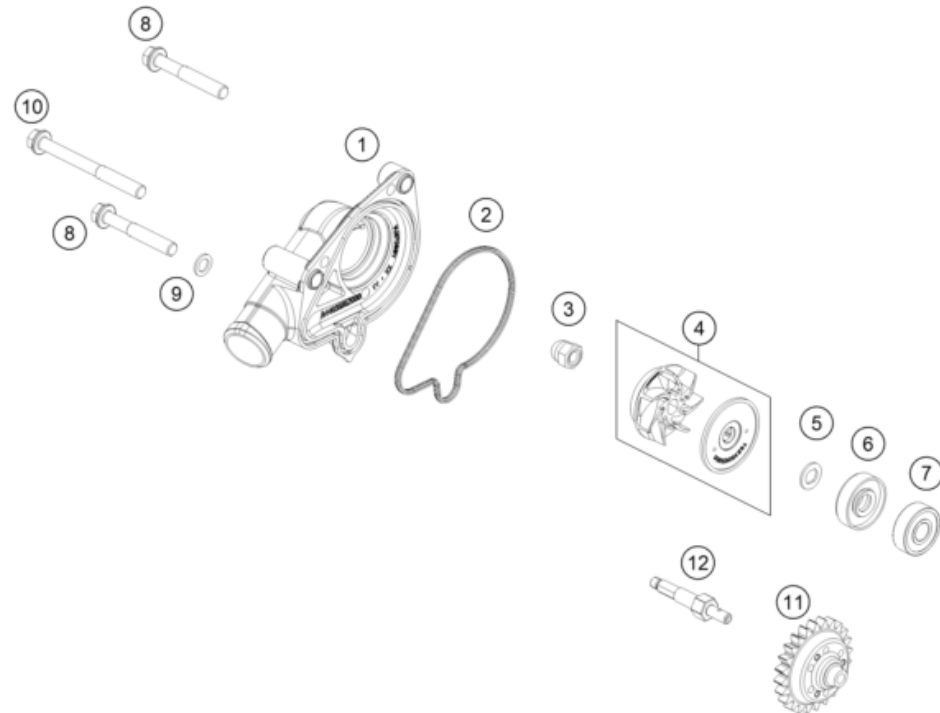

POS	PARTNUMBER		PIECE
1	A44035052000	Water pump cover	1
2	A44035052010	Water pump cover seal	1
3	61230045000	CAP NUT M6 STAINLESS STEEL	1
4	79235055044	WATER PUMP WHEEL CPL.	1
5	50435049000	PREFORMED WASHER	1
6	0760082472	SHAFT SEAL RING 8X24X7 A DUO	1
7	0625006087	Grooved ball bearing 608 2RS C3	1
8	0025060406	HH collar screw M6x40 TX30	2
9	0603061001	CU-seal ring DIN7603-6X10X1	1
10	0025060606	HH collar screw M6x60 TX30	1
11	A44035062024	Drive gear wheel	1
12	A44035054000	Water pump shaft	1

23A4603511

60439

* NEW PART

X ON DEMAND

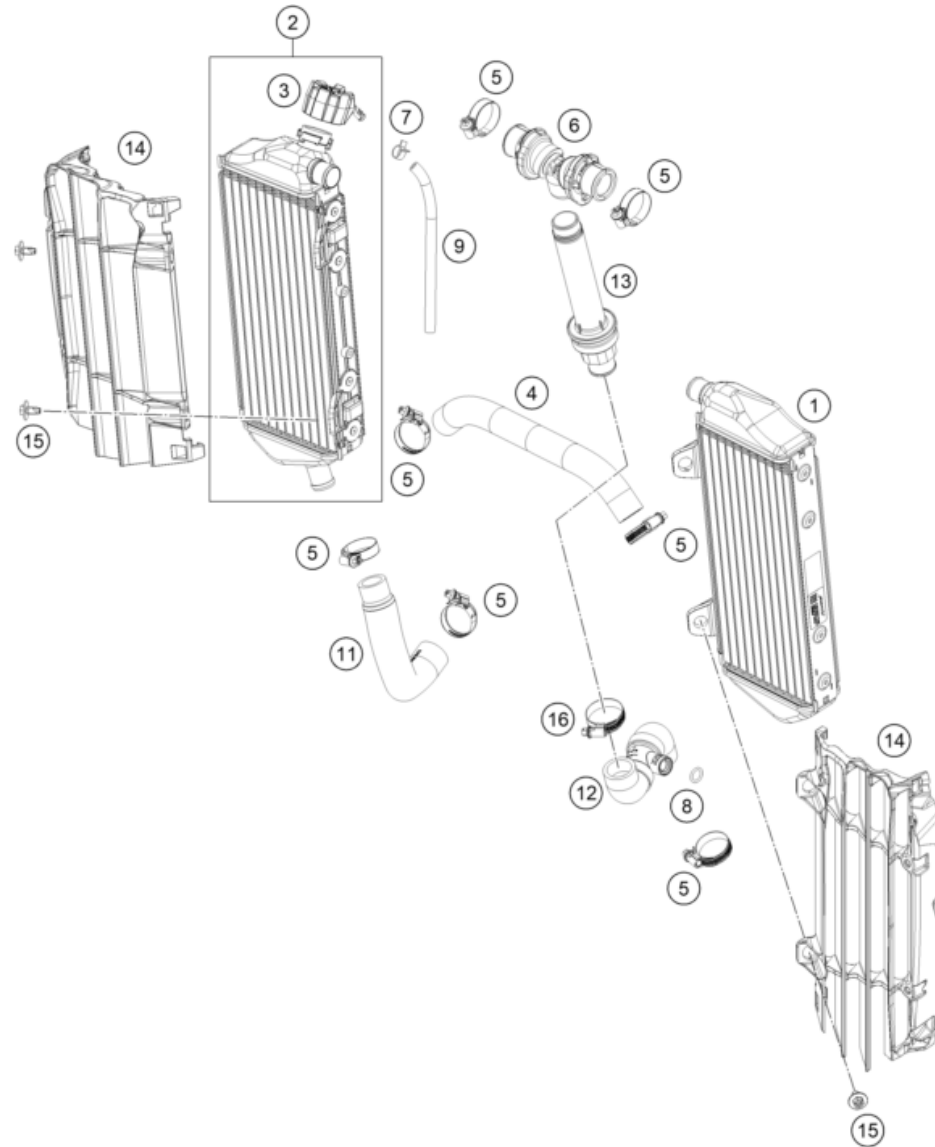

POS	PARTNUMBER		PIECE
1	A46035007000	Radiator left	1
2	A46035008100	Right radiator	1
3	72035016000	RADIATOR CAP 1,8 BAR	1
4	A46035025000	Pre-formed hose radiator left/right	1
5	0310000902900	Hose clip 18-29	7
6	A46035071044	Y-piece compl.	1
7	59007017000	CLAMP YDNAC 10096F (9,6MM)	1
8	0770100020	o-ring 10.00x2.00 silicone	1
9	50335030001	PVC-hose 6X9	x
11	A44035024000	Pre-formed hose engine/radiator right	1
12	A44035020044	Hose system, temperature sensor 250/300	1
13	A44035073033	Threaded bushing w. thermo.	1
14	A46035036044C1	Radiator protection set, black	1
15	0900000601203	HH ISR collar screw M6x12-10.9 ISA30	4
16	0310000903200	Hose clip 20-32	1

23A4603530

79225

* NEW PART

X ON DEMAND

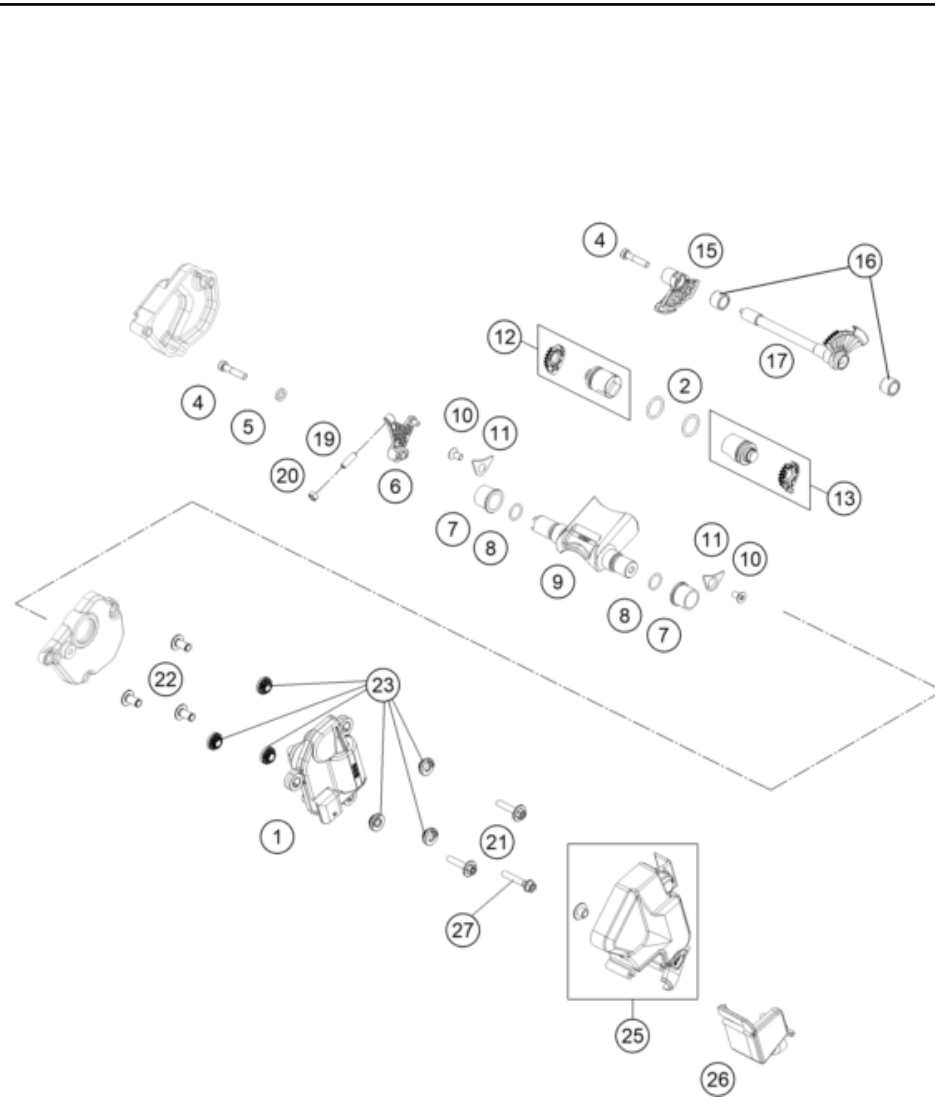

POS	PARTNUMBER		PIECE
1	A45041072033	Exhaust control actuator cpl.	1
2	0770160021	O-ring 16X2 VITON 75	2
4	0012050253S	Bolt DIN 6912 - M5x25 SS	2
5	50233041000	Pair of washers M6 NORDLOCK	1
6	A44037380000	control flap lever	1
7	50437023100	exhaust flap bushing	2
8	07700120151	O-ring 12x1.5 FPM75	2
9	A44037220000	control flap 250 raw part	1
10	0019050106S	hex lobe countersunc screw M5x10 - 10.9	2
11	75030085000	RETAINING PLATE F. CS BEARING	2
12	A44037362044	Power valve right cpl.	1
13	A44037361044	Power valve left cpl.	1
15	A44037365000	controlgate right	1
16	0618101410	needle sleeve HK 1010 10x14x10	2
17	A44037070033	Idler shaft cpl.	1
19	0913050160	Grub screw M5x16 with AH	1
20	0934050040	Nut M5 SW7	1
21	0000240502500S	HH collar screw, M5x25, ISA 30	2
22	A45041072010	Actuator bushing	3
23	A45041072005	Damper actuator	6
25	A42037096000	Actuator protection cap	1
26	A42037096020	Actuator protection cap	1
27	0025050306	HH COLLAR SCREW M5X30 TX30	1

23A4403710

79226

* NEW PART

X ON DEMAND

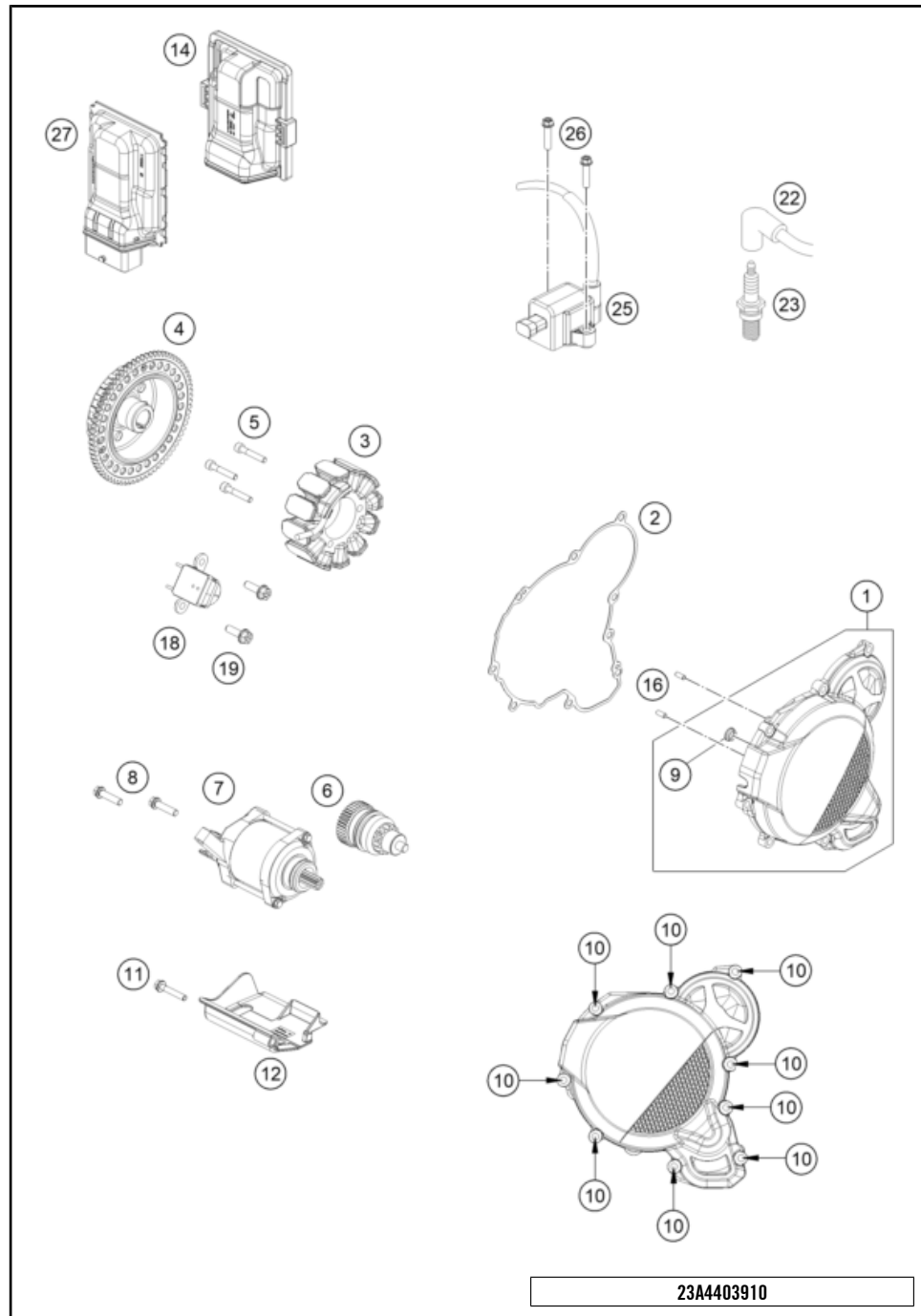

POS	PARTNUMBER		PIECE
1	A44030002044C1	Ignition cover cpl.	1
2	A44030040000	Ignition cover gasket	1
3	A44039404100	Stator	1
4	A44039405000	Rotor	1
5	0012050253S	Bolt DIN 6912 - M5x25 SS	3
6	55440126000	BENDIX	1
7	A44040201000	Starter motor	1
8	0025060256	HH collar screw M6x25 TX30	2
9	55540031000	Collar bushing	1
10	0025060206	HH collar screw M6x20 TX30	9
11	0025060306	HH collar screw M6x30 TX30	1
12	A44040040000	Starter motor cover	1
14	A45041031050	Engine control unit rubber	1
16	0402040980	Needle roll.DIN5402 NRB 4X9.8	2
18	55539034000	Pulse generator cmpl.	1
19	0014050163S	Hex collar screw M 5x16 SW=6	2
22	A44039007100	Ignition cable	1
23	A44039093000	Spark plug	1
25	55639006000	Ignition coil	1
26	0025060256	HH collar screw M6x25 TX30	2
27	A45041031000	Engine control unit	1

79227

* NEW PART

X ON DEMAND

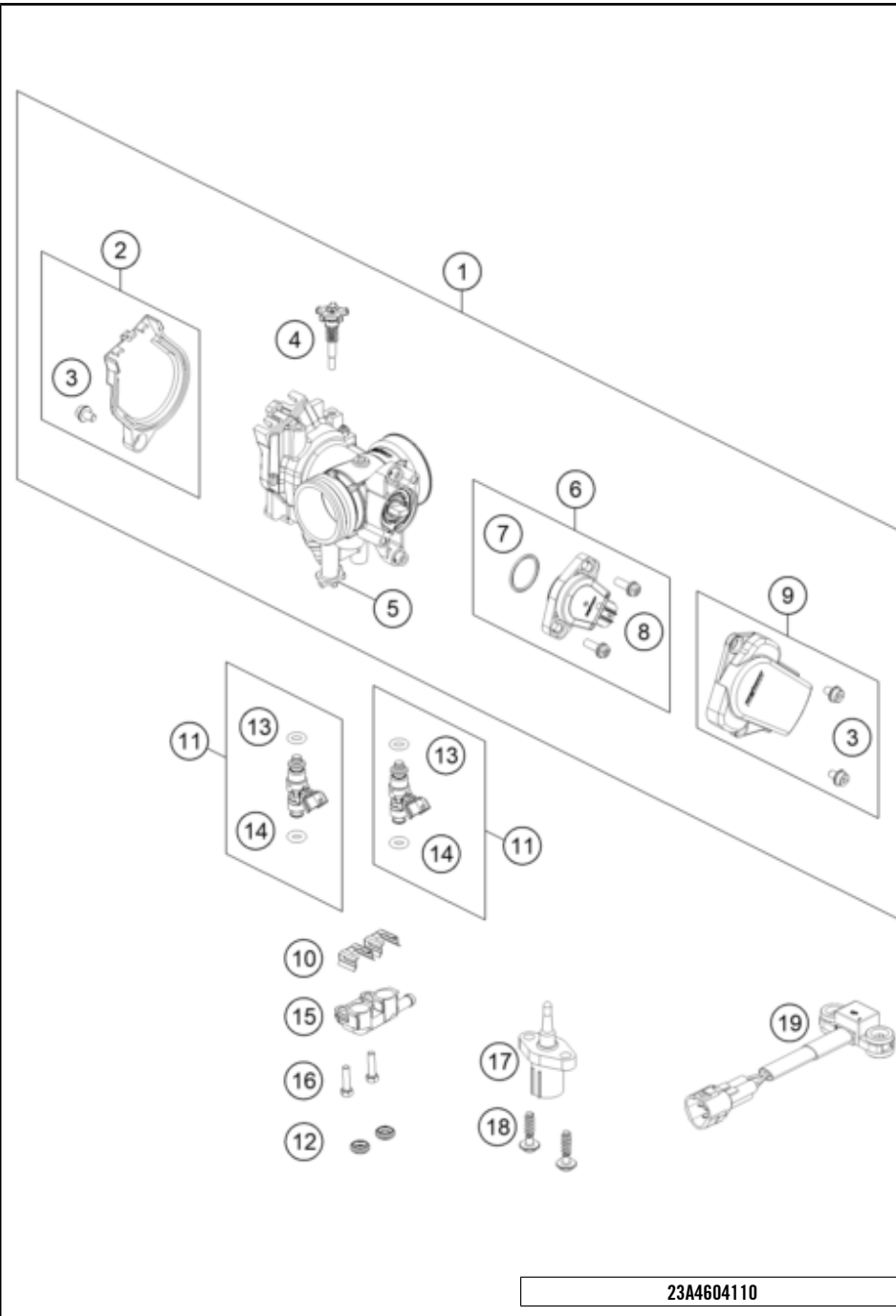

POS	PARTNUMBER		PIECE
1	A44041101000	Throttle body	1
2	79141056044	DKK Cover cpl.	1
3	79041056020	SPECIAL SCREW	3
4	A44041060044	STOP SCREW SET	1
5	79041070000	STARTER VALVE CPL.	1
6	79041077044	TPS CPL.	1
7	75041077110	O-RING	1
8	61041077020	SCREW THROTTLE POS. SENSOR	2
9	79141078044	TPS Cover cpl.	1
10	55441017000	Injector clip	2
11	A45041023044	Injector fuel rail	2
12	55441024000	Protective ring	2
13	55641023020	O-ring	2
14	55641023010	O-ring	2
15	A42041006000	Fuel manifold	1
16	0025050166	HH collar screw M5x16 TX30	2
17	61041080000	Ambient-air temperature sensor	1
18	0081050181	SCREW FOR PLASTIC K50X18 T20	2
19	A46041088000	Roll-over sensor	1

23A4604110

63970

* NEW PART

X ON DEMAND

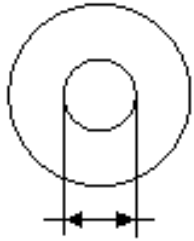

- ⑤ Ø 5 mm
- ⑥ Ø 6 mm
- ⑧ Ø 8 mm
- ⑩ Ø 10 mm
- ⑫ Ø 12 mm
- ⑭ Ø 14-14,5 mm
- ⑯ Ø 16 mm
- ⑳ Ø 20 mm
- ㉑ Ø 21 mm
- ㉒ Ø 22 mm
- ㉓ Ø 23 mm
- ㉔ Ø 24,5 mm
- ㉘ Ø 28,25-28,5 mm
- ㉚ Ø 32 mm
- ㉜ Ø 52 mm

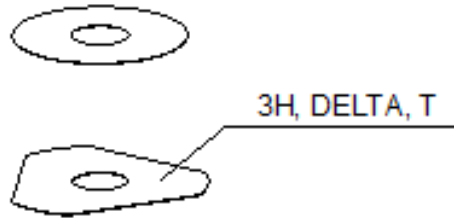

POS	PARTNUMBER		PIECE
1	48600611	Spring (10,2) l5 check valve	X
5	44906890	Washer 5X15X2	X
6	40540400	Shim 6x12x0,10	X
6	40540401	Shim 6x14x0,10	X
6	40540402	Shim 6x16x0,10	X
6	40540403	Shim 6x18x0,10	X
6	40540404	Shim 6x12x0,15	X
6	40540405	Shim 6x14x0,15	X
6	40540406	Shim 6x16x0,15	X
6	40540407	SHIM 6X18X0,15	X
6	40540408	Shim 6x12x0,20	X
6	40540409	Shim 6x14x0,20	X
6	40540410	Shim 6x16x0,20	X
6	40540411	Shim 6x18x0,20	X
6	48600095	SHIM 6X20X0,20	X
6	40540412	Shim 6x12x0,25	X
6	40540413	Shim 6x14x0,25	X
6	40540414	Shim 6x16x0,25	X
6	40540415	Shim 6x18x0,25	X
6	40540417	SHIM 6X8,5X0,10	X
6	40540418	SHIM 6X9X0,10	X
6	40540419	SHIM 6X9,5X0,10	X
6	40540423	SHIM 6X9,5X0,15	X
6	40540425	SHIM 6X8,5X0,20	X
6	40540426	SHIM 6X9X0,20	X
6	40540427	SHIM 6X9,5X0,20	X
6	40540447	Shim 6x10x0,30	X
6	40540449	Shim 6x9x0,30	X
6	40540450	Shim 6x9,5x0,30	X
6	40540494	Shim 6x18x0,40	X
6	40540774	Shim 6x18x0,10 delta	X
6	40541383	Shim 6X11X0,10	X
6	40541391	Shim 6x11x0,30	X
6	40541402	Shim 6x11x0,20	X
6	40541403	SHIM 6X10X0,20	X
6	40541404	Shim 6x10x0,10	X
6	40541405	Shim 6x10x0,15	X
6	40541406	SHIM 6X11X0,15	X

080000190

4668

* NEW PART

X ON DEMAND

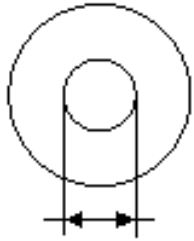

5 Ø 5 mm

6 Ø 6 mm

8 Ø 8 mm

10 Ø 10 mm

12 Ø 12 mm

14 Ø 14-14,5 mm

16 Ø 16 mm

20 Ø 20 mm

21 Ø 21 mm

22 Ø 22 mm

23 Ø 23 mm

24 Ø 24,5 mm

28 Ø 28,25-28,5 mm

32 Ø 32 mm

52 Ø 52 mm

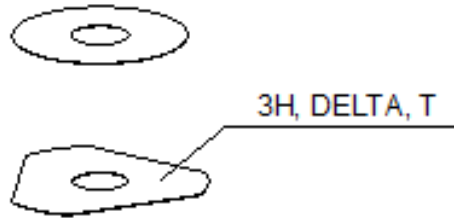

3H, DELTA, T

POS	PARTNUMBER		PIECE
6	40541408	SHIM 6X8,0X0,30	X
6	40541414	Shim 6x8x0,1	X
6	40541416	SHIM 6X8X0,3	X
6	40541417	SHIM 6X11X0,25	X
6	48600102	SHIM 6X24X0,25	X
6	48600063	Shim 6x24x0,10	X
6	48600064	Shim 6x22x0,10	X
6	48600065	Shim 6x20x0,10	X
6	48600069	Shim 6x20x0,15	X
6	48600100	Shim 6x24x0,15	X
6	48600116	Shim 6x24x0,10 delta	X
6	48600139	Shim 6x22x0,1 delta	X
6	48600217	Shim 6x10x0,25	X
6	48600325	Shim 6x13x0,10	X
6	48600327	SHIM 6X15X0,1	X
6	48600329	Shim 6x17x0,10	X
6	48600331	Shim 6x19x0,10	X
6	48600096	Shim 6x20x0,25	X
6	48600097	Shim 6x22x0,15	X
6	48600099	Shim 6x22x0,25	X
6	40540448	Shim 6x8,5x0,30	X
6	48600479	Shim 6x20x0,10 DELTA	X
6	48600332	SHIM 6X21X0,1	X
6	48600333	SHIM 6X23X0,1	X
6	40541393	Shim 6x12x0,30	X
6	48600330	SHIM 6X17X0,15	X
6	48600988	Shim 6x28x0,10	X
6	48600989	Shim 6x26x0,10	X
6	48601091	Shim 6x28x0,15	X
6	48601093	Shim 6x26x0,15	X
6	48600328	Shim 6x15x0,15	X
6	48600326	Shim 6x13x0,15	X
6	48601548	Shim 6x17x1,5	X
6	48601693	Washer 6x18x3	X
6	48600098	Shim 6x22x0,20	X
6	48601300	Washer 6x25x1,5	X
6	48601692	Shim 6x30x0,15	X
6	48601550	Shim 6x30x0,10	X

080000190

4668

* NEW PART

X ON DEMAND

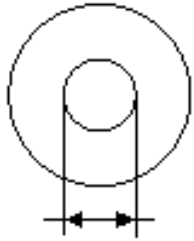

5 Ø 5 mm

6 Ø 6 mm

8 Ø 8 mm

10 Ø 10 mm

12 Ø 12 mm

14 Ø 14-14,5 mm

16 Ø 16 mm

20 Ø 20 mm

21 Ø 21 mm

22 Ø 22 mm

23 Ø 23 mm

24 Ø 24,5 mm

28 Ø 28,25-28,5 mm

32 Ø 32 mm

52 Ø 52 mm

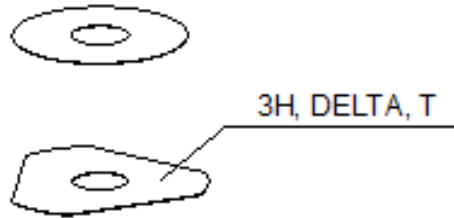

POS	PARTNUMBER		PIECE
6	40541392	Shim 6x8x0,2	X
6	48601917	Washer 6x25x4	X
6	48601916	Washer 6x18x4	X
6	40540399	Shim 6x16x0,30	X
6	48601584	Spring shim 6x30x0.4	X
6	48601459	Washer check valve 6x31x0,4	X
6	48601849	Check valve plate 2,5mm hub	X
6	48600101	SHIM 6X24X0,20	X
6	48601094	Shim 6x26x0,20	X
6	40540422	Shim 6X9X0,15	X
6	48601841	Washer check valve 6x31x0,4	X
6	48601850	Shim 6x30x0,4 spring shim	X
6	48601092	Shim 6x28x0,20	X
6	48601264	Shim 6x25x0,10	X
6	48600967	Shim 6x20x0,2 DELTA	X
6	48601847	Washer 6x25x1,5	X
6	48601707	Sinus shim plate 6X30	X
6	S64060000400000	Shim 6x14x0.3	X
6	S64060000500000	Shim 6x13x0.25	X
6	S64060000600000	Shim 6x17x0,2	X
6	40540421	Shim 6x8.5x0.15	X
6	48601262	Washer 6x18x1,5	X
6	S64060001500000	Shim 6x8x0.15	X
8	40540477	Shim 8x18x0,40	X
8	43570120	Shim 8x18x0,10	X
8	44916098	washer 8,4X16X0,8	X
8	44916130	washer 8,2X15X1	X
8	44916180	Washer 8.2X11X1	X
8	48600214	Shim 8x16x0,10	X
8	48600385	SHIM 8x14x0.25	X
8	48600346	Shim 8x11x0,20	X
8	48600215	Shim 8x20x0,10	X
8	48600485	washer 8X10X0,10	X
8	48601402	SHIM 8X13X0,10	X
8	48600350	Shim 8x16x0,15	X
8	48600061	Shim 8x24x0,40	X
8	48600062	CHECK VALVE 8X24X0,1	X
8	48600216	Shim 8x22x0,10	X

080000190

4668

* NEW PART

X ON DEMAND

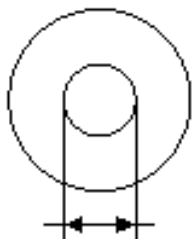

- 5 Ø 5 mm
- 6 Ø 6 mm
- 8 Ø 8 mm
- 10 Ø 10 mm
- 12 Ø 12 mm
- 14 Ø 14-14,5 mm
- 16 Ø 16 mm
- 20 Ø 20 mm
- 21 Ø 21 mm
- 22 Ø 22 mm
- 23 Ø 23 mm
- 24 Ø 24,5 mm
- 28 Ø 28,25-28,5 mm
- 32 Ø 32 mm
- 52 Ø 52 mm

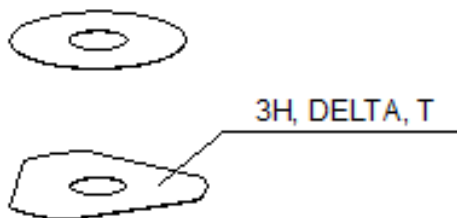

POS	PARTNUMBER		PIECE
8	48600480	Shim 8x10x0,20	X
8	48600555	SHIM 8X16X0,20	X
8	48600213	SHIM 8X14X0,10	X
8	48600357	Shim 8x11x0,10	X
8	48600351	Shim 8x12x0,10	X
8	48600607	Shim 8x20x0,40	X
8	48601095	Shim 8x17x0,10	X
8	48600352	check valve 8X11X0,4	X
8	48601860	Washer 8x11x0,15	X
8	48601266	Shim 8x26x0,40	X
8	46180640	Shim 8x16x0,3	X
8	43578166	Washer 8x20x1	X
8	48601113	Shim 8x15x0,1	X
8	48600218	Shim 8X11X0,40	X
8	48600964	Shim 8x20x0,15	X
8	89080008	Shim 8x30x0,10	X
8	48601859	Shim 8x10x0,15	X
8	48601863	Shim 8x14x0,15	X
8	89080001	Shim 8x18x0,15	X
8	89080002	Shim 8x22x0,15	X
8	89080003	Shim 8x24x0,15	X
8	89080005	Shim 8x26x0,15	X
8	89080007	Shim 8x28x0,15	X
8	89080009	Shim 8x30x0,15	X
8	48600386	Shim 8X12X0,25	X
8	48601862	Shim 8x13x0,15	X
8	89080004	Shim 8x26x0,10	X
8	89080006	Shim 8x28x0,10	X
8	S64080000000000	Shim 8x24x0,2	X
8	48601864	Shim 8x15x0,15	X
8	48600965	SHIM 8X20X0,2	X
8	S64080000300000	Shim 8x18x0,2	X
8	S64080000100000	Shim 8x12x0,2	X
8	S64080000900000	shim 8x14x0,2	X
8	S64080000100000	Shim 8x12x0,2	X
8	S64080000400000	Shim 8x22x0,2	X
8	48600384	Shim 8x22x0,30	X
8	S25080000300000	Trägerscheibe Sinus Shim 8x30	X

080000190

4668

* NEW PART

X ON DEMAND

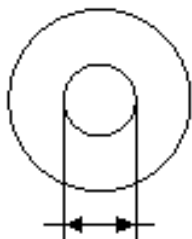

5 Ø 5 mm

6 Ø 6 mm

8 Ø 8 mm

10 Ø 10 mm

12 Ø 12 mm

14 Ø 14-14,5 mm

16 Ø 16 mm

20 Ø 20 mm

21 Ø 21 mm

22 Ø 22 mm

23 Ø 23 mm

24 Ø 24,5 mm

28 Ø 28,25-28,5 mm

32 Ø 32 mm

52 Ø 52 mm



3H, DELTA, T

POS	PARTNUMBER		PIECE
8	S25080000500000	Scheibe 8x25x2,5	X
10	36120284	SHIM 10X16X0,10	X
10	36120298	SHIM 10X16X0,2	X
10	36120312	SHIM 10X16X0,30	X
10	36120314	SHIM 10X18X0,30	X
10	36120325	SHIM 10X19X0,15	X
10	36120327	SHIM 10X23X0,15	X
10	36120328	SHIM 10X25X0,15	X
10	36120329	SHIM 10X27X0,15	X
10	36120330	SHIM 10X29X0,15	X
10	36120331	SHIM 10X31X0,15	X
10	36120332	SHIM 10X33X0,15	X
10	36120334	SHIM 10X21X0,20	X
10	36120335	SHIM 10X23X0,20	X
10	36120336	SHIM 10X25X0,20	X
10	36120337	SHIM 10X27X0,20	X
10	36120338	SHIM 10X29X0,20	X
10	36120339	SHIM 10X31X0,20	X
10	36120340	SHIM 10X33X0,20	X
10	36120342	SHIM 10X21X0,25	X
10	36120343	SHIM 10X23X0,25	X
10	36120344	SHIM 10X25X0,25	X
10	36120345	SHIM 10X27X0,25	X
10	36120349	SHIM 10X19X0,30	X
10	36120350	SHIM 10X21X0,30	X
10	36120313	SHIM 10X17X0,30	X
10	36120354	SHIM 10X29X0,30	X
10	40140275	WASHER 10X35X0,15	X
10	48601708	Shim 10x30x0,40	X
10	36120346	SHIM 10X29X0,25	X
10	36120355	SHIM 10X31X0,30	X
10	36120348	SHIM 10X33X0,25	X
10	36120311	SHIM 10X15X0,30	X
10	36120292	SHIM 10X17X0,15	X
10	36120326	SHIM 10X21X0,15	X
10	36120286	SHIM 10X18X0,10	X
10	36120347	SHIM 10X31X0,25	X
10	36120333	SHIM 10X19X0,20	X

080000190

4668

* NEW PART

X ON DEMAND

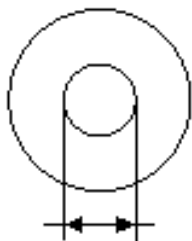

5 Ø 5 mm

6 Ø 6 mm

8 Ø 8 mm

10 Ø 10 mm

12 Ø 12 mm

14 Ø 14-14,5 mm

16 Ø 16 mm

20 Ø 20 mm

21 Ø 21 mm

22 Ø 22 mm

23 Ø 23 mm

24 Ø 24,5 mm

28 Ø 28,25-28,5 mm

32 Ø 32 mm

52 Ø 52 mm



3H, DELTA, T

POS	PARTNUMBER		PIECE
10	36120351	SHIM 10X23X0,30	X
10	36120352	SHIM 10X25X0,30	X
10	36120353	SHIM 10X27X0,30	X
10	36120356	SHIM 10X33X0,30	X
10	50180395	Washer 10x16x1	X
10	36120291	SHIM 10X16X0,15	X
10	36120308	Shim 10x13x0,30	X
10	36120604	Washer 10x22x2,5	X
10	36120299	SHIM 10X17X0,20	X
12	46810605	SHIM 12X21X0,10	X
12	46810490	SHIM 12X24X0,20	X
12	46810491	Shim 12x26x0,20	X
12	46810492	Shim 12x28x0,20	X
12	46810493	SHIM 12X30X0,20	X
12	46810494	Shim 12x32x0,20	X
12	46810495	Shim 12x34x0,20	X
12	46810496	SHIM 12X36X0,20	X
12	46810497	SHIM 12X38X0,20	X
12	46810498	Shim 12x40x0,20	X
12	46810499	Shim 12x24x0,25	X
12	46810500	SHIM 12X26X0,25	X
12	46810501	SHIM 12X28X0,25	X
12	46810502	Shim 12x30x0,25	X
12	46810504	SHIM 12X34X0,25	X
12	46810505	SHIM 12X36X0,25	X
12	46810507	Shim 12x40x0,25	X
12	46810508	SHIM 12X24X0,30	X
12	46810509	SHIM 12X26X0,30	X
12	46810510	SHIM 12X28X0,30	X
12	46810512	SHIM 12X32X0,30	X
12	46810513	SHIM 12X34X0,30	X
12	46810518	SHIM 12X26X0,15	X
12	46810519	SHIM 12X28X0,15	X
12	46810520	SHIM 12X30X0,15	X
12	46810521	SHIM 12X32X0,15	X
12	46810522	SHIM 12X34X0,15	X
12	46810523	SHIM 12X36X0,15	X
12	46810524	SHIM 12X38X0,15	X

080000190

4668

* NEW PART

X ON DEMAND

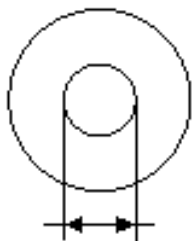

5 Ø 5 mm

6 Ø 6 mm

8 Ø 8 mm

10 Ø 10 mm

12 Ø 12 mm

14 Ø 14-14,5 mm

16 Ø 16 mm

20 Ø 20 mm

21 Ø 21 mm

22 Ø 22 mm

23 Ø 23 mm

24 Ø 24,5 mm

28 Ø 28,25-28,5 mm

32 Ø 32 mm

52 Ø 52 mm



3H, DELTA, T

POS	PARTNUMBER		PIECE
12	46810525	SHIM 12X40X0,15	X
12	46810604	SHIM 12X20X0,10	X
12	46810606	SHIM 12X22X0,10	X
12	46810607	SHIM 12X23X0,10	X
12	46810608	SHIM 12X24X0,10	X
12	46810610	Shim 12x17x0,15	X
12	46810611	SHIM 12X18X0,15	X
12	46810612	SHIM 12X19X0,15	X
12	46810615	SHIM 12X22X0,15	X
12	46810636	BACKPLATE 12X16X0,30	X
12	46810637	Shim 12x17x0,30	X
12	46810638	Shim 12x18x0,30	X
12	46810639	SHIM 12X19X0,30	X
12	46810641	Shim 12X21X0,30	X
12	46811582	Shim 12x30x0,10	X
12	46810631	SHIM 12X20X0,25	X
12	46810633	SHIM 12X22X0,25	X
12	46811580	Shim 12x32x0,10	X
12	46810503	SHIM 12X32X0,25	X
12	46810517	SHIM 12X24X0,15	X
12	46810856	Shim 12x20x0,30	X
12	46811258	Washer 12x24x2,5	X
12	46812018	Shim 12x42x0,25	X
12	46812015	Shim 12x44x0,20	X
12	46810613	SHIM 12X20X0,15	X
12	46810623	SHIM 12X21X0,20	X
12	46810624	SHIM 12X22X0,20	X
12	46810642	SHIM 12X22X0,30	X
12	46810643	SHIM 12X23X0,30	X
12	46811629	Shim 12x28x0,10	X
12	46810511	SHIM 12X30X0,30	X
12	46810514	SHIM 12X36X0,30	X
12	46810506	SHIM 12X38X0,25	X
12	46810515	SHIM 12X38X0,30	X
12	46812017	Shim 12x42x0,20	X
12	46812016	Shim 12x44x0,25	X
12	46810622	SHIM 12X20X0,20	X
12	46811635	Shim 12x26x0,10	X

080000190

4668

* NEW PART

X ON DEMAND

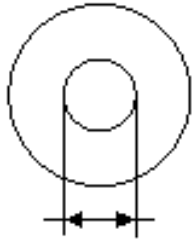

5 Ø 5 mm

6 Ø 6 mm

8 Ø 8 mm

10 Ø 10 mm

12 Ø 12 mm

14 Ø 14-14,5 mm

16 Ø 16 mm

20 Ø 20 mm

21 Ø 21 mm

22 Ø 22 mm

23 Ø 23 mm

24 Ø 24,5 mm

28 Ø 28,25-28,5 mm

32 Ø 32 mm

52 Ø 52 mm

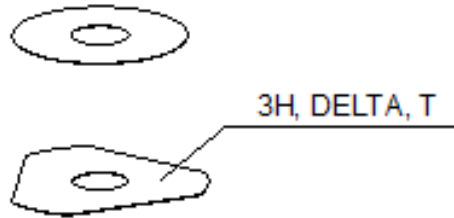

POS	PARTNUMBER		PIECE
12	50181296	Shim 12x45x0,20	X
12	46810620	Shim 12x18x0,2	X
12	46810616	Shim 12x23x0,15	X
12	46810625	SHIM 12X23X0,20	X
12	50181297	Adjustment 12x45x0,25	X
12	46810603	SHIM 12X19X0,10	X
12	46180712	SHIM 12X36X0,10	X
12	46810614	SHIM 12X21X0,15	X
12	46810628	SHIM 12X17X0,25	X
12	46810634	SHIM 12X23X0,25	X
12	S64120000000000	Shim 12x25x0.15	X
12	46810516	SHIM 12X40X0,30	X
12	S64120000800000	Shim 12x34x0,1	X
12	46810627	SHIM 12X16X0,25	X
12	46810632	SHIM 12X21X0,25	X
12	46810602	SHIM 12X18X0,10	X
14	35480479	Shim 14x26x0,40	X
14	46811046	Washer 14,5x35,4x1,25	X
16	50180023	SHIM 16X23X0,20	X
16	50180030	Shim 16x23x0,25	X
16	50180006	Shim 16x20x0,10	X
16	50180007	SHIM 16X21X0,10	X
16	50180028	SHIM 16X21X0,25	X
16	50180210	Washer 16x21x1	X
16	50180008	SHIM 16X22X0,10	X
16	50180022	Shim 16x22x0,20	X
16	50180037	SHIM 16X23X0,30	X
16	50180038	SHIM 16X24X0,30	X
16	50180032	Shim 16x25x0,25	X
16	50180039	SHIM 16X25X0,30	X
16	50180012	SHIM 16X26X0,10	X
16	50180019	SHIM 16X26X0,15	X
16	50180026	SHIM 16X26X0,20	X
16	50180040	SHIM 16X26X0,30	X
16	50180041	SHIM 16X28X0,10	X
16	50180045	Shim 16x28x0,15	X
16	50180054	Shim 16x28x0,2	X
16	50180063	SHIM 16X28X0,25	X

080000190

4668

* NEW PART

X ON DEMAND

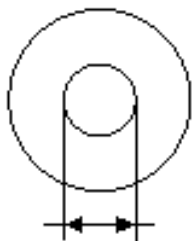

5 Ø 5 mm

6 Ø 6 mm

8 Ø 8 mm

10 Ø 10 mm

12 Ø 12 mm

14 Ø 14-14,5 mm

16 Ø 16 mm

20 Ø 20 mm

21 Ø 21 mm

22 Ø 22 mm

23 Ø 23 mm

24 Ø 24,5 mm

28 Ø 28,25-28,5 mm

32 Ø 32 mm

52 Ø 52 mm



3H, DELTA, T

POS	PARTNUMBER		PIECE
16	50180072	SHIM 16X28X0,30	X
16	50180046	SHIM 16X30X0,15	X
16	50180055	SHIM 16X30X0,20	X
16	50180064	Shim 16x30x0,25	X
16	50180073	SHIM 16X30X0,30	X
16	50180047	Shim 16X32X0,15	X
16	50180056	Shim 16x32x0,2	X
16	50180065	SHIM 16X32X0,25	X
16	50180074	SHIM 16X32X0,30	X
16	50180044	SHIM 16X34X0,10	X
16	50180048	SHIM 16X34X0,15	X
16	50180057	Shim 16x34x0,2 y5	X
16	50180066	SHIM 16X34X0,25	X
16	50180075	SHIM 16X34X0,30	X
16	50180049	Shim 16x36x0,15	X
16	50180058	Shim 16x36x0,20	X
16	50180067	SHIM 16X36X0,25	X
16	50180076	SHIM 16X36X0,30	X
16	50180050	SHIM 16X38X0,15	X
16	50180059	SHIM 16X38X0,20	X
16	50180068	SHIM 16X38X0,25	X
16	50180077	SHIM 16X38X0,30	X
16	50180051	Shim 16x40x0,15	X
16	50180060	Shim 16x40x0,2	X
16	50180069	SHIM 16X40X0,25	X
16	50180078	SHIM 16X40X0,30	X
16	50180052	SHIM 16X42X0,15	X
16	50180061	Shim 16x42x0,2	X
16	50180070	SHIM 16X42X0,25	X
16	50180079	SHIM 16X42X0,30	X
16	50180053	SHIM 16X44X0,15	X
16	50180062	Shim 16X44X0,20	X
16	50180071	SHIM 16X44X0,25	X
16	50180080	SHIM 16X44X0,30	X
16	50180177	spring washer 8,2x16x0,6	X
16	50180033	Shim 16x26x0,25	X
16	50180034	Shim 16x20x0,30	X
16	50180035	Shim 16x21x0,30	X

080000190

4668

* NEW PART

X ON DEMAND

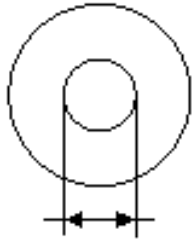

5 Ø 5 mm

6 Ø 6 mm

8 Ø 8 mm

10 Ø 10 mm

12 Ø 12 mm

14 Ø 14-14,5 mm

16 Ø 16 mm

20 Ø 20 mm

21 Ø 21 mm

22 Ø 22 mm

23 Ø 23 mm

24 Ø 24,5 mm

28 Ø 28,25-28,5 mm

32 Ø 32 mm

52 Ø 52 mm

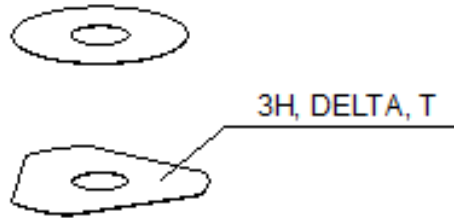

POS	PARTNUMBER		PIECE
16	50180036	Shim 16x22x0,30	X
16	50180043	SHIM 16X32X0,10	X
16	50180024	Shim 16x24x0,20	X
16	50180027	SHIM 16X20X0,25	X
16	50180031	Shim 16x24x0,25	X
16	50180029	SHIM	X
16	50180010	SHIM 16X24X0,10	X
16	50180021	SHIM 16X21X0,20	X
16	50180025	SHIM 16X25X0,20	X
16	50180383	Washer 16x19x0,3	X
16	50180014	SHIM	X
16	50180013	SHIM 16X20X0,15	X
16	50180015	DISTANCER PLATE 16X22X0,15	X
16	50180017	Shim 16x24x0,15	X
16	50180009	DISTANCER PLATE 16X23X0,10	X
16	50180016	SHIM 16X23X0,15	X
16	50180020	SHIM 16X20X0,20	X
20	48600212	pressure ring 20X16,25X0,20	X
20	50180666	SHIM 20X24X0,30	X
20	50180654	SHIM 20X36X0,20	X
20	50180655	SHIM 20X38X0,20	X
20	50180656	SHIM 20X40X0,20	X
20	50180665	SHIM 20X40X0,25	X
20	50180662	SHIM 20X34X0,25	X
20	50180657	SHIM 20X24X0,25	X
20	50180653	SHIM 20X34X0,20	X
20	50180634	RING 20X22,9X1	X
20	50180650	Shim 20x28x0,2	X
20	50180663	SHIM 20X36X0,25	X
20	50180664	SHIM 20X38X0,25	X
20	50180659	SHIM 20,2X28X0,25	X
21	50180209	Shim 21x36x0,25	X
22	50180330	Shim 18x22x0,3	X
23	50180635	SHUTTLE VALVE 23X38X0,25	X
23	50180578	SHIM D23XD16X2	X
24	40541061	Washer 24.5X34X2	X
28	36120469	SHIM 28,5X14X2	X
28	36120471	washer 28,5X14X5	X

080000190

4668

* NEW PART

X ON DEMAND

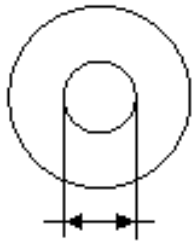

- ⑤ Ø 5 mm
- ⑥ Ø 6 mm
- ⑧ Ø 8 mm
- ⑩ Ø 10 mm
- ⑫ Ø 12 mm
- ⑭ Ø 14-14,5 mm
- ⑯ Ø 16 mm
- ⑳ Ø 20 mm
- ㉑ Ø 21 mm
- ㉒ Ø 22 mm
- ㉓ Ø 23 mm
- ㉔ Ø 24,5 mm
- ㉘ Ø 28,25-28,5 mm
- ㉚ Ø 32 mm
- ㉜ Ø 52 mm

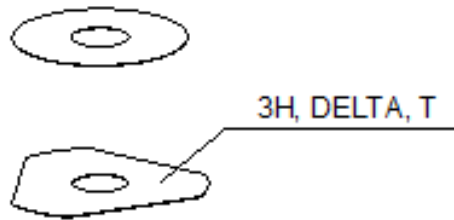

POS	PARTNUMBER		PIECE
28	89000001	Shim 28,25x34x0,30	X
28	46811636	Shim 28,25x32x0,30	X
32	48600460	washer 32X42X2,5	X
32	50600065	washer 32X45X2	X
32	46811637	Shim 32,25x36x0,30	X
52	50600002	washer 52x59x2,2	X

080000190

4668

* NEW PART

X ON DEMAND

WP Suspension GmbH
A 5230 Mattighofen, www.wp-suspension.com



083630ZEN



Art. Nr.: 083630ZEN 9. Jul 2025