

# Engine 300 EXC TPI 2019

ART.-NR.: 084688SEN

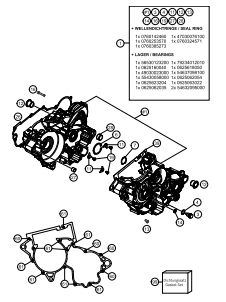

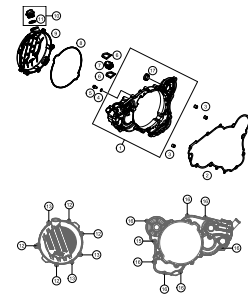
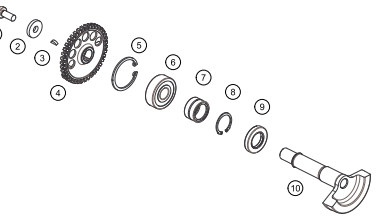
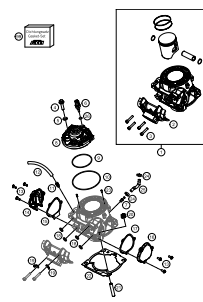
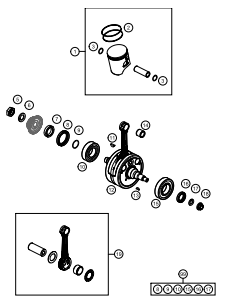
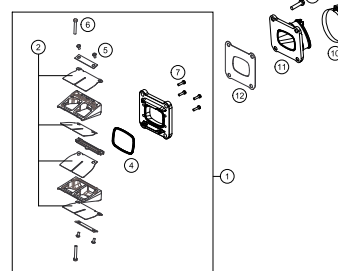
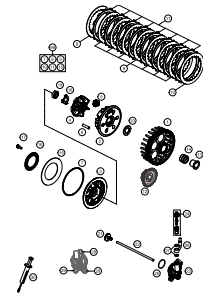
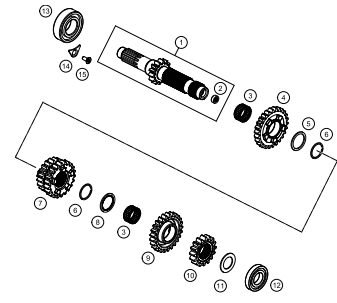
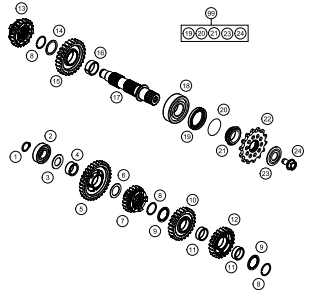
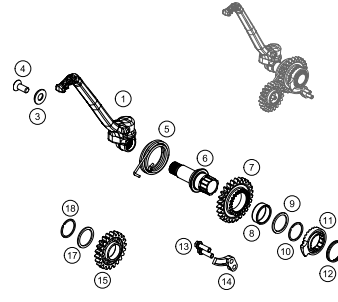
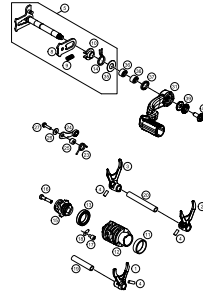
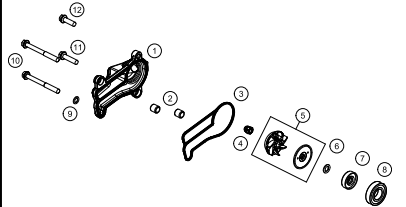

<p><b>ENGINE CASE</b></p>  <p><b>3</b></p>	<p><b>CLUTCH COVER</b></p>  <p><b>4</b></p>	<p><b>BALANCER SHAFT</b></p>  <p><b>5</b></p>	<p><b>CYLINDER, CYLINDER HEAD</b></p>  <p><b>6</b></p>
<p><b>CRANKSHAFT, PISTON</b></p>  <p><b>7</b></p>	<p><b>REED VALVE CASE</b></p>  <p><b>8</b></p>	<p><b>CLUTCH</b></p>  <p><b>9</b></p>	<p><b>TRANSMISSION I - MAIN SHAFT</b></p>  <p><b>10</b></p>
<p><b>TRANSMISSION II - COUNTERSHAFT</b></p>  <p><b>11</b></p>	<p><b>KICK STARTER</b></p>  <p><b>12</b></p>	<p><b>SHIFTING MECHANISM</b></p>  <p><b>13</b></p>	<p><b>WATER PUMP</b></p>  <p><b>14</b></p>

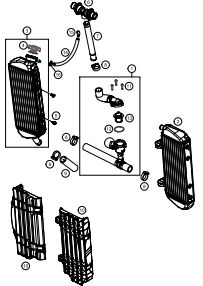
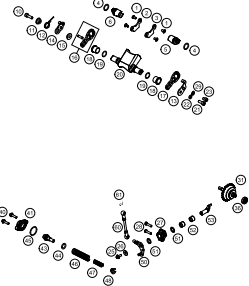
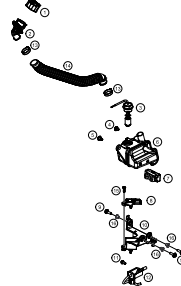
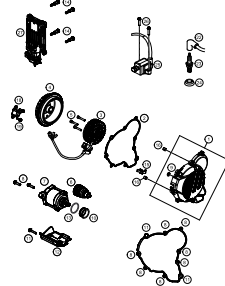
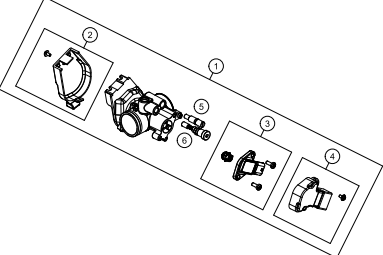
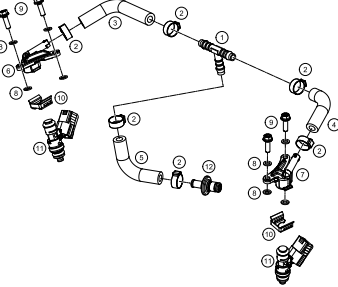
<p><b>COOLING SYSTEM</b></p>  <p style="text-align: right;"><b>15</b></p>	<p><b>EXHAUST CONTROL</b></p>  <p style="text-align: right;"><b>16</b></p>	<p><b>LUBRICATING SYSTEM</b></p>  <p style="text-align: right;"><b>18</b></p>	<p><b>IGNITION SYSTEM</b></p>  <p style="text-align: right;"><b>19</b></p>
<p><b>THROTTLE BODY</b></p>  <p style="text-align: right;"><b>20</b></p>	<p><b>FUEL DISTRIBUTOR</b></p>  <p style="text-align: right;"><b>21</b></p>		
<div style="display: flex; align-items: center;"> <div style="background-color: #cccccc; width: 50px; height: 50px; display: flex; align-items: center; justify-content: center; margin-right: 10px;"> <span style="font-size: 2em; font-weight: bold;">!</span> </div> <div> <p>All information contained is without obligation. KTM Sportmotorcycle GmbH particularly reserves the right to modify any equipment, technical specifications, prices, colors, shapes, materials, services, service work, constructions, equipment and the like so as to adapt them to local conditions or to cancel any of the above items, all without previous announcement and without giving reasons. KTM may stop manufacturing certain models without previous notice. KTM shall not be held liable for any deviations of availability and/or ability to deliver, illustrations, descriptions, printing and/or other errors. The illustrated models partly contain extra equipment, which is not applied to standard models.</p> <p>© by KTM Sportmotorcycle GmbH, Mattighofen AUSTRIA; All rights reserved; Reprint, also in extracts, with written allowance of KTM Sportmotorcycle GmbH, Mattighofen only.</p> </div> </div>			

- #1
- 3
- 4
- 11
- 12
- 13
- 14
- 16
- 19
- 27
- 28

**+ WELLENDICHTRINGE / SEAL RING**

- 1x 0760142460    1x 47030076100
- 1x 0760253570    1x 0760324571
- 1x 0760385273

**+ LAGER / BEARINGS**

- 1x 56530123200    1x 79234012010
- 1x 0625160040    1x 0625618050
- 1x 49030023000    1x 54637098100
- 1x 55430058000    1x 0625062054
- 1x 0625623204    1x 0625063022
- 1x 0625062035    2x 54632095000

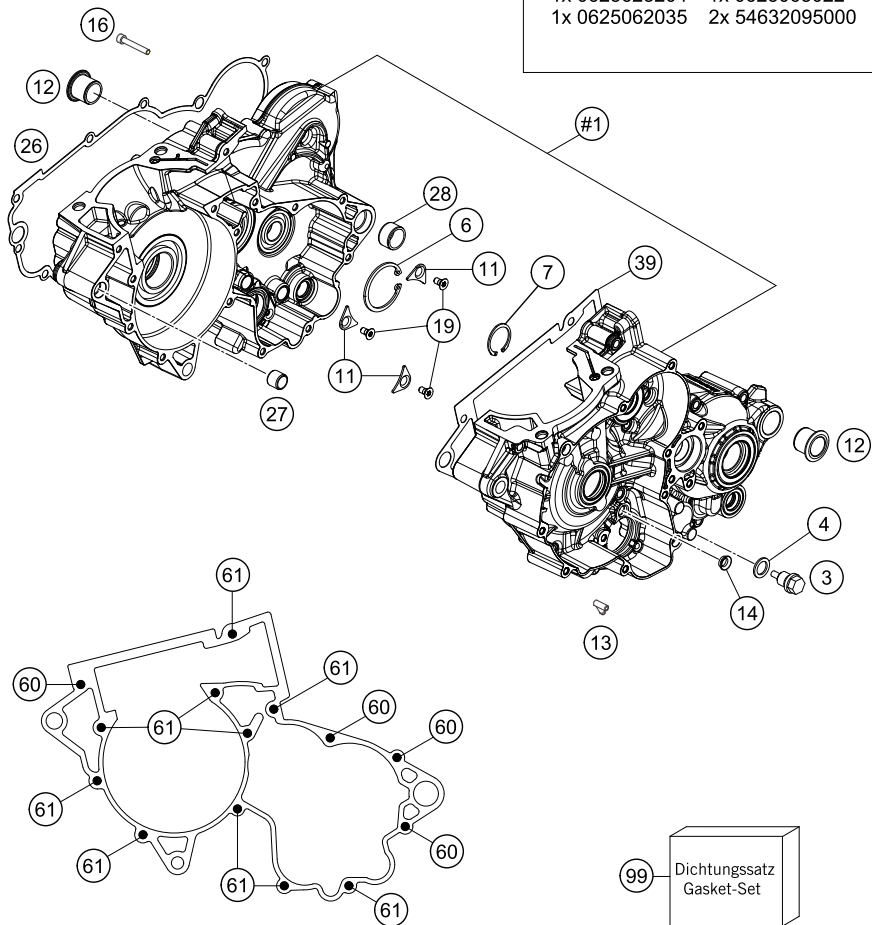

185543010

POS	PARTNUMBER	PARTNAME	PIECE
1*	55430200233	Crankcase, ready for installation	1
3	58030021000	OILDRAIN PLUG W.MAG. M 12X1,5	1
4	58038022000	CU-SEAL RING DIN7603-12X18X1,5	1
6	0472042175	CIRCLIP DIN0472-42X1,75	1
7	55430059100	CIRCLIP DIN0472-28X1,2	1
11	75030085000	RETAINING PLATE F. CS BEARING	3
12	75030010100	CASE BUSH	2
13	45130022000	ANGLE PIECE 50CCM LC 2001	1
14*	55540031000	Collar bushing	1
16	0912060406	AH SCREW DIN0912 M 6X40	1
19	0019050106S	hex lobe countersunc screw M5x10 - 10.9	3
26	55430025100	CLUTCH COVER GASKET INSIDE	1
27	54630027000	DOWEL BUSHING 13,8X11X12	1
28	54830027000	DOWEL 21X12 03	1
39	55430039000	ENGINE CASE GASKET	1
60	0025060606	HH collar screw M6x60 TX30	4
61	0025060456	HH COLLAR SCREW M6X45 TX30	10
99	55430199000	GASKET SET 250 EXC/SX 17	x

50606

\* NEW PART

X ON DEMAND

# CLUTCH COVER

Engine 300 EXC TPI 2019

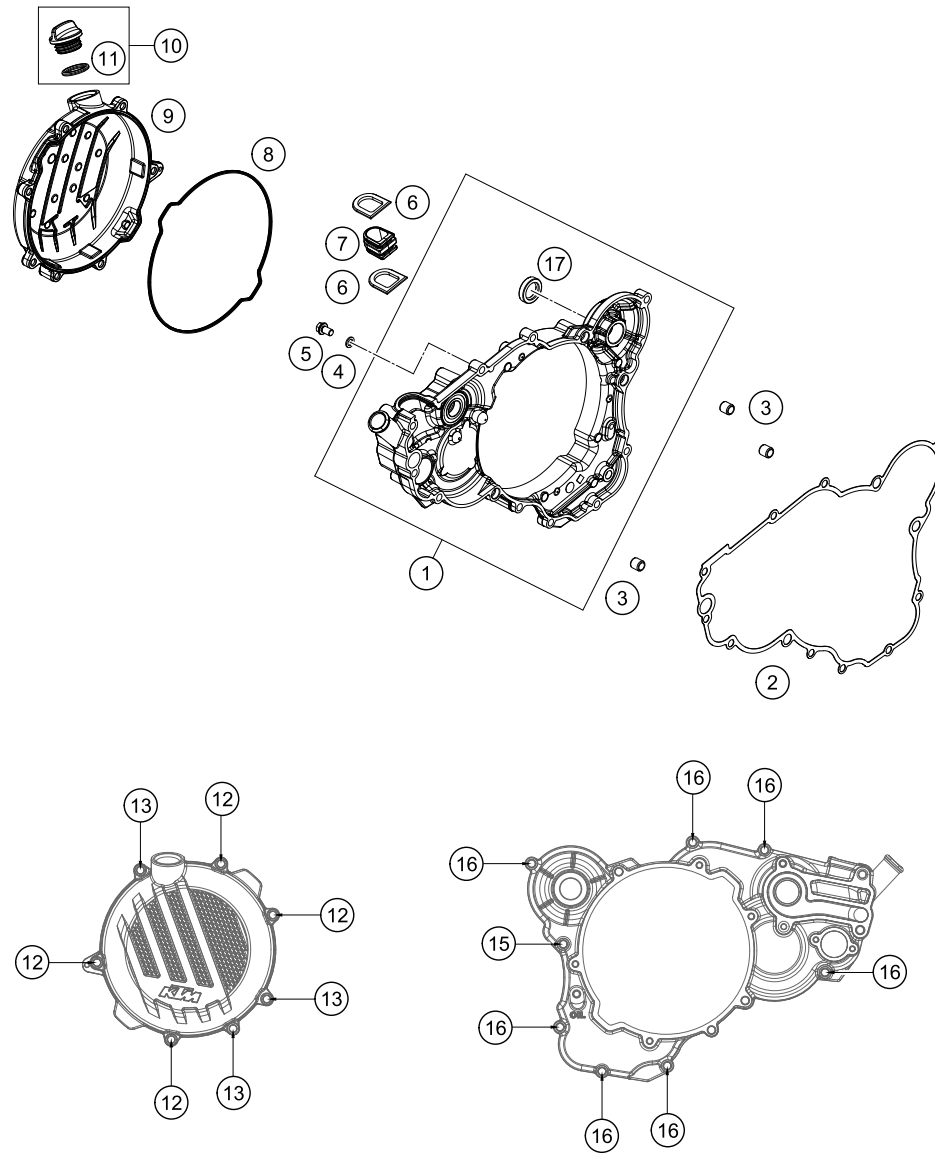

POS	PARTNUMBER	PARTNAME	PIECE
1	55430001144	Inner clutch cover cpl. 2018	1
2	55430025100	CLUTCH COVER GASKET INSIDE	1
3	49030090100	DOWEL 9,8 X7X10	3
4	0603061001	CU-SEAL RING DIN7603-6X10X1	1
5	0025060106	HH collar screw M6x10 TX30	1
6	54637107000	SEALING ELEMENT BOTTOM	2
7	54837091100	SEALING CARRIER 07	1
8	55430027000	CLUTCH COVER GASKET OUTSIDE	1
9	5543002610015	Clutch cover	1
10	79430020033	OIL FILLER CAP M24x3 WITH O-R	1
11	0770191015	O-RING 19,00X3,00 NBR	1
12	0025060206	HH collar screw M6x20 TX30	4
13	0025060606	HH collar screw M6x60 TX30	3
15	0025060306	HH collar screw M6x30 TX30	1
16	0025060256	HH collar screw M6x25 TX30	7
17	0760193070	SHAFT SEAL RING 19X30X7 B	1

185543021

49343

\* NEW PART

X ON DEMAND

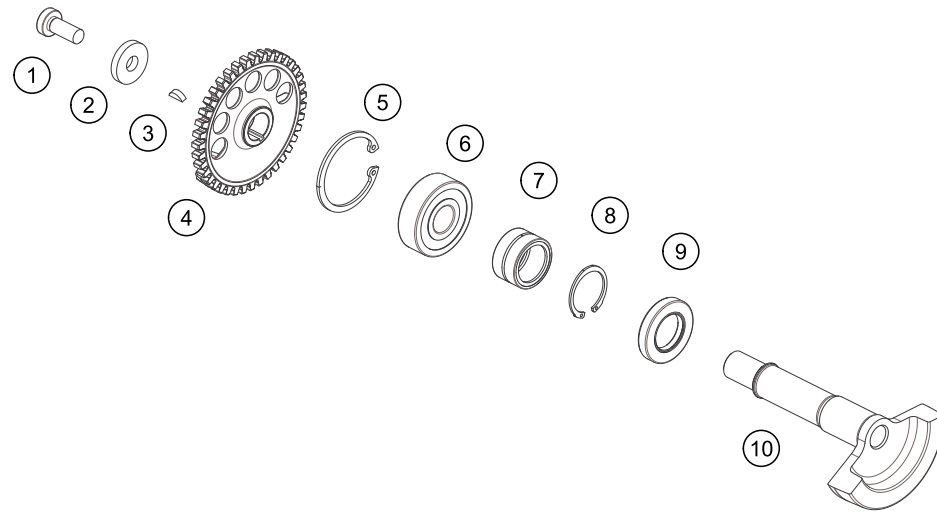

POS	PARTNUMBER	PARTNAME	PIECE
1	0035080206S	SHCS M8x20 TX45	1
2	0340084234	WASHER DIN 6340 8,4X23X4	1
3	0888030037	WOODRUFF KEY DIN6888-3X3,7	1
4	55430056000	AGW-GEAR WHEEL	1
5	0472042175	CIRCLIP DIN0472-42X1,75	1
6	0625063022	GROOVED BALL BEARING 6302 C3	1
7	55430058000	NEEDLE BEARING NK20X16XL	1
8	55430059100	CIRCLIP DIN0472-28X1,2	1
9	47030076100	SEAL SHAFT RING 20X35X6 BTSL	1
10	55430057100	BALANCER SHAFT	1

175543030

18075

\* NEW PART

X ON DEMAND

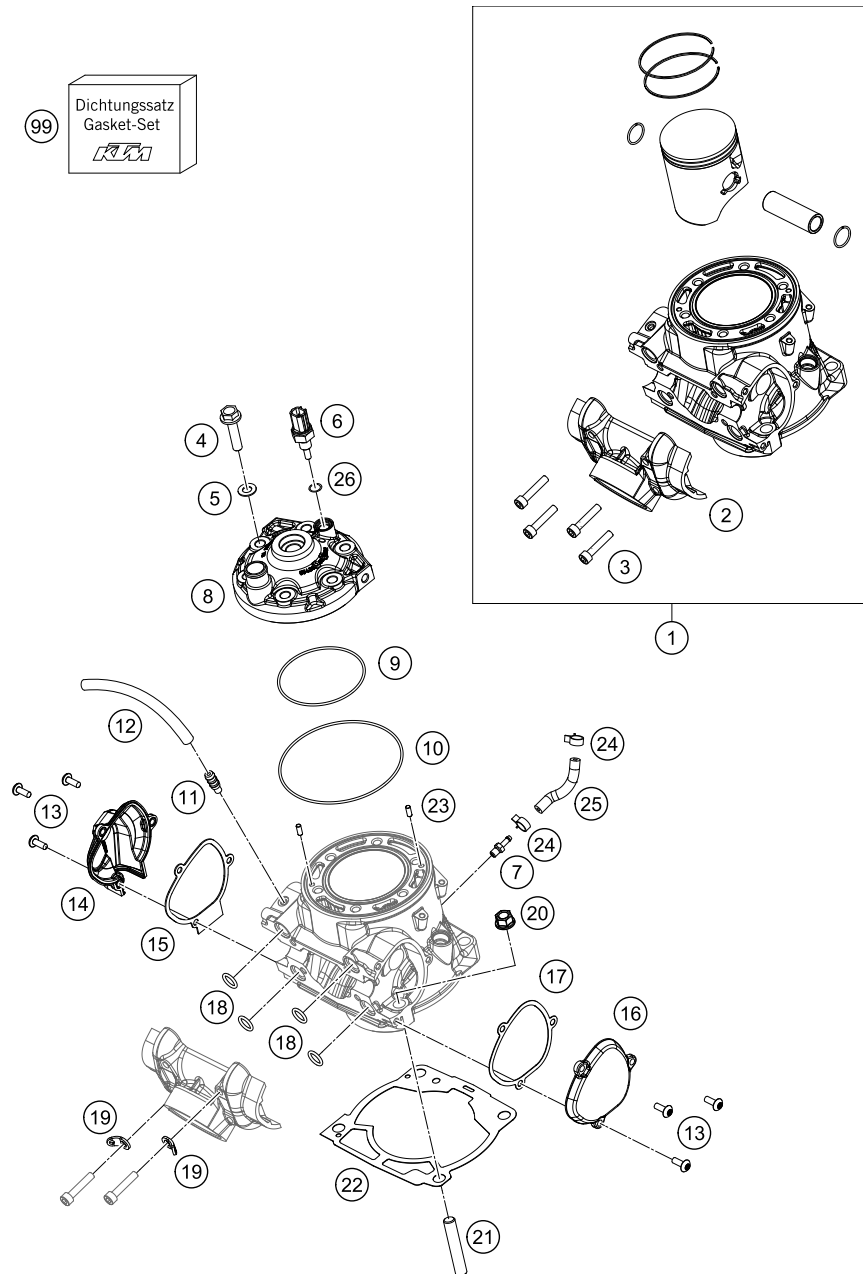

185543050

POS	PARTNUMBER	PARTNAME	PIECE
1	55630038100	Cylinder + Piston cpl. 18	1
2	55437001000	Connection Flange	1
3	0912060353	AH SCREW DIN0912-M 6X35	4
4	54830079000	COLLAR SCREW M 8X35 WS=13	6
5	56530080000	CU-SEAL RING 8 X 16 X 1	6
6	79435047000	water temperature sensor	1
7	55430023000	Vacuum connection	1
8*	55630106100	Cylinder head KTM 300 EXC	1
9	0770078020	O-RING 78,00X2,00 VIT. BLACK	1
10	0770105020	O-ring 105x2	1
11	58336020090	VACUUM CONNECTION M 6X1	1
12	78015019001	HOSE EPA D=6/10 PER METER	1
13	58605083014	SCREW M5X14 TORX 25 07	6
14*	5483700710015	exhaust control cover rh	1
15	54837008000	GASKET FOR CONTROL COVER R/S	1
16	5483700500015	CONTROL COVER L/S 09	1
17	54837006000	GASKET FOR CONTROL COVER L/S	1
18	0770116241	O-RING 11,3 X2,4 SILICON	4
19	51005074000	RETAINING PLATE	2
20	54630044000	COLLAR NUT M10 WS=13	4
21	0835100351S	STUD SCREW DIN0835-M10X35	4
22	55430030025	CYLINDER BASE GASKET	x
22	55430030020	CYLINDER BASE GASKET	x
22	55430030040	CYLINDER BASE GASKET	x
22	55430030050	CYLINDER BASE GASKET	x
22	55430030075	CYLINDER FOOT GASKET	x
23	0402040980	NEEDLE ROL.DIN5402 NRB 4X9,8	2
24	59007017000	CLAMP YDNAC 10096F (9,6MM)	2
25	61041095075	tube 3,2x9.0 L=75mm	1
26	0770100020	o-ring 10.00x2.00 silicone	1
99	55430097000	Gasket set piston 250/300	x

50659

\* NEW PART

X ON DEMAND



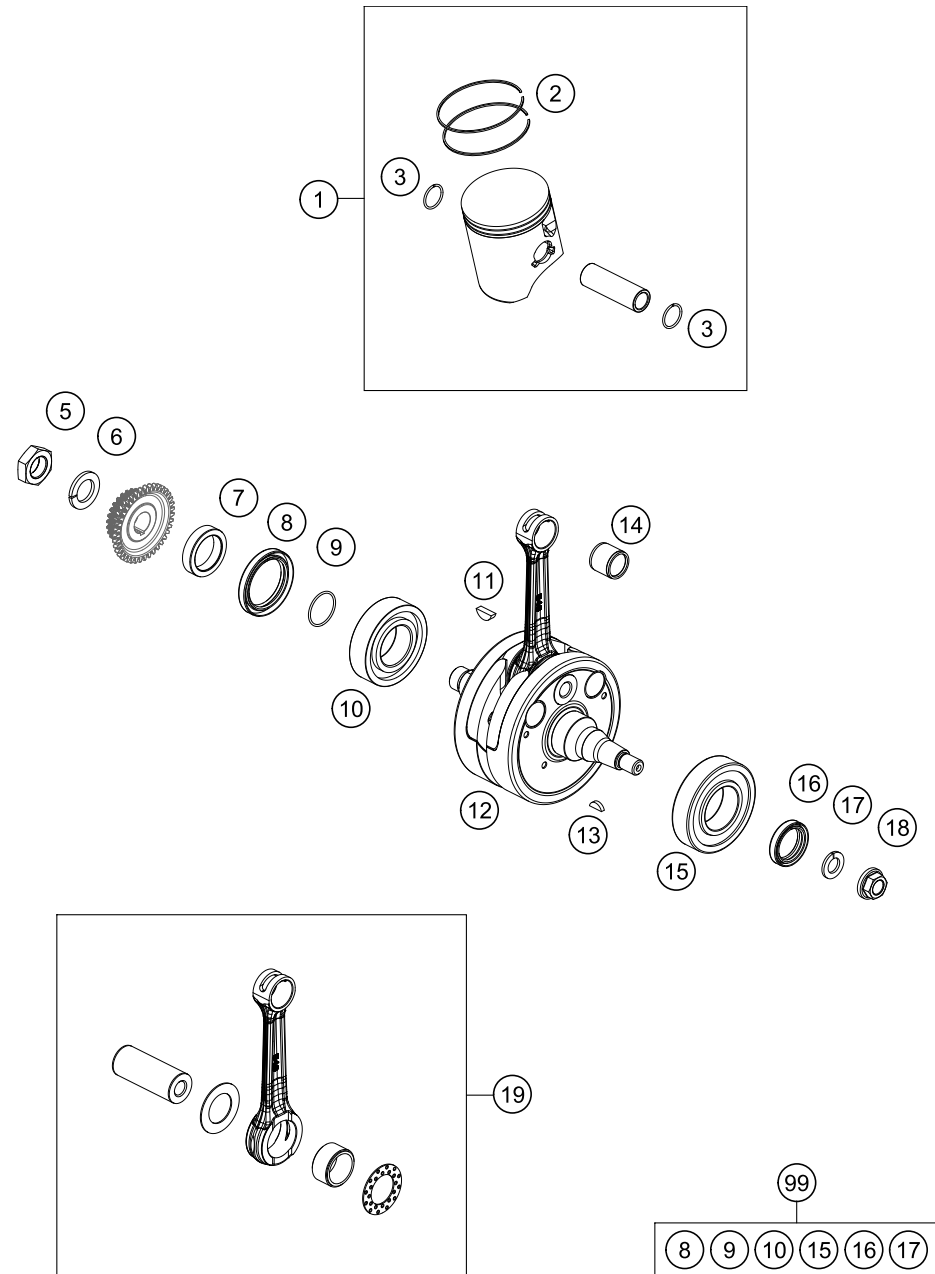

POS	PARTNUMBER	PARTNAME	PIECE
1*	55630307100 I	Piston I cpl.	1
1*	55630307100 II	Piston II cpl.	1
2	54830132000	R-RING 72,0MM 300 2004	2
3*	54830074000	SNAP RING 18X1,5	2
5	54630029000	HEX.NUT L/SH M18X1,5	1
6	58132072000	LOCK WASHER VSK 18	1
7	55430016000	DISTANCE SLEEVE	1
8	0760385273	SHAFT SEAL RING 38X52X7BTSL	1
9	0770250015	O-RING 25,00X1,50 NBR 70	1
10	0625623204	BALL BEARING 32X65X17 NTN	1
11	6946005	WOODRUFF KEY 5X6,5 HARDED	1
12	55430118100	CRANKSHAFT EXC	1
13	0888030050	WOODRUFF KEY DIN6888-3X5X13	1
14	54430034000	NEEDLE BEARING KBK 18X22X20	1
15	56530123200	CYLIND.ROL.BEAR. NJ207ET2XCS42	1
16	0760253570	SHAFT SEAL RING 25X35X7 BTSL	1
17	50230029012	LOCKING RING VSK 12	1
18	49030021000	COLLAR NUT M12X1 R/S	1
19	54830015244	CON.ROD REP.SET 250/300	x
99	00050002301	CRANKSHAF REP. KIT 250-300	x

185563060

50660

\* NEW PART

X ON DEMAND

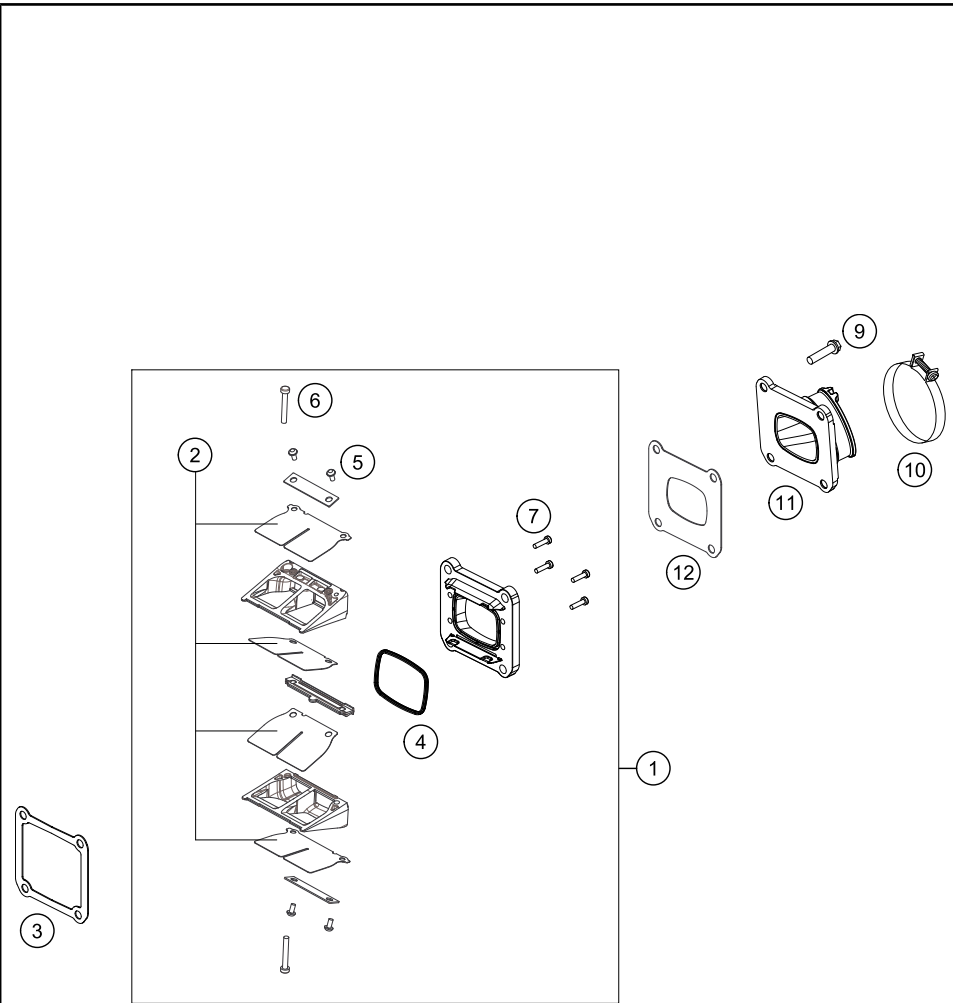

POS	PARTNUMBER	PARTNAME	PIECE
1	50430151044	REED VALVE CASE CPL.	1
2	54830052344	REED VALVE SET	1
3	50430098050	GASKET REED VALVE CASE	1
4	54830153050	GASKET SUPPORTING PLATE	1
5	00810300553	EJOT DELTA PT SCREW 30X5,5	4
6	0081035253	EJOT DELTA PT SCREW 35X25	2
7	0081030124	EJOT DELTA PT SCREW 30X12	4
9	0025060256	HH collar screw M6x25 TX30	4
10	54330061000	CLAMP 52/12 GEMI	1
11	50430050000	INTAKE FLANGE	1
12	50430098060	GASKET INTAKE FLANGE	1

165043070

17143

\* NEW PART

X ON DEMAND

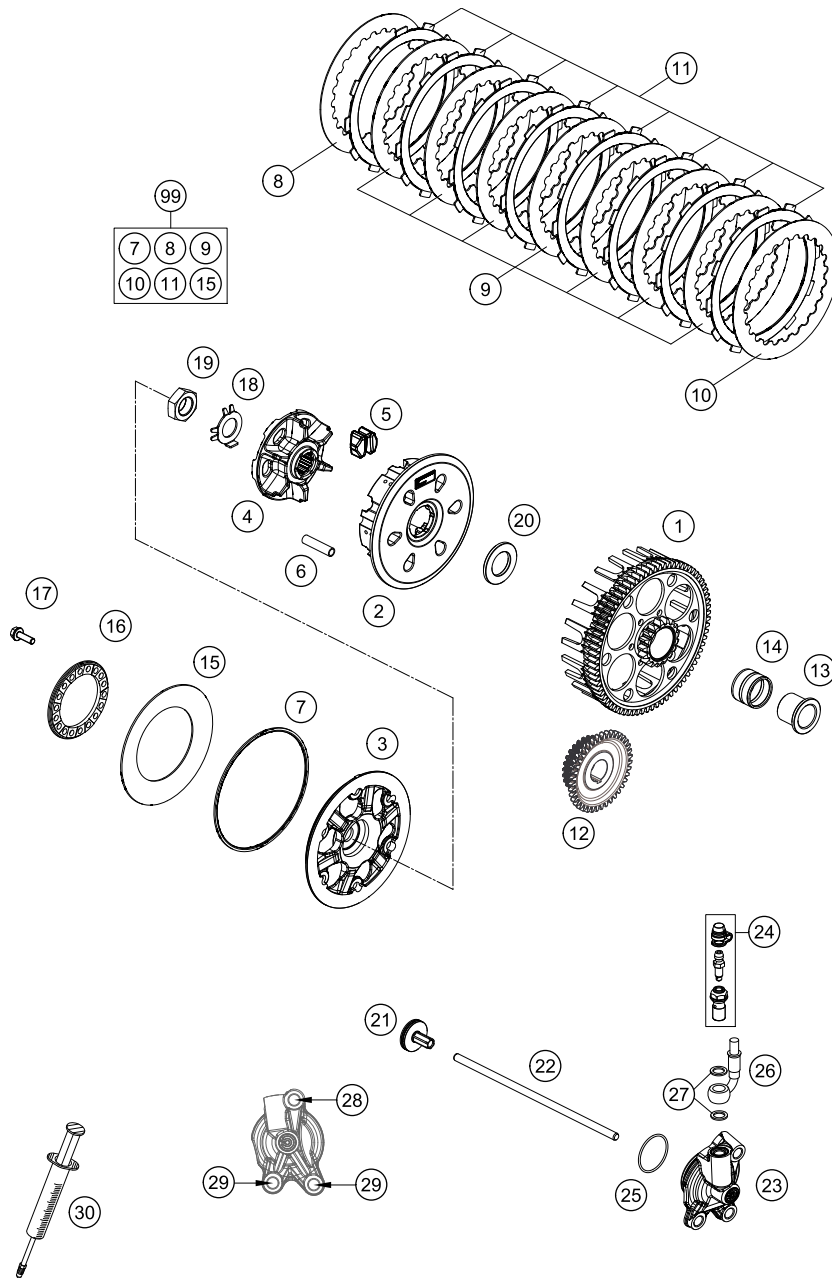

POS	PARTNUMBER	PARTNAME	PIECE
1*	79232201073	OUTER CLUTCH HUB EXC	1
2	78132002300	CLUTCH HUB	1
3	79432003000	CLUTCH PRESSURE CAP	1
4	78132002111	HUB	1
5	78132025100	DAMPING RUBBER	6
6	77232004000	DRIVING SLEEVE D=7,95 L=38	6
7	78132013000	WASHER 112X118X1.5	1
8	59032010100	INTERMEDIATE DISC 1MM 2002	1
9	59032010200	INTERMEDIATE DISC 1,4MM 2002	7
10	78932010000	INTERMEDIATE DISC 1MM	1
11	54832011100	LINING DISC 1,95 MM	8
12	55432024026	PRIMARY GEAR	1
13	77232015000	INNER RING	1
14	56532095000	NEEDLE BEARING K26X30X22ZW.KSE	1
15	78132005000	BELLEVILLE SPRING 71X115X1,5 I	1
16	78132006100	SPRING RING	1
17	0025050166	HH collar screw M5x16 TX30	6
18	78132018000	TAB WASHER	1
19	0936181505	HEXAGON NUT DIN0936-M18X1,5 R.	1
20	77232009000	WASHER 21,8 X 37 X 5,1	1
21	78032057044	PRESSURE PIECE CPL. 08	1
22	79232054000	PUSH ROD	1
23	79232061044	OUTPUT CYLINDER CPL.	1
24	79032064000	BLEEDER SCREW CPL.	1
25	0770300015	O-RING 30,00X1,50 NBR 70	1
26	79232063000	CLUTCH PIPE	1
27	0603082121	SEAL RING CU DIN7603- 8X12X1	2
28	0025060256	HH collar screw M6x25 TX30	1
29	0025060166	HH collar screw M6x16 TX30	2
30	50329050000	VENT INJEKTION HYDR. CLUTCH	1
99	54832011110	CLUTCH KIT 250/300 13-15	x

175543210

50613

\* NEW PART

X ON DEMAND

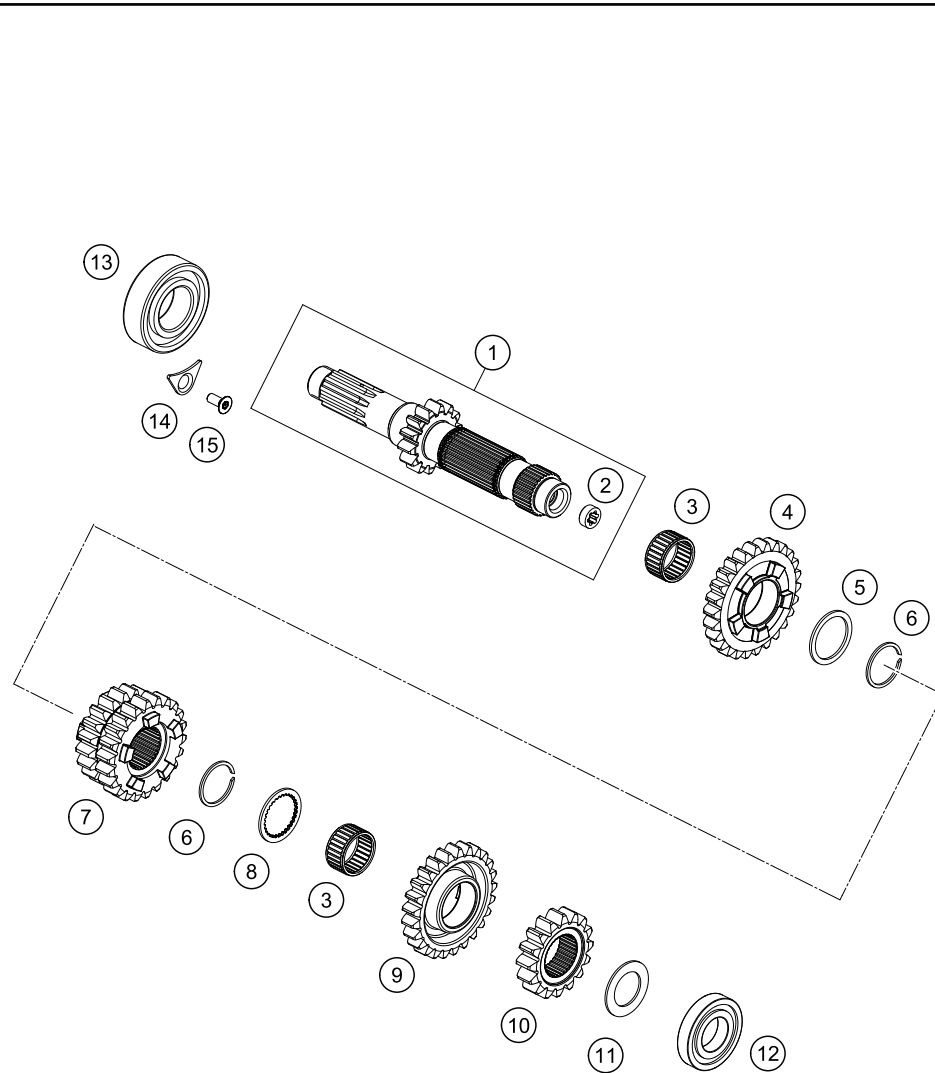

POS	PARTNUMBER	PARTNAME	PIECE
1	77233101100	Main shaft cpl. 14T	1
2	78033001110	BUSHING	1
3	0405222613	NEEDLE BEAR. K 22X26X13 TN	2
4	54833206100	Idler gear 6.G, Z=26	1
5	54833044000	STOP DISC 25X31X1,5	1
6	0417024000	CIRCLIP WS24	2
7	79233103100	Sliding gear 3rd/4th., t=20/22	1
8	54833043000	STOP DISC 25X0,8X30X30X7H	1
9	54833205100	Idler gear 5.G, Z=25	1
10	54833202100	Idler gear 2 nd. gear T=16	1
11	77233015000	DISK 20,2X32X1,3	1
12	0625160040	GROOVED BALL BEAR. TM 16004 C3	1
13	0625062054	BALL BEARING 6205 C3 NTN	1
14	75030085000	RETAINING PLATE F. CS BEARING	1
15	0019050121S	INT. TORX FLAT HEAD M5X12 T25	1

175543331

49344

\* NEW PART

X ON DEMAND

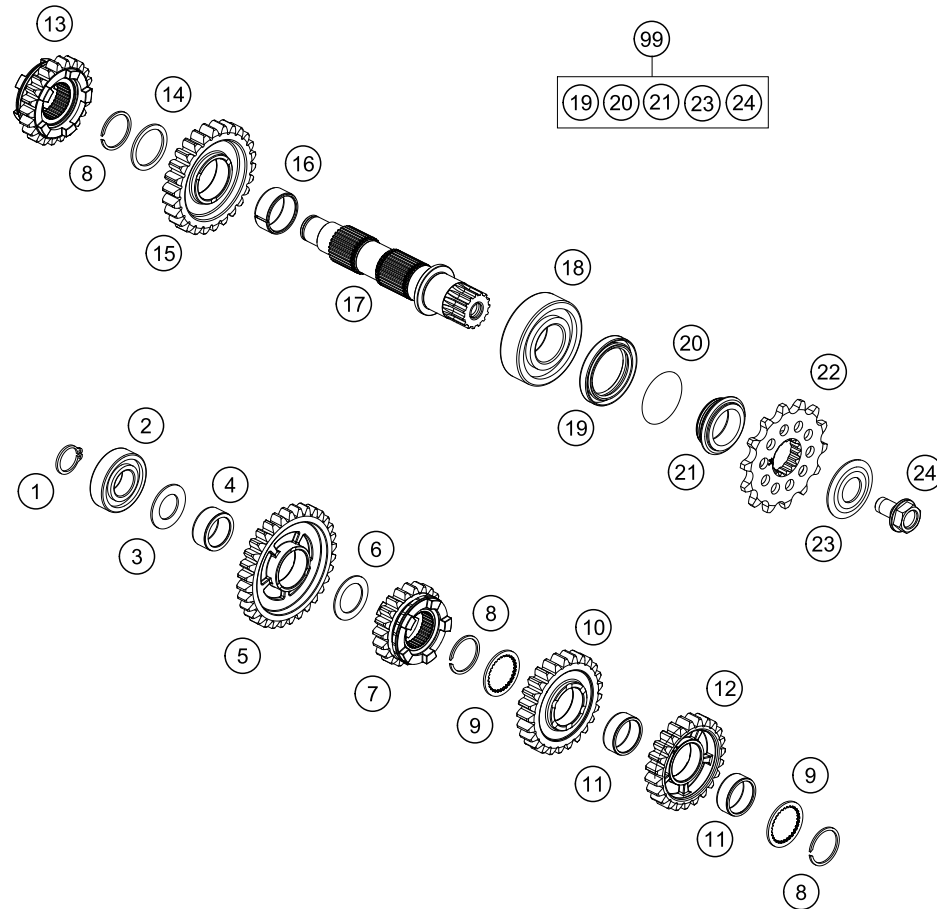

POS	PARTNUMBER	PARTNAME	PIECE
1	0471170015	CIRCLIP DIN 0471-17X1, 5	1
2	0625062035	BALL BEARING 6203 JR2 C3	1
3	77233020000	STOP DISK 17,2X30X1,3	1
4	0405202612	NEEDLE BEARING K 20X26X12	2
5	54833211100	Idler gear 1.G. Z=32	1
6	54833080000	STOP DISC 20,2X30X1	1
7	54833216100	Sliding gear 6 th, Z=20	1
8	0417024000	CIRCLIP WS24	3
9	54833043000	STOP DISC 25X0,8X30X30X7H	2
10	54833213100	Idler gear 3th, Z=25	1
11	0405222611	NEEDLE BEAR.K 22X26X10 DIVIDED	2
12	54833214100	Idler gear 4.G, Z=23	1
13	54833215100	Sliding gear 5th Z=22	1
14	54833044000	STOP DISC 25X31X1,5	1
15	54833212100	Idler gear 2 nd. gear T=26	1
16	0405242812	NEEDLE BEAR. K24X28X11,9 DIV.	1
17	77233110100	Output shaft	1
18	49030023000	cylindrical roller bearing NJ205	1
19	0760324571	SHAFT SEAL RING 32X45X7 BSLNBR	1
20	0770020220	O-RING 25,12X1,78 NBR70	1
21	78133014000	SPACER SLEEVE COUNTER	1
22	79233129014	ENGINE SPROCKET 14Z	1
22	79233029013	SPROCKET 13T	x
23	59033034000	SPRING WASHER 17,2X40X1,5	1
24	59033029000	HH COLLAR SCREW M10X18 10.9	1
99	00050000983	COUNTER SHAFT REP.KIT 2 STROKE	x

175543361

19139

\* NEW PART

X ON DEMAND

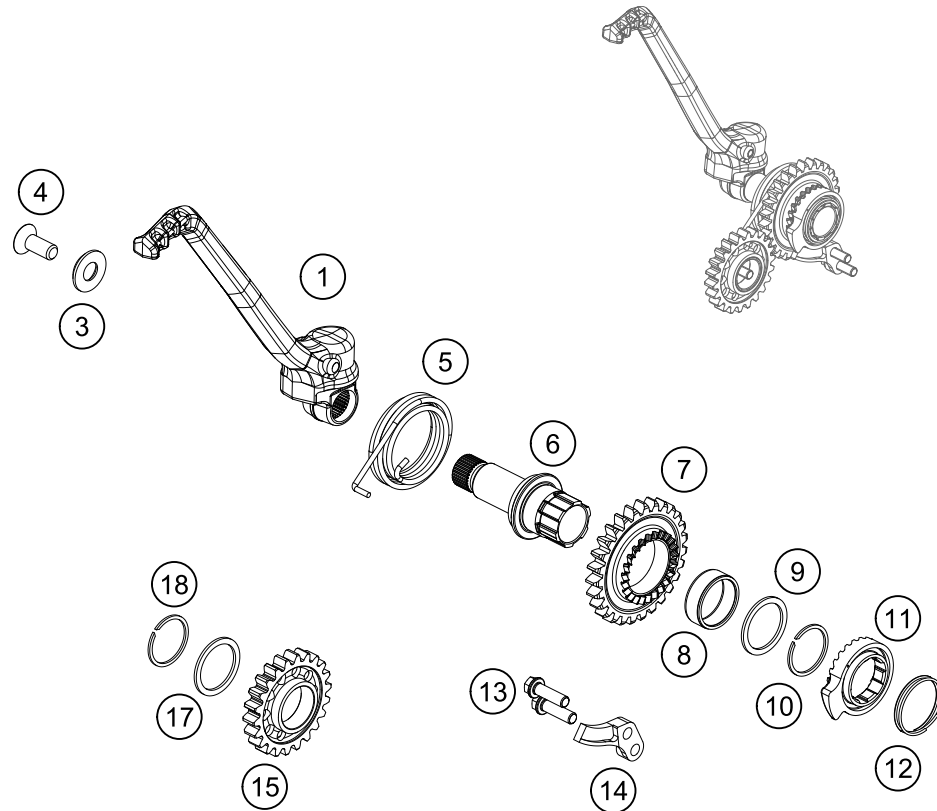

POS	PARTNUMBER	PARTNAME	PIECE
1	50433070044	KICKSTARTER CPL.	1
3	54633037000	WASHER 8MM GALVANIZED	1
4	0019080206S	FLAT HEAD SCREW M. ISA45 M8X20	1
5*	50433054200	Kick-starter spring	1
6	79233050000	KICK STARTER SHAFT	1
7	79233051027	KICK STARTER WHEEL 27Z	1
8	0405252910	NEEDLE BEAR K 25X29X10	1
9	54833044000	STOP DISC 25X31X1,5	1
10	0417025000	CIRCLIP SW25	1
11	50433052000	KICK STARTER RATCHET	1
12	58033028000	RATCHET GEAR SPRING 1,2 MM	1
13	0025060206	HH collar screw M6x20 TX30	2
14	59033069000	BUMP PART	1
15	79233053000	KICKSTART IDLER CPL.	1
17	50333041000	STOP DISC 17,2X26X1 B	1
18	0471170010	CIRCLIP DIN0471-17X1	1

185543390

50619

\* NEW PART

X ON DEMAND

# SHIFTING MECHANISM

Engine 300 EXC TPI 2019

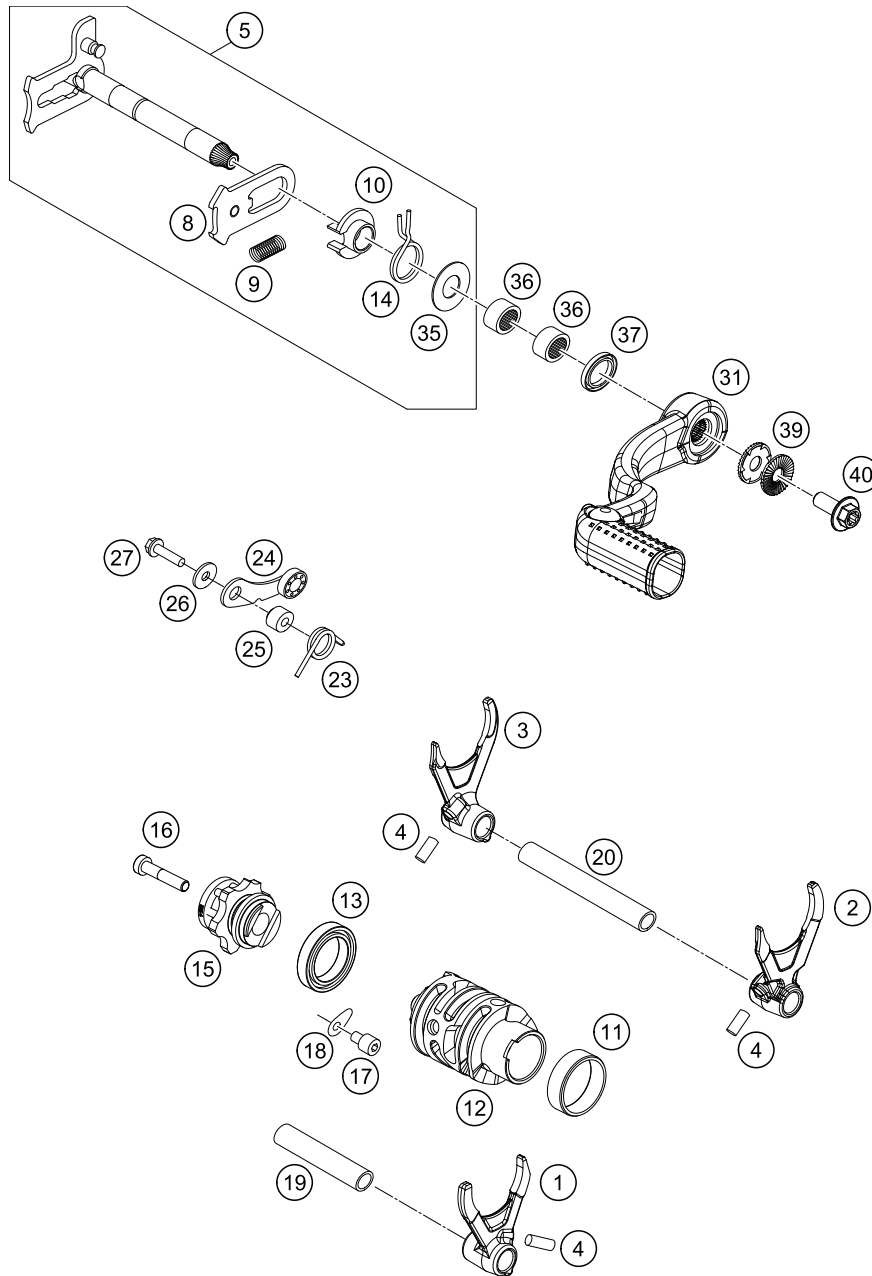

POS	PARTNUMBER	PARTNAME	PIECE
1	79234101000	SHIFT FORK 5.-6. GEAR	1
2	79234102000	SHIFT FORK 2.-4. GEAR	1
3	79234103000	SHIFT FORK 1.-3. GEAR	1
4	0402061480	NEEDLE ROLLER DIN5402 6X14,8	3
5	55434005133	SHIFT SHAFT CPL.	1
8	61234008044	SLIDING PLATE	1
9	56534013100	TENSIONING SPRING 0,8MM	1
10	54634020000	SPRING GUIDE	1
11	79234012010	FRICTION BEARING CONTROLLER	1
12	79234112000	SHIFT ROLLER	1
13	0625618050	BALL BEARING 61805 C3	1
14	54834014000	RETURN SPRING 03	1
15	55434015000	GEARSHIFT CPL.	1
16	0984060302	AH SCREW DIN6912 M 6X30	1
17	0019050106S	hex lobe countersunc screw M5x10 - 10.9	1
18	75030085000	RETAINING PLATE F. CS BEARING	1
19	54834019000	SHIFT. RAIL MAIN SHAFT 250/300	1
20	77034019000	SHIFTING MAIN L=93MM 05	1
23	55434023100	LOCKING LEVER SPRING	1
24	55434024000	LOCKING LEVER CPL.	1
25	54634052300	SLEEVE FOR LOCKING LEVER	1
26	0349000050	WASHER DIN7349-5X15X2	1
27	0025050206	HH collar screw M5x20 TX30	1
31	55434031000	SHIFTING LEVER CPL.	1
35	54634050000	STOP DISK 14X30X1	1
36	54632095000	needle sleeve HK 1412 14x20x12	2
37	0760142460	radial shaft seal 14x24x6 B	1
39	50233041500	PAIR NORDLOCK WASHER M6	1
40	0024060156S	HH collar screw M6x15 TX30	1

175543411

18096

\* NEW PART

X ON DEMAND

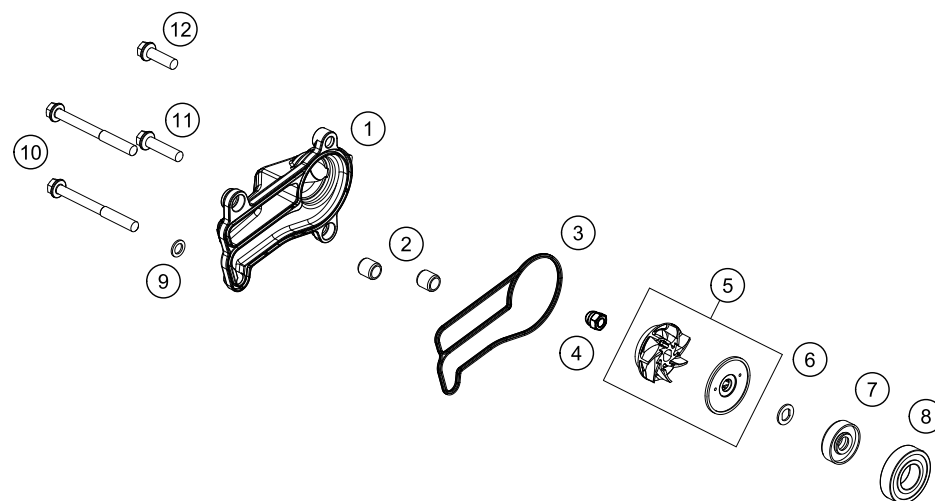

POS	PARTNUMBER	PARTNAME	PIECE
1	55435052000	WATER PUMP COVER	1
2	49030090100	DOWEL 9,8 X7X10	2
3	55435053000	GASKET WATER PUMP COVER	1
4*	61230045000	CAP NUT M6 STAINLESS STEEL	1
5	79235055044	WATER PUMP WHEEL CPL.	1
6	50435049000	PREFORMED WASHER	1
7	0760082472	SHAFT SEAL RING 8X24X7 A DUO	1
8	0625160020	BALL BEARING 16002 C3	1
9	0603061001	CU-SEAL RING DIN7603-6X10X1	1
10	0025060606	HH collar screw M6x60 TX30	2
11	0025060256	HH collar screw M6x25 TX30	1
12	0025060206	HH collar screw M6x20 TX30	1

195543510

50617

\* NEW PART

X ON DEMAND



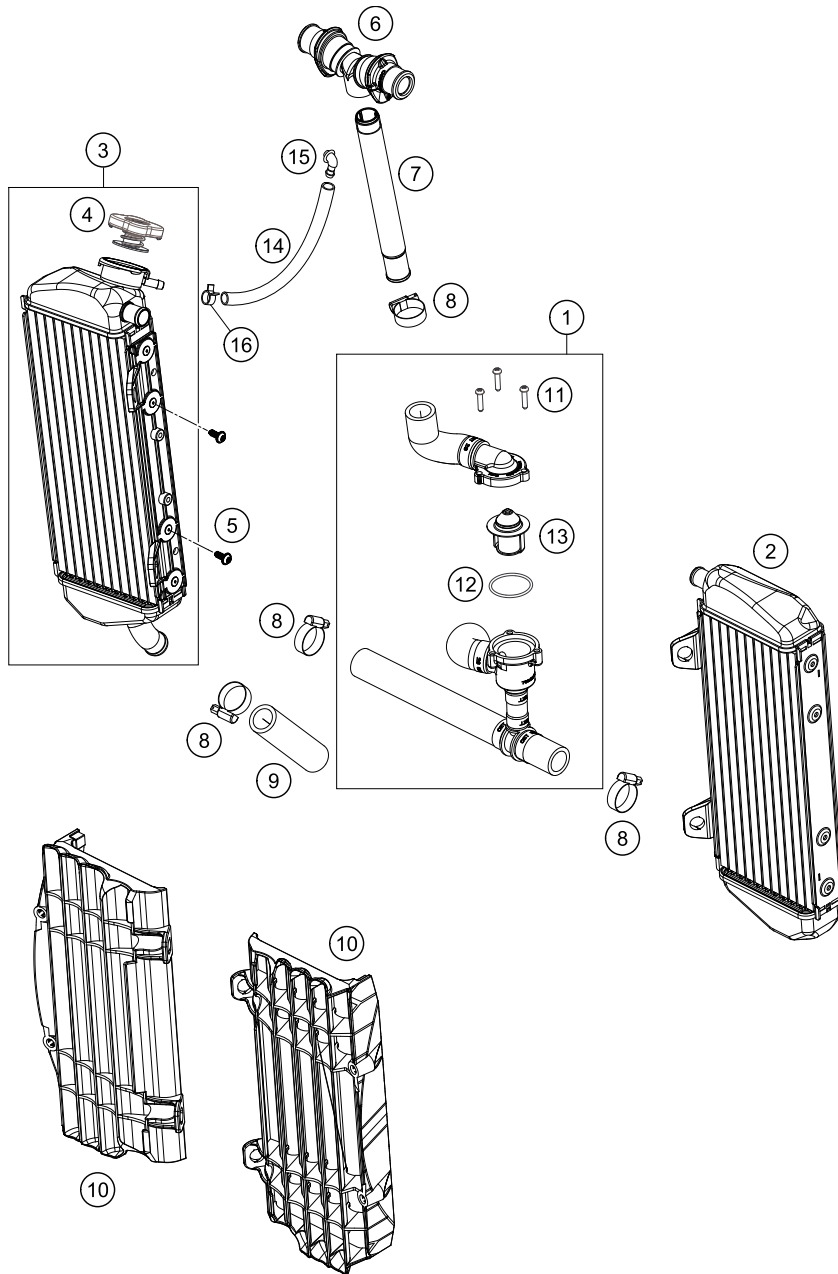

POS	PARTNUMBER	PARTNAME	PIECE
1	55635026133	Preformed hose w. therm.	1
2*	50435007200	Radiator left	1
3*	50435008200	Radiator right	1
4	79035016000	RADIATOR CAP 1,8 BAR	1
5	0024060123	COLLAR SCREW M6X12 TX	4
6	79035071044	Y-PIECE CPL.	1
7	50435073000	COOLING WATER PIPE	1
8	10001020000	HOSE CLAMP GEMI 18-29	6
9	55635027000	PRE-FORMENDHOSEENGINE/RADIAT	1
10	7903513400030	RADIATOR PROTECTOR	2
11	0016040183	SCREW FOR PLASTIC D=4X18	3
12	0770320020	O-RING 32,00X2,00	1
13	59435017000	THERMOSTAT 70 DEGREE 04	1
14	50335030001	PVC-HOSE 6X9	1
15	50303089000	ANGLE PIECE '97	1
16	59007017000	CLAMP YDNAC 10096F (9,6MM)	1

195543530

50627

\* NEW PART

X ON DEMAND

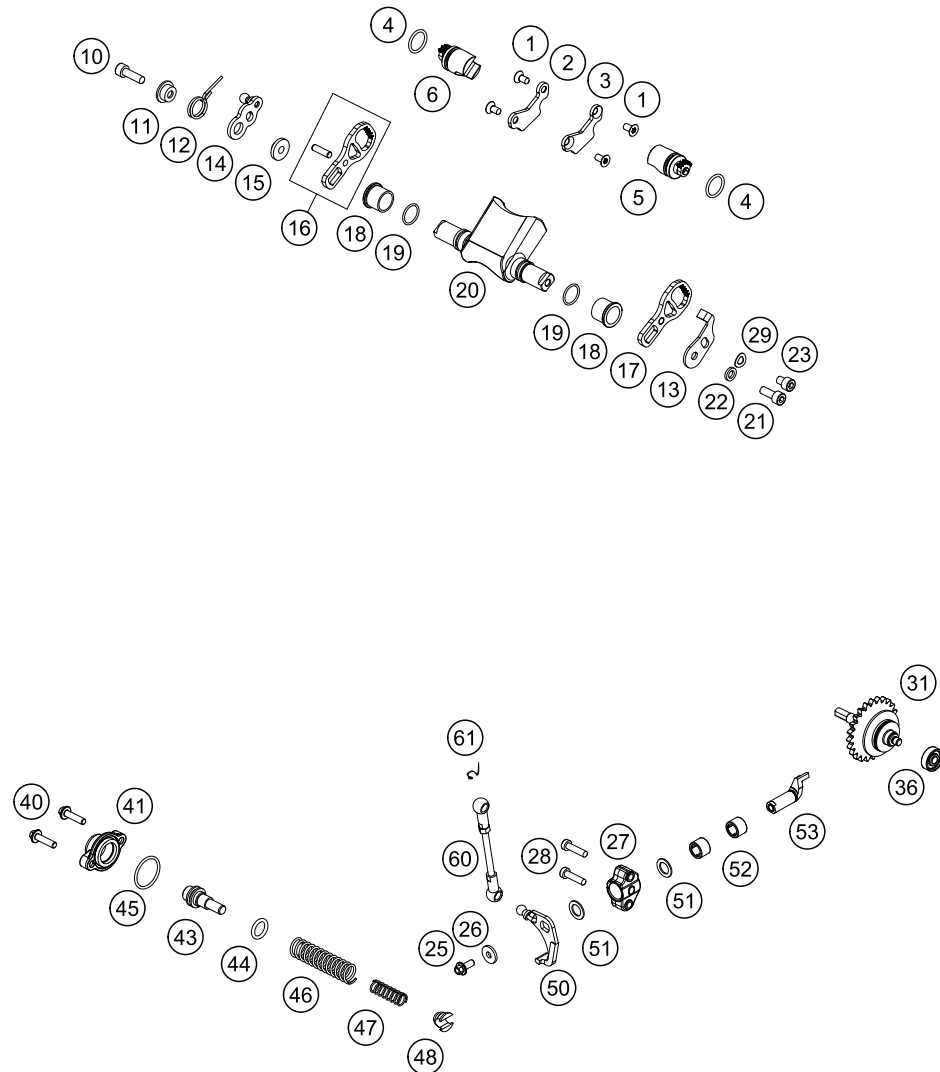

POS	PARTNUMBER	PARTNAME	PIECE
1	0019050106S	hex lobe countersunc screw M5x10 - 10.9	4
2	54837362000	RETAINING PLATE 300 R/S 08	1
3	54837363000	RETAINING PLATE 300 L/S 08	1
4	0770160021	O-RING 16,00X2,00 VITON	2
5	55437161044	CONTROL ROLLER 300 LEFT CPL.	1
6	55437162044	CONTROL ROLLER 300 RIGHT CPL.	1
10	0912060203	AH SCREW DIN0912-M 6X20	1
11	54637067000	SPRING SLEEVE	1
12	54637066000	OVERLOAD SPRING	1
13	54637085300	RETAIN.PLATE CONTROL FLAP '92	1
14	54637065000	CONTROL LEVER WITH BALL TYPE	1
15	54637068100	BUSHING SLEEVE	1
16	54837364044	GEAR SEGMENT RIGHT CPL. 08	1
17	54837364050	GEAR SEGMENT 300 L/S 08	1
18*	50437023100	exhaust flap bushing	2
19	0770150151	O-RING 15,00X1,50 VITON	2
20	55637120000	CONTROL FLAP 300	1
21	0912060163	AH SCREW DIN0912-M 6X16	1
22	54637056100	WASHER 6,5X11X2	1
23	0912060083	AH SCREW DIN0912-M 6X 8	1
25	0014050123	HH COLLAR SCREW M 5X12 WS=6	1
26	0349000050	WASHER DIN7349-5X15X2	1
27	55437058000	BEARING SUPPORT	1
28	0025050256	HH COLLAR SCREW M5X25 ISA30	2
29	0137060003	spring washer DIN 137 B - 6	1
31*	55537050244	Centrifugal force governor cmpl.	1
36	54637098100	BALL BEARING 626LLBC3/5K	1
40	0014050203	HH COLLAR SCREW M 5X20 WS=6	2
41	54637070100	COVER LID 250-380'98	1
43	54837075000	SPRING GUIDE 250/300	1
44	0770021120	O-RING 12,37X2,62 NBR70	1
45	0770240020	O-RING 24,00X2,00 NBR70	1
46	54837069000	ADJUST. SPRING 2003	1
47	54637072300	AUXILIARY SPRING MID., YELLOW	1
48	54637071200	SPRING INSERT	1
50	47237056000	angle lever	1
51	0988101610	SHIM WASHER DIN988 10X16X1	2
52	0618101410	needle sleeve HK 1010 10x14x10	2

175543710

50661

\* NEW PART

X ON DEMAND

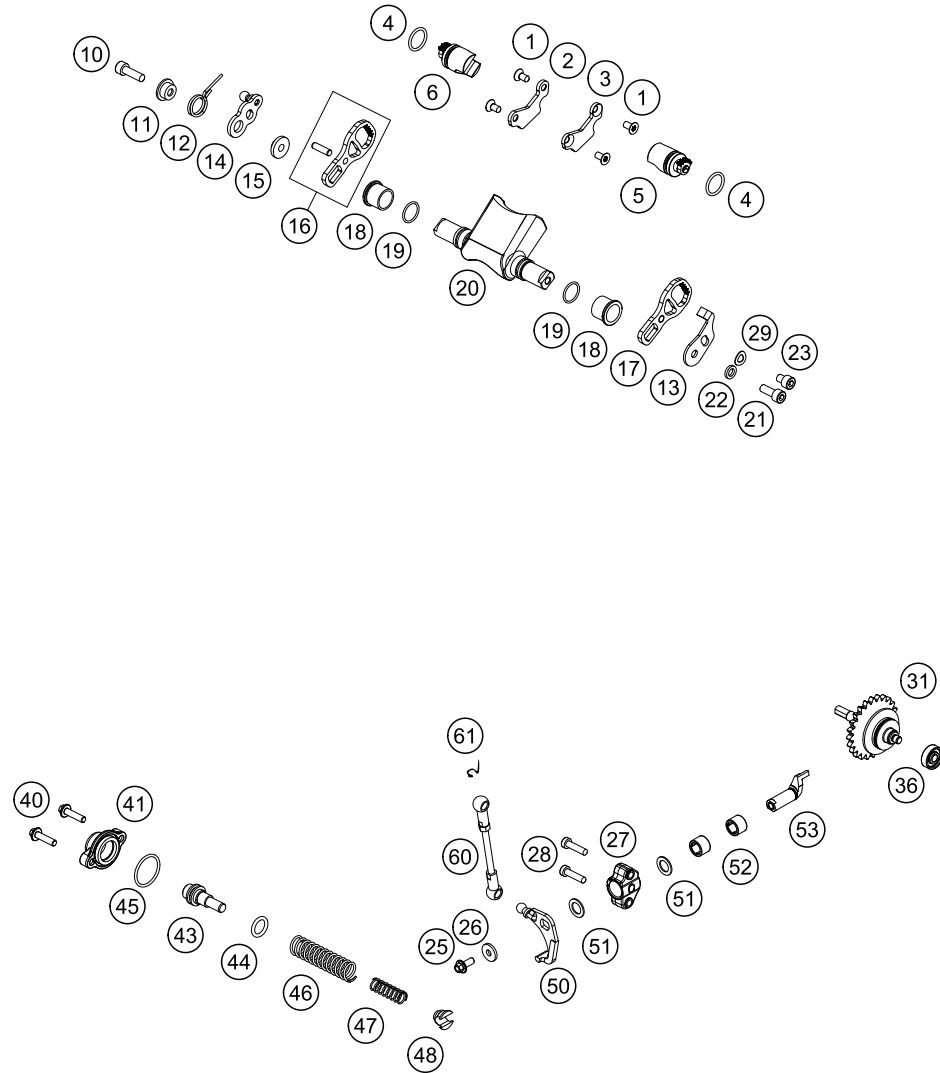

POS	PARTNUMBER	PARTNAME	PIECE
53	55437057100	ADJUSTING LEVER 250/300	1
60	55437095044	CONNECTING ROD CPL.	1
61	50237195055	SECURING DIN-71805-S-8	1

175543710

50661

\* NEW PART

X ON DEMAND

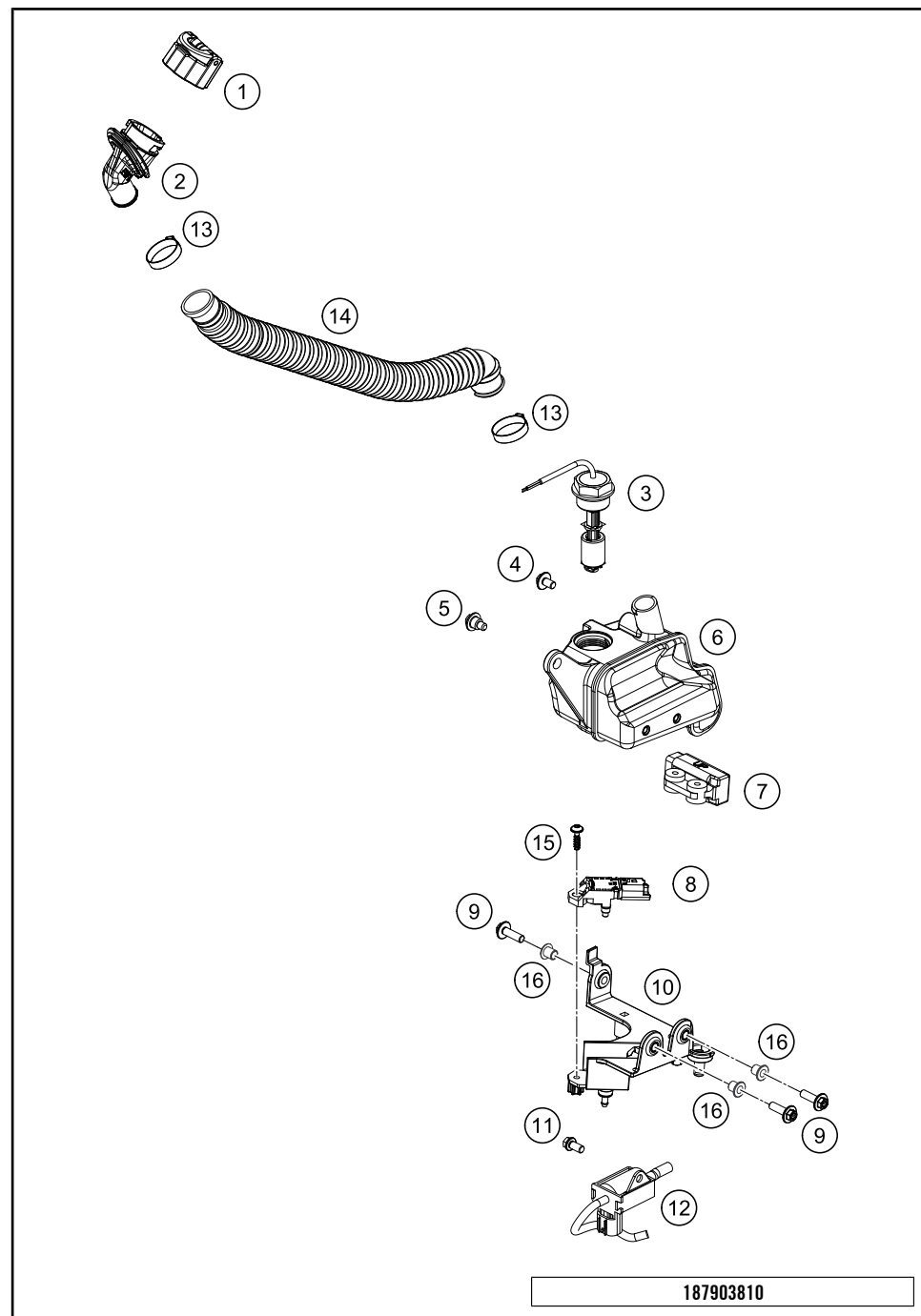

POS	PARTNUMBER	PARTNAME	PIECE
1	55638070033	Oilfillercap cpl.	1
2	55638061020	Filler plug oil tank	1
3	55638062000	Oil level sensor	1
4	0024060106	HH COLLAR SCREW M6X10 TX30	1
5	59001092050	SPECIAL SCREW M6X12,5 WS=8	1
6	55638061200	Oil tank	1
7	61041088000	ROLLOVER SENSOR 05	1
8	55641075000	Crankcase Presure Sensor CCP	1
9	0024060156	HH collar screw M6x15 TX30	3
10	55638061040	Oil pump support	1
11	0025060126	HH collar screw M6x12 TX30	1
12	55638064000	Oil pump	1
13	00050271708	VARIABLE ONE-EAR CLAMP 27,1MM	2
14	55638065100	Hose	1
15	0081050181	SCREW FOR PLASTIC K50X18 T20	1
16	58314060050	spacer bushing for speedometer holder	3
17	55538087000	Clamp 2	2
18	55538086000	Clamp 1	2
19	55538083044	Tube set, oil tank	1

19155

\* NEW PART X ON DEMAND

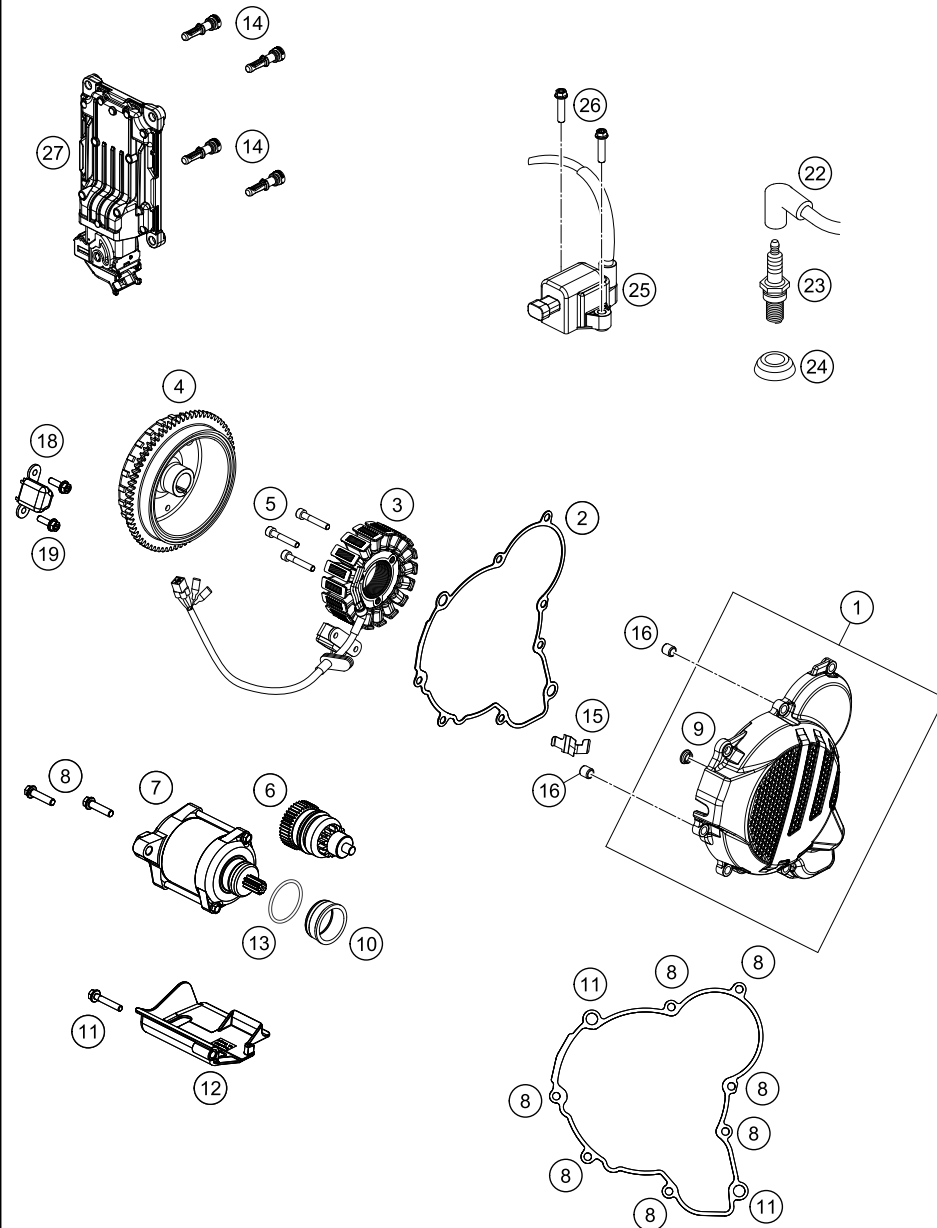

POS	PARTNUMBER	PARTNAME	PIECE
1	5543010214415	Ignition cover cpl.	1
2	55430040000	IGNITION COVER GASKET	1
3	55439104000	Stator	1
4	55439105000	flywhell	1
5	0912050303	AH SCREW DIN0912-M 5X30	3
6	55440126000	BENDIX	1
7	55440001000	STARTER ENGINE	1
8	0025060256	HH collar screw M6x25 TX30	9
9	55140030100	COLLAR BUSHING	1
10	55440012000	BEARING BUSH	1
11	0025060306	HH collar screw M6x30 TX30	3
12	55440040044	PROTECTION CAP STARTER ENGINE	1
13	0770021260	O-RING 34,59X2,62	1
14	55641030000	Holder control unit	4
15	55439140220	Holding plate generator cable	1
16	49030090100	DOWEL 9,8 X7X10	2
18	59039034000	pulse generator KOKUSAN 4K3-A/B	1
19	0025050166	HH collar screw M5x16 TX30	2
22	55639007000	Ignition wire	1
23	55439193000	Spark plug	1
24	50231012000	SEALING CUP FOR SPARK PLUG	1
25	55639006000	Ignition coil	1
26	0025060256	HH collar screw M6x25 TX30	2
27	55641031000	Control device EFI	1

185543910

19152

\* NEW PART

X ON DEMAND

# THROTTLE BODY

Engine 300 EXC TPI 2019

POS	PARTNUMBER	PARTNAME	PIECE
1	55641001000	Throttle body	1
2	55641056044	TVB cover compl.	1
3	55641077044	TPS compl.	1
4	55641078044	TPS cover compl.	1
5	55641060000	Air adjust. screw	1
6	55641070000	Starter valve comp.	1

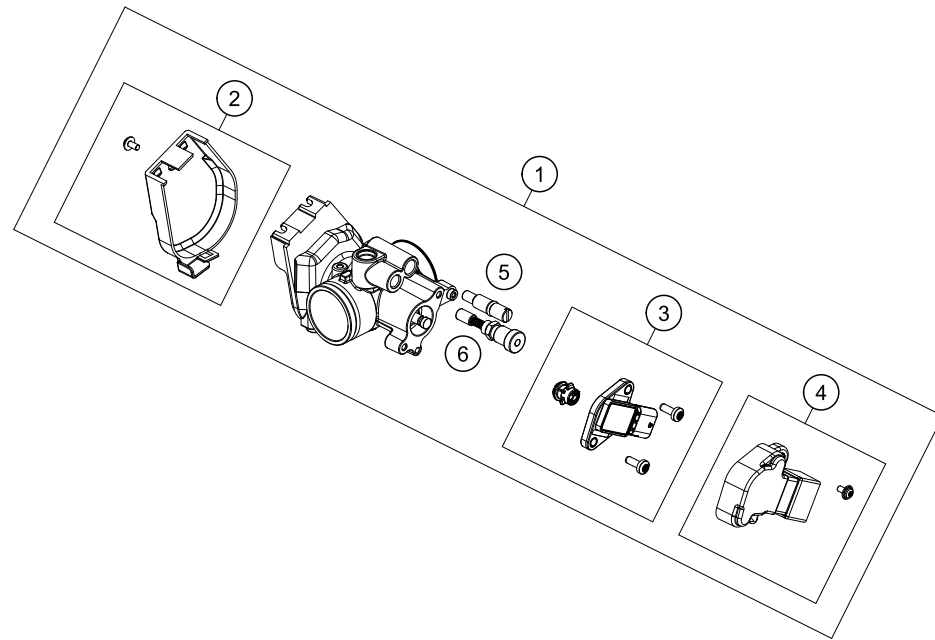

185544110

19185

\* NEW PART

X ON DEMAND

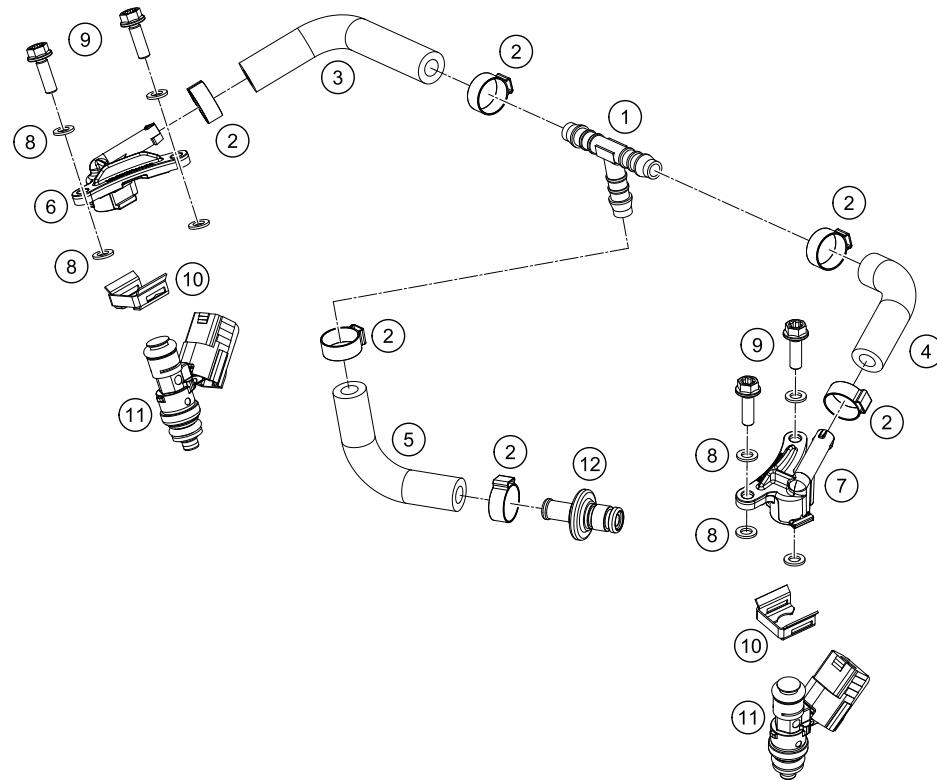

POS	PARTNUMBER	PARTNAME	PIECE
1	55441007000	T-connector 7.5	1
2	00050157706	VARIABLE ONE-EAR CLAMP 15,7MM	6
3	55441019000	TPI hose right	1
4	55441018000	TPI hose left	1
5	55441020000	TPI supply hose	1
6	55441113000	injector top right	1
7	55441013100	Injector top left	1
8	0773705916	Insulating disk 5x9x1	8
9	58605083014	SCREW M5X14 TORX 25 07	4
10	55441017000	Injector clip	2
11	55641023044	Injector right cpl.	2
12	77707010000	CONNECTOR FUEL PUMP	1

187904130

19170

\* NEW PART

X ON DEMAND

A large, empty rectangular box with a thin black border, occupying the majority of the page. It is intended for the user to write notes related to the engine specifications mentioned in the header.



A large, empty rectangular box with a thin black border, occupying the majority of the page. It is intended for the user to write notes related to the engine specifications mentioned in the header.

A large, empty rectangular box with a thin black border, occupying the majority of the page. It is intended for the user to write notes related to the engine specifications mentioned in the header.



WWW.KTM.COM



KTM Sportmotorcycle GmbH  
5230 Mattighofen, Austria  
[www.ktm.com](http://www.ktm.com)



**KTM**\_POWERPARTS

**KTM**\_POWERWEAR

**KTM**\_ORIGINAL SPARE PARTS



084688SEN

Art. Nr.: 084688SEN 10. Apr 2018