

# Engine 890 Duke 2023

ART.-NR.: 088720WEN





All information contained is without obligation. KTM Sportmotorcycle GmbH particularly reserves the right to modify any equipment, technical specifications, prices, colors, shapes, materials, services, service work, constructions, equipment and the like so as to adapt them to local conditions or to cancel any of the above items, all without previous announcement and without giving reasons. KTM may stop manufacturing certain models without previous notice. KTM shall not be held liable for any deviations of availability and/or ability to deliver, illustrations, descriptions, printing and/or other errors. The illustrated models partly contain extra equipment, which is not applied to standard models.

© by KTM Sportmotorcycle GmbH, Mattighofen AUSTRIA; All rights reserved; Reprint, also in extracts, with written allowance of KTM Sportmotorcycle GmbH, Mattighofen only.

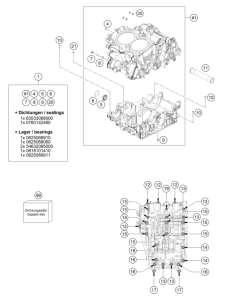
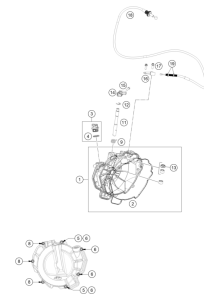
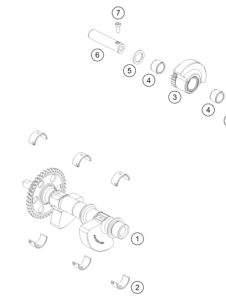
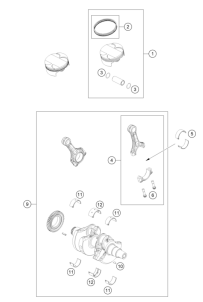
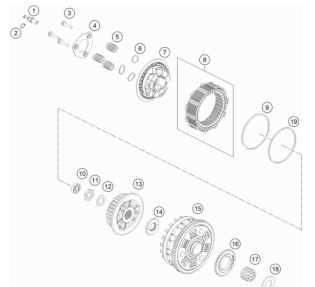
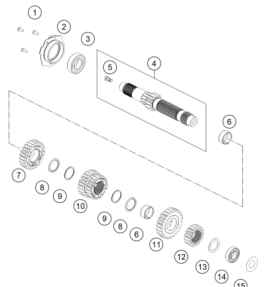
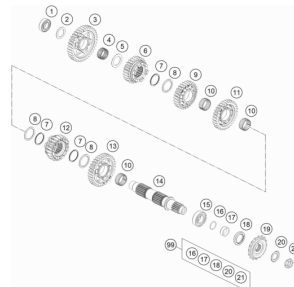
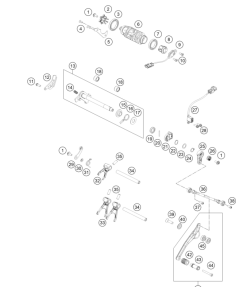
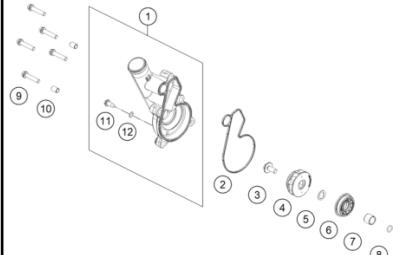
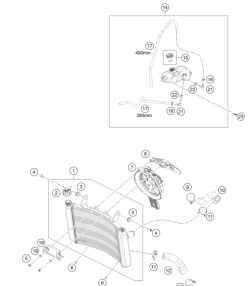
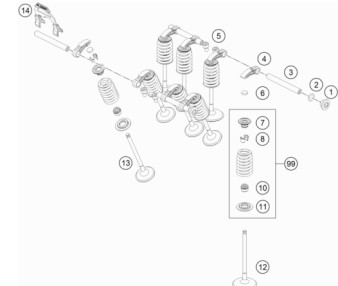
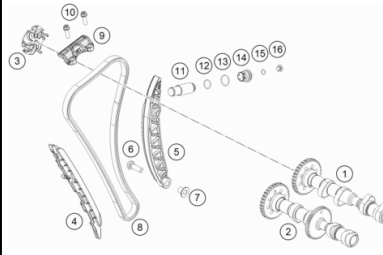
<p><b>ENGINE CASE</b></p>  <p><b>3</b></p>	<p><b>CLUTCH COVER</b></p>  <p><b>4</b></p>	<p><b>BALANCER SHAFT</b></p>  <p><b>5</b></p>	<p><b>CRANKSHAFT, PISTON</b></p>  <p><b>6</b></p>
<p><b>CLUTCH</b></p>  <p><b>7</b></p>	<p><b>TRANSMISSION I - MAIN SHAFT</b></p>  <p><b>8</b></p>	<p><b>TRANSMISSION II - COUNTERSHAFT</b></p>  <p><b>9</b></p>	<p><b>SHIFTING MECHANISM</b></p>  <p><b>10</b></p>
<p><b>WATER PUMP</b></p>  <p><b>12</b></p>	<p><b>COOLING SYSTEM</b></p>  <p><b>13</b></p>	<p><b>VALVE DRIVE</b></p>  <p><b>14</b></p>	<p><b>TIMING DRIVE</b></p>  <p><b>15</b></p>

# CONTENT

Engine 890 Duke 2023

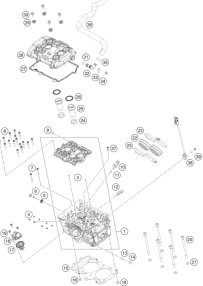
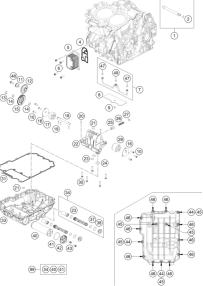
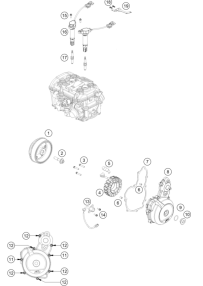
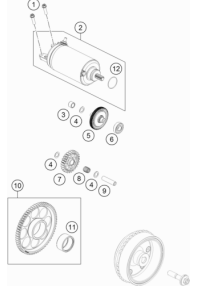
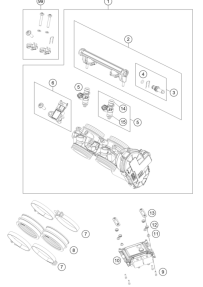
<p><b>CYLINDER HEAD</b></p>  <p><b>16</b></p>	<p><b>LUBRICATING SYSTEM</b></p>  <p><b>17</b></p>	<p><b>IGNITION SYSTEM</b></p>  <p><b>19</b></p>	<p><b>ELECTRIC STARTER</b></p>  <p><b>20</b></p>
<p><b>THROTTLE BODY</b></p>  <p><b>21</b></p>			

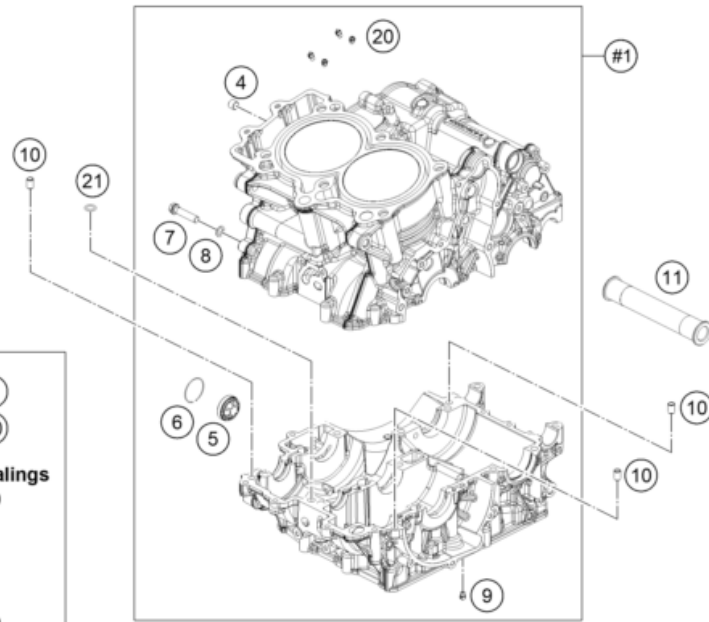

- 1**
- |    |   |   |    |
|----|---|---|----|
| #1 | 4 | 5 | 6  |
| 7  | 8 | 9 | 20 |
- + Dichtungen / sealings**  
 1x 63533088000  
 1x 0760142460
- + Lager / bearings**  
 1x 0625068910  
 1x 0625068060  
 2x 54632095000  
 1x 0618101410  
 1x 0625068911

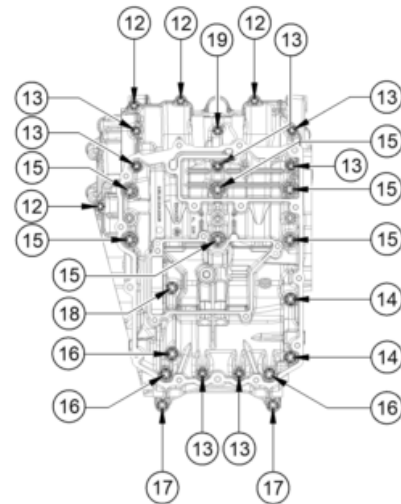

206363010

POS	PARTNUMBER	PARTNAME	PIECE
1	6363000014424	Crankcase compl.	1
4	0906100100	pipe plug DIN 906 M10x1	1
5	59030019200	OIL SIGHT GLASS	1
6	61030019050	CIRCLIP OIL LEVEL GLASS 03	1
7	0025080356	HH collar screw M8x35 TX40	1
8	0603082131	COPPER GASK.DIN7603- 8,2X13X1	1
9	60030063070	oil jet 70 M5	1
10	59030023000	dowel sleeve 6x8x11.5	3
11	63530010000	housing socket	1
12	00002506030U0	Hex collar scr., M6x30, ISA 30 w. washer	4
13	00002506060U0	Hex collar scr., M6x60, ISA 30 w. washer	7
14	0025080906	HH collar screw M8x90 TX40	2
15	00002508090U0	Hex collar scr., M8x90, ISA 40 w. washer	6
16	0025080656	HH collar screw M8x65 TX40	3
17	0025080556	HH collar screw M8x55 TX40	2
18	0025080456	HH collar screw M8x45 TX40	1
19	00002508065U0	Hexagon collar nut M8x65 ISA 40 w.washer	1
20	60030063050	oil jet 50 M5	4
21	0377101018000	O-ring 10x1.8 HNBR70 black	1
99	63630099000	Engine gasket kit 890 Duke 2020	1

53950

\* NEW PART

X ON DEMAND

# CLUTCH COVER

Engine 890 Duke 2023

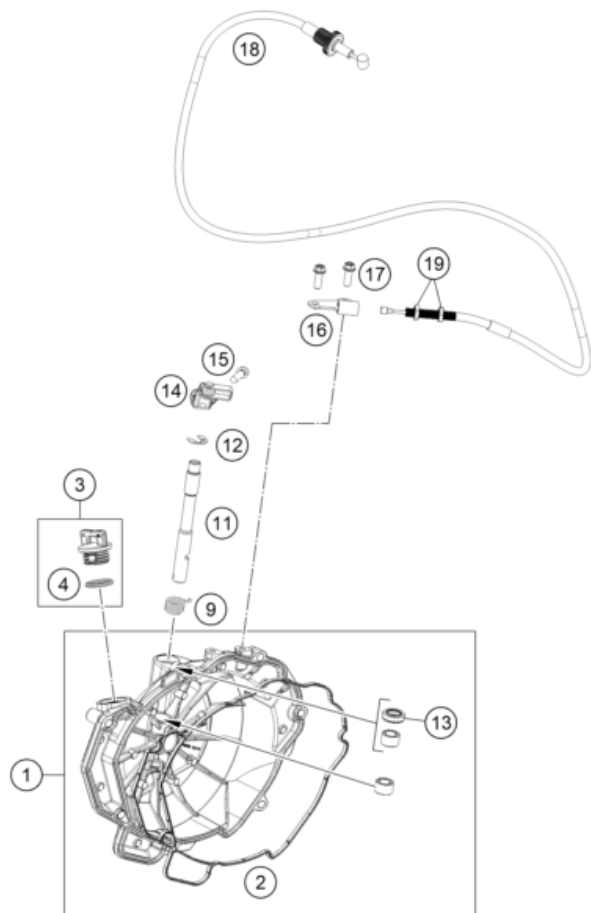

POS	PARTNUMBER	PARTNAME	PIECE
1	6353000134441	Clutch cover cpl.	1
2	63530025300	Form ring, clutch cover	1
3	58030020100	oil plug cpl. M24x3	1
4	0770191015	O-RING 19,00X3,00 NBR	1
5	59030023000	dowel sleeve 6x8x11.5	2
6	0025060356	HH collar screw M6x35 TX30	4
8	0025060256	HH collar screw M6x25 TX30	3
9	63532048003	clutch release lever spring	1
11	63532049000	clutch release shaft	1
12	0799090003	retaining washer DIN 6799 - 9	1
13	0760122060	Shaft seal ring 32x45x6.5	1
14	63532048233	Release lever assembly	1
15	014580060206S	Cyl. screw ISO 14580 M6x20 SS	1
16	63532052100	Cable retaining bracket	1
17	0025060166S	HH collar screw M6x16 TX30 SL	2
18	64102090000	Clutch cable	1
19	0934080006	HEXAGON NUT DIN 934 M8	2

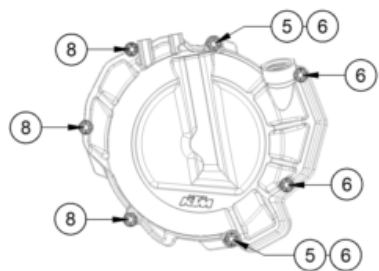

206353020

53298

\* NEW PART

X ON DEMAND

# BALANCER SHAFT

Engine 890 Duke 2023

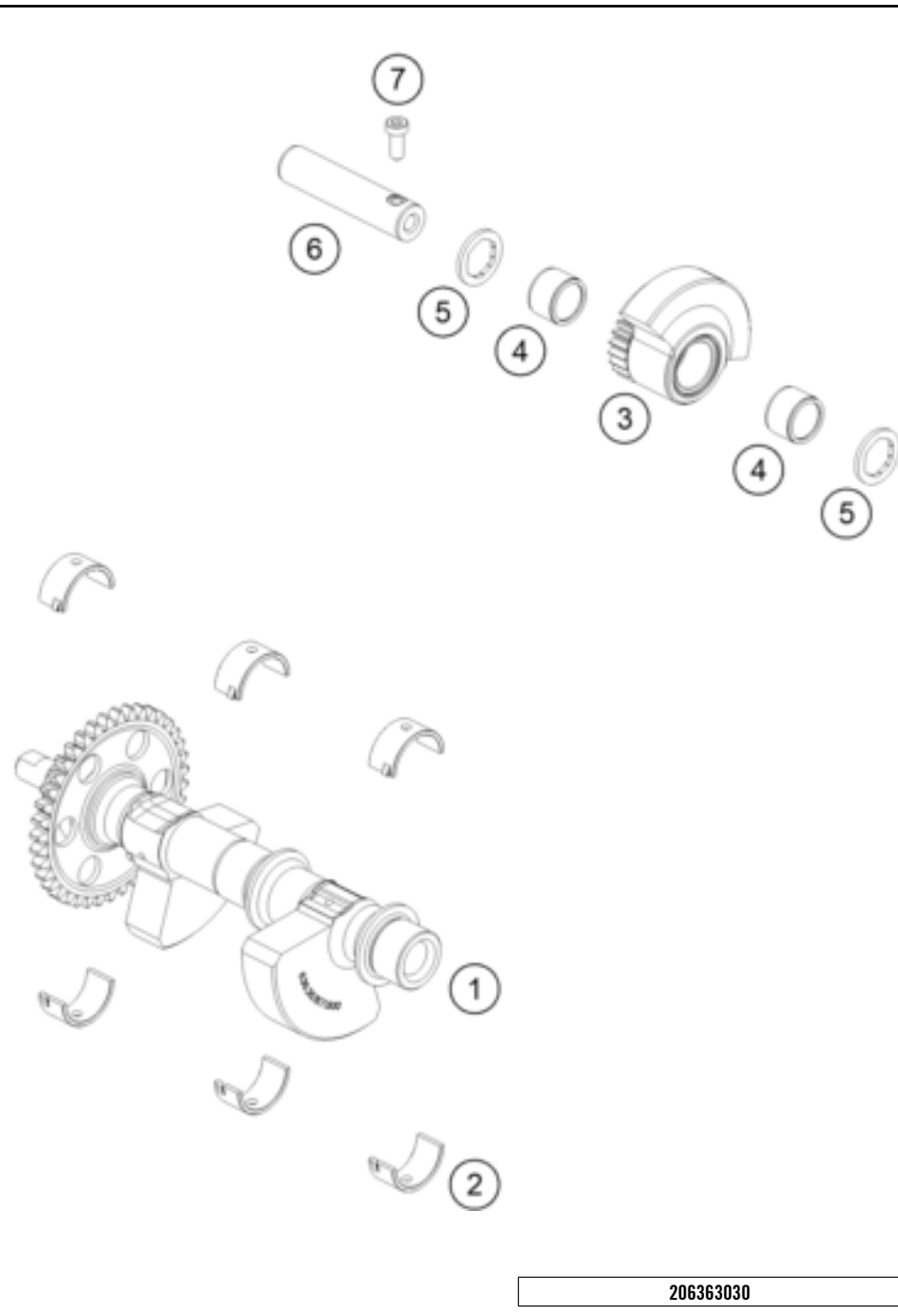

POS	PARTNUMBER	PARTNAME	PIECE
1	63630757044	Balancer Shaft assy	1
2	63530057050	Bearing Shell 22/26/13	6
3	63630059000	Balancer shaft compl.	1
4	0405151913	needle roller and cage assy. K 15x19x13	2
5	63530059060	thrust washer 15.5/22.5/2	2
6	63530059150	Bearing bolt	1
7	0984050123S	CYLIND. SCR. DIN6912 M5X12 8.8	1

206363030

5776

\* NEW PART

X ON DEMAND

# CRANKSHAFT, PISTON

Engine 890 Duke 2023

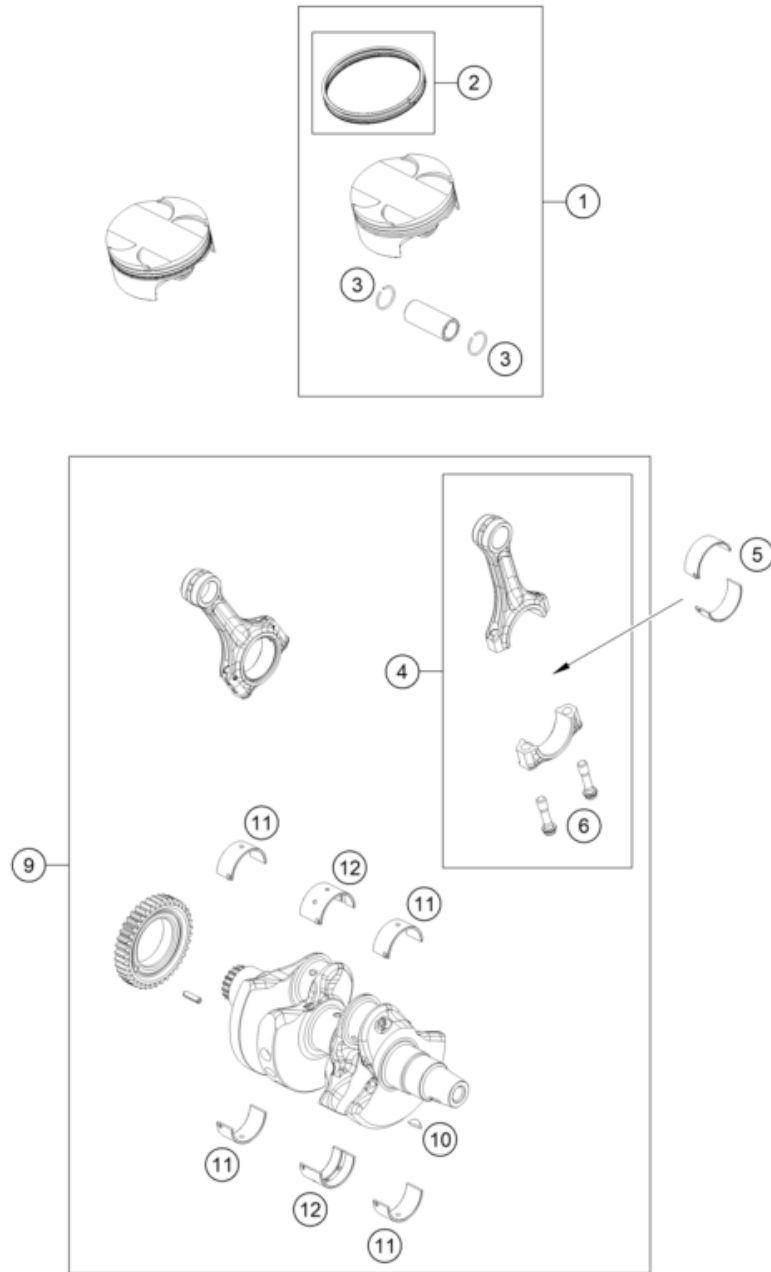

POS	PARTNUMBER	PARTNAME	PIECE
1	63630007200	Piston cmpl. 90.7 mm	2
2	63630031144	Piston ring kit	2
3	63630074000	circlip	4
4	63630015200	Connecting rod complete	2
5	635300140001	Bearing Shell, blue	x
5	635300140002	Bearing Shell, red	x
6	63630013000	Connecting rod screw, M8x0.75	4
9	63630018244	Crankshaft cpl. Incl. Primary gear	1
10	0888040050	woodruff key DIN 6888 4x5x13	1
11	635300820001	Main Bearing blue	x
11	635300820002	Main Bearing red	x
12	635301820001	Main Bearing blue	x
12	635301820002	Main Bearing red	x

186353060

53955

\* NEW PART

X ON DEMAND



# CLUTCH

Engine 890 Duke 2023

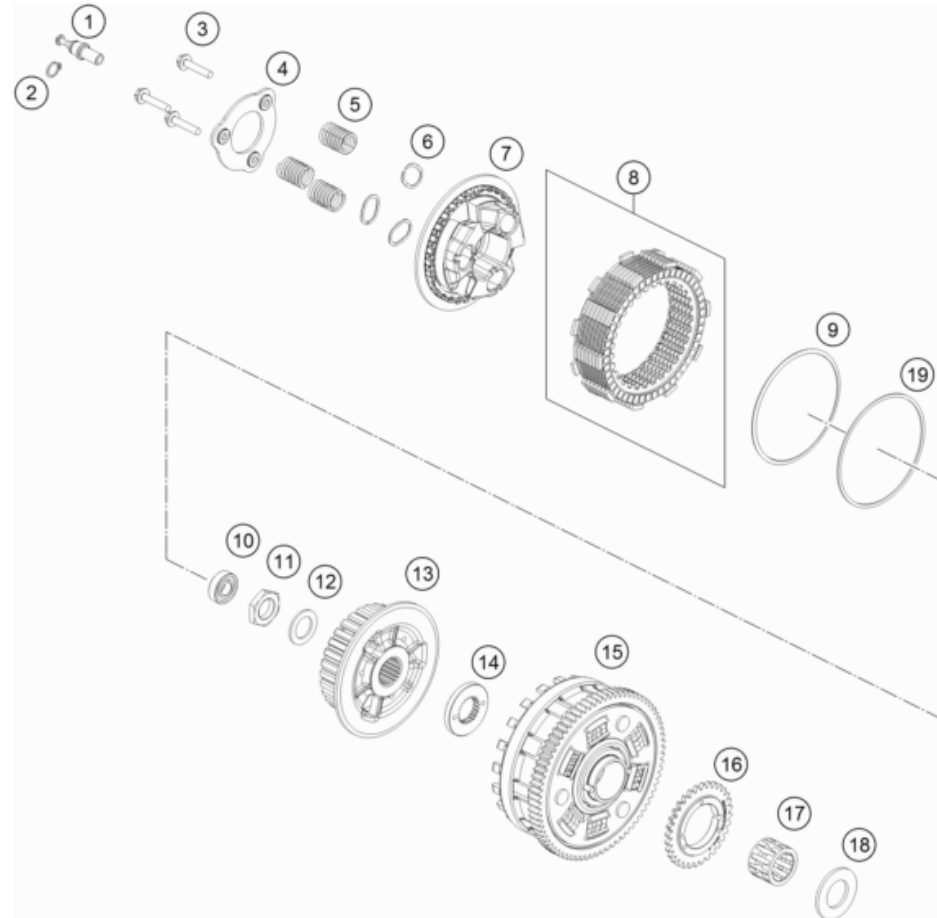

POS	PARTNUMBER	PARTNAME	PIECE
1	63532048104	tension bolt	1
2	0471120010	retaining ring DIN 471 12x1	1
3	63532044000	Collar screw M6x30	3
4	63532006000	Arrestor Pressure Cap	1
5	63532005000	Clutch spring	3
6	63532041000	Clutch spring cover	3
7	63532003000	Pressure Plate	1
8	63632011010	Disc Pack	1
9	63532034000	Belleville Spring	1
10	0625060017	BALL BEARING 6001.2URS.C3	1
11	60036073150	hex nut M20x1., H=6mm	1
12	0252012103100	Wedge lock washer HLS 20	1
13	63532002000	center clutch	1
14	63532021000	Spline Washer	1
15	63532001044	Clutch Cage cpl.	1
16	60038001232	Oil pump gear 32th	1
17	0405263525	Needle bearing PK26x35x24.8	1
18	63532020000	washer 26X47X3	1
19	63532035000	Seat Judder Spring	1

186353210

55621

\* NEW PART

X ON DEMAND

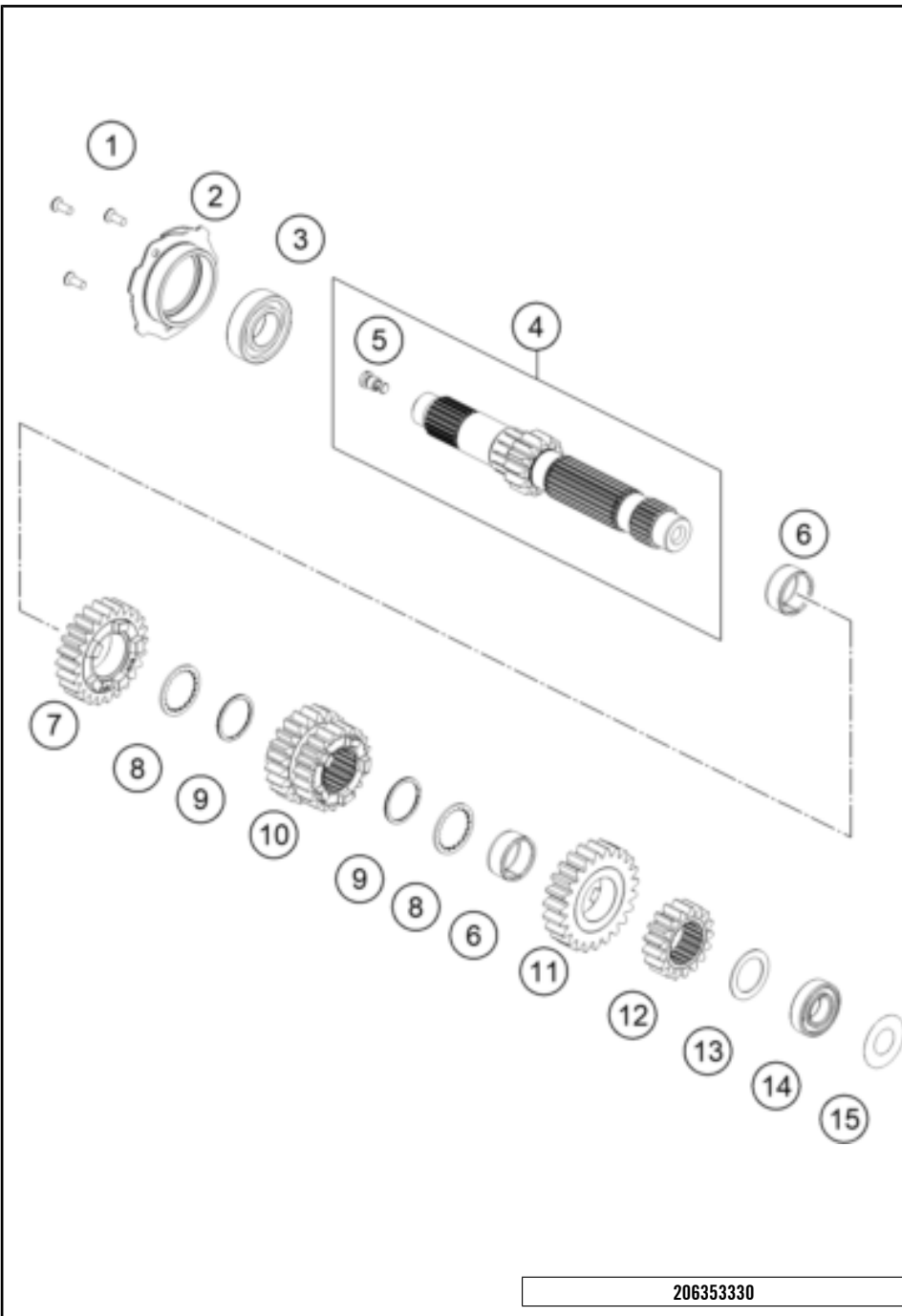

POS	PARTNUMBER	PARTNAME	PIECE
1	010642060166S	Hex screw ISO10642-M6x16 self-locking	3
2	63530168000	Bearing flange	1
3	0006252801600	Grooved ball bearing 62/28 C3	1
4	63633001044	Main shaft preassembled	1
5	63533001030	reducing jet Ø0.3mm M8	1
6	0405242813G	NEEDLE BEAR.K 24X28X13 DIVIDED	2
7	63633005000	Idle gear 5th gear	1
8	63533045000	toothed washer	2
9	0471026000	circlip d26	2
10	63633003000	Sliding gear 3rd/4th gear	1
11	63633006000	Idle gear 6th gear	1
12	63533002000	Solid gear 2. G	1
13	63533032000	stop disc 22.2/31.7/1	1
14	0625068910	Ball bearing 6891 PH C3H	1
15	63533088000	sealing washer 22x44x0.2	1

206353330

57775

\* NEW PART X ON DEMAND

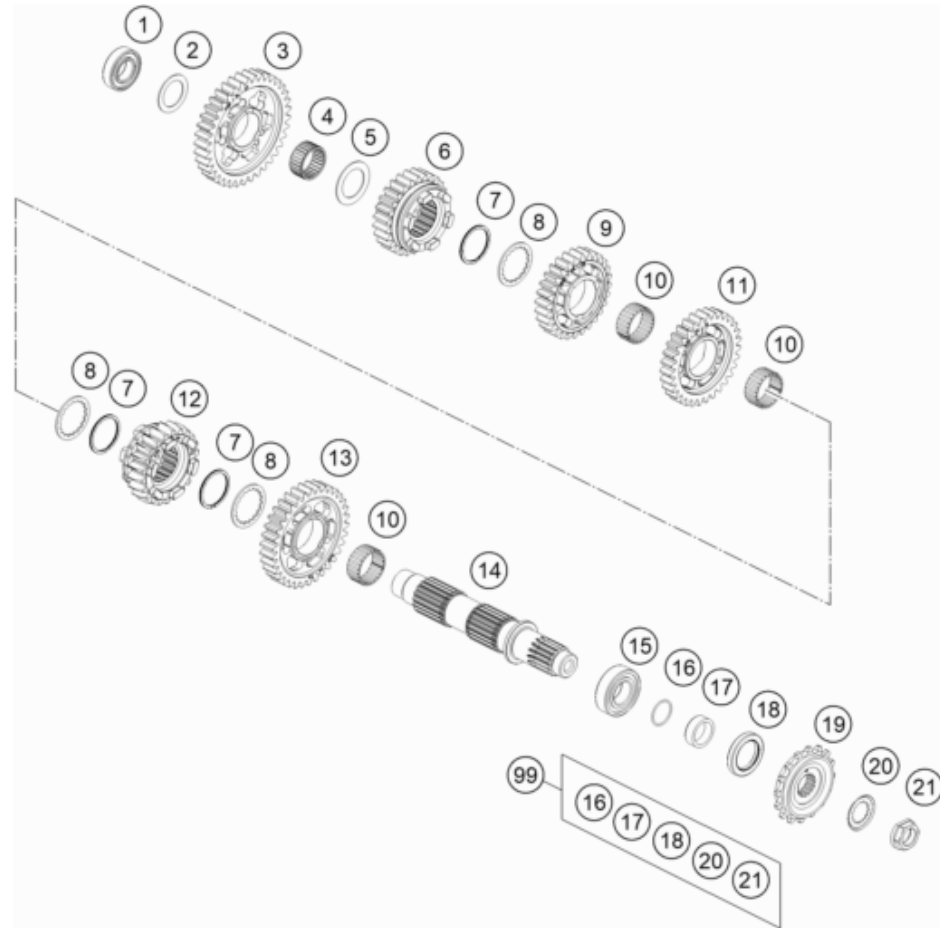

POS	PARTNUMBER	PARTNAME	PIECE
1	0625068910	Ball bearing 6891 PH C3H	1
2	63533032000	stop disc 22.2/31.7/1	1
3	63533011000	Idler Gear 1. G	1
4	0405242813	NEEDLE BEAR. K 24X28X13 TN	1
5	63533034000	stop disc 24.3/35.75/1	1
6	63633015000	Sliding gear 5th gear	1
7	0471029000	TWISTED CIRCLIP D29	3
8	63533033000	Stop Disc 27/36/1.5	3
9	63633014000	Idle gear 4th gear	1
10	0405263013G	needle bearing 26x30x13 splite	3
11	63633013000	Idle gear 3rd gear	1
12	63633016000	Sliding gear 6th gear	1
13	63533012000	Idler Gear 2. G	1
14	63533010000	Output shaft	1
15	49030023000	cylindrical roller bearing NJ205	1
16	0770020220	O-RING 25,12X1,78 NBR70	1
17	63533030011	Wear bushing, sprocket 11 mm	1
18	0760003247000	Shaft seal ring 32x47x7 AS-P FPM80	1
19	58033029116	front sprocket 16 teeth damped	1
20	51033031000	locking plate	1
21	58033132300	Sprocket nut M20x1.5	1
99	00050000992	Repair kit output shaft	x

186353360

53983

\* NEW PART

X ON DEMAND

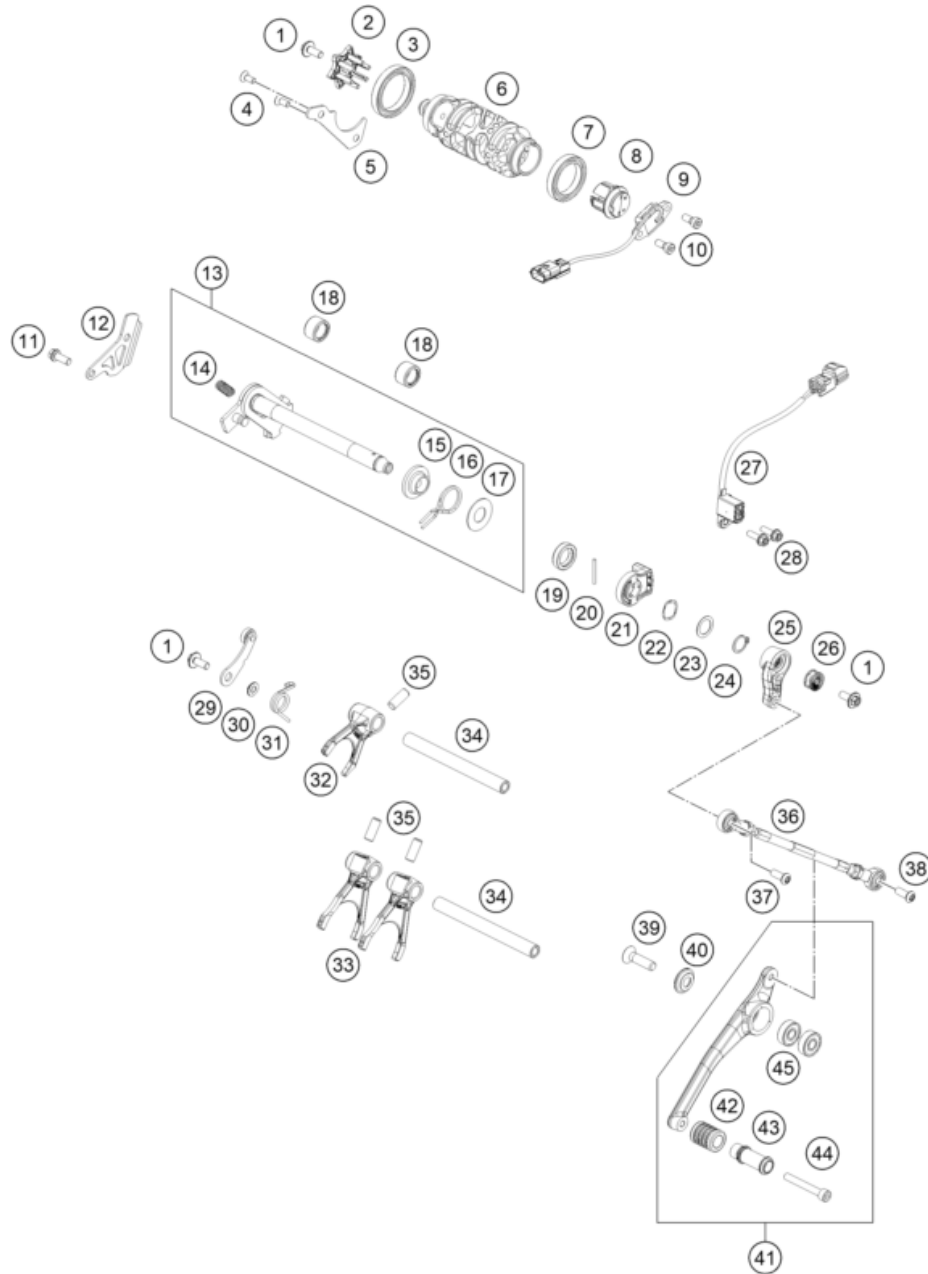

206353411

POS	PARTNUMBER	PARTNAME	PIECE
1	0024060156S	HH collar screw M6x15 TX30	1
2	63534115000	Shift star cmpl.	1
3	0625068070	deep groove ball bearing 6807	1
4	0019050121S	INT. TORX FLAT HEAD M5X12 T25	2
5	63534011200	Bearing retaining bracket	1
6	63534012001	shift drum 6G	1
7	0625068060	deep groove ball bearing 6806 C3	1
8	79234012020	magnet holder cpl.	1
9	79211023000	gear position sensor	1
10	0984050123S	CYLIND. SCR. DIN6912 M5X12 8.8	2
11	0025060166S	HH collar screw M6x16 TX30 SL	1
12	63533022000	bearing retaining plate	1
13	63534005033	shift shaft cpl.	1
14	56534013100	TENSIONING SPRING 0,8MM	1
15	54634020000	SPRING GUIDE	1
16	61234014000	RETURNSPRING 2MM	1
17	54634050000	STOP DISK 14X30X1	1
18	54632095000	needle sleeve HK 1412 14x20x12	2
19	0760142460	radial shaft seal 14x24x6 B	1
20	0007025241	dowel pin DIN 7 A1 2.5m6x24	1
21	63534050000	magnet holder	1
22	63534050010	wave spring Smalley SSB-0075-S17	1
23	0988142005	Thrust washer DIN 988 14x20x0.5	1
24	0471140100	retaining ring DIN 471 14x1	1
25	6413403000033	Pull Rod	1
26	50233041500	PAIR NORDLOCK WASHER M6	1
27	63534051000	Shift assistant sensor	1
28	0025060166S	HH collar screw M6x16 TX30 SL	2
29	63534024000	detent arm cpl.	1
30	63534052000	step washer	1
31	63634023000	Detent arm spring	1
32	63534002000	shift fork 5-6 gear	1
33	63534001100	Shift fork	2
34	75034019100	shift fork shaft	2
35	0402080200	needle roller D8x20	3
36	63634036044	Shift rod cmpl.	1
37	0738060205S	Oval head screw ISR M6x20-A2-70-MK	1
38	0738060165S	Rnd. hd. scr. TX M6x16 A2-70 S	1

61964

\* NEW PART

X ON DEMAND

# SHIFTING MECHANISM

Engine 890 Duke 2023

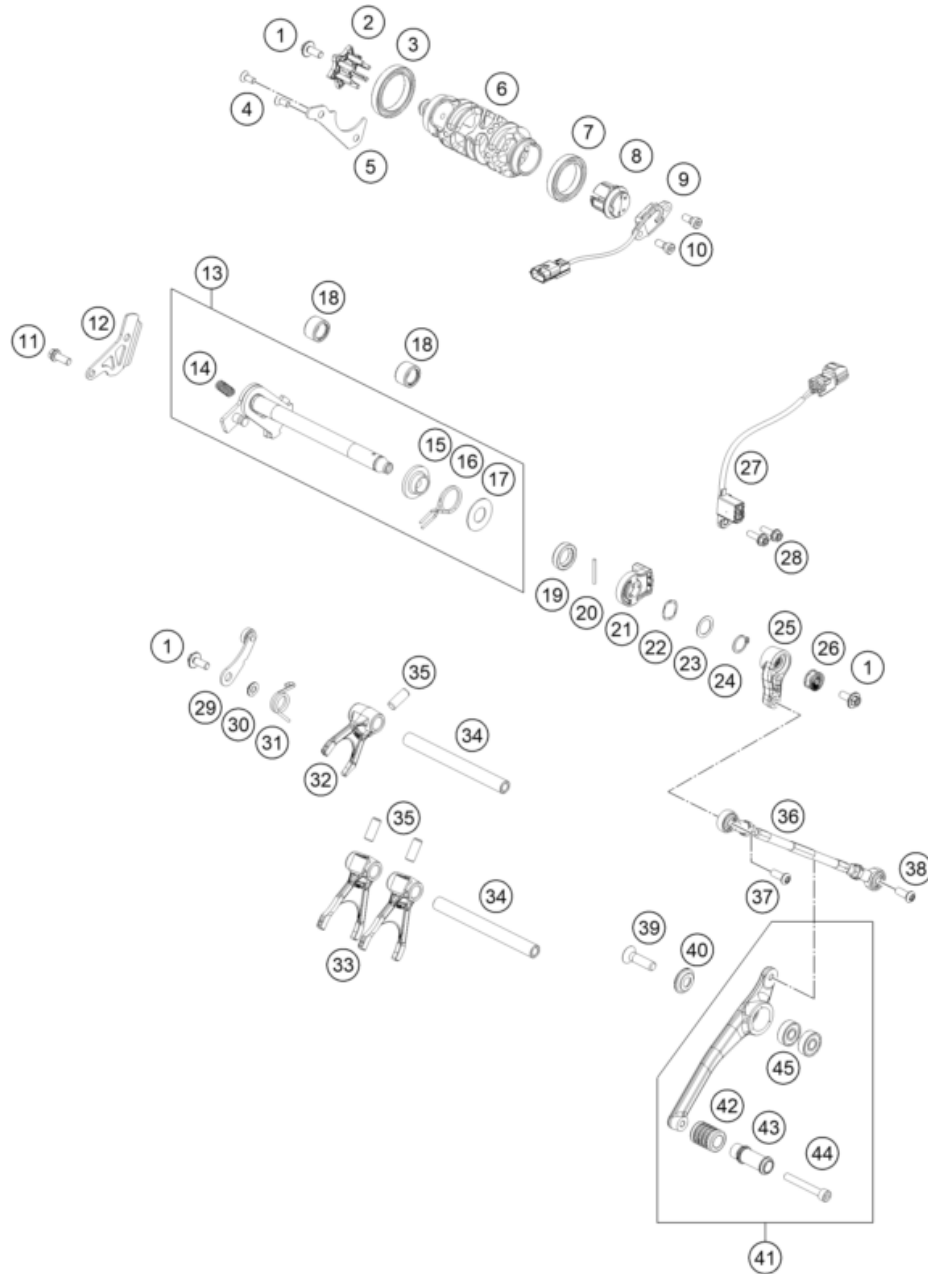

206353411

POS	PARTNUMBER	PARTNAME	PIECE
39	0019080306S	COUNTER-SUNK SCREW ISA45 M8X30	1
40	64134031020	Fasson Disc D=23x5	1
41	6413403104433	Gear lever kpl. black 890 Duke	1
41	63634031033C1	Gear shift lever, complete 890 Duke R	1
42	61034035000	RUBBER FOR SHIFT LEVER 05	1
43	69034032100	GEAR LEVER	1
44	0912060453S	Cap head screw ISO 4762-M6x45-8.8-MK	1
45	0625006087	GROOVED BALL BEAR. 608 2RS C3	2

61964

\* NEW PART

X ON DEMAND

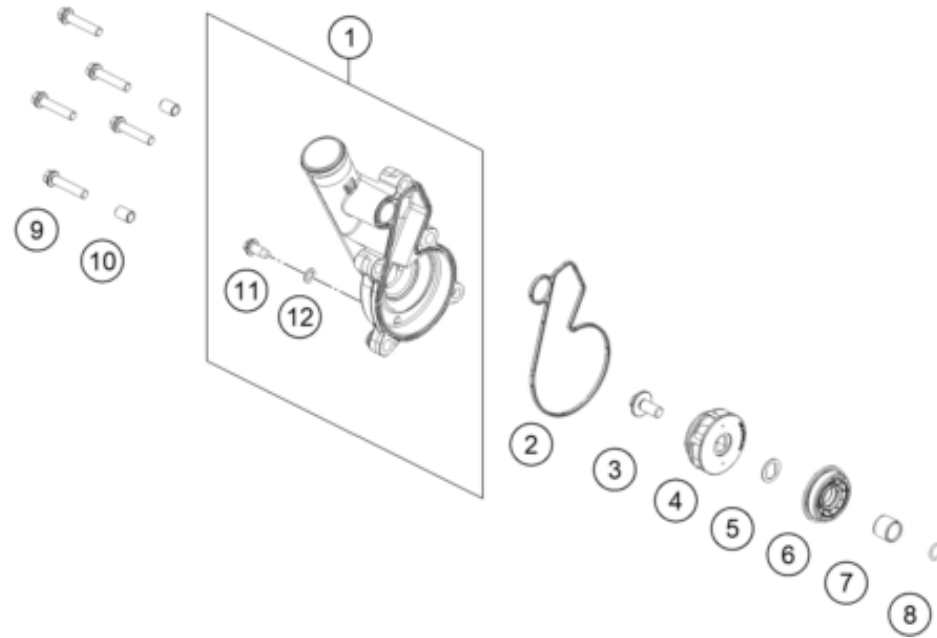

POS	PARTNUMBER	PARTNAME	PIECE
1	6353505200041	water pump cover	1
2	63535053000	water pump cover gasket	1
3	0024060136S	HH Collar screw M6x13 TX30 SL	1
4	63535055000	water pump wheel cpl.	1
5	60035055150	double-d washer 16x1 SST	1
6	0760153459	radial shaft seal 34.5x15x9 Duo	1
7	77236072020	water pump wear bushing	1
8	07700900151	O-RING 9x1,5 V80 SH	1
9	0025060306S	HH collar screw M6x30 TX30	5
10	59030023000	dowel sleeve 6x8x11.5	2
11	60335061000	Ejot Altracs Plus 60x14	1
12	0603061001	CU-SEAL RING DIN7603-6X10X1	1

186353510

49615

\* NEW PART

X ON DEMAND

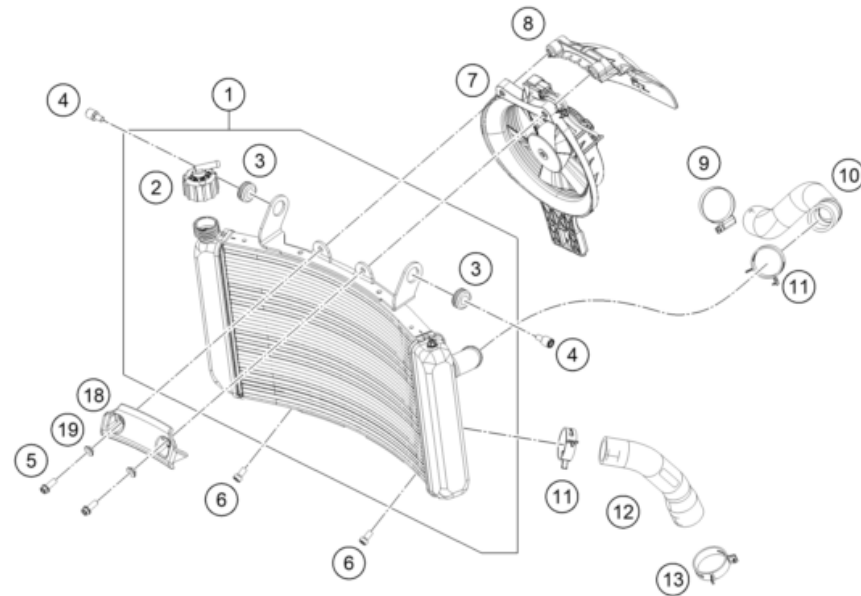
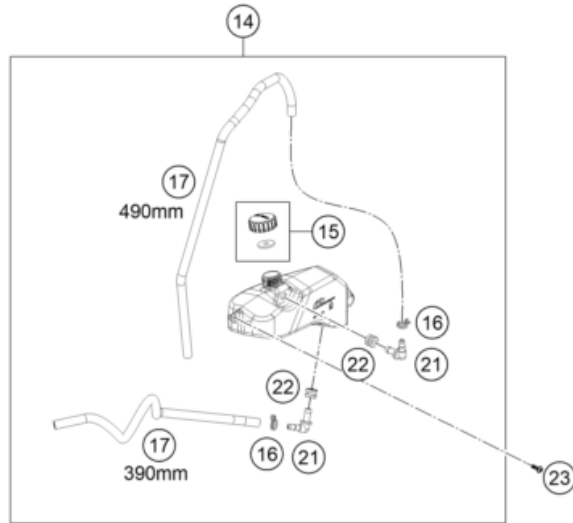

POS	PARTNUMBER	PARTNAME	PIECE
1	63635010100	Radiator	1
2	62535009000	RADIATOR CAP 1,4 BAR	1
3	41001052000	RUBBER SLEEVE D=12MM	2
4	69035001000	STUD BOLT M6 11X11 ISA45	2
5	0025060166S	HH collar screw M6x16 TX30 SL	2
6	014580060126	SHCS ISO 14580 M6x12	2
7	64135044033	Fan cover cpl.	1
8	63635042000	Air deflector, radiator	1
9	10001120000	CLAMP 25-40 SGT 4	1
10	63635027100	Pre-formed hose, radiator	1
11	00049320121	CLAMP STD DN32	2
12	63635026000	Pre-formed hose, radiator	1
13	00049380121	Spring band clamp STD DN38	1
14	63635065033	Reservoir, cpl.	1
15	60335066044	Latch, compens. tank cpl.	1
16	58007117000	YDNAC-CLAMP 10107 10MM	2
17	60035067001	HOSE 6X10 EPDM 03	x
18	64135032100	Edge protection radiator	1
19	69004060150	bushing chain protection	2
21	60035068000	ANGLE CONNECTION EXPANS. TANK	2
22	60035069000	RUBBER GROMMET 6X9X13MM 04	2
23	0081040121	EJOT Delta PT K40x12	1

206363530

57313

\* NEW PART

X ON DEMAND

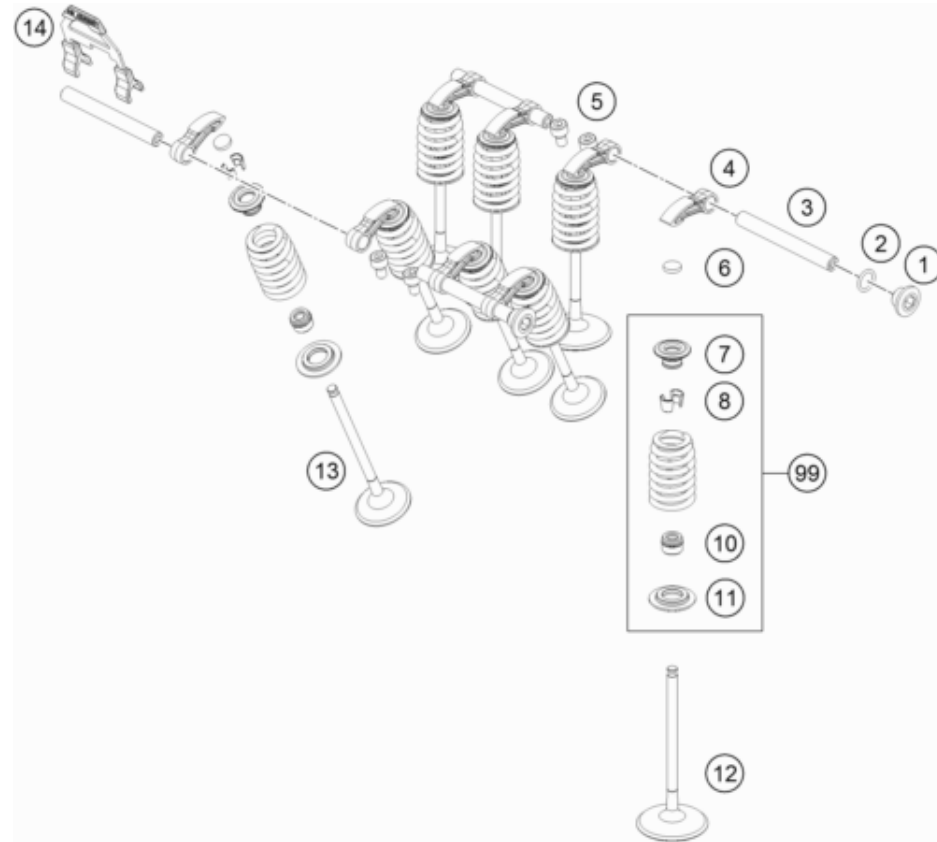

POS	PARTNUMBER	PARTNAME	PIECE
1	77236080100	threaded plug	2
2	07700900151	O-RING 9x1,5 V80 SH	2
3	63536056000	cam follower shaft	4
4	63536060000	Cam follower	8
5	014579050086S	Cap head screw, ISO 14579, M5x8-10.9	4
6	77036035172	SHIM D=8,9/1,72	x
6	77036035176	SHIM D=8,9/1,76	x
6	77036035180	SHIM D=8,9/1,80	x
6	77036035184	SHIM D=8,9/1,84	x
6	77036035188	SHIM D=8,9/1,88	x
6	77036035192	SHIM D=8,9/1,92	x
6	77036035196	SHIM D=8,9/1,96	x
6	77036035200	SHIM D=8,9/2,00	x
6	77036035204	SHIM D=8,9/2,04	x
6	77036035208	SHIM D=8,9/2,08	x
6	77036035212	SHIM D=8,9/2,12	x
6	77036035216	SHIM D=8,9/2,16	x
6	77036035220	SHIM D=8,9/2,20	x
6	77036035224	SHIM D=8,9/2,24	x
6	77036035228	SHIM D=8,9/2,28	x
6	77036035232	SHIM D=8,9/2,32	x
6	77036035236	SHIM D=8,9/2,36	x
6	77036035240	SHIM D=8,9/2,40	x
6	77036035244	SHIM D=8,9/2,44	x
6	77036035248	SHIM D=8,9/2,48	x
6	77036035252	SHIM D=8,9/2,52	x
6	77036035256	SHIM D=8,9/2,56	x
6	77036035260	SHIM D=8,9/2,60	x
7	63536032100	valve spring retainer	8
8	77036033000	valve collet	16
10	90236027000	valve stem seal	8
11	63536036000	Seat valve spring	8
12	63636130000	inlet valve	4
13	63636131000	exhaust valve	4
14	63536056050	cam follower clip	1
99	63636028044	VALVE SPRING KIT	x

186353610

55631

\* NEW PART

X ON DEMAND



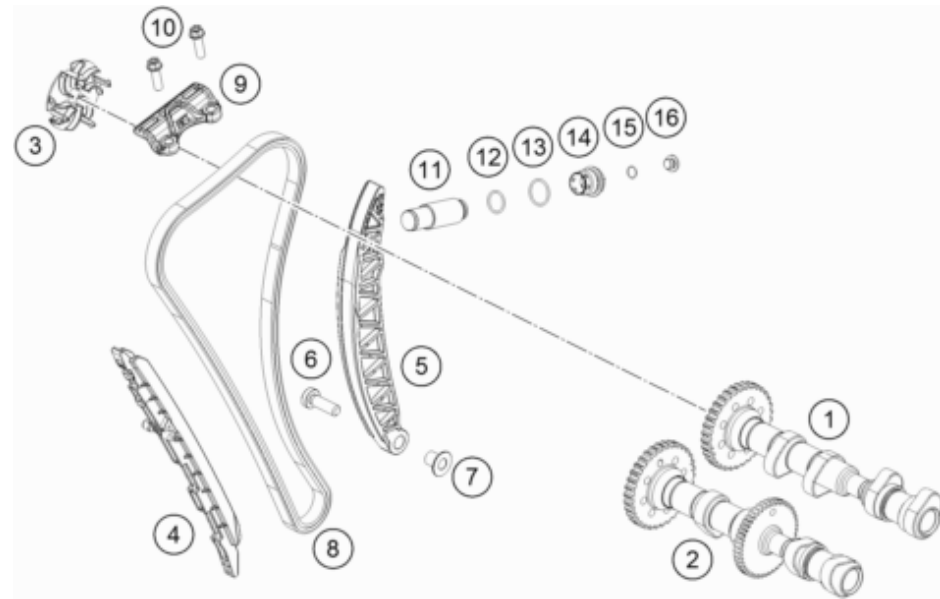

POS	PARTNUMBER	PARTNAME	PIECE
1	63636009044	Camshaft inlet valve cpl.	1
2	63636010044	Camshaft exhaust valve cpl.	1
3	63536080000	bleeder centrifuge	1
4	63536001000	slide bars	1
5	63636002000	Slide rail	1
6	0035080256S	ISA collar screw M8x25 ISA45	1
7	63536002150	Collar bush Ø8xØ10x13.2	1
8	63636013000	Timing chain	1
9	63536005000	slide bars, top cpl.	1
10	0025060206S	HH collar screw M6x20 TX30	2
11	77036003100	chain tension adjuster	1
12	0770180020	o-ring 18.00x2.00 NBR70	1
13	0770220020	o-ring 22.00x2.00 NBR70	1
14	61236008200	chain tension adjuster plug cpl.	1
15	0770010010	o-ring 10.00x1.00 NBR70	1
16	77236080100	threaded plug	1

186353620

53963

\* NEW PART

X ON DEMAND

# CYLINDER HEAD

Engine 890 Duke 2023

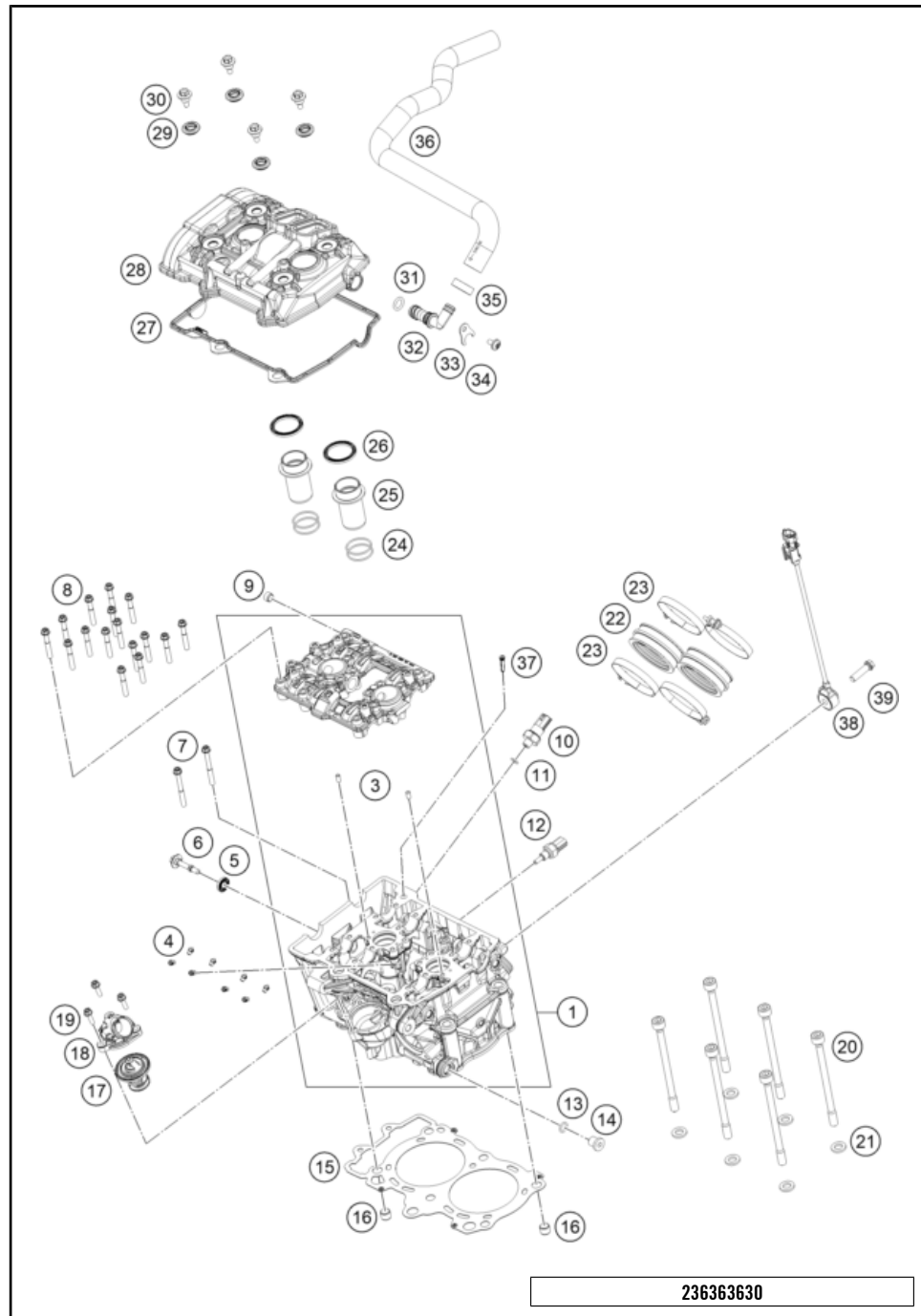

POS	PARTNUMBER	PARTNAME	PIECE
1	6363602000024	Cylinder head cpl.	1
3	0402050980	needle roller DIN 5402 5x9.8	2
4	60030063050	oil jet 50 M5	8
5	75036052010	decoupling element	1
6	75036055000	valve mechanism cover screw	1
7	0025060556	HH collar screw M6x55 TX30	2
8	0025060405	HH collar screw M6x40 ISA30	16
9	0906100100	pipe plug DIN 906 M10x1	1
10	61238091100	oil pressure switch "BITRON"	1
11	07700900151	O-RING 9x1,5 V80 SH	1
12	79435047000	water temperature sensor	1
13	0770100020	o-ring 10.00x2.00 silicone	1
14	0908120153	threaded plug DIN 908 M12x1.5	1
15	63630136000	Cylinder head gasket	1
16	58530014100	dowl sleeve 10.2x12.5x10	2
17	63635017000	Thermostat	1
18	63535019100	Water connection	1
19	0025050166S	HH Collar Screw M5x16 ISA30 SS	3
20	78630044000	cylinder head bolt M10x1.25 L=138	6
21	77336089010	washer 19x10.5x2.5	6
22	63536044000	Intake Sleeve	2
23	61236048000	hose clamp Gemi 66	4
24	0770298178	O-RING 29,87X1,78 VITON	4
25	63536075000	spark plug shaft insert	2
26	61136175050	Spark plug shaft seal	2
27	63536053000	Valve Cover Gasket	1
28	6353605200033	valve cover	1
29	77036054150	RUBBER GASKET FOR SCREW	4
30	77336054150	VALVE COVER SCREW	4
31	0770012030	O-RING 12,00X3,0 VITON 75	1
32	63536081000	bleeder connector	1
33	61236082150	connecting angle retaining plate	1
34	0080060123	EJOT Altracs 60x12 TX30	1
35	00050198706	VARIABLE ONE-EAR CLAMP 19,8MM	1
36	64130087200	Engine vent hose	1
37	61738016000	Oil screen	1
38	63641038000	Knock control sensor	1
39	0025080306	HH collar screw M8x30	1

236363630

61965

\* NEW PART X ON DEMAND

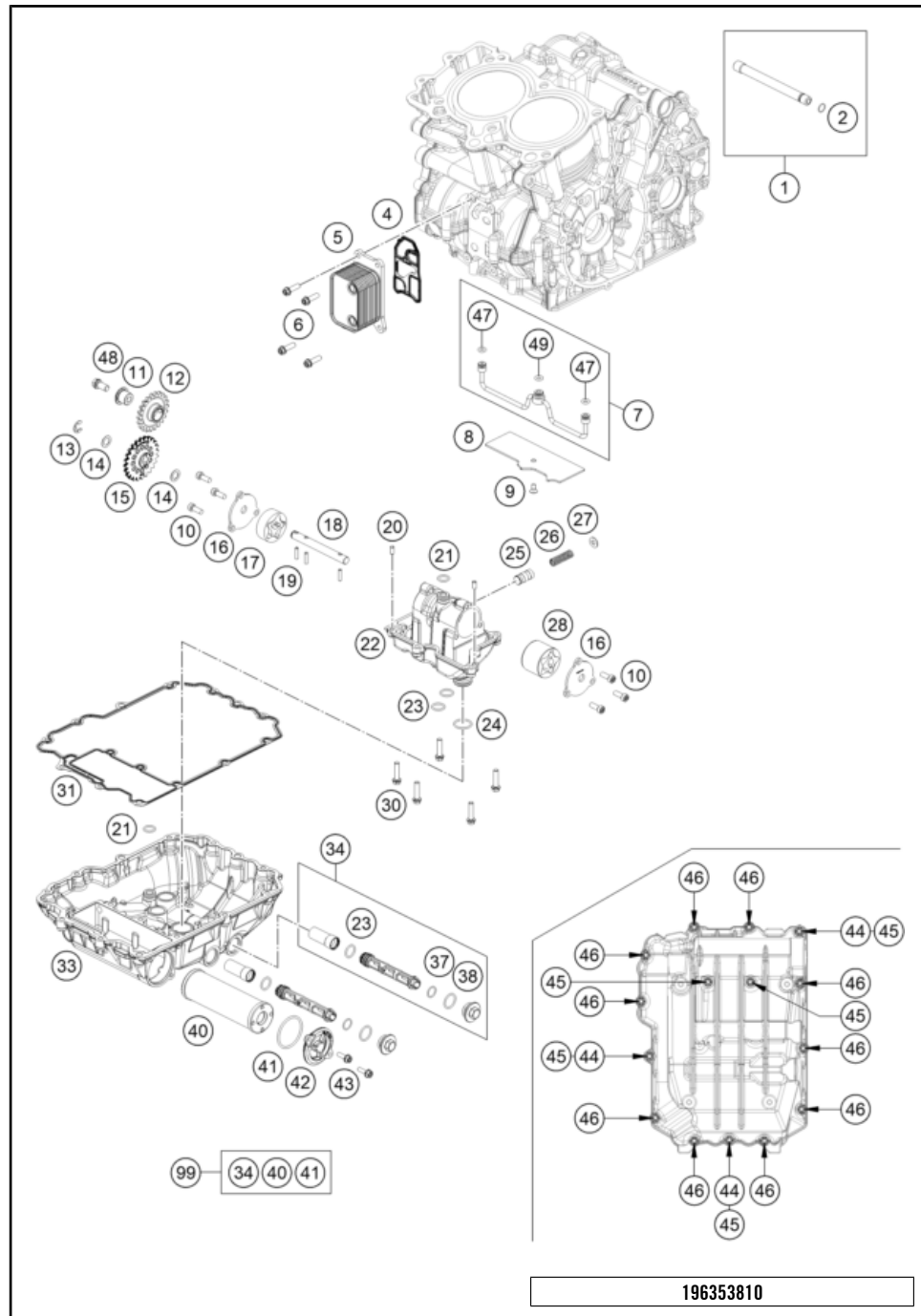

POS	PARTNUMBER	PARTNAME	PIECE
1	63530065000	Gearbox lubrication pipe compl.	1
2	0770010010	o-ring 10.00x1.00 NBR70	1
4	63538051000	gasket with support sheet	1
5	63638050000	Oil radiator, compl.	1
6	0025060206S	HH collar screw M6x20 TX30	4
7	63538035000	oil line	1
8	63530086010	pressure plate	1
9	0019050121S	INT. TORX FLAT HEAD M5X12 T25	1
10	014580060166S	SHCS ISO 14580 M6x16 SL	6
11	63638003000	Bearing bolt	1
12	63538001022	oil pump idler wheel 22 teeth cpl.	1
13	07990800000	retaining washer DIN 6799 - 8	1
14	60038007010	washer 10x16x0.5	1
15	60038001224	oil pump gear 24 teeth	1
16	63538008050	oil pump cover plate	2
17	60038011100	eaton pump set 14mm	1
18	63538002000	oil pump shaft	1
19	0402041580	needle roller NRB 4x15.8 G2	3
20	0402050980	needle roller DIN 5402 5x9.8	2
21	0770120020	O-RING 12,00X2,00 NBR 70	2
22	63538012000	Oil Pumphousing	1
23	0770140200	O-RING 14,00X2,00	4
24	0770020020	O-RING 20X2 VITON	1
25	60038128000	control piston	1
26	63538026000	oil pressure spring	1
27	50337073000	shim	1
28	61238010100	eaton pump set 30mm	1
30	0025060256	HH collar screw M6x25 TX30	5
31	63530086000	oil sump gasket	1
33	6353008500024	oil pan	1
34	61238021100	oil screen cpl.	2
37	0770125015	O-RING 12,5X1,5 NBR	2
38	0770170200	O-RING 17,00X2,00	2
40	61338015200	OIL FILTER	1
41	07700390261	O-RING 39,34X2,62	1
42	75038041200	oil filter cover	1
43	0025050166	HH collar screw M5x16 TX30	2
44	59030023000	dowel sleeve 6x8x11.5	3

196353810

53976

\* NEW PART X ON DEMAND

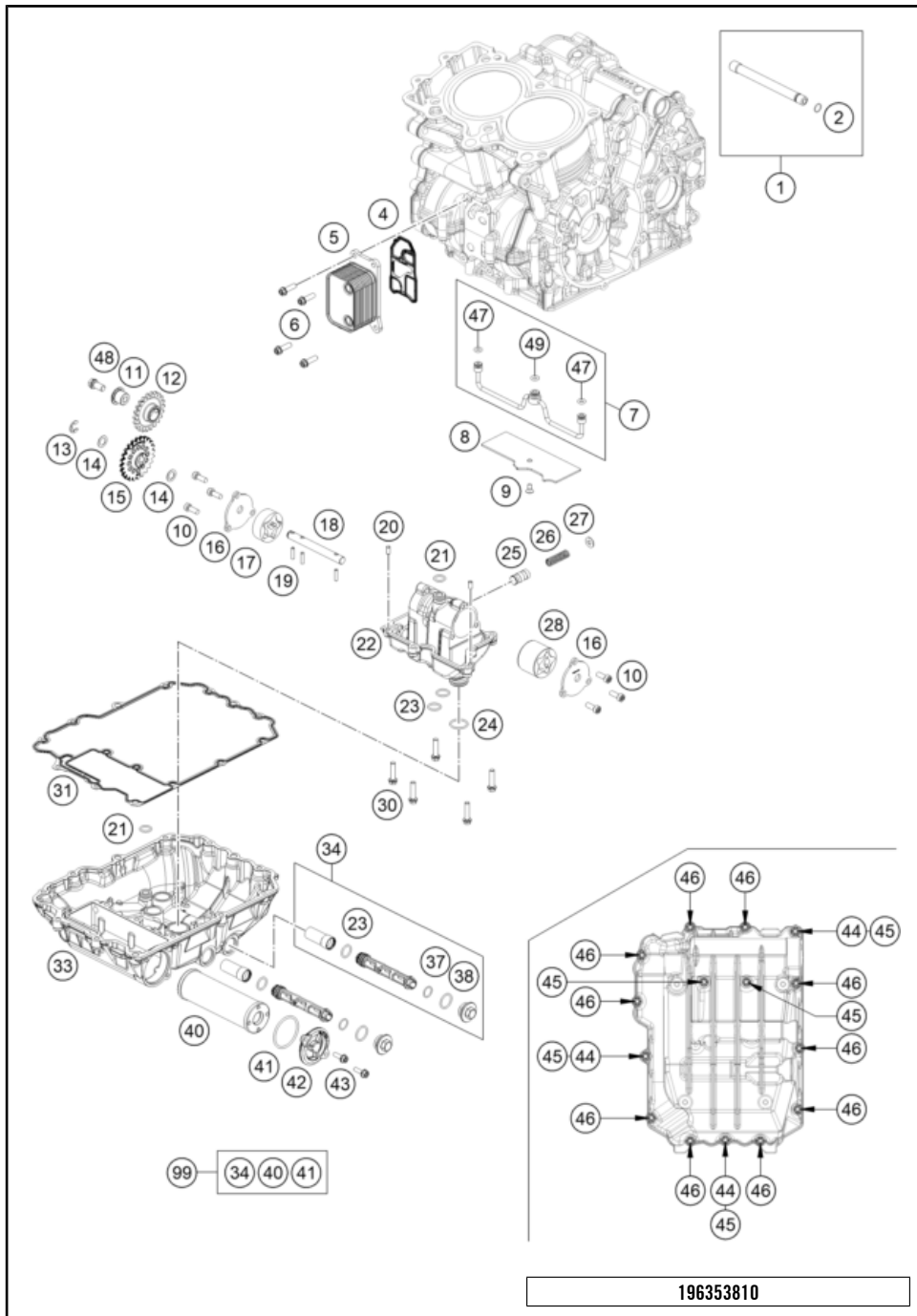

POS	PARTNUMBER	PARTNAME	PIECE
45	0025060356	HH collar screw M6x35 TX30	5
46	0025060306	HH collar screw M6x30 TX30	10
47	0770060025	O-Ring 6x2.5	2
48	0025080166S	HH collar screw M8x16 TX40 SL	1
49	0770070025	O-Ring 7x2,50 HNBR	1
99	00050000068	OILFILTER SERVICE KIT	x

196353810

53976

\* NEW PART X ON DEMAND

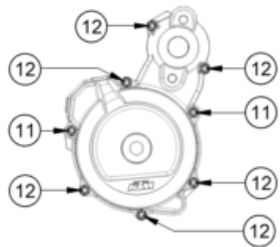
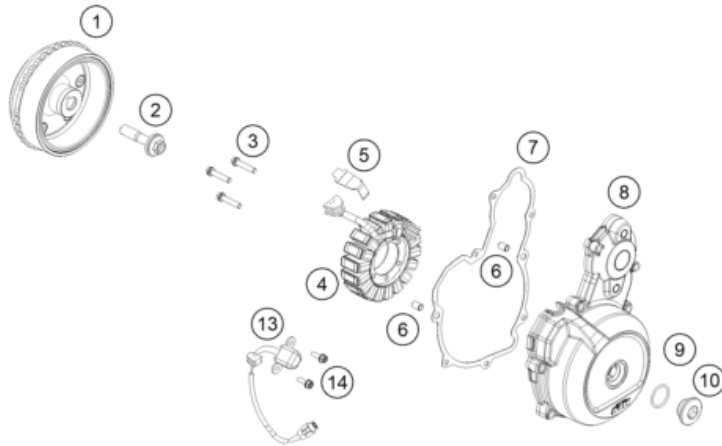
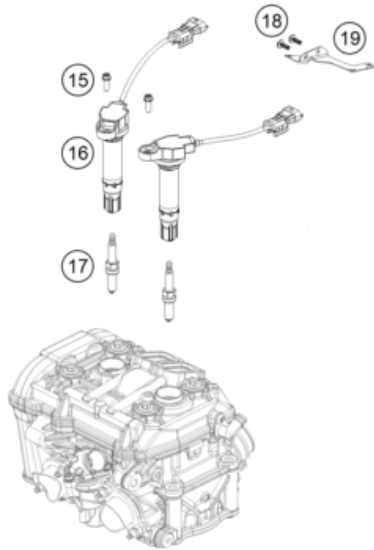

236363910

POS	PARTNUMBER	PARTNAME	PIECE
1	63539005200	Rotor	1
2	60339003000	special screw M12x1.5 WS15	1
3	0025060306S	HH collar screw M6x30 TX30	3
4	63539004200	Stator	1
5	60039040020	generator line bracket	1
6	59030023100	Dowel, 6x8x11.5	2
7	63530040000	ignition cover gasket	1
8	6353000200041	Generator Cover	1
9	07700240251	o-ring 24.00x2.50 Viton	1
10	6003009400030	threaded plug M24x1.5 PA 6.6	1
11	0025060356	HH collar screw M6x35 TX30	2
12	0025060306	HH collar screw M6x30 TX30	6
13	59039034000	pulse generator KOKUSAN 4K3-A/B	1
14	0025050166S	HH Collar Screw M5x16 ISA30 SS	2
15	0025060166	HH collar screw M6x16 TX30	2
16	63539006000	stick coil	2
17	77839093000	spark plug	2
18	0081050141	EJOT PT screw K50x14	2
19	64111038000	Retaining bracket stick coil connector	1

61966

\* NEW PART

X ON DEMAND

# ELECTRIC STARTER

Engine 890 Duke 2023

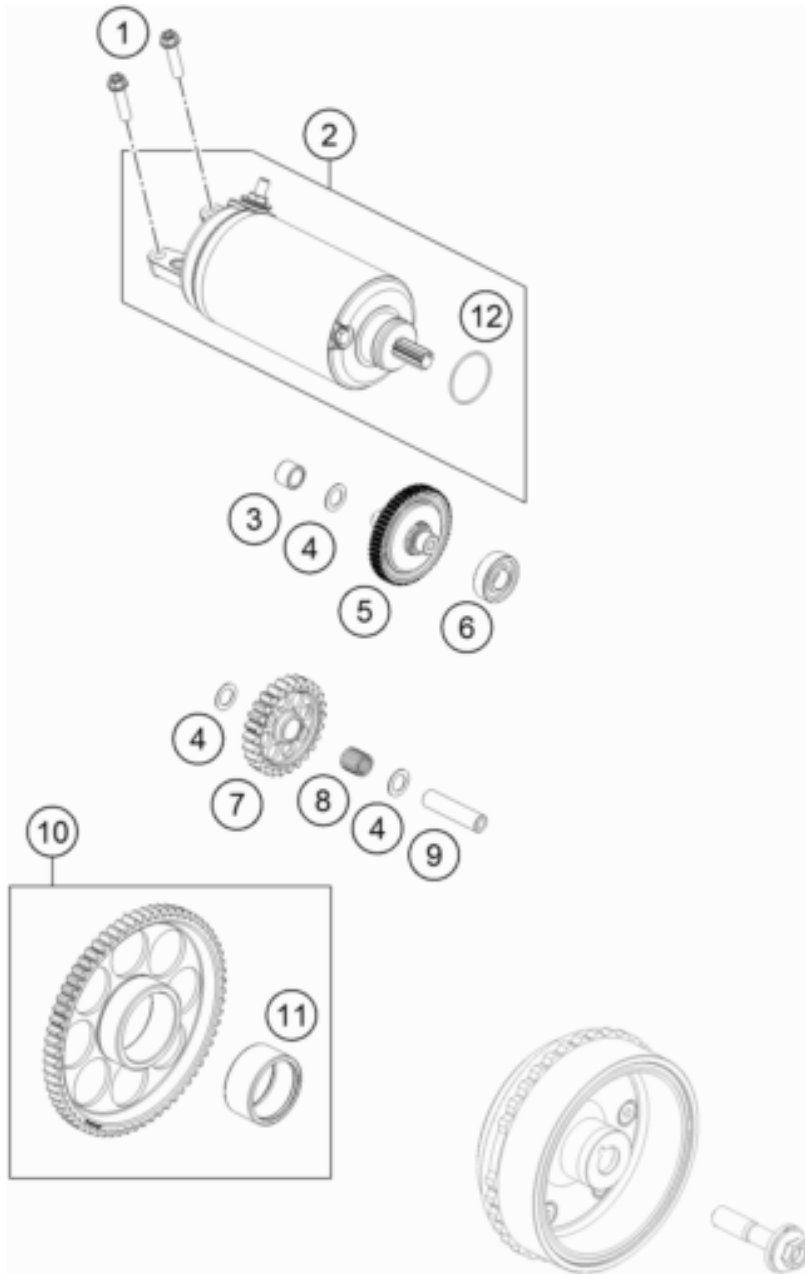

POS	PARTNUMBER	PARTNAME	PIECE
1	0025060256	HH collar screw M6x25 TX30	2
2	63540001000	starter	1
3	0618101410	needle sleeve HK 1010 10x14x10	1
4	60038007010	washer 10x16x0.5	3
5	60340117200	Torque limiter 10/55 cpl.	1
6	0625060016	deep groove ball bearing 6001.2RSR C3	1
7	63540022000	idler gear 26 teeth	1
8	58440090000	needle roller and cage K 10x13x13 TN	1
9	63540029000	pivot pin	1
10	63540020000	free wheel gear cpl.	1
11	0618354220	NEEDLE BUSH HK3520 35/42/20	1
12	0770244031	O-Ring 24,40 x 3,10 NBR 70	1

186354010

53302

\* NEW PART

X ON DEMAND

# THROTTLE BODY

Engine 890 Duke 2023

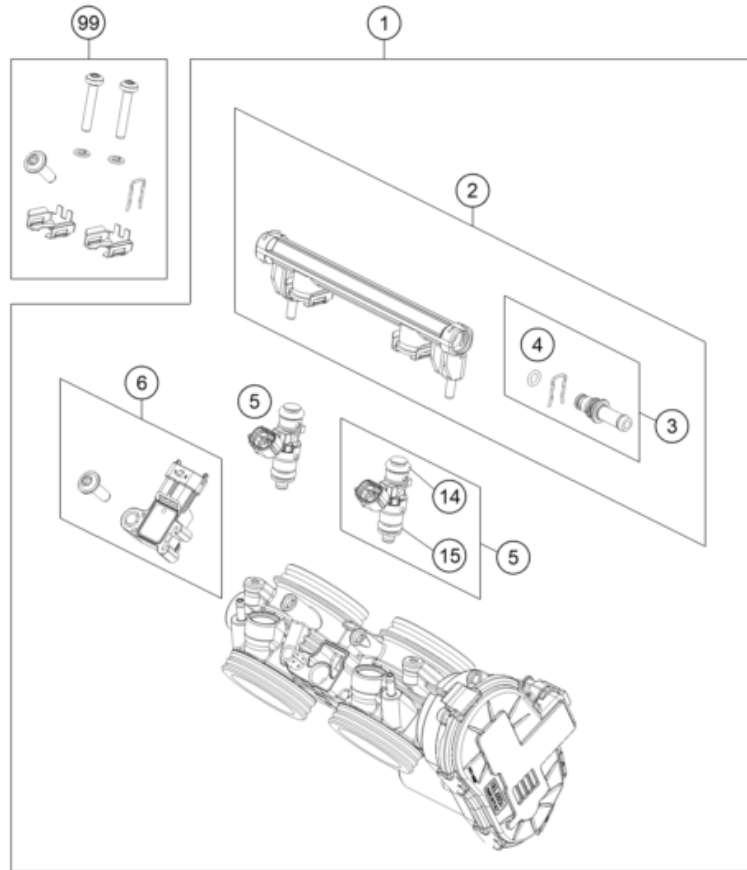

POS	PARTNUMBER	PARTNAME	PIECE
1	63641001000	Throttle valve body	1
2	63541013050	Fuel pipe	1
3	63541013044	Fuel connector cml.	1
4	63541013010	Square and dust seal	1
5	63641023044	Injektor	5
6	63641085044	MAP sensor, cml.	1
7	61236048000	hose clamp Gemi 66	4
8	63536044000	Intake Sleeve	2
9	0912040163S	AH screw DIN0912 M4x16 self-locking	4
10	63541031100	EFI control unit	1
11	64141030010	Collar Bushing 4.5x6x12x6.3	4
12	64141030000	Rubber grommet control unit	4
13	64141029000	Mounting Bracket ECU cpl.	2
14	55641023020	O-ring	2
15	55641023010	O-ring	2
99	63641099000	Smallpart kit	1

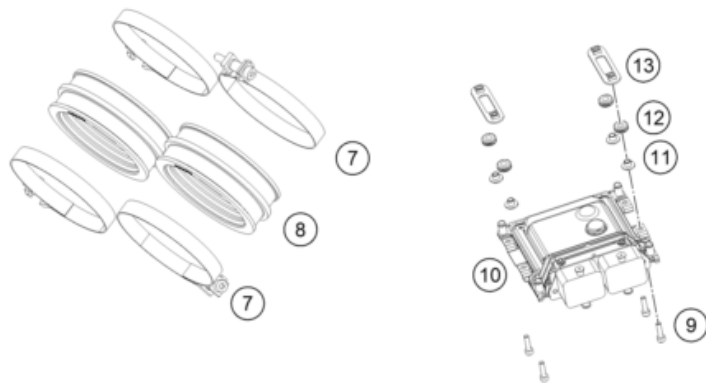

206364110

53986

\* NEW PART

X ON DEMAND

A large, empty rectangular box with a thin black border, occupying the majority of the page. It is intended for the user to write their notes.



A large, empty rectangular box with a thin black border, occupying the majority of the page. It is intended for the user to write notes related to the engine model mentioned in the header.

A large, empty rectangular box with a thin black border, occupying the majority of the page. It is intended for the user to write their notes.



# KTM.COM



088720WEN

KTM Sportmotorcycle GmbH  
5230 Mattighofen, Austria  
[www.ktm.com](http://www.ktm.com)

**KTM** POWERPARTS

**KTM** POWERWEAR

**KTM** ORIGINAL SPARE PARTS

