

OWNER'S MANUAL 2011

1190 RC8 R TRACK

Art. no. 3211609en



The KTM logo, consisting of the letters 'KTM' in a bold, italicized, sans-serif font, is positioned in the bottom right corner of the page against an orange background.

Congratulations on your decision to purchase a KTM motorcycle. You are now the owner of a state-of-the-art sports motorcycle that will give you enormous pleasure if you service and maintain it accordingly.

We wish you a lot of enjoyment in riding this vehicle.

Please enter the serial numbers of your vehicle below.

Vehicle identification number/type label (☛ p. 9)	Dealer's stamp
Engine number (☛ p. 9)	

The owner's manual contained the latest information for this model at the time of going to print. However, it is never possible to exclude small deviations arising from further development in design and construction.

All specifications are non-binding. KTM Sportmotorcycle AG specifically reserves the right to modify or delete technical specifications, prices, colors, forms, materials, services, designs, equipment, etc., without prior notice and without specifying reasons, to adapt these to local conditions, as well as to stop production of a particular model without prior notice. KTM accepts no liability for delivery options, deviations from illustrations and descriptions, as well as misprints and other errors. The models portrayed partly contain special equipment that does not form part of the regular scope of delivery.

© 2011 KTM-Sportmotorcycle AG, Mattighofen Austria

All rights reserved

Reproduction, even in part, as well as copying of all kinds, is permitted only with the express written permission of the copyright owner.



ISO 9001(12 100 6061)



















According to the international quality management standard ISO 9001, KTM uses quality assurance processes that lead to the maximum possible quality of the products.

Issued by: TÜV Management Service

REG.NO. 12 100 6061





KTM-Sportmotorcycle AG
5230 Mattighofen, Austria

MEANS OF REPRESENTATION	4	Hiding the external temperature display.....	34
IMPORTANT INFORMATION	5	Opening the filler cap	35
VIEW OF VEHICLE.....	7	Closing the filler cap.....	35
View of vehicle, front left side.....	7	Shift lever.....	35
View of vehicle, rear right side	8	Foot brake lever.....	36
SERIAL NUMBERS.....	9	PUTTING INTO OPERATION.....	37
Vehicle identification number/type label	9	Advice on first use.....	37
Engine number.....	9	Running the engine in.....	38
Fork part number.....	9	RIDING INSTRUCTIONS	39
Shock absorber part number	9	Checks and maintenance measures when preparing for	39
Steering damper part number	9	use	39
CONTROLS	10	Starting.....	39
Clutch lever	10	Refueling.....	40
Hand brake lever	10	SERVICE SCHEDULE.....	41
Throttle grip.....	10	Service schedule	41
Emergency OFF switch.....	10	TUNING THE CHASSIS.....	43
Electric starter button	10	Adjusting the compression damping of the fork	43
Quick shifter switch	11	Adjusting the rebound damping of the fork.....	43
Combination instrument - overview.....	11	Adjusting the spring preload of the fork	44
Combination instrument - function buttons on	11	Compression damping of the shock absorber	44
handlebar	11	Adjusting the low-speed compression damping of the	44
Combination instrument - activation and test	12	shock absorber	44
Display.....	12	Adjusting the high-speed compression damping of the	45
Info display.....	13	shock absorber	45
Indicator lamps.....	13	Adjusting the rebound damping of the shock absorber.....	45
Notes/warnings on the combination instrument.....	13	Adjusting the spring preload of the shock absorber 🏍️.....	45
Combination instrument - ROAD mode overview	15	Steering damper.....	46
Odometer menu, ODO/Trip 1	15	Adjusting the steering damper	46
Odometer menu, ODO/Trip 2	16	Vehicle level	47
FUELDISTANCE menu.....	16	Adjusting front vehicle level 🏍️.....	47
Next service menu, DISTANCE TO Next Service.....	17	Adjusting the vehicle level at the rear	48
Combination instrument - RACE mode overview.....	18	Footrest position.....	49
Remaining laps menu, LAPSTOGO	18	Adjusting the footrest position	49
Maximum lap speed menu, TOPSPEED	19	Adjusting the shift lever stub.....	49
LAP/BESTLAP/LastLap menu.....	19	Adjusting the shift lever	50
Maximum speed menu, LAP/BESTLAP/TopSpeed	20	Adjusting the foot brake lever stub	50
Total distance in Race mode menu, RACEODO.....	20	Adjusting the foot brake lever	51
Combination instrument - SET-UP mode.....	21	Handlebar height.....	51
SET-UP menu	21	Adjusting the handlebar height	52
Mode menu, CHANGE MODE	22	SERVICE WORK ON THE CHASSIS.....	54
Time menu, SET CLOCK	22	Raising the rear of the motorcycle with lifting gear.....	54
SETTINGS menu	23	Removing the rear of motorcycle from the lifting gear.....	54
Shift warning lamp menu, SHIFT RPMS	23	Raising the front of the motorcycle with lifting gear	54
Blank time menu, LAP, LAP BLANK TIME button.....	24	Taking the motorcycle off of the front wheel stand	54
Number of laps menu, SET NUM LAPS	24	Bleeding the fork legs	55
Fuel reserve display menu, TRIP F RESET	25	Removing the seat.....	55
UNITS menu.....	25	Fitting the seat.....	55
Kilometers/miles menu, SET KM/MILES	26	Removing the air filter 🏍️.....	55
Temperature display menu, SET °C/°F	26	Installing the air filter 🏍️.....	56
Additional functions menu, OPTIONS.....	27	Cleaning the air filter 🏍️.....	56
Tire pressure monitor menu, TPMS	27	Removing the left side cover.....	57
External temperature display menu, OPTION OUTTEMP....	28	Installing the left side cover	57
Displaying lap times	31	Removing the right side cover	57
Displaying maximum speed	31	Installing the right side cover.....	57
Setting ROAD or RACE mode.....	31	Removing the exhaust cover	58
Setting the clock with SET CLOCK	31	Installing the exhaust cover	58
Adjusting shift speed RPM1/2	32	Removing the fuel tank 🏍️.....	58
Setting the blank time of the LAP button	32	Installing the fuel tank 🏍️.....	59
LAP BLANK TIME	32	Checking the fuel overflow reservoir.....	61
Setting the number of laps SET NUM LAPS	33	Emptying the fuel overflow reservoir	61
Setting the kilometers/miles SET KM/MILES.....	33	Checking for chain dirt.....	61
Setting the temperature unit SET °C/°F	34	Cleaning the chain.....	61

Checking the chain tension	62	TECHNICAL DATA - ENGINE TIGHTENING TORQUES	97
Adjusting the chain tension	62	TECHNICAL DATA - CHASSIS	99
Checking the chain, rear sprocket and engine sprocket.....	63	Tires	99
Adjusting basic position of clutch lever.....	64	Capacity - fuel.....	100
Checking fluid level of hydraulic clutch	64	TECHNICAL DATA - FORK.....	101
Correcting fluid level of hydraulic clutch	65	TECHNICAL DATA - SHOCK ABSORBER	102
BRAKES	66	TECHNICAL DATA - CHASSIS TIGHTENING TORQUES	103
Checking the front brake discs.....	66	WIRING DIAGRAM	106
Checking the rear brake disc.....	66	Page 1 of 6.....	106
Adjusting the basic position of the hand brake lever.....	66	Page 2 of 6.....	108
Checking the front brake fluid level	67	Page 3 of 6.....	110
Adding brake fluid of front brake 	67	Page 4 of 6.....	112
Checking the front brake linings.....	68	Page 5 of 6.....	114
Checking the rear brake fluid level	68	Page 6 of 6.....	116
Adding rear brake fluid 	68	SUBSTANCES.....	118
Checking the rear brake linings.....	69	AUXILIARY SUBSTANCES.....	120
WHEELS, TIRES	70	STANDARDS.....	121
Removing the front frame sliders.....	70	INDEX.....	122
Installing the front frame sliders	70		
Removing the front wheel 	70		
Installing the front wheel 	71		
Removing the rear frame sliders.....	72		
Installing the rear frame sliders.....	72		
Removing the rear wheel 	72		
Installing the rear wheel 	73		
Checking rear hub cush drive 	74		
Checking the tire condition.....	74		
Checking the tire pressure.....	75		
ELECTRICAL SYSTEM	76		
Removing the battery 	76		
Installing the battery 	76		
Recharging the battery 	77		
Changing the main fuse	78		
Changing the fuses of individual power consumers.....	79		
COOLING SYSTEM	80		
Cooling system	80		
Checking the coolant level.....	80		
Filling cooling system compensating tank	80		
Adding coolant/bleeding the cooling system 	81		
TUNING THE ENGINE	83		
Checking the play in the throttle cable.....	83		
Adjusting the play in the throttle cable 	83		
Quick shifter	83		
Checking/tuning the position of the quick shifter 	84		
Positioning the quick shifter	86		
SERVICE WORK ON THE ENGINE	87		
Checking the engine oil level	87		
Changing engine oil and filter, cleaning oil screen 	87		
Draining engine oil, cleaning oil screens 	87		
Removing the oil filter 	88		
Installing the oil filter 	89		
Filling up with engine oil 	89		
Adding engine oil	90		
CLEANING, CARE	91		
Cleaning the motorcycle.....	91		
Storage.....	91		
Preparing for use after storage	92		
ENGINE CONTROL BLINK CODE	93		
TECHNICAL DATA - ENGINE	95		
Capacity - engine oil	95		
Capacity - coolant.....	96		

Symbols used

The following explains the meaning of specific symbols.

	Denotes an expected reaction (e.g. to a step or a function).
	Denotes an unexpected reaction (e.g. to a step or a function).
	All jobs marked with this symbol require specialist knowledge and technical understanding. In the interests of your own safety, have these jobs done in an authorized KTM-RC8 workshop! There, your motorcycle will be handled optimally by specially trained experts with the necessary special tools.
	Identifies a page reference (more information is provided on the specified page).

Formats used

The type formats used are explained here.

Specific name	Identifies a name.
Name[®]	Identifies a protected name.
Brand[™]	Identifies a trademark.

Use definition

KTM sport motorcycles are designed and built to withstand the normal stresses and strains of competitive use.



Info

The motorcycle may only be used in closed off areas remote from public road traffic.

Service

A prerequisite for perfect operation and prevention of premature wear is that the service, care and tuning work on the engine and chassis is properly carried out as described in the owner's manual. Poor suspension settings can cause damage and breakage to chassis components.

Use of the motorcycles under extreme operating conditions can lead to excessive component wear. For this reason, it may be necessary to service or replace worn parts before the limit specified in the service schedule is reached.

Pay careful attention to the prescribed running-in period and service intervals. Close adherence to these periods will significantly lengthen the service life of your motorcycle.

Warranty

The work prescribed in the service schedule must be carried out by an authorized KTM workshop only and confirmed in the customer's service record and in the **KTM dealer.net**; otherwise, all warranty claims will be void. No warranty claim can be met for damage resulting from manipulation and/or other changes to the vehicle.

Materials

The fuels and lubricants named in the owner's manual must be used according to specifications.

Spare parts, accessories

In the interests of your own safety, use only spare parts and accessories approved and/or recommended by KTM, and have these fitted in an authorized KTM-RC8 workshop. KTM accepts no liability for other products and any resulting damage.

Some of the spare parts and accessory products are specified in parentheses under the respective descriptions. Your KTM dealer will be glad to advise you.

You will find the current **KTM PowerParts** for your vehicle on the KTM website.

International KTM Website: <http://www.ktm.com>

Work rules

Special tools are necessary for some of the work. These are not included with the vehicle and can be ordered under the number in parentheses. Ex: valve spring compressor (59029019000)

During assembly, non-reusable parts (e.g. self-locking screws and nuts, seals and seal rings, O-rings, pins, lock washers) must be replaced by new parts.

If a thread lock (e.g. **Loctite**®) is used for screw connections, be sure to comply with the manufacturer's specific advice on its usage.

After disassembly, clean the parts that are to be reused and check them for damage and wear. Change damaged or worn parts.

Following repairs or servicing, the vehicle must be checked for operating safety.

Transport

Note

Danger of damage The parked vehicle may roll away or fall over.

- Always place the vehicle on a firm and even surface.

Note

Fire hazard Some vehicle components become very hot when the vehicle is operated.

- Do not park the vehicle near flammable or explosive substances. Do not place objects on the vehicle while it is still warm from being run. Always let the vehicle cool first.

- Switch off the ignition by pressing the emergency OFF switch into the position ☒.
- Secure the motorcycle against falling over or running away using straps or other suitable devices.

Environment

Motorcycling is a wonderful sport and we naturally hope that you can enjoy it to the full. However, it can also lead to problems with the environment and conflict with other persons. Responsible behavior in handling the motorcycle can help to avoid such problems and conflicts. To ensure the future of motorcycle sport, make sure you use the motorcycle legally, demonstrate a consciousness for the environment, and respect the rights of others.

Notes/warnings

Pay close attention to the notes/warnings.



Info

Various information and warning labels are affixed to the vehicle. Do not remove information/warning labels. If they are missing, you or others may not recognize potential hazards and may therefore be injured.

Grades of risks



Danger

Identifies a danger that will immediately and invariably lead to fatal or serious permanent injury if the appropriate measures are not taken.



Warning

Identifies a danger that is likely to lead to fatal or serious injury if the appropriate measures are not taken.



Caution

Identifies a danger that may lead to minor injuries if the appropriate measures are not taken.

Note

Identifies a danger that will lead to considerable machine and material damage if the appropriate measures are not taken.



Warning

Identifies a danger that will lead to environmental damage if the appropriate measures are not taken.

Owner's manual

- Be sure to read this owner's manual carefully and completely before taking your first ride. It contains useful information and tips to help you operate and handle your motorcycle. Only then will you learn how to best customize the motorcycle for your own use and how to protect yourself from injury. The owner's manual also contains important information on servicing the motorcycle.
- The owner's manual is an important component of the motorcycle and should be handed over to the new owner if the vehicle is sold.

View of vehicle, front left side



601394-10

- | | |
|---|--|
| 1 | Clutch lever (☛ p. 10) |
| 2 | Handwheel for the spring preload on the shock absorber |
| 3 | Engine oil fuel filler |
| 4 | Quick shifter (☛ p. 83) |
| 5 | Shift lever (☛ p. 35) |

View of vehicle, rear right side

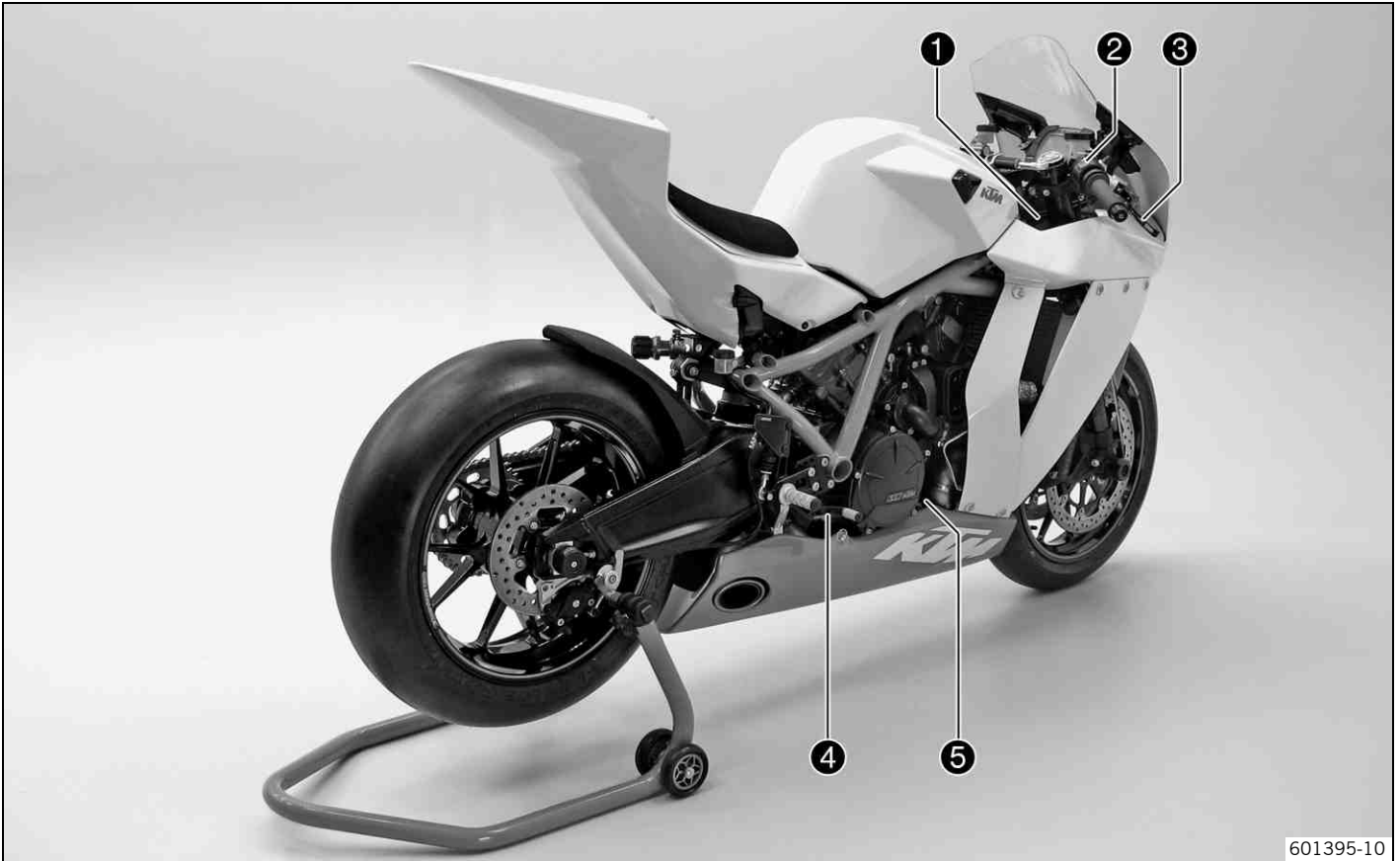

601395-10

- | | |
|---|---|
| 1 | Vehicle identification number/type label (☛ p. 9) |
| 2 | Emergency OFF switch (☛ p. 10) |
| 2 | Electric starter button (☛ p. 10) |
| 3 | Hand brake lever (☛ p. 10) |
| 4 | Foot brake lever (☛ p. 36) |
| 5 | Engine number (☛ p. 9) |

Vehicle identification number/type label

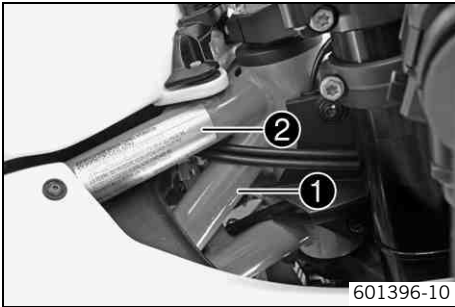

The vehicle identification number ❶ is stamped on the frame behind the steering head on the right.
The type label ❷ is on the frame above the chassis number.

Engine number

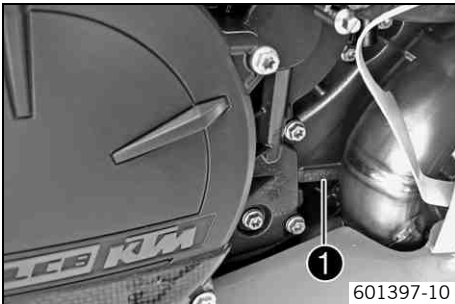

The engine number ❶ is stamped on the right side of the engine.

Fork part number

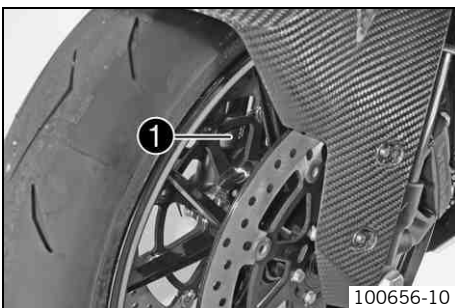

The fork part number ❶ is stamped on the inner side of the fork stub.

Shock absorber part number

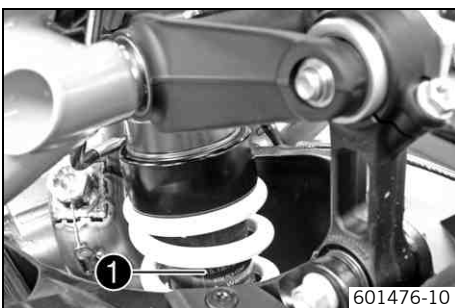

The shock absorber part number ❶ is shown on a sticker applied to the shock absorber case under the spring.

Steering damper part number



The steering damper part number ❶ is stamped on the top of the steering damper.

Clutch lever

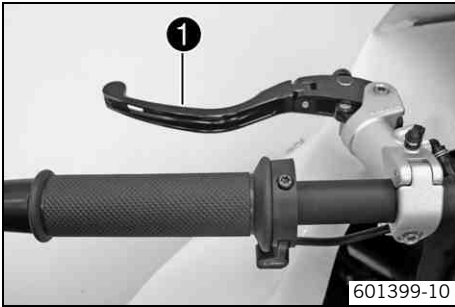

The clutch lever ❶ is fitted on the left side of the handlebar. The clutch is hydraulic and self-adjusting.

Hand brake lever



The hand brake lever ❶ is fitted on the right side of the handlebar. The hand brake lever operates the front brake.

Throttle grip

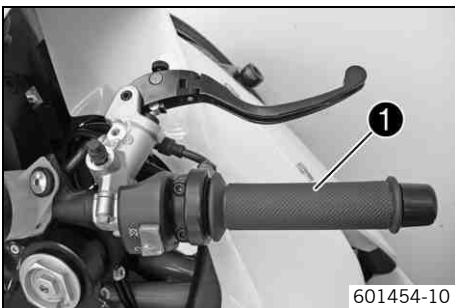

The throttle grip ❶ is fitted on the right side of the handlebar.

Emergency OFF switch

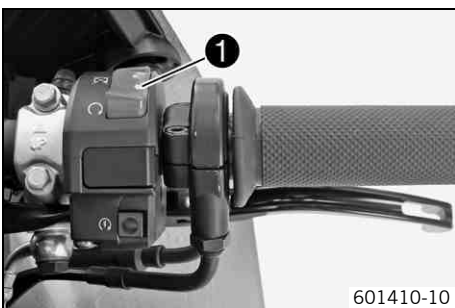

The emergency OFF switch ❶ is installed on the right side of the handlebar.

Possible states

	Emergency OFF switch (ignition) on – This setting is required for operation; all power consumers are supplied with current.
	Emergency OFF switch (ignition) off – In this position, the power supply to all power consumers is cut, a running engine stops, and a non-running engine cannot be started.

Electric starter button



The electric starter button ❶ is fitted on the right side of the handlebar.

Possible states

- Electric starter button ❷ in neutral position
- Electric starter button ❷ pressed – In this position, the electric starter is operated.

Quick shifter switch



The quick shifter switch ❶ is located on the left next to the combination instrument.

Possible states

- Quick shifter on – The quick shifter switch is flipped up.
- Quick shifter off – The quick shifter switch is flipped down.

Combination instrument - overview

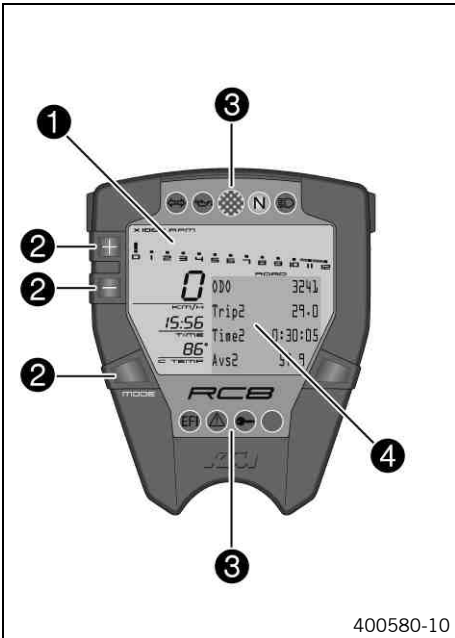

1 Display (☞ p. 12)

2 Function buttons

3 Indicator lamps (☞ p. 13)

4 Info display (☞ p. 13)

Combination instrument - function buttons on handlebar

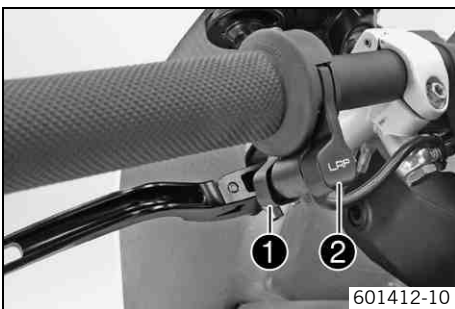

The **MODE** button ❶ is fitted on the handlebar, front left.

The **LAP** button ❷ is fitted on the handlebar, rear left.

MODE button

Changes to the next item on the info display in **ROAD** mode and in **RACE** mode.

LAP button

Changes to the next item in the info display in **ROAD** mode. Clocks the lap times in **RACE** mode.

Combination instrument - activation and test



400429-10

Activation

The combination instrument is activated when the emergency OFF switch is switched on.

Test

The segments of the tachometer light up and switch off in sequence.

The speed display counts from 0 to 300 and back.

The remaining display segments outside the info display light up briefly.

The **KTM** logo appears in the info display.

In **ROAD** mode, the info display switches to **ODO, Trip 1, Time 1, Avs 1** mode.

In **RACE** mode, the info display switches to **LAPSTOGO, LastLap, ±Last, ±Best** mode.

Display

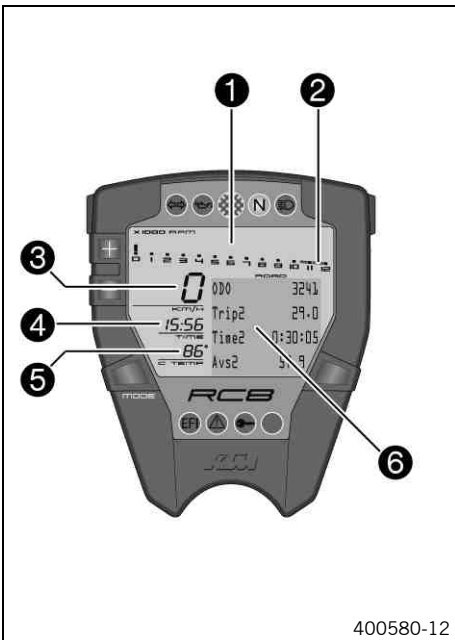

400580-12

The tachometer ❶ displays the engine speed in revolutions per minute (RPM).

The red marking ❷ marks the over-rev (excessive speed) range of the engine.

The speed ❸ is displayed in kilometers per hour **km/h** or in miles per hour **Mph**.

The time appears in segment ❹.

i Info

After reconnecting the battery or changing the fuse, the time must be reset.

The coolant temperature is shown in degrees Celsius or Fahrenheit in segment ❺.

The info display ❻ shows additional information.

Info display

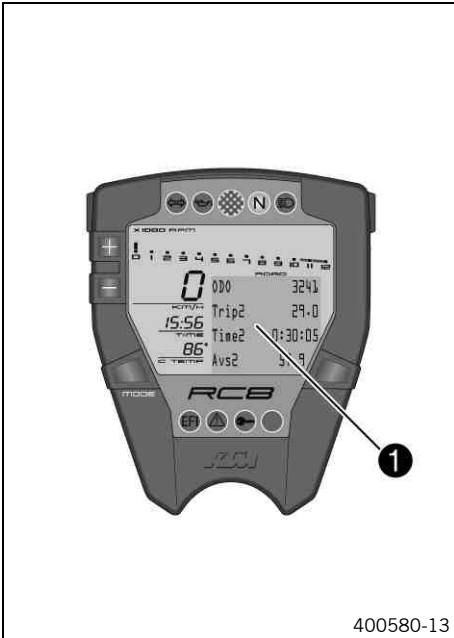

The info display ❶ has the **ROAD** mode and **RACE** mode menu interfaces. If the general warning lamp ⚠ lights up, the corresponding message is shown periodically on the info display.

Information repeat	45 s
--------------------	------

The information shown on the info display can be controlled with the function buttons.

Indicator lamps



Possible states

	The oil pressure warning lamp lights up red – The oil pressure is too low.
	The shift warning light lights up/flashes red – The set shift speed is reached.
	The idle speed indicator lamp lights up green – The transmission is shifted to idle.
	EFI warning lamp (MIL) lights up/flashes red – The OBD (on-board diagnosis) has detected an emission- or safety-critical error.
	The general warning lights up yellow – An operating safety (warning) message was detected. This is also shown periodically in the info display.
	Indicator lamp – No function
	Indicator lamp – No function
	Indicator lamp – No function

Notes/warnings on the combination instrument

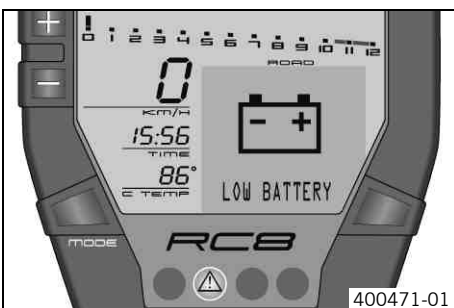

LOW BATTERY appears on the info display if the battery voltage falls below the specified value.

Battery voltage	10.80 V
-----------------	---------

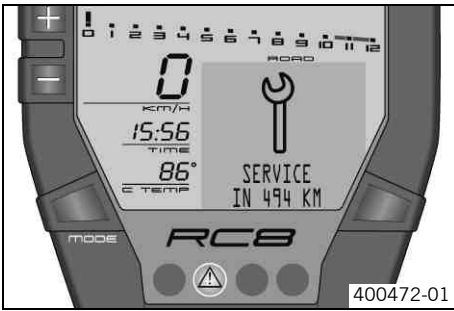

400472-01

SERVICE IN xxx KM(MPH) appears on the info display if the distance to the next service falls below the specified value.

Distance	500 km (310.7 mi)
----------	-------------------

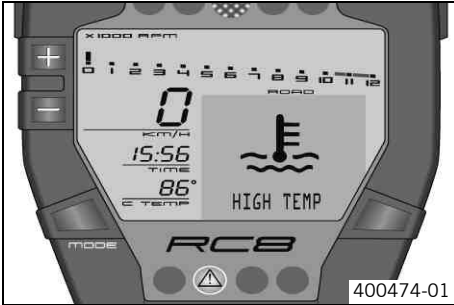

400474-01

HIGH TEMP appears on the info display if the coolant temperature rises above the specified value.

Coolant temperature	120 °C (248 °F)
---------------------	-----------------

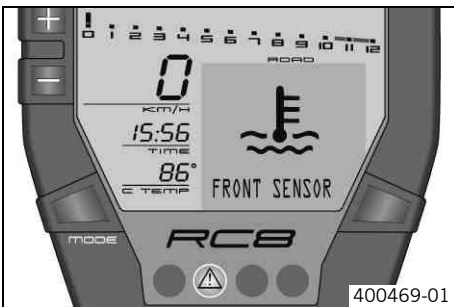

400469-01

FRONT SENSOR appears on the info display if the front cylinder coolant temperature sensor is faulty.

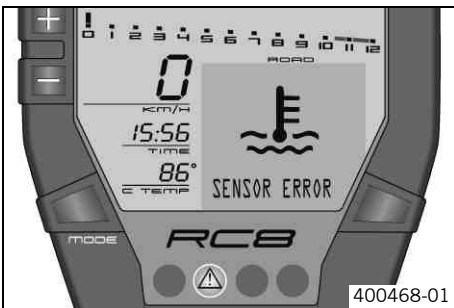

400468-01

SENSOR ERROR appears on the info display if the discrepancy between the front and rear cylinder coolant temperature sensor values is more than the specified value.

Coolant temperature	10 °C (50 °F)
---------------------	---------------

Combination instrument - ROAD mode overview

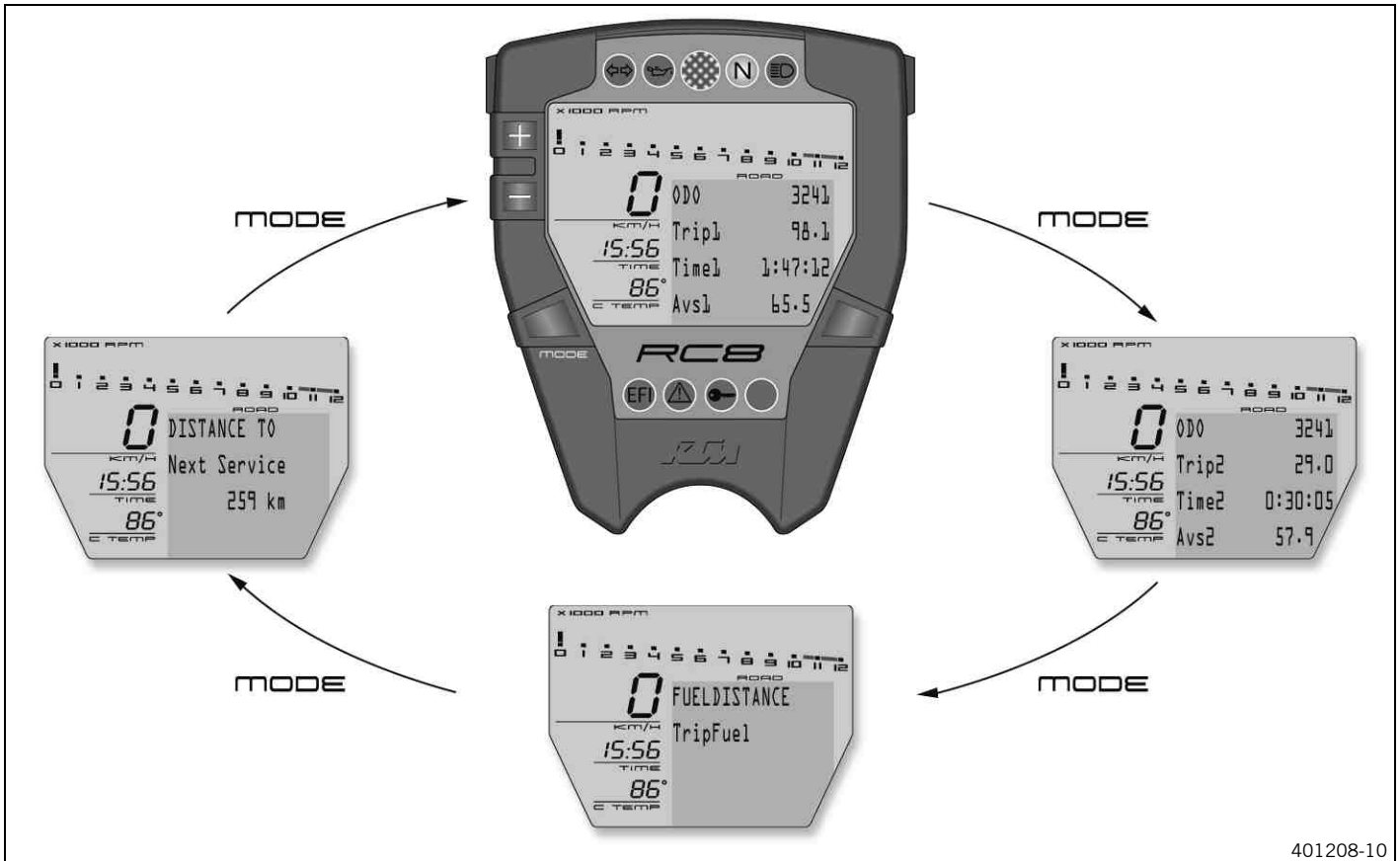

401208-10

Functions in ROAD mode

Odometer menu, **ODO/Trip 1**

Odometer menu, **ODO/Trip 2**

FUELDISTANCE menu

DISTANCE TO Next Service menu

Odometer menu, ODO/Trip 1

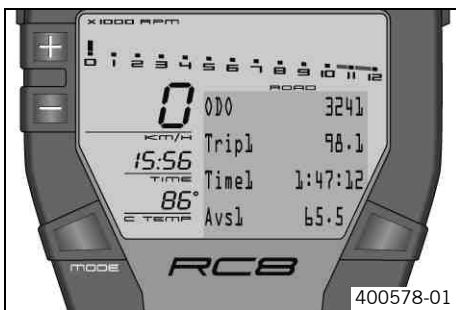

400578-01

Condition

Alternative 1

- The ignition is on.
- The motorcycle is stationary.
- **ROAD** mode

Alternative 2

- The ignition is on.
- The motorcycle is being ridden.
- **ROAD** mode

– Press the **MODE** button briefly and repeatedly until **ODO** appears at the top left of the info display.

ODO shows the total distance covered.

Trip 1 shows the distance covered since the last reset. For example, between two refueling stops. **Trip 1** is always running and counts up to **9999.9**.

Time 1 shows the journey time on the basis of **Trip 1** and resumes running as soon as a speed signal is received.

The calculation of this value starts with the first speed signal and ends 3 seconds after the last speed signal.

Avs 1 shows the average speed and is coupled with **Trip 1** and **Time 1**.

Press the button	No function
Press the button	No function
Press the button and the button for 3 - 5 seconds.	The display changes to the SET-UP menu

Press the MODE button for 3 - 5 seconds.	The display of Trip 1 , Time 1 and Avs 1 is reset
Press the MODE button briefly.	Next display mode

Odometer menu, ODO/Trip 2

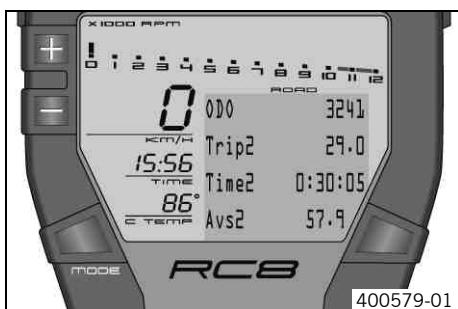

Condition

Alternative 1

- The ignition is on.
- The motorcycle is stationary.
- **ROAD** mode

Alternative 2

- The ignition is on.
 - The motorcycle is being ridden.
 - **ROAD** mode
- Press the **MODE** button briefly and repeatedly until **ODO** appears at the top left of the info display.

ODO shows the total distance covered.

Trip 2 shows the distance covered since the last reset. For example, between two refueling stops. **Trip 2** is always running and counts up to **9999.9**.

Time 2 shows the journey time on the basis of **Trip 2** and resumes running as soon as a speed signal is received.

The calculation of this value starts with the first speed signal and ends 3 seconds after the last speed signal.

Avs 2 shows the average speed and is coupled with **Trip 2** and **Time 2**.

Press the button	No function
Press the button	No function
Press the button and the button for 3 - 5 seconds.	The display changes to the SET-UP menu
Press the MODE button for 3 - 5 seconds.	The display of Trip 2 , Time 2 and Avs 2 is reset
Press the MODE button briefly.	Next display mode

FUELDISTANCE menu

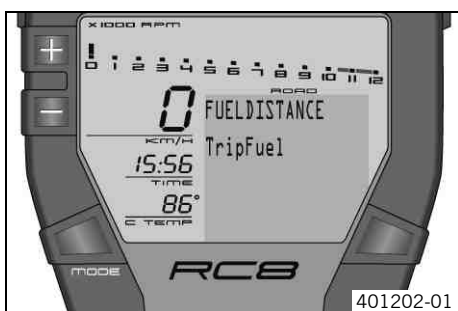

Condition

Alternative 1

- The ignition is on.
- The motorcycle is stationary.
- **ROAD** mode

Alternative 2



- The ignition is on.
 - The motorcycle is being ridden.
 - **ROAD** mode
- Press the **MODE** button briefly and repeatedly until **FUELDISTANCE** appears at the top of the info display.

TripFuel - No function

OuterTemp - No function

i Tip
The **OuterTemp** display can be switched off in the **OPTIONS** menu. **OuterTemp** then no longer appears on the info display.

Press the button	No function
Press the button	No function

Press the button  and the button  for 3 - 5 seconds.	The display changes to the SET-UP menu
Press the MODE button for 3 - 5 seconds.	No function
Press the MODE button briefly.	Next display mode



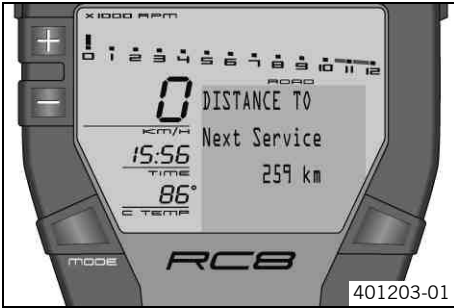

Next service menu, **DISTANCE TO Next Service**



Condition

- The ignition is on.
 - The motorcycle is stationary.
 - **ROAD** mode
- Press the **MODE** button briefly and repeatedly until **DISTANCE TO Next Service** appears in the info display.

DISTANCE TO Next Service shows the distance before the next service is necessary.

Press the button  .	No function
Press the button  .	No function
Press the button  and the button  for 3 - 5 seconds.	The display changes to the SET-UP menu
Press the MODE button for 3 - 5 seconds.	No function
Press the MODE button briefly.	Next display mode

Combination instrument - RACE mode overview

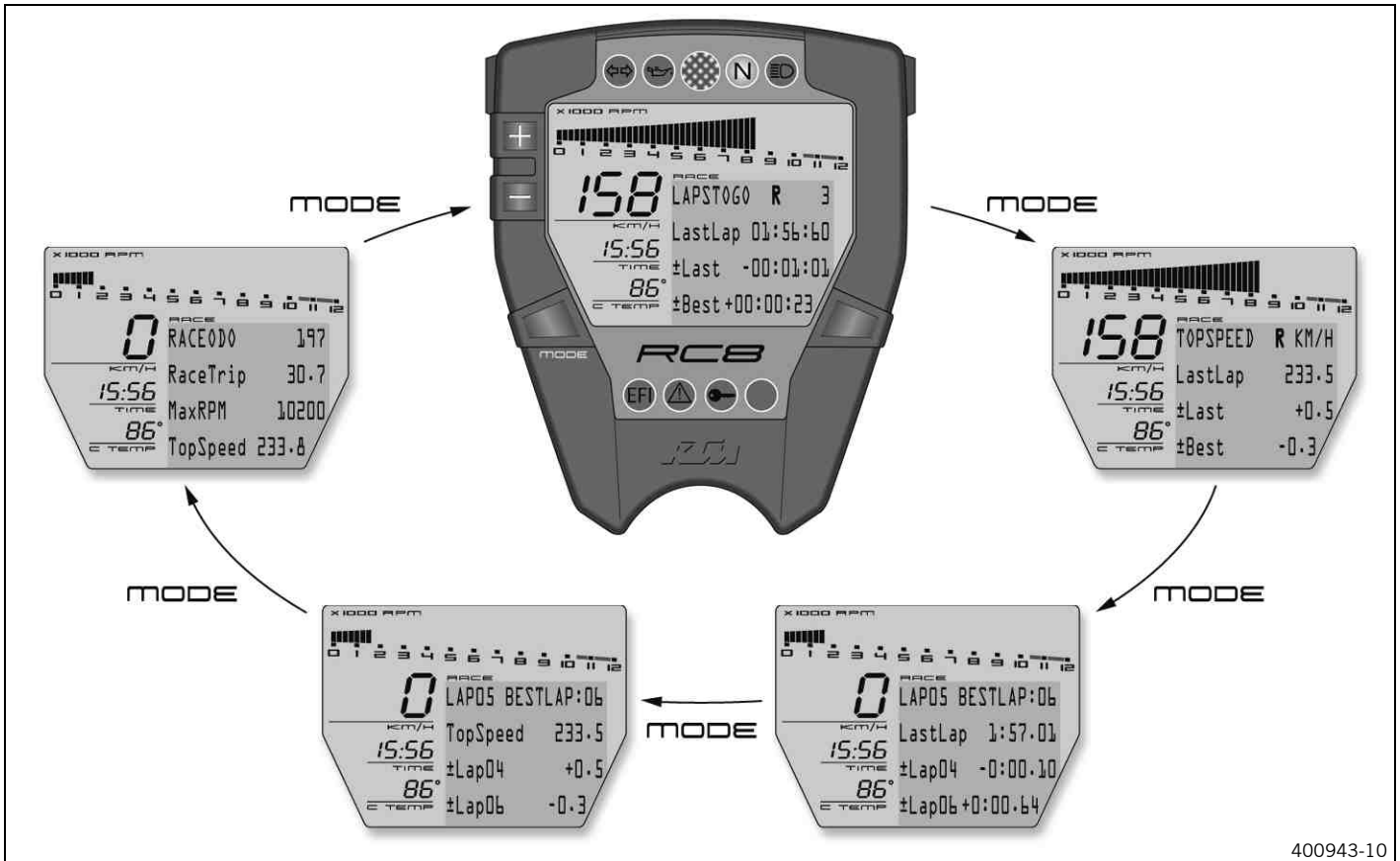

400943-10

Functions in RACE mode

LAPSTOGO menu

Maximum lap speed menu, **TOPSPEED**

Lap time, **LAP/BESTLAP/LastLap** menu

Top speed, **LAP/BESTLAP/TopSpeed** menu

Total distance in Race mode menu, **RACEODO**

Remaining laps menu, LAPSTOGO

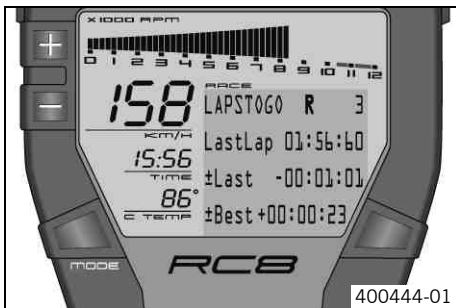

400444-01

Condition

Alternative 1

- The ignition is on.
- The motorcycle is stationary.
- **RACE** mode

Alternative 2

- The ignition is on.
- The motorcycle is being ridden.
- **RACE** mode

– Press the **MODE** button briefly and repeatedly until **LAPSTOGO** appears at the top left of the info display.

LAPSTOGO shows the number of remaining laps.

If an **R** appears after **LAPSTOGO**, the stopwatch is running in the background.

If a **P** appears after **LAPSTOGO**, the stopwatch in the background is active but waiting for a speed signal. The time is not running.

This function is controlled with the **LAP** button.



LastLap shows the lap time of the last lap.

±Last shows the difference between the last lap and the lap before last.

±Best shows the difference between the last lap and the best lap.

If the last lap was the fastest, you see behind **±Best**: the **Best!** symbol in the info display.

Press the button	No function
Press the button	No function

Press the button  and the button  for 3 - 5 seconds.	The display changes to the SET-UP menu
Press the MODE button for 3 - 5 seconds.	All values in RACE mode are reset (except RACEODO)
Press the MODE button briefly.	Next display mode

Maximum lap speed menu, TOPSPEED

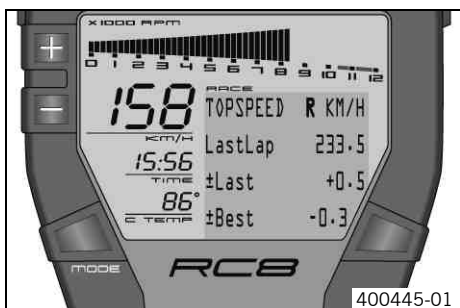

400445-01

Condition

Alternative 1

- The ignition is on.
- The motorcycle is stationary.
- **RACE** mode

Alternative 2

- The ignition is on.
 - The motorcycle is being ridden.
 - **RACE** mode
- Press the **MODE** button briefly and repeatedly until **TOPSPEED** appears at the top left of the info display.

TOPSPEED shows the highest lap speed.

If an **R** appears after **TOPSPEED**, the stopwatch is running in the background.

If a **P** appears after **TOPSPEED**, the stopwatch in the background is active but waiting for a speed signal. The time is not running.

This function is controlled with the **LAP** button.





LastLap shows the maximum speed of the last lap.

±Last shows the maximum speed difference between the last lap and the lap before.

±Best shows the maximum speed difference between the last lap and the highest maximum speed.

If the last lap was the lap with the highest maximum speed, the info display shows

±Best: Best!

Press the button  .	No function
Press the button  .	No function
Press the button  and the button  for 3 - 5 seconds.	The display changes to the SET-UP menu
Press the MODE button for 3 - 5 seconds.	The display of LastLap , ±Last and ±Best are set to 0
Press the MODE button briefly.	Next display mode

LAP/BESTLAP/LastLap menu



400446-01

Condition

- The ignition is on.
 - The motorcycle is stationary.
 - **RACE** mode
- Press the **MODE** button briefly and repeatedly until **LAP/BESTLAP/LastLap** appears in the info display.



LAP shows the selected lap.



BESTLAP shows the number of the lap with the best lap time.

LastLap shows the time of the lap behind **LAP**.

±Lap shows the difference to the lap before.

±Lap shows the difference to the lap after.

Press the button  .	The next lap is displayed
Press the button  .	The previous lap is displayed

Press the button  and the button  for 3 - 5 seconds.	The display changes to the SET-UP menu
Press the MODE button for 3 - 5 seconds.	All values in RACE mode are reset (except RACEODO)
Press the MODE button briefly.	Next display mode

Maximum speed menu, LAP/BESTLAP/TopSpeed



Condition

- The ignition is on.
 - The motorcycle is stationary.
 - **RACE** mode
- Press the **MODE** button briefly and repeatedly until **LAP/BESTLAP/TopSpeed** appears in the info display.





LAP shows the selected lap.

BESTLAP shows the lap in which the highest maximum speed was reached.

TopSpeed shows maximum speed of the lap behind **LAP**.

±Lap shows the difference to the lap before.

±Lap shows the difference to the lap after.

Press the button  .	The next lap is displayed
Press the button  .	The previous lap is displayed
Press the button  and the button  for 3 - 5 seconds.	The display changes to the SET-UP menu
Press the MODE button for 3 - 5 seconds.	All values in RACE mode are reset (except RACEODO)
Press the MODE button briefly.	Next display mode

Total distance in Race mode menu, RACEODO

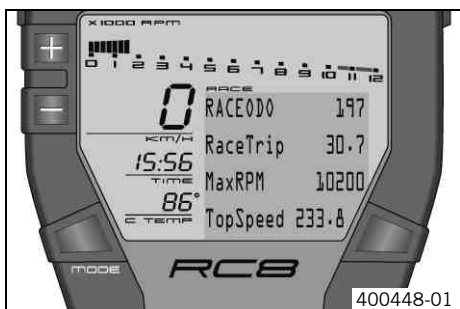

Condition





- The ignition is on.
 - The motorcycle is stationary.
 - **RACE** mode
- Press the **MODE** button briefly and repeatedly until **RACEODO** appears at the top of the info display.

RACEODO shows the total distance covered in **RACE** mode.

RaceTrip shows the distance covered since the last reset. For example, between two refueling stops. **RaceTrip** is always running and counts up to **999.9**.

MaxRPM shows the highest engine speed reached during the **RaceTrip**.

TopSpeed shows the highest speed reached during the **RaceTrip**.

Press the button  .	No function
Press the button  .	No function
Press the button  and the button  for 3 - 5 seconds.	The display changes to the SET-UP menu
Press the MODE button for 3 - 5 seconds.	All values in RACE mode are reset (except RACEODO)
Press the MODE button briefly.	Next display mode

Combination instrument - SET-UP mode

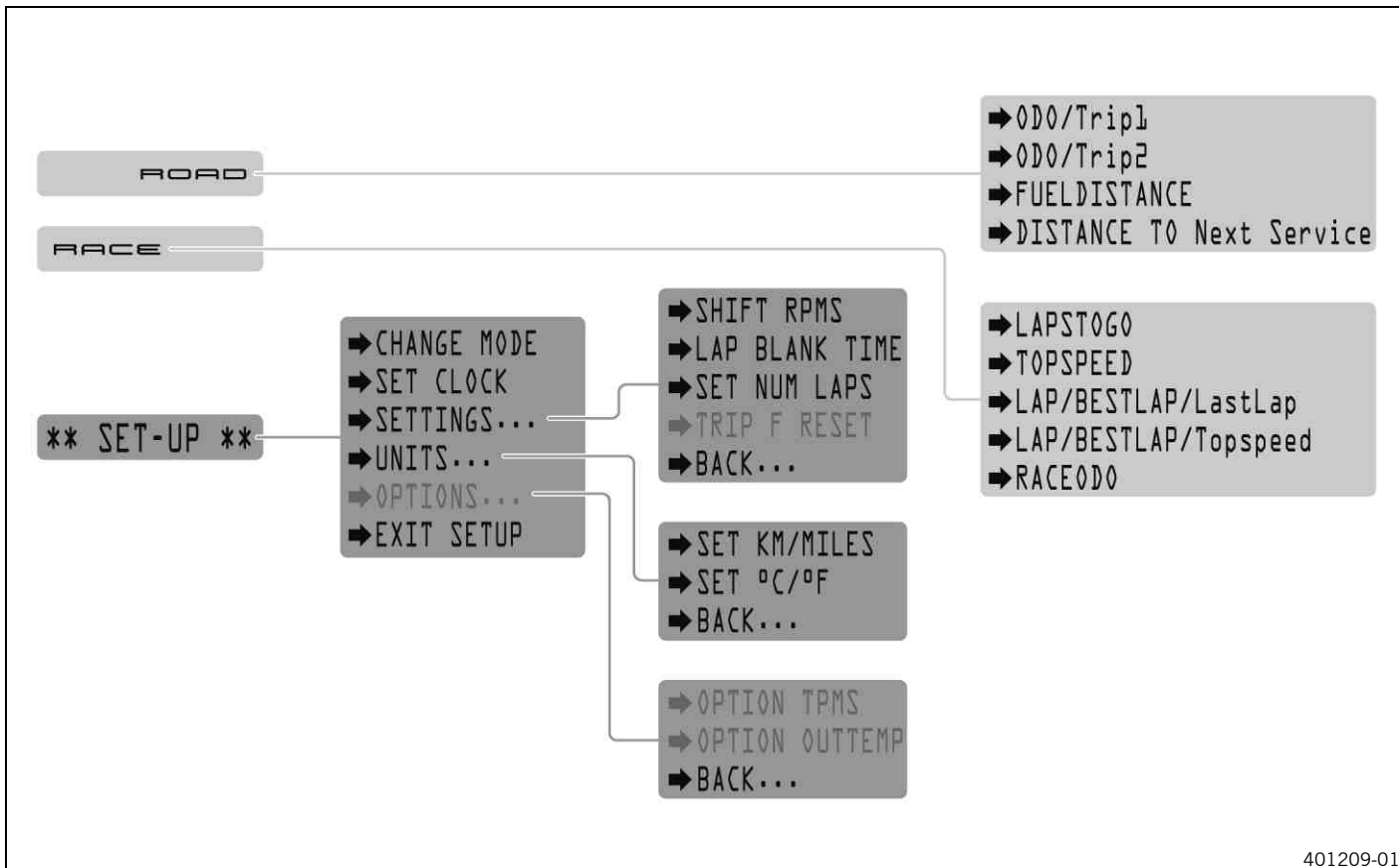

401209-01

Settings in SET-UP mode

Mode menu, **CHANGE MODE**

Time menu, **SET CLOCK**

SETTINGS menu

UNITS menu

OPTIONS menu

EXIT SETUP menu

SET-UP menu



400449-01

Condition

Alternative 1

- The ignition is on.
- The motorcycle is stationary.
- **ROAD** mode

Alternative 2

- The ignition is on.
- The motorcycle is stationary.
- **RACE** mode
- Press the button and the button for 3 - 5 seconds.

In the **CHANGE MODE** menu, you can select between **ROAD** and **RACE** mode.

You can set the clock in the **SET CLOCK** menu.

In the **SETTINGS** menu, you can set the shift warning light, the lap blank time of the **LAP** button, the number of laps, and the reset time of the fuel reserve display.

In the **UNITS** menu, you can set the units for measuring speed, distance, and temperature.

In the **OPTIONS** menu, you can switch the tire pressure check and external temperature display on/off (available as accessories).

Select **EXIT SETUP** to close the **SET-UP** menu.

The symbol indicates which menu can be activated with the **MODE** button.

Press the button .	The arrow moves up
Press the button .	The arrow moves down

Press the button and the button for 3 - 5 seconds.	No function
Press the MODE button for 3 - 5 seconds.	The menu in front of the arrow is selected
Press the MODE button briefly.	The menu in front of the arrow is selected

Mode menu, CHANGE MODE

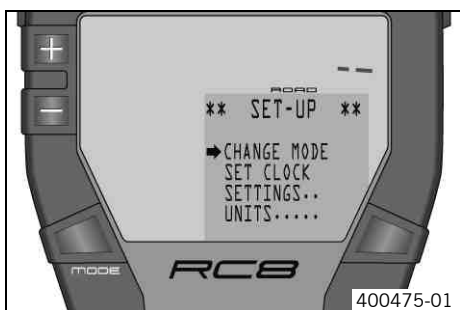

Condition

Alternative 1

- The ignition is on.
- The motorcycle is stationary.
- **ROAD** mode

Alternative 2

- The ignition is on.
 - The motorcycle is stationary.
 - **RACE** mode
- Press the button and the button for 3 - 5 seconds.
 - Press the **MODE** button briefly.

In the **CHANGE MODE** menu, you can select between **ROAD** and **RACE** mode.

Press the button .	Changes the menu
Press the button .	Changes the menu
Press the button and the button for 3 - 5 seconds.	No function
Press the MODE button for 3 - 5 seconds.	Opening and exiting CHANGE MODE
Press the MODE button briefly.	Opening and exiting CHANGE MODE

Time menu, SET CLOCK

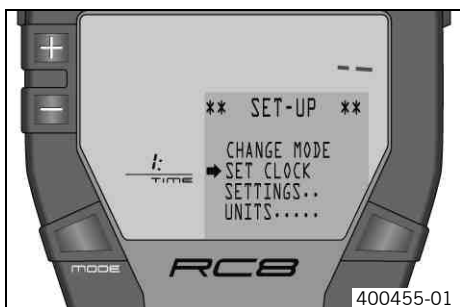

Condition

Alternative 1

- The ignition is on.
- The motorcycle is stationary.
- **ROAD** mode

Alternative 2

- The ignition is on.
 - The motorcycle is stationary.
 - **RACE** mode
- Press the button and the button for 3 - 5 seconds.
 - Press the button once until the symbol shows **SET CLOCK** in the info display.
 - Press the **MODE** button briefly.

You can set the clock in the **SET CLOCK** menu.

Press the button .	Increases the value
Press the button .	Decreases the value
Press the button and the button for 3 - 5 seconds.	No function
Press the MODE button for 3 - 5 seconds.	Open and exit SET CLOCK or change to the next value

Press the MODE button briefly.	Open and exit SET CLOCK or change to the next value
---------------------------------------	--

SETTINGS menu

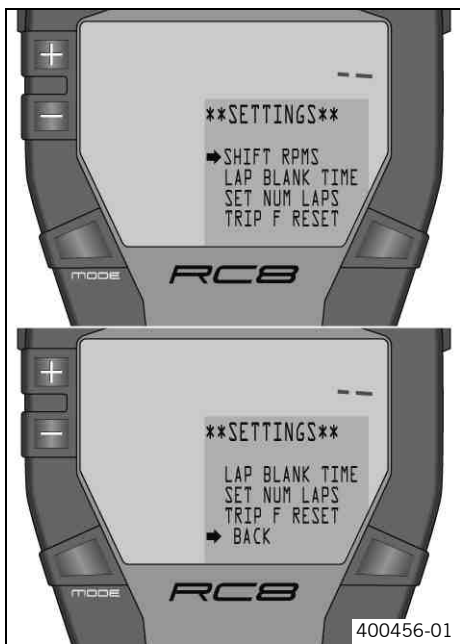

Condition

Alternative 1

- The ignition is on.
- The motorcycle is stationary.
- **ROAD** mode

Alternative 2

- The ignition is on.
 - The motorcycle is stationary.
 - **RACE** mode
- Press the button and the button for 3 - 5 seconds.
 - Press the button twice until the symbol appears in front of **SETTINGS** in the info display.
 - Press the **MODE** button briefly.

In the **SHIFT RPMS** menu, you can activate the shift warning light.
 In the **LAP BLANK TIME** menu, you can set the lap blank time of the **LAP** button.
 In the **SET NUM LAPS** menu, you can set the number of laps to cover in **RACE** mode.
 In the **TRIP F RESET** menu, you can set the reaction time of the fuel reserve display to changes in the fuel level.
 In the **BACK...** menu, you can switch back to the **SET-UP** menu.
 The symbol indicates which menu can be activated with the **MODE** button.

Press the button .	The arrow moves up
Press the button .	The arrow moves down
Press the button and the button for 3 - 5 seconds.	No function
Press the MODE button for 3 - 5 seconds.	The menu in front of the arrow is selected
Press the MODE button briefly.	The menu in front of the arrow is selected

Shift warning lamp menu, SHIFT RPMS



Condition

Alternative 1

- The ignition is on.
- The motorcycle is stationary.
- **ROAD** mode

Alternative 2

- The ignition is on.
 - The motorcycle is stationary.
 - **RACE** mode
- Press the button and the button for 3 - 5 seconds.
 - Press the button twice until the symbol appears in front of **SETTINGS** in the info display.
 - Press the **MODE** button briefly.
 - Press the **MODE** button briefly.

In the **SHIFT RPMS** menu, you can activate the shift warning light.

Press the button .	Increases the value
Press the button .	Decreases the value
Press the button and the button for 3 - 5 seconds.	No function

Press the MODE button for 3 - 5 seconds.	Open and exit SHIFT RPMS or change to the next value
Press the MODE button briefly.	Open and exit SHIFT RPMS or change to the next value

Blank time menu, LAP, LAP BLANK TIME button



Condition

Alternative 1

- The ignition is on.
- The motorcycle is stationary.
- **ROAD** mode

Alternative 2

- The ignition is on.
 - The motorcycle is stationary.
 - **RACE** mode
- Press the button and the button for 3 - 5 seconds.
 - Press the button twice until the symbol appears in front of **SETTINGS** in the info display.
 - Press the **MODE** button briefly.
 - Press the button once until the symbol shows **LAP BLANK T** in the info display.
 - Press the **MODE** button briefly.

In the **LAP BLANK TIME** menu, you set the lap blank time of the **LAP** button.

Press the button .	Increases the value
Press the button .	Decreases the value
Press the button and the button for 3 - 5 seconds.	No function
Press the MODE button for 3 - 5 seconds.	Open and exit LAP BLANK TIME
Press the MODE button briefly.	Open and exit LAP BLANK TIME

Number of laps menu, SET NUM LAPS

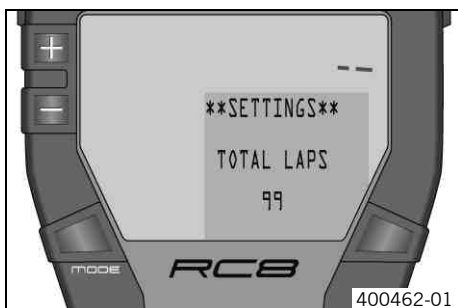

Condition

Alternative 1



- The ignition is on.
- The motorcycle is stationary.
- **ROAD** mode

Alternative 2

- The ignition is on.
 - The motorcycle is stationary.
 - **RACE** mode
- Press the button and the button for 3 - 5 seconds.
 - Press the button twice until the symbol appears in front of **SETTINGS** in the info display.
 - Press the **MODE** button briefly.
 - Press the button twice until the symbol shows **SET NUM LAPS** in the info display.
 - Press the **MODE** button briefly.

In the **SET NUM LAPS** menu, you can set the number of laps to cover in **RACE** mode.

Press the button .	Increases the value
Press the button .	Decreases the value

Press the button  and the button  for 3 - 5 seconds.	No function
Press the MODE button for 3 - 5 seconds.	Open and exit SET NUM LAPS
Press the MODE button briefly.	Open and exit SET NUM LAPS

Fuel reserve display menu, TRIP F RESET









Condition

Alternative 1

- The ignition is on.
- The motorcycle is stationary.
- **ROAD** mode





Alternative 2

- The ignition is on.
 - The motorcycle is stationary.
 - **RACE** mode
- Press the button  and the button  for 3 - 5 seconds.
 - Press the button  twice until the symbol  appears in front of **SETTINGS** in the info display.
 - Press the **MODE** button briefly.
 - Press the button  three times until the symbol  shows **TRIP F RESET** in the info display.
 - Press the **MODE** button briefly.

In the **TRIP F RESET** menu, you can set the reaction time of the fuel reserve display to changes of the fuel level.

Info

In this model, the fuel reserve cannot be measured.

Press the button  .	Increases the value
Press the button  .	Decreases the value
Press the button  and the button  for 3 - 5 seconds.	No function
Press the MODE button for 3 - 5 seconds.	Open and exit TRIP F RESET
Press the MODE button briefly.	Open and exit TRIP F RESET

UNITS menu







Condition

Alternative 1

- The ignition is on.
- The motorcycle is stationary.
- **ROAD** mode

Alternative 2

- The ignition is on.
 - The motorcycle is stationary.
 - **RACE** mode
- Press the button  and the button  for 3 - 5 seconds.
 - Press the button  three times until the symbol  shows **UNITS** in the info display.





- Press the **MODE** button briefly.

In the **SET KM/MILES** menu, you can set the units for measuring speed and distance.

In the **SET °C/°F** menu, you can set the unit for the temperature display.

In the **BACK...** menu, you can switch back to the **SET-UP** menu.

The symbol ➔ indicates which menu can be activated with the **MODE** button.

Press the button 	The arrow moves up
Press the button 	The arrow moves down
Press the button  and the button  for 3 - 5 seconds.	No function
Press the MODE button for 3 - 5 seconds.	The menu in front of the arrow is selected
Press the MODE button briefly.	The menu in front of the arrow is selected

Kilometers/miles menu, SET KM/MILES

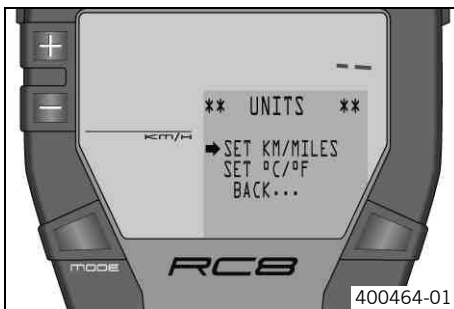



Condition

Alternative 1

- The ignition is on.
- The motorcycle is stationary.
- **ROAD** mode

Alternative 2

- The ignition is on.
- The motorcycle is stationary.
- **RACE** mode





- Press the button  and the button  for 3 - 5 seconds.

- Press the button  three times until the symbol ➔ shows **UNITS** in the info display.

- Press the **MODE** button briefly.

- Press the **MODE** button briefly.

In the **SET KM/MILES** menu, you can set the units for measuring speed and distance.

Press the button 	Changes the unit
Press the button 	Changes the unit
Press the button  and the button  for 3 - 5 seconds.	No function
Press the MODE button for 3 - 5 seconds.	Open and exit SET KM/MILES
Press the MODE button briefly.	Open and exit SET KM/MILES

Temperature display menu, SET °C/°F

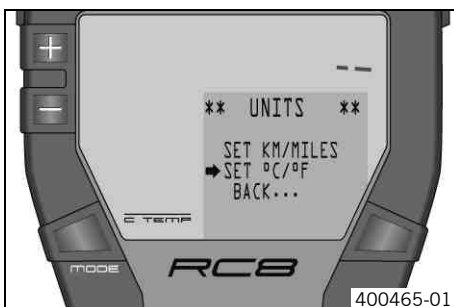



Condition

Alternative 1



- The ignition is on.
- The motorcycle is stationary.
- **ROAD** mode

Alternative 2





- The ignition is on.
- The motorcycle is stationary.
- **RACE** mode

- Press the button  and the button  for 3 - 5 seconds.

- Press the button  three times until the symbol ➔ shows **UNITS** in the info display.

- Press the **MODE** button briefly.
- Press the button  once until the symbol  shows **SET °C/°F** in the info display.
- Press the **MODE** button briefly.

In the **SET °C/°F** menu, you can set the unit for the temperature display.

Press the button  .	Changes the unit
Press the button  .	Changes the unit
Press the button  and the button  for 3 - 5 seconds.	No function
Press the MODE button for 3 - 5 seconds.	Open and exit SET °C/°F
Press the MODE button briefly.	Open and exit SET °C/°F

Additional functions menu, OPTIONS

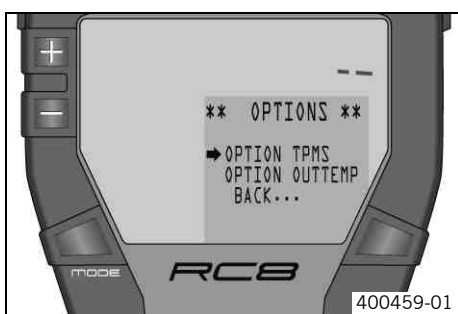





Condition

Alternative 1

- The ignition is on.
- The motorcycle is stationary.
- **ROAD** mode

Alternative 2

- The ignition is on.
- The motorcycle is stationary.
- **RACE** mode





- Press the button  and the button  for 3 - 5 seconds.
- Press the button  four times until the symbol  shows **OPTIONS** in the info display.
- Press the **MODE** button briefly.

In the **OPTION TPMS** menu, you can switch the tire pressure check on/off (available as accessory).

In the **OPTION OUTTEMP** menu, you can switch the external temperature display on/off.

In the **BACK...** menu, you can switch back to the **SET-UP** menu.

The symbol  indicates which menu can be activated with the **MODE** button.

Press the button  .	The arrow moves up
Press the button  .	The arrow moves down
Press the button  and the button  for 3 - 5 seconds.	No function
Press the MODE button for 3 - 5 seconds.	The menu in front of the arrow is selected
Press the MODE button briefly.	The menu in front of the arrow is selected

Tire pressure monitor menu, TPMS

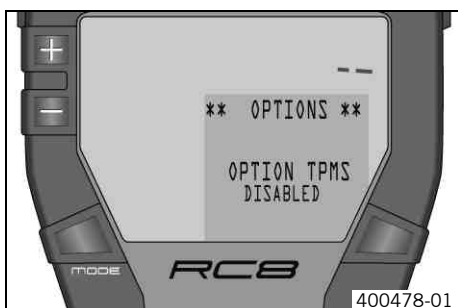





Condition

Alternative 1





- The ignition is on.
- The motorcycle is stationary.
- **ROAD** mode

Alternative 2

- The ignition is on.
- The motorcycle is stationary.

- **RACE** mode
 - Press the button  and the button  for 3 - 5 seconds.
 - Press the button  four times until the symbol  shows **OPTIONS** in the info display.
 - Press the **MODE** button briefly.
 - Press the **MODE** button briefly.

In the **OPTION TPMS** menu, you can switch the tire pressure check on/off (available as accessory).

Press the button  .	Switches the tire pressure display on/off
Press the button  .	Switches the tire pressure display on/off
Press the button  and the button  for 3 - 5 seconds.	No function
Press the MODE button for 3 - 5 seconds.	Open and exit OPTION TPMS
Press the MODE button briefly.	Open and exit OPTION TPMS

External temperature display menu, OPTION OUTTEMP









Condition

Alternative 1

- The ignition is on.
- The motorcycle is stationary.
- **ROAD** mode

Alternative 2

- The ignition is on.
- The motorcycle is stationary.
- **RACE** mode
 - Press the button  and the button  for 3 - 5 seconds.
 - Press the button  four times until the symbol  shows **OPTIONS** in the info display.
 - Press the **MODE** button briefly.
 - Press the button  once until the symbol  shows **OPTION OUTTEMP** in the info display.
 - Press the **MODE** button briefly.

In the **OPTION OUTTEMP** menu, you can switch the external temperature display on/off.

Info

In this model, the external temperature cannot be measured.





Press the button  .	Switches the external temperature display on/off
Press the button  .	Switches the external temperature display on/off
Press the button  and the button  for 3 - 5 seconds.	No function
Press the MODE button for 3 - 5 seconds.	Open and exit OPTION OUTTEMP
Press the MODE button briefly.	Open and exit OPTION OUTTEMP



Table of functions					
Display	Press the button  .	Press the button  .	Press the button  and the button  for 3 - 5 seconds.	Press the MODE button for 3 - 5 seconds.	Press the MODE button briefly.
Odometer menu, ODO/Trip 1	No function	No function	The display changes to the SET-UP menu	The display of Trip 1, Time 1 and Avs 1 is reset	Next display mode
Odometer menu, ODO/Trip 2	No function	No function	The display changes to the SET-UP menu	The display of Trip 2, Time 2 and Avs 2 is reset	Next display mode
FUELDISTANCE menu	No function	No function	The display changes to the SET-UP menu	No function	Next display mode
Next service menu, DISTANCE TO Next Service	No function	No function	The display changes to the SET-UP menu	No function	Next display mode
Remaining laps menu, LAPSTOGO	No function	No function	The display changes to the SET-UP menu	All values in RACE mode are reset (except RACEODO)	Next display mode
Maximum lap speed menu, TOPSPEED	No function	No function	The display changes to the SET-UP menu	The display of LastLap, ±Last and ±Best are set to 0	Next display mode
LAP/BESTLAP/LastLap menu	The next lap is displayed	The previous lap is displayed	The display changes to the SET-UP menu	All values in RACE mode are reset (except RACEODO)	Next display mode
Maximum speed menu, LAP/BESTLAP/TopSpeed	The next lap is displayed	The previous lap is displayed	The display changes to the SET-UP menu	All values in RACE mode are reset (except RACEODO)	Next display mode
Total distance in Race mode menu, RACEODO	No function	No function	The display changes to the SET-UP menu	All values in RACE mode are reset (except RACEODO)	Next display mode
SET-UP menu	The arrow moves up	The arrow moves down	No function	The menu in front of the arrow is selected	The menu in front of the arrow is selected
Mode menu, CHANGE MODE	Changes the menu	Changes the menu	No function	Opening and exiting CHANGE MODE	Opening and exiting CHANGE MODE
Time menu, SET CLOCK	Increases the value	Decreases the value	No function	Open and exit SET CLOCK or change to the next value	Open and exit SET CLOCK or change to the next value
SETTINGS menu	The arrow moves up	The arrow moves down	No function	The menu in front of the arrow is selected	The menu in front of the arrow is selected
Shift warning lamp menu, SHIFT RPMS	Increases the value	Decreases the value	No function	Open and exit SHIFT RPMS or change to the next value	Open and exit SHIFT RPMS or change to the next value
Blank time menu, LAP, LAP BLANK TIME button	Increases the value	Decreases the value	No function	Open and exit LAP BLANK TIME	Open and exit LAP BLANK TIME
Number of laps menu, SET NUM LAPS	Increases the value	Decreases the value	No function	Open and exit SET NUM LAPS	Open and exit SET NUM LAPS
Fuel reserve display menu, TRIP F RESET	Increases the value	Decreases the value	No function	Open and exit TRIP F RESET	Open and exit TRIP F RESET
UNITS menu	The arrow moves up	The arrow moves down	No function	The menu in front of the arrow is selected	The menu in front of the arrow is selected
Kilometers/miles menu, SET KM/MILES	Changes the unit	Changes the unit	No function	Open and exit SET KM/MILES	Open and exit SET KM/MILES
Temperature display menu, SET °C/°F	Changes the unit	Changes the unit	No function	Open and exit SET °C/°F	Open and exit SET °C/°F





Table of functions					
Display	Press the button  .	Press the button  .	Press the button  and the button  for 3 - 5 seconds.	Press the MODE button for 3 - 5 seconds.	Press the MODE button briefly.
Additional functions menu, OPTIONS	The arrow moves up	The arrow moves down	No function	The menu in front of the arrow is selected	The menu in front of the arrow is selected
Tire pressure monitor menu, TPMS	Switches the tire pressure display on/off	Switches the tire pressure display on/off	No function	Open and exit OPTION TPMS	Open and exit OPTION TPMS
External temperature display menu, OPTION OUTTEMP	Switches the external temperature display on/off	Switches the external temperature display on/off	No function	Open and exit OPTION OUTTEMP	Open and exit OPTION OUTTEMP

Table of conditions and menu activation					
Display	<ul style="list-style-type: none"> The ignition is on. The motorcycle is stationary. ROAD mode 	<ul style="list-style-type: none"> The ignition is on. The motorcycle is being ridden. ROAD mode 	<ul style="list-style-type: none"> The ignition is on. The motorcycle is stationary. RACE mode 	<ul style="list-style-type: none"> The ignition is on. The motorcycle is being ridden. RACE mode 	Menu can be activated
Odometer menu, ODO/Trip 1	•	•			
Odometer menu, ODO/Trip 2	•	•			
FUELDISTANCE menu	•	•			
Next service menu, DISTANCE TO Next Service	•				
Remaining laps menu, LAPSTOGO			•	•	
Maximum lap speed menu, TOPSPEED			•	•	
LAP/BESTLAP/LastLap menu			•		
Maximum speed menu, LAP/BESTLAP/TopSpeed			•		
Total distance in Race mode menu, RACEODO			•		
SET-UP menu	•		•		
Mode menu, CHANGE MODE	•		•		•
Time menu, SET CLOCK	•		•		
SETTINGS menu	•		•		
Shift warning lamp menu, SHIFT RPMS	•		•		
Blank time menu, LAP, LAP BLANK TIME button	•		•		
Number of laps menu, SET NUM LAPS	•		•		
Fuel reserve display menu, TRIP F RESET	•		•		
UNITS menu	•		•		
Kilometers/miles menu, SET KM/MILES	•		•		
Temperature display menu, SET °C/°F	•		•		
Additional functions menu, OPTIONS	•		•		
Tire pressure monitor menu, TPMS	•		•		•
External temperature display menu, OPTION OUTTEMP	•		•		•

Displaying lap times



Condition

The ignition is on.
The motorcycle is stationary.

RACE mode

- Press the **MODE** button briefly and repeatedly until **LAP/BESTLAP/LastLap** appears in the info display.
 - ✓ **LAP01** appears on the left of the info display.
- Press the button .
 - ✓ The next lap is displayed.
- Press the button .
 - ✓ The previous lap is displayed.
- Press the **MODE** button briefly.
 - ✓ Next display mode

Displaying maximum speed

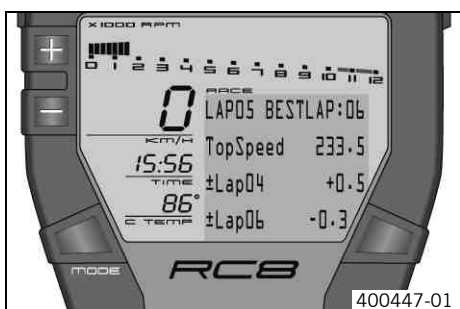

Condition

The ignition is on.
The motorcycle is stationary.

RACE mode

- Press the **MODE** button briefly and repeatedly until **LAP/BESTLAP/TopSpeed** appears in the info display.
 - ✓ **LAP01** appears on the left of the info display.
- Press the button .
 - ✓ The next lap is displayed.
- Press the button .
 - ✓ The previous lap is displayed.
- Press the **MODE** button briefly.
 - ✓ Next display mode

Setting ROAD or RACE mode

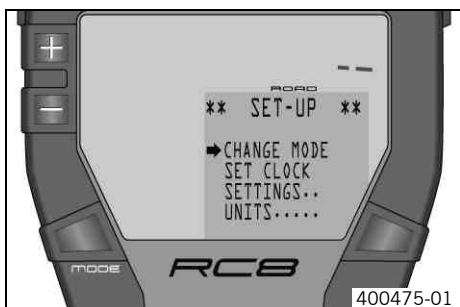

Condition

The ignition is on.
The motorcycle is stationary.

- Press the button and the button for 3 - 5 seconds.
- Press the **MODE** button briefly.
 - ✓ The mode set is shown in the info display.
- Select **ROAD** mode or **RACE** mode with the button or the button.
- Press the **MODE** button briefly.
 - ✓ The settings are stored and the display changes to the **SET-UP** menu.
- Press the button briefly and repeatedly until the symbol shows **EXIT SETUP** in the info display.
- Press the **MODE** button briefly.

Setting the clock with SET CLOCK

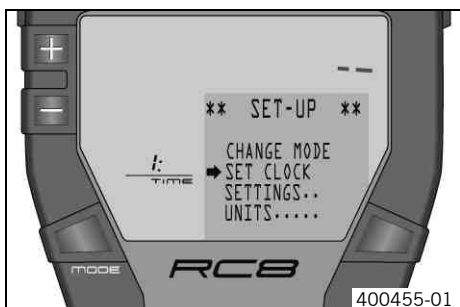

Condition

The ignition is on.
The motorcycle is stationary.

- Press the button and the button for 3 - 5 seconds.
- Press the button once until the symbol shows **SET CLOCK** in the info display.
- Press the **MODE** button briefly.
 - ✓ The hour is shown.
- Set the hour with the button or the button.
- Press the **MODE** button briefly.
 - ✓ The minutes are shown.

- Set the minutes with the button or the button.
- Press the **MODE** button briefly.
 - ✓ The settings are stored and the display changes to the **SET-UP** menu.
- Press the button briefly and repeatedly until the symbol shows **EXIT SETUP** in the info display.
- Press the **MODE** button briefly.

Adjusting shift speed RPM1/2



Condition

The ignition is on.
The motorcycle is stationary.

- Press the button and the button for 3 - 5 seconds.
- Press the button twice until the symbol appears in front of **SETTINGS** in the info display.
- Press the **MODE** button briefly.
- Press the **MODE** button briefly.
 - ✓ **RPM1** and **RPM2** appear in the info display.
 - ✓ The engine speed after **RPM1** flashes.



Info

The engine speed can be set at intervals of 50.
RPM1 is the engine speed above which the shift warning light starts to flash.

- Set the engine speed with the button or the button .
- Press the **MODE** button briefly.
 - ✓ The engine speed after **RPM2** flashes.



Info

RPM2 is the engine speed above which the shift warning light lights up constantly. If **RPM1** = **RPM2**, the shift warning light lights up constantly when you reach the engine speed set.

- Set the engine speed with the button or the button .
- Press the **MODE** button briefly.
 - ✓ The settings are stored and the display changes to the **SETTINGS** menu.



Info

At delivery, **RPM1** is set to 10000 and **RPM2** to 10500.

- Press the button briefly and repeatedly until the symbol shows **BACK...** in the info display.
- Press the **MODE** button briefly.
- Press the button briefly and repeatedly until the symbol shows **EXIT SETUP** in the info display.
- Press the **MODE** button briefly.

Setting the blank time of the LAP button LAP BLANK TIME



Condition

The ignition is on.
The motorcycle is stationary.

- Press the button and the button for 3 - 5 seconds.
- Press the button twice until the symbol appears in front of **SETTINGS** in the info display.
- Press the **MODE** button briefly.
- Press the button once until the symbol shows **LAP BLANK T** in the info display.
- Press the **MODE** button briefly.
 - ✓ **LAP BLANK T.** appears in the info display.



Info

At delivery, **LAP BLANK T.** is set to 1 second.



Tip

With the **LAP BLANK TIME** function, you can prevent the lap from being timed too short. This may happen if you accidentally press the **LAP** button twice in a row.

- Set the blank time of the **LAP** button with the button or the button.



Info

LAP BLANK T. can be set between **1** and **200**.

- Press the **MODE** button briefly.
 - ✓ The settings are stored and the display changes to the **SETTINGS** menu.
- Press the button briefly and repeatedly until the symbol shows **BACK...** in the info display.
- Press the **MODE** button briefly.
- Press the button briefly and repeatedly until the symbol shows **EXIT SETUP** in the info display.
- Press the **MODE** button briefly.

Setting the number of laps SET NUM LAPS

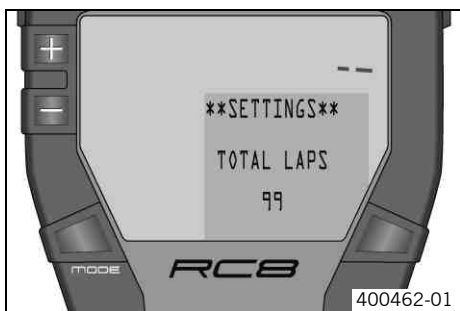

Condition

The ignition is on.
The motorcycle is stationary.

- Press the button and the button for 3 - 5 seconds.
- Press the button twice until the symbol appears in front of **SETTINGS** in the info display.
- Press the **MODE** button briefly.
- Press the button twice until the symbol shows **SET NUM LAPS** in the info display.
- Press the **MODE** button briefly.
- ✓ **TOTAL LAPS** appears in the info display with the number of laps.



Info

When delivered, the number of **TOTAL LAPS** is set to 99 laps.

- Set the number of laps with the button or the button.



Info

You can set **TOTAL LAPS** to between 1 and 99 laps.

- Press the **MODE** button briefly.
 - ✓ The settings are stored and the display changes to the **SETTINGS** menu.
- Press the button briefly and repeatedly until the symbol shows **BACK...** in the info display.
- Press the **MODE** button briefly.
- Press the button briefly and repeatedly until the symbol shows **EXIT SETUP** in the info display.
- Press the **MODE** button briefly.

Setting the kilometers/miles SET KM/MILES



Info

Making a country-specific setting.

Condition

The ignition is on.
The motorcycle is stationary.

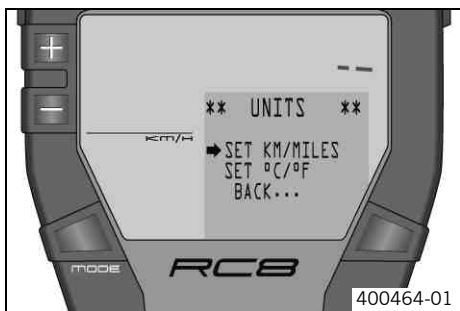

- Press the button and the button for 3 - 5 seconds.
- Press the button three times until the symbol shows **UNITS** in the info display.
- Press the **MODE** button briefly.
- Press the **MODE** button briefly.
- ✓ The selected unit appears on the left of the display.
- Select the unit with the button or the button.
- Press the **MODE** button briefly.
- ✓ The settings are stored and the display changes to the **UNITS** menu.
- Press the button briefly and repeatedly until the symbol shows **BACK...** in the info display.
- Press the **MODE** button briefly.
- Press the button briefly and repeatedly until the symbol shows **EXIT SETUP** in the info display.
- Press the **MODE** button briefly.

Setting the temperature unit SET °C/°F

Condition

The ignition is on.
The motorcycle is stationary.

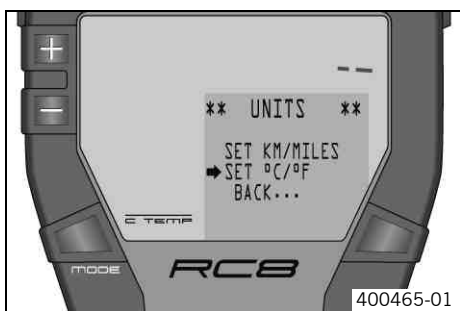

- Press the button and the button for 3 - 5 seconds.
- Press the button three times until the symbol shows **UNITS** in the info display.
- Press the **MODE** button briefly.
- Press the button once until the symbol shows **SET °C/°F** in the info display.
- Press the **MODE** button briefly.
- ✓ The selected unit appears on the left of the display.
- Select the unit with the button or the button.
- Press the **MODE** button briefly.
- ✓ The settings are stored and the display changes to the **UNITS** menu.
- Press the button briefly and repeatedly until the symbol shows **BACK...** in the info display.
- Press the **MODE** button briefly.
- Press the button briefly and repeatedly until the symbol shows **EXIT SETUP** in the info display.
- Press the **MODE** button briefly.

Hiding the external temperature display

Condition

The ignition is on.
The motorcycle is stationary.





- Press the button and the button for 3 - 5 seconds.
- Press the button four times until the symbol shows **OPTIONS** in the info display.
- Press the **MODE** button briefly.
- Press the button once until the symbol shows **OPTION OUTERTEMP** in the info display.
- Press the **MODE** button briefly.
- ✓ You see **ENABLED** or **DISABLED** on the info display.

Info

In this model, the external temperature cannot be measured.

- You can show or hide the external temperature display with the button or the button .
- Press the **MODE** button briefly.
- ✓ The settings are stored and the display changes to the **OPTIONS** menu.
- Press the button briefly and repeatedly until the symbol shows **BACK...** in the info display.

- Press the **MODE** button briefly.
- Press the button  briefly and repeatedly until the symbol  shows **EXIT SETUP** in the info display.
- Press the **MODE** button briefly.

Opening the filler cap

 **Danger**
Fire hazard Fuel is highly flammable.

- Never refuel the vehicle near open flames or burning cigarettes, and always switch off the engine first. Be careful that no fuel is spilt, especially on hot vehicle components. Clean up spilt fuel immediately.
- Fuel in the fuel tank expands when warm and can escape if the tank is overfilled. See the notes on refueling.

 **Warning**
Danger of poisoning Fuel is poisonous and a health hazard.

- Avoid contact between fuel and skin, eyes and clothing. Do not inhale fuel vapors. If fuel gets into your eyes, rinse immediately with water and contact a doctor. Wash affected skin areas immediately with soap and water. If fuel is swallowed, contact a doctor immediately. Change clothing that has come into contact with fuel. Store fuel in a suitable canister according to regulations and keep it out of the reach of children.

 **Warning**
Environmental hazard Improper handling of fuel is a danger to the environment.

- Do not allow fuel to get into the ground water, the ground, or the sewage system.

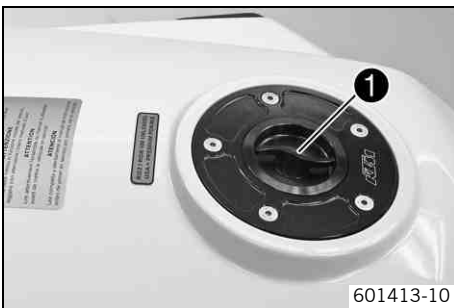

- Press the filler cap lever **1** and turn 90° counterclockwise.
- Remove the filler cap.

Closing the filler cap

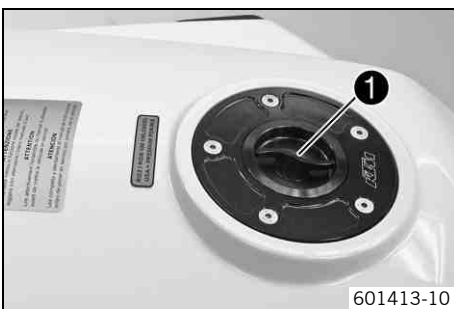

 **Warning**
Fire hazard Fuel is highly flammable, poisonous and harmful to your health.

- When closing the filler cap, ensure that it is closed correctly. Change clothing that came into contact with fuel. Immediately clean skin that came into contact with fuel using soap and water.

- Insert the filler cap.
- Turn the filler cap lever **1** 90° clockwise until it engages.

Shift lever

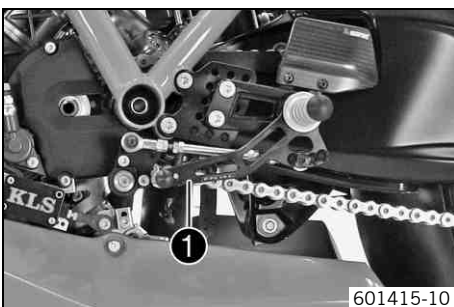

The shift lever **1** is mounted on the left of the engine.

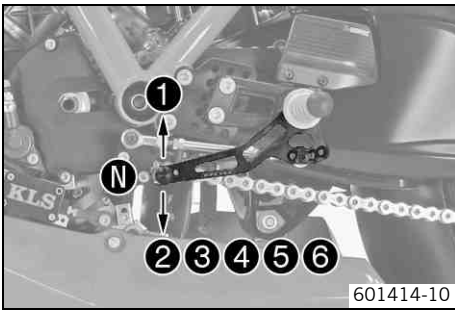

The gear positions can be seen in the figure.
The neutral or idle position **N** is between the first and second gear.

i Info
The arrangement of the gears is the reverse of that in RC8 R, which is approved for public road use.

Foot brake lever

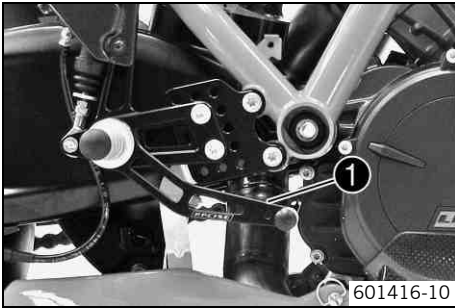

The foot brake lever **1** is in front of the right footrest.
The foot brake lever operates the rear brake.

Advice on first use



Danger

Danger of accidents Danger arising from the rider's judgement being impaired.

- Do not operate the vehicle while under the influence of alcohol, drugs and certain medications or physically or mentally impaired.



Warning

Risk of injury Missing or poor protective clothing present an increased safety risk.

- Wear protective clothing (helmet, boots, gloves, pants and jacket with protectors) every time you ride the vehicle. Always wear protective clothing, which must be undamaged and meet legal requirements.



Warning

Danger of accidents Uncontrollable handling characteristic due to non-approved and/or non-recommended tires/wheels.

- Only tires/wheels approved by KTM and with the corresponding speed index should be used.



Warning

Danger of accidents Critical riding behavior due to inappropriate riding.

- Adapt your riding speed to the road conditions and your riding ability.



Warning

Danger of accidents Accident risk caused by presence of a passenger.

- Your vehicle is not designed to carry passengers. Do not ride with a passenger.



Warning

Risk of misappropriation Usage by unauthorized persons.

- Never leave the vehicle while the engine is running. Secure the vehicle against use by unauthorized persons.



Info

When using your vehicle, remember that others may feel disturbed by excessive noise.

- Make sure that the pre-delivery inspection work has been carried out exclusively by an authorized KTM-RC8 workshop.
 - ✓ You receive a delivery certificate and the service record at vehicle handover.
- Before your first trip, read the entire operating instructions carefully.
- Get to know the controls.
- Adjust the basic position of clutch lever. (☞ p. 64)
- Adjust the basic position of hand brake lever. (☞ p. 66)
- Adjust the foot brake lever. (☞ p. 51)
- Adjust the shift lever. (☞ p. 50)
- Check and tune the setting of the quick shifter. ☞ (☞ p. 84)
- Become accustomed to the handling of the vehicle on suitable terrain. Try also to ride as slowly as possible to get a better feeling for the motorcycle.



Info

Your motorcycle is not authorized for riding on public roads.

- Hold the handlebar firmly with both hands and keep your feet on the footrests when riding.
- Run the engine in. (☞ p. 38)

Running the engine in

- Do not exceed the specified engine speed and load during the running-in period.

Guideline

Maximum engine speed	
During the first: 250 km (155.3 mi)	7,500 rpm
After the first: 250 km (155.3 mi)	10,500 rpm

- Avoid full-throttle operation!

Checks and maintenance measures when preparing for use



Info

Before every trip, check the condition of the vehicle and ensure that it is safe to operate. The vehicle must be in perfect technical condition when it is being operated.

- Check the engine oil level. (☛ p. 87)
- Check the front brake fluid level. (☛ p. 67)
- Check the rear brake fluid level. (☛ p. 68)
- Check the front brake linings. (☛ p. 68)
- Check the rear brake linings. (☛ p. 69)
- Check the brake system.
- Check the coolant level. (☛ p. 80)
- Check the chain for dirt. (☛ p. 61)
- Check the chain tension. (☛ p. 62)
- Check the tire condition. (☛ p. 74)
- Check the tire pressure. (☛ p. 75)
- Warm the tires to the operating temperature with a tire warmer.

Guideline

Tire temperature	78... 80 °C (172... 176 °F)
------------------	-----------------------------

Tire warmer set (58609085100)

- Check the adjustment and smooth operation of all controls.
- Check that the electrical equipment is functioning properly.
- Check the fuel level.
- Check the fuel overflow reservoir. (☛ p. 61)

Starting



Danger

Danger of poisoning Exhaust gases are poisonous and inhaling them may result in unconsciousness and/or death.

- When running the engine, always make sure there is sufficient ventilation, and do not start or run the engine in an enclosed space without an effective exhaust extraction system.



Caution

Danger of accidents If the vehicle is operated with a discharged battery or without a battery, electronic components and safety equipment may be damaged.



- Never operate the vehicle with a discharged battery or without a battery.

Note

Engine failure High engine speeds in cold engines have a negative effect on the service life of the engine.

- Always warm up the engine at low engine speeds.



- Switch on the ignition by pressing the emergency OFF switch into the position .
- ✓ After you switch on the ignition, you can hear the fuel pump working for about two seconds. The function test of the combination instrument is run at the same time.
- Shift into neutral.
- ✓ The green idling speed indicator lamp **N 1** lights up.
- Press the electric starter button .

i Info
 Do not press the electric starter button until the combination instrument function test finishes.
 When starting, **DO NOT** open the throttle. If you apply the throttle during the starting procedure, the engine management shuts off the injectors and the engine will not start.
 Press the starter for a maximum of 5 seconds. Wait for a least 5 seconds before trying again.

Refueling

! Danger
Fire hazard Fuel is highly flammable.

- Never refuel the vehicle near open flames or burning cigarettes, and always switch off the engine first. Be careful that no fuel is spilt, especially on hot vehicle components. Clean up spilt fuel immediately.
- Fuel in the fuel tank expands when warm and can escape if the tank is overfilled. See the notes on refueling.

! Warning
Danger of poisoning Fuel is poisonous and a health hazard.

- Avoid contact of the fuel with skin, eyes and clothing. Do not inhale fuel vapors. If fuel gets into your eyes, rinse immediately with water and contact a doctor. Wash affected skin areas immediately with soap and water. If fuel is swallowed, contact a doctor immediately. Change clothing that has come into contact with fuel.

Note
Material damage Premature clogging of the fuel filter.

- In some countries and regions, the available fuel quality and cleanliness may not be sufficient. This will result in problems with the fuel system. (Your authorized KTM RC8 workshop will be pleased to help.)
- Only refuel with clean fuel that meets the specified standards.

☀ Warning
Environmental hazard Improper handling of fuel is a danger to the environment.

- Do not allow fuel to get into the ground water, the ground, or the sewage system.



- Switch off the engine.
- Open the filler cap. (☛ p. 35)
- Fill the fuel tank with fuel up to the lower edge **1** of the fuel filler.

Total fuel tank capacity, approx.	16.5 l (4.36 US gal)	Super unleaded (ROZ 100) (☛ p. 119)
-----------------------------------	-------------------------	-------------------------------------

- Close the filler cap. (☛ p. 35)

Service schedule

	K025N	K10A	K50A	K100A
Check that the electrical equipment is functioning properly.	•	•	•	•
Read out the trouble code memory using the KTM diagnostics tool. 🛠️	•	•	•	•
Check the measured service values with the KTM diagnostics tool. 🛠️		•	•	•
Change the engine oil and filter, clean the oil screen. 🛠️ (👉 p. 87)	•	•	•	•
Check the oil jet for the clutch lubrication. 🛠️	•	•	•	•
Check the front brake linings. (👉 p. 68)	•	•	•	•
Check the front brake discs. (👉 p. 66)	•	•	•	•
Check the rear brake linings. (👉 p. 69)	•	•	•	•
Check the rear brake disc. (👉 p. 66)	•	•	•	•
Check that brake lines are undamaged and free of leaks.	•	•	•	•
Check the rear brake fluid level. (👉 p. 68)	•	•	•	•
Check the free travel of the foot brake lever.	•	•	•	•
Check that the shock absorber and fork are leak tight. If necessary and depending on use, service the fork and shock absorber.	•	•	•	•
Check the swingarm bearing. 🛠️		•	•	•
Check the wheel bearings for play. 🛠️		•	•	•
Check the tire condition. (👉 p. 74)	•	•	•	•
Check the tire pressure. (👉 p. 75)	•	•	•	•
Check the chain, rear sprocket and engine sprocket. (👉 p. 63)		•	•	•
Check the chain tension. (👉 p. 62)	•	•	•	•
Grease all moving parts (e.g., hand lever, chain, ...) and check for smooth operation. 🛠️	•	•	•	•
Clean the dust boots of the fork legs.			•	•
Check the front brake fluid level. (👉 p. 67)	•	•	•	•
Bleed the fork legs. (👉 p. 55)		•	•	•
Check the steering head bearing play.	•	•	•	•
Check the cylinder and piston. (under difficult riding conditions) 🛠️			•	•
Check the cylinder and piston. 🛠️				•
Check the connecting rod, conrod bearing, and crank pin. 🛠️				•
Check the crankshaft bearing. 🛠️				•
Check the transmission and shift mechanism. 🛠️				•
Check the oil pressure regulator valve. 🛠️				•
Check the oil pumps and lubrication system. 🛠️				•
Check the timing assembly. 🛠️				•
Check all engine bearings. 🛠️				•
Change the spark plugs. 🛠️			•	•
Change the valves, valve springs, and valve spring seats. 🛠️			•	•
Check the camshaft and cam lever. 🛠️			•	•
Check the cylinder head. 🛠️				•
Check the valve clearance. 🛠️			•	•
Check the clutch. 🛠️			•	•
Check all hoses (e.g. fuel, cooling, bleeder, drainage, etc.) and sleeves for cracking, leaks, and incorrect routing. 🛠️			•	•
Drain the drainage hose of the air filter box. 🛠️			•	•
Check the antifreeze and coolant level.	•	•	•	•
Check the wiring harness of the throttle valve body for damage and correct routing. 🛠️			•	•
Check cables for damage and kink-free routing. 🛠️		•	•	•
Check that the cables are undamaged, routed without sharp bends and set correctly.	•	•	•	•
Check the play in the throttle cable. (👉 p. 83)	•	•	•	•
Check the air filter and air filter box. 🛠️		•	•	•

	K025N	K10A	K50A	K100A
Check the fuel pressure. 🛠️		•	•	•
Check the value of the manifold absolute pressure sensor (PM value) with the KTM diagnostics tool. 🛠️		•	•	•
Check the fluid level of the hydraulic clutch. (📖 p. 64)		•	•	•
Change the hydraulic clutch fluid. 🛠️			•	•
Check screws and for tightness. 🛠️	•	•	•	•
Change the front brake fluid. 🛠️		•	•	•
Change the rear brake fluid. 🛠️		•	•	•
Check radiator fan operation. 🛠️	•	•	•	•
Final check: Check the vehicle for safe operation and take a test ride.	•	•	•	•
Read out the fault memory using the KTM diagnostics tool after a test ride. 🛠️	•	•	•	•
Set the service interval display. 🛠️	•	•	•	•
Make the service entry in KTM DEALER.NET and in the service record. 🛠️	•	•	•	•

K025N: Once after 250 km (155 mi)

K10A: Every 1,000 km (621.4 mi) or every year

K50A: Every 5,000 km (3,107 mi)

K100A: Every 10,000 km (6,214 mi)

Adjusting the compression damping of the fork

i Info
 The hydraulic compression damping determines the fork suspension behavior. An optimally adjusted compression damping ensures that the fork does not compress too far and fast when you brake hard or when the load shifts very fast. It gives the rider good feedback about the road conditions.

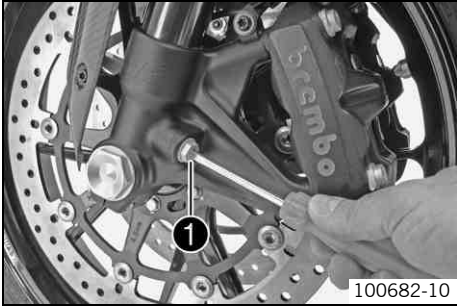

- Turn adjusting screws ❶ clockwise to the stop.

i Info
 The adjusting screws are located at the bottom end of the fork legs. Adjust both fork legs to the same setting.

- Turn back counterclockwise by the number of clicks corresponding to the fork type.
 Guideline

Compression damping	
Comfort	15 clicks
Standard	10 clicks
Sport	5 clicks
Full payload	5 clicks

i Info
 Turn clockwise to increase damping; turn counterclockwise to reduce damping.

Adjusting the rebound damping of the fork

i Info
 The hydraulic rebound damping determines the fork suspension behavior. An optimally adjusted rebound damping brakes the springing energy and enables a fast, vibration-free resetting of the fork to the zero position.



- Turn adjusting screws ❶ clockwise to the stop.

i Info
 The adjustment screws are located at the top end of the fork legs. Make the same adjustment on both fork legs.

- Turn back counterclockwise by the number of clicks corresponding to the fork type.
 Guideline

Rebound damping	
Comfort	15 clicks
Standard	10 clicks
Sport	5 clicks
Full payload	5 clicks

i Info
 Turn clockwise to increase suspension damping; turn counterclockwise to reduce damping.

Adjusting the spring preload of the fork

i Info
 Spring preload determines the initial fork position. The best spring preload setting is achieved when it is set for the weight of the rider and that of any baggage and a passenger, thus ensuring an ideal compromise between maneuverability and stability.



- Turn adjusting screws ❶ clockwise to the stop.

i Info
 The adjustment screws are located at the top end of the fork legs. Make the same adjustment on both fork legs.

- Turn back counterclockwise by the number of turns according to the fork type.
 Guideline

Spring preload - Preload Adjuster	
Comfort	5 turns
Standard	5 turns
Sport	3 turns
Full payload	3 turns

i Info
 Turn clockwise to increase preload, turn counterclockwise to reduce spring preload. Changing the spring preload has no influence on the rebound damping although the adjusting screws turn during the adjustment work. However, you should also adjust the rebound damping when you alter the spring preload.

Compression damping of the shock absorber

The compression damping of the shock absorber is divided into two ranges: high-speed and low-speed. High-speed and low-speed refer to the compression speed of the rear wheel suspension and not to the vehicle speed. The high-speed setting, for example, has an effect on the landing after a jump: the rear wheel suspension compresses more quickly. The low-speed setting, for example, has an effect when riding over long ground swells: the rear wheel suspension compresses more slowly. These two ranges can be adjusted separately, although the transition between high-speed and low-speed is gradual. Thus, changes in the high-speed range affect the compression damping in the low-speed range and vice versa.

Adjusting the low-speed compression damping of the shock absorber

⚠ Caution
Danger of accidents Disassembly of pressurized parts can lead to injury.

- The shock absorber is filled with high density nitrogen. Adhere to the description provided. (Your authorized KTM RC8 workshop will be pleased to help.)

i Info
 The low-speed setting can be seen during the slow to normal compression of the shock absorber.



- Turn adjusting screw ❶ clockwise up to the last perceptible click.
- Turn back counterclockwise by the number of clicks corresponding to the shock absorber type.

Guideline

Compression damping, low-speed	
Standard	10 clicks

i Info
 Turn clockwise to increase damping; turn counterclockwise to reduce damping.

Adjusting the high-speed compression damping of the shock absorber

- Caution**
Danger of accidents Disassembly of pressurized parts can lead to injury.
- The shock absorber is filled with high density nitrogen. Adhere to the description provided. (Your authorized KTM RC8 workshop will be pleased to help.)

Info
 The high-speed setting can be seen during the fast compression of the shock absorber.



- Turn adjusting screw ❶ clockwise up to the last perceptible click.
- Turn back counterclockwise the number of turns corresponding to the shock absorber type.

Guideline

Compression damping, high-speed	
Standard	10 clicks

Info
 Turn clockwise to increase damping; turn counterclockwise to reduce damping.

Adjusting the rebound damping of the shock absorber

- Caution**
Danger of accidents Disassembly of pressurized parts can lead to injury.
- The shock absorber is filled with high density nitrogen. Adhere to the description provided. (Your authorized KTM RC8 workshop will be pleased to help.)

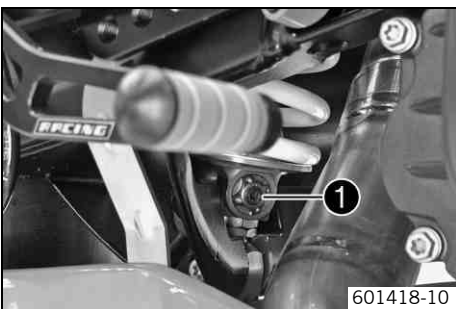

- Turn adjusting screw ❶ clockwise up to the last perceptible click.
- Turn back counterclockwise by the number of clicks corresponding to the shock absorber type.

Guideline

Rebound damping	
Standard	10 clicks

Info
 Turn clockwise to increase suspension damping; turn counterclockwise to reduce damping.

Adjusting the spring preload of the shock absorber ↩

- Warning**
Danger of accidents Modifications to the suspension settings can seriously alter the vehicle's ride behavior.
- Following modifications, ride slowly at first to get the feel of the new ride behavior.

Info
 The spring preload defines the initial situation of the spring process on the shock absorber. An optimally adjusted spring preload is adapted to the rider's weight and ensures a compromise between easy handling and stability.

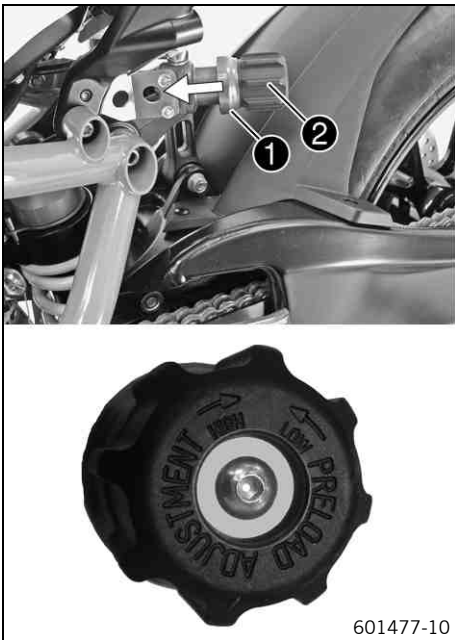

- Release lock ❶ by pressing in the direction of the arrow and turn handwheel ❷ all the way in the **LOW** direction.
- Let go of the lock ❶.
- Turn handwheel ❷ in the **HIGH** direction until the handwheel engages.

i Info
Turn clockwise to increase preload; turn counterclockwise to reduce spring preload.

Steering damper



The steering damper suppresses shocks to the steering arising from acceleration on uneven ground at high speed or when the load is temporarily taken from the front wheel.

The steering damper is adjusted to suit the riding style and the road conditions. For high speeds, a setting with high damping can be chosen to make the best possible use of the steering damper function. In slow, tight bends, intensive damping can negatively affect handling and steering precision, so the damping should be set to low.

Adjusting the steering damper

i Info
The hydraulic steering damper stabilizes the steering if the front wheel is raised off the ground or carries no load. In contrast to other damping elements, the steering damper is adjusted with the damping element open.

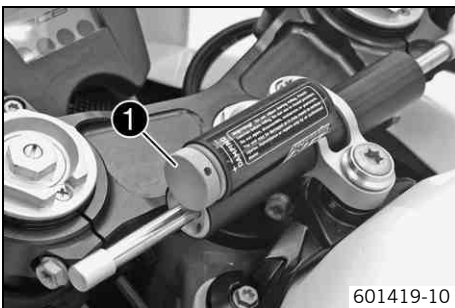

- Turn the adjusting screw ❶ counterclockwise towards "-" as far as the last perceptible click.
- Adjust the steering damper according to your riding style and the road conditions by turning the adjust screw clockwise towards "+".

Guideline

Steering damper adjustment range	1... 32 clicks
Recommended range for use	1... 20 clicks
Standard	1 click

i Info
Do not change the adjustment of the steering damper during the journey! After adjusting the steering damper, check the steering for smooth operation, making sure that the handlebar can be moved from extreme left to extreme right without a tendency to lock.

Vehicle level



Warning

Danger of accidents Modifications to the suspension settings can seriously alter the vehicle's ride behavior.

- Following modifications, ride slowly at first to get the feel of the new ride behavior.

The vehicle level can be adjusted at the front by means of the fork leg clamp and at the rear by the eccentric shaft.

The fork legs can be clamped at three positions in the triple clamp.

Upper triple clamp flush with upper edge of fork legs	0 mm (0 in)
Upper triple clamp flush with 1st ring of fork legs	2.5 mm (0.098 in)
Upper triple clamp flush with 2nd ring of fork legs (standard)	5 mm (0.2 in)

The infinitely variable frame height setting can be adjusted by turning the eccentric shaft.

Frame height difference HIGH - LOW	12 mm (0.47 in)
Maximum adjustment range between HIGH - LOW	180°

Adjusting front vehicle level ↶



Warning

Danger of accidents Modifications to the suspension settings can seriously alter the vehicle's ride behavior.

- Following modifications, ride slowly at first to get the feel of the new ride behavior.

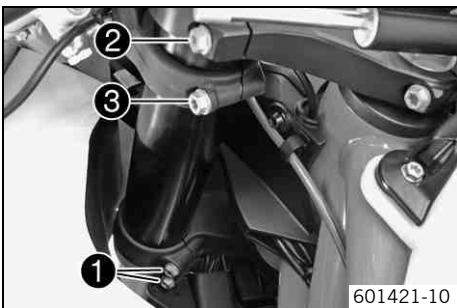

- Loosen screws ❶ on the lower triple clamp.
- Loosen screw ❷ on the upper triple clamp.
- Loosen screw ❸ of the handlebar stub.



Info

Loosen the screws far enough to prevent damage to the lacquer when the fork legs are moved.

Make the adjustments first on one fork leg and then on the other. When the screws of both fork legs are loosened, the vehicle sags toward the front.

- Align the fork leg in the desired position by means of the fork rings.

Guideline

Upper triple clamp flush with upper edge of fork legs	0 mm (0 in)
Upper triple clamp flush with 1st ring of fork legs	2.5 mm (0.098 in)
Upper triple clamp flush with 2nd ring of fork legs (standard)	5 mm (0.2 in)



Info

The standard adjustment is the setting that provides the best vehicle handling. When the fork is compressed, the suspension setting changes, causing the vehicle to become more stable but also more difficult to handle.



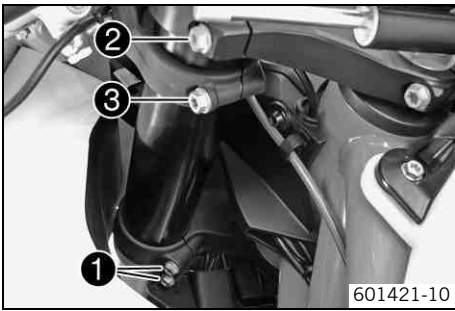

- Tighten screw ②.

Guideline

Screw, top triple clamp	M8	17 Nm (12.5 lbf ft)
-------------------------	----	------------------------

- Tighten screws ①.

Guideline

Screw, bottom triple clamp	M8	15 Nm (11.1 lbf ft)
----------------------------	----	------------------------

- Tighten screw ③.

Guideline

Screw, handlebar stub	M8	20 Nm (14.8 lbf ft)
-----------------------	----	------------------------

- Repeat the adjustment on the other fork leg.



Info

The vehicle level setting on both fork legs must be identical.

Adjusting the vehicle level at the rear



Warning

Danger of accidents Modifications to the suspension settings can seriously alter the vehicle's ride behavior.

- Following modifications, ride slowly at first to get the feel of the new ride behavior.

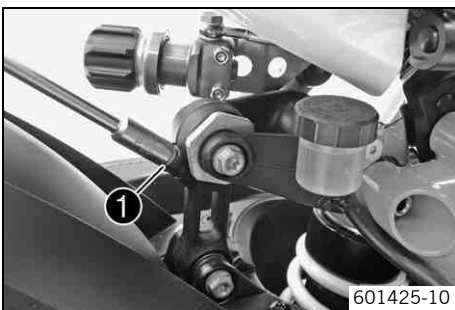

- Loosen screw ① but do not remove it.

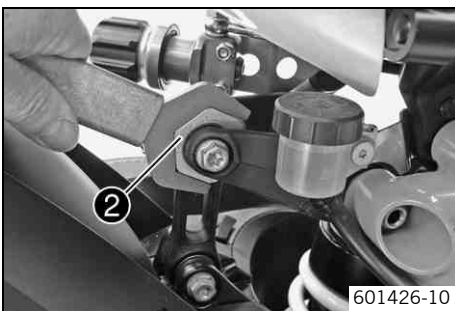

- Turn eccentric shaft ② to the desired position using the tool from the tool set.

Guideline

Standard	LOW
Maximum adjustment range between HIGH - LOW	180°

Open end wrench SW 38 (69012021000)



Info

The chassis height can be adjusted in both directions.

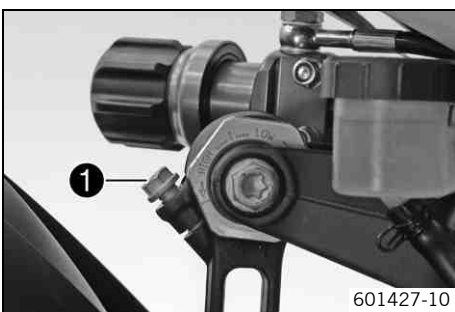

- Tighten screw ①.

Guideline

Screw, clamp, eccentric shaft of deflector	M8	18 Nm (13.3 lbf ft)
--	----	------------------------

Footrest position



The adjustable footrest system enables an individual setting of the footrest position and an individual adjustment of the controls.

The footrest holder can be mounted in 9 different positions on the footrest bracket. The lower footrest position enables a more comfortable knee angle, the upper footrest position a sporting sitting position and more forward-leaning freedom for use in racing.

Adjusting the footrest position



Info

The footrest position must be identical on the left and the right.

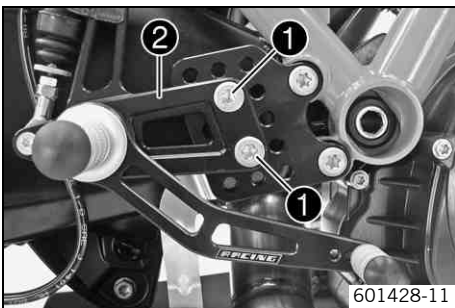

- Remove screws ❶.
- Position footrest holder ❷. Mount and tighten screws ❶.

Guideline

Screw, front footrest bracket	M8	25 Nm (18.4 lbf ft)	Loctite® 243™
-------------------------------	----	------------------------	---------------

- Repeat the operation on the opposite side.
- Adjust the foot brake lever. (☛ p. 51)
- Adjust the shift lever. (☛ p. 50)

Adjusting the shift lever stub

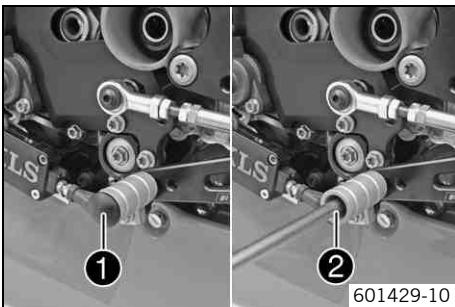

- Remove cap ❶.
- Remove screw ❷ with the shift lever stub.

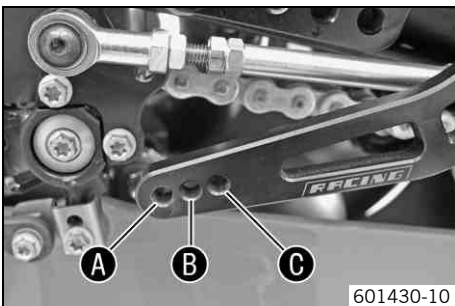

- Position the shift lever stub with the screw into drill hole A, B, or C, depending on the desired lever length.

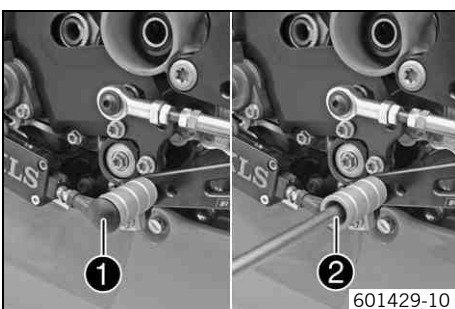

- Tighten screw ❷.

Guideline

Screw, shift lever stub	M6	10 Nm (7.4 lbf ft)	Loctite® 243™
-------------------------	----	-----------------------	---------------

- Mount cap ❶.

Adjusting the shift lever

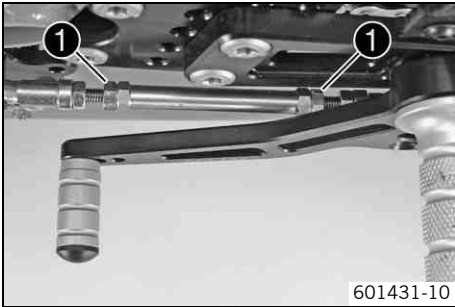

- Loosen nuts 1.

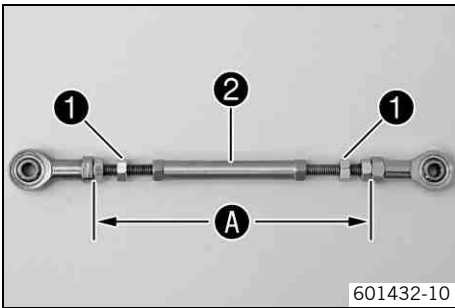

- Turn shift rod 2 while installed until the shift lever is in the desired position.

Guideline

Shift rod length A	≤ 132 mm (≤ 5.2 in)
--------------------	---------------------

i Info
If the adjustment range of the shift rod is insufficient, the positioning of the shift rod can be changed at the shift lever.

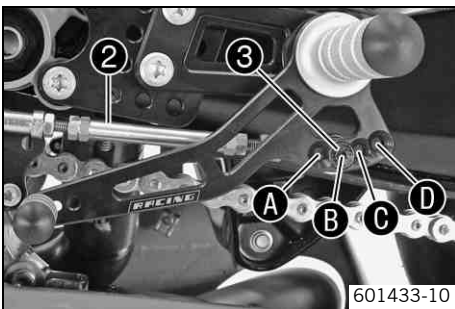

- Remove screw 3.
- Position shift rod 2 in one of the drill holes A - D. Mount and tighten screw 3.

Guideline

Screw, shift rod	M6	12 Nm (8.9 lbf ft)	Loctite® 243™
------------------	----	-----------------------	---------------

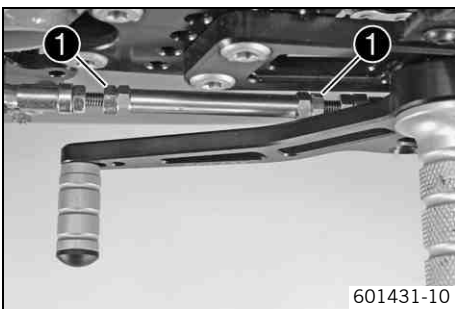

- Tighten nuts 1.

i Info
After the counter nuts have been tightened, the bearings of the shift shaft must be central and aligned identically to each other in order to ensure freedom of movement in the bearing shells.

Adjusting the foot brake lever stub

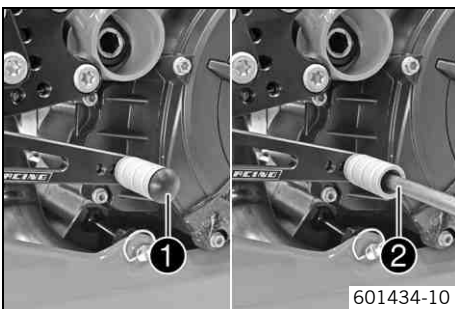

- Take off cap 1.
- Remove screw 2 with the foot brake lever stub.

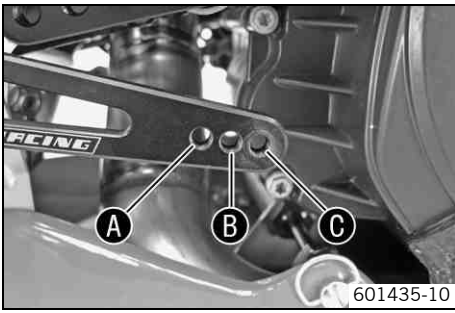

- Position the shift lever stub with the screw into drill hole **A**, **B**, or **C**, depending on the desired lever length.

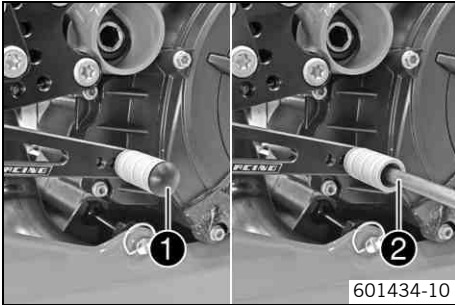

- Tighten screw **2**.

Guideline

Bolt, foot brake lever stub	M6	10 Nm (7.4 lbf ft)	Loctite® 243™
-----------------------------	----	-----------------------	---------------

- Mount cap **1**.

Adjusting the foot brake lever

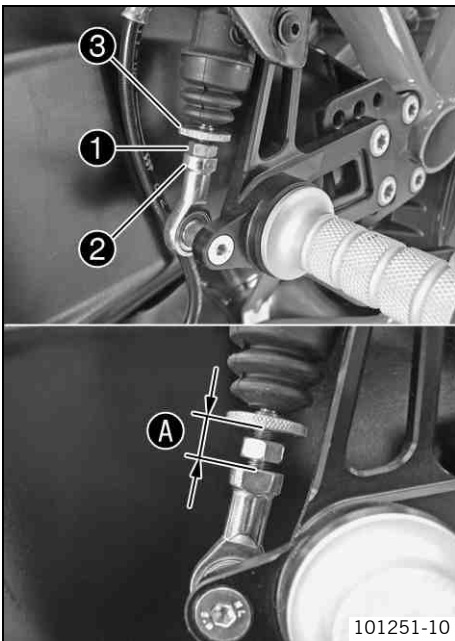

- Loosen lock nut **1** while holding heim joint **2**.
- Adjust the foot brake lever using handwheel **3**.

Guideline

Distance handwheel - heim joint A	≤ 10 mm (≤ 0.39 in)
--	---------------------

- Tighten lock nut **1** while holding heim joint **2**.

Handlebar height

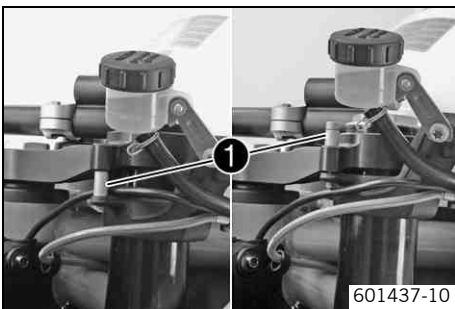

By removing or inserting distance sleeve **1**, you can set the handlebar height to two different positions.

Length, distance sleeve	15 mm (0.59 in)
-------------------------	-----------------

With distance sleeves, the handlebar stub is positioned low for sports use. Removing the distance sleeves gives a more upright sitting position.

Standard	Low position with distance sleeve
----------	-----------------------------------

Adjusting the handlebar height



Info

The handlebar stub position must be identical on the left and right of the vehicle.

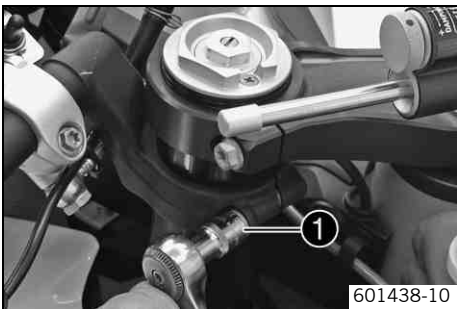

Adjusting the high position of the handlebar stubs:

- Loosen screw ❶.



Info

Loosen the screw several turns to prevent damage to the fork paint when moving the handlebar stub.

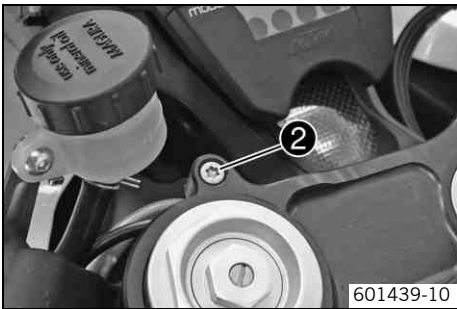

- Remove screw ❷.

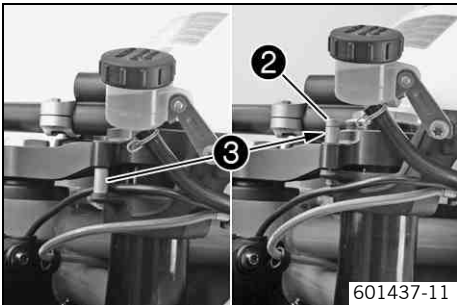

- Remove distance sleeve ❸.
- All cables routed under the upper triple clamp must now be routed under the handlebar stub.
- Push the handlebar stub carefully up to the upper triple clamp.
- Position distance sleeve ❸ above the triple clamp.
- Mount and tighten screw ❷.

Guideline

Remaining frame bolts	M5	5 Nm (3.7 lbf ft)
-----------------------	----	-------------------



- Tighten screw ❶.

Guideline

Screw, handlebar stub	M8	20 Nm (14.8 lbf ft)
-----------------------	----	---------------------

- Repeat the adjustments on the other handlebar stub.
- Move the handlebar to and fro over the entire steering range.
 - » If the cables restrict the freedom of movement of the steering:
 - Correct the cable routing.

Adjusting the low position of the handlebar stubs:

- Loosen screw ❶.



Info

Loosen the screw several turns to prevent damage to the fork paint when moving the handlebar stub.



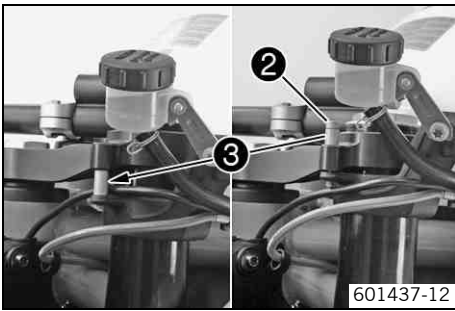

- Remove screw ② with distance sleeve ③.
- Carefully shift the handlebar stub by the length of the distance sleeve.

Guideline

Length, distance sleeve	15 mm (0.59 in)
-------------------------	-----------------

- Lay all cables between the upper triple clamp and the handlebar stub.
- Position distance sleeve ③.

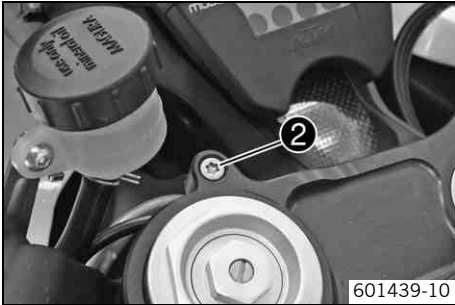

- Mount and tighten screw ②.

Guideline

Remaining frame bolts	M5	5 Nm (3.7 lbf ft)
-----------------------	----	-------------------

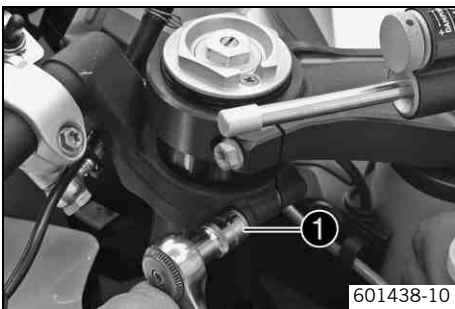

- Tighten screw ①.

Guideline

Screw, handlebar stub	M8	20 Nm (14.8 lbf ft)
-----------------------	----	------------------------

- Repeat the adjustments on the other handlebar stub.
- Move the handlebar to and fro over the entire steering range.
 - » If the cables restrict the freedom of movement of the steering:
 - Correct the cable routing.

Raising the rear of the motorcycle with lifting gear

Note

Danger of damage The parked vehicle may roll away or fall over.

- Always place the vehicle on a firm and even surface.

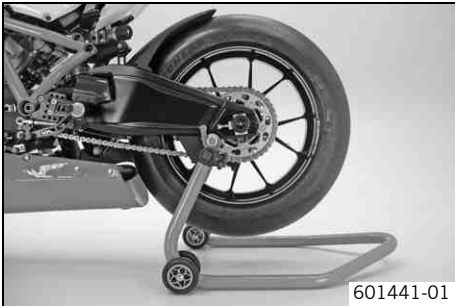

- Insert the adapter into the lifting gear at the rear.

Adapter (61029055120)

Rear wheel stand (61029055400)

- Stand the motorcycle upright, align the lifting gear to the link fork and the adapters, and raise the motorcycle.

Removing the rear of motorcycle from the lifting gear

Note

Danger of damage The parked vehicle may roll away or fall over.

- Always place the vehicle on a firm and even surface.
- Secure the motorcycle against falling over.
- Remove the lift stand from the rear and lean the vehicle on the side stand.

Raising the front of the motorcycle with lifting gear

Note

Danger of damage The parked vehicle may roll away or fall over.

- Always place the vehicle on a firm and even surface.

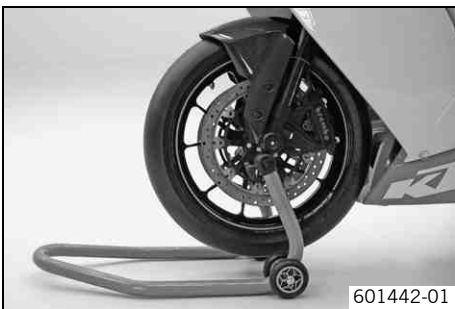

- Raise the rear of the motorcycle with lifting gear. (☛ p. 54)
- Move the handlebar to the straight-ahead position. Align the lifting gear at the front with the adapters to the fork legs.

Front wheel stand (61029055300)



Info

Always raise the rear of the motorcycle first.

- Raise the motorcycle at the front.

Taking the motorcycle off of the front wheel stand

Note

Danger of damage The parked vehicle may roll away or fall over.

- Always place the vehicle on a firm and even surface.
- Secure the motorcycle against falling over.
- Remove the lifting gear from the front.

Bleeding the fork legs

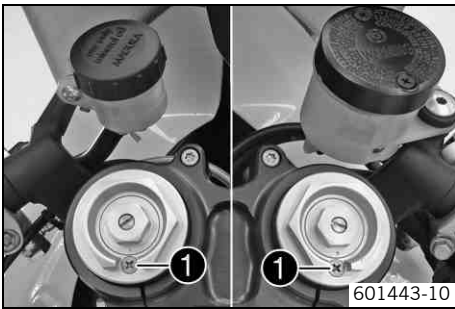

601443-10

- Raise the rear of the motorcycle with lifting gear. (🔧 p. 54)
- Remove bleeder screws ❶ briefly.
- ✓ Any excess pressure escapes from the interior of the fork.
- Mount and tighten bleeder screws.



Info

Perform this action on both fork legs.

Removing the seat

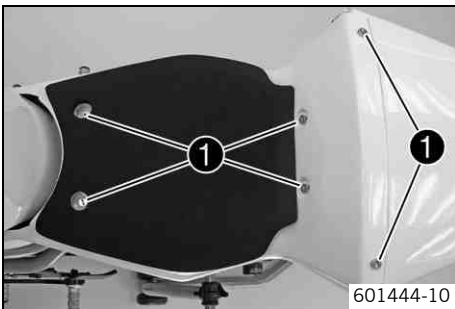

601444-10

- Unlock quick releases ❶ and remove the seat.

Fitting the seat

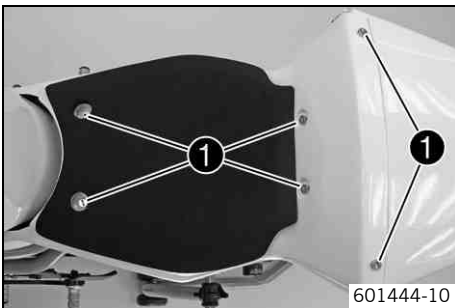

601444-10

- Position the seat with quick releases ❶.
- Lock quick releases ❶.

Removing the air filter 🗑️

Note

Engine failure Unfiltered intake air has a negative effect on the service life of the engine.

- Never ride the vehicle without an air filter since dust and dirt can get into the engine and result in increased wear.

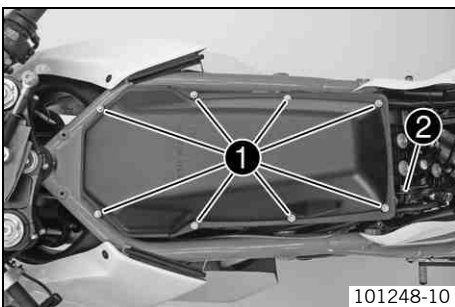

101248-10

- Remove the fuel tank. 🗑️ (🔧 p. 58)
- Remove screws ❶.
- Slide back clamp ❷. Pull off the engine breather hose and take off the clamp.
- Take off the filter box top.



Info

Watch out for the engine breather hose.

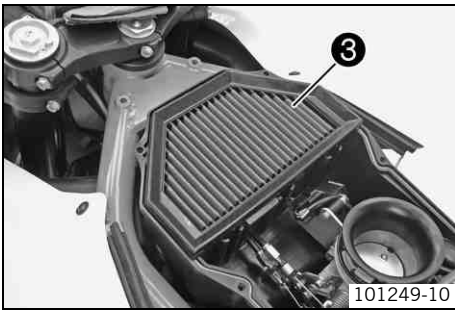

- Remove air filter ③.
- Clean the air filter box.

Installing the air filter 🛠️

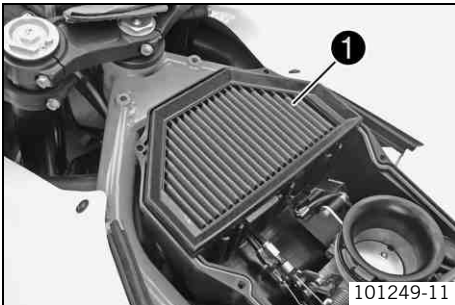

- Position air filter ①.

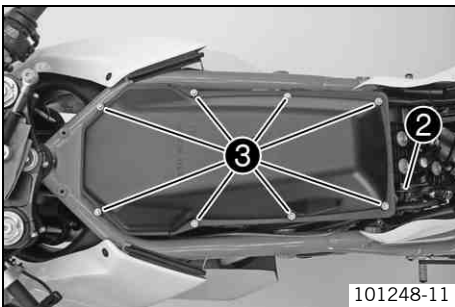

- Position the filter box top with the engine breather hose. Mount clamp ② with the engine breather hose.
- Tighten screws ③.
- Install the fuel tank. 🛠️ (📖 p. 59)

Cleaning the air filter 🛠️



Warning

Environmental hazard Hazardous substances cause environmental damage.

- Oil, grease, filters, fuel, cleaners, brake fluid, etc., should be disposed of as stipulated in applicable regulations.



Info

Do not clean the air filter with fuel or petroleum.



- Remove the air filter. 🛠️ (📖 p. 55)
- Tap to remove coarse dirt. Brush off the air filter with a soft brush.
- Spray on cleaner and leave it on for 10 minutes.

Air filter cleaner (📖 p. 120)

- Rinse the air filter from the inside to the outside with a gentle spray of water.
- Shake off remaining water. Let the air filter dry.



Info

Do not use compressed air to dry the filter.

- Thoroughly spray the dry air filter with filter oil.

Air filter oil (📖 p. 120)

- Leave the filter oil on the filter for 20 minutes.
- Clean the air filter box.
- Check the distribution of the filter oil.

- » If unoiled areas are visible:
 - Oil the air filter again.
- Wipe off excess filter oil.



Info

Do not apply too much oil to the air filter.

- Install the air filter. 🛠️ (📖 p. 56)

Removing the left side cover

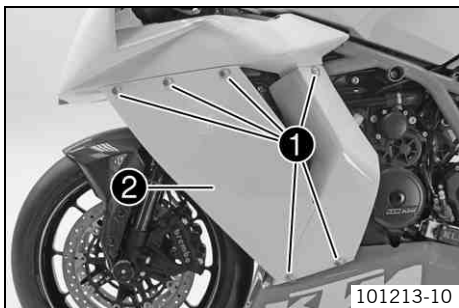

- Unlock quick releases ❶.
- Take off side cover ❷.

Installing the left side cover

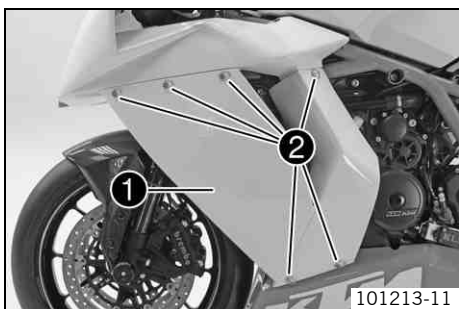

- Position side cover ❶.
- Lock quick releases ❷.

Removing the right side cover

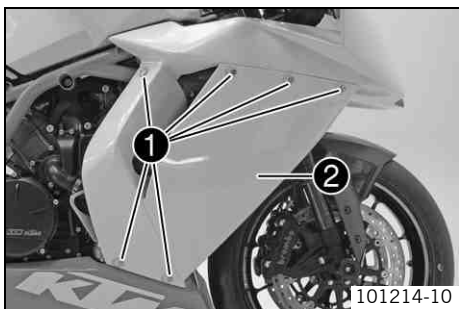

- Unlock quick releases ❶.
- Take off side cover ❷.

Installing the right side cover

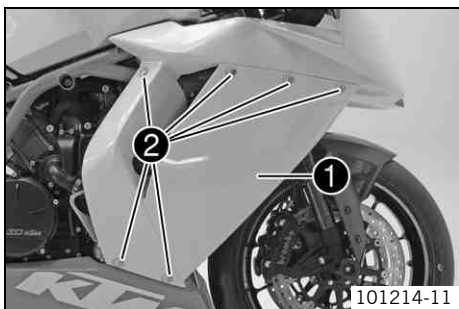

- Position side cover ❶.
- Lock quick releases ❷.

Removing the exhaust cover

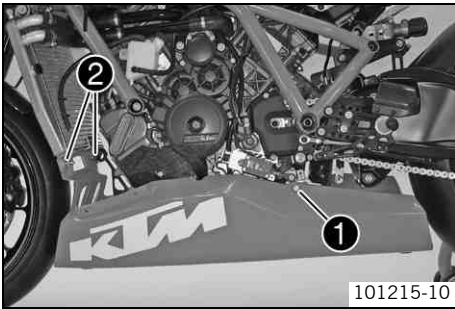

101215-10

- Remove the right side cover. (☛ p. 57)
- Remove the left side cover. (☛ p. 57)
- Unlock quick release ❶.
- Repeat the operation on the opposite side.
- Detach the exhaust cover from radiator ❷ and remove.

Installing the exhaust cover

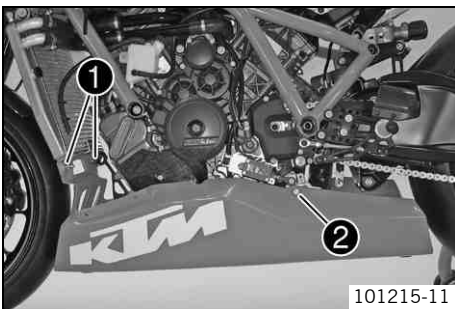

101215-11

- Attach the exhaust cover to radiator ❶ and position at the rear.
- Lock quick release ❷.
- Repeat the operation on the opposite side.
- Install the left side cover. (☛ p. 57)
- Install the right side cover. (☛ p. 57)

Removing the fuel tank



Danger

Fire hazard Fuel is highly flammable.

- Never refuel the vehicle near open flames or burning cigarettes, and always switch off the engine first. Be careful that no fuel is spilt, especially on hot vehicle components. Clean up spilt fuel immediately.
- Fuel in the fuel tank expands when warm and can escape if the tank is overfilled. See the notes on refueling.



Warning

Danger of poisoning Fuel is poisonous and a health hazard.

- Avoid contact between fuel and skin, eyes and clothing. Do not inhale fuel vapors. If fuel gets into your eyes, rinse immediately with water and contact a doctor. Wash affected skin areas immediately with soap and water. If fuel is swallowed, contact a doctor immediately. Change clothing that has come into contact with fuel. Store fuel in a suitable canister according to regulations and keep it out of the reach of children.

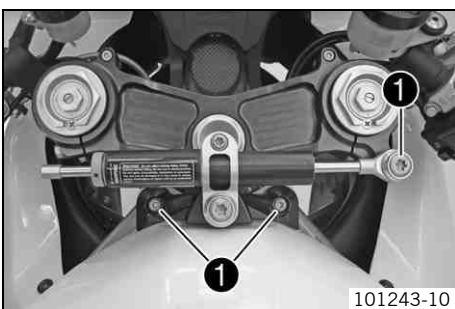

101243-10

- Remove the seat. (☛ p. 55)
- Remove screws ❶ of the steering damper.
- Remove the steering damper.

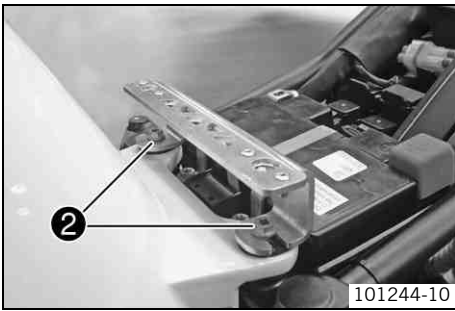

- Remove screws ②.

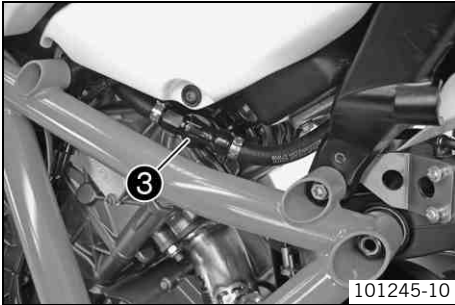

- Clean and disconnect fuel hose connection ③.



Info

Remaining fuel may run out of the fuel hose.

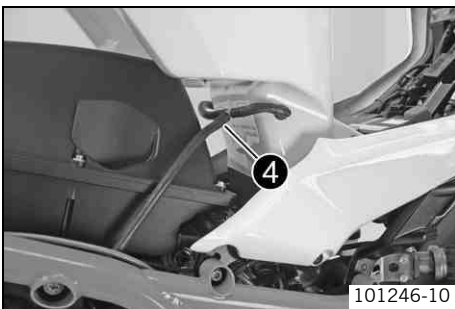

- Raise the front of the fuel tank.
- Detach overflow hose ④ from the T-piece.

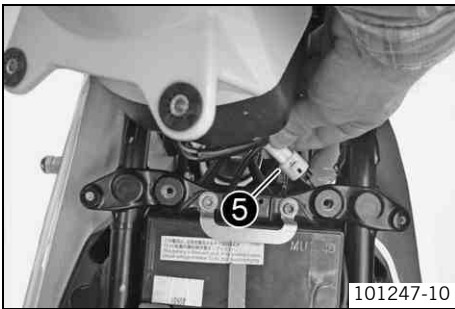

- Raise the rear of the fuel tank.
- Disconnect electric plug-in connector ⑤ of the fuel pump.
- Take off the fuel tank.

Installing the fuel tank ↩



Danger

Fire hazard Fuel is highly flammable.

- Never refuel the vehicle near open flames or burning cigarettes, and always switch off the engine first. Be careful that no fuel is spilt, especially on hot vehicle components. Clean up spilt fuel immediately.
- Fuel in the fuel tank expands when warm and can escape if the tank is overfilled. See the notes on refueling.



Warning

Danger of poisoning Fuel is poisonous and a health hazard.

- Avoid contact between fuel and skin, eyes and clothing. Do not inhale fuel vapors. If fuel gets into your eyes, rinse immediately with water and contact a doctor. Wash affected skin areas immediately with soap and water. If fuel is swallowed, contact a doctor immediately. Change clothing that has come into contact with fuel. Store fuel in a suitable canister according to regulations and keep it out of the reach of children.

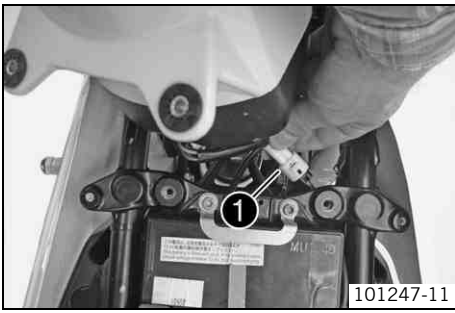

- Position the fuel tank.
- Connect electric plug-in connector ❶ of the fuel pump.

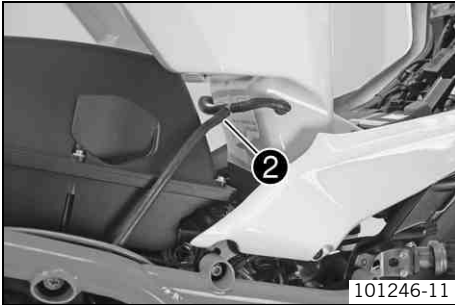

- Position the fuel tank and raise it at the front.
- Connect overflow hose ❷.
- Lower the front of the fuel tank.

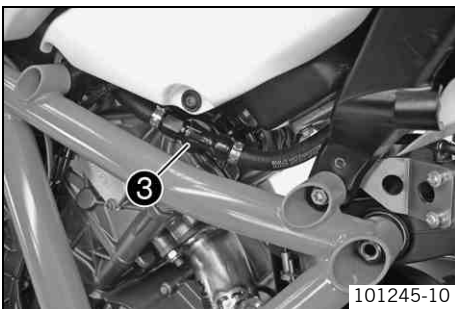

- Connect fuel hose connector ❸ with the new O-ring.

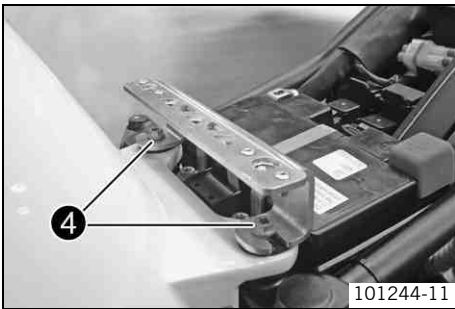

- Mount and tighten screws ❹.

Guideline

Remaining chassis screws	M6	10 Nm (7.4 lbf ft)
--------------------------	----	--------------------

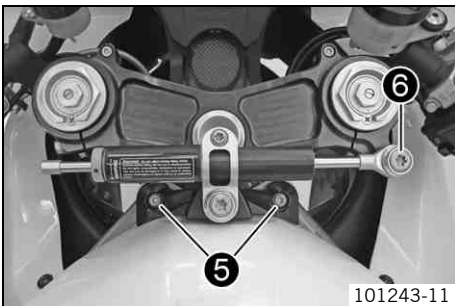

- Position the steering damper.
- Mount and tighten screws ❺.

Guideline

Remaining chassis screws	M6	10 Nm (7.4 lbf ft)
--------------------------	----	--------------------

- Mount and tighten screw ❻.

Guideline

Screw, steering damper fixing bracket on triple clamp	M8	10 Nm (7.4 lbf ft)	Loctite® 243™
---	----	--------------------	---------------

- Fit the seat. (🔗 p. 55)

Checking the fuel overflow reservoir

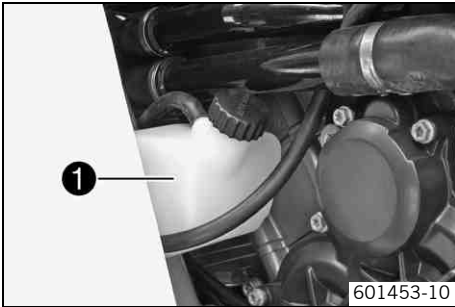

- Check the fluid level in the fuel overflow reservoir.
 - » If there is fluid in the fuel overflow reservoir:
 - Empty the fuel overflow reservoir. (☛ p. 61)

Emptying the fuel overflow reservoir

- Warning**
Danger of poisoning Fuel is poisonous and a health hazard.
- Avoid contact of the fuel with skin, eyes and clothing. Do not inhale fuel vapors. If fuel gets into your eyes, rinse immediately with water and contact a doctor. Wash affected skin areas immediately with soap and water. If fuel is swallowed, contact a doctor immediately. Change clothing that has come into contact with fuel.

- Warning**
Environmental hazard Improper handling of fuel is a danger to the environment.
- Do not allow fuel to get into the ground water, the ground, or the sewage system.

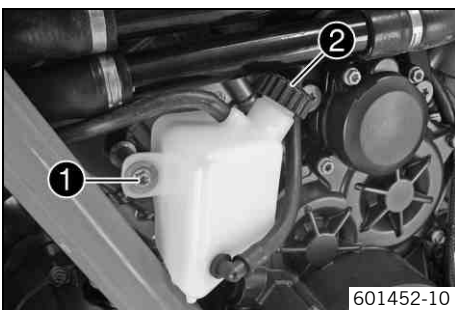

- Remove the left side cover. (☛ p. 57)
- Remove screw 1.
- Open cover 2 and empty the fuel overflow reservoir.
- Close cover 2.
- Position the fuel overflow reservoir. Mount and tighten screw 1.

Guideline

Remaining chassis screws	M6	10 Nm (7.4 lbf ft)
--------------------------	----	--------------------

- Install the left side cover. (☛ p. 57)

Checking for chain dirt

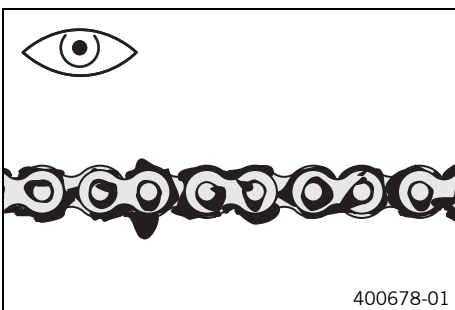

- Check the chain for loose dirt.
 - » If the chain is very dirty:
 - Clean the chain. (☛ p. 61)

Cleaning the chain

- Warning**
Danger of accidents Oil or grease on the tires reduces their grip.
- Remove oil and grease with a suitable cleaning material.

- Warning**
Danger of accidents Reduced braking efficiency due to oil or grease on the brake discs.
- Always keep the brake discs free of oil and grease, and clean them with brake cleaner when necessary.

- Warning**
Environmental hazard Hazardous substances cause environmental damage.
- Oil, grease, filters, fuel, cleaners, brake fluid, etc., should be disposed of as stipulated in applicable regulations.



Info

The service life of the chain depends largely on its maintenance.

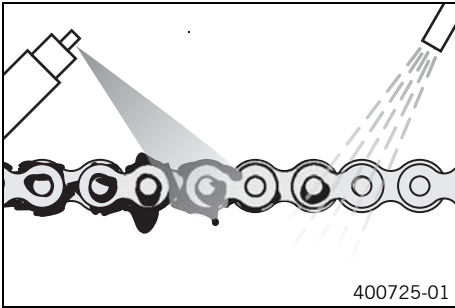

- Clean the chain regularly.
- Rinse off loose dirt with a soft jet of water.
- Remove old grease remains with chain cleaner.

Chain cleaner (☛ p. 120)

- After drying, apply chain spray.

Chain lube for road use (☛ p. 120)

Checking the chain tension



Warning

Danger of accidents Danger caused by incorrect chain tension.

- If the chain tension is too high, the components of the secondary power train (chain, engine sprocket, rear sprocket, bearings in transmission and rear wheel) are under additional load. Apart from premature wear, in extreme cases the chain can rupture or the countershaft of the transmission can break. On the other hand, if the chain is loose, it can fall off the engine sprocket or the rear sprocket and block the rear wheel or damage the engine. Check the chain tension and correct if necessary.

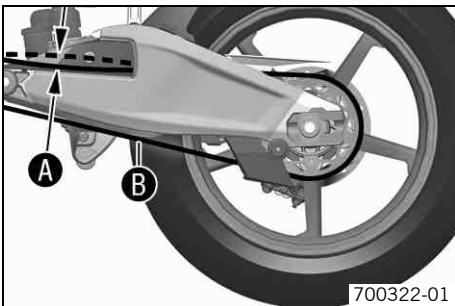

- Raise the rear of the motorcycle with lifting gear. (☛ p. 54)
- Shift into neutral.
- In the area in front of where the chain passes through the link fork, push the chain upward and measure chain tension **A**.



Info

The lower chain section **B** must be taut.

Chain wear is not always even, so you should repeat this measurement at different chain positions.

Chain tension	15... 20 mm (0.59... 0.79 in)
---------------	-------------------------------

- » If the chain tension does not meet specifications:
 - Adjust the chain tension. (☛ p. 62)

Adjusting the chain tension



Warning

Danger of accidents Danger caused by incorrect chain tension.

- If the chain tension is too high, the components of the secondary power train (chain, engine sprocket, rear sprocket, bearings in transmission and rear wheel) are under additional load. Apart from premature wear, in extreme cases the chain can rupture or the countershaft of the transmission can break. On the other hand, if the chain is loose, it can fall off the engine sprocket or the rear sprocket and block the rear wheel or damage the engine. Check the chain tension and correct if necessary.

- Check the chain tension. (☛ p. 62)
- Remove the rear frame sliders. (☛ p. 72)

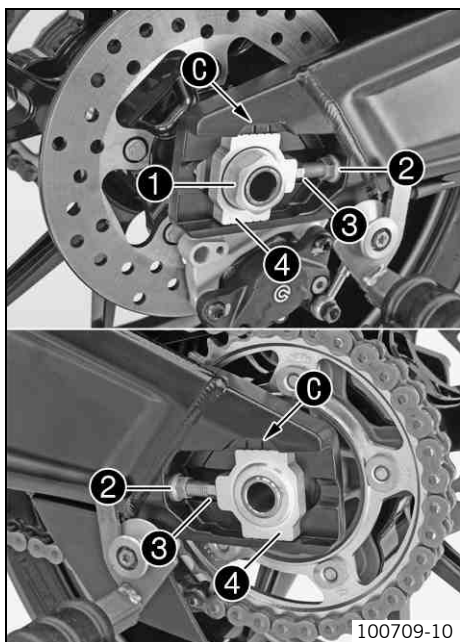

- Loosen nut ①.
- Loosen nuts ②.
- Adjust the chain tension by turning adjusting screws ③ on the left and right.

Guideline

Chain tension	15... 20 mm (0.59... 0.79 in)
Turn adjusting screws ③ on the left and right so that the markings on the left and right chain adjuster ④ are in the same position in relation to the reference marks ①. The rear wheel is then correctly aligned.	



Info

The lower chain section must be taut. Chain wear is not always even, so you should check the setting at different chain positions.

- Tighten nuts ②.
- Make sure that chain adjusters ④ are in contact with adjusting screws ③.
- Tighten nut ①.

Guideline

Nut, rear wheel spindle	M25x1.5	90 Nm (66.4 lbf ft)	Thread greased
-------------------------	---------	------------------------	----------------



Info

The wide adjustment range of the chain adjuster (35 mm/1.38") allows different secondary transmission ratios to be used with the same chain length. Chain adjusters ④ can be turned through 180°.

- Install the rear frame sliders. (☛ p. 72)

Checking the chain, rear sprocket and engine sprocket

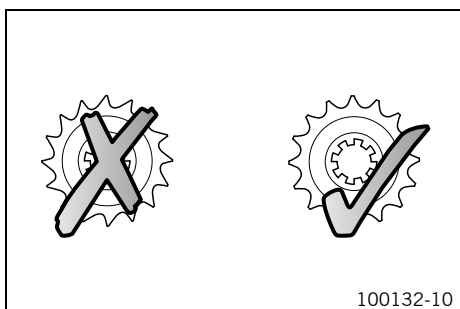

- Check the rear sprocket and engine sprocket for wear.
 - » If the rear sprocket and engine sprocket are worn:
 - Replace the rear sprocket or engine sprocket. ☛



Info

The engine sprocket, rear sprocket and chain should always be replaced together.

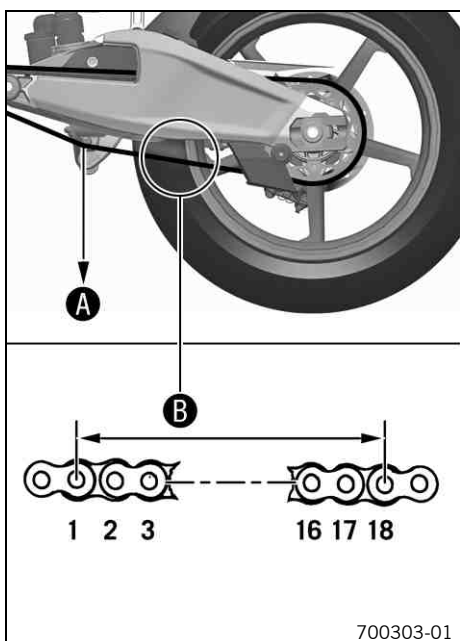

- Shift into neutral.
- Pull the lower chain section with specified weight ①.

Guideline

Weight, chain wear measurement	15 kg (33 lb.)
--------------------------------	----------------

- Measure the distance ② of 18 chain links in the lower chain section.



Info

Chain wear is not always even, so you should repeat this measurement at different chain positions.

Maximum distance ② at the longest chain section	272 mm (10.71 in)
---	-------------------

- » If distance ② is greater than the specified measurement:
 - Replace the chain. ☛



Info

When the chain is replaced, the rear sprocket and engine sprocket should also be changed. A new chain wears out faster on old, worn sprockets. For safety reasons, the chain has no chain joint.

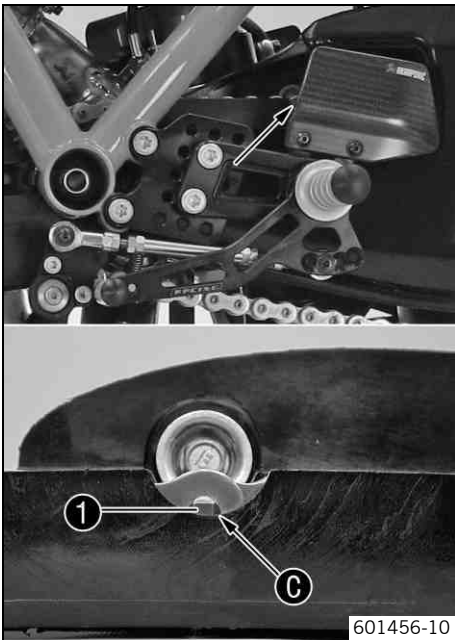

- Check the chain sliding guard for wear at the opening.
 - » If the rivets ① of the chain are no longer visible at the lower edge ② of the opening of the chain sliding guard:
 - Change the chain sliding guard. 🛠️
- Check that the chain sliding guard is firmly seated.
 - » If the chain sliding guard is loose:
 - Tighten the chain sliding guard.

Guideline

Screw, chain sliding guard	M5	5 Nm (3.7 lbf ft)
----------------------------	----	----------------------

Adjusting basic position of clutch lever

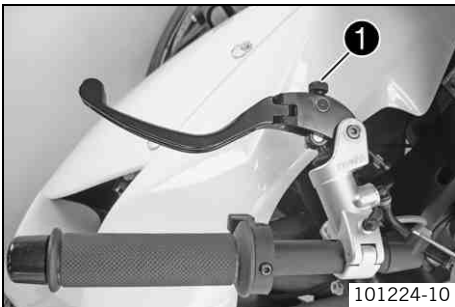

- Adjust the basic setting of the clutch lever to your hand size by turning adjusting screw ①.

i Info

Turn the adjusting screw clockwise to increase the distance between the clutch lever and the handlebar.
 Turn the adjusting screw counterclockwise to decrease the distance between the clutch lever and the handlebar.
 The range of adjustment is limited.
 Turn the adjusting screw by hand only, and do not apply any force.
 Do not make any adjustments while riding!

Checking fluid level of hydraulic clutch

i Info

The fluid level rises with increasing wear of the clutch lining disc.
 Do not use brake fluid.



- Move the clutch fluid reservoir mounted on the handlebar to a horizontal position.
- Check the fluid level.

The fluid level must be between the **MIN** and **MAX** markings.

- » If the coolant level does not meet specifications:
 - Correct the fluid level of the hydraulic clutch. (🔧 p. 65)

Correcting fluid level of hydraulic clutch



Info

The fluid level rises with increasing wear of the clutch lining disc.
Do not use brake fluid.



- Move the clutch fluid reservoir mounted on the handlebar to a horizontal position.
- Remove screw cap with membrane.
- Correct the fluid level.

Guideline

The fluid level must be between the **MIN** and **MAX** markings.

Hydraulic fluid (15) (☛ p. 119)

- Refit the screw cap with the membrane.

Checking the front brake discs



Warning

Danger of accidents Reduced braking efficiency due to worn brake disc(s).

- Change the worn brake disc(s) without delay. (Your authorized KTM RC8 workshop will be pleased to help.)

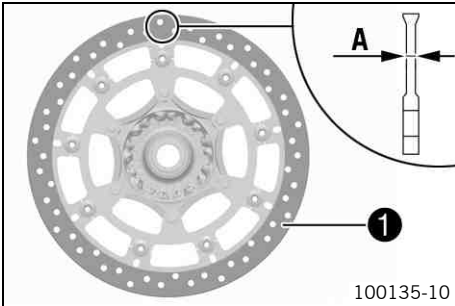

- Check the thickness of the brake disc in several places to see if it is within the specified wear tolerance **A**.



Info

Wear reduces the thickness of the brake discs in area **1** of the brake discs.

Brake discs - wear limit

Front	4.5 mm (0.177 in)
-------	-------------------

- » If the brake disc thickness is less than the specified value:
 - Change the brake discs. 🛠️
- Check the brake discs for damage, cracking and deformation.
 - » If the brake discs exhibit damage, cracking or deformation:
 - Change the brake discs. 🛠️

Checking the rear brake disc



Warning

Danger of accidents Reduced braking efficiency due to worn brake disc(s).

- Change the worn brake disc(s) without delay. (Your authorized KTM RC8 workshop will be pleased to help.)

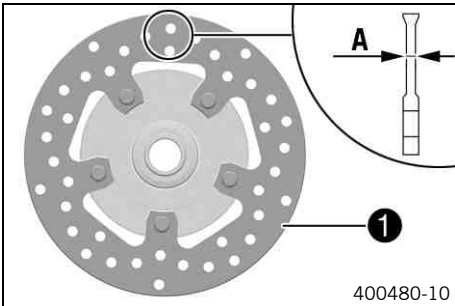

- Check the thickness of the brake disc in several places to see if it conforms to measurement **A**.



Info

Wear reduces the thickness of the brake disc in area **1** of the brake disc.

Brake disc - wear limit

Rear	4.5 mm (0.177 in)
------	-------------------

- » If the brake disc thickness is less than the specified value:
 - Change the brake disc. 🛠️
- Check the brake disc for damage, cracking and deformation.
 - » If damage, cracks or deformation are visible on the brake disc:
 - Change the brake disc. 🛠️

Adjusting the basic position of the hand brake lever

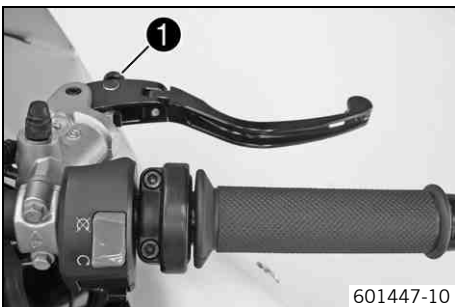

- Pull the brake lever forwards.
- Adjust the basic setting of the hand brake lever to your hand size by turning adjusting wheel **1**.



Info

Do not make any adjustments while riding!

Checking the front brake fluid level



Warning

Danger of accidents Failure of the brake system.

- If the brake fluid level falls below the **MIN** mark, this indicates a leakage in the brake system or worn-out brake linings. Check the brake system and do not continue riding. (Your authorized KTM RC8 workshop will be pleased to help.)



Warning

Danger of accidents Reduced braking effect caused by old brake fluid.

- Change the brake fluid of the front and rear brake according to the service schedule. (Your authorized KTM RC8 workshop will be pleased to help.)

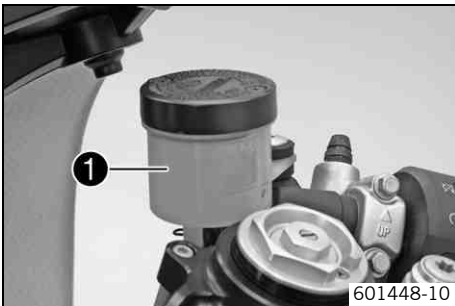

- Move the brake fluid reservoir mounted on the handlebar to a horizontal position.
- Check the brake fluid level in the brake fluid reservoir ❶.
 - » If the brake fluid is below the **MIN** marking:
 - Add front brake fluid. 🛠️ (📖 p. 67)

Adding brake fluid of front brake 🛠️



Warning

Danger of accidents Failure of the brake system.

- If the brake fluid level falls below the **MIN** mark, this indicates a leakage in the brake system or worn-out brake linings. Check the brake system and do not continue riding. (Your authorized KTM RC8 workshop will be pleased to help.)



Warning

Skin irritation Brake fluid can cause skin irritation on contact.

- Avoid contact with skin and eyes, and keep out of the reach of children.
- Wear suitable protective clothing and goggles.
- If brake fluid comes into contact with the eyes, flush the eyes thoroughly with water and consult a physician immediately.



Warning

Danger of accidents Reduced braking effect caused by old brake fluid.

- Change the brake fluid of the front and rear brake according to the service schedule. (Your authorized KTM RC8 workshop will be pleased to help.)



Warning

Environmental hazard Hazardous substances cause environmental damage.

- Oil, grease, filters, fuel, cleaners, brake fluid, etc., should be disposed of as stipulated in applicable regulations.



Info

Never use DOT 5 brake fluid! It is silicone-based and purple in color. Oil seals and brake lines are not designed for DOT 5 brake fluid.

Avoid contact between brake fluid and painted parts. Brake fluid is corrosive and will damage painted surfaces.

Use only clean brake fluid from a sealed container!

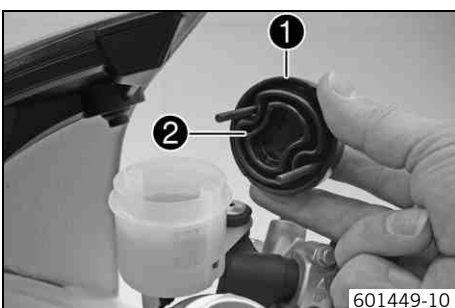

- Move the brake fluid reservoir mounted on the handlebar to a horizontal position.
- Loosen screw.
- Remove cap ❶ with membrane ❷.
- Add brake fluid to the **MAX** level.

Brake fluid DOT 4 / DOT 5.1 (📖 p. 118)

- Position the cap with the membrane. Mount and tighten the screws.

**Info**

Clean up overflowed or spilt brake fluid immediately with water.

Checking the front brake linings**Warning**

Danger of accidents Reduced braking efficiency caused by worn brake linings.

- Change worn brake linings immediately. (Your authorized KTM RC8 workshop will be pleased to help.)

Note

Danger of accidents Reduced braking efficiency caused by damaged brake discs.

- If the brake linings are not changed in time, the steel brake lining carriers grind on the brake disc. The braking effect is greatly reduced and the brake discs are rendered unserviceable. Check the brake linings regularly.

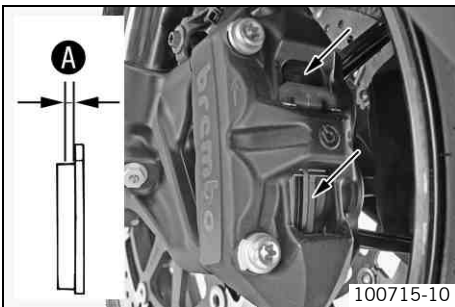

- Check all brake linings on both brake calipers to ensure they have minimum thickness **A**.

Minimum thickness A	$\geq 1 \text{ mm } (\geq 0.04 \text{ in})$
----------------------------	---

- » If the minimum thickness is less than specified:
 - Change the front brake linings. 🛠️
- Check all brake linings on both brake calipers for damage and cracking.
 - » If damage or wear is encountered:
 - Change the front brake linings. 🛠️

Checking the rear brake fluid level**Warning**

Danger of accidents Failure of the brake system.

- If the brake fluid level falls below the **MIN** mark, this indicates a leakage in the brake system or worn-out brake linings. Check the brake system and do not continue riding. (Your authorized KTM RC8 workshop will be pleased to help.)

**Warning**

Danger of accidents Reduced braking effect caused by old brake fluid.

- Change the brake fluid of the front and rear brake according to the service schedule. (Your authorized KTM RC8 workshop will be pleased to help.)

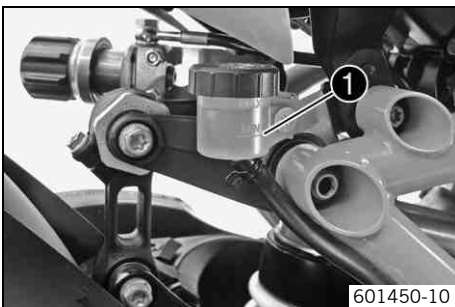

- Stand the vehicle upright.
- Check the brake fluid level of the brake fluid reservoir.
 - » If the fluid level reaches the **MIN** mark ❶:
 - Add rear brake fluid. 🛠️ (📄 p. 68)

Adding rear brake fluid 🛠️**Warning**

Danger of accidents Failure of the brake system.

- If the brake fluid level falls below the **MIN** mark, this indicates a leakage in the brake system or worn-out brake linings. Check the brake system and do not continue riding. (Your authorized KTM RC8 workshop will be pleased to help.)

**Warning**

Skin irritation Brake fluid can cause skin irritation on contact.

- Avoid contact with skin and eyes, and keep out of the reach of children.
- Wear suitable protective clothing and goggles.
- If brake fluid comes into contact with the eyes, flush the eyes thoroughly with water and consult a physician immediately.

- Warning**
Danger of accidents Reduced braking effect caused by old brake fluid.
- Change the brake fluid of the front and rear brake according to the service schedule. (Your authorized KTM RC8 workshop will be pleased to help.)

- Warning**
Environmental hazard Hazardous substances cause environmental damage.
- Oil, grease, filters, fuel, cleaners, brake fluid, etc., should be disposed of as stipulated in applicable regulations.

i Info
 Never use DOT 5 brake fluid! It is silicone-based and purple in color. Oil seals and brake lines are not designed for DOT 5 brake fluid.
 Avoid contact between brake fluid and painted parts. Brake fluid is corrosive and will damage painted surfaces.
 Use only clean brake fluid from a sealed container!

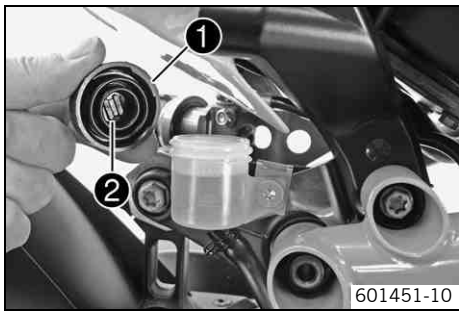

- Stand the vehicle upright.
- Remove screw cap ❶ with membrane ❷.
- Add brake fluid to the **MAX** level.

Brake fluid DOT 4 / DOT 5.1 (☞ p. 118)
--

- Refit screw with membrane.

i Info
 Clean up overflowed or spilt brake fluid immediately with water.

Checking the rear brake linings

- Warning**
Danger of accidents Reduced braking efficiency caused by worn brake linings.
- Change worn brake linings immediately. (Your authorized KTM RC8 workshop will be pleased to help.)

Note
Danger of accidents Reduced braking efficiency caused by damaged brake discs.

- If the brake linings are not changed in time, the steel brake lining carriers grind on the brake disc. The braking effect is greatly reduced and the brake discs are rendered unserviceable. Check the brake linings regularly.

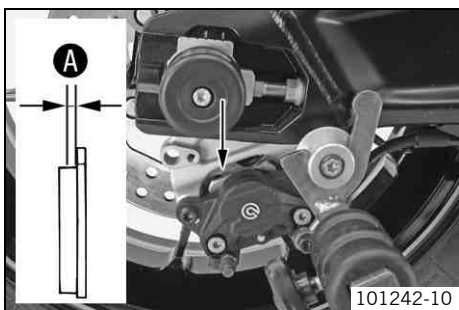

- Check the brake linings for minimum thickness **A**.

Minimum thickness A	≥ 1 mm (≥ 0.04 in)
----------------------------	--------------------

- » If the minimum thickness is less than specified:
 - Change the rear brake linings. 🛠️
- Check the brake linings for damage and cracking.
 - » If damage or wear is encountered:
 - Change the rear brake linings. 🛠️

Removing the front frame sliders

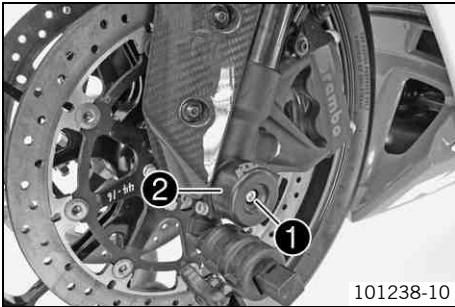

- Remove screw ❶.
- Take off frame slider ❷.
- Pull the second frame slider with the linkage arm out of the wheel spindle.

Installing the front frame sliders

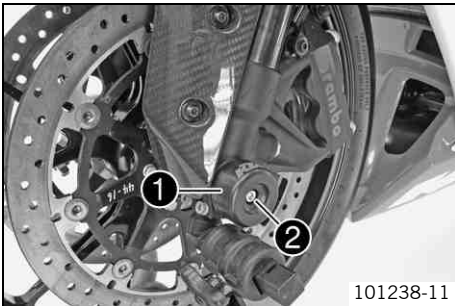

- Position the frame slider with the linkage arm in the wheel spindle.
- Mount frame slider ❶ on the linkage arm.
- Mount and tighten screw ❷.

Guideline

Remaining chassis screws	M6	10 Nm (7.4 lbf ft)
--------------------------	----	--------------------

Removing the front wheel ↩

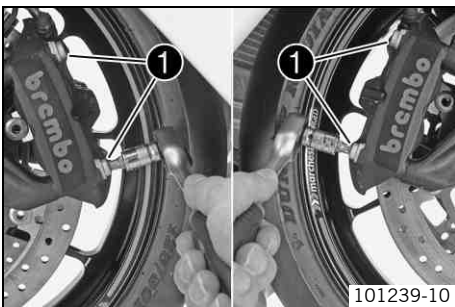

- Raise the rear of the motorcycle with lifting gear. (↪ p. 54)
- Raise the front of the motorcycle with lifting gear. (↪ p. 54)
- Remove the front frame sliders. (↪ p. 70)
- Remove screws ❶ from both brake calipers.
- Press back the brake linings with a light lateral tilting of the brake calipers on the brake disc. Pull the brake calipers carefully back from the brake discs and hang them to one side.



Info

Do not pull the hand brake lever when the brake calipers are removed.

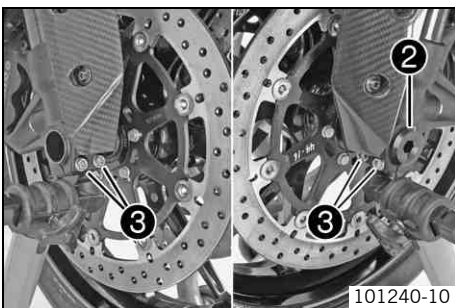

- Loosen screws ❷ and ❸.
- Unscrew screw ❷ about six turns and press your hand on the screw to push the wheel spindle out of the axle clamp. Remove screw ❷.



Warning

Danger of accidents Reduced braking efficiency caused by damaged brake discs.

- Always lay the wheel down in such a way that the brake discs are not damaged.

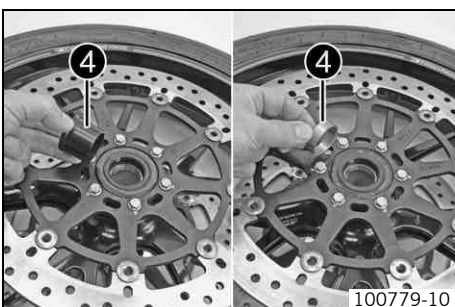

- Holding the front wheel, withdraw the wheel spindle. Take the front wheel out of the fork.
- Remove spacers ❹.

Installing the front wheel

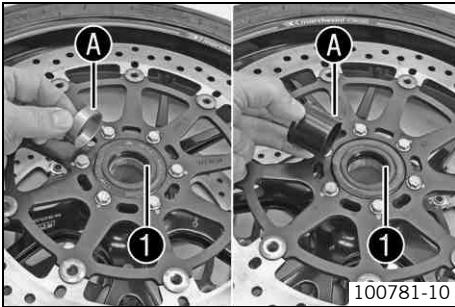

100781-10

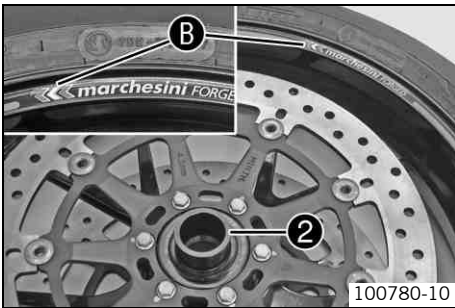

100780-10

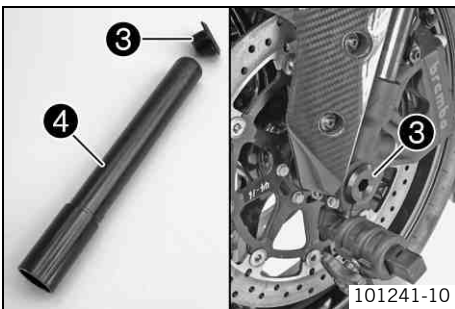

101241-10

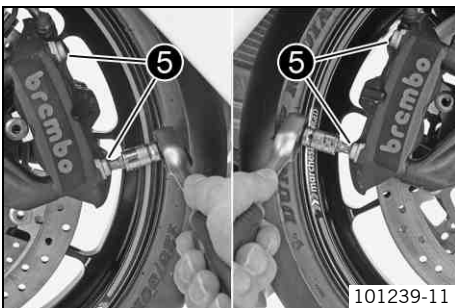

101239-11

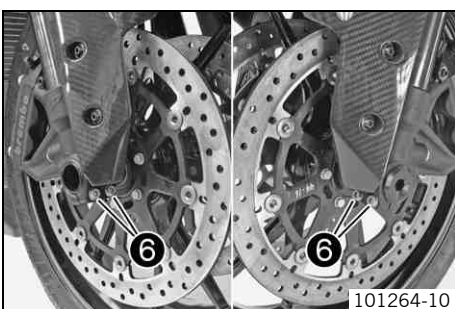

101264-10

- Check the wheel bearing for damage and wear.
 - » If the wheel bearing is damaged or worn:
 - Replace the wheel bearing.
- Clean and grease the shaft seal rings ① and mating surfaces ② of the spacers.

Long-life grease (☛ p. 120)

- Insert the wide spacer on the left-hand side ② (when looking in the direction of travel).

Info

The arrow ② indicates the direction of rotation of the front wheel.

- Insert the narrow spacer on the right-hand side (when viewed in the direction of travel).

Warning

Danger of accidents Reduced braking efficiency due to oil or grease on the brake discs.

- Always keep the brake discs free of oil and grease, and clean them with brake cleaner when necessary.

- Clean screw ③ and axle ④.
- Lift the front wheel into the fork, position it, and insert the wheel spindle.
- Mount and tighten screw ③.

Guideline

Bolt, front axle	M25x1.5	45 Nm (33.2 lbf ft)
------------------	---------	------------------------

- Position the brake calipers and check that the brake linings are seated correctly.
- Mount screws ⑤ on both brake calipers but do not tighten yet.
- Operate the hand brake lever repeatedly until the brake linings are in contact with the brake disc and there is a pressure point. Fix the hand brake lever in its engaged position.

✓ The brake calipers straighten.

- Tighten screws ⑤ on both brake calipers.

Guideline

Screw, front brake caliper	M10x1.25	45 Nm (33.2 lbf ft)	Loctite® 243™
----------------------------	----------	------------------------	----------------------

- Remove the fixation of the hand brake lever.
- Take the motorcycle off of the front wheel stand. (☛ p. 54)
- Remove the rear of the motorcycle from the lifting gear. (☛ p. 54)
- Pull the front brake and compress the fork powerfully a few times.

✓ The fork legs straighten.

- Tighten screws ⑥.

Guideline

Fork end pinch bolts	M8	15 Nm (11.1 lbf ft)
----------------------	----	------------------------

- Install the front frame sliders. (☛ p. 70)

Removing the rear frame sliders

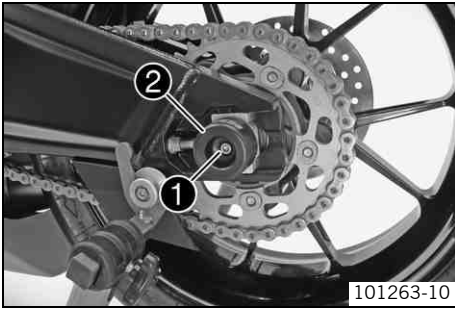

- Remove screw ❶.
- Take off frame slider ❷.
- Pull the second frame slider with the linkage arm out of the wheel spindle.

Installing the rear frame sliders

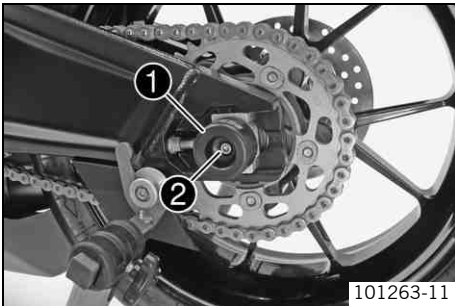

- Position the frame slider with the linkage arm in the wheel spindle.
- Mount frame slider ❶ on the linkage arm.
- Mount and tighten screw ❷.

Guideline

Remaining chassis screws	M6	10 Nm (7.4 lbf ft)
--------------------------	----	--------------------

Removing the rear wheel ↩

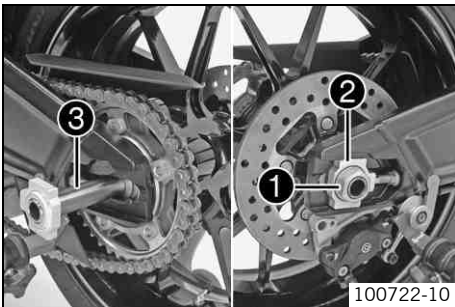

- Raise the rear of the motorcycle with lifting gear. (↩ p. 54)
- Remove the rear frame sliders. (↩ p. 72)
- Remove nut ❶.
- Remove chain adjuster ❷.
- Remove axle ❸.

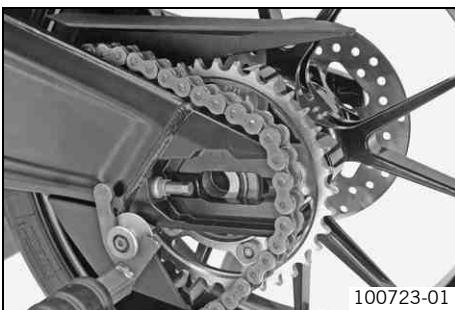

- Push the rear wheel as far forward as possible and then remove the chain from the rear sprocket.



Warning

Danger of accidents Reduced braking efficiency caused by damaged brake discs.

- Always lay the wheel down in such a way that the brake discs are not damaged.

- Take the rear wheel out of the swingarm carefully without damaging the rim or brake disc.



Info

Do not operate the foot brake when the rear wheel is removed.

Installing the rear wheel 🛠️



Warning

Danger of accidents Reduced braking efficiency due to oil or grease on the brake discs.

- Always keep the brake discs free of oil and grease, and clean them with brake cleaner when necessary.



Warning

Danger of accidents No braking effect when operating the rear brake.

- After installing the rear wheel, always operate the foot brake until the pressure point is reached.

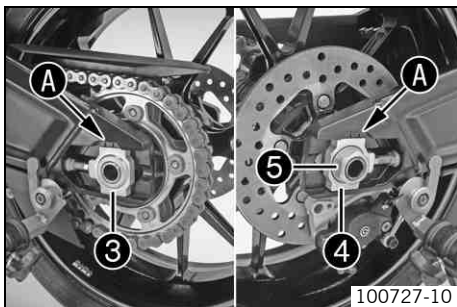
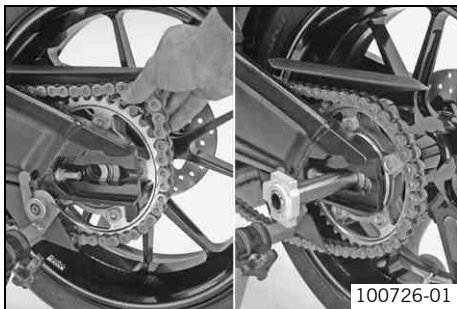
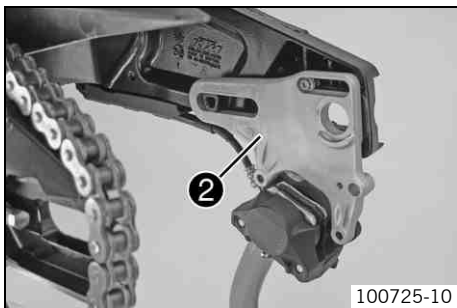
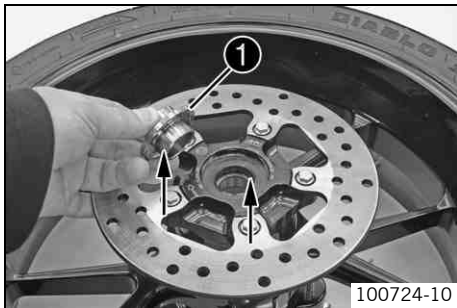

- Check the rear hub cush drive. 🛠️ (📖 p. 74)
- Remove bushing ❶. Clean and grease the mating surfaces of the bushing and shaft seal ring.

Long-life grease (📖 p. 120)

- Check the wheel bearing for damage and wear.
 - » If the wheel bearing is damaged or worn:
 - Replace the wheel bearing. 🛠️
- Install the bushing.
- Clean the thread of the axle and nut.
- Clean the mating surfaces of the brake caliper frame and swingarm.
- Push the brake caliper frame ❷ completely to the rear.
- Position the rear wheel, and position the brake caliper support between the rim and the brake disc.
- Position the brake caliper on the brake disc.
- Position the rear wheel on the bearing surfaces in the swingarm.

- Push the rear wheel as far forward as possible and place the chain on the rear sprocket.
- Pull the rear wheel back and insert the axle.

- Place chain adjuster ❸ on the tensioning screw.
- Position chain adjuster ❹ and place it on the tensioning screw.
- Tighten nut ❺.

Guideline

In order for the rear wheel to be correctly aligned, the markings on the left and right chain adjusters must be in the same position relative to reference marks A.



Nut, rear wheel spindle	M25x1.5	90 Nm (66.4 lbf ft)	Thread greased
-------------------------	---------	------------------------	----------------

- Operate the foot brake lever repeatedly until the brake linings are in contact with the brake disc and there is a pressure point.
- Remove the rear of the motorcycle from the lifting gear. (📖 p. 54)
- Check the chain tension. (📖 p. 62)
- Install the rear frame sliders. (📖 p. 72)



Checking rear hub cush drive

i Info
The engine power is transmitted by the rear sprocket to the rear wheel through five shock absorbers. They eventually wear out during operation. If the shock absorbers are not changed in time, the rear sprocket carrier and the rear hub are damaged.



- Remove the rear wheel.  ( p. 72)
- Remove the rear sprocket carrier.
- Check the rear hub for damage and wear.
 - » If the rear hub cush drive is damaged or worn:
 - Change the shock absorber. 
- Position the rear sprocket carrier.

i Info
A set of bolts and shock absorbers should have as little free travel as possible to increase the service life of the shock absorbers.

- Install the rear wheel.  ( p. 73)

Checking the tire condition

! Warning
Danger of accidents Uncontrollable vehicle handling in the event of a flat tire.

- In the interest of safety, replace damaged or worn tires immediately. (Your authorized KTM RC8 workshop will be pleased to help.)

! Warning
Danger of crashing Poor vehicle handling due to different tire tread patterns on front and rear wheels.

- The front and rear wheels must be fitted with tires with similar tread patterns to prevent loss of control over the vehicle.

! Warning
Danger of accidents Uncontrollable handling characteristic due to non-approved and/or non-recommended tires/wheels.

- Only tires/wheels approved by KTM and with the corresponding speed index should be used.

i Info
The type, condition, and air pressure of the tires all have a major impact on the handling of the motorcycle.

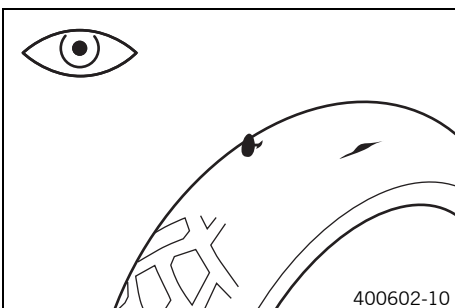

- Check the front and rear tires for cuts, run-in objects, and other damage.
 - » If the tires exhibit cuts, run-in objects, or other damage:
 - Change the tires.
- Check the tread.
 - » If the tread is worn:
 - Change the tires.
- Check the age of the tires.

i Info
The tire's date of manufacture is usually part of the tire markings and is indicated by the last four digits of the **DOT** marking. The first two digits refer to the week of manufacture and last two digits refer to the year of manufacture.

KTM recommends that the tires are changed regardless of the actual wear, at the latest after five years.

- » If a tire is more than five years old:
 - Change the tires.

Checking the tire pressure



Info

Low tire pressure leads to abnormal wear and overheating of the tire.
Correct tire pressure ensures riding comfort and maximum tire life.

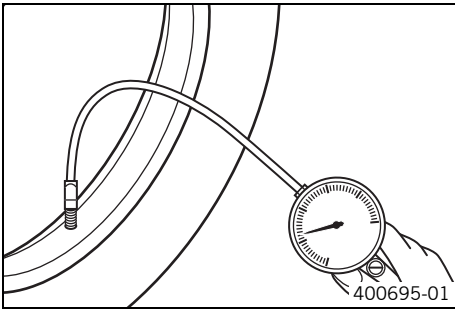

- Remove the dust cap.
- Check the tire pressure when the tires are cold.

Tire air pressure	
Front	2.0 bar (29 psi)
Rear	1.5 bar (22 psi)

- » If the tire pressure does not meet specifications:
 - Correct the tire pressure.
- Mount the dust cap.



Info

The rubber seal in the dust cap prevents air from leaking out of the tire if the valve is faulty.

Removing the battery ↩



Warning

Risk of injury Battery acid and battery gases cause serious chemical burns.

- Keep batteries out of the reach of children.
- Wear suitable protective clothing and goggles.
- Avoid contact with battery acid and battery gases.
- Keep the battery away from sparks or open flames. Charge only in well-ventilated areas.
- In the event of skin contact, rinse with large amounts of water. If battery acid gets in the eyes, rinse with water for at least 15 minutes and contact a physician.



Caution

Danger of accidents If the vehicle is operated with a discharged battery or without a battery, electronic components and safety equipment may be damaged.

- Never operate the vehicle with a discharged battery or without a battery.

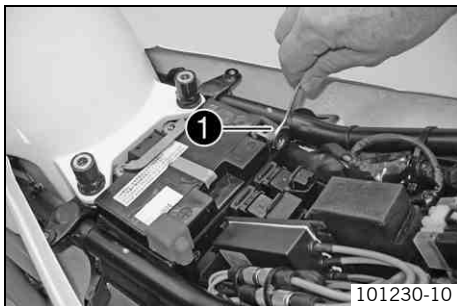

- Switch off all power consumers and the engine.
- Remove the seat. (↩ p. 55)
- Disconnect negative (minus) cable ❶ of the battery.

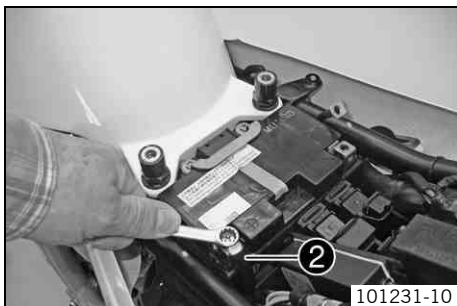

- Remove the cover of the positive terminal.
- Disconnect the positive (plus) cable ❷ of the battery.

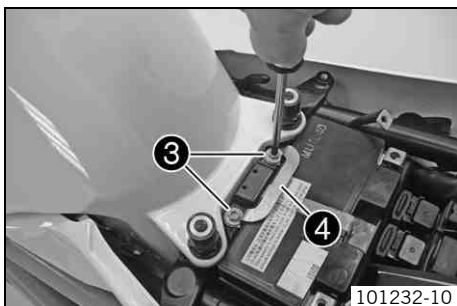

- Remove screws ❸.
- Removing the securing bracket ❹.
- Pull the battery up and out of the battery rack.

Installing the battery ↩

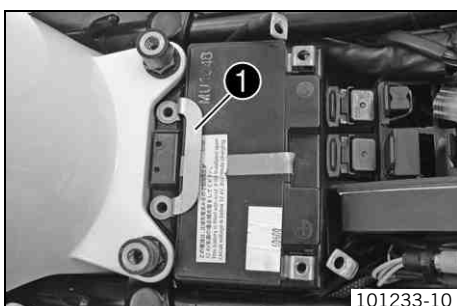

- Position the battery in the battery rack.



Info

The terminals of the battery must face the rear of the vehicle.

- Position the bracket ❶.

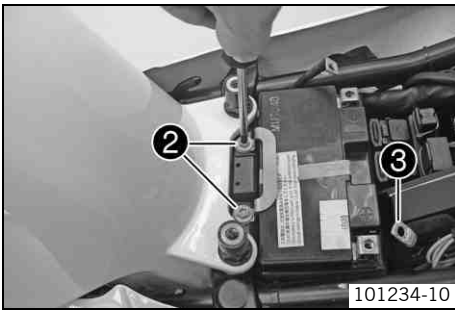

- Mount and tighten screws ②.

Guideline

Remaining chassis screws	M6	10 Nm (7.4 lbf ft)
--------------------------	----	--------------------

- Reconnect the positive (plus) ③ cable of the battery.
- Position cover of the positive terminal.

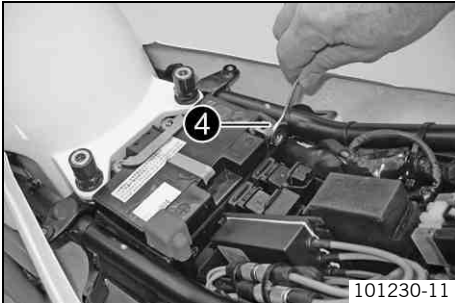

- Reconnect the negative (minus) cable ④ of the battery.
- Fit the seat. (☛ p. 55)
- Set the clock with **SET CLOCK**. (☛ p. 31)

Recharging the battery ↩



Warning

Risk of injury Battery acid and battery gases cause serious chemical burns.

- Keep batteries out of the reach of children.
- Wear suitable protective clothing and goggles.
- Avoid contact with battery acid and battery gases.
- Keep the battery away from sparks or open flames. Charge only in well-ventilated areas.
- In the event of skin contact, rinse with large amounts of water. If battery acid gets in the eyes, rinse with water for at least 15 minutes and contact a physician.



Warning

Environmental hazard The battery contains elements that are harmful to the environment.

- Do not discard batteries with the household trash. Dispose of a defective battery in an environmentally compatible manner. Give the battery to your KTM dealer or to a recycling center that accepts used batteries.



Warning

Environmental hazard Hazardous substances cause environmental damage.

- Oil, grease, filters, fuel, cleaners, brake fluid, etc., should be disposed of as stipulated in applicable regulations.



Info

Even when there is no load on the battery, it discharges steadily.

The charge state and the type of charge are very important for the service life of the battery.

Rapid recharging with a high charging current shortens the battery's service life.

If the charging current, charging voltage and charging time are exceeded, electrolyte escapes through the safety valves. This reduces the battery capacity.

If the battery is depleted from starting the vehicle repeatedly, the battery must be charged immediately.

If the battery is left in a discharged state for an extended period, it will become over-discharged and sulfate, destroying the battery.

The battery is maintenance-free, i.e., the acid level does not have to be checked.

- Switch off all power consumers and switch off the engine.
- Remove the seat. (☛ p. 55)
- Disconnect the negative (minus) cable of the battery to avoid damage to the motorcycle's electronics.

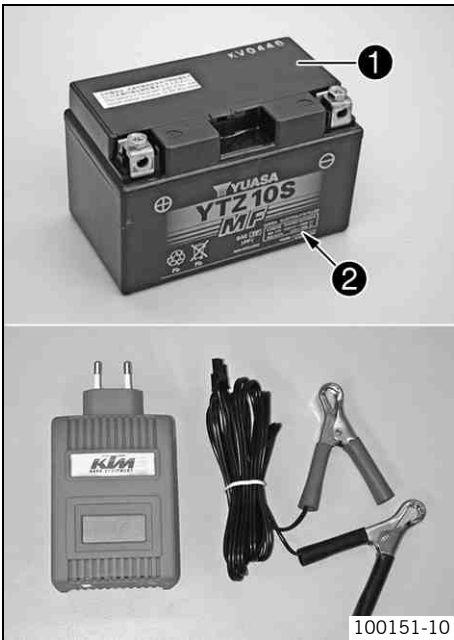

- Connect the battery charger to the battery. Switch on the battery charger.

Battery charger (58429074000)

You can also use the battery charger to test the rest potential and start potential of the battery, and to test the alternator. With this device, you cannot overcharge the battery.

i Info

Never remove lid ❶.
Charge the battery at no more than 10% of the capacity specified on the battery housing ❷.

- Switch off the charger after charging. Reconnect the battery.

Guideline

The charge current, charge voltage and charge time must not be exceeded.

Charge the battery regularly when the motorcycle is not in use	3 months
--	----------

- Fit the seat. (☛ p. 55)
- Set the clock with **SET CLOCK**. (☛ p. 31)

Changing the main fuse

! Warning

Fire hazard The electrical system can be overloaded if the wrong fuses are used.

- Use only fuses with the prescribed amperage. Never by-pass or repair fuses.

i Info

The main fuse protects all power consumers of the vehicle. The main fuse is under the seat.

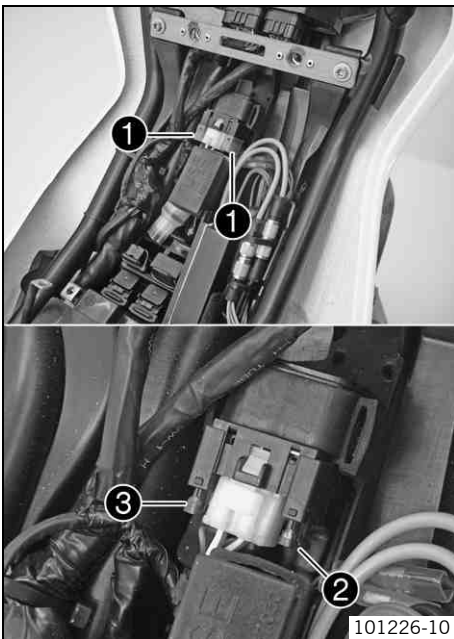

- Switch off all power consumers and the engine.
- Remove the seat. (☛ p. 55)
- Remove protection covers ❶.
- Remove the faulty main fuse ❷.

i Info

A reserve fuse ❸ is located in the starter relay.

- Install a new main fuse.

Fuse (58011109130) (☛ p. 99)

i Tip

Place the spare fuse in the starter relay so that it is available if needed.

- Attach the protection covers ❶.
- Fit the seat. (☛ p. 55)
- Set the clock with **SET CLOCK**. (☛ p. 31)

Changing the fuses of individual power consumers



Warning

Fire hazard The electrical system can be overloaded if the wrong fuses are used.

- Use only fuses with the prescribed amperage. Never by-pass or repair fuses.



Info

The fuse box containing the fuses of individual power consumers is located under the seat.

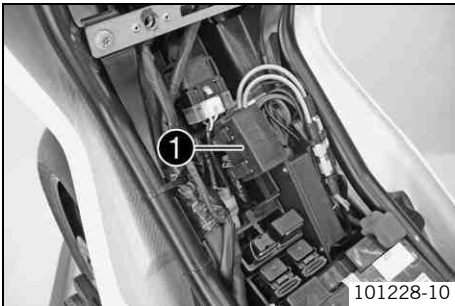

- Switch off all power consumers and switch off the engine.
- Remove the seat. (☛ p. 55)
- Open the fuse box cover ❶.

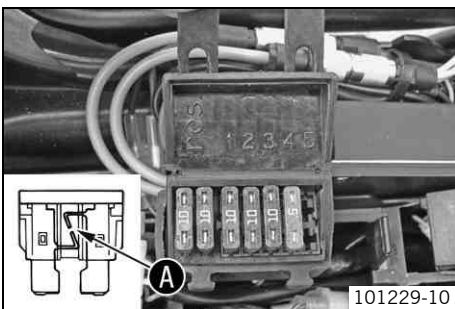

- Check the fuses.



Info

A defective fuse is shown by a burned-out fuse wire ❷.

- Remove the defective fuse.

Guideline

Fuse 1 - 10 A - emergency OFF switch, combination instrument (permanent positive)
Fuse 2 - 10 A - ignition, fuel injection, combination instrument (accessories connected to the emergency OFF switch)
Fuse 3 - 10 A - fuel pump
Fuse 4 - 5 A - quick shifter
Fuse res. - 10 A - spare fuses

- Use spare fuses with the correct rating only.

Fuse (58011109110) (☛ p. 99)

Fuse (58011109105) (☛ p. 99)



Tip

Replace the spare fuse in the fuse box so that it is available if needed.

- Close the fuse box cover.
- Fit the seat. (☛ p. 55)

Cooling system

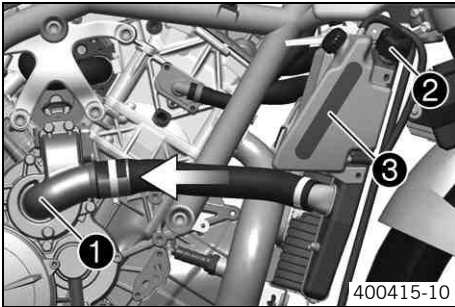

The water pump with a 3D water pump wheel ❶ in the engine ensures forced circulation of the coolant. The heat exchanger enables faster warming of the engine oil at the start of a journey and better heat dissipation for the engine oil during the journey. The pressure in the cooling system resulting from heat is regulated by a valve in the radiator cap ❷. The heat expansion causes the surplus coolant to flow into the compensating tank ❸. When the temperature falls, this surplus coolant is sucked back into the cooling system.

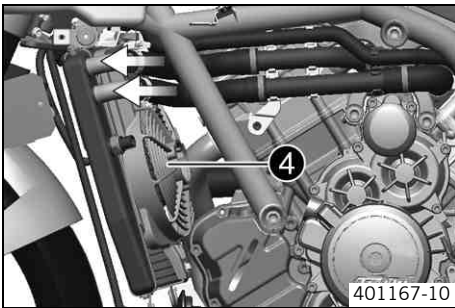

Cooling takes place by means of the air stream and a radiator fan ❹, which is controlled by a thermostitch. The lower the speed, the less the cooling effect. Dirty cooling fins also reduce the cooling effect.

Checking the coolant level



Warning

Danger of scalding During motorcycle operation, the coolant gets very hot and is under pressure.

- Do not remove the radiator cap, radiator hoses or other cooling system components when the engine is hot. Allow the engine and cooling system to cool down. In case of scalding, rinse immediately with lukewarm water.

Condition

The engine is cold.
The radiator is completely full.

- Rest the motorcycle on its side stand on a horizontal surface.
- Check the coolant level in the compensating tank.

The coolant level must be between **MIN** and **MAX**.

- » If there is no coolant in the compensating tank:
 - Check the cooling system for leaks. 🛠️



Info

Do not operate the motorcycle!

- Add coolant/bleed the cooling system. 🛠️ (📖 p. 81)
- » If the coolant level in the compensating tank does not meet specifications, but the tank is not empty:
 - Check the cooling system for leaks. 🛠️
 - Fill the cooling system compensating tank. (📖 p. 80)



Filling cooling system compensating tank



Warning

Danger of scalding During motorcycle operation, the coolant gets very hot and is under pressure.

- Do not remove the radiator cap, radiator hoses or other cooling system components when the engine is hot. Allow the engine and cooling system to cool down. In case of scalding, rinse immediately with lukewarm water.



Warning

Danger of poisoning Coolant is poisonous and a health hazard.

- Avoid contact between coolant and skin, eyes and clothing. If it gets into your eyes, rinse immediately with water and contact a doctor. Wash affected skin areas immediately with soap and water. If coolant is swallowed, contact a doctor immediately. Change clothes that have come into contact with coolants. Keep coolant out of the reach of children.

Note

Engine damage Impaired cooling efficiency due to air trapped in the cooling system.

- After draining coolant and refilling the cooling system, the motorcycle must be raised at the front according to the model type. This is the only way of ensuring that the cooling system is filled without air bubbles. (Your authorized KTM RC8 workshop will be pleased to help.)

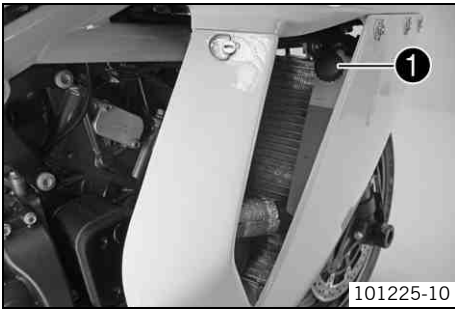

101225-10

- Check the coolant level. (☞ p. 80)
- Remove the cap ❶ of the compensating tank.
- Add coolant to the specified level.

Guideline

The coolant level must be between MIN and MAX .

Alternative 1

Coolant (☞ p. 118)

Alternative 2

Coolant (mixed ready to use) (☞ p. 118)

- Mount the cap of the compensating tank.

Adding coolant/bleeding the cooling system ↩



Warning

Danger of poisoning Coolant is poisonous and a health hazard.

- Avoid contact between coolant and skin, eyes and clothing. If it gets into your eyes, rinse immediately with water and contact a doctor. Wash affected skin areas immediately with soap and water. If coolant is swallowed, contact a doctor immediately. Change clothes that have come into contact with coolants. Keep coolant out of the reach of children.

Condition

The side cover has been removed.

- Position the vehicle as shown and secure it against rolling. Height difference **A** must be reached.

Guideline

Height difference A	50 cm (19.7 in)
----------------------------	-----------------

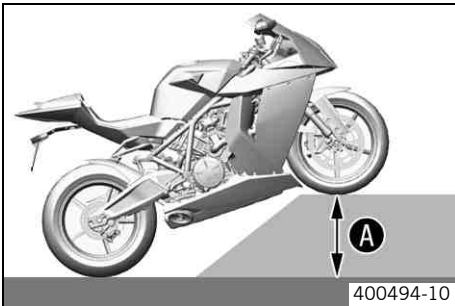

400494-10

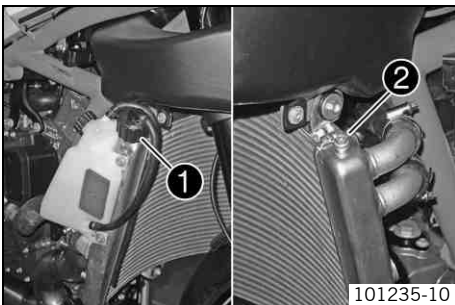

101235-10

- Remove radiator cap ❶ and bleeder screw ❷ of the radiator.

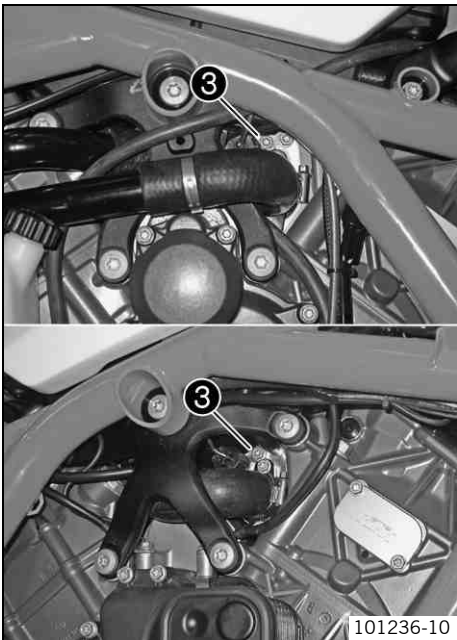

- Remove bleeder screws ③ of the cylinder heads.
- Add coolant until it exits from the vent hole without bubbles.

Coolant	2.60 l (2.75 qt.)	Coolant (☛ p. 118)
		Coolant (mixed ready to use) (☛ p. 118)

- Mount and tighten the bleeder screws with the seal rings.

Guideline

Remaining engine screws	M6	10 Nm (7.4 lbf ft)
Remaining chassis screws	M6	10 Nm (7.4 lbf ft)

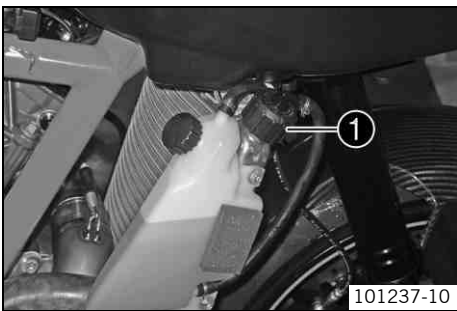

- Completely fill the radiator with coolant and close it with radiator cap ①.
- Position the vehicle on a level surface.
- Remove the cap of the compensating tank.
- Add coolant to the compensating tank until the coolant reaches the specified level.

Guideline

The coolant level must be between MIN and MAX .

- Mount the cap of the compensating tank.

Checking the play in the throttle cable

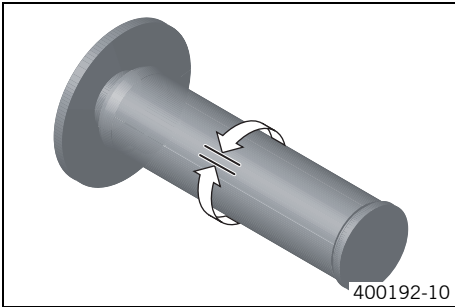

- Check the throttle grip for smooth operation.
- Move the handlebar to the straight-ahead position. Move the throttle grip backwards and forwards to ascertain the play in the throttle cable.

Throttle cable play	3... 5 mm (0.12... 0.2 in)
---------------------	----------------------------

- » If the throttle cable play does not meet specifications:
 - Adjust the play in the throttle cable. 🛠️ (📄 p. 83)



Danger

Danger of poisoning Exhaust gases are poisonous and inhaling them may result in unconsciousness and/or death.

- When running the engine, always make sure there is sufficient ventilation, and do not start or run the engine in an enclosed space without an effective exhaust extraction system.

- Start the engine and let it run idle. Move the handlebar to and fro over the entire steering range.

The idle speed must not change.

- » If the idle speed changes:
 - Adjust the play in the throttle cable. 🛠️ (📄 p. 83)

Adjusting the play in the throttle cable 🛠️

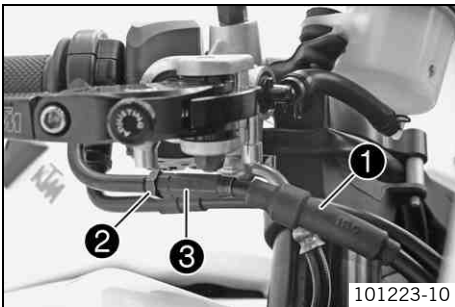

- Move the handlebar to the straight-ahead position.
- Throttle position sensor circuit A - check in zero position. 🛠️



Info

It is imperative to use the KTM diagnostics tool for this.

- Push back protective cover ❶.
- Loosen lock nut ❷.
- Set the play in the throttle cable by turning adjusting screw ❸.

Guideline

Throttle cable play	3... 5 mm (0.12... 0.2 in)
---------------------	----------------------------

- Tighten lock nut ❷.
- Mount protection cap ❶.

Quick shifter



The quick shifter ❶ is mounted on the left of the engine.

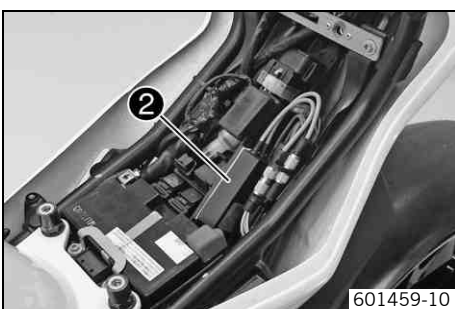

The quick shifter control unit ❷ is mounted below the seat.

Possible states

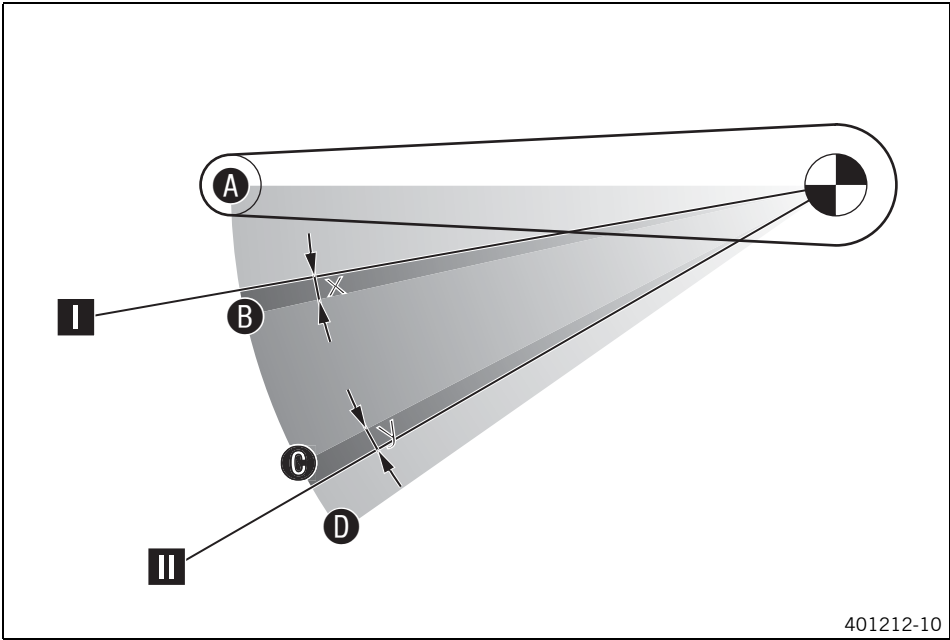

A	Shift lever in neutral position
I	Ignition circuit is interrupted – Green LED goes out, red LED lights up
x	Ignition interruption until shift begin – Range should be as small as possible but must not overlap
B	Shift process in transmission begins – Resistance in shift lever increases
C	Shift process in transmission ended – Resistance in shift lever decreases
y	Shift end until ignition circuit closed – Range should be as small as possible but must not overlap
II	Ignition circuit is closed – Red LED goes out, green LED lights up
D	Shift lever at end stop

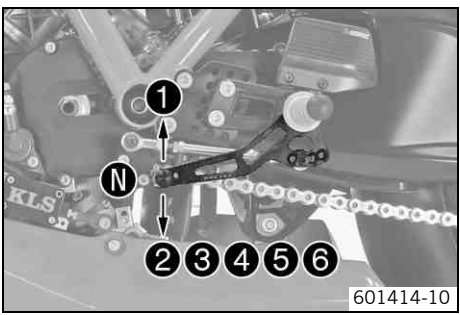

With the quick shifter, it is not necessary to activate the clutch when upshifting gears from the 1st to the 6th gear. The ignition is briefly interrupted by the control unit during a shift procedure. To simplify adjustment of the quick shifter, it is equipped with two LEDs. The green LED lights up when the ignition is not interrupted. The red LED lights up when the ignition is interrupted. The time span of the ignition interruption must be matched to the vehicle.

i Info
It is always possible to shift by conventional means using the clutch and throttle.

Checking/tuning the position of the quick shifter

i Info
The quick shifter only operates when upshifting gears from 1st to 6th gear. If the ignition circuit is interrupted too late, upshifting under full throttle is difficult or not possible at all. If it is interrupted too early, the ignition circuit may be interrupted unintentionally (e. g. due to shift lever vibrations). If the ignition circuit is closed too early, the shift procedure in the transmission cannot be completed correctly.

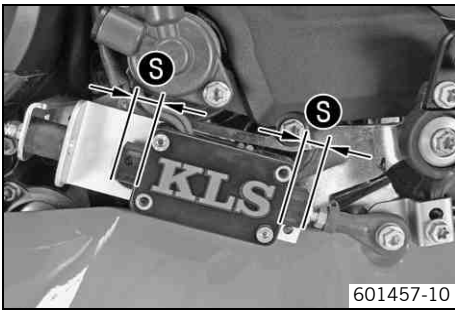



- Check the installation position of the quick shifter.

Guideline

Distance S	7... 8 mm (0.28... 0.31 in)
-------------------	-----------------------------

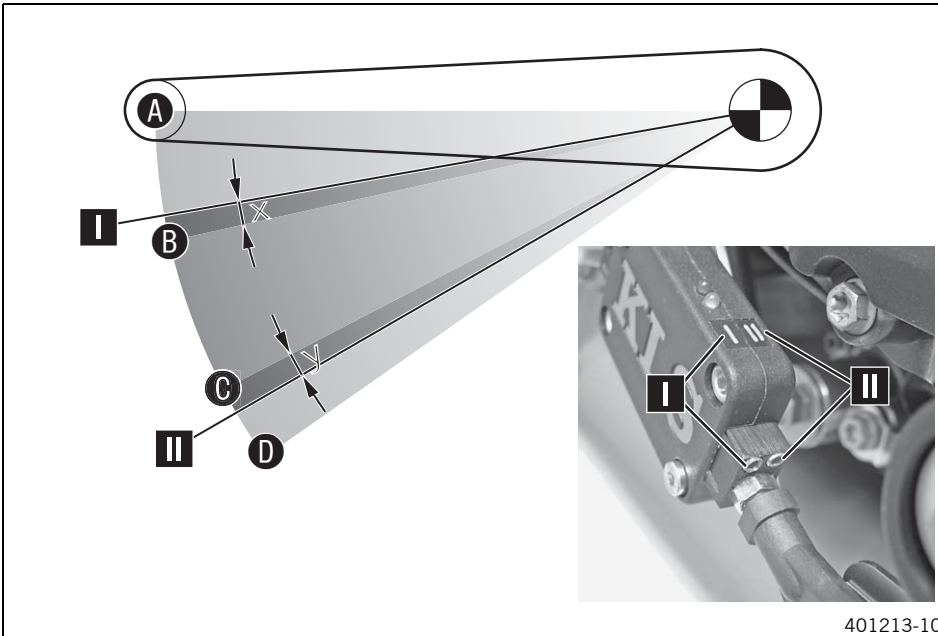
- » If the specifications have not been met:
 - Position the quick shifter. (🔧 p. 86)



- Switch on the ignition by pressing the emergency OFF switch into the position .
- Switch on the quick shifter. To do so, flip the quick shifter switch up to the **EIN** position.
- Engage 3rd or 4th gear.
 - ✓ The green LED lights up on the quick shifter.
- Check the quick shifter against the overview. Turn the rear wheel slightly while doing so.

A - Shift lever in neutral position	
I - Ignition circuit is interrupted	Green LED goes out; red LED lights up (must lie between A and B)
x - Ignition interruption until shift begin	Range should be as small as possible but must not overlap
B - Shift process in transmission begins	Resistance in shift lever increases
C - Shift process in transmission ended	Resistance in shift lever decreases
y - Shift end until ignition circuit closed	Range should be as small as possible but must not overlap
II - Ignition circuit is closed	Red LED goes out; green LED lights up (must lie between C and D)
D - Shift lever at end stop	

- » The LED display is not as specified:
 - Adjust the settings.



Info

Turning screw **I** clockwise causes the ignition circuit to be interrupted earlier.
 Turning screw **II** clockwise causes the ignition circuit to close earlier.

Positioning the quick shifter

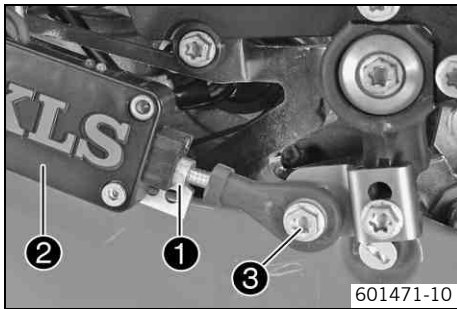

- Release nuts ① while holding quick shifter ② with your hand.
- Remove screw ③.

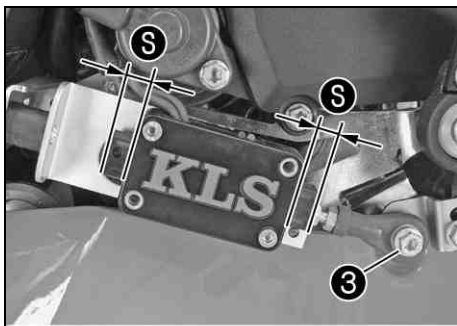

- Turn heim joint ④ until distance ⑤ is reached.

Guideline

Distance ⑤	7... 8 mm (0.28... 0.31 in)
------------	-----------------------------

- Check distance ①.

Guideline

Distance ①	≤ 15 mm (≤ 0.59 in)
------------	---------------------

- Mount and tighten screw ③.

Guideline

Remaining frame bolts	M5	5 Nm (3.7 lbf ft)
-----------------------	----	-------------------

- Check distance ⑤ again.

Guideline

Distance ⑤	7... 8 mm (0.28... 0.31 in)
------------	-----------------------------

- » If the specifications have not been met:
 - Repeat the steps.

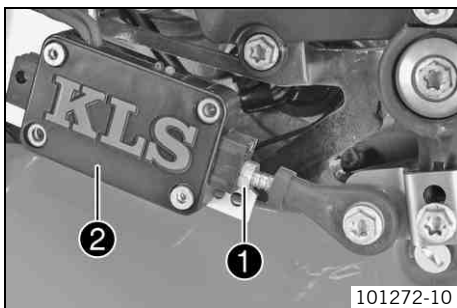
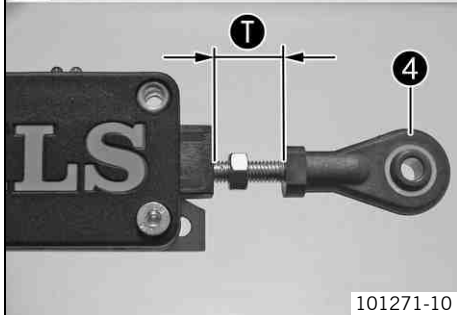

- Tighten nut ① while holding quick shifter ② with your hand.
- Check and tune the setting of the quick shifter. 🛠️ (📖 p. 84)

Checking the engine oil level



Info

The engine oil level must be checked at normal engine operating temperature.

- Stand the motorcycle upright on a horizontal surface.
- Remove the left side cover. (☞ p. 57)
- Remove screw ❶.

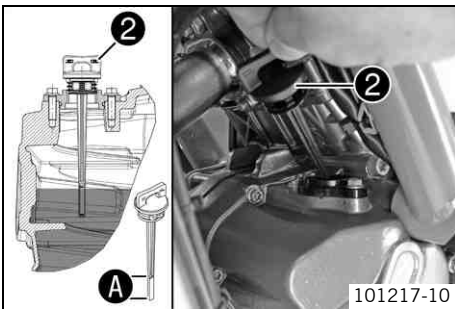
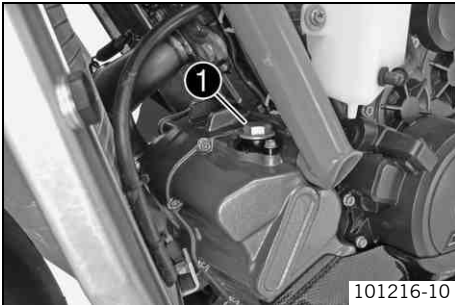

- Insert the provided oil dipstick ❷ all the way - do not screw in.

Oil dipstick (60030020100)



Info

After switching off the engine, wait one minute before checking the level. Do not screw in the oil dipstick; only insert it to the stop.

The engine oil level must be within range A on the oil dipstick.

- » If the engine oil level is not at the specified level:
 - Add engine oil. (☞ p. 90)
- Mount screw ❶.
- Install the left side cover. (☞ p. 57)

Changing engine oil and filter, cleaning oil screen



- Drain the engine oil and clean the oil screens. (☞ p. 87)
- Fill up with engine oil. (☞ p. 89)

Draining engine oil, cleaning oil screens



Warning

Danger of scalding Engine oil and gear oil get very hot when the motorcycle is ridden.

- Wear appropriate protective clothing and safety gloves. In case of burns, rinse immediately with lukewarm water.



Warning

Environmental hazard Hazardous substances cause environmental damage.

- Oil, grease, filters, fuel, cleaners, brake fluid, etc., should be disposed of as stipulated in applicable regulations.



Info

Drain the engine oil only when the engine is warm.

- Remove the left side cover. (☞ p. 57)
- Remove the right side cover. (☞ p. 57)

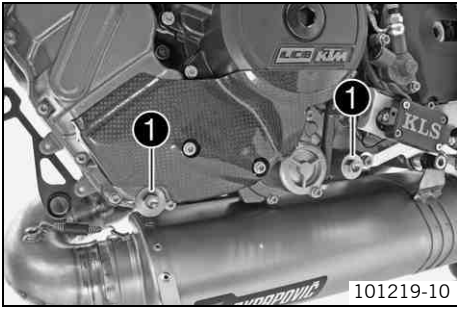

- Remove the exhaust cover. (☞ p. 58)
- Park the motorcycle on a level surface.
- Place a suitable container under the engine.
- Remove oil drain plug ❶ with the magnet, O-rings, and oil screen.
- Remove the oil filter. ☞ (☞ p. 88)
- Completely drain the engine oil.

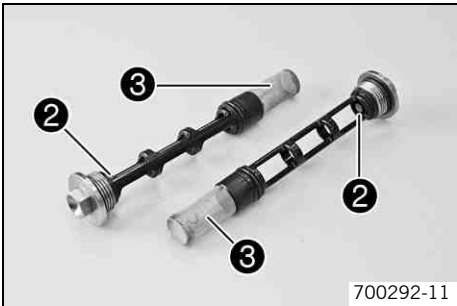

- Thoroughly clean magnet ❷ and oil screen ❸ of the oil drain plug.

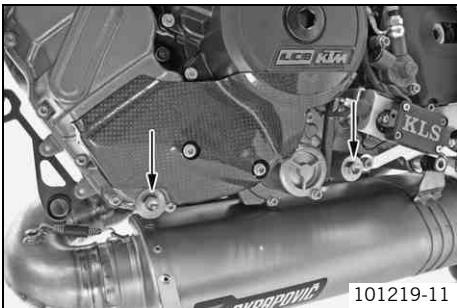

- Mount and tighten the oil drain plugs with the magnet, O-rings, and oil screen.

Guideline

Oil drain plug	M20x1.5	20 Nm (14.8 lbf ft)
----------------	---------	------------------------

- Install the oil filter. ☞ (☞ p. 89)
- Install the exhaust cover. (☞ p. 58)
- Install the right side cover. (☞ p. 57)
- Install the left side cover. (☞ p. 57)

Removing the oil filter ☞



Warning

Danger of scalding Engine oil and gear oil get very hot when the motorcycle is ridden.

- Wear appropriate protective clothing and safety gloves. In case of burns, rinse immediately with lukewarm water.



Warning

Environmental hazard Hazardous substances cause environmental damage.

- Oil, grease, filters, fuel, cleaners, brake fluid, etc., should be disposed of as stipulated in applicable regulations.

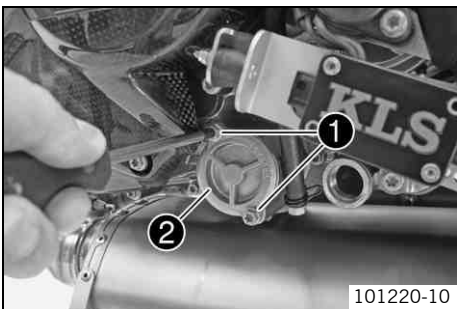

- Place a suitable container under the engine.
- Remove screws ❶. Take off oil filter cover ❷ with the O-ring.

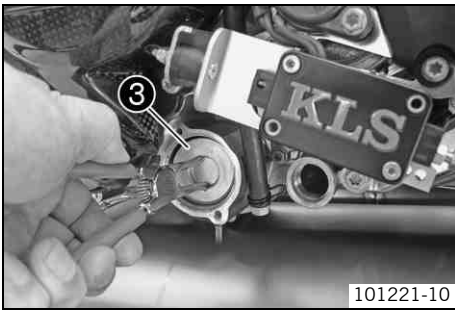

- Pull oil filter ③ out of the oil filter housing.
- | |
|--------------------------------------|
| Circlip pliers reverse (51012011000) |
|--------------------------------------|
- Completely drain the engine oil.
 - Clean the parts and the sealing area thoroughly.

Installing the oil filter ↩

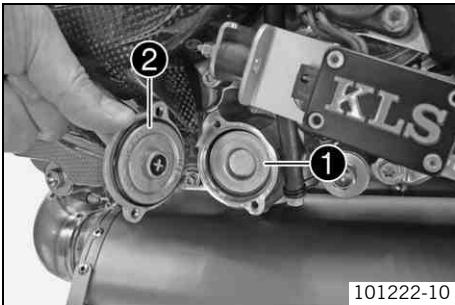

- Insert oil filter ①.
- Lubricate the O-ring of the oil filter cover. Mount oil filter cover ②.
- Mount and tighten the screws.

Guideline

Remaining engine screws	M5	6 Nm (4.4 lbf ft)
-------------------------	----	-------------------

Filling up with engine oil ↩

Info

Too little engine oil or poor-quality engine oil results in premature wear to the engine.

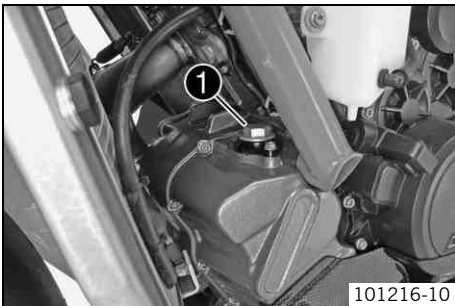

- The oil must be added in two steps.

Engine oil	3.60 l (3.8 qt.)	External temperature: $\geq 0\text{ }^{\circ}\text{C}$ ($\geq 32\text{ }^{\circ}\text{F}$)	Engine oil (SAE 10W/50) (☛ p. 118)
		External temperature: $< 0\text{ }^{\circ}\text{C}$ ($< 32\text{ }^{\circ}\text{F}$)	Engine oil (SAE 5W/40) (☛ p. 118)

- Remove screw ① and add engine oil.

Engine oil (1st quantity)	3.00 l (3.17 qt.)	External temperature: $\geq 0\text{ }^{\circ}\text{C}$ ($\geq 32\text{ }^{\circ}\text{F}$)	Engine oil (SAE 10W/50) (☛ p. 118)
		External temperature: $< 0\text{ }^{\circ}\text{C}$ ($< 32\text{ }^{\circ}\text{F}$)	Engine oil (SAE 5W/40) (☛ p. 118)

- Mount screw ①.



Danger

Danger of poisoning Exhaust gases are poisonous and inhaling them may result in unconsciousness and/or death.

- When running the engine, always make sure there is sufficient ventilation, and do not start or run the engine in an enclosed space without an effective exhaust extraction system.

- Start the engine and check that it is oil-tight.
- Remove screw ① and pour in the remaining engine oil.

Engine oil (2nd quantity)	0.60 l (0.63 qt.)	External temperature: $\geq 0\text{ }^{\circ}\text{C}$ ($\geq 32\text{ }^{\circ}\text{F}$)	Engine oil (SAE 10W/50) (☛ p. 118)
		External temperature: $< 0\text{ }^{\circ}\text{C}$ ($< 32\text{ }^{\circ}\text{F}$)	Engine oil (SAE 5W/40) (☛ p. 118)

- Mount screw ❶.



Danger

Danger of poisoning Exhaust gases are poisonous and inhaling them may result in unconsciousness and/or death.

- When running the engine, always make sure there is sufficient ventilation, and do not start or run the engine in an enclosed space without an effective exhaust extraction system.

- Start the engine and check that it is oil-tight.
- Check the engine oil level. (☛ p. 87)

Adding engine oil



Info

Too little engine oil or poor-quality engine oil results in premature wear to the engine.

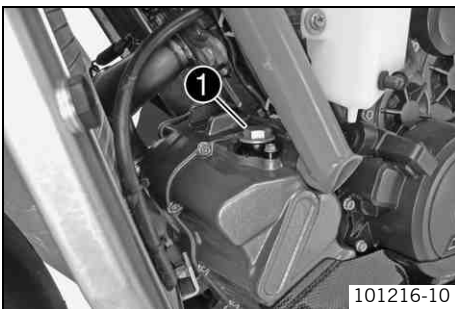

- Check the engine oil level. (☛ p. 87)
- Remove screw ❶ and add engine oil.

Condition

External temperature: $\geq 0\text{ }^{\circ}\text{C}$ ($\geq 32\text{ }^{\circ}\text{F}$)

Engine oil (SAE 10W/50) (☛ p. 118)

Condition

External temperature: $< 0\text{ }^{\circ}\text{C}$ ($< 32\text{ }^{\circ}\text{F}$)

Engine oil (SAE 5W/40) (☛ p. 118)



Info

For optimal performance of the engine oil, do not mix different types of engine oil.
If appropriate, change the engine oil.

- Mount screw ❶.



Danger

Danger of poisoning Exhaust gases are poisonous and inhaling them may result in unconsciousness and/or death.

- When running the engine, always make sure there is sufficient ventilation, and do not start or run the engine in an enclosed space without an effective exhaust extraction system.

- Start the engine and check that it is oil-tight.
- Check the engine oil level. (☛ p. 87)

Cleaning the motorcycle

Note

Material damage Damage and destruction of components by high-pressure cleaning equipment.

- Never clean the vehicle with high-pressure cleaning equipment or a strong water-jet. The excessive pressure can penetrate electrical components, socket connects, throttle cables, and bearings, etc., and can damage or destroy these parts.



Warning

Environmental hazard Hazardous substances cause environmental damage.

- Oil, grease, filters, fuel, cleaners, brake fluid, etc., should be disposed of as stipulated in applicable regulations.



Info

To maintain the value and appearance of the motorcycle over a long period, clean it regularly. Avoid direct sunshine when cleaning the motorcycle.

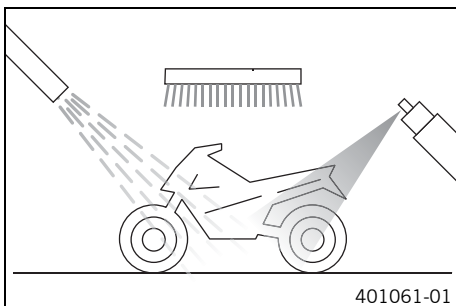

- Close off the exhaust system to keep water from entering.
- Remove loose dirt first with a soft jet of water.
- Spray very dirty parts with a normal commercial engine cleaner and then brush off with a soft brush.

Motorcycle cleaner (☛ p. 120)



Info

Clean the vehicle with warm water containing normal motorcycle cleaner and a soft sponge.

- After rinsing the motorcycle with a gentle spray of water, allow it to dry thoroughly.



Warning

Danger of accidents Reduced braking efficiency due to wet or dirty brakes.

- Clean or dry dirty or wet brakes by riding and braking gently.

- After cleaning, ride the vehicle a short distance until the engine warms up, and then apply the brakes.
 - ✓ The heat causes water to evaporate from inaccessible parts of the engine and brakes.
- After the motorcycle has cooled off, lubricate all moving parts and bearings.
- Clean the chain. (☛ p. 61)
- Treat all painted parts with a mild lacquer care spray.

Paint cleaner and polish for high-gloss and matte finishes, bare metal and plastic surfaces (☛ p. 120)

Storage



Info

If you want to garage the motorcycle for a longer period, take the following actions.

Before storing the motorcycle, check all parts for function and wear. If service, repairs or replacements are necessary, you should do this during the storage period (less workshop overload). In this way, you can avoid long workshop waiting times at the start of the new season.

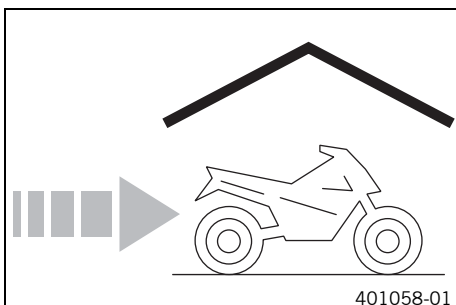

- Make sure the tank is as empty as possible so that you can fill up with fresh fuel when you put the motorcycle back into operation.
- Clean the motorcycle. (☛ p. 91)
- Change the engine oil and filter, clean the oil screen. 🛢 (☛ p. 87)
- Check the coolant level. (☛ p. 80)
- Check the antifreeze. 🛢
- Check the tire pressure. (☛ p. 75)
- Remove the battery. 🛢 (☛ p. 76)

- Recharge the battery. 🛡️ (🔧 p. 77)

Guideline

Storage temperature of battery without direct sunshine.	0... 35 °C (32... 95 °F)
---	--------------------------

- Store the vehicle in a dry location that is not subject to large fluctuations in temperature.



Info

KTM recommends raising the motorcycle.

- Raise the rear of the motorcycle with lifting gear. (🔧 p. 54)
- Raise the front of the motorcycle with lifting gear. (🔧 p. 54)
- Cover the motorcycle with a porous sheet or blanket.



Info







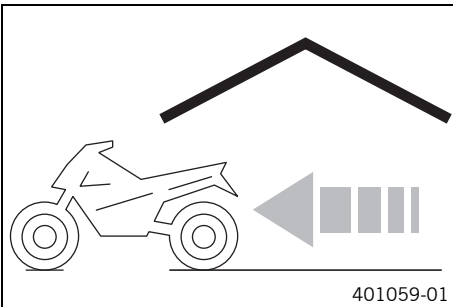



Do not use non-porous materials since they prevent humidity from escaping, thus causing corrosion.

Avoid running the engine for a short time only. Since the engine cannot warm up properly, the water vapor produced during combustion condenses and causes valves and exhaust system to rust.

Preparing for use after storage



- Take the motorcycle off of the front wheel stand. (🔧 p. 54)
- Recharge the battery. 🛡️ (🔧 p. 77)
- Install the battery. 🛡️ (🔧 p. 76)
- Set the clock with **SET CLOCK**. (🔧 p. 31)
- Fill up with fuel. (🔧 p. 40)
- Perform checks and maintenance measures when preparing for use. (🔧 p. 39)
- Take a test ride.

Blink code EFI warning lamp (MIL)	 09 EFI warning lamp (MIL) flashes 9x short
Error level condition	Manifold absolute pressure sensor cylinder 1 - input signal too low Manifold absolute pressure sensor cylinder 1 - input signal too high
Blink code EFI warning lamp (MIL)	 13 EFI warning lamp (MIL) flashes 1x long, 3x short
Error level condition	Intake air temperature sensor - input signal too low Intake air temperature sensor - input signal too high
Blink code EFI warning lamp (MIL)	 12 EFI warning lamp (MIL) flashes 1x long, 2x short
Error level condition	Engine coolant temperature sensor - input signal too low Engine coolant temperature sensor - input signal too high
Blink code EFI warning lamp (MIL)	 06 EFI warning lamp (MIL) flashes 6x short
Error level condition	Throttle position sensor circuit A - input signal too low Throttle position sensor circuit A - input signal too high
Blink code EFI warning lamp (MIL)	 33 EFI warning lamp (MIL) flashes 3x long, 3x short
Error level condition	Injector cylinder 1 - circuit fault
Blink code EFI warning lamp (MIL)	 34 EFI warning lamp (MIL) flashes 3x long, 4x short
Error level condition	Injector cylinder 2 - circuit fault
Blink code EFI warning lamp (MIL)	 07 EFI warning lamp (MIL) flashes 7x short
Error level condition	Throttle position sensor circuit B - input signal too low Throttle position sensor circuit B - input signal too high
Blink code EFI warning lamp (MIL)	 02 EFI warning lamp (MIL) flashes 2x short
Error level condition	Crankshaft position sensor - circuit fault
Blink code EFI warning lamp (MIL)	 37 EFI warning lamp (MIL) flashes 3x long, 7x short
Error level condition	Ignition coil 1, cylinder 1 - circuit fault
Blink code EFI warning lamp (MIL)	 38 EFI warning lamp (MIL) flashes 3x long, 8x short
Error level condition	Ignition coil 1, cylinder 2 - circuit fault
Blink code EFI warning lamp (MIL)	 49 EFI warning lamp (MIL) flashes 4x long, 9x short
Error level condition	Motor drive circuit A - circuit fault

Blink code EFI warning lamp (MIL)	 24 EFI warning lamp (MIL) flashes 2x long, 4x short
Error level condition	Power supply - circuit fault
Blink code EFI warning lamp (MIL)	 50 EFI warning lamp (MIL) flashes 5x long
Error level condition	Motor drive circuit B - circuit fault
Blink code EFI warning lamp (MIL)	 68 EFI warning lamp (MIL) flashes 6x long, 8x short
Error level condition	Manifold absolute pressure sensor cylinder 1 - connection leaks
Blink code EFI warning lamp (MIL)	 69 EFI warning lamp (MIL) flashes 6x long, 9x short
Error level condition	Manifold absolute pressure sensor cylinder 2 - connection leaks
Blink code EFI warning lamp (MIL)	 14 EFI warning lamp (MIL) flashes 1x long, 4x short
Error level condition	Ambient air pressure sensor - input signal too low Ambient air pressure sensor - input signal too high
Blink code EFI warning lamp (MIL)	 41 EFI warning lamp (MIL) flashes 4x long, 1x short
Error level condition	Fuel pump control - short circuit to ground or open circuit Fuel pump control - input signal too high
Blink code EFI warning lamp (MIL)	 25 EFI warning lamp (MIL) flashes 2x long, 5x short
Error level condition	Side stand switch - circuit fault
Blink code EFI warning lamp (MIL)	 15 EFI warning lamp (MIL) flashes 1x long, 5x short
Error level condition	Rollover sensor - input signal too low Rollover sensor - input signal too high
Blink code EFI warning lamp (MIL)	 81 EFI warning lamp (MIL) flashes 8x long, 1x short
Error level condition	Immobilizer control unit - circuit fault
Blink code EFI warning lamp (MIL)	 11 EFI warning lamp (MIL) flashes 1x long, 1x short
Error level condition	Manifold absolute pressure sensor cylinder 2 - input signal too low Manifold absolute pressure sensor cylinder 2 - input signal too high
Blink code EFI warning lamp (MIL)	 91 EFI warning lamp (MIL) flashes 9x long, 1x short
Error level condition	CAN bus communication error

Design	2-cylinder 4-stroke Otto motor, 75° V arrangement, water-cooled		
Displacement	1,195 cm ³ (72.92 cu in)		
Stroke	69 mm (2.72 in)		
Bore	105 mm (4.13 in)		
Compression ratio	13.5:1		
Control	DOHC, 4 valves per cylinder, chain-driven		
Valve - valve stem diameter			
Intake	42 mm (1.65 in)		
Exhaust	34 mm (1.34 in)		
Valve clearance			
Exhaust at: 20 °C (68 °F)	0.25... 0.30 mm (0.0098... 0.0118 in)		
Intake at: 20 °C (68 °F)	0.10... 0.15 mm (0.0039... 0.0059 in)		
Crankshaft bearing	Sleeve bearing		
Conrod bearing	Sleeve bearing		
Piston pin bearing	No bearing bushes - DLC-coated piston pins		
Piston	Forged light alloy		
Piston ring	1 Upper compression (rectangular) ring, 1 lower compression ring, 1 oil scraper ring		
Engine lubrication	Dry sump lubrication system with three rotor pumps		
Primary transmission	40:76		
Clutch	Multi-disc clutch in oilbath / hydraulically operated		
Transmission	6-speed claw gears		
Transmission ratio			
1st gear	14:36		
2nd gear	16:30		
3rd gear	20:30		
4th gear	21:27		
5th gear	23:26		
6th gear	25:26		
Mixture preparation	Electronically controlled fuel injection		
Ignition system	Contactless controlled fully electronic ignition with digital ignition adjustment		
Alternator	12 V, 390 W		
Spark plug	NGK LKAR9BI9		
Electrode gap, spark plug	0.8... 0.9 mm (0.031... 0.035 in)		
Cooling	Water cooling, permanent circulation of coolant by water pump		
Cold start device	Electric starter		

Capacity - engine oil

Engine oil	3.60 l (3.8 qt.)	External temperature: ≥ 0 °C (≥ 32 °F)	Engine oil (SAE 10W/50) (☛ p. 118)
		External temperature: < 0 °C (< 32 °F)	Engine oil (SAE 5W/40) (☛ p. 118)

Capacity - coolant

Coolant	2.60 l (2.75 qt.)	Coolant (☛ p. 118)
		Coolant (mixed ready to use) (☛ p. 118)

Hose clip, intake flange	M4	1.5 Nm (1.11 lbf ft)	–
Remaining engine screws	M5	6 Nm (4.4 lbf ft)	–
Screw, bearing retainer	M5	6 Nm (4.4 lbf ft)	Loctite® 243™
Screw, gear sensor	M5	3 Nm (2.2 lbf ft)	Loctite® 243™
Screw, pulse generator	M5	6 Nm (4.4 lbf ft)	Loctite® 243™
Camshaft drive sprocket bolt	M6	13 Nm (9.6 lbf ft)	–
Freewheel ring bolt	M6 – 10.9	15 Nm (11.1 lbf ft)	Loctite® 648™
Nut, cylinder head	M6	9 Nm (6.6 lbf ft)	–
Plug, vacuum connection	M6	5 Nm (3.7 lbf ft)	Loctite® 243™
Remaining engine screws	M6	10 Nm (7.4 lbf ft)	–
Screw, camshaft bearing support	M6 – 10.9	10 Nm (7.4 lbf ft)	–
Screw, clutch cover	M6	10 Nm (7.4 lbf ft)	–
Screw, clutch spring	M6	12 Nm (8.9 lbf ft)	Loctite® 243™
Screw, coolant connection on cylinder head	M6	10 Nm (7.4 lbf ft)	–
Screw, engine case	M6x60	10 Nm (7.4 lbf ft)	–
Screw, engine case	M6x80	10 Nm (7.4 lbf ft)	–
Screw, engine case	M6x90	10 Nm (7.4 lbf ft)	–
Screw, freewheel holder	M6	10 Nm (7.4 lbf ft)	Loctite® 243™
Screw, locking lever	M6	10 Nm (7.4 lbf ft)	Loctite® 243™
Screw, oil pump cover	M6	10 Nm (7.4 lbf ft)	Loctite® 243™
Screw, shift drum locating	M6	10 Nm (7.4 lbf ft)	Loctite® 243™
Screw, shift lever	M6	10 Nm (7.4 lbf ft)	Loctite® 243™
Screw, starter motor	M6	10 Nm (7.4 lbf ft)	–
Screw, stator	M6	10 Nm (7.4 lbf ft)	Loctite® 243™
Screw, valve cover	M6	10 Nm (7.4 lbf ft)	–
Screw, water pump cover	M6	10 Nm (7.4 lbf ft)	–
Screw, water pump wheel	M6	10 Nm (7.4 lbf ft)	Loctite® 243™
Stud, chain shaft	M6	8 Nm (5.9 lbf ft)	–
Vacuum connection	M6	2.5 Nm (1.84 lbf ft)	Loctite® 243™
Oil jet	M6x0.75	4 Nm (3 lbf ft)	Loctite® 243™
Plug, crankshaft retainer	M8	15 Nm (11.1 lbf ft)	–
Screw, camshaft bearing support	M8 – 10.9	Step 1 10 Nm (7.4 lbf ft) Step 2 18 Nm (13.3 lbf ft)	–
Screw, camshaft bearing support	M8 – 10.9	Step 1 8.5 Nm (6.27 lbf ft) Step 2 14.5 Nm (10.7 lbf ft)	Only applies when using: Hex key bit (61229025000)
Screw, engine case	M8	18 Nm (13.3 lbf ft)	–
Screw, engine console	M8	20 Nm (14.8 lbf ft)	Loctite® 243™
Screw, heat exchanger	M8	15 Nm (11.1 lbf ft)	–
Screw, timing chain guide rail	M8	15 Nm (11.1 lbf ft)	Loctite® 243™
Screw, timing chain tensioning rail	M8	15 Nm (11.1 lbf ft)	Loctite® 243™
Stud, exhaust flange	M8	10 Nm (7.4 lbf ft)	–
Oil pressure sensor	M10x1	10 Nm (7.4 lbf ft)	–
Plug, cam lever axis	M10x1	15 Nm (11.1 lbf ft)	–
Plug, clutch lubrication	M10x1	12 Nm (8.9 lbf ft)	–

Screw, conrod bearing	M10x1	Step 1 25 Nm (18.4 lbf ft) Step 2 30 Nm (22.1 lbf ft) Step 3 90°	–
Screw, timing chain tensioner release	M10x1	10 Nm (7.4 lbf ft)	–
Cylinder head screw	M11x1.5	Tightening sequence: Using a crisscross pattern Step 1 15 Nm (11.1 lbf ft) Step 2 30 Nm (22.1 lbf ft) Step 3 90° Step 4 90°	Lubricated with engine oil
Coolant temperature sensor	M12x1.5	12 Nm (8.9 lbf ft)	–
Rotor screw	M12x1.5	90 Nm (66.4 lbf ft)	–
Spark plug	M12x1.5	17 Nm (12.5 lbf ft)	–
Oil drain plug	M20x1.5	20 Nm (14.8 lbf ft)	–
Nut, inner clutch hub	M22x1.5	130 Nm (95.9 lbf ft)	Loctite® 243™
Plug, timing-chain tensioner	M24x1.5	25 Nm (18.4 lbf ft)	–
Screw in alternator cover	M24x1.5	8 Nm (5.9 lbf ft)	–
Nut, primary gear	M33LHx1.5	130 Nm (95.9 lbf ft)	Loctite® 243™

Frame	Lattice frame made of chromium molybdenum steel tubing, powder-coated
Fork	WP Suspension Up Side Down 4354
Shock absorber	WP Suspension 4618 DACC
Suspension travel	
Front	120 mm (4.72 in)
Rear	120 mm (4.72 in)
Brake system	
Front	Twin floating disc with radial mount, 4-piston calipers
Rear	Single non-floating disc with 2 piston brake caliper
Brake discs - diameter	
Front	320 mm (12.6 in)
Rear	220 mm (8.66 in)
Brake discs - wear limit	
Front	4.5 mm (0.177 in)
Brake disc - wear limit	
Rear	4.5 mm (0.177 in)
Tire air pressure	
Front	2.0 bar (29 psi)
Rear	1.5 bar (22 psi)
Secondary drive	17:38
Chain	5/8 x 1/4" (520) X-ring
Steering head angle	66.7°
Wheelbase	1,425 mm (56.1 in)
Seat height, unloaded	845 mm (33.27 in)
Ground clearance, unloaded	110 mm (4.33 in)
Weight without fuel approx.	173 kg (381 lb.)
Maximum permissible front axle load	150 kg (331 lb.)
Maximum permissible rear axle load	240 kg (529 lb.)
Maximum permissible total weight	300 kg (661 lb.)

Battery	YTZ14S	Battery voltage: 12 V Nominal capacity: 11.2 Ah maintenance-free
Fuse	58011109130	30 A
Fuse	58011109110	10 A
Fuse	58011109105	5 A

Tires

Front tire	Rear tire
120/70 R 17 TL Dunlop Sportmax GP Racer D211 Slick	200/55 R 17 TL Dunlop Sportmax GP Racer D211 Slick
Additional information is available in the Service section under: http://www.ktm.com	

Capacity - fuel

Total fuel tank capacity, approx.	16.5 l (4.36 US gal)	Super unleaded (ROZ 100) (☛ p. 119)
-----------------------------------	----------------------	-------------------------------------

Fork part number	05.18.7E.10	
Fork	WP Suspension Up Side Down 4354	
Compression damping		
Comfort	15 clicks	
Standard	10 clicks	
Sport	5 clicks	
Full payload	5 clicks	
Rebound damping		
Comfort	15 clicks	
Standard	10 clicks	
Sport	5 clicks	
Full payload	5 clicks	
Spring preload - Preload Adjuster		
Comfort	5 turns	
Standard	5 turns	
Sport	3 turns	
Full payload	3 turns	
Spring length with preload spacer(s)	405 mm (15.94 in)	
Spring rate		
Medium (standard)	10 N/mm (57 lb/in)	
Air chamber length	80 ⁺²⁰ ₋₁₀ mm (3.15 ^{+0.79} _{-0.39} in)	
Fork length	735 mm (28.94 in)	
Fork oil per fork leg	520 ml (17.58 fl. oz.)	Fork oil (SAE 5) (☛ p. 119)

Shock absorber part number	15.18.7E.4402
Shock absorber	WP Suspension 4618 DACC
Compression damping, high-speed	
Standard	10 clicks
Compression damping, low-speed	
Standard	10 clicks
Rebound damping	
Standard	10 clicks
Spring preload	
Standard	7 mm (0.28 in)
Spring rate	
Medium (standard)	80 N/mm (457 lb/in)
Spring length	150 mm (5.91 in)
Gas pressure	10 bar (145 psi)
Static sag	11... 15 mm (0.43... 0.59 in)
Riding sag	27... 35 mm (1.06... 1.38 in)
Inbuilt length	291 mm (11.46 in)
Shock absorber oil (☛ p. 119)	SAE 2,5

Remaining frame bolts	M5	5 Nm (3.7 lbf ft)	–
Screw, brake fluid reservoir of rear brake	M5	5 Nm (3.7 lbf ft)	Loctite® 243™
Screw, brake line holder	M5	5 Nm (3.7 lbf ft)	–
Screw, chain guard	M5	5 Nm (3.7 lbf ft)	–
Screw, chain sliding guard	M5	5 Nm (3.7 lbf ft)	–
Screw, fuel tank cover	M5	3 Nm (2.2 lbf ft)	–
Screw, fuel tank guard	M5x17	3 Nm (2.2 lbf ft)	–
Screw, steering damper fixing bracket	M5	5 Nm (3.7 lbf ft)	Loctite® 243™
Bolt, foot brake lever stub	M6	10 Nm (7.4 lbf ft)	Loctite® 243™
Remaining chassis nuts	M6	15 Nm (11.1 lbf ft)	–
Remaining chassis screws	M6	10 Nm (7.4 lbf ft)	–
Screw for wheel speed sensor bracket	M6	3 Nm (2.2 lbf ft)	Loctite® 243™
Screw, foot brake cylinder	M6	10 Nm (7.4 lbf ft)	Loctite® 243™
Screw, foot brake lever	M6	15 Nm (11.1 lbf ft)	Loctite® 243™
Screw, fuel pump	M6	6 Nm (4.4 lbf ft)	–
Screw, shift lever stub	M6	10 Nm (7.4 lbf ft)	Loctite® 243™
Screw, shift rod	M6	12 Nm (8.9 lbf ft)	Loctite® 243™
Screw, shift shaft deflector on chain securing guide	M6	10 Nm (7.4 lbf ft)	Loctite® 243™
Screw, shift shaft deflector on shift shaft	M6	18 Nm (13.3 lbf ft)	Loctite® 243™
Fork end pinch bolts	M8	15 Nm (11.1 lbf ft)	–
Nut, forked bracket on foot brake lever	M8	30 Nm (22.1 lbf ft)	Loctite® 243™
Remaining chassis nuts	M8	30 Nm (22.1 lbf ft)	–
Remaining chassis screws	M8	25 Nm (18.4 lbf ft)	–
Screw for lifting gear support, rear	M8	18 Nm (13.3 lbf ft)	Loctite® 243™
Screw of rear brake caliper	M8	22 Nm (16.2 lbf ft)	Loctite® 243™
Screw, bottom triple clamp	M8	15 Nm (11.1 lbf ft)	–
Screw, clamp, eccentric shaft of deflector	M8	18 Nm (13.3 lbf ft)	–
Screw, front brake disc	M8	30 Nm (22.1 lbf ft)	Loctite® 243™
Screw, front footrest bracket	M8	25 Nm (18.4 lbf ft)	Loctite® 243™
Screw, handlebar stub	M8	20 Nm (14.8 lbf ft)	–
Screw, rear brake disc	M8	30 Nm (22.1 lbf ft)	Loctite® 243™
Screw, shift lever	M8	25 Nm (18.4 lbf ft)	Loctite® 243™
Screw, steering damper clamp on console	M8	20 Nm (14.8 lbf ft)	Loctite® 243™
Screw, steering damper fixing bracket on triple clamp	M8	10 Nm (7.4 lbf ft)	Loctite® 243™
Screw, steering stem	M8	20 Nm (14.8 lbf ft)	–
Screw, subframe	M8	20 Nm (14.8 lbf ft)	Loctite® 243™
Screw, top triple clamp	M8	17 Nm (12.5 lbf ft)	–
Remaining chassis nuts	M10	50 Nm (36.9 lbf ft)	–
Remaining chassis screws	M10	45 Nm (33.2 lbf ft)	–
Screw, connecting lever, shock absorber deflector	M10	45 Nm (33.2 lbf ft)	Loctite® 243™
Screw, engine bearer	M10	45 Nm (33.2 lbf ft)	–
Screw, shock absorber	M10	45 Nm (33.2 lbf ft)	Loctite® 243™
Rear sprocket bolt	M10x1.25	50 Nm (36.9 lbf ft)	Loctite® 243™
Screw, front brake caliper	M10x1.25	45 Nm (33.2 lbf ft)	Loctite® 243™
Nut of bell crank on frame	M14x1.5	100 Nm (73.8 lbf ft)	–
Nut, swingarm pivot	M19x1.5	130 Nm (95.9 lbf ft)	Thread greased

Bolt, front axle	M25x1.5	45 Nm (33.2 lbf ft)	–
Nut, rear wheel spindle	M25x1.5	90 Nm (66.4 lbf ft)	Thread greased
Screw, steering head	M25x1.5	18 Nm (13.3 lbf ft)	–

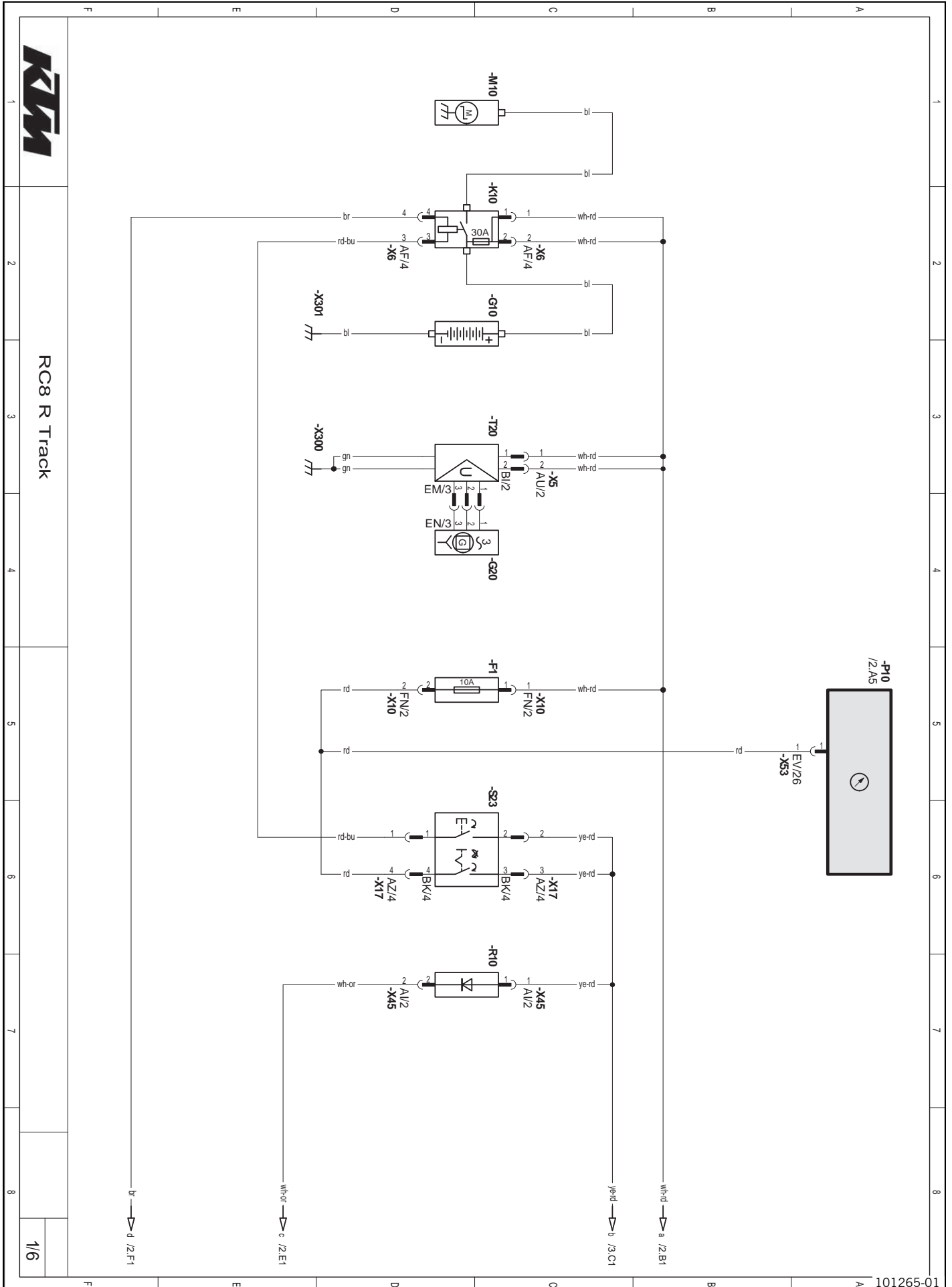

Components:

F1	Fuse
G10	Battery
G20	Alternator
K10	Starter relay with main fuse
M10	Starter motor
P10	Combination instrument
R10	Diode
S23	Emergency OFF switch, electric starter button
T20	Voltage regulator

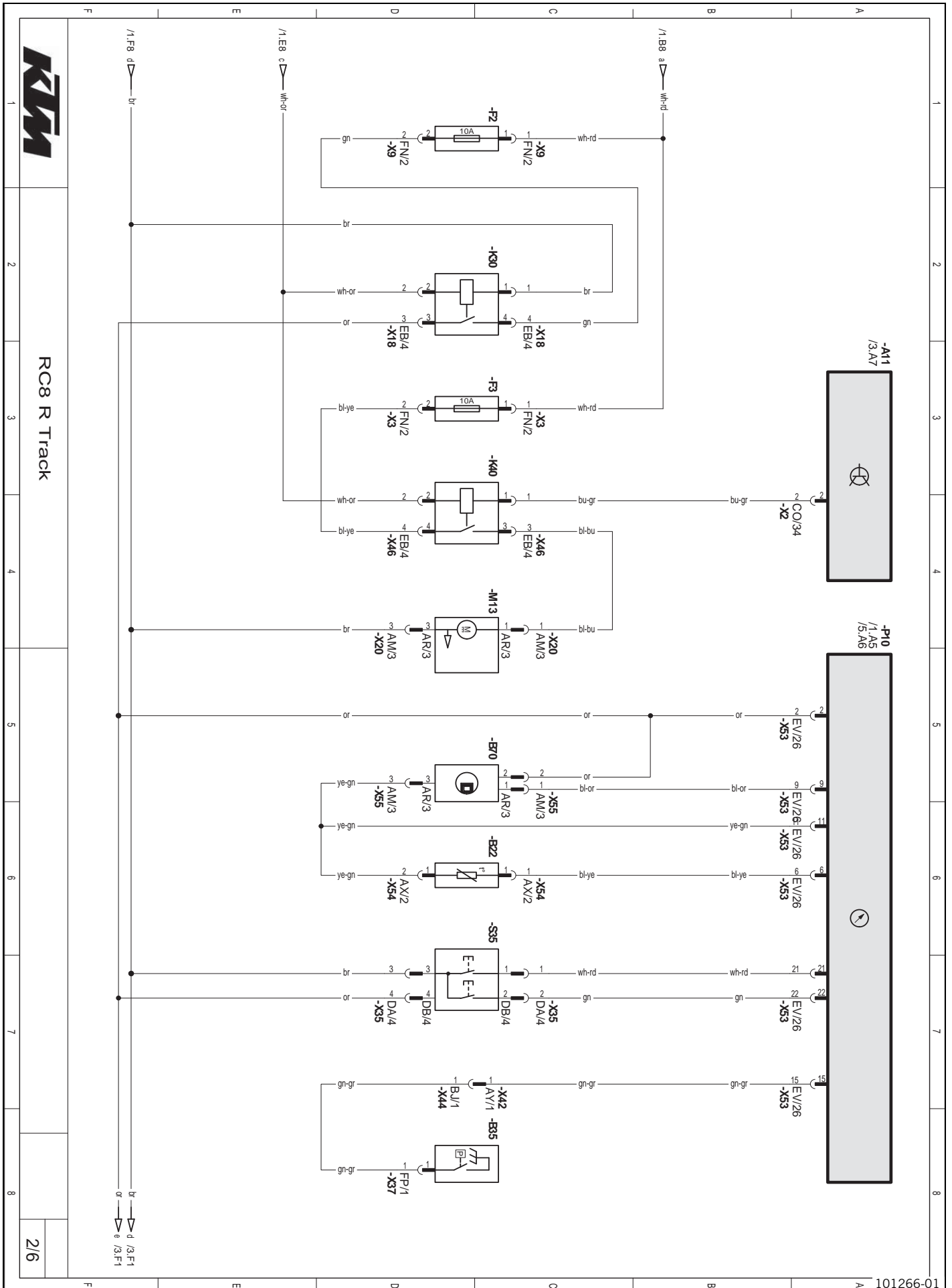

Components:

A11	EFI control unit
B22	Coolant temperature sensor (cylinder 2)
B35	Oil pressure sensor
B70	Wheel speed sensor, front
F2	Fuse
F3	Fuse
K30	Power relay
K40	Fuel pump relay
M13	Fuel pump
P10	Combination instrument
S35	MODE/LAP button

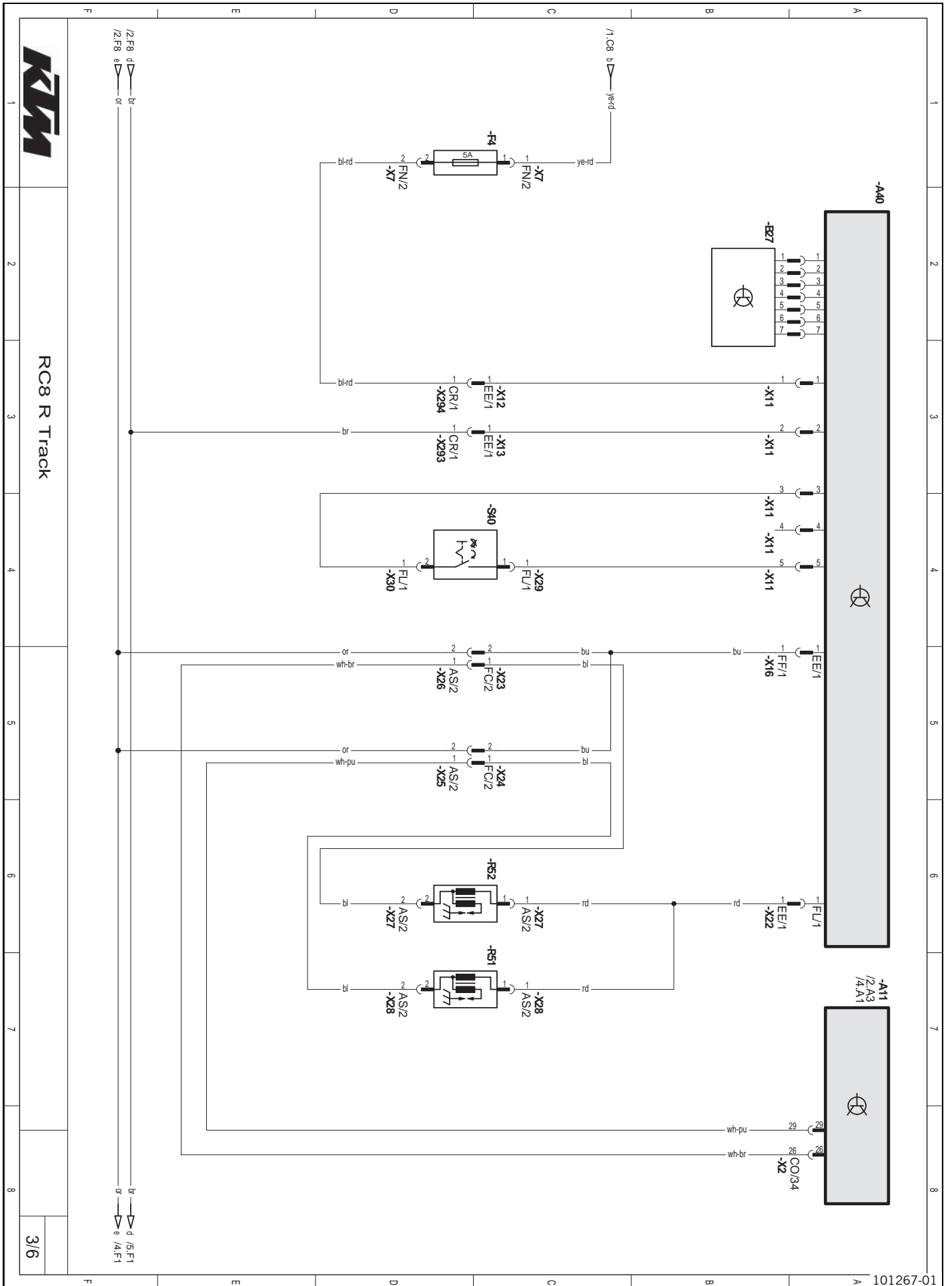

Components:

A11	EFI control unit
A40	Quick shifter control unit
B27	Quick shifter
F4	Fuse
R51	Ignition coil (cylinder 1)
R52	Ignition coil (cylinder 2)
S40	Quick shifter switch

Components:

A11	EFI control unit
B10	Throttle position sensor circuit A
B11	Throttle position sensor circuit B
M51	Injector (cylinder 1)
M52	Injector (cylinder 2)
M61	Motor drive circuit A
M62	Motor drive circuit B

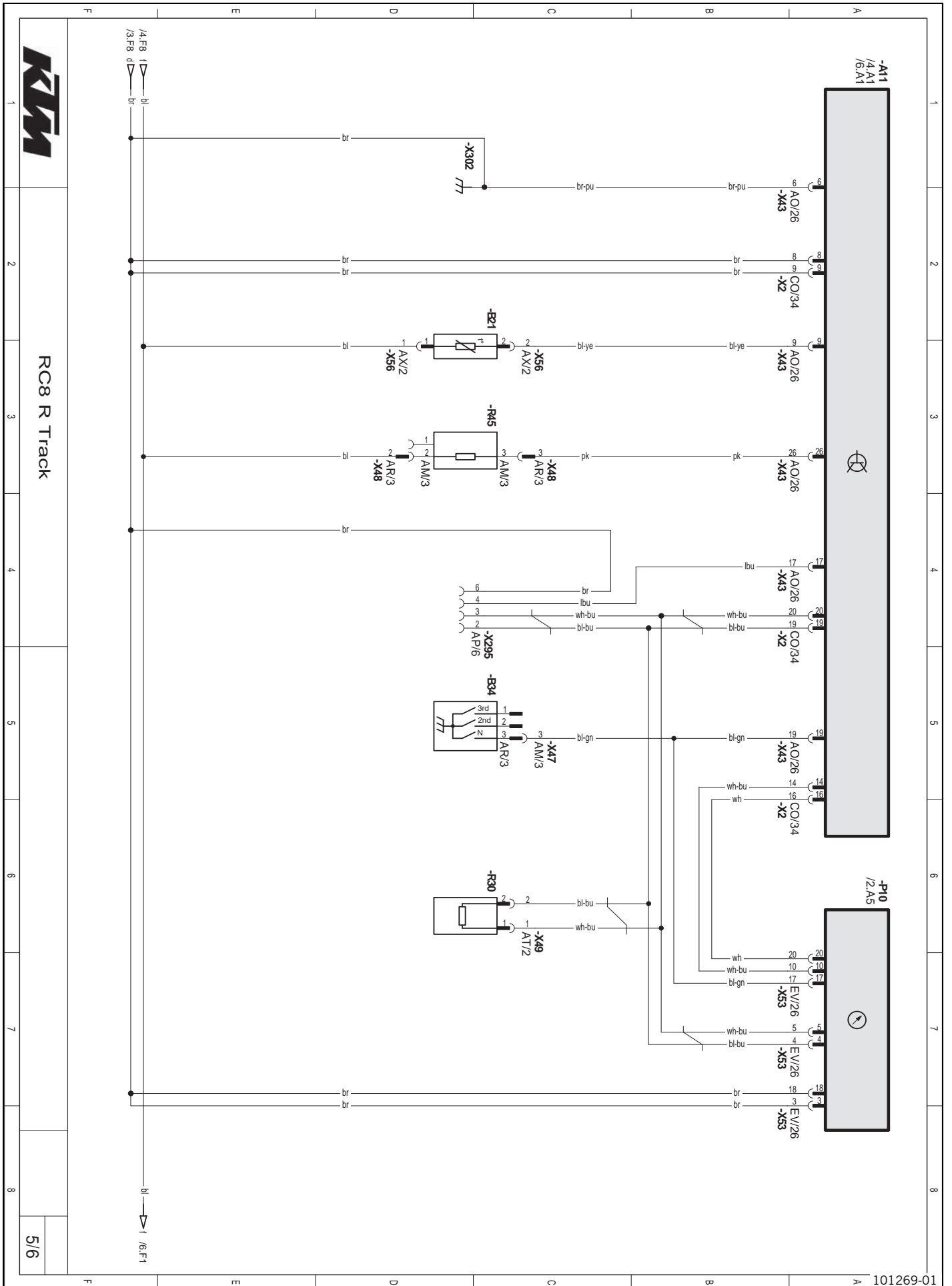

RC8 R Track

Components:

A11	EFI control unit
B21	Coolant temperature sensor (cylinder 1)
B34	Gear position sensor
P10	Combination instrument
R30	CAN bus terminating resistor
R45	Resistance
X295	Diagnostics connector

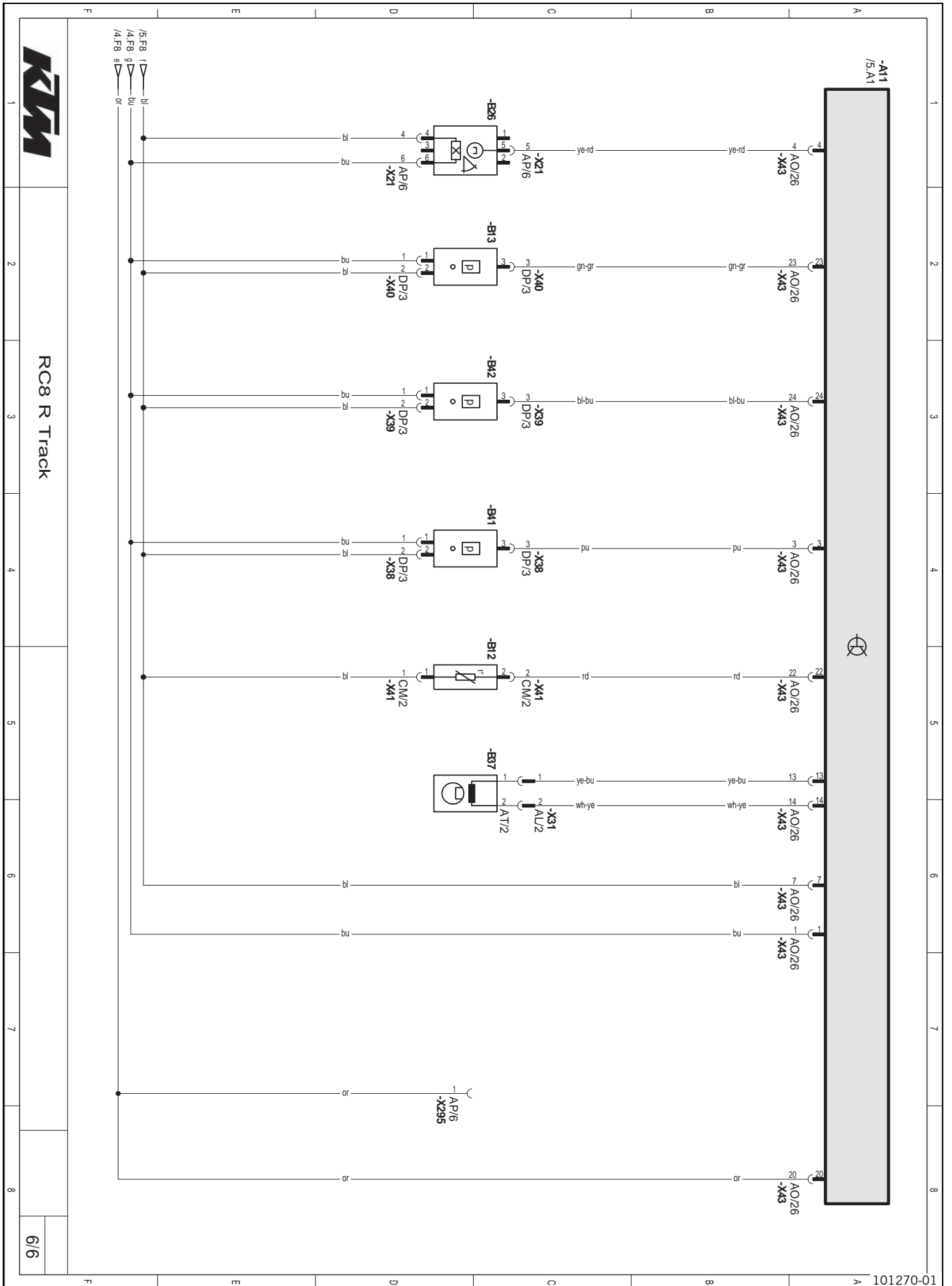

Components:

A11	EFI control unit
B12	Intake air temperature sensor
B13	Ambient air pressure sensor
B26	Rollover sensor
B37	Crankshaft position sensor
B41	Manifold absolute pressure sensor (cylinder 1)
B42	Manifold absolute pressure sensor (cylinder 2)
X295	Diagnostics connector

Cable colors:

bl	Black
br	Brown
bu	Blue
gn	Green
gr	Gray
lbu	Light blue
or	Orange
pk	Pink
pu	Violet
rd	Red
wh	White
ye	Yellow

Brake fluid DOT 4 / DOT 5.1

According to

- DOT

Guideline

- Use only brake fluid that complies with the specified standard (see specifications on the container) and that possesses the corresponding properties. KTM recommends **Castrol** and **Motorex®** products.

Supplier

Castrol

- **RESPONSE BRAKE FLUID SUPER DOT 4**

Motorex®

- **Brake Fluid DOT 5.1**

Coolant

Guideline

- Use only suitable coolant (also in countries with high temperatures). Use of low-quality antifreeze can lead to corrosion and foaming. KTM recommends **Motorex®** products.

Mixture ratio

Antifreeze protection: -25... -45 °C (-13... -49 °F)	50 % corrosion inhibitor/antifreeze 50 % distilled water
--	---

Coolant (mixed ready to use)

Antifreeze	-40 °C (-40 °F)
------------	-----------------

Supplier

Motorex®

- **Anti Freeze**

Engine oil (SAE 10W/50)

According to

- JASO T903 MA (☛ p. 121)
- SAE (☛ p. 121) (SAE 10W/50)

Guideline

- Use only engine oils that comply with the specified standards (see specifications on the container) and that possess the corresponding properties. KTM recommends **Motorex®** products.

Fully synthetic engine oil

Supplier

Motorex®

- **Power Synt 4T**

Engine oil (SAE 5W/40)

According to

- JASO T903 MA (☛ p. 121)
- SAE (☛ p. 121) (SAE 5W/40)

Guideline

- Use only engine oils that comply with the specified standards (see specifications on the container) and that possess the corresponding properties. KTM recommends **Motorex®** products.

Synthetic engine oil

Supplier

Motorex®

- **Power Synt 4T**

Fork oil (SAE 5)**According to**

- SAE (☛ p. 121) (SAE 5)

Guideline

- Use only oils that comply with the specified standards (see specifications on the container) and that possess the corresponding properties. KTM recommends **Motorex®** products.

Supplier**Motorex®**

- **Racing Fork Oil**

Hydraulic fluid (15)**According to**

- ISO VG (15)

Guideline

- Use only hydraulic oil that complies with the specified standard (see specifications on the container) and that possesses the corresponding properties. KTM recommends **Motorex®** products.

Supplier**Motorex®**

- **Hydraulic Fluid 75**

Shock absorber oil (SAE 2,5) (50180342S1)**According to**

- SAE (☛ p. 121) (SAE 2,5)

Guideline

- Use only oils that comply with the specified standards (see specifications on the container) and that possess the corresponding properties.

Super unleaded (ROZ 100)**According to**

- DIN EN 228 (ROZ 100)

Air filter cleaner

Guideline

- KTM recommends **Motorex®** products.

Supplier

Motorex®

- **Twin Air Dirt Bio Remover**

Air filter oil

Guideline

- KTM recommends **Motorex®** products.

Supplier

Motorex®

- **Air Filter Oil Spray 655**

Chain cleaner

Guideline

- KTM recommends **Motorex®** products.

Supplier

Motorex®

- **Chain Clean**

Chain lube for road use

Guideline

- KTM recommends **Motorex®** products.

Supplier

Motorex®

- **Chainlube Road**

Long-life grease

Guideline

- KTM recommends **Motorex®** products.

Supplier

Motorex®

- **Bike Grease 2000**

Motorcycle cleaner

Guideline

- KTM recommends **Motorex®** products.

Supplier

Motorex®

- **Moto Clean 900**

Paint cleaner and polish for high-gloss and matte finishes, bare metal and plastic surfaces

Guideline

- KTM recommends **Motorex®** products.

Supplier

Motorex®

- **Clean & Polish**

JASO T903 MA

Different technical development directions required a new specification for 4-stroke motorcycles – the JASO T903 MA Standard. Earlier, engine oils from the automobile industry were used for 4-stroke motorcycles because there was no separate motorcycle specification. Whereas long service intervals are demanded for automobile engines, high performance at high engine speeds are in the foreground for motorcycle engines. With most motorcycles, the gearbox and the clutch are lubricated with the same oil as the engine. The JASO MA Standard meets these special requirements.

SAE

The SAE viscosity classes were defined by the Society of Automotive Engineers and are used for classifying oils according to their viscosity. The viscosity describes only one property of oil and says nothing about quality.

A

Accessories 5

Air filter

 cleaning 56

 installing 56

 removing 55

B

Battery

 installing 76

 recharging 77

 removing 76

Blank time of the LAP button LAP BLANK TIME

 setting 32

Blink code

 engine control 93-94

Brake disc of rear brake

 checking 66

Brake discs, front

 checking 66

Brake fluid

 front brake, adding 67

 rear brake, adding 68

Brake fluid level

 front brake, checking 67

 rear brake, checking 68

Brake linings

 front brake, checking 68

 rear brake, checking 69

C

Care 91-92

Chain

 checking 63

 checking for dirt 61

 cleaning 61

Chain tension

 adjusting 62

 checking 62

Cleaning 91-92

Clutch

 fluid level, checking 64

 fluid level, correcting 65

Clutch lever 10

 adjusting basic position 64

Combination instrument

 activation and test 12

 additional functions menu, **OPTIONS** 27, 30

 blank time menu, **LAP, LAP BLANK TIME** button 24, 29-30

 display 12

 external temperature display menu, **OPTION OUTTEMP** 28, 30

 fuel reserve display menu, **TRIP F RESET** 25, 29-30

FUELDISTANCE menu 16, 29-30

 function buttons, handlebar 11

 indicator lamps 13

 info display 13

 kilometers/miles menu, **SET KM/MILES** 26, 29-30

LAP/BESTLAP/LastLap menu 19, 29-30

 maximum lap speed menu, **TOPSPEED** 19, 29-30

 maximum speed menu, **LAP/BESTLAP/TopSpeed** 20, 29-30

 mode menu, **CHANGE MODE** 22, 29-30

 next service menu, **DISTANCE TO Next Service** 17, 29-30

 notes/warnings 13

 number of laps menu, **SET NUM LAPS** 24, 29-30

 odometer menu, **ODO/Trip 1** 15, 29-30

 odometer menu, **ODO/Trip 2** 16, 29-30

 remaining laps menu, **LAPSTOGO** 18, 29-30

SETTINGS menu 23, 29-30

SET-UP menu 21, 29-30

 shift warning lamp menu, **SHIFT RPMS** 23, 29-30

 temperature display menu, **SET °C/°F** 26, 29-30

 time menu, **SET CLOCK** 22, 29-30

 tire pressure monitor menu, **TPMS** 27, 30

 total distance in **Race** mode menu, **RACEODO** 20, 29-30

UNITS menu 25, 29-30

Coolant

 refilling 81

Coolant level

 checking 80

Cooling system 80

 bleeding 81

 compensating tank, filling 80

E

Electric starter button 10

Emergency OFF switch 10

Engine

 running in 38

Engine number 9

Engine oil

 adding 90

 changing 87

 draining 87

 refilling 89

Engine oil level

 checking 87

Engine sprocket

 checking 63

Environment 6

Exhaust cover

 installing 58

 removing 58

External temperature display

 hiding 34

F

Filler cap

 closing 35

 opening 35

Filling up

 fuel 40

Foot brake lever 36

 adjusting 51

Foot brake lever stub

 adjusting 50

Footrest position	49	installing	89
adjusting	49	removing	88
Fork		Oil screen	
compression damping, adjusting	43	cleaning	87
fork legs, bleeding	55	Owner's manual	6
rebound, adjusting	43	P	
spring preload, adjusting	44	Play in the throttle cable	
Fork part number	9	checking	83
Frame sliders, front		Preparing for use	
installing	70	after storage	92
removing	70	checks and maintenance measures when preparing for use	39
Frame sliders, rear		Putting into operation	
installing	72	advice on first use	37
removing	72	Q	
Front wheel		Quick shifter	83
installing	71	positioning	86
removing	70	setting, checking	84
Fuel overflow reservoir		setting, tuning	84
checking	61	Quick shifter switch	11
Fuel tank		R	
installing	59	RACE mode	
removing	58	setting	31
Fuse		Rear hub cush drive	
individual power consumers, changing	79	checking	74
H		Rear sprocket	
Hand brake lever	10	checking	63
basic position, adjusting	66	Rear wheel	
Handlebar		installing	73
handlebar height	51	removing	72
handlebar height, adjusting	52	ROAD mode	
K		setting	31
Kilometers/miles SET KM/MILES		S	
setting	33	Seat	
L		fitting	55
Lap times		removing	55
displaying	31	Service	5
M		Service schedule	41-42
Main fuse		SET °C/°F temperature unit	
changing	78	setting	34
Materials	5	SET CLOCK	
Maximum speed		setting	31
displaying	31	Shift lever	35
Motorcycle		adjusting	50
cleaning	91	Shift lever stub	
raising the front with lifting gear	54	adjusting	49
raising the rear with lifting gear	54	Shift speed RPM1/2	
removing the front from the lifting gear	54	adjusting	32
removing the rear from the lifting gear	54	Shock absorber	
N		compression damping, general	44
Number of laps SET NUM LAPS		compression damping, high-speed, adjusting	45
setting	33	compression damping, low-speed, adjusting	44
O		rebound damping, adjusting	45
Oil filter		spring preload, adjusting	45
changing	87	Shock absorber part number	9

Side cover, left	
installing	57
removing	57
Side cover, right	
installing	57
removing	57
Spare parts	5
Starting	39
Steering damper	46
adjusting	46
Steering damper part number	9
Storage	91
T	
Technical data	
chassis	99-100
chassis tightening torques	103-104
engine	95-96
engine tightening torques	97-98
fork	101
shock absorber	102
Throttle cable play	
adjusting	83
Throttle grip	10
Tire air pressure	
checking	75
Tire condition	
checking	74
Transport	5
Type label	9
U	
Use definition	5
V	
Vehicle identification number	9
Vehicle level	47
front, adjusting	47
rear, adjusting	48
View of vehicle	
front left	7
rear right	8
W	
Warranty	5
Wiring diagram	106-117
page 1 of 6	106
page 2 of 6	108
page 3 of 6	110
page 4 of 6	112
page 5 of 6	114
page 6 of 6	116
Work rules	5



3211609en



02/2011 Photo: Mitterbauer



KTM-Sportmotorcycle AG
5230 Mattighofen/Austria
<http://www.ktm.com>