

SETUP INSTRUCTIONS 2011

990 Supermoto R EU
990 Supermoto R FR
990 Supermoto R AUS/UK
990 SUPERMOTO R USA

Art. no. 3211733en



KTM

The work described in these setup instructions must be performed before the vehicle is delivered to the customer.

Read the setup instructions in their entirety before beginning work.

Print out the current **PDI** form found on the **KTM DEALER.NET**.

These setup instructions were written to correspond to the latest state of this series. We reserve the right to make changes in the interest of technical advancement without at the same time updating this manual.

We shall not provide a description of general workshop methods. Likewise, safety rules that apply in a workshop are not specified here. It is assumed that the work will be performed by a fully trained mechanic.

All specifications are non-binding. KTM Sportmotorcycle AG specifically reserves the right to modify or delete technical specifications, prices, colors, forms, materials, services, designs, equipment, etc., without prior notice and without specifying reasons, to adapt these to local conditions, as well as to stop production of a particular model without prior notice. KTM accepts no liability for delivery options, deviations from illustrations and descriptions, as well as misprints and other errors. The models portrayed partly contain special equipment that does not belong to the regular scope of delivery.

© 2011 KTM-Sportmotorcycle AG, Mattighofen Austria

All rights reserved

Reproduction, even in part, as well as copying of all kinds, is permitted only with the express written permission of the copyright owner.



ISO 9001(12 100 6061)

According to the international quality management standard ISO 9001, KTM uses quality assurance processes that lead to the maximum possible quality of the products.

Issued by: TÜV Management Service

REG.NO. 12 100 6061

KTM-Sportmotorcycle AG
5230 Mattighofen, Austria

Symbols used

The symbols used are explained in the following.



Indicates an expected reaction (e.g. of a work step or a function).



Indicates an unexpected reaction (e.g. of a work step or a function).



Identifies a page reference (more information is provided on the specified page).



Denotes additional information or tips.



Denotes the result of a test step.



Denotes a voltage measurement.



Denotes a current measurement.



Denotes a resistance measurement.

Formats used

The following typographical formats are used.

Specific name Identifies a proprietary name.

Name[®] Identifies a protected name.

Brand[™] Identifies a brand in merchandise traffic.

Unpacking and setting up the vehicle

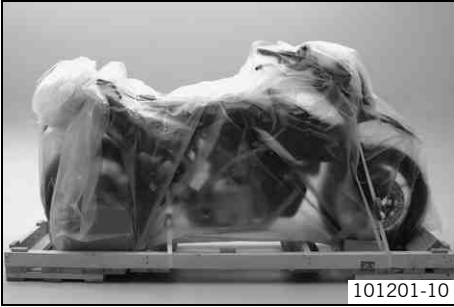

- Remove the carton.
- Remove the adhesive tape in the upper area of the motorcycle.



- Roll down the film at the sides.

i **Info**

To avoid damaging the motorcycle during unpacking, leave the other films on the vehicle until you have finished work on the vehicle.

- Unpack the separate enclosure and check its contents on the basis of the enclosure list.
- Check the vehicle for transport damage.

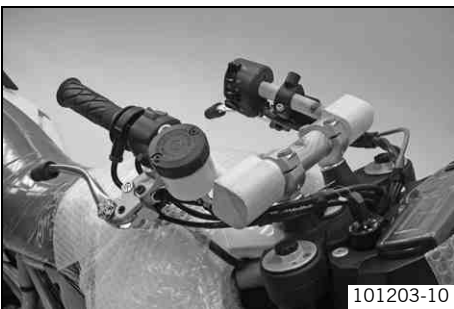

- Remove the controls from the transport holder. Remove the screws and handlebar clamps. Remove the transport holder.

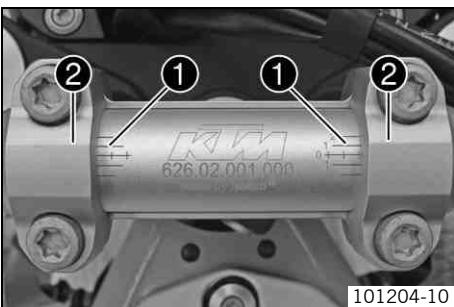

- Remove the right-hand handlebar weight.
- Position the controls on the right half of the handlebar but do not tighten.
- Position the handlebar.
- Position the handlebar clamps. Fit and slightly tighten the four screws.
- Position the handlebar exactly.
 - ✓ The marking **1** of the scale on the handlebar must align with the edge **2** of the handlebar clamp.
- Tighten the four screws evenly.

Guideline

Screw, handlebar clamp	M8	20 Nm (14.8 lbf ft)
------------------------	----	------------------------

- Position the right combination switch. Tighten the screws.

i **Info**

Position holding lug **A** in bore **B**.

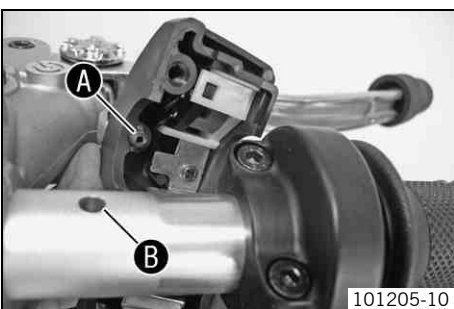



- Position the hand brake cylinder. Tighten the screws.

Guideline

Remaining chassis screws	M6	10 Nm (7.4 lbf ft)
--------------------------	----	--------------------



- Position the throttle grip. Tighten the screws.

Guideline

Remaining chassis screws	M5	5 Nm (3.7 lbf ft)
--------------------------	----	-------------------

- Mount and tighten the right handlebar weight.

Guideline

Remaining chassis screws	M6	10 Nm (7.4 lbf ft)
--------------------------	----	--------------------

101206-01

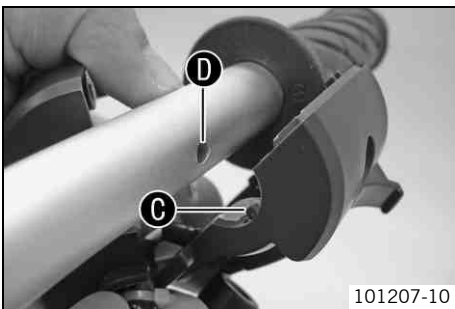

- Position the left combination switch. Tighten the screws.

i Info

Position holding lug **C** in bore **D**.

101207-10



- Position the clutch master cylinder and tighten the screw.

Guideline

Remaining chassis screws	M6	10 Nm (7.4 lbf ft)
--------------------------	----	--------------------

101208-01



- Mount and tighten the rear mirror adapter and rear mirror on both sides.

101209-01



- Mount the reflector.

101210-01

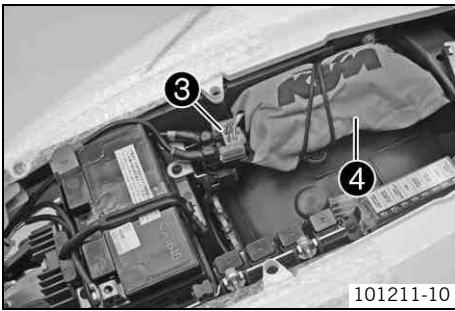

- Remove the seat. (☞ p. 6)
- Recharge the battery. (☞ p. 6)
- Insert connector ③ into the starter relay.
- Secure tool set ④ with the rubber strap.
- Remove the protective film from the seat.
- Mount the seat. (☞ p. 6)

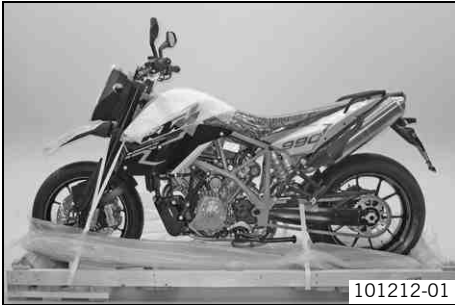

- Carefully loosen and remove the tensioning belt over the link fork.

**Info**

An assistant prevents the motorcycle from falling over.

- Carefully loosen and remove the tensioning belts around the lower triple clamp.
 - ✓ The vehicle is released at the front.
- Together with an assistant, take the vehicle off of the pallette.
- Remove the protective plastic.
- Refuel. (☞ p. 8)
- Print out the current **PDI** form found on **KTM DEALER.NET** and perform the delivery inspection.
- Set kilometers or miles. (☞ p. 9)
- Set the clock. (☞ p. 9)

Removing the seat

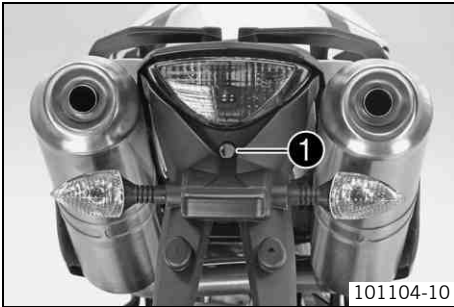

- Insert the ignition key in the seat lock ❶ and turn it clockwise.
- Raise the rear of the seat, push it towards the rear, and remove it upwards.
- Remove the ignition key from the seat lock.

Mounting the seat

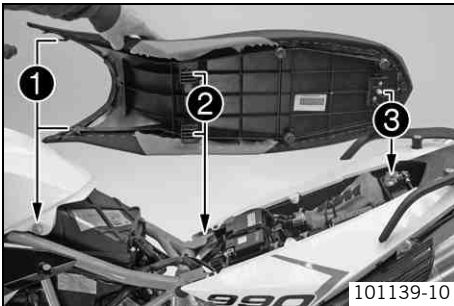

- Position front recesses ❶ of the seat on the oval head screws of the fuel tank, lower the rear and simultaneously push it forward. Both lugs ❷ must hook into the frame and locking bolt ❸ must be inserted into the lock housing.
- ✓ The seat engages with an audible click.
- Finally, check that the seat is correctly mounted.

Recharging the battery



Warning

Risk of injury Battery acid and battery gases cause serious chemical burns.

- Keep batteries out of the reach of children.
- Wear suitable protective clothing and goggles.
- Avoid contact with battery acid and battery gases.
- Keep the battery away from sparks or open flames. Charge only in well-ventilated areas.
- In the event of skin contact, rinse with large amounts of water. If battery acid gets in the eyes, rinse with water for at least 15 minutes and contact a physician.



Warning

Environmental hazard The battery contains elements that are harmful to the environment.

- Do not discard batteries with the household trash. Dispose of a defective battery in an environmentally compatible manner. Give the battery to your KTM dealer or to a recycling center that accepts used batteries.



Warning

Environmental hazard Hazardous substances cause environmental damage.

- Oil, grease, filters, fuel, cleaners, brake fluid, etc., should be disposed of as stipulated in applicable regulations.



Info

Even when there is no load on the battery, it discharges steadily. The charge state and the type of charge are very important for the service life of the battery. Rapid recharging with a high charging current shortens the battery's service life. If the charging current, charging voltage and charging time are exceeded, electrolyte escapes through the safety valves. This reduces the battery capacity. If the battery is depleted from starting the vehicle repeatedly, the battery must be charged immediately. If the battery is left in a discharged state for an extended period, it will become over-discharged and sulfate, destroying the battery. The battery is maintenance-free, i.e., the acid level does not have to be checked.

- Switch off all power consumers and switch off the engine.
- Remove the seat. (☛ p. 6)
- Disconnect the negative (minus) cable of the battery to avoid damage to the motorcycle's electronics.

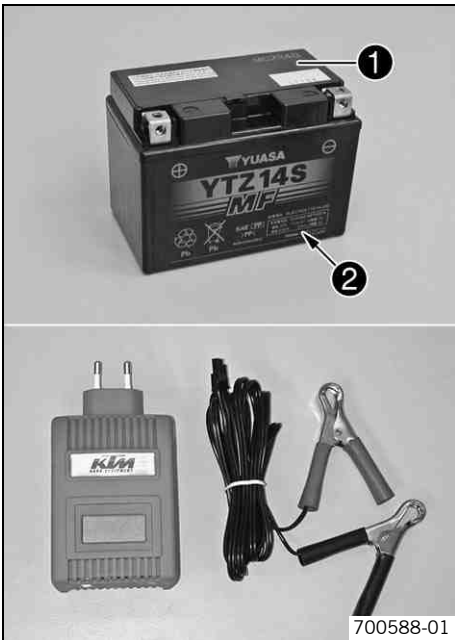

- Connect the battery charger to the battery. Switch on the battery charger.

Battery charger (58429074000)

You can also use the battery charger to test the rest potential and start potential of the battery, and to test the alternator. With this device, you cannot overcharge the battery.



Info

Never remove lid ❶.

Charge the battery at no more than 10% of the capacity specified on battery housing ❷.

- Switch off the charger after charging. Disconnect the battery.

Guideline

The charge current, charge voltage and charge time must not be exceeded.

Charge the battery regularly when the motorcycle is not in use	3 months
--	----------

- Mount the seat. (☛ p. 6)

Opening the filler cap



Danger

Fire hazard Fuel is highly flammable.

- Never refuel the vehicle near open flames or burning cigarettes, and always switch off the engine first. Be careful that no fuel is spilt, especially on hot vehicle components. Clean up spilt fuel immediately.
- Fuel in the fuel tank expands when warm and can escape if the tank is overfilled. See the notes on refueling.



Warning

Danger of poisoning Fuel is poisonous and a health hazard.

- Avoid contact between fuel and skin, eyes and clothing. Do not inhale fuel vapors. If fuel gets into your eyes, rinse immediately with water and contact a doctor. Wash affected skin areas immediately with soap and water. If fuel is swallowed, contact a doctor immediately. Change clothing that has come into contact with fuel. Store fuel in a suitable canister according to regulations and keep it out of the reach of children.



Warning

Environmental hazard Improper handling of fuel is a danger to the environment.

- Do not allow fuel to get into the ground water, the ground, or the sewage system.

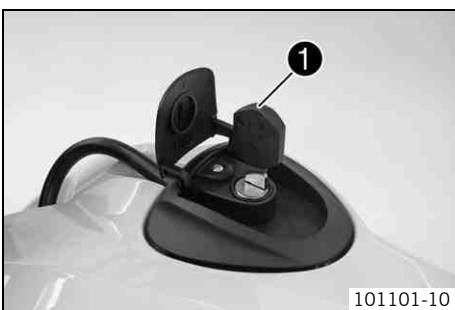

- Lift the cover of the filler cap ❶ and insert the ignition key.

Note

Danger of damage Ignition key breakage.

- To take pressure off of the ignition key, push down on the filler cap. Damaged ignition keys must be replaced.

- Turn the ignition key 90° counterclockwise and remove the filler cap.



Info

The filler cap has a tank air vent system.

Closing the filler cap



- Put the filler cap back on and turn the ignition key 90° clockwise.
- Remove the ignition key and fold down the cover.

Refueling



Danger

Fire hazard Fuel is highly flammable.

- Never refuel the vehicle near open flames or burning cigarettes, and always switch off the engine first. Be careful that no fuel is spilt, especially on hot vehicle components. Clean up spilt fuel immediately.
- Fuel in the fuel tank expands when warm and can escape if the tank is overfilled. See the notes on refueling.



Warning

Danger of poisoning Fuel is poisonous and a health hazard.

- Avoid contact of the fuel with skin, eyes and clothing. Do not inhale fuel vapors. If fuel gets into your eyes, rinse immediately with water and contact a doctor. Wash affected skin areas immediately with soap and water. If fuel is swallowed, contact a doctor immediately. Change clothing that has come into contact with fuel.

Note

Material damage Premature clogging of the fuel filter.

- In some countries and regions, the available fuel quality and cleanliness may not be sufficient. This will result in problems with the fuel system.
- Only refuel with clean fuel that meets the specified standards.



Warning

Environmental hazard Improper handling of fuel is a danger to the environment.

- Do not allow fuel to get into the ground water, the ground, or the sewage system.

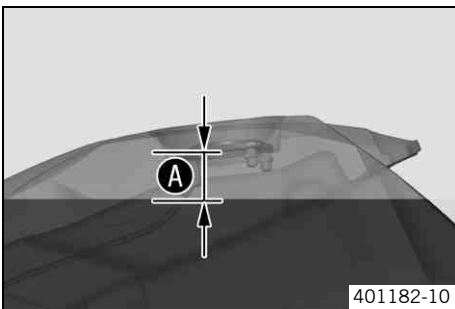

- Switch off the engine.
- Open the filler cap. (☛ p. 7)
- Fill the fuel tank with fuel no higher than level **A**.

Guideline

Distance A	35 mm (1.38 in)	
Total fuel tank capacity, approx.	15 l (4 US gal)	Super unleaded (ROZ 95/RON 95/PON 91) (☛ p. 12)

- Close the filler cap. (☛ p. 8)

For low octane fuel

Note

Engine failure Low-quality fuel damages the engine.

- Operate the vehicle with fuel with an octane rating below 95 (ROZ 95/RON 95/PON 91) for no more than one tank full.
 - The ignition curve must be adjusted to low octane fuel.
-
- Adjust the ignition curve to the fuel quality.



400970-12

- Press the **SET** button ② for two seconds.
- ✓ The low fuel warning lamp ① goes out. **TRIP F** is set to **0.0** and the display returns to the previous display mode.



Info

If the **SET** button ② is not pressed, the value is automatically reset after approx. 3 minutes.

Setting kilometers or miles



Info

If you change the unit, the value **ODO** is retained and converted accordingly. Making the setting according to the country.

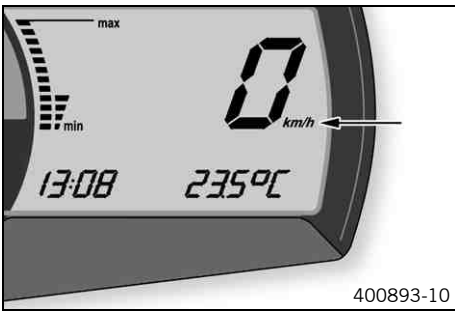

400893-10

Condition

The motorcycle is stationary.

- Switch on the ignition by turning the ignition key to the **ON** \odot position.
- Press the **MODE** button repeatedly until the **ODO** mode is active.
- Keep the **MODE** button pressed until the display mode changes from **km/h** to **mph** or from **mph** to **km/h**.

Setting the clock

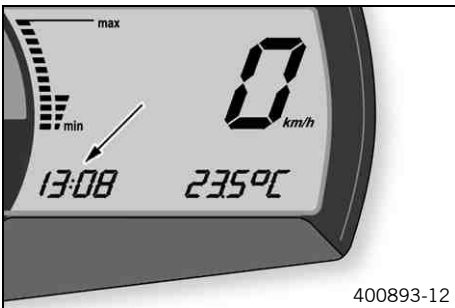

400893-12

Condition

The motorcycle is stationary.

- Switch on the ignition by turning the ignition key to the **ON** \odot position.
- Press the **MODE** button repeatedly until the **ODO** mode is active.
- Keep the **MODE** button and the **SET** button pressed simultaneously.
- ✓ The time display begins to flash.
- Press the **MODE** button to set the hour.
- Press the **SET** button to set the minute.
- Keep the **MODE** button and the **SET** button pressed simultaneously.
- ✓ The time is set.

Remaining frame bolts	EJOT Delta PT 50x12	1.2 Nm (0.89 lbf ft)	–
Remaining frame bolts	EJOT PT K50x12 T20	1.2 Nm (0.89 lbf ft)	–
Remaining frame bolts	EJOT PT K50x18 T20	2 Nm (1.5 lbf ft)	–
Screw, combination instrument	EJOT Delta PT 50x12	1 Nm (0.7 lbf ft)	–
Screw, side stand switch	M4	2 Nm (1.5 lbf ft)	Loctite® 243™
Screw, wheel speed sensor	M4	2 Nm (1.5 lbf ft)	Loctite® 243™
Remaining chassis nuts	M5	5 Nm (3.7 lbf ft)	–
Remaining chassis screws	M5	5 Nm (3.7 lbf ft)	–
Screw, chain sliding guard	M5	5 Nm (3.7 lbf ft)	–
Screw, closure flange, fuel tank	M5	3.3 Nm (2.43 lbf ft)	–
Screw, engine oil level viewer	M5	3.3 Nm (2.43 lbf ft)	–
Screw, foot brake lever stub	M5	6 Nm (4.4 lbf ft)	Loctite® 243™
Nut, tail light	M6	8 Nm (5.9 lbf ft)	–
Remaining chassis nuts	M6	15 Nm (11.1 lbf ft)	–
Remaining chassis screws	M6	10 Nm (7.4 lbf ft)	–
Screw, chain sliding guard	M6	6 Nm (4.4 lbf ft)	Loctite® 243™
Screw, foot brake cylinder	M6	10 Nm (7.4 lbf ft)	Loctite® 243™
Screw, fuel pump	M6	6 Nm (4.4 lbf ft)	–
Screw, fuel tap	M6	6 Nm (4.4 lbf ft)	–
Screw, magnetic holder on side stand	M6	6 Nm (4.4 lbf ft)	Loctite® 243™
Screw, seat bracket, fuel tank	M6	3.3 Nm (2.43 lbf ft)	–
Screw, splash protector	M6	6 Nm (4.4 lbf ft)	Loctite® 243™
Screw, spoiler	M6	3.3 Nm (2.43 lbf ft)	–
Nut, manifold on cylinder head	M8	Tightening sequence: Tighten the nuts uniformly. Do not bend the metal.	–
Remaining chassis nuts	M8	30 Nm (22.1 lbf ft)	–
Remaining chassis screws	M8	25 Nm (18.4 lbf ft)	–
Screw, bottom triple clamp	M8	15 Nm (11.1 lbf ft)	–
Screw, exhaust clamp on distributor pipe	M8	35 Nm (25.8 lbf ft)	–
Screw, exhaust clamp on main silencer	M8	20 Nm (14.8 lbf ft)	–
Screw, fork stub	M8	15 Nm (11.1 lbf ft)	–
Screw, front brake disc	M8	30 Nm (22.1 lbf ft)	Loctite® 243™
Screw, handlebar clamp	M8	20 Nm (14.8 lbf ft)	–
Screw, handrail	M8	20 Nm (14.8 lbf ft)	–
Screw, ignition lock (ratchet screw)	M8		Loctite® 243™
Screw, rear brake disc	M8	30 Nm (22.1 lbf ft)	Loctite® 243™
Screw, rear footrest bracket	M8	25 Nm (18.4 lbf ft)	Loctite® 243™
Screw, spring holder on side stand bracket	M8	25 Nm (18.4 lbf ft)	Loctite® 243™
Screw, steering stem	M8	20 Nm (14.8 lbf ft)	–
Screw, top triple clamp	M8	20 Nm (14.8 lbf ft)	–
Remaining chassis nuts	M10	50 Nm (36.9 lbf ft)	–
Remaining frame bolts	M10	45 Nm (33.2 lbf ft)	–
Screw connection, engine mounting bracket	M10	45 Nm (33.2 lbf ft)	–
Screw, handlebar support	M10	20 Nm (14.8 lbf ft)	–
Screw, side stand	M10	35 Nm (25.8 lbf ft)	Loctite® 243™
Screw, side stand bracket	M10	45 Nm (33.2 lbf ft)	Loctite® 243™
Screw connection, rear hub shock absorber/rear sprocket	M10x1.25	50 Nm (36.9 lbf ft)	Loctite® 243™
Screw, front brake caliper	M10x1.25	45 Nm (33.2 lbf ft)	Loctite® 243™

Screw, lower subframe	M10x1.25	45 Nm (33.2 lbf ft)	Loctite® 243™
Screw, upper subframe	M10x1.25	45 Nm (33.2 lbf ft)	Loctite® 243™
Oil drain plug with magnet	M12x1.5	25 Nm (18.4 lbf ft)	–
Screw connection, suction line	M14x1.5	45 Nm (33.2 lbf ft)	Loctite® 577
Screw, bottom shock absorber	M14x1.5	80 Nm (59 lbf ft)	Thread greased
Screw, top shock absorber	M14x1.5	80 Nm (59 lbf ft)	Thread greased
Nut, oil line	M16x1.5	25 Nm (18.4 lbf ft)	–
Nut, swingarm pivot	M19x1.5	130 Nm (95.9 lbf ft)	Thread greased
Screw, steering head	M20x1.5	12 Nm (8.9 lbf ft)	–
Bolt, front axle	M25x1.5	45 Nm (33.2 lbf ft)	–
Nut, rear wheel spindle	M25x1.5	90 Nm (66.4 lbf ft)	Thread greased

Super unleaded (ROZ 95/RON 95/PON 91)

According to

- DIN EN 228 (ROZ 95/RON 95/PON 91)

Guideline

- Only use unleaded super fuel that matches or is equivalent to the specified fuel grade.
- Fuel with an ethanol content of up to 10 % (E10 fuel) is safe to use.



Info

Do **not** use fuel containing methanol (e. g. M15, M85, M100) or more than 10 % ethanol (e. g. E15, E25, E85, E100).



3211733en



03/2011 Photo: Mitterbauer



KTM-Sportmotorcycle AG
5230 Mattighofen/Austria
<http://www.ktm.com>