

OWNER'S MANUAL 2012

990 Supermoto R EU

990 Supermoto R FR

990 Supermoto R AUS/UK

Art. no. 3211794en



KTM

DEAR KTM CUSTOMER

Congratulations on your decision to purchase a KTM motorcycle. You are now the owner of a state-of-the-art sports motorcycle that will give you enormous pleasure if you service and maintain it accordingly.

We wish you a lot of enjoyment in riding this vehicle.

Please enter the serial numbers of your vehicle below.

Chassis number/type label (☛ p. 16)	Dealer's stamp
Engine number (☛ p. 17)	
Key number (☛ p. 17)	

The owner's manual contained the latest information for this model at the time of going to print. Minor differences due to developments in design cannot be ruled out completely.

All specifications are non-binding. KTM Sportmotorcycle AG specifically reserves the right to modify or delete technical specifications, prices, colors, forms, materials, services, designs, equipment, etc., without prior notice and without specifying reasons, to adapt these to local conditions, as well as to stop production of a particular model without prior notice. KTM accepts no liability for delivery options, deviations from illustrations and descriptions, as well as misprints and other errors. The models portrayed partly contain special equipment that does not belong to the regular scope of delivery.

© 2011 KTM-Sportmotorcycle AG, Mattighofen Austria

All rights reserved

Reproduction, even in part, as well as copying of all kinds, is permitted only with the express written permission of the copyright owner.



ISO 9001(12 100 6061)





According to the international quality management standard ISO 9001, KTM uses quality assurance processes that lead to the maximum possible quality of the products.

Issued by: TÜV Management Service

REG.NO. 12 100 6061

KTM-Sportmotorcycle AG
5230 Mattighofen, Austria

MEANS OF REPRESENTATION	7	Combination instrument - display.....	27
IMPORTANT INFORMATION	8	Combination instrument - speedometer.....	28
VIEW OF VEHICLE.....	12	Setting kilometers or miles	28
View of vehicle, front left side (vehicle differs slightly from photo)	12	Combination instrument - time	29
View of vehicle, rear right side (vehicle differs slightly from photo)	14	Setting the clock	29
SERIAL NUMBERS.....	16	Combination instrument - ODO display	30
Chassis number/type label.....	16	Combination instrument - setting/resetting TRIP 1.....	30
Engine number.....	17	Combination instrument - setting/resetting TRIP 2.....	31
Key number	17	Combination instrument - TRIP F display.....	32
Fork part number.....	18	Combination instrument - ambient temperature display.....	32
Shock absorber part number	18	Setting the temperature units	33
CONTROLS	19	Combination instrument - warning of slippery roads	33
Clutch lever	19	Combination instrument - coolant temperature indicator	34
Hand brake lever	19	Opening the filler cap	34
Throttle grip.....	20	Closing the filler cap.....	35
Light switch	20	Seat lock	36
Headlight flasher switch.....	21	Tool set	36
Turn signal switch	21	Handrails.....	37
Horn button	22	Helmet lock	37
Emergency OFF switch	22	Passenger footrests.....	38
Electric starter button	23	Shift lever.....	38
Ignition/steering lock	23	Foot brake lever.....	39
Immobilizer	24	Side stand	40
Combination instrument.....	24	PREPARING FOR USE	41
Combination instrument - function buttons	25	Information on first use.....	41
Combination instrument - tachometer.....	25	Running in the engine.....	42
Combination instrument - indicator lamps.....	26	Loading the vehicle	42

RIDING INSTRUCTIONS	45	Removing the seat	70
Checks and maintenance measures when preparing for use	45	Mounting the seat	71
Starting	46	Mounting the helmet lock on the vehicle.....	71
Starting off	48	Reinstalling the fuel tank	72
Shifting, riding.....	48	Positioning the fuel tank	73
Braking	51	Checking the chain for dirt	75
Stopping, parking.....	53	Cleaning the chain.....	75
Refueling.....	54	Checking the chain tension	76
SERVICE SCHEDULE.....	56	Adjusting the chain tension	77
Service schedule	56	Checking the chain, rear sprocket, engine sprocket and chain guide.....	79
TUNING THE CHASSIS.....	59	Adjusting the basic position of the clutch lever.....	82
Fork/shock absorber.....	59	Checking/rectifying the fluid level of the hydraulic clutch	82
Adjusting the compression damping of the fork	59	BRAKES	84
Adjusting the rebound damping of the fork.....	60	ABS/antilock brake system	84
Adjusting the spring preload of the fork	61	Adjusting the basic position of the hand brake lever.....	85
Compression damping of the shock absorber	63	Checking the front brake discs.....	85
Adjusting the low-speed compression damping of the shock absorber	63	Checking the front brake fluid level	86
Adjusting the high-speed compression damping of the shock absorber	64	Adding front brake fluid 	87
Adjusting the rebound damping of the shock absorber.....	65	Checking the front brake linings.....	88
Adjusting the spring preload of the shock absorber 	66	Checking the free travel of the foot brake lever	89
SERVICE WORK ON THE CHASSIS.....	68	Adjusting the basic position of the foot brake lever	90
Raising the motorcycle with the front wheel stand	68	Checking the rear brake disc.....	91
Taking the motorcycle off of the front wheel stand	68	Checking the rear brake fluid level	91
Raising the motorcycle with the rear wheel stand.....	69	Adding rear brake fluid 	92
Taking the motorcycle off of the rear wheel stand	69	Checking the rear brake linings	94
Bleeding the fork legs	70	WHEELS, TIRES	96
		Removing the front wheel 	96
		Installing the front wheel 	97













Removing the rear wheel 	99	Adjusting the play in the throttle cable 	149
Installing the rear wheel 	101	Ignition curve plug-in connector.....	149
Checking rear hub shock absorbers 	104	Adjusting the ignition curve to the fuel quality.....	150
Checking the tire condition.....	105	Checking the basic position of the shift lever.....	151
Checking the tire air pressure	106	Adjusting the basic position of the shift lever 	151
ELECTRICAL SYSTEM	108	SERVICE WORK ON THE ENGINE	153
Removing the battery 	108	Checking the engine oil level	153
Installing the battery 	110	Changing the engine oil and filter, cleaning the oil screens 	154
Recharging the battery 	111	Draining the engine oil and filter, cleaning the oil screens 	154
Changing the main fuse	113	Filling up with engine oil 	159
Changing the ABS fuses.....	115	Adding engine oil	160
Changing the fuses of individual power consumers.....	116	CLEANING, CARE	161
Changing the headlight bulb.....	118	Cleaning motorcycle	161
Changing the parking light bulb	121	Checks and maintenance measures for winter operation	163
Changing the turn signal bulb.....	123	STORAGE	164
Changing the brake light bulb.....	124	Storage.....	164
Changing the tail light bulbs.....	128	Preparing for use after storage	165
Changing the license plate lamp	132	TROUBLESHOOTING.....	166
Checking the headlight setting.....	134	IMMOBILIZER BLINK CODE.....	169
Adjusting the headlight range	134	ENGINE CONTROL BLINK CODE.....	171
Activating/deactivating the ignition key.....	135	TECHNICAL DATA - ENGINE.....	177
COOLING SYSTEM	140	Capacity - engine oil	178
Cooling system	140	Capacity - coolant.....	178
Checking the antifreeze and coolant level	140	TECHNICAL DATA - ENGINE TIGHTENING TORQUES.....	179
Checking the coolant level in the compensating tank	143	TECHNICAL DATA - CHASSIS	182
Draining the coolant 	144	Lighting equipment	183
Filling/bleeding the cooling system 	145	Capacity - fuel.....	184
TUNING THE ENGINE	148		
Checking the play in the throttle cable.....	148		

TABLE OF CONTENTS

TECHNICAL DATA - FORK.....	185
TECHNICAL DATA - SHOCK ABSORBER	186
TECHNICAL DATA - CHASSIS TIGHTENING TORQUES	188
SUBSTANCES.....	191
AUXILIARY SUBSTANCES.....	195
STANDARDS.....	197
INDEX	198

Symbols used

The meaning of specific symbols is described below.



Indicates an expected reaction (e.g. of a work step or a function).



Indicates an unexpected reaction (e.g. of a work step or a function).



All work marked with this symbol requires specialist knowledge and technical understanding. In the interest of your own safety, have these jobs performed by an authorized KTM workshop! There, your motorcycle will be serviced optimally by specially trained experts using the specialist tools required.



Indicates a page reference (more information is provided on the specified page).

Formats used

The typographical formats used in this document are explained below.

Specific name

Identifies a proprietary name.

Name[®]

Identifies a protected name.

Brand[™]

Identifies a brand available on the open market.

Use definition

KTM sport motorcycles are designed and constructed to meet the normal demands of regular road operation but not for use on race courses or offroad.



Info

The motorcycle is authorized for public road traffic in the homologous version only.

Service

A prerequisite for perfect operation and prevention of premature wear is that the service, care and tuning work on the engine and chassis are properly carried out as described in the owner's manual. Poor adjustment and tuning of the engine and suspension can lead to damage and breakage of components.

Using the motorcycle in extreme conditions such as very muddy or wet roads can lead to above-average wear of components such as the transmission train or the brakes. For this reason, it may be necessary to service or replace worn parts before the limit specified in the service schedule is reached.

Pay careful attention to the prescribed running-in period and service intervals. Close adherence to these periods will significantly lengthen the service life of your motorcycle.

Warranty

The work prescribed in the service schedule must be carried out by an authorized KTM workshop only and confirmed in the customer's service record and in the **KTM dealer.net**; otherwise, all warranty claims will be void. No warranty claim can be honored for damage resulting from manipulation and/or other changes to the vehicle.

Fuels, oils, etc.

The fuels and lubricants named in the owner's manual must be used according to specifications.

Spare parts, accessories

For your own safety, only use spare parts and accessory products that have been approved and/or recommended by KTM and have them installed by an authorized KTM workshop. KTM accepts no liability for other products and any resulting damage.

Some of the spare parts and accessory products are specified in parentheses under the respective descriptions. Your KTM dealer will be glad to advise you.

You will find the current **KTM PowerParts** for your vehicle on the KTM website.

International KTM Website: <http://www.ktm.com>

Work rules

Special tools are necessary for some of the work. These are not included with the vehicle and can be ordered under the number in parentheses. Ex: valve spring mounter (59029019000)

During assembly, non-reusable parts (e.g. self-locking screws and nuts, seals and seal rings, O-rings, pins, lock washers) must be replaced by new parts.

Where thread lockers are used on screw connections (e.g., **Loctite**®), follow the instructions for use from the manufacturer.

Parts that you want to reuse following repairs and servicing should be cleaned and checked for damage and wear. Change damaged or worn parts.

Following repairs or servicing, the vehicle must be checked for roadworthiness.

Transport

Note

Danger of damage The parked vehicle may roll away or fall over.

- Always place the vehicle on a firm and even surface.

Note

Fire hazard Some vehicle components become very hot when the vehicle is operated.

- Do not park the vehicle near flammable or explosive substances. Do not place objects on the vehicle while it is still warm from being run. Always let the vehicle cool first.

- Switch off the engine and remove the ignition key.
- Secure the motorcycle against falling over or rolling away using straps or other suitable devices.

Environment

Motorcycling is a wonderful sport and we naturally hope that you can enjoy it to the full. However, it can also lead to problems with the environment and conflict with other persons. Responsible behavior in handling the motorcycle can help to avoid such problems and conflicts. To protect the future of motorcycle sport, make sure that you use your motorcycle legally, display environmental consciousness, and respect the rights of others.

Notes/warnings

Pay close attention to the notes/warnings.



Info

Various information and warning labels are affixed to the vehicle. Do not remove information/warning labels. If they are missing, you or others may not recognize potential hazards and may therefore be injured.

Grades of risks



Danger

Identifies a danger that will immediately and invariably lead to fatal or serious permanent injury if the appropriate measures are not taken.



Warning

Identifies a danger that is likely to lead to fatal or serious injury if the appropriate measures are not taken.



Caution

Identifies a danger that may lead to minor injuries if the appropriate measures are not taken.

Note

Identifies a danger that will lead to considerable machine and material damage if the appropriate measures are not taken.



Warning

Identifies a danger that will lead to environmental damage if the appropriate measures are not taken.

Owner's manual

- Be sure to read this owner's manual carefully and completely before taking your first ride. It contains useful information and tips to help you operate and handle your motorcycle. Only then will you find out how to best customize the motorcycle for your own use and how you can protect yourself from injury. The owner's manual also contains important information on servicing the motorcycle.
- The owner's manual is an important component of the motorcycle and should be handed over to the new owner if the vehicle is sold.

View of vehicle, front left side (vehicle differs slightly from photo)



1	Combination instrument (☛ p. 24)
2	Rear mirror
3	Clutch lever (☛ p. 19)
4	Seat
5	Handrails (☛ p. 37)
6	Level viewer, engine oil
7	Shift lever (☛ p. 38)
8	Engine number (☛ p. 17)
9	Compression damping of the shock absorber (☛ p. 63)

View of vehicle, rear right side (vehicle differs slightly from photo)



1	Seat lock (☛ p. 36)
2	Light switch (☛ p. 20)
2	Headlight flasher switch (☛ p. 21)
2	Turn signal switch (☛ p. 21)
2	Horn button (☛ p. 22)
3	Filler cap
4	Emergency OFF switch (☛ p. 22)
4	Electric starter button (☛ p. 23)
5	Hand brake lever (☛ p. 19)
6	Fork rebound setting and spring preload setting
7	Shock absorber rebound adjustment
8	Passenger footrests (☛ p. 38)
9	Foot brake lever (☛ p. 39)
10	Chassis number/type label (☛ p. 16)
11	Fork compression adjustment

Chassis number/type label

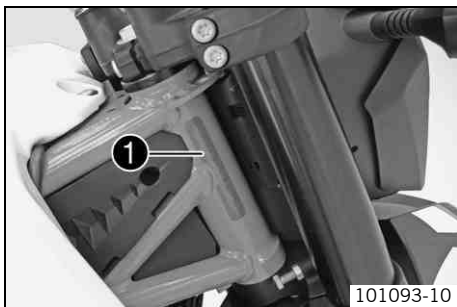

Chassis number ❶ is embossed in the steering head at the right.

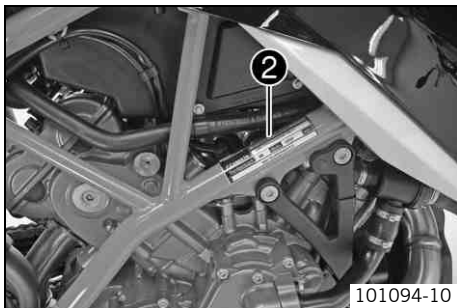

Type label ❷ is applied to the right frame tube.

Engine number

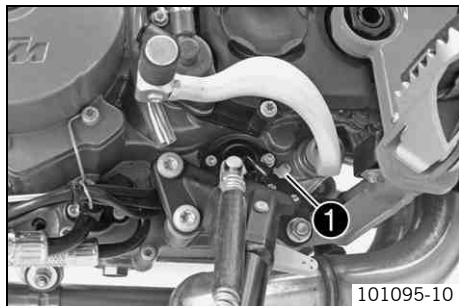

The engine number ❶ is stamped on the left side of the engine under the engine sprocket.

Key number

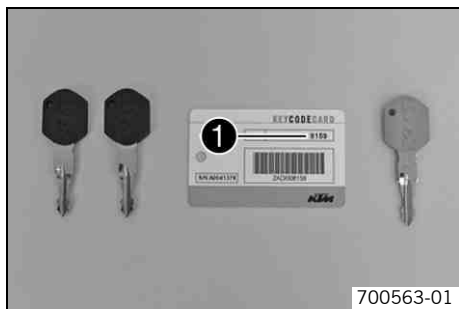

The **Code number** ❶ key number can be found on the **KEYCODECARD**.



Info

You need the key number to order a spare key. Keep the **KEYCODECARD** in a safe place.

Use the orange programming key to activate and deactivate the black ignition key. Keep the orange programming key in a safe place: it must only be used for learning and programming functions.

Fork part number

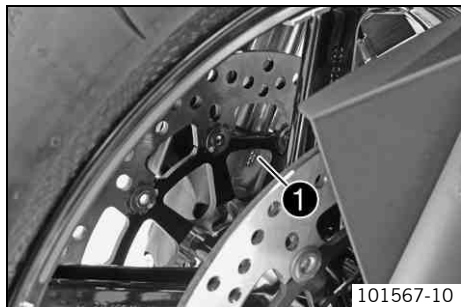

101567-10

The fork part number ❶ is stamped on the inner side of the fork stub.

Shock absorber part number

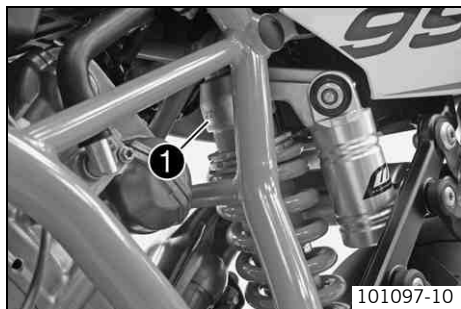

101097-10

The shock absorber part number ❶ is stamped on the top of the shock absorber above the adjusting ring on the engine side.

Clutch lever

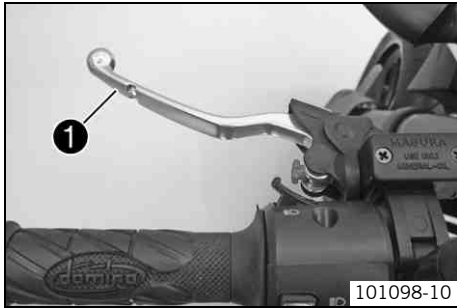

The clutch lever ❶ is fitted on the left side of the handlebar.
The clutch is hydraulically operated and self-adjusting.

Hand brake lever

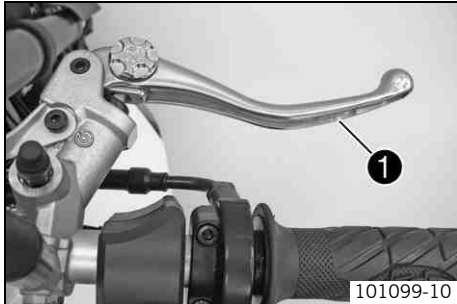

The hand brake lever ❶ is fitted on the right side of the handlebar.
The front brake is engaged using the hand brake lever.

Throttle grip





The throttle grip ❶ is fitted on the right side of the handlebar.

Light switch



The light switch ❶ is fitted on the left side of the handlebar.

Possible states

	Low beam on – The light switch is turned downwards. In this position, the low beam and tail light are switched on.
	High beam on – The light switch is turned upwards. In this position, the high beam and tail light are switched on.

Headlight flasher switch

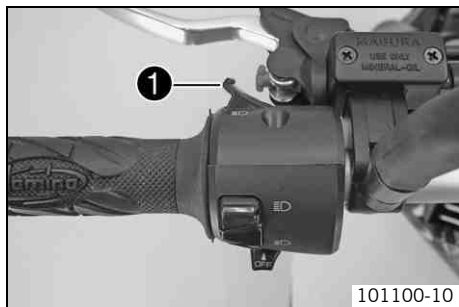

101100-10

The headlight flasher switch ❶ is fitted on the left side of the handlebar.

Possible states

- Headlight flasher switch in basic position
- Headlight flasher switch pressed – The headlight flasher switch (high beam) is operated in this position.



Turn signal switch



700550-11

The turn signal switch ❶ is fitted on the left side of the handlebar.

Possible states

	Turn signal off
	Left turn signal on – The turn signal switch is pressed to the left. The turn signal switch automatically returns to the central position after use.
	Right turn signal on – The turn signal switch is pressed to the right. The turn signal switch automatically returns to the central position after use.

To switch off the turn signal, press the turn signal switch towards the switch case.

Horn button

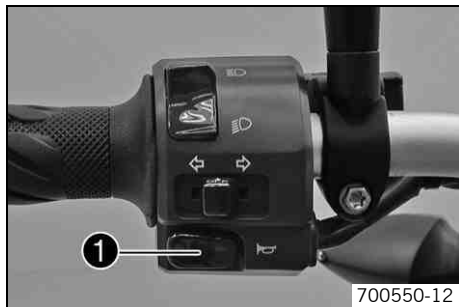

The horn button ❶ is fitted on the left side of the handlebar.

Possible states

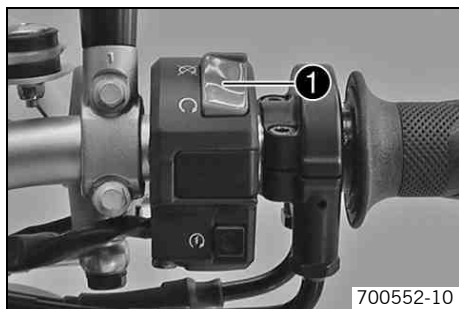

- Horn button ❶ in basic position
- Horn button ❶ pressed – The horn is operated in this position.

Emergency OFF switch



The emergency OFF switch ❶ is fitted on the right side of the handlebar.

Possible states

	Emergency OFF switch on – This position is necessary for operation as it closes the ignition circuit.
	Emergency OFF switch off – In this position, the ignition circuit is interrupted, a running engine stops, and the engine cannot be started.

Electric starter button

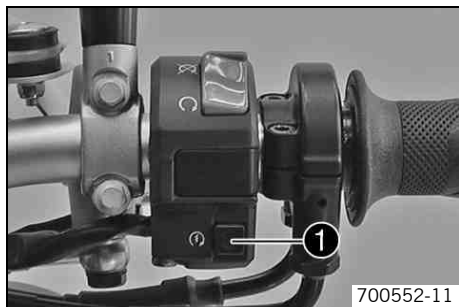

The electric starter button ❶ is fitted on the right side of the handlebar.

Possible states

- Electric starter button ❸ in basic position
- Electric starter button ❸ pressed – The electric starter is actuated in this position.

Ignition/steering lock

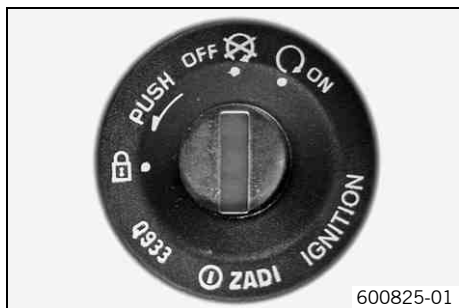

The ignition/steering lock is in front of the upper triple clamp.

Info

The ignition may only be switched on using a black ignition key. Use the orange programming key to activate and deactivate the black ignition key.

Possible states

	<p>Ignition OFF – In this position, the ignition circuit is interrupted, a running engine stops, and a non-running engine will not start. The ignition key can be removed.</p>
	<p>Ignition ON – In this position, the ignition circuit is closed and the engine can be started.</p>
	<p>Steering locked – In this position, the ignition circuit is interrupted and the steering locked. The ignition key can be removed.</p>

Immobilizer

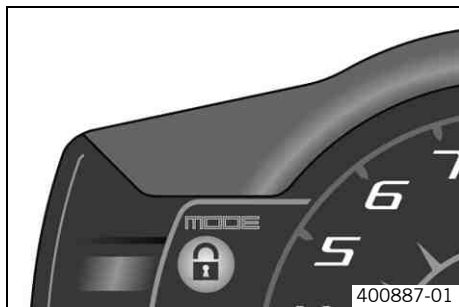

The electronic immobilizer secures the vehicle against unauthorized use. The immobilizer is activated automatically and the engine electronics are locked when the ignition key is withdrawn.

The red warning lamp  flashes at 15 second intervals after one minute.

The red warning lamp can also indicate errors by flashing.



Info

The ignition key contains electronic components. Never attach multiple ignition keys to a single key ring; this may cause mutual interference and lead to problems.

A lost black ignition key must be deactivated to prevent unauthorized persons from operating the vehicle.

The second black ignition key is activated when the vehicle is shipped.

Two additional spare ignition keys (key number on the **KEYCODECARD**) can be ordered from an authorized KTM workshop, but they must be activated before use.

Combination instrument

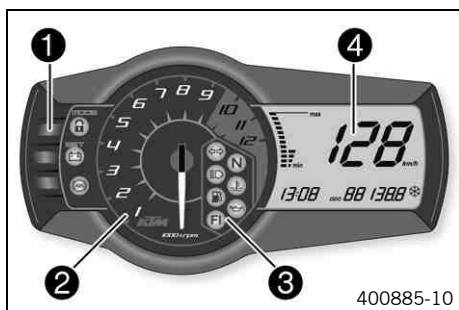

The combination instrument is installed in front of the handlebar.

The combination instrument is divided into 4 function areas.

- 1** Function buttons
- 2** Tachometer
- 3** Indicator lights
- 4** Display

Combination instrument - function buttons

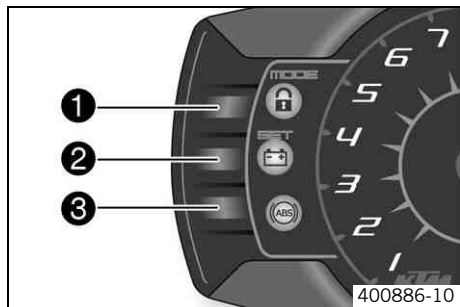

You can change the display mode with the **MODE** button ❶.

Possible display modes are the distance traveled (**ODO**), trip master 1 (**TRIP 1**), trip master 2 (**TRIP 2**) and the ambient temperature.

Press the **SET** button ❷ to reset the trip master 1 function (**TRIP 1**) and trip master 2 function (**TRIP 2**) to **0.0**.

Button ❸ has no function.

Combination instrument - tachometer

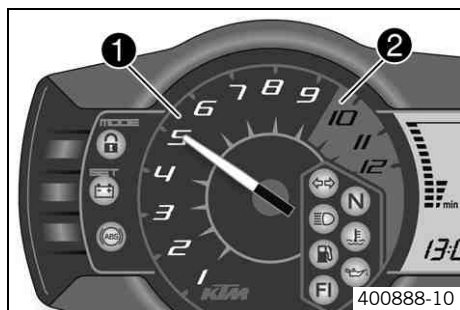

The tachometer ❶ shows the engine speed in revolutions per minute.





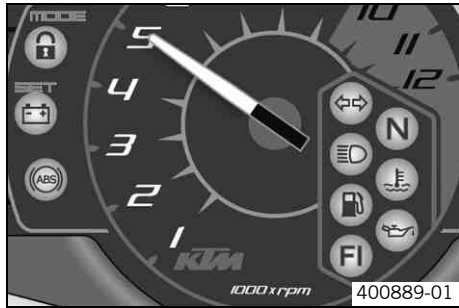





The red marking ❷ shows the excess speed range of the engine.

Combination instrument - indicator lamps



The indicator lamps offer additional information about the operating state of the motorcycle.

Possible states

	The turn signal indicator light flashes green simultaneously with the turn signal – The turn signal is switched on.
	The idling speed indicator lamp lights up green – The transmission is shifted to idle.
	The high beam indicator light lights up blue – The high beam is switched on.
	The temperature warning lamp lights up red – The coolant temperature has reached a critical value.
	The low fuel warning lamp lights up orange – The fuel level has reached the reserve mark. The display switches to TRIP F .
	The oil pressure warning lamp lights up red – The oil pressure is too low.
	FI warning lamp (MIL) lights up/flashes orange – The OBD (on-board diagnosis) has detected an emission- or safety-critical error.
	The immobilizer indicator lamp lights up or flashes red – Status or error message for immobilizer/alarm system.
	The battery warning lamp lights up red – The voltage in the vehicle system is too low.
	The ABS warning lamp lights up/flashes red – Status or error messages relating to ABS (antilock brake system).

Combination instrument - display



When you switch on the ignition, all display segments light up for one second as a function test.

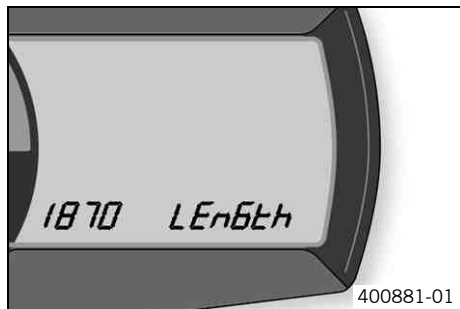

LEnGth

Following the display function test, the **LEnGth** wheel circumference is shown for one second.



Info

1870 mm corresponds to the circumference of the 17" front wheel with a series production tire.

The display then changes to the last selected mode.

Combination instrument - speedometer

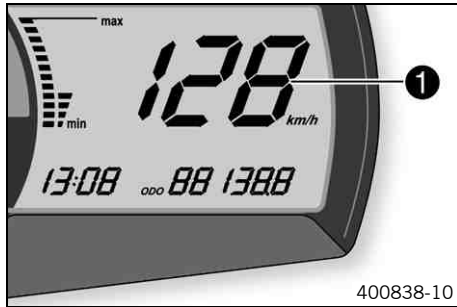

The speed ❶ is shown in kilometers per hour **km/h** or in miles per hour **mph**.

Setting kilometers or miles

i Info

If you change the unit, the value **ODO** is retained and converted accordingly.
Making the setting according to the country.

Condition

The motorcycle is stationary.



- Switch on the ignition by turning the ignition key to the **ON**  position.
- Press the **MODE** button repeatedly until the **ODO** mode is active.
- Keep the **MODE** button pressed until the display mode changes from **km/h** to **mph** or from **mph** to **km/h**.

Combination instrument - time



The time is shown in area **1** of the display.



Info

After reconnecting the battery or changing the fuse, the time must be reset.

Setting the clock

Condition

The motorcycle is stationary.

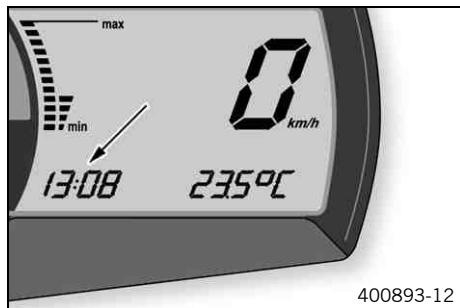

- Switch on the ignition by turning the ignition key to the **ON**  position.
- Press the **MODE** button repeatedly until the **ODO** mode is active.
- Keep the **MODE** button and the **SET** button pressed simultaneously.
 - ✓ The time display begins to flash.
- Press the **MODE** button to set the hour.
- Press the **SET** button to set the minute.
- Keep the **MODE** button and the **SET** button pressed simultaneously.
 - ✓ The time is set.

Combination instrument - ODO display

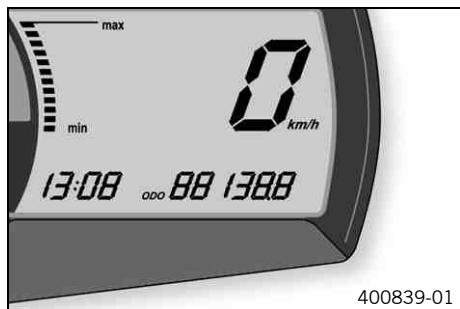

In the **ODO** display mode, the total distance traveled is shown in kilometers or miles.



Info

This value is retained, even if the battery is disconnected and/or the fuse blows.

Combination instrument - setting/resetting TRIP 1



Info

The **TRIP 1** trip counter is always running and counts up to **999.9**.

The trip counter can be used to measure the distance covered during trips or between two refueling stops. After the value **999.9** is reached, the trip counter starts at **0.0** again.



- Switch on the ignition by turning the ignition key to the **ON**  position.
- Press the **MODE** button repeatedly until the **TRIP 1** mode is active.
- Keep the **SET** button pressed.
- ✓ The **TRIP 1** display is set to **0.0**.

Combination instrument - setting/resetting TRIP 2



Info

The **TRIP 2** trip counter is always running and counts up to **999.9**.

The trip counter can be used to measure the distance covered during trips or between two refueling stops. After the value **999.9** is reached, the trip counter starts at **0.0** again.

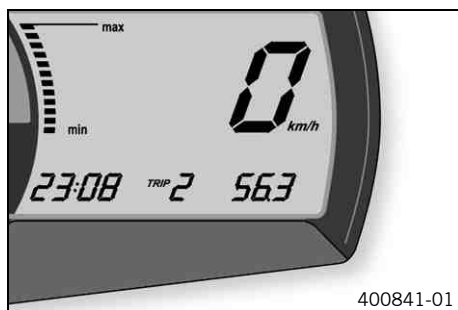

- Switch on the ignition by turning the ignition key to the **ON**  position.
- Press the **MODE** button repeatedly until the **TRIP 2** mode is active.
- Keep the **SET** button pressed.
- ✓ The **TRIP 2** display is set to **0.0**.

Combination instrument - TRIP F display

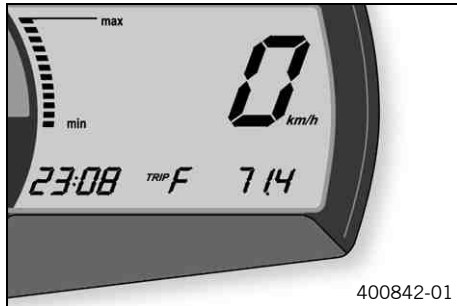

If the fuel level drops to the reserve mark, the display automatically changes to **TRIP F** and starts to count from **0.0**, regardless of the previous display mode.



Info

The low fuel warning lamp lights up in parallel to the **TRIP F** display.

Combination instrument - ambient temperature display

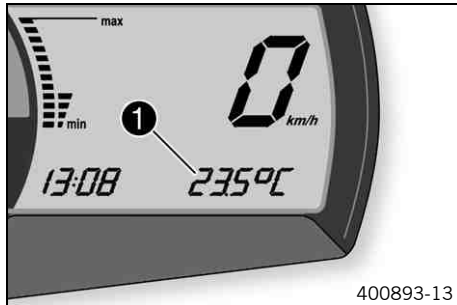

The ambient temperature ❶ is displayed in °C or °F.

Setting the temperature units

Condition

The motorcycle is stationary.

- Switch on the ignition by turning the ignition key to the **ON** \odot position.
- Press the **MODE** button repeatedly until the ambient temperature is active.
- Keep the **MODE** button pressed until the display mode changes from $^{\circ}\text{C}$ to $^{\circ}\text{F}$ or from $^{\circ}\text{F}$ to $^{\circ}\text{C}$.

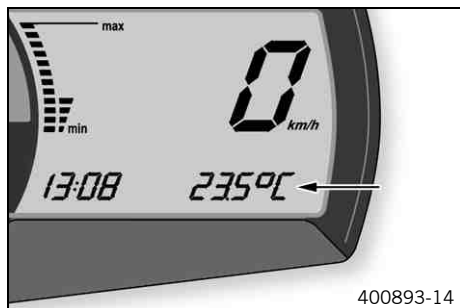

Combination instrument - warning of slippery roads

The ice symbol ❄ lights up to indicate an increased danger of slippery roads.

The ice symbol ❄ appears in the display when the ambient temperature drops below the specified value.

Temperature	3 $^{\circ}\text{C}$ (37 $^{\circ}\text{F}$)
-------------	---

The ice symbol ❄ goes out in the display when the ambient temperature rises above the specified value again.

Temperature	4 $^{\circ}\text{C}$ (39 $^{\circ}\text{F}$)
-------------	---

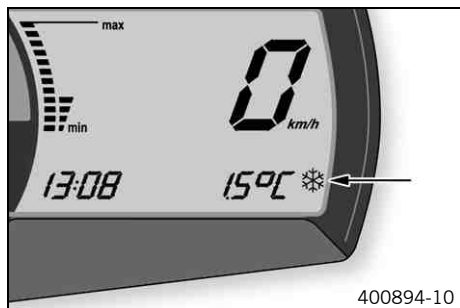

Combination instrument - coolant temperature indicator

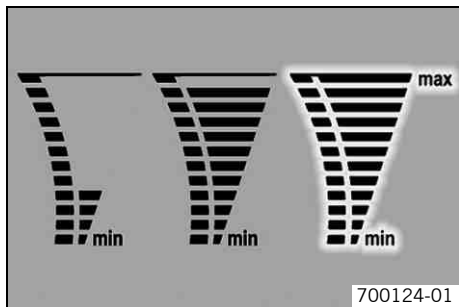

The temperature display consists of 12 bars. The more bars that light up, the hotter the coolant. When the upper bar lights up, all bars in the display begin to flash and the temperature warning lamp lights up.

Possible states

- Engine cold – Up to five bars light up.
- The engine is warm – Six to eleven bars light up.
- Engine hot – All twelve bars flash.

Opening the filler cap



Danger

Fire hazard Fuel is highly flammable.

- Never refuel the vehicle near open flames or burning cigarettes, and always switch off the engine first. Be careful that no fuel is spilt, especially on hot vehicle components. Clean up spilt fuel immediately.
- Fuel in the fuel tank expands when warm and can escape if the tank is overfilled. See the notes on refueling.



Warning

Danger of poisoning Fuel is poisonous and a health hazard.

- Avoid contact between fuel and skin, eyes and clothing. Do not inhale fuel vapors. If fuel gets into your eyes, rinse immediately with water and contact a doctor. Wash affected skin areas immediately with soap and water. If fuel is swallowed, contact a doctor immediately. Change clothing that has come into contact with fuel. Store fuel in a suitable canister according to regulations and keep it out of the reach of children.



Warning

Environmental hazard Improper handling of fuel is a danger to the environment.

- Do not allow fuel to get into the ground water, the ground, or the sewage system.

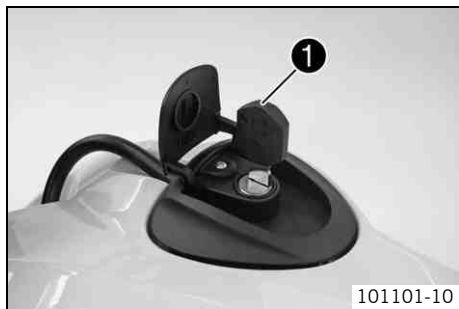

- Lift the cover of the filler cap ❶ and insert the ignition key.

Note

Danger of damage Ignition key breakage.

- To take pressure off of the ignition key, push down on the filler cap. Damaged ignition keys must be replaced.
- Turn the ignition key 90° counterclockwise and remove the filler cap.



Info

The filler cap has a tank air vent system.

Closing the filler cap



- Put the filler cap back on and turn the ignition key 90° clockwise.
- Remove the ignition key and fold down the cover.

Seat lock

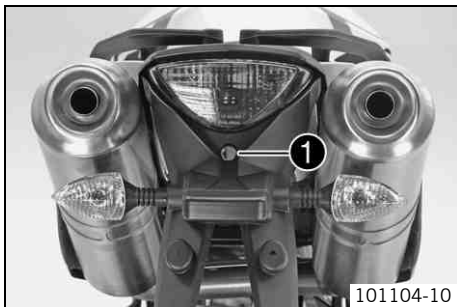

Seat lock ❶ is located at the rear under the tail light.
It can be locked with the ignition key.

Tool set



The tool set ❶ is located in the storage compartment under the seat.

Handrails

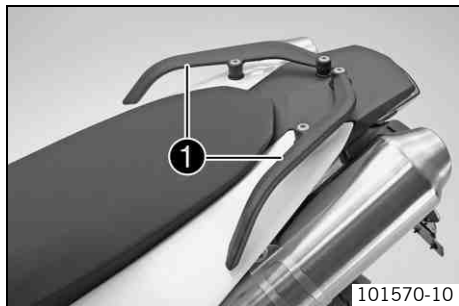

The handrails ❶ are used for moving the motorcycle around.
If you carry a passenger, the passenger can hold onto the handrails during the trip.

Helmet lock

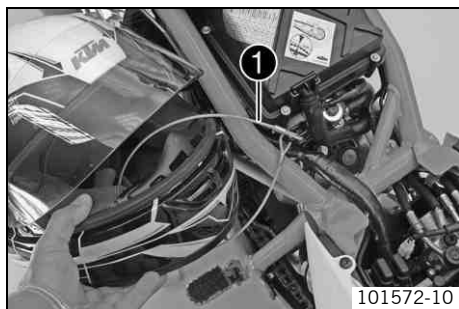

Warning

Danger of accidents Impairment of ride behavior and vehicle operation if a helmet or helmet lock is attached to the vehicle.

- Do not use the helmet lock for holding a helmet or other objects during the journey. Always remove the helmet lock before starting out.

The steel cable ❶ in the tool set can be used to lock a helmet to the vehicle to prevent it from being stolen.

Passenger footrests

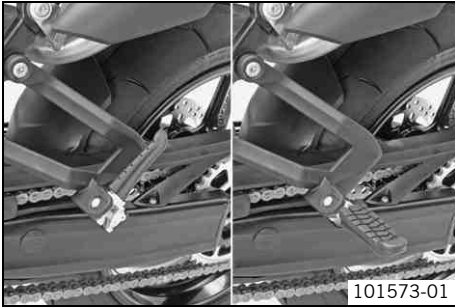

The passenger footrests can be folded up and down.

Possible states

- Passenger footrests folded up – For operation without a passenger.
- Passenger footrests folded down – For operation with a passenger.

Shift lever

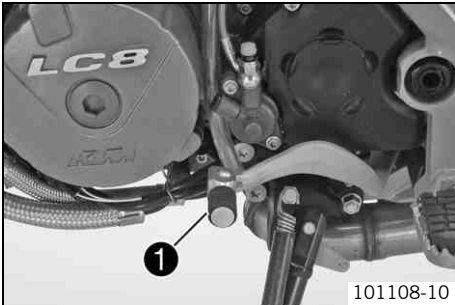

Shift lever ❶ is mounted on the left side of the engine.

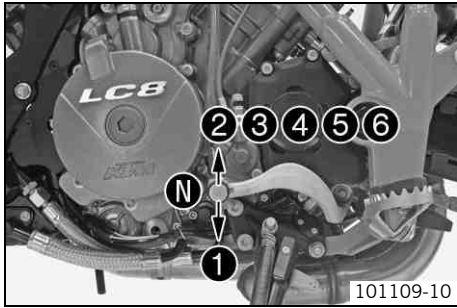

The gear positions can be seen in the photograph.
The neutral or idle position **N** is between the first and second gear.

Foot brake lever

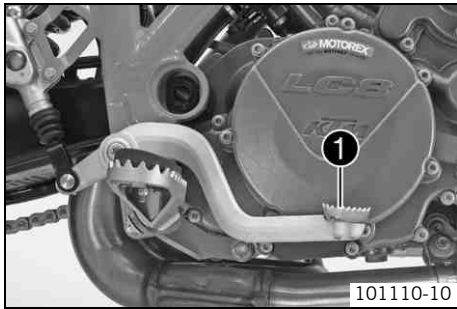

Foot brake lever **1** is located in front of the right footrest.
The rear brake is activated using the foot brake lever.

Side stand

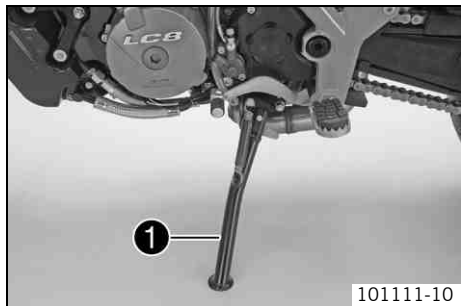

The side stand ❶ is located on the left side of the vehicle.
The side stand is used to park the motorcycle.



Info

The side stand must be folded up during motorcycle use.
Side stand is coupled with the safety start system; see the riding instructions.

Possible states

- Side stand folded out – The vehicle can be leaned on the side stand. The safety start system is active.
- Side stand folded in – This position is mandatory for all trips. The safety start system is inactive.

Information on first use



Danger

Danger of accidents Danger arising from the rider's judgement being impaired.

- Do not operate the vehicle while under the influence of alcohol, drugs and certain medications or physically or mentally impaired.



Warning

Risk of injury Missing or poor protective clothing present an increased safety risk.

- Wear protective clothing (helmet, boots, gloves, pants and jacket with protectors) every time you ride the vehicle. Always wear protective clothing, which must be undamaged and meet legal requirements.



Warning

Danger of crashing Poor vehicle handling due to different tire tread patterns on front and rear wheels.

- The front and rear wheels must be fitted with tires with similar tread patterns to prevent loss of control over the vehicle.



Warning

Danger of accidents Uncontrollable handling characteristic due to non-approved and/or non-recommended tires/wheels.

- Only tires/wheels approved by KTM and with the corresponding speed index should be used.



Warning

Danger of accidents Reduced road grip with new tires.

- New tires have a smooth rolling surface and therefore cannot provide full road grip. The entire rolling surface must be roughened in the first 200 kilometers (124.3 miles) by moderate riding at alternating angles. The full grip levels are not achieved until the tires have been run in.



Info

When using your vehicle, remember that others may feel disturbed by excessive noise.

- Make sure that the pre-delivery inspection work has been carried out by an authorized KTM workshop.
 - ✓ You receive a delivery certificate and the service record at vehicle handover.
- Before your first trip, read the entire operating instructions carefully.
- Get to know the controls.
- Adjust the basic position of the clutch lever. (☛ p. 82)
- Adjust the basic position of hand brake lever. (☛ p. 85)
- Adjust the basic position of foot brake lever. (☛ p. 90)
- Get used to handling the vehicle on empty suitable terrain before making a longer trip. Try also to ride as slowly as possible to get a better feeling for the motorcycle.
- Hold the handlebar firmly with both hands and keep your feet on the footrests when riding.
- Run the engine in. (☛ p. 42)

Running in the engine

- Do not exceed the specified engine speed and load during the running-in period.

Guideline

Maximum engine speed	
During the first: 1,000 km (621.4 mi)	6,500 rpm
After the first: 1,000 km (621.4 mi)	9,500 rpm

- Avoid full-throttle operation!

Loading the vehicle





Warning

Danger of accidents Unstable handling characteristics.

- Do not exceed the maximum permitted weight and axle loads. The overall weight consists of: motorcycle operational and with a full tank, driver and passenger with protective clothing and helmet, baggage.

-  **Warning**
Danger of accidents Unstable handling characteristics due to incorrect mounting of suitcase and/or tank rucksack.
- Mount and secure suitcase and tank rucksack according to the manufacturer's instructions.

-  **Warning**
Danger of accidents Unstable handling characteristics at high speed.
- Adapt your speed according to your payload. If the motorcycle is loaded with luggage, ride more slowly.
Maximum speed with luggage 130 km/h (80.8 mph)

-  **Warning**
Danger of accidents Destruction of luggage carrier system.
- If the motorcycle is fitted with luggage cases, note the manufacturer's specifications concerning the maximum payload.

-  **Warning**
Danger of accidents Poor visibility for other road users due to slipped baggage.
- If the tail light is covered, you are less visible to traffic behind you, especially in the dark. Check that your baggage is fixed properly at regular intervals.

-  **Warning**
Danger of accidents Changed handling characteristics and longer stopping distance with excessive payload.
- Adapt your speed according to your payload.

-  **Warning**
Danger of accidents Unstable handling characteristics due to slipped baggage.
- Check the way your baggage is fixed regularly.

-  **Warning**
Danger of burns A hot exhaust system can burn baggage.
- Fasten your baggage in such a way that it cannot be burned or singed by the hot exhaust system.
-

- If you are carrying baggage, make sure it is fixed firmly as close as possible to the center of the vehicle and ensure even weight distribution between the front and rear wheels.
- Do not exceed the maximum permissible total weight and the axle loads.

Guideline

Maximum permissible total weight	400 kg (882 lb.)
Maximum permissible front axle load	160 kg (353 lb.)
Maximum permissible rear axle load	250 kg (551 lb.)

Checks and maintenance measures when preparing for use

i **Info**
Before every trip, check the condition of the vehicle and ensure that it is roadworthy.
The vehicle must be in perfect technical condition when it is being operated.

- Check the engine oil level. (☛ p. 153)
- Check the front brake fluid level. (☛ p. 86)
- Check the rear brake fluid level. (☛ p. 91)
- Check the front brake linings. (☛ p. 88)
- Check the rear brake linings. (☛ p. 94)
- Check that the brake system is functioning properly.
- Check the coolant level in the compensating tank. (☛ p. 143)
- Check the chain for dirt. (☛ p. 75)
- Check the chain tension. (☛ p. 76)
- Check the tire condition. (☛ p. 105)
- Check the tire air pressure. (☛ p. 106)
- Check that all controls are correctly adjusted and free to move.
- Check that the electrical equipment is functioning properly.
- Check that baggage is correctly secured.
- Sit on the motorcycle and check the rear mirror setting.
- Check the fuel level.

Starting



Danger

Danger of poisoning Exhaust gases are poisonous and inhaling them may result in unconsciousness and/or death.

- When running the engine, always make sure there is sufficient ventilation, and do not start or run the engine in an enclosed space without an effective exhaust extraction system.



Caution

Danger of accidents If the vehicle is operated with a discharged battery or without a battery, electronic components and safety equipment may be damaged.

- Never operate the vehicle with a discharged battery or without a battery.

Note

Engine failure High engine speeds in cold engines have a negative effect on the service life of the engine.

- Always warm up the engine at low engine speeds.



B00650-10

- Press the emergency OFF switch into the position
- Switch on the ignition by turning the ignition key to the **ON**
- ✓ After you switch on the ignition, you can hear the fuel pump working for about two seconds. The function test of the combination instrument is run at the same time.
- Shift the transmission to neutral.
- ✓ The green idling speed indicator lamp **N**
- Press the electric starter button

i Info

Do not press the electric starter button until the function test of the combination instrument is finished.

When starting, **DO NOT** open the throttle. If you open the throttle during the starting procedure, fuel is not injected by the engine management system and the engine cannot start.

Press the starter for a maximum of 5 seconds. Wait for a least 5 seconds before trying again.

This motorcycle is equipped with a safety start system. You can only start the engine if the transmission is in neutral or if the clutch is pulled when a gear is engaged. If the side stand is folded out and you shift into gear and release the clutch, the engine stops.

- Take the weight off the side stand and swing it upwards with your foot as far as it will go.

Switching off ABS

KTM recommends riding with ABS at all times. However, situations may arise in which ABS is not advantageous.

Condition

Vehicle stationary, engine running.

- Press button ② for 3 - 5 seconds.
 - ✓ The ABS warning lamp starts flashing; ABS is deactivated.

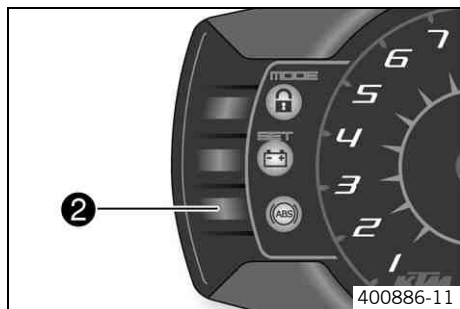

Starting off

- Pull the clutch lever, engage 1st gear, release the clutch lever slowly and simultaneously open the throttle carefully.

Shifting, riding



Warning

Danger of accidents Abrupt load alterations can cause the vehicle to get out of control.

- Avoid abrupt load alterations and sudden braking actions, and adapt your speed to the road conditions.



Warning

Danger of accidents If you change down at high engine speed, the rear wheel can lock up.

- Do not change into a low gear at high engine speed. The engine races and the rear wheel can lock up.



Warning

Danger of accidents Malfunctions caused by incorrect ignition key position.

- Do not change the ignition key position during a journey.



Warning

Danger of accidents Distraction from traffic activity by adjustments to the vehicle.

- Make all adjustments when the vehicle is at a standstill.



Warning

Risk of injury The passenger must be able to sit securely on the passenger seat.

- The passenger must hold on to the rider or supporting strap firmly and place his/her feet on the passenger footrests. Observe the regulations concerning the minimum age for passengers in your country.



Warning

Danger of accidents Danger of accidents caused by dangerous driving.

- Comply with traffic regulations and ride defensively and foresightedly to detect sources of danger early on.



Warning

Danger of accidents Reduced road grip with cold tires.

- On every journey, take the first miles carefully at moderate speed until the tires reach operating temperature and optimal road grip is ensured.



Warning

Danger of accidents Reduced road grip with new tires.

- New tires have a smooth rolling surface and therefore cannot provide full road grip. The entire rolling surface must be roughened in the first 200 kilometers (124.3 miles) by moderate riding at alternating angles. The full grip levels are not achieved until the tires have been run in.



Warning

Danger of accidents Unstable handling characteristics.

- Do not exceed the maximum permitted weight and axle loads. The overall weight consists of: motorcycle operational and with a full tank, driver and passenger with protective clothing and helmet, baggage.



Warning

Danger of accidents Unstable handling characteristics due to slipped baggage.

- Check the way your baggage is fixed regularly.



Warning

Danger of accidents Lack of roadworthiness.

- After a fall, check the vehicle as usual before preparing for use.

Note

Engine failure Unfiltered intake air has a negative effect on the service life of the engine.

- Never ride the vehicle without an air filter since dust and dirt can get into the engine and result in increased wear.

Note

Engine damage Engine overheating.

- If the coolant temperature warning lamp lights up, stop the vehicle and switch off the engine. Let the engine cool down, and then check the coolant level in the radiator and top up if necessary. If you continue your journey with the coolant temperature warning lamp on, this may cause engine failure.



Info

If you hear unusual noises while riding, stop immediately, switch off the engine and contact an authorized KTM workshop.

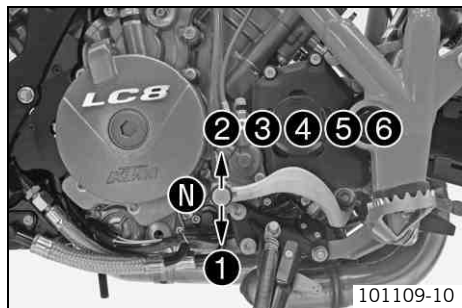

- When conditions allow (incline, road situation, etc.), you can shift into a higher gear.
- Release the throttle while simultaneously pulling the clutch lever, shift into the next gear, release the clutch and open the throttle.



Info

You can see the positions of the six forward gears in the figure. The neutral or idle position is between the first and second gears. First gear is used for starting off or for steep inclines.

- After reaching maximum speed by fully opening the throttle grip, turn the throttle back so it is $\frac{3}{4}$ open. This will barely reduce the speed but fuel consumption will be considerably lower.
- Accelerate only up to a speed suitable for the road surface and weather conditions. When traveling in bends, do not shift, and accelerate very carefully.
- To shift down, brake if necessary and close the throttle at the same time.
- Pull the clutch lever and shift into a lower gear, release the clutch lever slowly and open the throttle or shift again.
- If the engine stalls (e.g. at a crossroads), pull the clutch lever only and press the electric starter button. You do not have to shift into neutral.

- Switch off the engine if you expect to be standing for a long time.
- If the **FI** warning lamp (**MIL**) lights up during a trip, stop immediately. When you shift to neutral, the **FI** warning lamp (**MIL**) starts to flash.

Info

From the flashing rhythm, you can derive a two-digit number, the so-called flashing code. The flashing code tells you which component has a fault.

-
- If the ice symbol ❄ appears in the combination instrument, the roads may be icy. Adapt your speed to the changed road conditions.

Braking



Warning

Danger of accidents Reduced braking efficiency due to wet or dirty brakes.

- Clean or dry dirty or wet brakes by riding and braking gently.



Warning

Danger of accidents Reduced braking efficiency caused by spongy pressure point of front or rear brake.

- Check the brake system and do not continue riding. (Your authorized KTM workshop will be glad to help.)



Warning

Danger of accidents Failure of brake system.

- If the foot brake lever is not released, the brake linings drag continuously. The rear brake may fail due to overheating. Take your foot off the foot brake lever when you are not braking.



Warning

Danger of accidents Longer stopping distance due to higher overall weight.

- Take the longer stopping distance into account when carrying a passenger and baggage.



Warning

Danger of accidents Delayed brake action on salted roads.

- There may be salt deposits on the brake discs. In order to restore the normal braking efficiency, you will need to remove the deposits from the discs by carefully applying the brakes.



Warning

Danger of accidents Greater stopping distance due to ABS.

- Braking should be appropriate to the driving situation and the road conditions.



Warning

Danger of accidents Excessively hard braking causes the wheels to lock.

- ABS must be switched on to be effective.



Warning

Danger of accidents Locking of the wheels due to braking action of the engine.

- Pull the clutch during emergency braking, full brake application and when braking on a slippery surface.

-
- When braking, first throttle back and then apply the front and rear brakes at the same time.



Info

When ABS is active, you can achieve maximum braking power even on low grip surfaces such as sandy, wet, or slippery terrain without locking of the tires.



Warning

Danger of accidents Road grip is reduced when braking with the motorcycle at an angle or on a laterally inclined surface.

- Braking should be completed before you enter into a bend.

-
- Braking should always be completed before you enter a bend. Shift down to a lower gear that is appropriate to your speed.

- On long downhill stretches, use the braking effect of the engine. Do this by changing down two gears, but do not race the engine. You will require less braking force and the brakes will not overheat.

Stopping, parking



Warning

Risk of misappropriation Usage by unauthorized persons.

- Never leave the vehicle while the engine is running. Secure the vehicle against use by unauthorized persons. If you leave the vehicle, lock the steering and remove the ignition key.



Warning

Danger of burns Some vehicle components become very hot when the vehicle is operated.

- Do not touch hot components such as exhaust system, radiator, engine, shock absorber and brakes. Allow these components to cool down before starting work on them.

Note

Danger of damage The parked vehicle may roll away or fall over.

- Always place the vehicle on a firm and even surface.

Note

Fire hazard Some vehicle components become very hot when the vehicle is operated.

- Do not park the vehicle near flammable or explosive substances. Do not place objects on the vehicle while it is still warm from being run. Always let the vehicle cool first.

Note

Material damage Damage and destruction of components by excessive load.

- The side stand is designed for the weight of the motorcycle only. Do not sit on the motorcycle when it is supported by the side stand only. The side stand and/or the frame could be damaged and the motorcycle could fall over.

- Apply the brakes.
- Shift the transmission to neutral.
- Switch off the ignition by turning the ignition key to the **OFF** ☒ position.



Info

If you switch off the engine with the emergency OFF switch but the ignition remains switched on at the ignition lock, power continues to flow to most power consumers and the battery is soon discharged. Therefore, always switch off the engine with the ignition key; the emergency OFF switch is provided for emergency situations only.

- Park the motorcycle on a firm surface.
- Swing the side stand to the front with your foot as far as it will go, and lean the vehicle onto it.
- Lock the steering by turning the handlebar fully to the left, pressing down the ignition key to the **OFF** position ☒ and turning it to the position ☒. To make the steering lock engage more easily, move the handlebar back and forth slightly. Remove the ignition key.

Refueling



Danger

Fire hazard Fuel is highly flammable.

- Never refuel the vehicle near open flames or burning cigarettes, and always switch off the engine first. Be careful that no fuel is spilt, especially on hot vehicle components. Clean up spilt fuel immediately.
- Fuel in the fuel tank expands when warm and can escape if the tank is overfilled. See the notes on refueling.



Warning

Danger of poisoning Fuel is poisonous and a health hazard.

- Avoid contact of the fuel with skin, eyes and clothing. Do not inhale fuel vapors. If fuel gets into your eyes, rinse immediately with water and contact a doctor. Wash affected skin areas immediately with soap and water. If fuel is swallowed, contact a doctor immediately. Change clothing that has come into contact with fuel.

Note

Material damage Premature clogging of the fuel filter.

- In some countries and regions, the available fuel quality and cleanliness may not be sufficient. This will result in problems with the fuel system. (Your authorized KTM workshop will be glad to help.)
- Only refuel with clean fuel that meets the specified standards.



Warning

Environmental hazard Improper handling of fuel is a danger to the environment.

- Do not allow fuel to get into the ground water, the ground, or the sewage system.

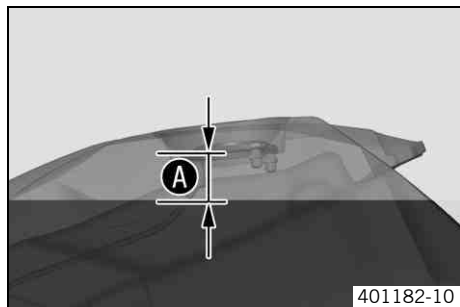

401182-10

- Switch off the engine.
- Open the filler cap. (☛ p. 34)
- Fill the fuel tank with fuel no higher than level **A**.

Guideline

Distance A	35 mm (1.38 in)	
Total fuel tank capacity, approx.	15 l (4 US gal)	Super unleaded (ROZ 95/RON 95/PON 91) (☛ p. 194)

- Close the filler cap. (☛ p. 35)
- Press the **SET** button **2** for two seconds.
- ✓ The low fuel warning lamp **1** goes out. **TRIP F** is set to **0.0** and the display returns to the previous display mode.



Info

If the **SET** button **2** is not pressed, the value is automatically reset after approx. 3 minutes.



400885-12

Service schedule

	K10N	K75A	K150A	K300A
Check that the electrical equipment is functioning properly.	•	•	•	•
Read out the trouble code memory using the KTM diagnostics tool. 🛠️	•	•	•	•
Check the measured service values with the KTM diagnostics tool. 🛠️		•	•	•
Change the engine oil and filter, clean the oil screens. 🛠️ (📖 p. 154)	•	•	•	•
Check the oil jet for the clutch lubrication. 🛠️	•		•	•
Check the front brake linings. (📖 p. 88)	•	•	•	•
Check the front brake discs. (📖 p. 85)	•	•	•	•
Check the rear brake linings. (📖 p. 94)	•	•	•	•
Check the rear brake disc. (📖 p. 91)	•	•	•	•
Check that brake lines are undamaged and free of leaks.	•	•	•	•
Check the rear brake fluid level. (📖 p. 91)	•	•	•	•
Check the free travel of the foot brake lever. (📖 p. 89)	•	•	•	•
Check the shock absorber and fork for leaks. Perform a fork and shock absorber service if needed and depending on vehicle use.	•	•	•	•
Check the swingarm bearings. 🛠️		•	•	•
Check the wheel bearing for play. 🛠️		•	•	•
Check the tire condition. (📖 p. 105)	•	•	•	•
Check the tire air pressure. (📖 p. 106)	•	•	•	•
Check the chain, rear sprocket, engine sprocket, and chain guide. (📖 p. 79)		•	•	•
Check the chain tension. (📖 p. 76)	•	•	•	•
Lubricate all moving parts (e.g. side stand, hand lever, chain, ...) and check for smooth operation. 🛠️	•	•	•	•

	K10N	K75A	K150A	K300A
Clean the dust boots of the fork legs.		•	•	•
Check the front brake fluid level. (☞ p. 86)	•	•	•	•
Bleed the fork legs. (☞ p. 70)		•	•	•
Check the steering head bearing play.	•	•	•	•
Change the spark plugs. 🛠️			•	•
Check the valve clearance. 🛠️			•	•
Check all hoses (e.g. fuel, cooling, bleeding, drainage, ...) and sleeves for cracking, leaks, and incorrect routing. 🛠️			•	•
Check the antifreeze and coolant level. (☞ p. 140)	•	•	•	•
Check the wiring harness of the throttle valve body for damage and correct routing. 🛠️			•	•
Check the cables for damage and kink-free routing. 🛠️			•	•
Check the control cables for damage, kink-free routing and adjustment.	•	•	•	•
Change the air filter. Clean the air filter box. 🛠️			•	•
Check the fuel pressure. 🛠️		•	•	•
Check the value of the manifold absolute pressure sensor (PM value) with the KTM diagnostics tool. 🛠️		•	•	•
Check the CO adjustment with the KTM diagnostics tool. 🛠️		•	•	•
Check/rectify the fluid level of the hydraulic clutch. (☞ p. 82)		•	•	•
Check the fasteners for tightness. 🛠️	•	•	•	•
Change the coolant. 🛠️				•
Change the front brake fluid. 🛠️			•	•
Change the rear brake fluid. 🛠️			•	•
Check the clutch. 🛠️			•	•

	K10N	K75A	K150A	K300A
Check the headlight setting. (☞ p. 134)	•	•	•	•
Check the radiator fan operation. ☞	•	•	•	•
Final inspection: Check the vehicle of roadworthiness and take a test ride.	•	•	•	•
Read out the fault memory after a test ride using the KTM diagnostics tool. ☞	•	•	•	•
Make the service entries in the KTM DEALER.NET and service record. ☞	•	•	•	•

K10N: Once after 1,000 km (621.4 mi)

K75A: Every 7,500 km (4,660 mi) or annually

K150A: Every 15,000 km (9,321 mi) or every 2 years

K300A: Every 30,000 km (18,641 mi) or every 4 years

Fork/shock absorber



The fork and the shock absorber offer many options of adapting the suspension to your riding style and the payload.



Info

To help you adapt the vehicle, we have summarized our findings in Table ❶. You can find the table on the air filter box after you remove the seat. In all settings except for the spring preload of the shock absorber, the value is adjusted by first turning the screw all the way in and then setting the value. Do not use excessive force to turn the adjusting screws against the stop, and take the last perceptible click as the end position.

These adjustments should be understood as a guideline and should always be the basis of your own personal suspension adaptation. Do not change the adjustments at random or by more than $\pm 40\%$, since otherwise the riding characteristics could deteriorate, particularly at high speeds.

Adjusting the compression damping of the fork



Info

The hydraulic compression damping determines the fork suspension behavior.

An optimally adjusted compression damping ensures that the fork does not compress too far and fast when you brake hard or when the load shifts very fast. It gives the rider good feedback about the road conditions.

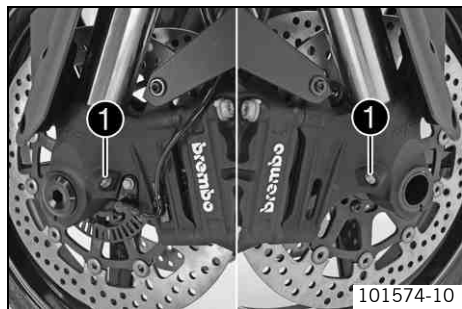

- Turn adjusting screws ❶ clockwise all the way.



Info

The adjusting screws are located at the bottom end of the fork legs. Make the same adjustment on both fork legs.

- Turn back counterclockwise by the number of clicks corresponding to the fork type.

Guideline

Compression damping	
Comfort	20 clicks
Standard	15 clicks
Sport	10 clicks
Full payload	10 clicks



Info

Turn clockwise to increase damping; turn counterclockwise to reduce damping.

Adjusting the rebound damping of the fork



Info

The hydraulic rebound damping determines the fork rebound behavior.

An optimally adjusted rebound damping brakes the springing energy and enables a fast, vibration-free resetting of the fork to the zero position.

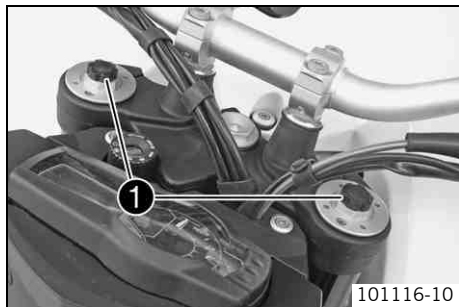

- Turn adjusting screws ❶ clockwise all the way.



Info

The adjusting screws are located at the top end of the fork legs. Make the same adjustment on both fork legs.

- Turn back counterclockwise by the number of clicks corresponding to the fork type.

Guideline

Rebound damping	
Comfort	20 clicks
Standard	15 clicks
Sport	10 clicks
Full payload	10 clicks



Info

Turn clockwise to increase damping; turn counterclockwise to reduce damping.

Adjusting the spring preload of the fork



Info

The spring preload determines the initial fork position.

The best spring preload setting is achieved when it is set for the weight of the rider and that of any baggage and a passenger, thus ensuring an ideal compromise between maneuverability and stability.

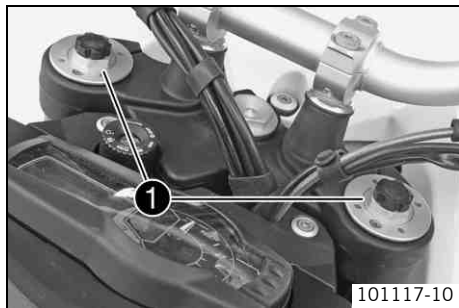

- Turn adjusting screws ❶ clockwise all the way.

i **Info**

The adjusting screws are located at the top end of the fork legs. Make the same adjustment on both fork legs.

- Turn back counterclockwise by the number of turns according to the fork type.

Guideline

Spring preload - Preload Adjuster	
Comfort	5 turns
Standard	5 turns
Sport	3 turns
Full payload	3 turns

i **Info**

Turn clockwise to increase preload; turn counterclockwise to reduce spring preload.

Changing the spring preload has no influence on the rebound damping although the adjusting screws turn during the adjustment work. However, you should also adjust the rebound damping when you alter the spring preload.

Compression damping of the shock absorber



The compression damping of the shock absorber is divided into two ranges: high-speed and low-speed.

High-speed and low-speed refer to the compression speed of the rear wheel suspension and not to the vehicle speed.

The high-speed setting, for example, has an effect on the landing after a jump: the rear wheel suspension compresses more quickly.

The low-speed setting, for example, has an effect when riding over long ground swells: the rear wheel suspension compresses more slowly.

These two ranges can be adjusted separately, although the transition between high-speed and low-speed is gradual. Thus, changes in the high-speed range affect the compression damping in the low-speed range and vice versa.

Adjusting the low-speed compression damping of the shock absorber



Caution

Danger of accidents Disassembly of pressurized parts can lead to injury.

- The shock absorber is filled with high density nitrogen. Adhere to the description provided. (Your authorized KTM workshop will be glad to help.)



Info

The low-speed setting can be seen during the slow to normal compression of the shock absorber.

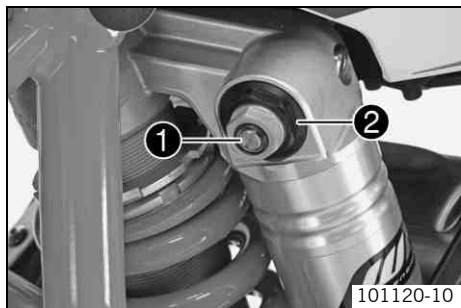

- Turn adjusting screw ❶ clockwise with a screwdriver up to the last perceptible click.

i Info
Do not loosen nut ❷!

- Turn back counterclockwise by the number of clicks corresponding to the shock absorber type.

Guideline

Compression damping, low-speed	
Comfort	25 clicks
Standard	20 clicks
Sport	15 clicks
Full payload	15 clicks

i Info
Turn clockwise to increase damping; turn counterclockwise to reduce damping.

Adjusting the high-speed compression damping of the shock absorber

! Caution
Danger of accidents Disassembly of pressurized parts can lead to injury.

- The shock absorber is filled with high density nitrogen. Adhere to the description provided. (Your authorized KTM workshop will be glad to help.)

i Info
The high-speed setting can be seen during the fast compression of the shock absorber.

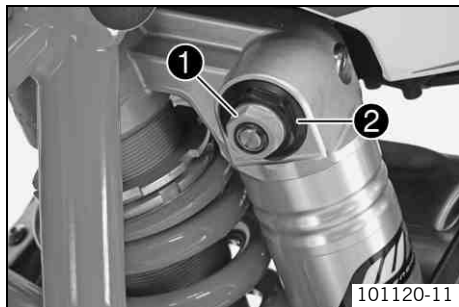

- Turn adjusting screw ❶ clockwise all the way using a socket wrench.

i Info
Do not loosen nut ❷!

- Turn back counterclockwise by the number of turns corresponding to the shock absorber type.

Guideline

Compression damping, high-speed	
Comfort	2 turns
Standard	1.5 turns
Sport	1 turn
Full payload	1 turn

i Info
Turn clockwise to increase damping; turn counterclockwise to reduce damping.

Adjusting the rebound damping of the shock absorber

! Caution
Danger of accidents Disassembly of pressurized parts can lead to injury.

- The shock absorber is filled with high density nitrogen. Adhere to the description provided. (Your authorized KTM workshop will be glad to help.)

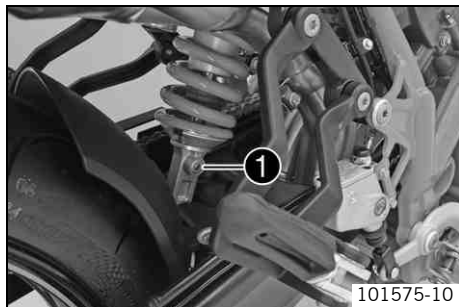

- Turn adjusting screw ❶ clockwise up to the last perceptible click.
- Turn back counterclockwise by the number of clicks corresponding to the shock absorber type.

Guideline

Rebound damping	
Comfort	20 clicks
Standard	15 clicks
Sport	10 clicks
Full payload	10 clicks

i Info Turn clockwise to increase damping; turn counterclockwise to reduce damping.

Adjusting the spring preload of the shock absorber ↩

⚠ Warning **Danger of accidents** Modifications to the suspension settings can seriously alter the vehicle's ride behavior.

- Following modifications, ride slowly at first to get the feel of the new ride behavior.

i Info The spring preload defines the initial situation of the spring process on the shock absorber. The best spring preload setting is achieved when it is set for the weight of the rider and that of any baggage and a passenger, thus ensuring an ideal compromise between maneuverability and stability. Before changing the spring preload, make a note of the present setting, e.g., by measuring the length of the spring.

Preliminary work

- Take the weight off the rear wheel and swingarm.



Info

The spring preload can be adjusted correctly only if the rear wheel and the swingarm are fully relieved of weight.

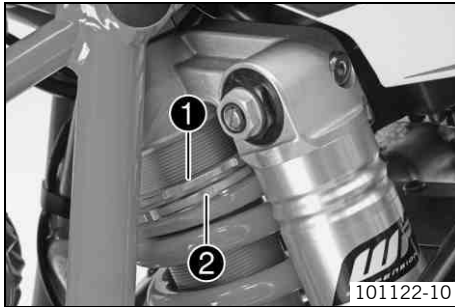

101122-10

Main work

- Release retaining ring ❶.
- Turn adjusting ring ❷ until the spring is fully relaxed.

Hook wrench (T157S)

- Measure the overall spring length without a load.
- Tension the spring by turning adjusting ring ❷ to the prescribed value.

Guideline

Spring preload	
Comfort	11 mm (0.43 in)
Standard	11 mm (0.43 in)
Sport	11 mm (0.43 in)
Full payload	13 mm (0.51 in)

- Tighten retaining ring ❶.

Raising the motorcycle with the front wheel stand

Note

Danger of damage The parked vehicle may roll away or fall over.

- Always place the vehicle on a firm and even surface.

Preliminary work

- Raise the motorcycle with the rear wheel stand. (🔧 p. 69)

Main work

- Move the handlebar to the straight-ahead position. Align the front wheel stand with the fork legs using the adapters.

Front wheel stand (61029055300)



Info

Always raise the rear of the motorcycle first.

- Raise the front of the motorcycle.

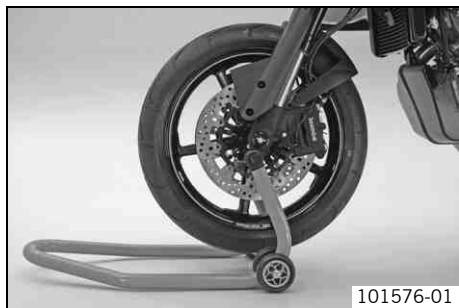

Taking the motorcycle off of the front wheel stand

Note

Danger of damage The parked vehicle may roll away or fall over.

- Always place the vehicle on a firm and even surface.

- Secure the motorcycle against falling over.
- Remove the front wheel stand.

Raising the motorcycle with the rear wheel stand

Note

Danger of damage The parked vehicle may roll away or fall over.

- Always place the vehicle on a firm and even surface.

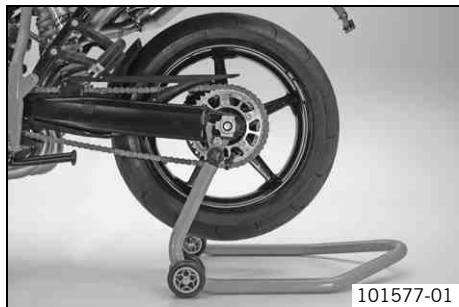

- Mount the lifting bushings on the swingarm.
- Insert the adapter in the rear wheel stand.

Adapter (61029055120)

Rear wheel stand (61029055400)

- Stand the motorcycle upright, align the wheel stand with the swingarm and the adapters, and lift the motorcycle.

Taking the motorcycle off the rear wheel stand

Note

Danger of damage The parked vehicle may roll away or fall over.

- Always place the vehicle on a firm and even surface.
- Secure the motorcycle against falling over.
- Remove the rear wheel stand and lean the vehicle on the side stand.
- Remove the lifting bushings from the swingarm.

Bleeding the fork legs

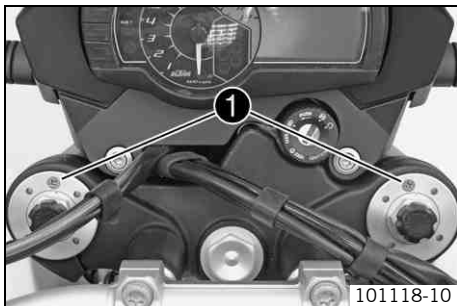

Preliminary work

- Lean the motorcycle on the side stand.

Main work

- Remove bleeder screws ❶ briefly.
 - ✓ Any excess pressure escapes from the interior of the fork.
- Mount and tighten the bleeder screws.



Info

Carry out this operation on both fork legs.

Removing the seat

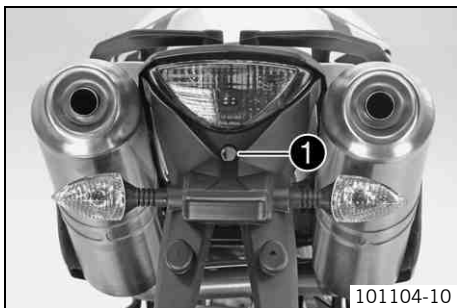

- Insert the ignition key in the seat lock ❶ and turn it clockwise.
- Raise the rear of the seat, push it towards the rear, and remove it upwards.
- Remove the ignition key from the seat lock.

Mounting the seat

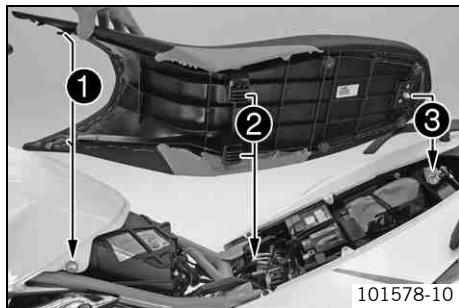

- Position front recesses ❶ of the seat on the oval head screws of the fuel tank, lower the rear and simultaneously push it forward. Both lugs ❷ must hook into the frame and locking bolt ❸ must be inserted into the lock housing.
 - ✓ The seat engages with an audible click.
- Finally, check that the seat is correctly mounted.

Mounting the helmet lock on the vehicle



Warning

Danger of accidents Impairment of ride behavior and vehicle operation if a helmet or helmet lock is attached to the vehicle.

- Do not use the helmet lock for holding a helmet or other objects during the journey. Always remove the helmet lock before starting out.

Preliminary work

- Remove the seat. (🔧 p. 70)

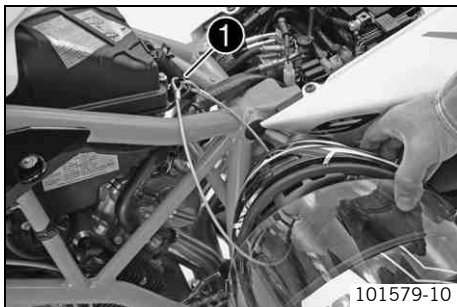

Main work

- Position the steel cable from the tool set with one loop on hook ❶.

Steel cable (60012015000)

- Guide the steel cable through the helmet opening.
- Attach the free loop of the steel cable to the hook as well.
- Position the helmet carefully on the side of the vehicle.

Subsequent work

- Mount the seat. (👉 p. 71)

Reinstalling the fuel tank



Preliminary work

- Remove the seat. (👉 p. 70)

Main work

- Remove screws ❶ and the spoiler on both sides.

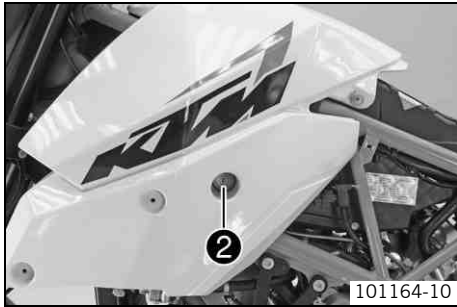

- Remove screw ② on both sides.

**Info**

The fuel hoses do not need to be disconnected.

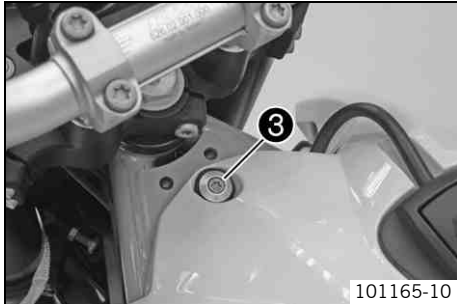

- Remove screw ③.
- Carefully push the fuel tank back.

Positioning the fuel tank

Main work

- Carefully push the fuel tank forward.

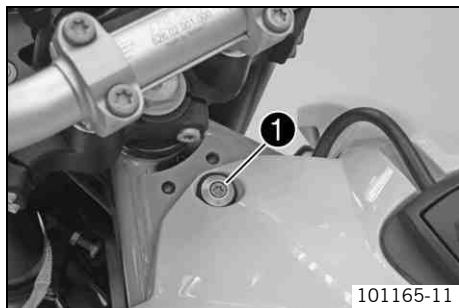

- Mount and tighten screw ❶ with the collar bushing.

Guideline

Remaining chassis screws	M6	10 Nm (7.4 lbf ft)
--------------------------	----	--------------------

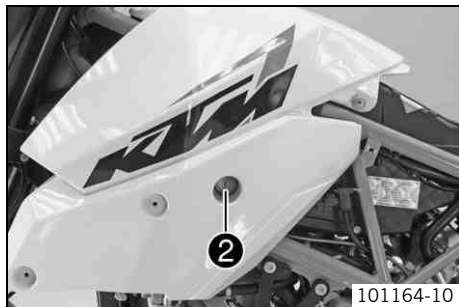

- Install and tighten screw ❷ with the bearing sleeve and rubber bushing on both sides.

Guideline

Remaining chassis screws	M8	25 Nm (18.4 lbf ft)
--------------------------	----	------------------------

- Check the routing of the fuel lines.



- Position the spoilers on both sides. Mount and tighten screws ❸.

Guideline

Screw, spoiler	M6	3.3 Nm (2.43 lbf ft)
----------------	----	-------------------------

Subsequent work

- Mount the seat. (👉 p. 71)

Checking the chain for dirt

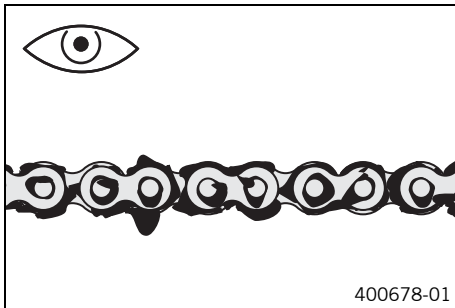

- Check the chain for coarse dirt accumulation.
 - » If the chain is very dirty:
 - Clean the chain. (👉 p. 75)

Cleaning the chain



Warning

Danger of accidents Oil or grease on the tires reduces their grip.

- Remove oil and grease with a suitable cleaning material.



Warning

Danger of accidents Reduced braking efficiency due to oil or grease on the brake discs.

- Always keep the brake discs free of oil and grease, and clean them with brake cleaner when necessary.



Warning

Environmental hazard Hazardous substances cause environmental damage.

- Oil, grease, filters, fuel, cleaners, brake fluid, etc., should be disposed of as stipulated in applicable regulations.



Info

The service life of the chain depends largely on its maintenance.

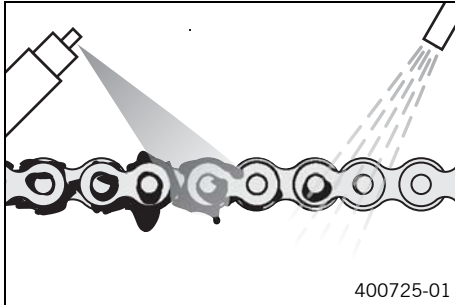

- Clean the chain regularly.
- Rinse off loose dirt with a soft jet of water.
- Remove old grease remains with chain cleaner.

Chain cleaner (☛ p. 195)

- After drying, apply chain spray.

Chain lube for road use (☛ p. 195)

Checking the chain tension



Warning

Danger of accidents Danger caused by incorrect chain tension.

- If the chain tension is too high, the components of the secondary power train (chain, engine sprocket, rear sprocket, bearings in transmission and rear wheel) are under additional load. Apart from premature wear, in extreme cases the chain can rupture or the countershaft of the transmission can break. On the other hand, if the chain is loose, it can fall off the engine sprocket or the rear sprocket and block the rear wheel or damage the engine. Check the chain tension and correct if necessary.

Preliminary work

- Lean the motorcycle on the side stand.

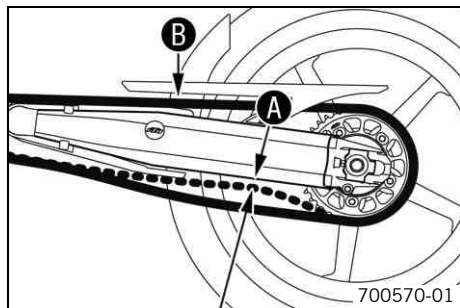

Main work

- Shift the transmission to neutral.
- In the area after the chain sliding guard, press the chain upward toward the link fork and measure chain tension **A**.

Info

The upper chain section **B** must be taut.

Chain wear is not always even, so you should repeat this measurement at different chain positions.

Chain tension	7 mm (0.28 in)
---------------	----------------

- » If the chain tension does not meet specifications:
 - Adjust the chain tension. (☞ p. 77)

Adjusting the chain tension



Warning

Danger of accidents Danger caused by incorrect chain tension.

- If the chain tension is too high, the components of the secondary power train (chain, engine sprocket, rear sprocket, bearings in transmission and rear wheel) are under additional load. Apart from premature wear, in extreme cases the chain can rupture or the countershaft of the transmission can break. On the other hand, if the chain is loose, it can fall off the engine sprocket or the rear sprocket and block the rear wheel or damage the engine. Check the chain tension and correct if necessary.

Preliminary work

- Lean the motorcycle on the side stand.
- Check the chain tension. (☞ p. 76)

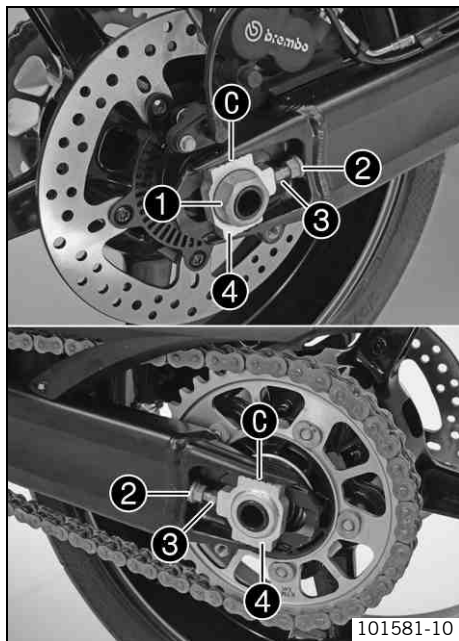

Main work

- Loosen nut ❶.
- Loosen nuts ❷.
- Adjust the chain tension by turning the adjusting screws ❸ on the left and right.

Guideline

Chain tension	7 mm (0.28 in)
Turn adjusting screws ❸ on the left and right so that the markings on the left and right chain adjuster ❹ are in the same position in relation to reference marks ❷. The rear wheel is then correctly aligned.	

Info

The upper chain section must be taut.

Chain wear is not always even, so you should check the setting at different chain positions.

- Tighten nuts ❷.
- Make sure that chain adjusters ❹ are resting against adjusting screws ❸.
- Tighten nut ❶.

Guideline

Nut, rear wheel spindle	M25x1.5	90 Nm (66.4 lbf ft)	Thread greased
-------------------------	---------	------------------------	----------------

Info

The wide adjustment range of the chain adjusters (32 mm (1.26 in)) enables different secondary transmissions with the same chain length.

Chain adjusters ❹ can be turned through 180°.

Checking the chain, rear sprocket, engine sprocket and chain guide

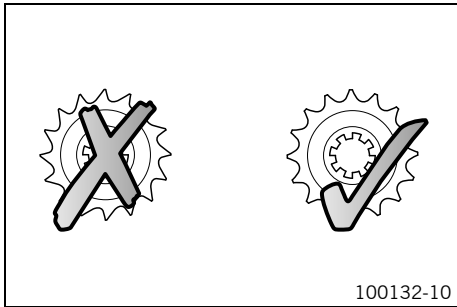

- Check the rear sprocket and engine sprocket for wear.
 - » If the rear sprocket or engine sprocket is worn:
 - Replace the rear sprocket or engine sprocket. 



Info

The rear sprocket, engine sprocket and chain should always be changed together.

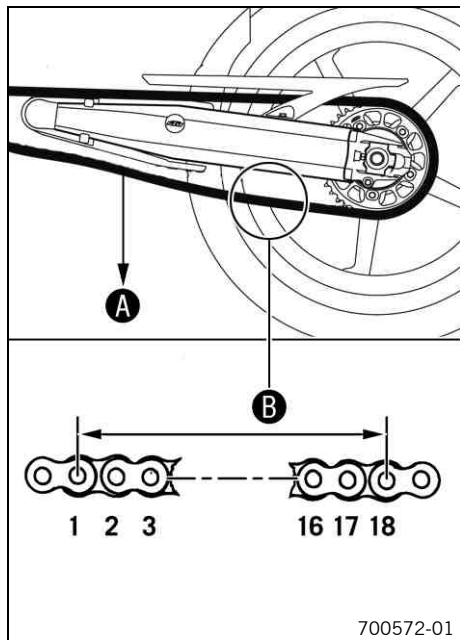

700572-01

- Shift the transmission to neutral.
- Pull the lower chain section with specified weight **A**.

Guideline

Weight, chain wear measurement	15 kg (33 lb.)
--------------------------------	----------------

- Measure the distance **B** of 18 chain links in the lower chain section.

i Info

Chain wear is not always even, so you should repeat this measurement at different chain positions.

Maximum distance B at the longest chain section	272 mm (10.71 in)
--	-------------------

- » If distance **B** is greater than the specified measurement:
 - Replace the chain.

i Info

When the chain is replaced, the rear sprocket and engine sprocket should also be changed.
 New chains wear out faster on old, worn sprockets.
 For safety reasons, the chain has no chain joint.

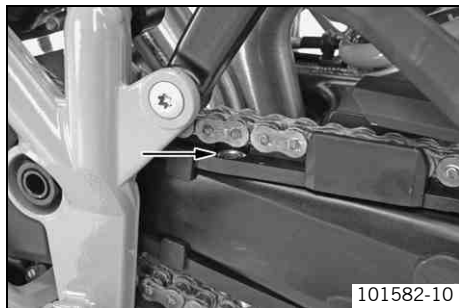

- Check the chain sliding guard for wear.
 - » If there is no gap between the chain and the upper edge of the screw:
 - Change the chain sliding guard. 🛠️
- Check the chain sliding guard for tightness.
 - » If the chain sliding guard is loose:
 - Tighten the chain sliding guard.

Guideline

Screw, chain sliding guard	M5	5 Nm (3.7 lbf ft)	-
Screw, chain sliding guard	M6	6 Nm (4.4 lbf ft)	Loctite® 243™

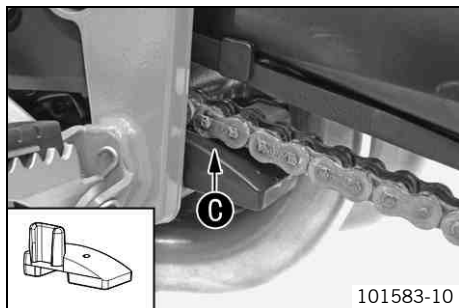

- Check the chain sliding piece for wear.
 - » If the drill hole becomes visible on the chain sliding piece in area **C**:
 - Change the chain sliding piece. 🛠️
- Check the chain sliding piece for tightness.
 - » If the chain sliding piece is loose:
 - Tighten the chain sliding piece.

Guideline

Screw, chain sliding piece	EJOT PT K60x20	2 Nm (1.5 lbf ft)
----------------------------	----------------	-------------------

Adjusting the basic position of the clutch lever

i Info

Turn the adjusting screw clockwise to increase the distance between the clutch lever and the handlebar.
Turn the adjusting screw counterclockwise to decrease the distance between the clutch lever and the handlebar.
The range of adjustment is limited.
Turn the adjusting screw by hand only, and do not apply any force.
Do not make any adjustments while riding!

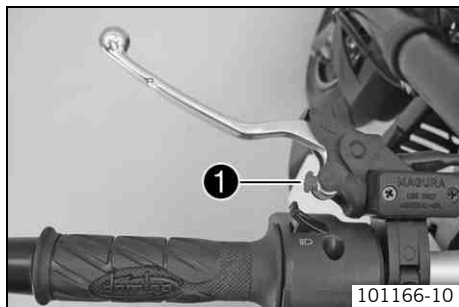

- Adjust the basic setting of the clutch lever to your hand size by turning adjusting screw ❶.

Checking/rectifying the fluid level of the hydraulic clutch

i Info

The fluid level rises with increasing wear of the clutch lining disc.
Do not use brake fluid.

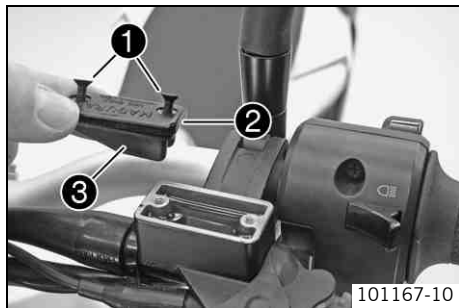

- Move the clutch fluid reservoir mounted on the handlebar to a horizontal position.
- Remove screws ❶.
- Remove cover ❷ with membrane ❸.
- Check the fluid level.

Fluid level below container rim	4 mm (0.16 in)
---------------------------------	----------------

- » If the coolant level does not meet specifications:
 - Correct the fluid level of the hydraulic clutch.

Hydraulic fluid (15) (☛ p. 193)

- Position the cover with the membrane. Mount and tighten the screws.

ABS/antilock brake system

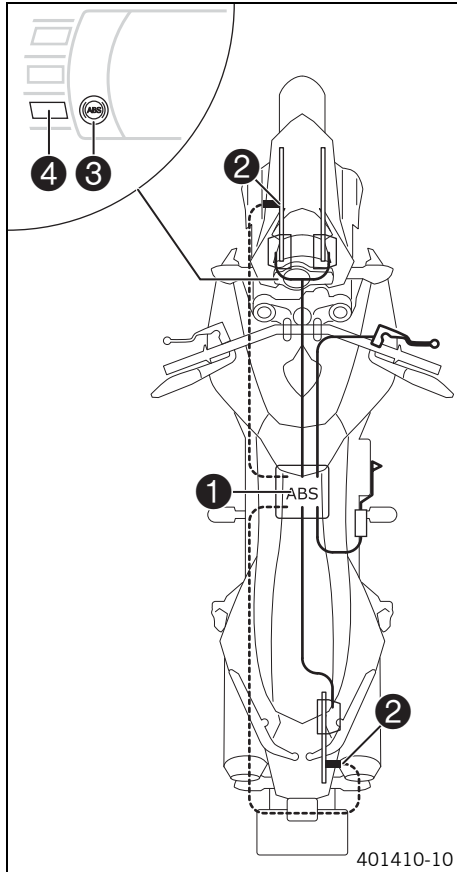

The ABS unit ❶, which consists of a hydraulic unit, ABS control unit, and return pump, is installed under the seat. The front and rear wheels each have a wheel speed sensor ❷.



Warning

Danger of accidents Impaired ABS function

- The ABS cannot function properly if certain modifications have been made such as shorter or longer suspension travel, other rim diameters, other tires, an incorrect tire air pressure, other brake linings, etc.
- The ABS will only function correctly if the spare parts used in the brake system and the tires have been approved and/or recommended by KTM.
- Maintenance work and repairs must be carried out professionally. (Your authorized KTM workshop will be glad to help.)

The ABS is a safety system that prevents locking of the wheels when the vehicle is traveling straight ahead without the action of lateral forces.

The ABS operates with two independent brake circuits (front and rear brakes). During normal operation, the brake system operates like a conventional brake system without ABS. When the ABS control unit detects the tendency of a wheel to lock, the ABS begins regulating the braking pressure. The control process causes the hand and foot brake levers to vibrate slightly.

The ABS warning lamp ❸ must light up briefly after the ignition is switched on and should then go out after starting off. If it does not go out after starting off or if it lights up while riding, this indicates a fault in the ABS system. In this case, the ABS is no longer enabled and the wheels may lock during braking. The brake system itself stays functional; only ABS control is not available.

The ABS warning lamp may also light up if the rotating speeds of the front and rear wheels differ greatly under extreme riding conditions, for example when making wheelies or if the rear wheel spins. This causes the ABS to switch off.

To reenble the ABS, the vehicle must be stopped and the ignition switched off. The ABS is reenbled when the vehicle is switched on again. The ABS warning lamp goes out when you start off.

Button ④ can be used to switch ABS off manually (see Starting).

Adjusting the basic position of the hand brake lever

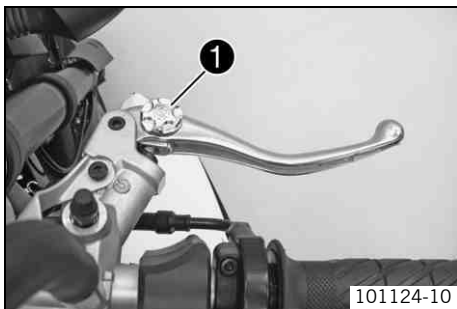

- Pull the hand brake lever forward.
- Adjust the basic setting of the hand brake lever to your hand size by turning adjusting wheel ①.



Info

Do not make any adjustments while riding!

Checking the front brake discs



Warning

Danger of accidents Reduced braking efficiency due to worn brake disc(s).

- Change the worn brake disc(s) without delay. (Your authorized KTM workshop will be glad to help.)

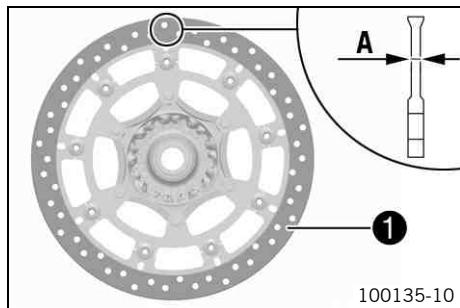

100135-10

- Check the thickness of the brake disc in several places to see if it conforms to measurement **A**.

i Info

Wear reduces the thickness of the brake discs in area **1** of the brake discs.

Brake discs - wear limit	
Front	4.5 mm (0.177 in)

- » If the brake disc thickness is less than the specified value:
 - Change the brake discs. 🛠️
- Check the brake discs for damage, cracking and deformation.
 - » If the brake discs exhibit damage, cracking or deformation:
 - Change the brake discs. 🛠️

Checking the front brake fluid level



Warning

Danger of accidents Failure of the brake system.

- If the brake fluid level falls below the **MIN** mark, this indicates a leakage in the brake system or worn-out brake linings. Check the brake system and do not continue riding. (Your authorized KTM workshop will be glad to help.)



Warning

Danger of accidents Reduced braking efficiency due to old brake fluid.

- Change the brake fluid of the front and rear brake according to the service schedule. (Your authorized KTM workshop will be glad to help.)

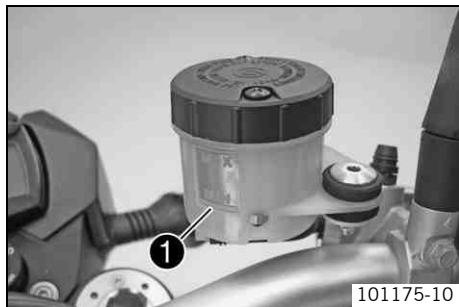

- Move the brake fluid reservoir mounted on the handlebar to a horizontal position.
- Check the brake fluid level in the brake fluid reservoir ❶.
 - » If the brake fluid is below the **MIN** marking:
 - Add front brake fluid. 🛠️ (📖 p. 87)

Adding front brake fluid 🛠️



Warning

Danger of accidents Failure of the brake system.

- If the brake fluid level falls below the **MIN** mark, this indicates a leakage in the brake system or worn-out brake linings. Check the brake system and do not continue riding. (Your authorized KTM workshop will be glad to help.)



Warning

Skin irritation Brake fluid can cause skin irritation on contact.

- Avoid contact with skin and eyes, and keep out of the reach of children.
- Wear suitable protective clothing and goggles.
- If brake fluid comes into contact with the eyes, flush the eyes thoroughly with water and consult a physician immediately.



Warning

Danger of accidents Reduced braking efficiency due to old brake fluid.

- Change the brake fluid of the front and rear brake according to the service schedule. (Your authorized KTM workshop will be glad to help.)



Warning

Environmental hazard Hazardous substances cause environmental damage.

- Oil, grease, filters, fuel, cleaners, brake fluid, etc., should be disposed of as stipulated in applicable regulations.



Info

Avoid contact between brake fluid and painted parts. Brake fluid is corrosive and will damage painted surfaces. Use only clean brake fluid from a sealed container.

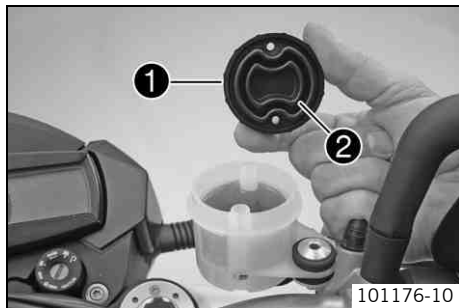

- Move the brake fluid reservoir mounted on the handlebar to a horizontal position.
 - Remove screws.
 - Remove cover ❶ with membrane ❷.
 - Add brake fluid to the **MAX** level.
- Brake fluid DOT 4 / DOT 5.1 (☞ p. 191)
- Position the cover with the membrane. Mount and tighten the screws.



Info

Clean up overflowed or spilt brake fluid immediately with water.

Checking the front brake linings



Warning

Danger of accidents Reduced braking efficiency caused by worn brake linings.

- Change worn brake linings immediately. (Your authorized KTM workshop will be glad to help.)

Note

Danger of accidents Reduced braking efficiency caused by damaged brake discs.

- If the brake linings are not changed in time, the steel brake lining carriers grind on the brake disc. The braking effect is greatly reduced and the brake discs are rendered unserviceable. Check the brake linings regularly.

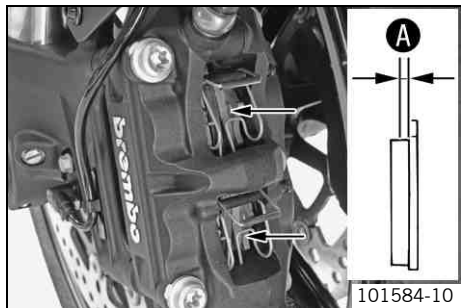

- Check all brake linings on both brake calipers to ensure they have minimum thickness **A**.

Minimum thickness A	$\geq 1 \text{ mm } (\geq 0.04 \text{ in})$
----------------------------	---

- » If the minimum thickness is less than specified:
 - Change the front brake linings. 🛠️
- Check all brake linings on both brake calipers for damage and cracking.
 - » If damage or wear is encountered:
 - Change the front brake linings. 🛠️

Checking the free travel of the foot brake lever



Warning

Danger of accidents Brake system failure.

- If there is no free travel on the foot brake lever, pressure builds up on the rear brake circuit. The rear brake can fail due to overheating. Adjust free travel on foot brake lever according to specifications.

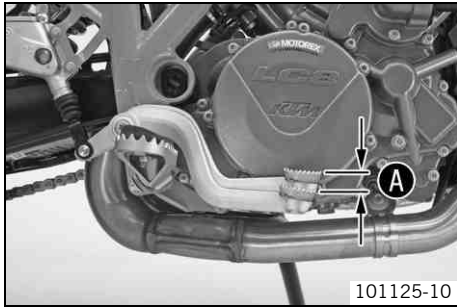

101125-10

- Move the foot brake lever back and forth between the end stop and the contact to the piston rod and check free travel **A**.

Guideline

Free travel at foot brake lever	3... 5 mm (0.12... 0.2 in)
---------------------------------	----------------------------

i Info
The piston rod should not move.

- » If the free travel does not meet specifications:
 - Adjust the free travel to the specified value.

Adjusting the basic position of the foot brake lever

! Warning
Danger of accidents Brake system failure.

- If there is no free travel on the foot brake lever, pressure builds up on the rear brake circuit. The rear brake can fail due to overheating. Adjust free travel on foot brake lever according to specifications.

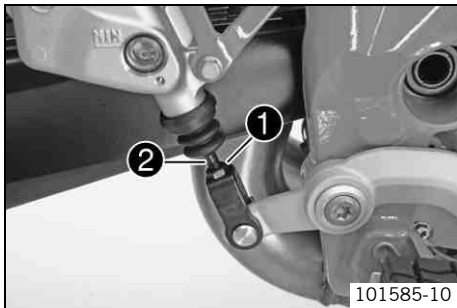

101585-10

- Release nut **1** and turn push rod **2** until the foot brake lever is in the desired position.
✓ At least two thread turns are visible at the lower nut.

i Info
The range of adjustment is limited.

- Check the free travel of the foot brake lever. (☛ p. 89)
- Tighten nut **1**.

Checking the rear brake disc



Warning

Danger of accidents Reduced braking efficiency due to worn brake disc(s).

- Change the worn brake disc(s) without delay. (Your authorized KTM workshop will be glad to help.)

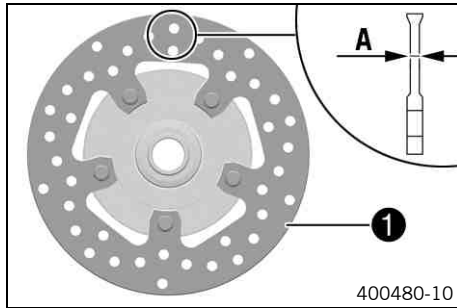

- Check the thickness of the brake disc in several places to see if it conforms to measurement **A**.



Info

Wear reduces the thickness of the brake disc in area **1** of the brake disc.

Brake disc - wear limit	
Rear	4.5 mm (0.177 in)

- » If the brake disc thickness is less than the specified value:
 - Change the brake disc. 🛠️
- Check the brake disc for damage, cracking and deformation.
 - » If damage, cracks or deformation are visible on the brake disc:
 - Change the brake discs. 🛠️

Checking the rear brake fluid level



Warning

Danger of accidents Failure of the brake system.

- If the brake fluid level falls below the **MIN** mark, this indicates a leakage in the brake system or worn-out brake linings. Check the brake system and do not continue riding. (Your authorized KTM workshop will be glad to help.)



Warning

Danger of accidents Reduced braking efficiency due to old brake fluid.

- Change the brake fluid of the front and rear brake according to the service schedule. (Your authorized KTM workshop will be glad to help.)

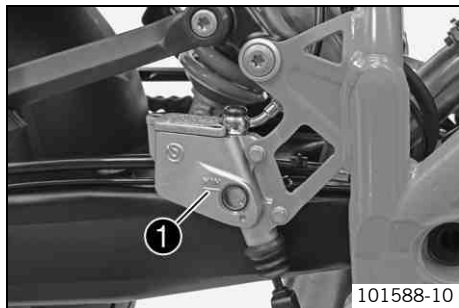

- Stand the vehicle upright.
- Check the brake fluid level of the brake fluid reservoir.
 - » If the fluid level reaches the **MIN** mark ❶:
 - Add rear brake fluid. 🛠️ (📖 p. 92)

Adding rear brake fluid 🛠️



Warning

Danger of accidents Failure of the brake system.

- If the brake fluid level falls below the **MIN** mark, this indicates a leakage in the brake system or worn-out brake linings. Check the brake system and do not continue riding. (Your authorized KTM workshop will be glad to help.)



Warning

Skin irritation Brake fluid can cause skin irritation on contact.

- Avoid contact with skin and eyes, and keep out of the reach of children.
- Wear suitable protective clothing and goggles.
- If brake fluid comes into contact with the eyes, flush the eyes thoroughly with water and consult a physician immediately.



Warning

Danger of accidents Reduced braking efficiency due to old brake fluid.

- Change the brake fluid of the front and rear brake according to the service schedule. (Your authorized KTM workshop will be glad to help.)



Warning

Environmental hazard Hazardous substances cause environmental damage.

- Oil, grease, filters, fuel, cleaners, brake fluid, etc., should be disposed of as stipulated in applicable regulations.



Info

Avoid contact between brake fluid and painted parts. Brake fluid is corrosive and will damage painted surfaces. Use only clean brake fluid from a sealed container.

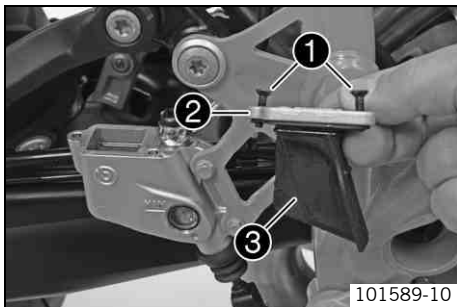

- Remove screws ❶.
- Remove cover ❷ with membrane ❸.

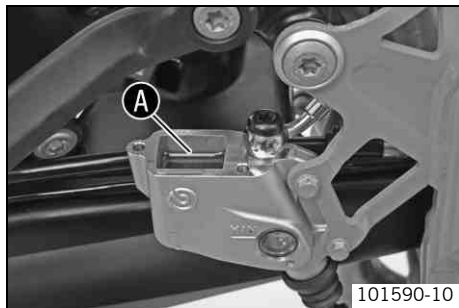

- Add brake fluid to level **A**.

Brake fluid DOT 4 / DOT 5.1 (☛ p. 191)

- Position the cover with the membrane. Mount and tighten the screws.



Info

Clean up overflowed or spilt brake fluid immediately with water.

Checking the rear brake linings



Warning

Danger of accidents Reduced braking efficiency caused by worn brake linings.

- Change worn brake linings immediately. (Your authorized KTM workshop will be glad to help.)

Note

Danger of accidents Reduced braking efficiency caused by damaged brake discs.

- If the brake linings are not changed in time, the steel brake lining carriers grind on the brake disc. The braking effect is greatly reduced and the brake discs are rendered unserviceable. Check the brake linings regularly.

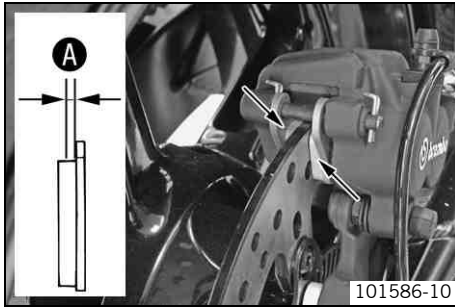



- Check the brake linings for minimum thickness **A**.

Minimum thickness A	$\geq 1 \text{ mm } (\geq 0.04 \text{ in})$
----------------------------	---

- » If the minimum thickness is less than specified:
 - Change the rear brake linings. 🔧
- Check the brake linings for damage and cracking.
 - » If damage or wear is encountered:
 - Change the rear brake linings. 🔧

Removing the front wheel

Preliminary work

- Raise the motorcycle with the rear wheel stand. ( p. 69)
- Raise the motorcycle with the front wheel stand. ( p. 68)

Main work

- Take the speed sensor cable out of the clamp.
- Remove screw **1** and pull wheel speed sensor **2** out of the hole with the sleeve.
- Remove screws **3** from both brake calipers.
- Press back the brake linings with a light lateral tilting of the brake calipers on the brake disc. Pull the brake calipers carefully back from the brake discs and hang them to one side.

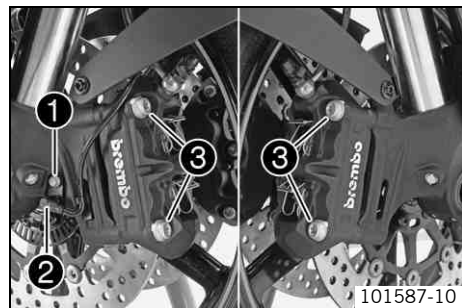

101587-10

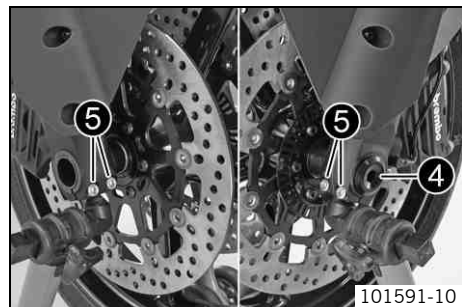

101591-10

Info

Do not pull the hand brake lever when the brake calipers are removed.

- Loosen screws **4** and **5**.
- Unscrew screw **4** about six turns and press your hand on the screw to push the wheel spindle out of the axle clamp. Remove screw **4**.

Warning

Danger of accidents Reduced braking efficiency due to damaged brake discs.

- Always lay down the wheel in such a way that the brake discs are not damaged.
-
- Holding the front wheel, withdraw the wheel spindle. Take the front wheel out of the fork.

Installing the front wheel





Warning

Danger of accidents  Reduced braking efficiency due to oil or grease on the brake discs.

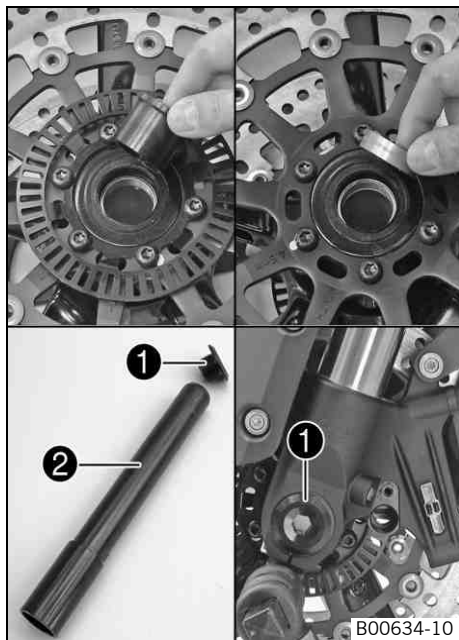
- Always keep the brake discs free of oil and grease, and clean them with brake cleaner when necessary.



- Check the wheel bearing for damage and wear.
 - » If the wheel bearing is damaged or worn:
 - Replace the wheel bearing. 
- Clean, grease, and mount the left and right spacers and the shaft seal rings.

Long-life grease ( p. 196)

- Clean screw **1** and wheel spindle **2**.
- Lift the front wheel into the fork, position it, and insert the wheel spindle.
 - ✓ The arrow on the spoke points in the direction of motion.
- Mount and tighten screw **1**.

Guideline

Bolt, front axle	M25x1.5	45 Nm (33.2 lbf ft)
------------------	---------	------------------------

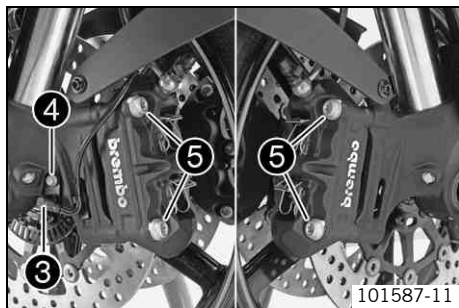

- Slide the sleeve onto the wheel speed sensor ③ and push them into the hole together. Mount and tighten screw ④.

Guideline

Screw, wheel speed sensor	M6	6 Nm (4.4 lbf ft)	Loctite® 243™
---------------------------	----	----------------------	----------------------

- Fasten the speed sensor cable in the bracket.
- Position the brake calipers and check that the brake linings are seated correctly.
- Mount screws ⑤ on both brake calipers but do not tighten yet.
- Operate the hand brake lever repeatedly until the brake linings are in contact with the brake disc and there is a pressure point. Fix the hand brake lever in the activated position.
 - ✓ The brake calipers straighten.
- Tighten screws ⑤ on both brake calipers.

Guideline

Screw, front brake caliper	M10x1.25	45 Nm (33.2 lbf ft)	Loctite® 243™
----------------------------	----------	------------------------	----------------------

- Release the fixation of the hand brake lever.
- Take the motorcycle off of the front wheel stand. (👉 p. 68)
- Take the motorcycle off of the rear wheel stand. (👉 p. 69)

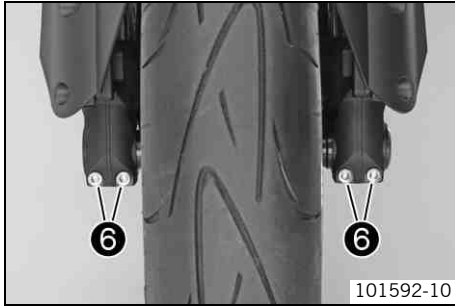

- Pull the front brake and compress the fork powerfully a few times.
 - ✓ The fork legs straighten.
- Tighten screws ⑥.

Guideline

Screw, fork stub	M8	15 Nm (11.1 lbf ft)
------------------	----	------------------------

Removing the rear wheel

Preliminary work

- Raise the motorcycle with the rear wheel stand. ( p. 69)

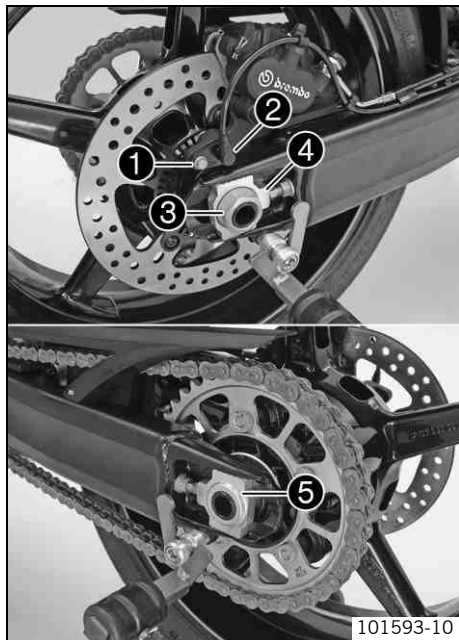

Main work

- Remove screw ① and pull wheel speed sensor ② out of the hole.
- Remove nut ③. Remove chain adjuster ④.
- Pull out wheel spindle ⑤ to the point where the chain adjuster is no longer in contact with the adjusting screw.



- Push the rear wheel forward as far as possible and take the chain off the rear sprocket.
- Withdraw the wheel spindle.
- Pull the rear wheel back until the brake caliper support is suspended freely between the brake disc and rim.



Warning

Danger of accidents Reduced braking efficiency due to damaged brake discs.

- Always lay down the wheel in such a way that the brake discs are not damaged.

- Take the rear wheel carefully out of the swingarm without damaging the rim and/or brake disc.

**Info**

Do not operate the foot brake when the rear wheel is removed.

Installing the rear wheel

**Warning**

Danger of accidents Reduced braking efficiency due to oil or grease on the brake discs.





- Always keep the brake discs free of oil and grease, and clean them with brake cleaner when necessary.

**Warning**

Danger of accidents No braking effect when operating the rear brake.

- After installing the rear wheel, always operate the foot brake until the pressure point is reached.

Preliminary work

- Raise the motorcycle with the rear wheel stand. ( p. 69)
- Remove the rear wheel.  ( p. 99)
- Check the rear hub shock absorbers.  ( p. 104)

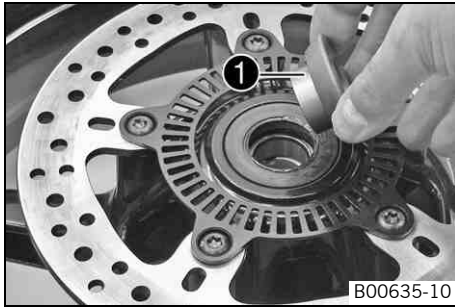

Main work

- Check the wheel bearing for damage and wear.
 - » If the wheel bearing is damaged or worn:
 - Replace the wheel bearing. 🛠️
- Remove bushing ❶. Clean and grease the mating surfaces of the bushing and the shaft seal ring.

Long-life grease (🛠️ p. 196)

- Install the bushing.
- Clean and grease the thread of the wheel spindle and nut.

Long-life grease (🛠️ p. 196)

- Clean the fixing locations on the brake caliper support and swingarm.

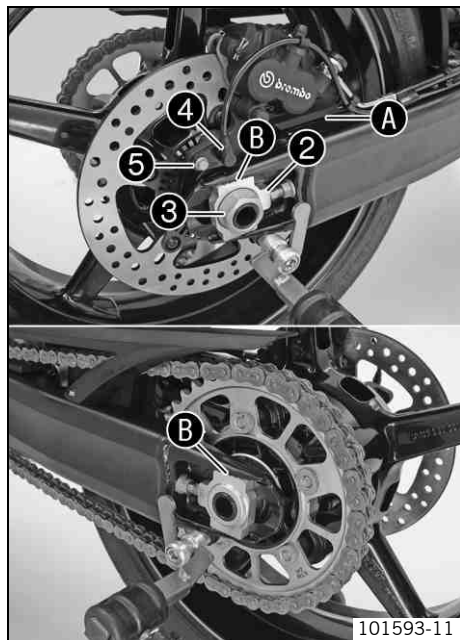

- Engage the counter bearing of the brake caliper support **A** and swingarm. Carefully lift the rear wheel into the swingarm and engage the brake disc. Lay the chain on the rear sprocket and mount the wheel spindle.
- Mount chain adjuster **2** and nut **3**.

i Info

Mount the left and right chain adjusters in the same position.

- Push the rear wheel forward so that the chain adjusters are in contact with the adjusting screws, and tighten the nut.

Guideline

In order for the rear wheel to be correctly aligned, the markings on the left and right chain adjusters must be in the same position relative to reference marks **B**.

Nut, rear wheel spindle	M25x1.5	90 Nm (66.4 lbf ft)	Thread greased
-------------------------	---------	------------------------	----------------

- Insert wheel speed sensor **4** into the hole. Mount and tighten screw **5**.

Guideline

Screw, wheel speed sensor	M6	6 Nm (4.4 lbf ft)	Loctite® 243™
---------------------------	----	----------------------	----------------------

- Operate the foot brake lever repeatedly until the brake linings lie on the brake disc and there is a pressure point.

Subsequent work

- Take the motorcycle off of the rear wheel stand. (🔧 p. 69)
- Check the chain tension. (🔧 p. 76)

Checking rear hub shock absorbers 🛠️

i Info

The engine power is transmitted by the rear sprocket to the rear wheel through five shock absorbers. They eventually wear out during operation. If the shock absorbers are not changed in time, the rear sprocket carrier and the rear hub are damaged.

Preliminary work

- Raise the motorcycle with the rear wheel stand. (🔧 p. 69)
- Remove the rear wheel. 🛠️ (🔧 p. 99)

Main work

- Remove the rear sprocket carrier.
- Check the rear hub for damage and wear.
 - » If the rear hub shock absorbers are damaged or worn:
 - Change the rear hub shock absorber. 🛠️
- Position the rear sprocket carrier.

i Info

A set of bolts and shock absorbers should have as little free travel as possible to increase the service life of the shock absorbers.

Subsequent work

- Install the rear wheel. 🛠️ (🔧 p. 101)
- Take the motorcycle off of the rear wheel stand. (🔧 p. 69)
- Check the chain tension. (🔧 p. 76)



Checking the tire condition



Warning

Danger of accidents Uncontrollable vehicle handling in the event of a flat tire.

- In the interest of safety, replace damaged or worn tires immediately. (Your authorized KTM workshop will be glad to help.)



Warning

Danger of crashing Poor vehicle handling due to different tire tread patterns on front and rear wheels.

- The front and rear wheels must be fitted with tires with similar tread patterns to prevent loss of control over the vehicle.



Warning

Danger of accidents Uncontrollable handling characteristic due to non-approved and/or non-recommended tires/wheels.

- Only tires/wheels approved by KTM and with the corresponding speed index should be used.



Warning

Danger of accidents Reduced road grip with new tires.

- New tires have a smooth rolling surface and therefore cannot provide full road grip. The entire rolling surface must be roughened in the first 200 kilometers (124.3 miles) by moderate riding at alternating angles. The full grip levels are not achieved until the tires have been run in.



Info

The type, condition and air pressure of the tires all have a major impact on the handling of the motorcycle. Worn tires have a negative effect on vehicle handling, especially on wet surfaces.

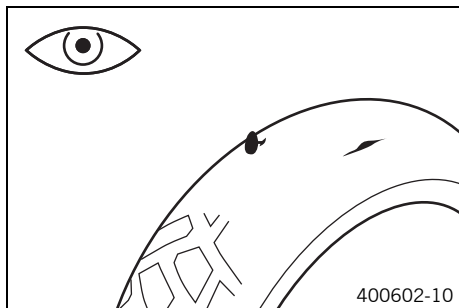

- Check the front and rear tires for cuts, run-in objects and other damage.
 - » If the tires exhibit cuts, run-in objects or other damage:
 - Change the tires.
- Check the depth of the tread.

i **Info**

Note local national regulations concerning the minimum tread depth.

Minimum tread depth	$\geq 2 \text{ mm } (\geq 0.08 \text{ in})$
---------------------	---

- » If the tread depth is less than the minimum permissible depth:
 - Change the tires.
- Check the age of the tires.

i **Info**

The tire's date of manufacture is usually part of the tire markings and is indicated by the last four digits of the **DOT** marking. The first two digits refer to the week of manufacture and last two digits refer to the year of manufacture. KTM recommends that the tires be changed after 5 years at the latest, regardless of the actual state of wear.

-
- » If a tire is more than five years old:
 - Change the tires.

Checking the tire air pressure

i **Info**

Low tire air pressure leads to abnormal wear and overheating of the tire. Correct tire air pressure ensures optimal riding comfort and maximum tire service life.

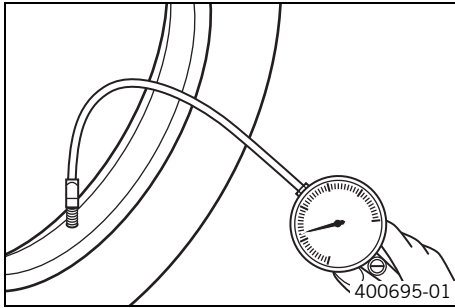

- Remove the dust cap.
- Check the tire air pressure when the tires are cold.

Tire air pressure, solo	
Front	2.4 bar (35 psi)
Rear	2.4 bar (35 psi)

Tire air pressure with passenger/full payload	
Front	2.4 bar (35 psi)
Rear	2.6 bar (38 psi)

- » If the tire pressure does not meet specifications:
 - Correct the tire pressure.
- Mount the dust cap.

i **Info**

The rubber seal in the dust cap prevents air from leaking out of the tire if the valve is faulty.

Removing the battery



Warning

Risk of injury Battery acid and battery gases cause serious chemical burns.

- Keep batteries out of the reach of children.
- Wear suitable protective clothing and goggles.
- Avoid contact with battery acid and battery gases.
- Keep the battery away from sparks or open flames. Charge only in well-ventilated areas.
- In the event of skin contact, rinse with large amounts of water. If battery acid gets in the eyes, rinse with water for at least 15 minutes and contact a physician.



Caution

Danger of accidents If the vehicle is operated with a discharged battery or without a battery, electronic components and safety equipment may be damaged.

- Never operate the vehicle with a discharged battery or without a battery.

Preliminary work

- Switch off all power consumers and the engine.
- Remove the seat. ( p. 70)

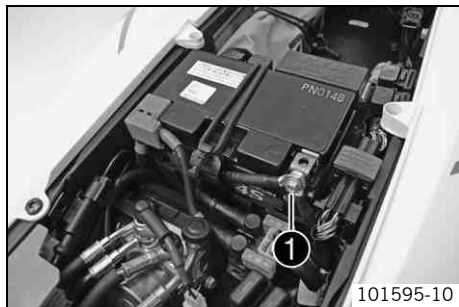

Main work

- Disconnect negative (minus) cable ❶ of the battery.

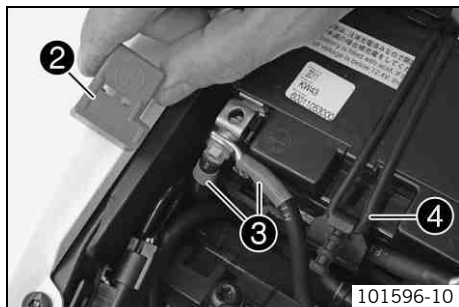

- Remove positive terminal cover ❷.
- Disconnect the positive (plus) cable ❸ of the battery.
- Detach rubber band ❹.
- Pull the battery up and out of the battery rack.

Installing the battery ↩

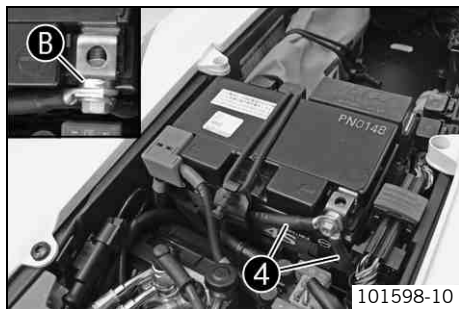
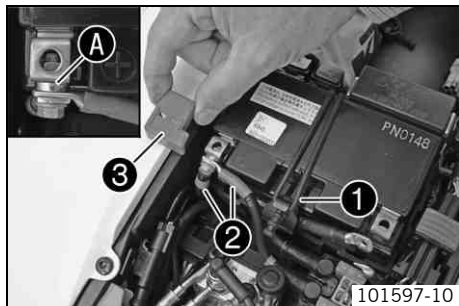
**Main work**

- Position the battery in the battery rack.

**Info**

The terminals of the battery must face in the direction of travel.

- Attach rubber band ①.
- Position washer ① and detach positive cable ② of the battery.
- Position positive terminal cover ③.
- Position washer ③ and detach negative cable ④ of the battery.

Subsequent work

- Mount the seat. (↩ p. 71)
- Set the clock. (↩ p. 29)

Recharging the battery



Warning

Risk of injury Battery acid and battery gases cause serious chemical burns.

- Keep batteries out of the reach of children.
- Wear suitable protective clothing and goggles.
- Avoid contact with battery acid and battery gases.
- Keep the battery away from sparks or open flames. Charge only in well-ventilated areas.
- In the event of skin contact, rinse with large amounts of water. If battery acid gets in the eyes, rinse with water for at least 15 minutes and contact a physician.



Warning

Environmental hazard The battery contains elements that are harmful to the environment.

- Do not discard batteries with the household trash. Dispose of a defective battery in an environmentally compatible manner. Give the battery to your KTM dealer or to a recycling center that accepts used batteries.



Warning

Environmental hazard Hazardous substances cause environmental damage.

- Oil, grease, filters, fuel, cleaners, brake fluid, etc., should be disposed of as stipulated in applicable regulations.



Info

Even when there is no load on the battery, it discharges steadily.

The charge state and the type of charge are very important for the service life of the battery.

Rapid recharging with a high charging current shortens the battery's service life.

If the charging current, charging voltage and charging time are exceeded, electrolyte escapes through the safety valves. This reduces the battery capacity.

If the battery is depleted from starting the vehicle repeatedly, the battery must be charged immediately.

If the battery is left in a discharged state for an extended period, it will become over-discharged and sulfate, destroying the battery.

The battery is maintenance-free, i.e., the acid level does not have to be checked.

Preliminary work

- Switch off all power consumers and switch off the engine.
- Remove the seat. (🔧 p. 70)
- Disconnect the negative (minus) cable of the battery to avoid damage to the motorcycle's electronics.

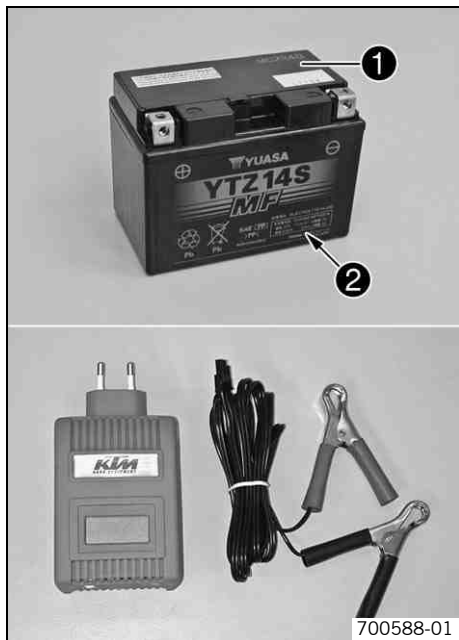

Main work

- Connect the battery charger to the battery. Switch on the battery charger.

Battery charger (58429074000)

You can also use the battery charger to test the rest potential and start potential of the battery, and to test the alternator. With this device, you cannot overcharge the battery.

i Info

Never remove lid ①.

Charge the battery to no more than 10% of the capacity specified on battery housing ②.

- Switch off the charger after charging. Reconnect the battery.

Guideline

The charge current, charge voltage and charge time must not be exceeded.	
Charge the battery regularly when the motorcycle is not in use	3 months

Subsequent work

- Mount the seat. (👉 p. 71)

Changing the main fuse



Warning

Fire hazard The electrical system can be overloaded if the wrong fuses are used.

- Use only fuses with the prescribed amperage. Never by-pass or repair fuses.

i Info

The main fuse protects all power consumers of the vehicle. The main fuse is under the seat.

Preliminary work

- Switch off all power consumers and the engine.
- Remove the seat. (👉 p. 70)

Main work

- Remove protection covers ❶.
- Remove the faulty main fuse ❷.

i Info

A defective fuse can be identified by the burned-out fuse wire **A**.
A reserve fuse **3** is located in the starter relay.

- Install a new main fuse.

Fuse (58011109130) (👉 p. 183)

i Tip

Place the spare fuse in the starter relay so that it is available if needed.

- Attach the protection covers ❶.

Follow-up work

- Mount the seat. (👉 p. 71)

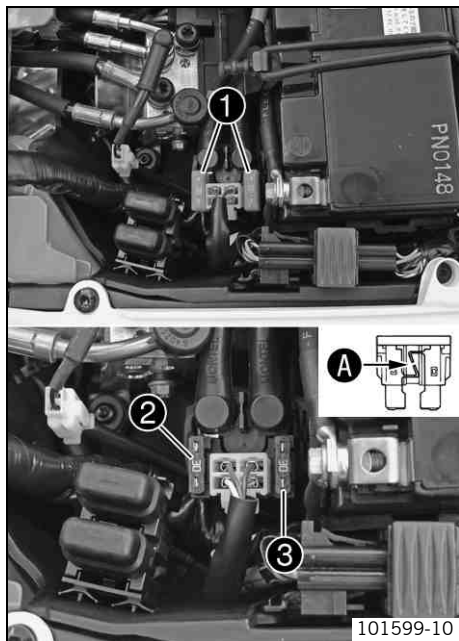

Changing the ABS fuses



Warning

Fire hazard The electrical system can be overloaded if the wrong fuses are used.

- Use only fuses with the prescribed amperage. Never by-pass or repair fuses.



Info

Two fuses for the ABS are located under the seat. These fuses protect the return pump and the hydraulic unit of the ABS. The third fuse, which protects the ABS control unit, is located in the fuse box.

Preliminary work

- Switch off all power consumers and switch off the engine.
- Remove the seat. (👉 p. 70)

To change the fuse of the ABS hydraulic unit:

- Take off the protection cap and remove fuse ❶.
- Insert the new fuse.

Fuse (58011109130)

- Check that the ABS warning lamp still lights up.
- Mount the protection cap.

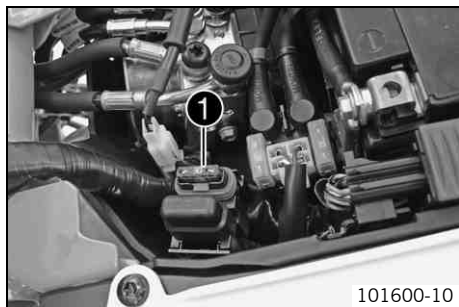

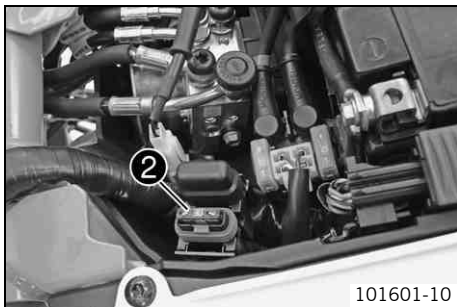

To change the fuse of the ABS return pump:

- Take off the protection cap and remove fuse ②.
- Insert the new fuse.

Fuse (58011109130)

- Check that the ABS warning lamp still lights up.
- Mount the protection cap.

Follow-up work

- Mount the seat. (👉 p. 71)

Changing the fuses of individual power consumers



Warning

Fire hazard The electrical system can be overloaded if the wrong fuses are used.

- Use only fuses with the prescribed amperage. Never by-pass or repair fuses.



Info

The fuse box containing the fuses of individual power consumers is located under the seat.

Preliminary work

- Switch off all power consumers and switch off the engine.
- Remove the seat. (👉 p. 70)

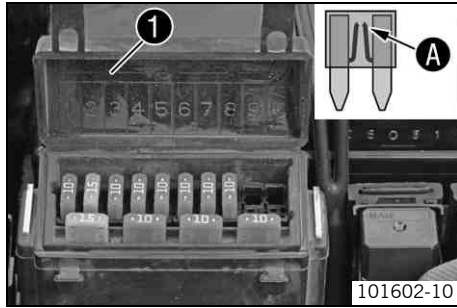

Main work

- Open fuse box cover **1**.
- Check the fuses.

Info

A faulty fuse can be identified by the burned-out fuse wire **A**.

- Remove the faulty fuse.

Guideline

Fuse 1 - 10 A - ignition, fuel pump, hazard warning flasher
Fuse 2 - 15 A - high beam, low beam, parking light, tail light, license plate lamp
Fuse 3 - 10 A - horn, brake light, turn signal
Fuse 4 - 10 A - radiator fan
Fuse 5 - 10 A - ignition (EFI control unit), immobilizer
Fuse 6 - 10 A - combination instrument, auxiliary equipment (permanent positive), alarm system (optional), socket
Fuse 7 - 10 A - supplementary equipment (accessories connected to the ignition switch)
Fuse 8 - 10 A - ABS
Fuse 9 - not used
Fuse 10 - not used
Fuse SPARE - 10 A/15 A - spare fuses

- Use spare fuses with the correct rating only.

Fuse (75011088010) (☞ p. 183)
Fuse (75011088015) (☞ p. 183)

**Tip**

Insert a spare fuse so that it is available if needed.

- Close the fuse box cover.

Follow-up work

- Mount the seat. (👉 p. 71)

Changing the headlight bulb

Note

Damage to reflector Reduced luminance.

- Grease on the lamp will evaporate due to the heat and be deposited on the reflector. Clean the lamp and keep it free of grease before mounting.

Preliminary work

- Switch off all power consumers and the engine.
- Remove screws ❶.

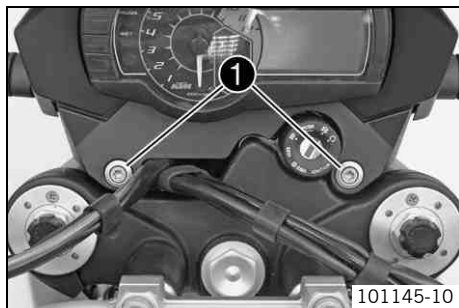

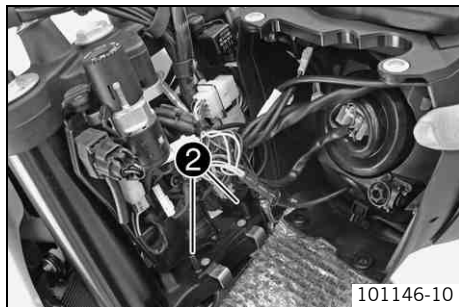

- Cover the fender with a cloth.
- Swing the headlight mask forward and pull it upward out of holding lugs ②.

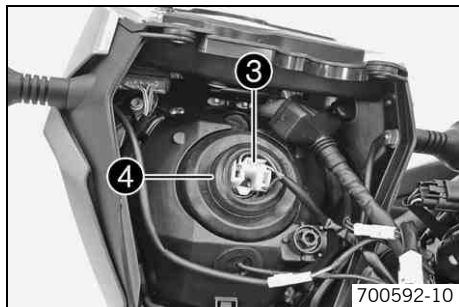

- Disconnect connector ③.
- Remove rubber cap ④.

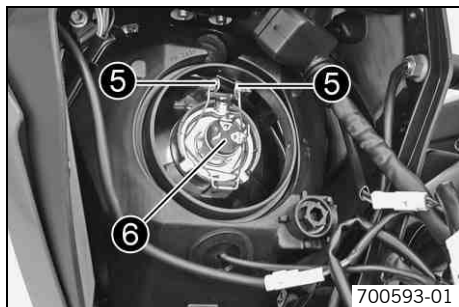

- Push off retaining clamp ⑤ on both sides, squeeze and fold down.
- Remove headlight bulb ⑥.
- Position the new headlight bulb in the headlight housing.

Low beam/high beam (H4/socket P43t) (☛ p. 183)

i Info

Insert the headlight bulb so that the bayonet lugs latch into the slots.

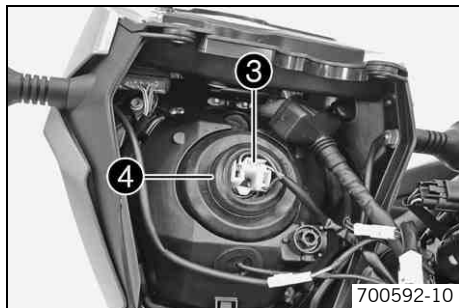

- Position the retaining clamp.
- Mount rubber cap ④.
- Plug in connector ③.

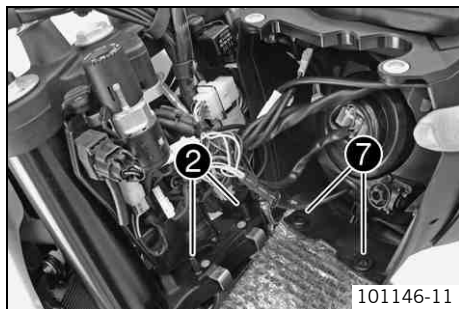

- Position holes ⑦ onto holding lugs ②.

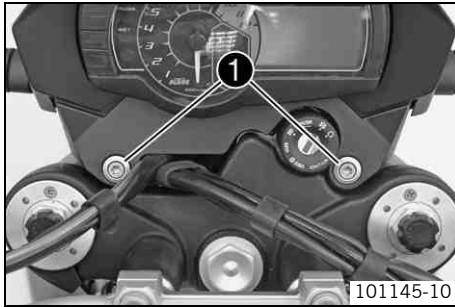

- Position the headlight mask. Mount and tighten screws ❶.

Guideline

Remaining chassis screws	M6	10 Nm (7.4 lbf ft)
--------------------------	----	--------------------

- Check that the lighting is functioning properly.

Changing the parking light bulb

Note

Damage to reflector Reduced luminance.

- Grease on the lamp will evaporate due to the heat and be deposited on the reflector. Clean the lamp and keep it free of grease before mounting.

Preliminary work

- Switch off all power consumers and the engine.
- Remove screws ❶.

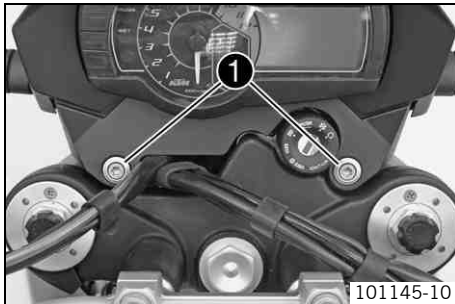

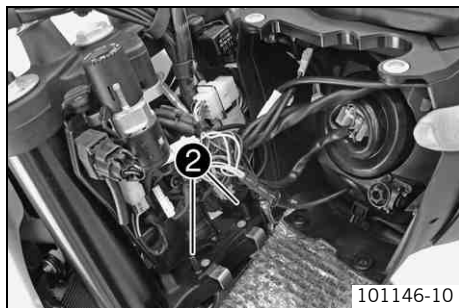

- Cover the fender with a cloth.
- Swing the headlight mask forward and pull it upward out of holding lugs ②.

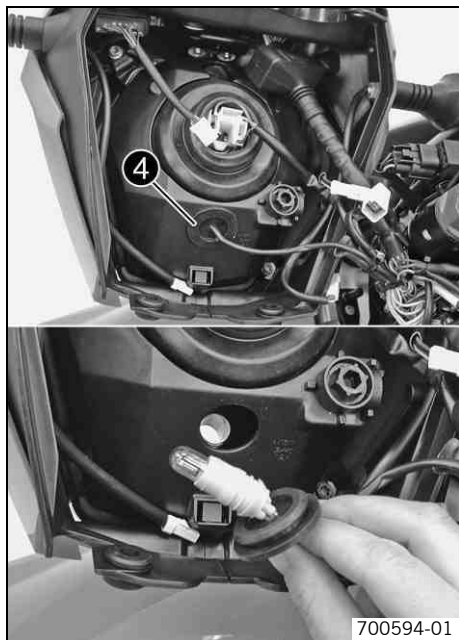

- Pull the parking light ④ carefully out of the holder.
- Remove the bulb.
- Position a new light bulb in the holder.

Parking light (W5W/socket W2.1x9.5d) (☛ p. 183)

- Carefully position the holder with the bulb into the holder in the headlight.

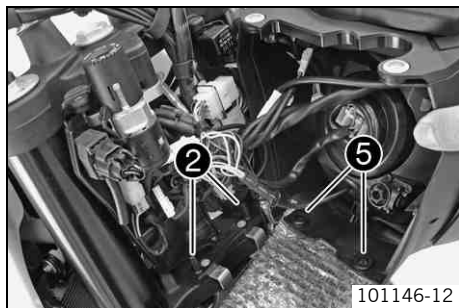

- Position holes ⑤ onto holding lugs ②.

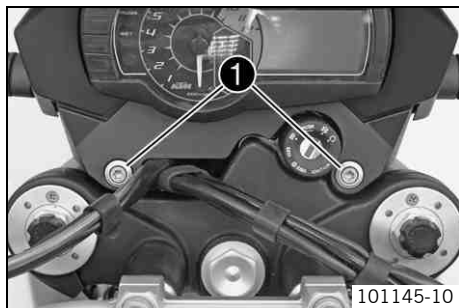

- Position the headlight mask. Mount and tighten screws ①.

Guideline

Remaining chassis screws	M6	10 Nm (7.4 lbf ft)
--------------------------	----	--------------------

- Check that the lighting is functioning properly.

Changing the turn signal bulb

Note

Damage to reflector Reduced luminance.

- Grease on the lamp will evaporate due to the heat and be deposited on the reflector. Clean the lamp and keep it free of grease before mounting.

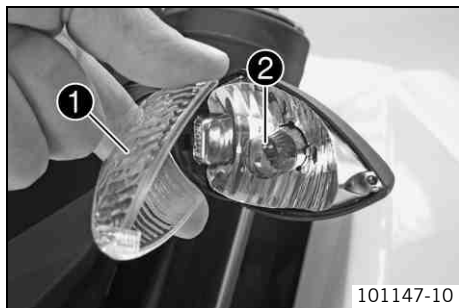

- Remove the screw on the rear of the turn signal housing.
- Carefully remove diffuser ❶.
- Press bulb ❷ carefully into the socket, turn it counterclockwise by about 30°, and pull it out of the socket.
- Press the new bulb carefully into the socket and turn it clockwise until it stops.

Turn signal (RY10W/socket BAU15s) (☛ p. 184)

- Check the turn signal to make sure it is functioning properly.
- Position the diffuser.
- Insert the screw and first turn it counterclockwise until it engages in the thread. Tighten the screw slightly.

Changing the brake light bulb

Note

Damage to reflector Reduced luminance.

- Grease on the lamp will evaporate due to the heat and be deposited on the reflector. Clean the lamp and keep it free of grease before mounting.

Preliminary work

- Remove the seat. (☛ p. 70)

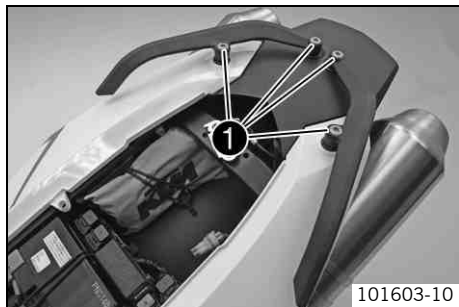

Main work

- Remove screws ❶.
- Remove the grab handles.

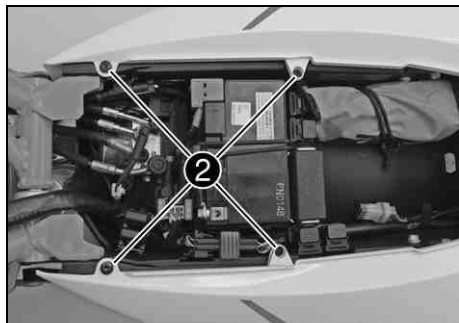

- Remove screws ❷.
- Remove screws ❸ on the left and right rear side part.
- Remove the rear side part.

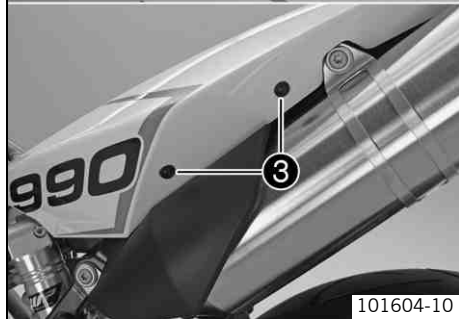

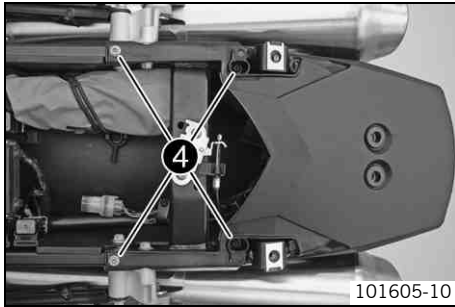

- Remove screws ④.
- Remove the top part.

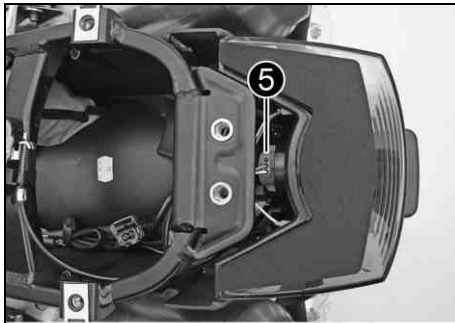

- Turn bulb socket ⑤ counterclockwise all the way and take it out of the tail light.
- Push the bulb carefully into the socket, turn it counterclockwise and pull it out of the socket.
- Press the new bulb carefully into the socket and turn it clockwise until it stops.

Brake light (PR21W/socket BAW15s) (☛ p. 184)

- Insert the bulb socket into the tail light and turn clockwise until it stops.
- Check that the brake light system is functioning properly.

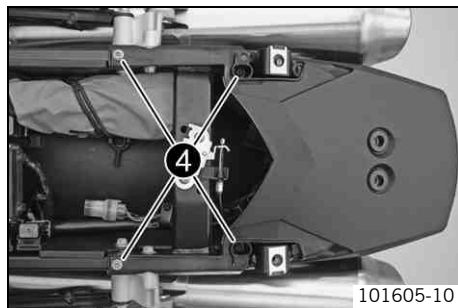

- Position the rear top part.
- Mount and tighten screws ④.

Guideline

Remaining chassis screws	M6	10 Nm (7.4 lbf ft)
--------------------------	----	--------------------

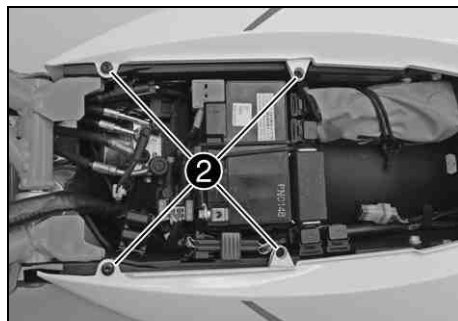

- Position the rear side parts.
- Mount and tighten screws ②.

Guideline

Remaining chassis screws	M5	5 Nm (3.7 lbf ft)
Remaining frame bolts	EJOT PT K50x12 T20	1.2 Nm (0.89 lbf ft)

- Mount and tighten screws ③ on the left and right rear side part.

Guideline

Remaining frame bolts	EJOT PT K50x12 T20	1.2 Nm (0.89 lbf ft)
-----------------------	-----------------------	-------------------------

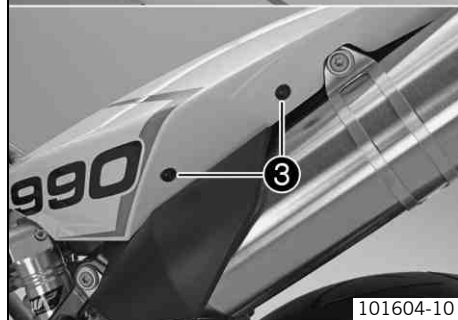

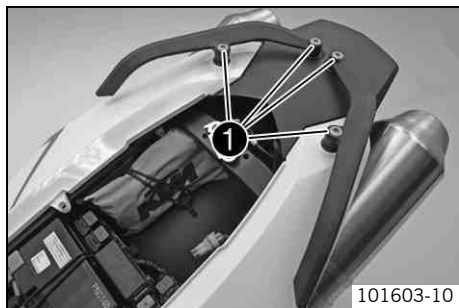

- Position the grab handles.
- Mount and tighten screws ❶.

Guideline

Screw, handrail	M8	20 Nm (14.8 lbf ft)
-----------------	----	------------------------

Follow-up work

- Mount the seat. (🔧 p. 71)

Changing the tail light bulbs

Note

Damage to reflector Reduced luminance.

- Grease on the lamp will evaporate due to the heat and be deposited on the reflector. Clean the lamp and keep it free of grease before mounting.

Preliminary work

- Remove the seat. (🔧 p. 70)

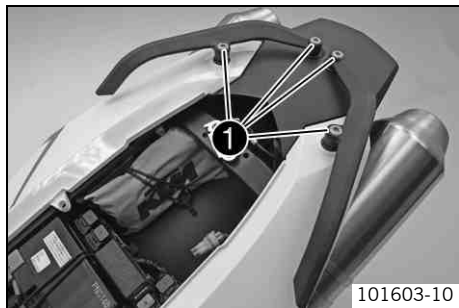

Main work

- Remove screws ❶.
- Remove the grab handles.

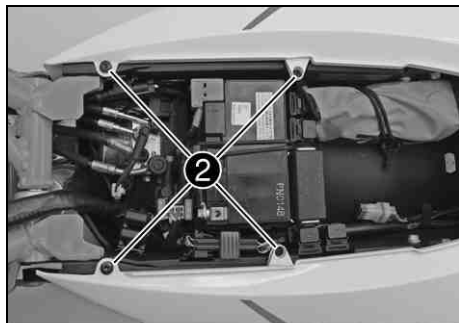

- Remove screws ❷.
- Remove screws ❸ on the left and right rear side part.
- Remove the rear side part.

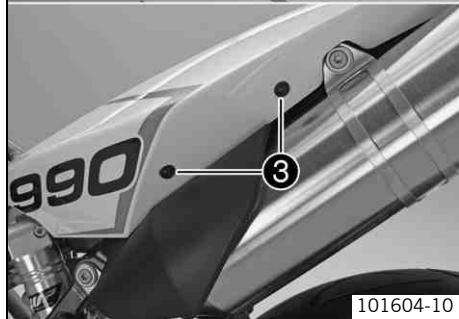

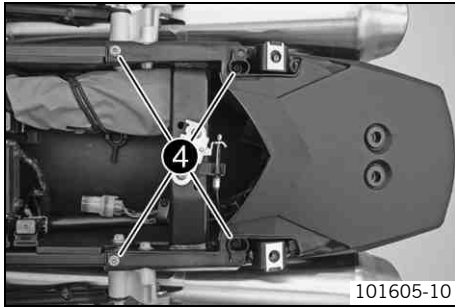

- Remove screws ④.
- Remove the top part.

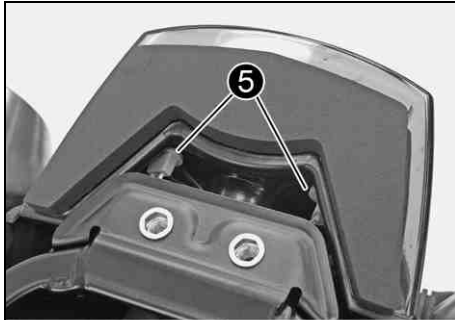

- Pull bulb holders ⑤ carefully out of the bracket.
- Remove the bulb.
- Position a new light bulb in the holder.

Tail light (WR5W/socket W2.1x9.5d) (☛ p. 184)

- Carefully position the holders with the bulbs into the holder in the tail light.
- Check that the tail light bulbs are functioning properly.



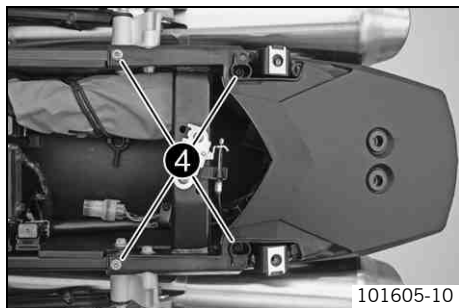

- Position the rear top part.
- Mount and tighten screws ④.

Guideline

Remaining chassis screws	M6	10 Nm (7.4 lbf ft)
--------------------------	----	--------------------

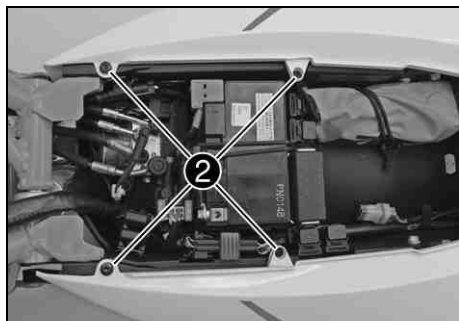

- Position the rear side parts.
- Mount and tighten screws ②.

Guideline

Remaining chassis screws	M5	5 Nm (3.7 lbf ft)
Remaining frame bolts	EJOT PT K50x12 T20	1.2 Nm (0.89 lbf ft)

- Mount and tighten screws ③ on the left and right rear side part.

Guideline

Remaining frame bolts	EJOT PT K50x12 T20	1.2 Nm (0.89 lbf ft)
-----------------------	-----------------------	-------------------------

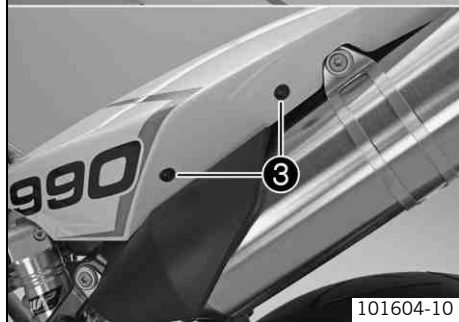

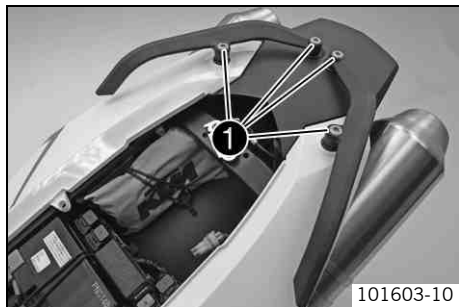

- Position the grab handles.
- Mount and tighten screws ❶.

Guideline

Screw, handrail	M8	20 Nm (14.8 lbf ft)
-----------------	----	------------------------

Follow-up work

- Mount the seat. (👉 p. 71)

Changing the license plate lamp

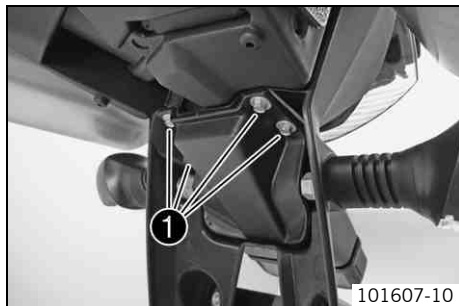

Main work

- Remove screws ❶.
- Remove the license plate lamp cover.

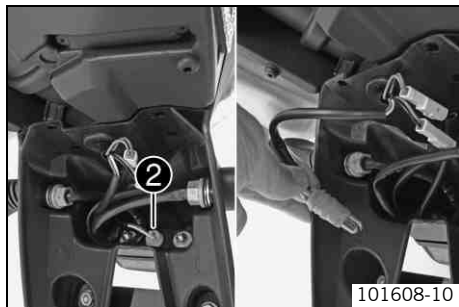

- Pull holder ② carefully out of the bracket.
- Remove the bulb.
- Position a new light bulb in the holder.

License plate lamp (W5W/socket W2.1x9.5d) (☛ p. 184)

- Carefully position the holder with the bulb into the bracket.

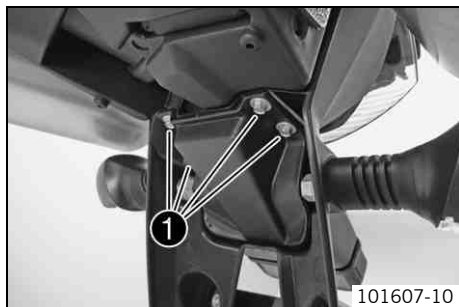

- Position the cover.
- Mount and tighten screws ①.

Follow-up work

- Check that the license plate lamp is functioning properly.

Checking the headlight setting

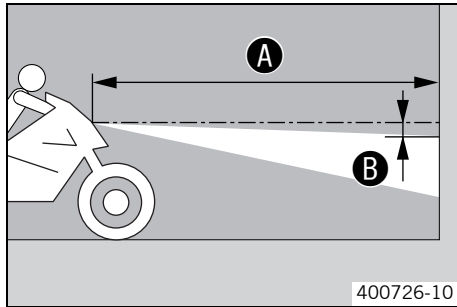

- Park the vehicle on a horizontal surface in front of a light-colored wall and make a mark at the level of the center of the headlight.
- Make another mark at a distance of **B** under the first mark.

Guideline

Distance B	5 cm (2 in)
-------------------	-------------

- Park the vehicle at a distance of **A** vertically in front of the wall and switch on the low beam headlight.

Guideline

Distance A	5 m (16 ft)
-------------------	-------------

- The rider, with luggage and passenger if applicable, now mounts the motorcycle.
- Check the headlight setting.

The light-dark boundary must lie exactly on the lower mark when the motorcycle is ready to operate with the rider mounted along with any luggage and a passenger if applicable.

- » If the boundary between light and dark does not meet specifications:
 - Adjust the headlight range. (☛ p. 134)

Adjusting the headlight range

Preliminary work

- Check the headlight setting. (☛ p. 134)

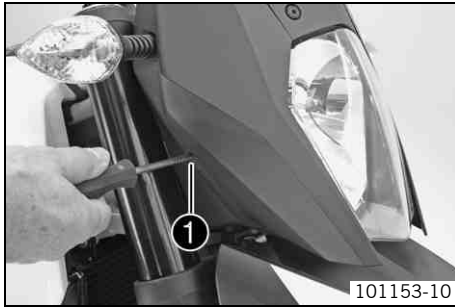

- Turn screw ❶ to adjust the headlight range.

Guideline

For a motorcycle with rider, and with luggage and a passenger if applicable, the light/dark boundary must be exactly on the lower mark (applied in: Checking the headlight adjustment).



Info

Turn clockwise to increase the headlight range; turn counterclockwise to reduce the headlight range.

Activating/deactivating the ignition key



Info

The orange programming key must only be used for activating and deactivating!

If a black ignition key is lost or replaced, the black ignition keys must be individually activated/deactivated using the orange programming key. This will also prevent the vehicle from being operated without authorization with the lost black ignition key. You can activate or deactivate up to four black ignition keys. Only the black ignition keys programmed during an activation procedure are valid. All black ignition keys not programmed during the activation procedure are invalid, but can be reprogrammed in a further activation procedure.

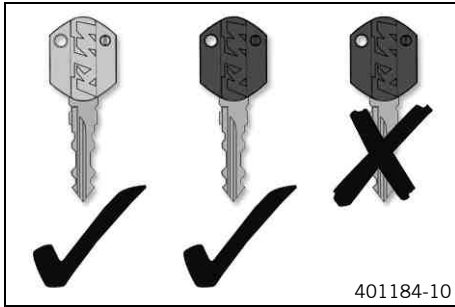

Loss of a black ignition key (second black ignition key available):

The following procedure deactivates all activated black ignition keys that are not included in the procedure.

- Press the emergency OFF switch into the position ○.



- Insert the orange programming key in the ignition lock.
- Switch on the ignition by turning the orange programming key to the **ON** ○ position.
 - ✓ FI warning lamp ① (MIL) lights up, switches off, and then starts to flash.
 - ✓ Immobilizer indicator lamp ② lights up.
- Switch off the ignition by turning the orange programming key to the **OFF** ⊗ position.
- Pull out the orange programming key.
- Insert the black ignition key in the ignition lock.
- Switch on the ignition by turning the ignition key to the **ON** ○ position.
 - ✓ FI warning lamp ① (MIL) lights up, switches off, and then starts to flash.
 - ✓ The immobilizer indicator lamp ② lights up, switches off briefly, and switches on again.
- Switch off the ignition by turning the ignition key to the **OFF** ⊗ position.
- Remove the black ignition key.
- Insert the orange programming key in the ignition lock.
- Switch on the ignition by turning the orange programming key to the **ON** ○ position.
 - ✓ FI warning lamp ① (MIL) lights up, switches off, and then starts to flash.

- ✓ Immobilizer indicator lamp ⑥ lights up, switches off briefly and flashes; the number of flashes equals the number of functional black ignition keys including the orange programming key. In this case, twice.
- Switch off the ignition by turning the orange programming key to the **OFF** position ☒.
- Pull out the orange programming key.
- ✓ The lost black ignition key is deactivated.
- ✓ The existing black ignition key is reactivated.

Loss of both black ignition keys (no black ignition key available):

This procedure is important to prevent misuse of the lost black ignition key.

- Press the emergency OFF switch into the position ○.

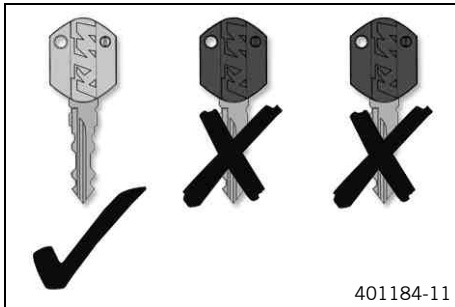



- Insert the orange programming key in the ignition lock.
- Switch on the ignition by turning the orange programming key to the **ON** position ○.
- ✓ FI warning lamp ⑥ (MIL) lights up, switches off, and then starts to flash.
- ✓ Immobilizer indicator lamp ⑥ lights up.
- Switch off the ignition by turning the orange programming key to the **OFF** position ☒.
- Switch on the ignition by turning the orange programming key to the **ON** position ○.
- ✓ FI warning lamp ⑥ (MIL) lights up, switches off, and then starts to flash.
- ✓ Immobilizer indicator lamp ⑥ lights up, switches off briefly and flashes; the number of flashes equals the number of functional black ignition keys including the orange programming key. In this case once, since all black ignition keys are deactivated.



- Switch off the ignition by turning the orange programming key to the **OFF** position ☒.
- Pull out the orange programming key.
 - ✓ All black ignition keys are deactivated.
- Order a new black ignition key according to the key number on the **KEYCODECARD** and activate it.

Activating the ignition key:

- Press the emergency OFF switch into the position ○.
- Insert the orange programming key in the ignition lock.
- Switch on the ignition by turning the orange programming key to the **ON** position ○.
 - ✓ FI warning lamp ⑥ (**MIL**) lights up, switches off, and then starts to flash.
 - ✓ Immobilizer indicator lamp ④ lights up.
- Switch off the ignition by turning the orange programming key to the **OFF** position ☒.
- Pull out the orange programming key.
- Insert the black ignition key in the ignition lock.
- Switch on the ignition by turning the ignition key to the **ON** ○ position.
 - ✓ FI warning lamp ⑥ (**MIL**) lights up, switches off, and then starts to flash.
 - ✓ The immobilizer indicator lamp ④ lights up, switches off briefly, and lights up again.
- Switch off the ignition by turning the ignition key to the **OFF** ☒ position.
- Remove the black ignition key.
- To activate further ignition keys, repeat the last 4 steps with the respective ignition key.
- Insert the orange programming key into the ignition lock.
- Switch on the ignition by turning the orange programming key to the **ON** position ○.
 - ✓ FI warning lamp ⑥ (**MIL**) lights up, switches off, and then starts to flash.

- ✓ The immobilizer indicator lamp  lights up, switches off briefly and flashes; the number of flashes equals the number of functional black ignition keys including the orange programming key.
- Switch off the ignition by turning the orange programming key to the **OFF** position .
- Pull out the orange programming key.
- ✓ All black ignition keys are activated included in this job sequence are activated.

Cooling system

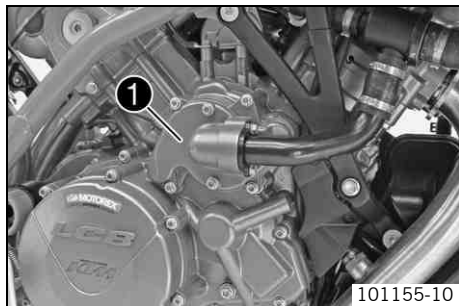

The water pump ❶ in the engine forces the coolant to flow.

The pressure in the cooling system resulting from heat is regulated by a valve in the radiator cap. This permits the specified coolant temperature without causing any malfunctions.

125 °C (257 °F)

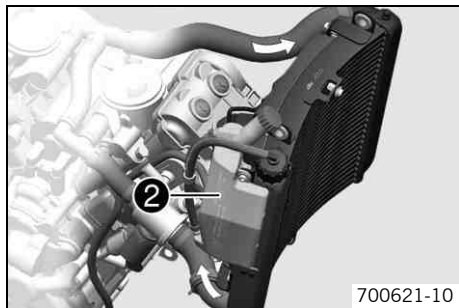

Cooling takes place by means of the air stream and a radiator fan, which is controlled by a thermostat.

The lower the speed, the less the cooling effect. Dirty cooling fins also reduce the cooling effect.

The heat expansion causes the surplus coolant to flow into the compensating tank ❷. When the temperature falls, this surplus coolant is sucked back into the cooling system.

Checking the antifreeze and coolant level



Warning

Danger of scalding During motorcycle operation, the coolant gets very hot and is under pressure.

- Do not remove the radiator cap, radiator hoses or other cooling system components when the engine is hot. Allow the engine and cooling system to cool down. In case of scalding, rinse immediately with lukewarm water.



Warning

Danger of poisoning Coolant is poisonous and a health hazard.

- Avoid contact between coolant and skin, eyes and clothing. If it gets into your eyes, rinse immediately with water and contact a doctor. Wash affected skin areas immediately with soap and water. If coolant is swallowed, contact a doctor immediately. Change clothes that have come into contact with coolants. Keep coolant out of the reach of children.

Condition

The engine is cold.

Preliminary work

- Stand the motorcycle upright on a horizontal surface.
- Remove the seat. (🔧 p. 70)
- Reset the fuel tank. (🔧 p. 72)

Main work

- Remove radiator cap ❶ and plug ❷ from the compensating tank.
- Check the coolant antifreeze.

-25... -45 °C (-13... -49 °F)

- » If the coolant antifreeze does not meet specifications:
 - Correct the coolant antifreeze.

- Check the coolant level in the compensating tank.

The coolant level must be between the upper marking ❸ and lower marking ❹.

- » If the coolant level in the compensating tank does not meet specifications, but the tank is not empty:
 - Add coolant to the upper marking.

Alternative 1

Coolant (🔧 p. 191)

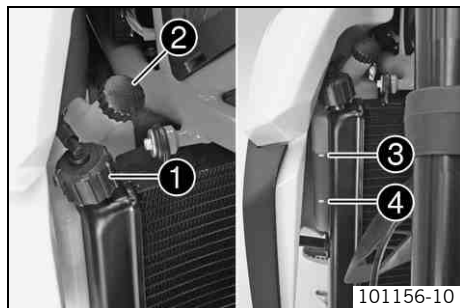

Alternative 2

Coolant (mixed ready to use) (☞ p. 191)

- » If there is no coolant in the compensating tank:
 - Check the cooling system for leaks. 🛠️



Info

Do not start up the motorcycle!

- Fill/bleed the cooling system. 🛠️ (☞ p. 145)
- Mount cap ❷ of the compensating tank.
- Check the coolant level in the radiator.

The radiator must be completely filled.

- » If the coolant level does not meet specifications:
 - Correct the coolant level and determine the reason for the coolant loss.

Alternative 1

Coolant (☞ p. 191)

Alternative 2

Coolant (mixed ready to use) (☞ p. 191)

- » If more coolant needed to be added than the specified value:
 - > 0.50 l (> 0.53 qt.)
 - Fill/bleed the cooling system. 🛠️ (☞ p. 145)
- Mount radiator cap ❶.

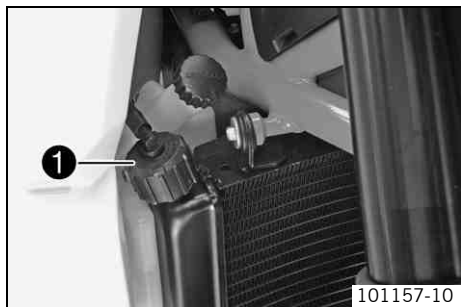

Checking the coolant level in the compensating tank



Warning

Danger of scalding During motorcycle operation, the coolant gets very hot and is under pressure.

- Do not remove the radiator cap, radiator hoses or other cooling system components when the engine is hot. Allow the engine and cooling system to cool down. In case of scalding, rinse immediately with lukewarm water.



Warning

Danger of poisoning Coolant is poisonous and a health hazard.

- Avoid contact between coolant and skin, eyes and clothing. If it gets into your eyes, rinse immediately with water and contact a doctor. Wash affected skin areas immediately with soap and water. If coolant is swallowed, contact a doctor immediately. Change clothes that have come into contact with coolants. Keep coolant out of the reach of children.

Condition

The engine is cold.

The radiator is completely full.

Preliminary work

- Stand the motorcycle on a horizontal surface.

Main work

- Check the coolant level in the compensating tank ❶.

The coolant level must be between the upper marking ❷ and lower marking ❸.

- » If the coolant level in the compensating tank does not meet specifications, but the tank is not empty:
 - Remove the compensating tank cap.
 - Add coolant to the upper marking.

Alternative 1

Coolant (👉 p. 191)

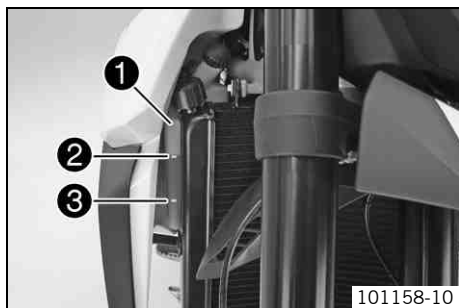

Alternative 2

Coolant (mixed ready to use) (🔧 p. 191)

- Mount the cap of the compensating tank.
- » If there is no coolant in the compensating tank:
 - Check the cooling system for leaks. 🛠️



Info

Do not start up the motorcycle!

- Fill/bleed the cooling system. 🛠️ (🔧 p. 145)

Draining the coolant 🛠️



Warning

Danger of scalding During motorcycle operation, the coolant gets very hot and is under pressure.

- Do not remove the radiator cap, radiator hoses or other cooling system components when the engine is hot. Allow the engine and cooling system to cool down. In case of scalding, rinse immediately with lukewarm water.



Warning

Danger of poisoning Coolant is poisonous and a health hazard.

- Avoid contact between coolant and skin, eyes and clothing. If it gets into your eyes, rinse immediately with water and contact a doctor. Wash affected skin areas immediately with soap and water. If coolant is swallowed, contact a doctor immediately. Change clothes that have come into contact with coolants. Keep coolant out of the reach of children.

Preliminary work

- Remove the seat. (🔧 p. 70)
- Reset the fuel tank. (🔧 p. 72)

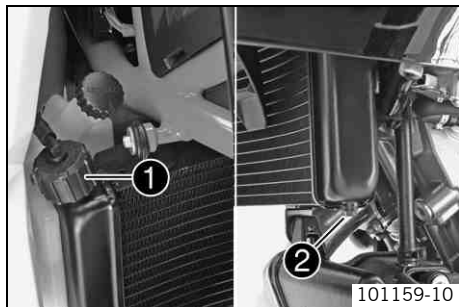

Main work

- Place a suitable container under the radiator.
- Remove radiator cap ①.
- Remove screw ②.
- Completely drain the coolant.
- Mount screw ② with a new seal ring and tighten it.

Guideline

Remaining chassis screws	M6	10 Nm (7.4 lbf ft)
--------------------------	----	--------------------

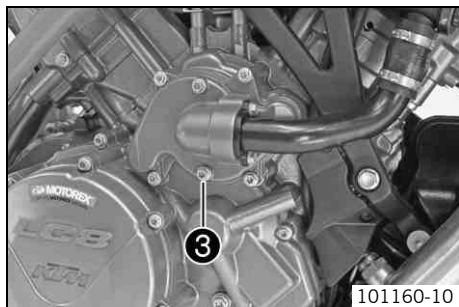

- Place a suitable container under the engine.
- Remove screw ③.
- Completely drain the coolant.
- Mount screw ③ with a new seal ring and tighten it.

Guideline

Screw, water pump cover	M6	10 Nm (7.4 lbf ft)
-------------------------	----	--------------------

Filling/bleeding the cooling system



Warning

Danger of poisoning Coolant is poisonous and a health hazard.

- Avoid contact between coolant and skin, eyes and clothing. If it gets into your eyes, rinse immediately with water and contact a doctor. Wash affected skin areas immediately with soap and water. If coolant is swallowed, contact a doctor immediately. Change clothes that have come into contact with coolants. Keep coolant out of the reach of children.

Preliminary work

- Remove the seat. (☞ p. 70)
- Reset the fuel tank. (☞ p. 72)

Main work

- Ensure that the drain plug on the radiator and the water pump cover are tightened.
- Remove bleeder screw ❶.

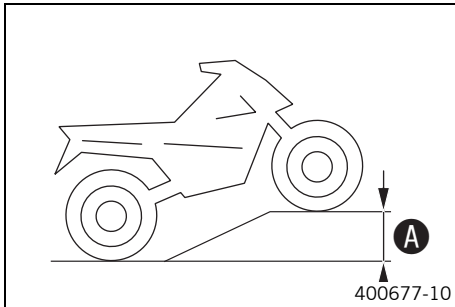
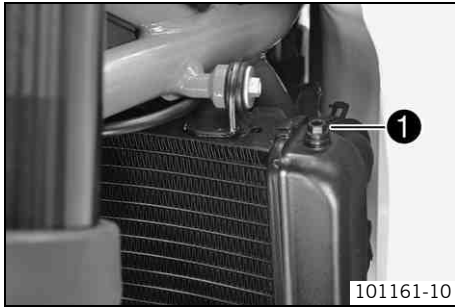

- Position the vehicle as shown and secure it against rolling. Height difference Ⓐ must be reached.

Guideline

Height difference Ⓐ	50 cm (19.7 in)
---------------------	-----------------

Info

To make sure that all of the air can escape from the cooling system, raise the front of the vehicle. A poorly bled cooling system is less effective at cooling and the engine can overheat.

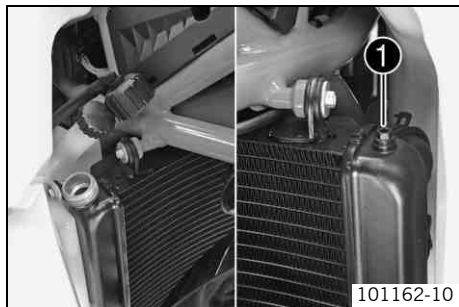

- Remove the radiator cap and pour in coolant until it emerges without bubbles at the vent hole, and then immediately mount and tighten the bleeder screw ❶.

Alternative 1

Coolant (☞ p. 191)

Alternative 2

Coolant (mixed ready to use) (☞ p. 191)

- Fill the radiator completely with coolant. Mount the radiator cap.
- Lean the vehicle on the side stand.
- Check the coolant level in the compensating tank. (☞ p. 143)



Danger

Danger of poisoning Exhaust gases are poisonous and inhaling them may result in unconsciousness and/or death.

- When running the engine, always make sure there is sufficient ventilation, and do not start or run the engine in an enclosed space without an effective exhaust extraction system.
-
- Start the engine and run it until it reaches operating temperature.
 - ✓ Six bars of the temperature display light up.
 - Stop the engine and allow it to cool down.
 - When the engine is cool, check the coolant level in the radiator and add coolant if necessary.
 - Check the coolant level in the compensating tank. (☞ p. 143)

Subsequent work

- Position the fuel tank. (☞ p. 73)
- Mount the seat. (☞ p. 71)

Checking the play in the throttle cable

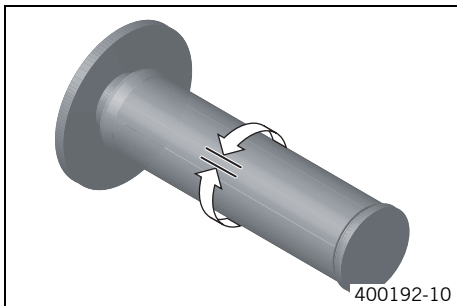

- Check the throttle grip for smooth operation.
- Move the handlebar to the straight-ahead position. Move the throttle grip backwards and forwards to ascertain the play in the throttle cable.

Play in throttle cable	3... 5 mm (0.12... 0.2 in)
------------------------	----------------------------

- » If the throttle cable play does not meet specifications:
 - Adjust the play in the throttle cable. 🛠️ (📖 p. 149)



Danger

Danger of poisoning Exhaust gases are poisonous and inhaling them may result in unconsciousness and/or death.

- When running the engine, always make sure there is sufficient ventilation, and do not start or run the engine in an enclosed space without an effective exhaust extraction system.
-
- Start the engine and let it run idle. Move the handlebar to and fro over the entire steering range.

The idle speed must not change.

- » If the idle speed changes:
 - Adjust the play in the throttle cable. 🛠️ (📖 p. 149)

Adjusting the play in the throttle cable ↩

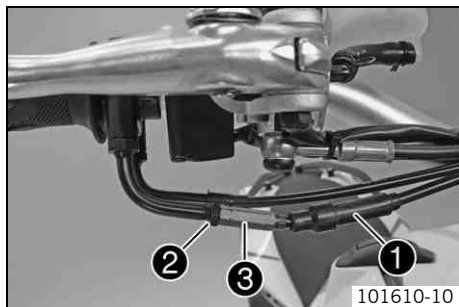

- Move the handlebar to the straight-ahead position.
- Use the KTM diagnostics tool to set the throttle stepper motor to the basic position.
- Push back sleeve ❶.
- Loosen lock nut ❷.
- Set the play in the throttle cable by turning adjusting screw ❸.

Guideline

Play in throttle cable	3... 5 mm (0.12... 0.2 in)
------------------------	----------------------------

- Tighten lock nut ❷.
- Slide on sleeves ❶.
- Check the throttle grip for ease of movement.

Ignition curve plug-in connector

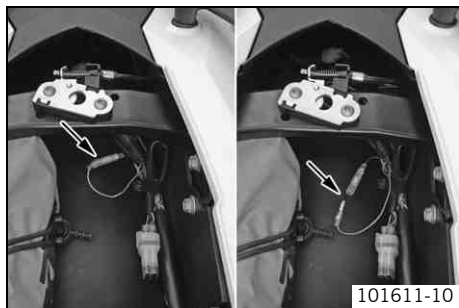

The plug-in connection is located under the seat in front of the tail light.

By disconnecting the plug-in connector, the ignition curve for fuel with an octane rating below 95 (ROZ 95/RON 95/PON 91) is activated. While the engine will have a slightly lower power output, this setting prevents engine damage by hindering spark knocking due to poor fuel quality.

Possible states

- Plug-in connector disconnected – Fuel with an octane rating of 80 to 94 (RON) can be used for one tank full.
- Plug-in connector connected – Fuel with an octane rating of 95 or higher can be used.

Adjusting the ignition curve to the fuel quality

Preliminary work

- Switch off the ignition by turning the ignition key to the **OFF** ☒ position.
- Remove the seat. (🔧 p. 70)

To activate the ignition curve for low octane fuel:

Note

Engine failure Low-quality fuel damages the engine.

- Operate the vehicle with fuel with an octane rating below 95 (ROZ 95/RON 95/PON 91) for no more than one tank full.
 - The ignition curve must be adjusted to low octane fuel.
-

- Disconnect the plug-in connector.

✓ Plug-in connector disconnected – Fuel with an octane rating of 80 to 94 (RON) can be used for one tank full. (🔧 p. 149)

Activate the ignition curve for fuel with an octane rating of 95 or higher (ROZ 95/RON 95/PON 91):

- Connect the plug-in connector.

✓ Plug-in connector connected – Fuel with an octane rating of 95 or higher can be used. (🔧 p. 149)

Subsequent work

- Mount the seat. (🔧 p. 71)

Checking the basic position of the shift lever

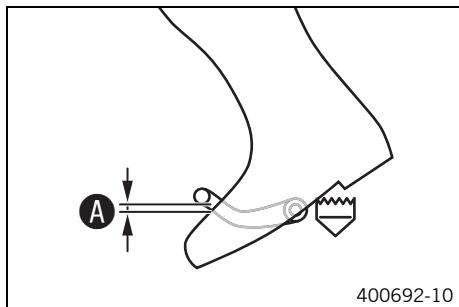

- Sit on the vehicle in the riding position and determine the distance **A** between the upper edge of your boot and the shift lever.

Distance between shift lever and upper edge of boot	10... 20 mm (0.39... 0.79 in)
---	-------------------------------

- » If the distance does not meet specifications:
 - Adjust the basic position of the shift lever. 🛠️ (👉 p. 151)

Adjusting the basic position of the shift lever 🛠️

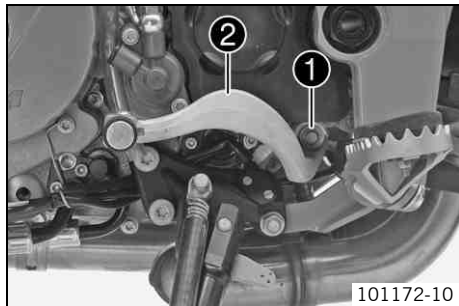

- Remove screw **1** and remove shift lever **2**.

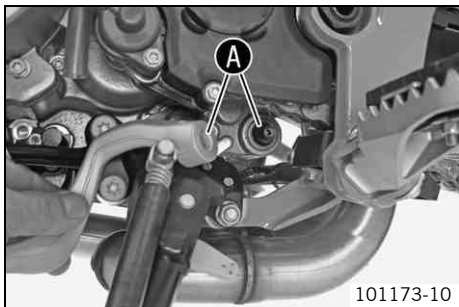

- Clean gear teeth **A** of the shift lever and shift shaft.
- Mount the shift lever on the shift shaft in the required position and engage the gearing.

i **Info**

The range of adjustment is limited.
The shift lever must not come into contact with any other vehicle components during the shift procedure.

- Mount and tighten screw.

Guideline

Screw, shift lever	M6	10 Nm (7.4 lbf ft)	Loctite® 243™
--------------------	----	-----------------------	----------------------

Checking the engine oil level

Preliminary work



Danger

Danger of poisoning Exhaust gases are poisonous and inhaling them may result in unconsciousness and/or death.

- When running the engine, always make sure there is sufficient ventilation, and do not start or run the engine in an enclosed space without an effective exhaust extraction system.

- Start the engine and run it until it reaches operating temperature.
 - ✓ Six bars of the temperature display light up.

Main work

- Switch off the engine.
- Park the motorcycle on a horizontal surface in a vertical position (not on the side stand).



Info

After switching off the engine, wait one minute before checking the level.

- Check the engine oil level at oil level viewer ❶.



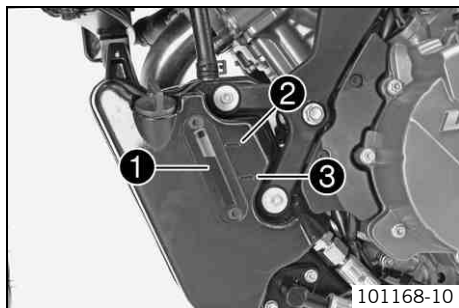

The engine oil level must be between the upper marking ❷ and lower marking ❸.

- » If the engine oil level is not at the specified level:
 - Add engine oil. (🔧 p. 160)



Changing the engine oil and filter, cleaning the oil screens



- Drain the engine oil and filter, clean the oil screens.  ( p. 154)
- Fill up with engine oil.  ( p. 159)

Draining the engine oil and filter, cleaning the oil screens



Warning

Danger of scalding Engine oil and gear oil get very hot when the motorcycle is ridden.

- Wear appropriate protective clothing and safety gloves. In case of burns, rinse immediately with lukewarm water.



Warning

Environmental hazard Hazardous substances cause environmental damage.

- Oil, grease, filters, fuel, cleaners, brake fluid, etc., should be disposed of as stipulated in applicable regulations.



Info

Drain the engine oil only when the engine is warm.

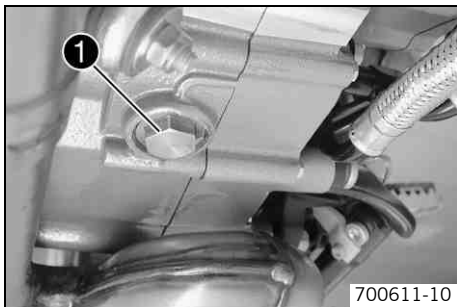

- Place a suitable container under the engine.
- Remove the oil drain plug ❶ with the magnet and seal ring.
- Fully drain the engine oil out of the engine.

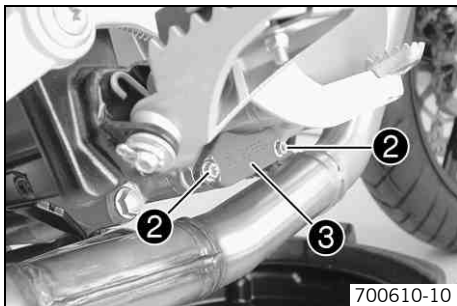

- Remove screws ❷ and cover ❸.

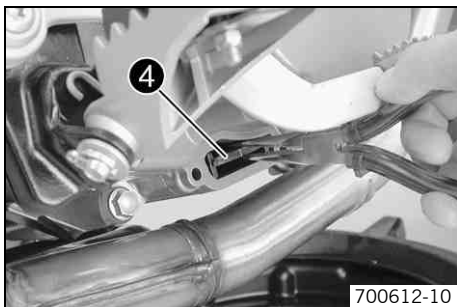

- Pull oil screen ❹ out of the engine case with pliers.

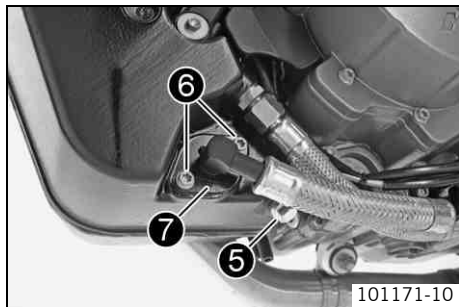

- Place a suitable container under the engine.
- Remove oil drain plug **5**.
- Fully drain the engine oil out of the oil tank.
- Remove screws **6** and move oil line **7** to one side.

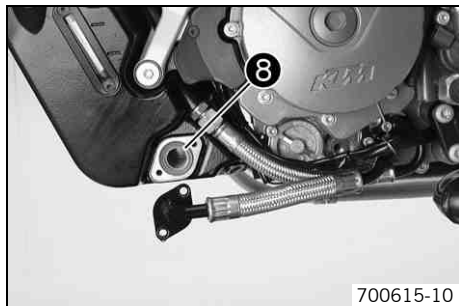

- Pull oil screen **8** out of the oil tank.

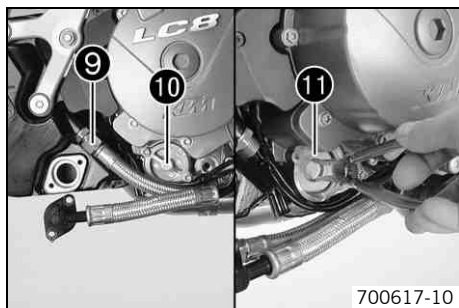

- Remove screw connection **9** and move the oil line to one side.
- Remove screws . Remove the oil filter cover **10** with the O-ring.
- Pull oil filter **11** out of the oil filter housing.

Circlip pliers reverse (51012011000)

- Completely drain the engine oil.
- Clean all oil screens and oil drain plugs with a magnet.
- Clean all sealing surfaces.

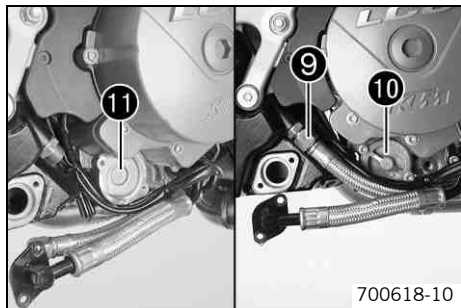

- Insert oil filter ⑪.
- Lubricate the O-ring of the oil filter cover.
- Mount the oil filter cover ⑩. Mount and tighten the screws.

Guideline

Remaining engine screws	M5	6 Nm (4.4 lbf ft)
-------------------------	----	-------------------

- Position the oil line. Mount and tighten screw connection ⑨.

Guideline

Nut, oil line	M16x1.5	25 Nm (18.4 lbf ft)
---------------	---------	------------------------

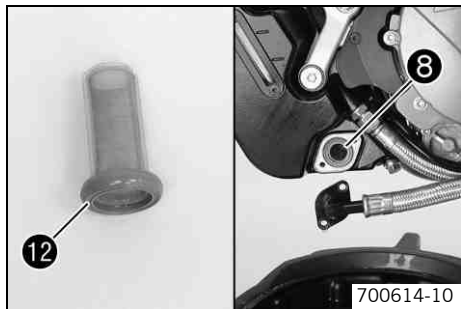

- Check seal ring ⑫ of the oil screen for damage and correct seating.
- Insert oil screen ⑧ into the oil tank.

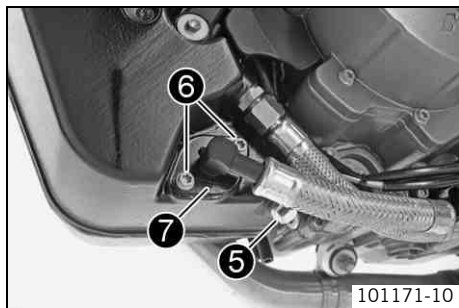

101171-10

- Position oil line ⑦. Mount and tighten screws ⑥.

Guideline

Remaining engine screws	M6	10 Nm (7.4 lbf ft)
-------------------------	----	--------------------

- Mount oil drain plug ⑤ with the magnet and new seal and tighten.

Guideline

Oil drain plug with magnet	M12x1.5	25 Nm (18.4 lbf ft)
----------------------------	---------	------------------------

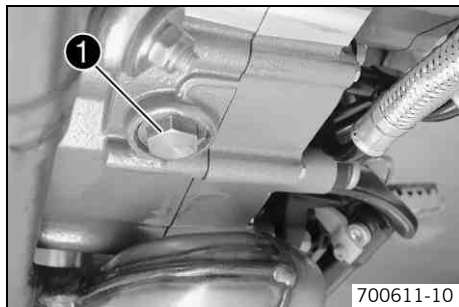

700611-10

- Mount oil drain plug ① with the magnet and new seal ring and tighten.

Guideline

Oil drain plug with magnet	M22x1.5	35 Nm (25.8 lbf ft)
----------------------------	---------	------------------------

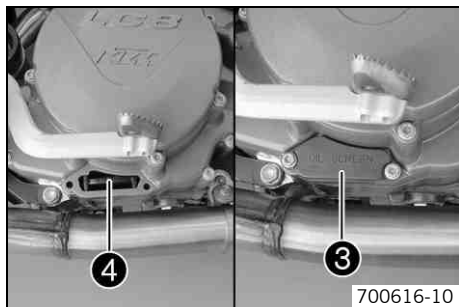

700616-10

- Slide oil screen ④ into the engine case with the **TOP** marking facing up.
- Check the form ring in cover ③ for damage and correct seating.
- Position the cover. Mount and tighten the screws.

Guideline

Screw, clutch cover	M6	10 Nm (7.4 lbf ft)
---------------------	----	--------------------

Filling up with engine oil



Info

Too little engine oil or poor-quality engine oil results in premature wear to the engine.

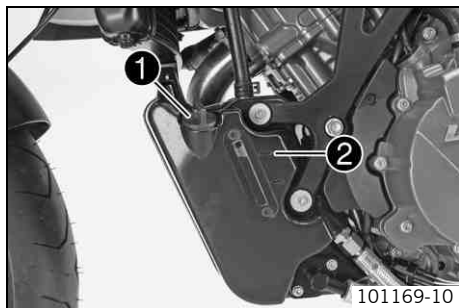

- The oil must be added in two steps.

Engine oil	3.0 l (3.2 qt.)	External temperature: ≥ 0 °C (≥ 32 °F)	Engine oil (SAE 10W/50) (☛ p. 192)
		External temperature: < 0 °C (< 32 °F)	Engine oil (SAE 5W/40) (☛ p. 192)

- Remove plug **1** and add engine oil to the top marking **2**.
- Mount the plug.



Danger

Danger of poisoning Exhaust gases are poisonous and inhaling them may result in unconsciousness and/or death.

- When running the engine, always make sure there is sufficient ventilation, and do not start or run the engine in an enclosed space without an effective exhaust extraction system.
-
- Start the engine and run it until it reaches operating temperature.
 - ✓ Six bars of the temperature display light up.
 - Check the lubrication system for leaks.
 - Switch off the engine.
 - Park the motorcycle on a horizontal surface in a vertical position (not on the side stand).

- Remove the plug.
- Add engine oil to the top marking ②.
- Mount the plug.

Adding engine oil

i **Info**
Too little engine oil or poor-quality engine oil results in premature wear to the engine.
The engine oil level must be corrected when the engine is warm.

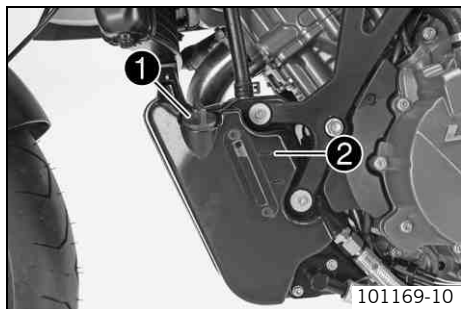

- Remove plug ① and add engine oil to the top marking ②.

Condition

External temperature: $\geq 0\text{ }^{\circ}\text{C}$ ($\geq 32\text{ }^{\circ}\text{F}$)

Engine oil (SAE 10W/50) (☛ p. 192)

Condition

External temperature: $< 0\text{ }^{\circ}\text{C}$ ($< 32\text{ }^{\circ}\text{F}$)

Engine oil (SAE 5W/40) (☛ p. 192)

i **Info**
For optimal performance of the engine oil, do not mix different types of engine oil.
We recommend changing the engine oil, if necessary.

- Mount the plug.

Cleaning motorcycle

Note

Material damage Damage and destruction of components by high-pressure cleaning equipment.

- Never clean the vehicle with high-pressure cleaning equipment or a strong water-jet. The excessive pressure can penetrate electrical components, socket connects, throttle cables, and bearings, etc., and can damage or destroy these parts.



Warning

Environmental hazard Hazardous substances cause environmental damage.

- Oil, grease, filters, fuel, cleaners, brake fluid, etc., should be disposed of as stipulated in applicable regulations.



Info

If you clean the motorcycle regularly, its value and appearance will be maintained over a long period. Avoid direct sunshine on the motorcycle during cleaning.

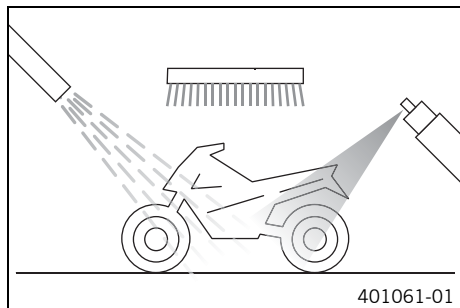

Main work

- Close off the exhaust system to keep water from entering.
- Remove coarse dirt particles with a gentle spray of water.
- Spray very dirty areas with a normal motorcycle cleaner and then clean with a paint-brush.

Motorcycle cleaner (☛ p. 196)



Info

Clean the vehicle using warm water containing normal motorcycle cleaner and a soft sponge.

If the vehicle was operated in road salt, clean it with cold water. Warm water would enhance the corrosive effects of salt.

- After the motorcycle has been thoroughly cleaned with a gentle jet of water, it should be dried with compressed air and a cloth.



Warning

Danger of accidents Reduced braking efficiency due to wet or dirty brakes.

- Clean or dry dirty or wet brakes by riding and braking gently.

-
- After cleaning, ride the vehicle a short distance until the engine warms up, applying the brakes occasionally.



Info

The heat produced causes water at inaccessible positions in the engine and on the brakes to evaporate.

Follow-up work

- After the motorcycle has cooled off, lubricate all moving parts and bearings.
- Clean the chain. (🔧 p. 75)
- Treat bare metal parts (except for brake discs and exhaust system) with anti-corrosion materials.

Cleaning and preserving materials for metal, rubber and plastic (🔧 p. 195)

- Treat all painted parts with a mild paint polish.

High-luster polish for paint (🔧 p. 195)

- Oil the ignition/steering lock, tank lock, and seat lock.

Universal oil spray (🔧 p. 196)

Checks and maintenance measures for winter operation

i Info

If you use the motorcycle in winter, you must expect salt on the roads. You should therefore take precautions against aggressive road salt.

If the vehicle was operated in road salt, clean it with cold water after use. Warm water would enhance the corrosive effects of salt.

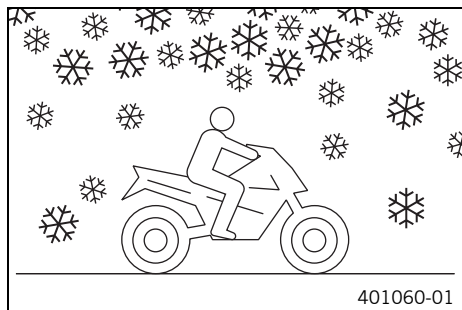

- Clean the motorcycle. (☛ p. 161)
- Clean the brakes.

i Info

After **EVERY** trip on salted roads, thoroughly clean the brake calipers and brake linings after they have cooled down while they are installed; use cold water and dry them well.

After riding on salted roads, thoroughly wash the motorcycle with cold water and dry it well.

- Treat the engine, the swingarm, and all other bare or galvanized parts (except brake discs) with a wax-based anti-corrosion substance.

i Info

To prevent serious reduction of the braking efficiency, make sure no anti-corrosion substance gets on to the brake discs.

- Clean the chain. (☛ p. 75)

Storage

i Info

If you want to garage the motorcycle for a longer period, take the following actions.

Before storing the motorcycle, check all parts for function and wear. If service, repairs or replacements are necessary, you should do this during the storage period (less workshop overload). In this way, you can avoid long workshop waiting times at the start of the new season.

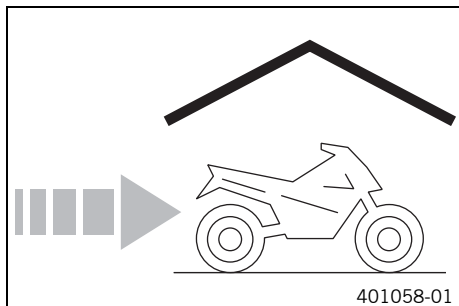

- Make sure the fuel tanks are as empty as possible so that you can fill up with fresh fuel when you put the motorcycle back into operation.
- Clean the motorcycle. (☞ p. 161)
- Change the engine oil and filter, clean the oil screens. 🛠️ (☞ p. 154)
- Check the antifreeze and coolant level. (☞ p. 140)
- Check the tire air pressure. (☞ p. 106)
- Remove the battery. 🛠️ (☞ p. 108)
- Recharge the battery. 🛠️ (☞ p. 111)

Guideline

Storage temperature of battery without direct sunshine	0... 35 °C (32... 95 °F)
--	--------------------------

- Store the vehicle in a dry location that is not subject to large fluctuations in temperature.

i Info

KTM recommends raising the motorcycle.

- Raise the motorcycle with the rear wheel stand. (☞ p. 69)
- Raise the motorcycle with the front wheel stand. (☞ p. 68)

- Cover the motorcycle with a tarp or cover that is permeable to air.

i Info

Do not use non-porous materials since they prevent humidity from escaping, thus causing corrosion.

Avoid running the engine for a short time only. Since the engine cannot warm up properly, the water vapor produced during combustion condenses and causes valves and exhaust system to rust.

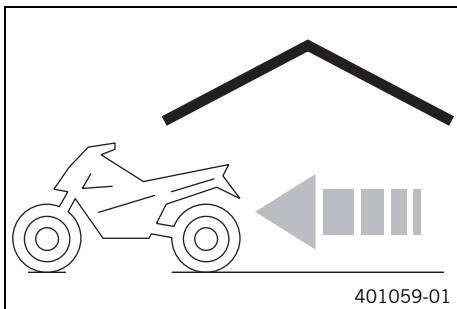



Preparing for use after storage





- Take the motorcycle off of the front wheel stand. (🔧 p. 68)
- Take the motorcycle off of the rear wheel stand. (🔧 p. 69)
- Recharge the battery. 🔌 (🔧 p. 111)
- Install the battery. 🔌 (🔧 p. 110)
- Set the clock. (🔧 p. 29)
- Refuel. (🔧 p. 54)
- Perform checks and maintenance measures when preparing for use. (🔧 p. 45)
- Take a test ride.





Faults	Possible cause	Action
The engine does not turn when the starter button is pressed	Operating error	– Carry out the start procedure. (☞ p. 46)
	Battery discharged	– Recharge the battery. 🛠️ (☞ p. 111) – Check the closed current. 🛠️
	1, or 5 fuse blown	– Change the fuses of individual power consumers. (☞ p. 116)
	Main fuse burned out	– Change the main fuse. (☞ p. 113)
	Ignition/steering lock or emergency OFF switch defective	– Check the emergency OFF switch. 🛠️ – Check the ignition/steering lock. 🛠️
	Defect in safety start system	– Check the safety start system. 🛠️
	ICU is not activated	– Activate the immobilizer control unit. 🛠️
	Malfunction in CAN bus communication	– Read out the trouble code memory using the KTM diagnostics tool. 🛠️
	Combination instrument defective	– Check the combination instrument. 🛠️
Engine turns only if the clutch lever is drawn	The vehicle is in gear	– Shift the transmission to neutral.
	Defect in safety start system	– Check the safety start system. 🛠️
Engine turns although a gear is engaged	Defect in safety start system	– Check the safety start system. 🛠️
Engine turns but does not start	Coupling of fuel hose connection not connected	– Reconnect coupling of fuel hose connection.
	Socket connector of wiring harness oxidized	– Clean the socket connector and treat it with contact spray.
	Defect in fuel injection system	– Read out the fault memory using the KTM diagnostics tool. 🛠️





Faults	Possible cause	Action
Engine has too little power	Air filter very dirty	– Change the air filter. 🛠️
	Defect in fuel injection system	– Read out the fault memory using the KTM diagnostics tool. 🛠️
Engine overheats	Too little coolant in cooling system	– Check the cooling system for leaks. 🛠️ – Check the antifreeze and coolant level. (🔧 p. 140)
	Radiator fins very dirty	– Clean radiator fins.
	Foam formation in cooling system	– Drain the coolant. 🛠️ (🔧 p. 144) – Fill/bleed the cooling system. 🛠️ (🔧 p. 145)
	Buckled or damaged radiator hose	– Change the radiator hose. 🛠️
	Fuse 4 blown	– Change the fuses of individual power consumers. (🔧 p. 116)
	Thermostat defective	– Check the thermostat. 🛠️
	Defect in radiator fan system	– Check the radiator fan system. 🛠️
	Air in cooling system	– Fill/bleed the cooling system. 🛠️ (🔧 p. 145)
FI warning lamp (MIL) lights up/flashes	Defect in fuel injection system	– Read out the fault memory using the KTM diagnostics tool. 🛠️
Engine dies during a trip	Lack of fuel	– Refuel. (🔧 p. 54)
	1 , or 5 fuse blown	– Change the fuses of individual power consumers. (🔧 p. 116)
The ABS warning lamp lights up	ABS fuse is blown	– Change the ABS fuses. (🔧 p. 115)
	Large difference in wheel speeds of the front and rear wheels	– Stop the vehicle, switch off the ignition, and start it again.
	Malfunction in ABS	– Read out the ABS fault memory using the KTM diagnostics tool. 🛠️





Faults	Possible cause	Action
High oil consumption	Engine oil level too high	– Check the engine oil level. (☞ p. 153)
	Engine oil too thin (low viscosity)	– Change the engine oil and filter, clean the oil screens. ☞ (☞ p. 154)
The headlight and tail light are not functioning	Fuse 2 blown	– Change the fuses of individual power consumers. (☞ p. 116)
Turn signal, hazard warning flasher, brake light and horn are not functional	Fuse 1 or 3 blown	– Change the fuses of individual power consumers. (☞ p. 116)
Battery discharged	Ignition not switched off when vehicle was parked	– Recharge the battery. ☞ (☞ p. 111)
	Battery is not charged by the alternator	– Check the charging voltage. ☞
Combination instrument shows nothing in the display	Fuse 6 blown	– Change the fuses of individual power consumers. (☞ p. 116)
Speedometer in combination instrument not functioning	Wiring harness of wheel revolution counter damaged or plug-in connector oxidized	– Check the wheel speed sensor. ☞





Blink code of immobilizer indicator lamp	 <p>12 Immobilizer indicator lamp flashes 1x short, 1 second pause, 2x short</p>
Error level condition	<p>All ignition keys inactive</p>
Blink code of immobilizer indicator lamp	 <p>13 Immobilizer indicator lamp flashes 1x short, 1 second pause, 3x short</p>
Error level condition	<p>ICU antenna malfunction</p>
Blink code of immobilizer indicator lamp	 <p>14 Immobilizer indicator lamp flashes 1x short, 1 second pause, 4x short</p>
Error level condition	<p>Malfunction in transponder of black ignition key</p>
Blink code of immobilizer indicator lamp	 <p>15 Immobilizer indicator lamp flashes 1x short, 1 second pause, 5x short</p>
Error level condition	<p>Black ignition key inactive</p>
Blink code of immobilizer indicator lamp	 <p>16 Immobilizer indicator lamp flashes 1x short, 1 second pause, 6x short</p>
Error level condition	<p>Malfunction, ICU encryption for black ignition key</p>





Blink code of immobilizer indicator lamp	 <p>21 Immobilizer indicator lamp flashes 2x short, 1 second pause, 1x short</p>
Error level condition	ICU is not activated
Blink code of immobilizer indicator lamp	 <p>31 Immobilizer indicator lamp flashes 3x short, 1 second pause, 1x short</p>
Error level condition	Malfunction, encryption query from EFI control unit to immobilizer control unit
Blink code of immobilizer indicator lamp	 <p>32 Immobilizer indicator lamp flashes 3x short, 1 second pause, 2x short</p>
Error level condition	Malfunction in CAN bus communication
Blink code of immobilizer indicator lamp	 <p>60 Immobilizer indicator lamp flashes 6x short</p>
Error level condition	E²PROM malfunction



Blink code of FI warning lamp (MIL)	 02 FI warning lamp (MIL) flashes 2x short
Error level condition	Circuit ignition pulse generator - circuit fault
Blink code of FI warning lamp (MIL)	 06 FI warning lamp (MIL) flashes 6x short
Error level condition	Throttle valve sensor circuit A - input signal too low
	Throttle valve sensor circuit A - input signal too high
Blink code of FI warning lamp (MIL)	 07 FI warning lamp (MIL) flashes 7x short
Error level condition	Throttle position sensor circuit B - input signal too low
	Throttle position sensor circuit B - input signal too high
Blink code of FI warning lamp (MIL)	 09 FI warning lamp (MIL) flashes 9x short
Error level condition	Manifold absolute pressure sensor cylinder 1 - input signal too low
	Manifold absolute pressure sensor cylinder 1 - input signal too high
Blink code of FI warning lamp (MIL)	 11 FI warning lamp (MIL) flashes 1x long, 1x short
Error level condition	Manifold absolute pressure sensor cylinder 2 - input signal too low
	Manifold absolute pressure sensor cylinder 2 - input signal too high

Blink code of FI warning lamp (MIL)	 12 FI warning lamp (MIL) flashes 1x long, 2x short
Error level condition	Coolant temperature sensor - input signal too low
	Coolant temperature sensor - input signal too high
Blink code of FI warning lamp (MIL)	 13 FI warning lamp (MIL) flashes 1x long, 3x short
Error level condition	Intake air temperature sensor - input signal too low
	Intake air temperature sensor - input signal too high
Blink code of FI warning lamp (MIL)	 14 FI warning lamp (MIL) flashes 1x long, 4x short
Error level condition	Ambient air pressure sensor - input signal too low
	Ambient air pressure sensor - input signal too high
Blink code of FI warning lamp (MIL)	 15 FI warning lamp (MIL) flashes 1x long, 5x short
Error level condition	Rollover sensor (A/D type) - input signal too low
	Rollover sensor (A/D type) - input signal too high
Blink code of FI warning lamp (MIL)	 17 FI warning lamp (MIL) flashes 1x long, 7x short
Error level condition	Lambda sensor cylinder 1, sensor 1 - circuit fault

Blink code of FI warning lamp (MIL)	 18 FI warning lamp (MIL) flashes 1x long, 8x short
Error level condition	Lambda sensor cylinder 2, sensor 1 - circuit fault
Blink code of FI warning lamp (MIL)	 24 FI warning lamp (MIL) flashes 2x long, 4x short
Error level condition	Power supply - circuit fault
Blink code of FI warning lamp (MIL)	 25 FI warning lamp (MIL) flashes 2x long, 5x short
Error level condition	Side stand (A/D type) - malfunction in circuit
Blink code of FI warning lamp (MIL)	 33 FI warning lamp (MIL) flashes 3x long, 3x short
Error level condition	Injector cylinder 1 - circuit fault
Blink code of FI warning lamp (MIL)	 34 FI warning lamp (MIL) flashes 3x long, 4x short
Error level condition	Injector cylinder 2 - circuit fault

Blink code of FI warning lamp (MIL)	 37 FI warning lamp (MIL) flashes 3x long, 7x short
Error level condition	Ignition coil 1, cylinder 1 - circuit fault
Blink code of FI warning lamp (MIL)	 38 FI warning lamp (MIL) flashes 3x long, 8x short
Error level condition	Ignition coil 1, cylinder 2 - circuit fault
Blink code of FI warning lamp (MIL)	 41 FI warning lamp (MIL) flashes 4x long, 1x short
Error level condition	Fuel pump control - interruption/short circuit to ground
	Fuel pump control - input signal too high
Blink code of FI warning lamp (MIL)	 45 FI warning lamp (MIL) flashes 4x long, 5x short
Error level condition	Heating lambda sensor cylinder 1, sensor 1 - interruption/short circuit to ground
	Heating lambda sensor cylinder 1, sensor 1 - input signal too high
Blink code of FI warning lamp (MIL)	 46 FI warning lamp (MIL) flashes 4x long, 6x short
Error level condition	Heating lambda sensor cylinder 2, sensor 1 - interruption/short circuit to ground
	Heating lambda sensor cylinder 2, sensor 1 - input signal too high

Blink code of FI warning lamp (MIL)	 49 FI warning lamp (MIL) flashes 4x long, 9x short
Error level condition	Motor drive circuit A - circuit fault
Blink code of FI warning lamp (MIL)	 50 FI warning lamp (MIL) flashes 5x long
Error level condition	Motor drive circuit B - circuit fault
Blink code of FI warning lamp (MIL)	 54 FI warning lamp (MIL) flashes 5x long, 4x short
Error level condition	Secondary air valve - interruption/short circuit to ground
	Secondary air valve - input signal too high
Blink code of FI warning lamp (MIL)	 68 FI warning lamp (MIL) flashes 6x long, 8x short
Error level condition	Manifold absolute pressure sensor cylinder 1 - connection leaks
Blink code of FI warning lamp (MIL)	 69 FI warning lamp (MIL) flashes 6x long, 9x short
Error level condition	Manifold absolute pressure sensor cylinder 2 - connection leaks

Blink code of FI warning lamp (MIL)	 81 FI warning lamp (MIL) flashes 8x long, 1x short
Error level condition	Immobilizer control unit - circuit fault
Blink code of FI warning lamp (MIL)	 91 FI warning lamp (MIL) flashes 9x long, 1x short
Error level condition	Malfunction in CAN bus communication

Design	2-cylinder 4-stroke Otto motor, 75° V arrangement, water-cooled
Displacement	999 cm ³ (60.96 cu in)
Stroke	62.4 mm (2.457 in)
Bore	101 mm (3.98 in)
Compression ratio	11.5:1
Control	DOHC, 4 valves per cylinder, chain-driven
Valve - diameter	
Exhaust	33 mm (1.3 in)
Intake	38 mm (1.5 in)
Valve clearance	
Exhaust at: 20 °C (68 °F)	0.25... 0.30 mm (0.0098... 0.0118 in)
Intake at: 20 °C (68 °F)	0.10... 0.15 mm (0.0039... 0.0059 in)
Crankshaft bearing	Sleeve bearing
Conrod bearing	Sleeve bearing
Piston	Forged light alloy
Piston ring	1 L-ring, 1 tapered compression piston ring, 1 oil scraper ring
Engine lubrication	Dry sump lubrication system with two rotor pumps
Primary transmission	35:67
Clutch	Multidisc clutch in oil bath/hydraulically activated
Transmission	6-gears, claw-shifted
Transmission ratio	
1st gear	12:35
2nd gear	15:32
3rd gear	18:30
4th gear	20:27

5th gear	24:27
6th gear	27:26
Mixture preparation	Electronic fuel injection
Ignition system	Contactless controlled fully electronic ignition with digital ignition adjustment
Alternator	12 V, 450 W
Spark plug	NGK LKAR8BI9
Spark plug electrode gap	0.8 mm (0.031 in)
Cooling	Water cooling, permanent circulation of coolant by water pump
Idle speed	1,400... 1,500 rpm
Cold start device	Electric starter

Capacity - engine oil

Engine oil	3.0 l (3.2 qt.)	External temperature: $\geq 0\text{ }^{\circ}\text{C}$ ($\geq 32\text{ }^{\circ}\text{F}$)	Engine oil (SAE 10W/50) (☛ p. 192)
		External temperature: $< 0\text{ }^{\circ}\text{C}$ ($< 32\text{ }^{\circ}\text{F}$)	Engine oil (SAE 5W/40) (☛ p. 192)

Capacity - coolant

Coolant	2.10 l (2.22 qt.)	Coolant (☛ p. 191)
		Coolant (mixed ready to use) (☛ p. 191)

TECHNICAL DATA - ENGINE TIGHTENING TORQUES

Hose clip, intake flange	M4	1.5 Nm (1.11 lbf ft)	–
Screw, oil spray tube	M4	6 Nm (4.4 lbf ft)	Loctite® 243™
Remaining engine screws	M5	6 Nm (4.4 lbf ft)	–
Screw, bearing retainer	M5	6 Nm (4.4 lbf ft)	Loctite® 243™
Screw, connecting angle on valve cover	M5	3 Nm (2.2 lbf ft)	Loctite® 243™
Screw, gear sensor	M5	3 Nm (2.2 lbf ft)	Loctite® 243™
Screw, locking lever	M5	6 Nm (4.4 lbf ft)	Loctite® 243™
Nut, cylinder head	M6	8 Nm (5.9 lbf ft)	–
Plug, vacuum connection	M6	5 Nm (3.7 lbf ft)	Loctite® 243™
Remaining engine screws	M6	10 Nm (7.4 lbf ft)	–
Screw in alternator cover	M6	10 Nm (7.4 lbf ft)	–
Screw, bearing bolt in alternator cover	M6	10 Nm (7.4 lbf ft)	Loctite® 243™
Screw, camshaft bearing support	M6	10 Nm (7.4 lbf ft)	–
Screw, clutch cover	M6	10 Nm (7.4 lbf ft)	–
Screw, clutch spring	M6	10 Nm (7.4 lbf ft)	–
Screw, engine case	M6	10 Nm (7.4 lbf ft)	–
Screw, freewheel holder	M6	10 Nm (7.4 lbf ft)	Loctite® 243™
Screw, freewheel hub	M6	13 Nm (9.6 lbf ft)	Loctite® 648™
Screw, oil pump housing	M6	10 Nm (7.4 lbf ft)	Loctite® 243™
Screw, pulse generator	M6	10 Nm (7.4 lbf ft)	Loctite® 243™
Screw, shift drum locating	M6	10 Nm (7.4 lbf ft)	Loctite® 243™
Screw, shift lever	M6	10 Nm (7.4 lbf ft)	Loctite® 243™
Screw, starter motor	M6	10 Nm (7.4 lbf ft)	–
Screw, stator	M6	10 Nm (7.4 lbf ft)	Loctite® 243™

TECHNICAL DATA - ENGINE TIGHTENING TORQUES

Screw, valve cover	M6	10 Nm (7.4 lbf ft)	–
Screw, water pump cover	M6	10 Nm (7.4 lbf ft)	–
Screw, water pump wheel	M6	10 Nm (7.4 lbf ft)	Loctite® 243™
Vacuum connection	M6	2.5 Nm (1.84 lbf ft)	Loctite® 243™
Oil jet	M6x0.75	4 Nm (3 lbf ft)	Loctite® 243™
Screw, camshaft bearing support	M8	Step 1 10 Nm (7.4 lbf ft) Step 2 18 Nm (13.3 lbf ft)	–
Screw, clutch cover	M8	15 Nm (11.1 lbf ft)	–
Screw, timing chain guide rail	M8	15 Nm (11.1 lbf ft)	Loctite® 243™
Screw, timing chain tensioning rail	M8	20 Nm (14.8 lbf ft)	Loctite® 243™
Stud, exhaust flange	M8	15 Nm (11.1 lbf ft)	–
Nut, cylinder head (exterior)	M10	Step 1 23 Nm (17 lbf ft) Step 2 34 Nm (25.1 lbf ft)	Only applies when using: Box wrench attachment 13 mm (60029081000)
			Lubricated with engine oil
Nut, cylinder head on chain shaft	M10	Step 1 25 Nm (18.4 lbf ft) Step 2 38 Nm (28 lbf ft)	Lubricated with engine oil
Plug, clutch lubrication	M10	15 Nm (11.1 lbf ft)	–
Screw, bearing bolt of timing gears	M10	30 Nm (22.1 lbf ft)	–
Oil pressure sensor	M10x1	10 Nm (7.4 lbf ft)	–

TECHNICAL DATA - ENGINE TIGHTENING TORQUES

Screw, conrod bearing	M10x1	Step 1 25 Nm (18.4 lbf ft) Step 2 30 Nm (22.1 lbf ft) Step 3 60°	–
Spark plug	M12x1.25	18 Nm (13.3 lbf ft)	–
Coolant temperature sensor	M12x1.5	12 Nm (8.9 lbf ft)	–
Plus, cylinder head (2nd cylinder)	M12x1.5	25 Nm (18.4 lbf ft)	–
Plug, oil filter housing	M14x1.5	15 Nm (11.1 lbf ft)	Loctite® 243™
Bleeder flange, alternator cover	M16x1.5	10 Nm (7.4 lbf ft)	Loctite® 243™
Plug, timing-chain tensioner	M16x1.5	20 Nm (14.8 lbf ft)	–
Rotor screw	M16x1.5	150 Nm (110.6 lbf ft)	Loctite® 243™
Nut, balancer shaft	M20x1.5	120 Nm (88.5 lbf ft)	Loctite® 243™
Nut, engine sprocket	M20x1.5	100 Nm (73.8 lbf ft)	Loctite® 243™
Screw-in fitting, cooling system	M20x1.5	10 Nm (7.4 lbf ft)	Loctite® 577
Nut, inner clutch hub	M22x1.5	130 Nm (95.9 lbf ft)	Loctite® 243™
Oil drain plug with magnet	M22x1.5	35 Nm (25.8 lbf ft)	–
Screw in alternator cover	M24x1.5	8 Nm (5.9 lbf ft)	–
Nut, primary gear	M33LHx1.5	130 Nm (95.9 lbf ft)	Loctite® 243™

Frame	Lattice frame made of chrome molybdenum steel tubing, powder-coated
Fork	WP Suspension Up Side Down 4860 ROMA PA
Shock absorber	WP Suspension 4618 BAVP DCC
Suspension travel	
Front	160 mm (6.3 in)
Rear	180 mm (7.09 in)
Brake system	
Front	Double disc brake with radially screwed four-piston brake calipers, float-mounted brake discs
Rear	Single disc brake with dual-piston brake caliper, rigid-mounted brake disc
Brake system	Two independent brake circuits with ABS (antilock brake system) - Brembo/Bosch
Brake discs - diameter	
Front	305 mm (12.01 in)
Rear	240 mm (9.45 in)
Brake discs - wear limit	
Front	4.5 mm (0.177 in)
Brake disc - wear limit	
Rear	4.5 mm (0.177 in)
Tire air pressure, solo	
Front	2.4 bar (35 psi)
Rear	2.4 bar (35 psi)
Tire air pressure with passenger/full payload	
Front	2.4 bar (35 psi)

Rear	2.6 bar (38 psi)
Secondary drive ratio	17:41
Chain	5/8 x 5/16" X-ring
Steering head angle	65.6°
Wheelbase	1,505 \pm 15 mm (59.25 \pm 0.59 in)
Seat height, unloaded	875 mm (34.45 in)
Ground clearance, unloaded	195 mm (7.68 in)
Weight without fuel, approx.	192 kg (423 lb.)
Maximum permissible front axle load	160 kg (353 lb.)
Maximum permissible rear axle load	250 kg (551 lb.)
Maximum permissible total weight	400 kg (882 lb.)

Battery	YTZ14S	Battery voltage: 12 V Nominal capacity: 11.2 Ah maintenance-free
Fuse	75011088010	10 A
Fuse	75011088015	15 A
Fuse	58011109130	30 A

Lighting equipment

Low beam/high beam	H4/socket P43t	12 V 60/55 W
Parking light	W5W/socket W2.1x9.5d	12 V 5 W
Instrument lights and indicator lamps	LED	

Turn signal	RY10W/socket BAU15s	12 V 10 W
Tail light	WR5W/socket W2.1x9.5d	12 V 5 W
Brake light	PR21W/socket BAW15s	12 V 21 W
License plate lamp	W5W/socket W2.1x9.5d	12 V 5 W

Capacity - fuel

Total fuel tank capacity, approx.	15 l (4 US gal)	Super unleaded (ROZ 95/RON 95/PON 91) (☛ p. 194)
Fuel reserve, approx.	3.5 l (3.7 qt.)	

Fork part number	14.18.7L.21	
Fork	WP Suspension Up Side Down 4860 ROMA PA	
Compression damping		
Comfort	20 clicks	
Standard	15 clicks	
Sport	10 clicks	
Full payload	10 clicks	
Rebound damping		
Comfort	20 clicks	
Standard	15 clicks	
Sport	10 clicks	
Full payload	10 clicks	
Spring preload - Preload Adjuster		
Comfort	5 turns	
Standard	5 turns	
Sport	3 turns	
Full payload	3 turns	
Spring length with preload spacer(s)	386 mm (15.2 in)	
Spring rate		
Medium (standard)	7.5 N/mm (42.8 lb/in)	
Fork length	877 mm (34.53 in)	
Air chamber length	100±20 mm (3.94±0.79 in)	
Fork oil per fork leg	750 ml (25.36 fl. oz.)	Fork oil (SAE 5) (☛ p. 193)

Shock absorber part number	15.18.7L.21
Shock absorber	WP Suspension 4618 BAVP DCC
Compression damping, low-speed	
Comfort	25 clicks
Standard	20 clicks
Sport	15 clicks
Full payload	15 clicks
Compression damping, high-speed	
Comfort	2 turns
Standard	1.5 turns
Sport	1 turn
Full payload	1 turn
Rebound damping	
Comfort	20 clicks
Standard	15 clicks
Sport	10 clicks
Full payload	10 clicks
Spring preload	
Comfort	11 mm (0.43 in)
Standard	11 mm (0.43 in)
Sport	11 mm (0.43 in)
Full payload	13 mm (0.51 in)
Spring rate	
Medium (standard)	140 N/mm (799 lb/in)
Spring length	200 mm (7.87 in)

TECHNICAL DATA - SHOCK ABSORBER

Gas pressure	10 bar (145 psi)
Static sag	20 mm (0.79 in)
Fitted length	372 mm (14.65 in)
Shock absorber fluid	Shock absorber oil (SAE 2.5) (50180342S1) (☛ p. 193)

TECHNICAL DATA - CHASSIS TIGHTENING TORQUES

Remaining frame bolts	EJOT Delta PT 50x12	1.2 Nm (0.89 lbf ft)	–
Remaining frame bolts	EJOT PT K50x12 T20	1.2 Nm (0.89 lbf ft)	–
Remaining frame bolts	EJOT PT K50x18 T20	2 Nm (1.5 lbf ft)	–
Screw, brake line holder	EJOT PT K60x20	2 Nm (1.5 lbf ft)	–
Screw, chain sliding piece	EJOT PT K60x20	2 Nm (1.5 lbf ft)	–
Screw, combination instrument	EJOT Delta PT 45x12	1 Nm (0.7 lbf ft)	–
Screw, side stand switch	M4	2 Nm (1.5 lbf ft)	Loctite® 243™
Remaining chassis nuts	M5	5 Nm (3.7 lbf ft)	–
Remaining chassis screws	M5	5 Nm (3.7 lbf ft)	–
Screw, brake line holder	M5	2 Nm (1.5 lbf ft)	–
Screw, chain sliding guard	M5	5 Nm (3.7 lbf ft)	–
Screw, closure flange, fuel tank	M5	3.3 Nm (2.43 lbf ft)	–
Screw, engine oil level viewer	M5	3.3 Nm (2.43 lbf ft)	–
Screw, foot brake lever stub	M5	6 Nm (4.4 lbf ft)	Loctite® 243™
Nut, tail light	M6	8 Nm (5.9 lbf ft)	–
Remaining chassis nuts	M6	10 Nm (7.4 lbf ft)	–
Remaining chassis screws	M6	10 Nm (7.4 lbf ft)	–
Screw, chain sliding guard	M6	6 Nm (4.4 lbf ft)	Loctite® 243™
Screw, foot brake cylinder	M6	10 Nm (7.4 lbf ft)	Loctite® 243™
Screw, fuel pump	M6	6 Nm (4.4 lbf ft)	–
Screw, fuel tap	M6	6 Nm (4.4 lbf ft)	–
Screw, holder on ABS unit	M6	6 Nm (4.4 lbf ft)	–
Screw, magnetic holder on side stand	M6	6 Nm (4.4 lbf ft)	Loctite® 243™
Screw, seat bracket, fuel tank	M6	3.3 Nm (2.43 lbf ft)	–

TECHNICAL DATA - CHASSIS TIGHTENING TORQUES

Screw, splash protector	M6	6 Nm (4.4 lbf ft)	Loctite® 243™
Screw, spoiler	M6	3.3 Nm (2.43 lbf ft)	–
Screw, wheel speed sensor	M6	6 Nm (4.4 lbf ft)	Loctite® 243™
Nut, manifold on cylinder head	M8	Tightening sequence: Tighten the nuts uniformly. Do not bend the metal.	–
Remaining chassis nuts	M8	25 Nm (18.4 lbf ft)	–
Remaining chassis screws	M8	25 Nm (18.4 lbf ft)	–
Screw, bottom triple clamp	M8	15 Nm (11.1 lbf ft)	–
Screw, exhaust clamp on distributor pipe	M8	35 Nm (25.8 lbf ft)	–
Screw, exhaust clamp on main silencer	M8	20 Nm (14.8 lbf ft)	–
Screw, fork stub	M8	15 Nm (11.1 lbf ft)	–
Screw, front brake disc	M8	30 Nm (22.1 lbf ft)	Loctite® 243™
Screw, handlebar clamp	M8	20 Nm (14.8 lbf ft)	–
Screw, handrail	M8	20 Nm (14.8 lbf ft)	–
Screw, ignition lock (ratchet screw)	M8		Loctite® 243™
Screw, rear brake disc	M8	30 Nm (22.1 lbf ft)	Loctite® 243™
Screw, rear footrest bracket	M8	25 Nm (18.4 lbf ft)	Loctite® 243™
Screw, spring holder on side stand bracket	M8	25 Nm (18.4 lbf ft)	Loctite® 243™
Screw, steering stem	M8	20 Nm (14.8 lbf ft)	–
Screw, top triple clamp	M8	20 Nm (14.8 lbf ft)	–
Remaining chassis nuts	M10	45 Nm (33.2 lbf ft)	–
Remaining frame bolts	M10	45 Nm (33.2 lbf ft)	–

TECHNICAL DATA - CHASSIS TIGHTENING TORQUES

Screw connection, engine mounting bracket	M10	45 Nm (33.2 lbf ft)	–
Screw, handlebar support	M10	20 Nm (14.8 lbf ft)	–
Screw, side stand	M10	35 Nm (25.8 lbf ft)	Loctite® 243™
Screw, side stand bracket	M10	45 Nm (33.2 lbf ft)	Loctite® 243™
Banjo bolt, brake line	M10x1	20 Nm (14.8 lbf ft)	–
Brake light switch	M10x1	20 Nm (14.8 lbf ft)	–
Screw connection, rear hub shock absorber/rear sprocket	M10x1.25	50 Nm (36.9 lbf ft)	Loctite® 243™
Screw, front brake caliper	M10x1.25	45 Nm (33.2 lbf ft)	Loctite® 243™
Screw, lower subframe	M10x1.25	45 Nm (33.2 lbf ft)	Loctite® 243™
Screw, upper subframe	M10x1.25	45 Nm (33.2 lbf ft)	Loctite® 243™
Oil drain plug with magnet	M12x1.5	25 Nm (18.4 lbf ft)	–
Screw connection, suction line	M14x1.5	45 Nm (33.2 lbf ft)	Loctite® 577
Screw, bottom shock absorber	M14x1.5	80 Nm (59 lbf ft)	Thread greased
Screw, top shock absorber	M14x1.5	80 Nm (59 lbf ft)	Thread greased
Nut, oil line	M16x1.5	25 Nm (18.4 lbf ft)	–
Nut, swingarm pivot	M19x1.5	130 Nm (95.9 lbf ft)	Thread greased
Screw, steering head	M20x1.5	12 Nm (8.9 lbf ft)	–
Bolt, front axle	M25x1.5	45 Nm (33.2 lbf ft)	–
Nut, rear wheel spindle	M25x1.5	90 Nm (66.4 lbf ft)	Thread greased

Brake fluid DOT 4 / DOT 5.1

According to

- DOT

Guideline

- Use only brake fluid that complies with the specified standard (see specifications on the container) and that possesses the corresponding properties. KTM recommends **Castrol** and **Motorex®** products.

Supplier

Castrol

- **RESPONSE BRAKE FLUID SUPER DOT 4**

Motorex®

- **Brake Fluid DOT 5.1**

Coolant

Guideline

- Use only suitable coolant (also in countries with high temperatures). Use of low-quality antifreeze can lead to corrosion and foaming. KTM recommends **Motorex®** products.

Mixture ratio

Antifreeze protection: -25... -45 °C (-13... -49 °F)	50 % corrosion inhibitor/antifreeze 50 % distilled water
--	---

Coolant (mixed ready to use)

Antifreeze	-40 °C (-40 °F)
------------	-----------------

Supplier

Motorex®

- **Anti Freeze**

Engine oil (SAE 10W/50)

According to

- JASO T903 MA (☛ p. 197)
- SAE (☛ p. 197) (SAE 10W/50)

Guideline

- Use only engine oils that comply with the specified standards (see specifications on the container) and that possess the corresponding properties. KTM recommends **Motorex®** products.

Fully synthetic engine oil

Supplier

Motorex®

- **Power Synt 4T**

Engine oil (SAE 5W/40)

According to

- JASO T903 MA (☛ p. 197)
- SAE (☛ p. 197) (SAE 5W/40)

Guideline

- Use only engine oils that comply with the specified standards (see specifications on the container) and that possess the corresponding properties. KTM recommends **Motorex®** products.

Synthetic engine oil

Supplier

Motorex®

- **Power Synt 4T**

Fork oil (SAE 5)

According to

- SAE (☛ p. 197) (SAE 5)

Guideline

- Use only oils that comply with the specified standards (see specifications on the container) and that possess the corresponding properties. KTM recommends **Motorex**[®] products.

Supplier

Motorex[®]

- **Racing Fork Oil**

Hydraulic fluid (15)

According to

- ISO VG (15)

Guideline

- Use only hydraulic oil that complies with the specified standard (see specifications on the container) and that possesses the corresponding properties. KTM recommends **Motorex**[®] products.

Supplier

Motorex[®]

- **Hydraulic Fluid 75**

Shock absorber oil (SAE 2.5) (50180342S1)

According to

- SAE (☛ p. 197) (SAE 2.5)

Guideline

- Use only oils that comply with the specified standards (see specifications on the container) and that possess the corresponding properties.

Super unleaded (ROZ 95/RON 95/PON 91)

According to

- DIN EN 228 (ROZ 95/RON 95/PON 91)

Guideline

- Only use unleaded super fuel that matches or is equivalent to the specified fuel grade.
- Fuel with an ethanol content of up to 10 % (E10 fuel) is safe to use.



Info

Do **not** use fuel containing methanol (e. g. M15, M85, M100) or more than 10 % ethanol (e. g. E15, E25, E85, E100).

Chain cleaner

Guideline

- KTM recommends **Motorex®** products.

Supplier

Motorex®

- **Chain Clean**

Chain lube for road use

Guideline

- KTM recommends **Motorex®** products.

Supplier

Motorex®

- **Chainlube Road**

Cleaning and preserving materials for metal, rubber and plastic

Guideline

- KTM recommends **Motorex®** products.

Supplier

Motorex®

- **Protect & Shine**

High-luster polish for paint

Guideline

- KTM recommends **Motorex®** products.

Supplier

Motorex®

- **Moto Polish**

Long-life grease

Guideline

- KTM recommends **Motorex®** products.

Supplier

Motorex®

- **Bike Grease 2000**

Motorcycle cleaner

Guideline

- KTM recommends **Motorex®** products.

Supplier

Motorex®

- **Moto Clean 900**

Universal oil spray

Guideline

- KTM recommends **Motorex®** products.

Supplier

Motorex®

- **Joker 440 Synthetic**

JASO T903 MA

Different technical development directions required a new specification for 4-stroke motorcycles – the JASO T903 MA Standard. Earlier, engine oils from the automobile industry were used for 4-stroke motorcycles because there was no separate motorcycle specification. Whereas long service intervals are demanded for automobile engines, high performance at high engine speeds are in the foreground for motorcycle engines. With most motorcycles, the gearbox and the clutch are lubricated with the same oil as the engine. The JASO MA Standard meets these special requirements.

SAE

The SAE viscosity classes were defined by the Society of Automotive Engineers and are used for classifying oils according to their viscosity. The viscosity describes only one property of oil and says nothing about quality.

A

ABS 84

Accessories 9

Antifreeze
 checking 140

Antilock brake system 84

B

Baggage 42

Battery
 installing 110
 recharging 111
 removing 108

Blink code
 engine control 171-176
 immobilizer 169-170

Brake disc, rear
 checking 91

Brake discs, front
 checking 85

Brake fluid
 front brake, adding 87
 rear brake, adding 92

Brake fluid level
 front brake, checking 86
 rear brake, checking 91

Brake light bulb
 changing 124

Brake linings
 front brake, checking 88
 rear brake, checking 94

Brakes 51

Braking 51

C

Chain
 checking 79
 cleaning 75
 dirt, checking 75

Chain guide
 checking 79

Chain tension
 adjusting 77
 checking 76

Chassis number 16

Clutch
 fluid level, checking/correcting 82

Clutch lever 19
 basic position, adjusting 82

Combination instrument 24
 clock, setting 29
 coolant temperature indicator 34
 display 27

display, ambient temperature	32
function buttons	25
indicator lamps	26
kilometers or miles, setting	28
ODO display	30
speed display	28
tachometer	25
temperature units, setting	33
time	29
TRIP 1 display, setting/resetting	30
TRIP 2 display, setting/resetting	31
TRIP F display	32
warning of slippery roads	33
Coolant	
draining	144
Coolant level	
checking	140
compensating tank, checking	143
Cooling system	140
filling/bleeding	145
D	
Display	27
E	
Electric starter button	23
Emergency OFF switch	22
Engine	
running in	42

Engine number	17
Engine oil	
adding	160
changing	154
draining	154
refilling	159
Engine oil level	
checking	153
Engine sprocket	
checking	79
Environment	10
F	
Filler cap	
closing	35
opening	34
Foot brake lever	39
basic position, adjusting	90
free travel, checking	89
Fork	59
compression damping, adjusting	59
fork legs, bleeding	70
rebound, adjusting	60
spring preload, adjusting	61
Fork part number	18
Front wheel	
installing	97

removing 96

Fuel tank

 positioning 73

 reinstalling 72

Fuel, oils, etc. 8

Fuse

 individual power consumers, changing 116

Fuses, ABS

 changing 115

H

Hand brake lever 19

 basic position, adjusting 85

Handrails 37

Headlight adjustment

 adjusting 134

 checking 134

Headlight bulb

 changing 118

Headlight flasher switch 21

Helmet lock 37

 mounting on vehicle 71

Horn button 22

I

Ignition curve

 adjusting to fuel quality 150

 plug-in connector 149

Ignition key

 activating/deactivating 135

Ignition lock 23

Immobilizer 24

Indicator lamps 26

K

Key number 17

L

License plate lamp

 changing 132

Light switch 20

M

Main fuse

 changing 113

Motorcycle

 cleaning 161

 raising with the front wheel stand 68

 raising with the rear wheel stand 69

 taking off of the front wheel stand 68

 taking off of the rear wheel stand 69

O

Oil filter

 changing 154

Oil screens	
cleaning	154
Owner's manual	11
P	
Parking	53
Parking light bulb	
changing	121
Passenger footrests	38
Play in throttle cable	
adjusting	149
checking	148
Preparing for use	
after storage	165
checks and maintenance measures when preparing for use	45
information on first use	41
R	
Rear hub shock absorber	
checking	104
Rear sprocket	
checking	79
Rear wheel	
installing	101
removing	99
Refueling	
fuel	54

Riding	48
starting off	48
S	
Seat	
mounting	71
removing	70
Seat lock	36
Service	8
Service schedule	56-58
Shift lever	38
basic position, adjusting	151
basic position, checking	151
Shifting	48
Shock absorber	59
compression damping, general	63
compression damping, high-speed, adjusting	64
compression damping, low-speed, adjusting	63
rebound damping, adjusting	65
spring preload, adjusting	66
Shock absorber part number	18
Side stand	40
Spare parts	9
Starting	46
Steering lock	23
Stopping	53
Storage	164

T

Tachometer	25
Tail lamp bulbs	
changing	128
Technical data	
chassis	182-184
chassis tightening torques	188-190
engine	177-178
engine tightening torques	179-181
fork	185
shock absorber	186-187
Throttle grip	20
Tire air pressure	
checking	106
Tire condition	
checking	105
Tool set	36
Transport	9
Troubleshooting	166-168
Turn signal bulb	
changing	123
Turn signal switch	21
Type label	16

U

Use definition	8
---------------------------------	---

V

Vehicle	
loading	42
View of vehicle	
front left	12
rear right	14
W	
Warning of slippery roads	33
Warranty	8
Winter operation	
checks and maintenance measures	163
Work rules	9



3211794en



11/2011 Photo: Mitterbauer



KTM-Sportmotorcycle AG
5230 Mattighofen/Austria
<http://www.ktm.com>