

50 SX
50 SX Mini

Art. no. 3211912en



KTM

The work described in these setup instructions must be performed before the vehicle is delivered to the customer.

Read the setup instructions in their entirety before beginning work.

Print out the current **PDI** form found on the **KTM DEALER.NET**.

These setup instructions were written to correspond to the latest state of this series. We reserve the right to make changes in the interest of technical advancement without at the same time updating these setup instructions.

We shall not provide a description of general workshop methods. Likewise, safety rules that apply in a workshop are not specified here. It is assumed that the work will be performed by a fully trained mechanic.

All specifications are non-binding. KTM Sportmotorcycle AG specifically reserves the right to modify or delete technical specifications, prices, colors, forms, materials, services, designs, equipment, etc., without prior notice and without specifying reasons, to adapt these to local conditions, as well as to stop production of a particular model without prior notice. KTM accepts no liability for delivery options, deviations from illustrations and descriptions, as well as misprints and other errors. The models portrayed partly contain special equipment that does not belong to the regular scope of supply.

© 2012 KTM-Sportmotorcycle AG, Mattighofen Austria

All rights reserved

Reproduction, even in part, as well as copying of all kinds, is permitted only with the express written permission of the copyright owner.



ISO 9001(12 100 6061)

According to the international quality management standard ISO 9001, KTM uses quality assurance processes that lead to the maximum possible quality of the products.

Issued by: TÜV Management Service

REG.NO. 12 100 6061

KTM-Sportmotorcycle AG
5230 Mattighofen, Austria

1.1 Symbols used

The meaning of specific symbols is described below.



Indicates an expected reaction (e.g. of a work step or a function).



Indicates an unexpected reaction (e.g. of a work step or a function).



Indicates a page reference (more information is provided on the specified page).



Indicates information with more details or tips.



Indicates the result of a testing step.



Denotes a voltage measurement.



Denotes a current measurement.



Denotes a resistance measurement.

1.2 Formats used

The typographical formats used in this document are explained below.

Proprietary name Identifies a proprietary name.

Name[®] Identifies a protected name.

Brand[™] Identifies a trademark.

2.1 Unpacking and setting up the vehicle



- Open the box.

i Info

To avoid damaging the vehicle while setting it up, do not remove the protective film on each component until installing the component, and leave it on the vehicle until work has been completed.

- Remove the separate enclosure and unpack it. Check that the scope of supply is complete on the basis of the enclosed packing list.
- Lift the vehicle out of the box with the assistance of another person.
- Raise the motorcycle with a lift stand. (☛ p. 4)
- Check the vehicle for transport damage.
- Remove the protective film from the handlebar.
- Position the handlebar with handlebar clamps.
- Mount and tighten screws.

Guideline

Screw, handlebar clamp	M8	20 Nm (14.8 lbf ft)
------------------------	----	------------------------

- Check the handlebar position.
 - » If the handlebar position is not adjusted as required by the customer:
 - Adjust the handlebar position. ☛ (☛ p. 4)
- Remove the screw of the brake line guide. Position the brake line. Mount the brake line guide again and tighten the screw.
- Check the wiring harness, cables, and brake line for freedom of movement and correct routing.
- Check that the controls on the handlebar are correctly positioned and firmly seated.
- Mount the footrests with the springs and pins. Secure the pins using the washers and cotter pins.

Pliers for footrest spring (58429083000)

- Fill up with fuel. (☛ p. 5)

(50 SX Mini)

- Fill up with oil. (☛ p. 6)
- Remove the motorcycle from the lift stand. (☛ p. 4)
- Park the vehicle on the plug-in stand.
- Print out the current **PDI** form found on **KTM DEALER.NET** and perform the delivery inspection.



3.1 Raising the motorcycle with a lift stand

Note

Danger of damage The parked vehicle may roll away or fall over.

- Always place the vehicle on a firm and even surface.

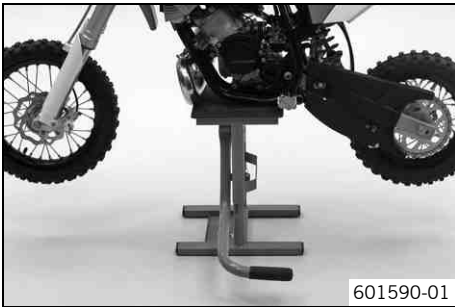

- Raise the motorcycle at the frame underneath the engine.

Lift stand (59229055000)

- ✓ The tires should no longer be in contact with the ground.
- Secure the motorcycle against falling over.

3.2 Removing the motorcycle from the lift stand

Note

Danger of damage The parked vehicle may roll away or fall over.

- Always place the vehicle on a firm and even surface.

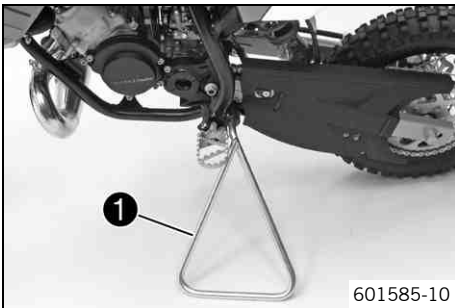

- Remove the motorcycle from the lift stand.
- Remove the lift stand.
- To park the motorcycle, insert plug-in stand ❶ into the plug-in stand bracket on the left side of the vehicle.

i Info

Remove the plug-in stand before riding.

3.3 Adjusting handlebar position

Warning

Danger of accidents Handlebar breakage.

- If the handlebar is bent or straightened it will cause material fatigue, and the handlebar can break. Always replace handlebar.

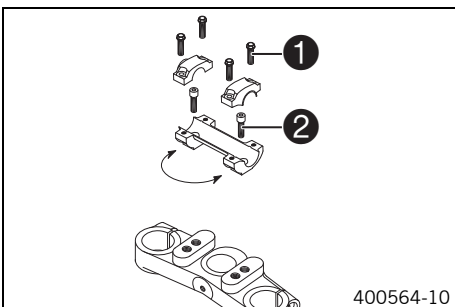

- Remove the four screws ❶. Remove the handlebar clamps. Remove the handlebar and lay it to one side.

i Info

Protect the motorcycle and its attachments from damage by covering them. Do not bend the cables and lines.

- Remove the two screws ❷. Remove the handlebar support.
- Place the handlebar support in the required position. Mount and tighten the two screws ❷.

Guideline

Screw, handlebar support	M10	40 Nm (29.5 lbf ft)	Loctite® 243™
--------------------------	-----	------------------------	---------------

- Position the handlebar.

i Info

Make sure cables and wiring are positioned correctly.

- Position the handlebar clamps. Mount and evenly tighten the four screws ❶.

Guideline

Screw, handlebar clamp	M8	20 Nm (14.8 lbf ft)
------------------------	----	------------------------

Info
Make sure the gap width is even.

3.4 Refueling

Danger
Fire hazard Fuel is highly flammable.

- Never refuel the vehicle near open flames or burning cigarettes, and always switch off the engine first. Be careful that no fuel is spilt, especially on hot vehicle components. Clean up spilt fuel immediately.
- Fuel in the fuel tank expands when warm and can escape if the tank is overfilled. See the notes on refueling.

Warning
Danger of poisoning Fuel is poisonous and a health hazard.

- Avoid contact of the fuel with skin, eyes and clothing. Do not inhale fuel vapors. If fuel gets into your eyes, rinse immediately with water and contact a doctor. Wash affected skin areas immediately with soap and water. If fuel is swallowed, contact a doctor immediately. Change clothing that has come into contact with fuel.

Warning
Environmental hazard Improper handling of fuel is a danger to the environment.

- Do not allow fuel to get into the ground water, the ground, or the sewage system.

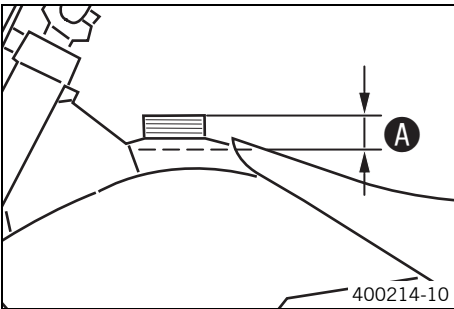

- Switch off the engine.
- Open the filler cap. (☛ p. 5)
- Fill the fuel tank with fuel up to measurement A.

Guideline

Measurement of A	35 mm (1.38 in)	
Fuel tank capacity, approx. (50 SX Mini)	2.0 l (2.1 qt.)	Super unleaded (ROZ 95/RON 95/PON 91) (☛ p. 9)
Fuel tank capacity, approx. (50 SX)	2.3 l (2.4 qt.)	Super unleaded gasoline (95 octane), mixed with 2-stroke engine oil (1:60) (☛ p. 9)

- Close the filler cap. (☛ p. 6)

3.5 Opening filler cap

Danger
Fire hazard Fuel is highly flammable.

- Never refuel the vehicle near open flames or burning cigarettes, and always switch off the engine first. Be careful that no fuel is spilt, especially on hot vehicle components. Clean up spilt fuel immediately.
- Fuel in the fuel tank expands when warm and can escape if the tank is overfilled. See the notes on refueling.

Warning
Danger of poisoning Fuel is poisonous and a health hazard.

- Avoid contact between fuel and skin, eyes and clothing. Do not inhale fuel vapors. If fuel gets into your eyes, rinse immediately with water and contact a doctor. Wash affected skin areas immediately with soap and water. If fuel is swallowed, contact a doctor immediately. Change clothing that has come into contact with fuel. Store fuel in a suitable canister according to regulations and keep it out of the reach of children.

Warning
Environmental hazard Improper handling of fuel is a danger to the environment.

- Do not allow fuel to get into the ground water, the ground, or the sewage system.

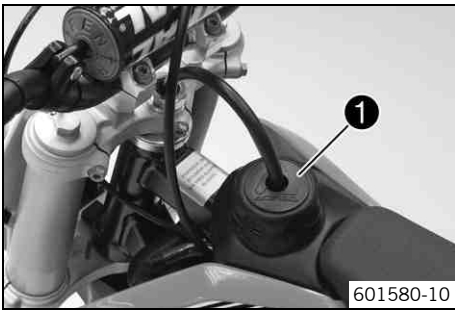

- Turn the tank cap ❶ counterclockwise and pull it up.

3.6 Closing filler cap

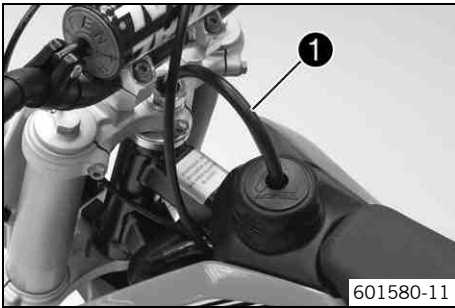

- Put the tank cap on and turn it clockwise.



Info

Run the fuel tank breather hose ❶ without kinks.

3.7 Filling up with oil (50 SX Mini)



Warning

Engine failure If the vehicle is run without 2-stroke oil in the tank, the result is engine failure.

- The oil tank must always be filled up to the **MIN** mark.

- Switch off the engine.
- Open the oil tank cap. (☛ p. 6)
- Fill the oil tank at least up to the **MIN** mark ❶.

Guideline

MIN mark	Sufficient for a single tank filling	
Oil tank contents ca.	0.2 l (0.2 qt.)	2-stroke engine oil (☛ p. 9)

- Close the oil tank cap. (☛ p. 7)

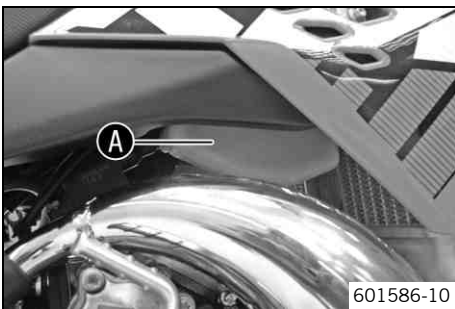

3.8 Opening oil tank cap (50 SX Mini)



- Turn the oil tank cap ❶ counterclockwise and pull it up.

3.9 Closing oil tank cap (50 SX Mini)



- Put the oil tank cap on and turn it clockwise.



Info

Run the oil tank breather hose ❶ without kinks.

4 TECHNICAL DATA - TIGHTENING TORQUES FOR CHASSIS

Spoke nipple	M3.5	3 Nm (2.2 lbf ft)	–
Screw, brake linings	M5	8 Nm (5.9 lbf ft)	–
Rear brake caliper screw	M6	10 Nm (7.4 lbf ft)	Loctite® 243™
Remaining nuts, chassis	M6	10 Nm (7.4 lbf ft)	–
Remaining screws, chassis	M6	10 Nm (7.4 lbf ft)	–
Screw, ball joint of push rod on foot brake cylinder	M6	10 Nm (7.4 lbf ft)	–
Screw, chain sliding piece	M6	3 Nm (2.2 lbf ft)	–
Screw, fork stub	M6	10 Nm (7.4 lbf ft)	–
Screw, front brake disc	M6	14 Nm (10.3 lbf ft)	Loctite® 243™
Screw, rear brake disc	M6	14 Nm (10.3 lbf ft)	Loctite® 243™
Screw, throttle grip	M6	4.5 Nm (3.32 lbf ft)	–
Screw, rear sprocket	M7	15 Nm (11.1 lbf ft)	Loctite® 243™
Engine carrying screw	M8	25 Nm (18.4 lbf ft)	–
Nut, foot brake lever	M8	22 Nm (16.2 lbf ft)	–
Nut, rim lock	M8	10 Nm (7.4 lbf ft)	–
Remaining nuts, chassis	M8	25 Nm (18.4 lbf ft)	–
Remaining screws, chassis	M8	25 Nm (18.4 lbf ft)	–
Screw, bottom triple clamp	M8	15 Nm (11.1 lbf ft)	–
Screw, chain sliding piece	M8	15 Nm (11.1 lbf ft)	–
Screw, front brake caliper	M8	20 Nm (14.8 lbf ft)	Loctite® 243™
Screw, handlebar clamp	M8	20 Nm (14.8 lbf ft)	–
Screw, top triple clamp	M8	20 Nm (14.8 lbf ft)	–
Front wheel spindle nut	M10	40 Nm (29.5 lbf ft)	–
Nut, swingarm pivot	M10	45 Nm (33.2 lbf ft)	–
Remaining nuts, chassis	M10	45 Nm (33.2 lbf ft)	–
Remaining screws, chassis	M10	45 Nm (33.2 lbf ft)	–
Screw, bottom shock absorber	M10	45 Nm (33.2 lbf ft)	–
Screw, handlebar support	M10	40 Nm (29.5 lbf ft)	Loctite® 243™
Screw, top shock absorber	M10	45 Nm (33.2 lbf ft)	–
Nut, rear wheel spindle	M12x1	40 Nm (29.5 lbf ft)	–
Nut, steering head	M20x1.5	No play ≤ 10 Nm (≤ 7.4 lbf ft)	–

2-stroke engine oil

According to

- JASO FC (☛ p. 10)

Guideline

- Only use high quality 2-stroke engine oil of a well-known brand. KTM recommends **Motorex®** products.

Fully synthetic

Supplier

Motorex®

- **Cross Power 2T**

Super unleaded (ROZ 95/RON 95/PON 91)

According to

- DIN EN 228 (ROZ 95/RON 95/PON 91)

Guideline

- Only use unleaded super fuel that matches or is equivalent to the specified fuel grade.
- Fuel with an ethanol content of up to 10 % (E10 fuel) is safe to use.



Info

Do **not** use fuel containing methanol (e. g. M15, M85, M100) or more than 10 % ethanol (e. g. E15, E25, E85, E100).

Super unleaded gasoline (95 octane), mixed with 2-stroke engine oil (1:60)

According to

- DIN EN 228
- JASO FC (☛ p. 10) (1:60)

Mixture ratio

1:60	2-stroke engine oil (☛ p. 9) Super unleaded (ROZ 95/RON 95/PON 91) (☛ p. 9)
------	--

Supplier

Motorex®

- **Cross Power 2T**

JASO FC

JASO FC is a classification for a 2-stroke engine oil that was specifically developed for the extreme demands of racing. Thanks to first rate synthetic esters and specially designed additives, superb combustion is achieved even under extreme operating conditions.



3211912en

08/2012

