

**250 SX-F EU**  
**250 SX-F USA**  
**250 XC-F USA**

Art. no. 3211914en



**KTM**



The work described in these setup instructions must be performed before the vehicle is delivered to the customer.

Read the setup instructions in their entirety before beginning work.

Print out the current **PDI** form found on the **KTM DEALER.NET**.

These setup instructions were written to correspond to the latest state of this series. We reserve the right to make changes in the interest of technical advancement without at the same time updating these setup instructions.

We shall not provide a description of general workshop methods. Likewise, safety rules that apply in a workshop are not specified here. It is assumed that the work will be performed by a fully trained mechanic.

All specifications are non-binding. KTM Sportmotorcycle AG specifically reserves the right to modify or delete technical specifications, prices, colors, forms, materials, services, designs, equipment, etc., without prior notice and without specifying reasons, to adapt these to local conditions, as well as to stop production of a particular model without prior notice. KTM accepts no liability for delivery options, deviations from illustrations and descriptions, as well as misprints and other errors. The models portrayed partly contain special equipment that does not belong to the regular scope of supply.

© 2012 KTM-Sportmotorcycle AG, Mattighofen Austria

All rights reserved

Reproduction, even in part, as well as copying of all kinds, is permitted only with the express written permission of the copyright owner.



ISO 9001(12 100 6061)

According to the international quality management standard ISO 9001, KTM uses quality assurance processes that lead to the maximum possible quality of the products.

Issued by: TÜV Management Service

REG.NO. 12 100 6061

KTM-Sportmotorcycle AG  
5230 Mattighofen, Austria

## 1.1 Symbols used

The meaning of specific symbols is described below.



Indicates an expected reaction (e.g. of a work step or a function).



Indicates an unexpected reaction (e.g. of a work step or a function).



Indicates a page reference (more information is provided on the specified page).



Indicates information with more details or tips.



Indicates the result of a testing step.



Denotes a voltage measurement.



Denotes a current measurement.



Denotes a resistance measurement.

## 1.2 Formats used

The typographical formats used in this document are explained below.

**Proprietary name** Identifies a proprietary name.

**Name<sup>®</sup>** Identifies a protected name.

**Brand<sup>™</sup>** Identifies a trademark.

## 2.1 Unpacking and setting up the vehicle

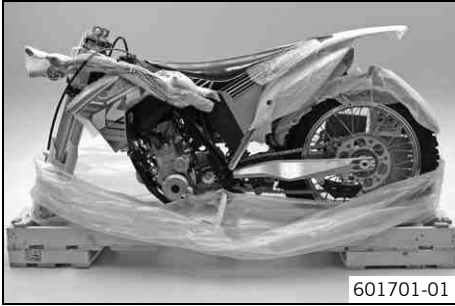

### Packaging 2

- Remove the box and the plastic packaging.

**i** **Info**

To avoid damaging the motorcycle during the setup, leave the protective film on the vehicle until you have finished.

- Remove the separate enclosure and unpack it. Check that the scope of supply is complete on the basis of the enclosed packing list.
- Have a lift stand available.

Lift stand (54829055000)

- Carefully loosen and remove the tension belt of the footrest mount.

**i** **Info**

An assistant prevents the motorcycle from falling over.

- Together with an assistant, take the vehicle off the pallette.
- Position the vehicle on a lift stand.
- Check the vehicle for transport damage.

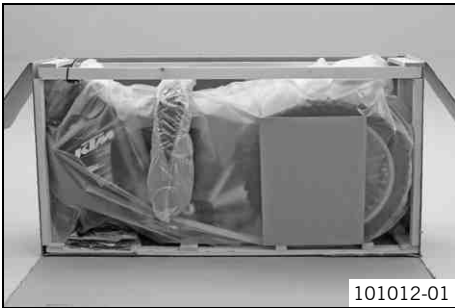

### Package 12

- Remove the box and the plastic packaging.

**i** **Info**

An assistant prevents the motorcycle from falling over.  
To avoid damaging the motorcycle during the setup, leave the protective film on the vehicle until you have finished.

- Remove the separate enclosure and unpack it. Check that the scope of supply is complete on the basis of the enclosed packing list.
- Have a lift stand available.

Lift stand (54829055000)

- Together with an assistant, take the vehicle off the pallette.
- Position the vehicle on a lift stand.
- Check the vehicle for transport damage.

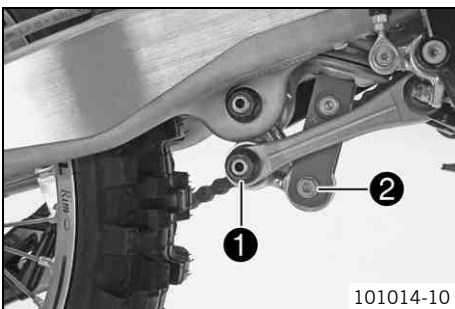

- Remove the cardboard from around the shock absorber.
- Position the angle lever and linkage lever.
- Mount and tighten screw cap ①.

Guideline

Nut, frame to linkage lever	M14x1.5	80 Nm (59 lbf ft)	<b>Loctite® 2701</b>
-----------------------------	---------	-------------------	----------------------

- Mount and tighten screw ②.

Guideline

Screw, bottom shock absorber	M10	60 Nm (44.3 lbf ft)	<b>Loctite® 2701</b>
------------------------------	-----	---------------------	----------------------

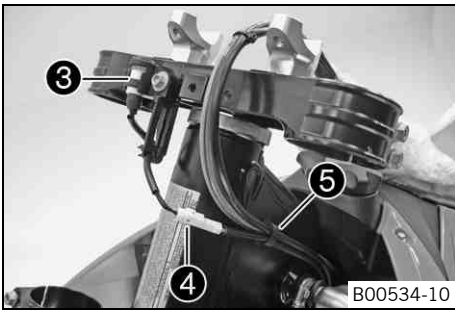

B00534-10

- Position FI warning lamp with holder ③. Mount and tighten screw.

Guideline

Remaining screws, chassis	M6	10 Nm (7.4 lbf ft)
---------------------------	----	-----------------------

- Attach connector ④ to the wiring harness.
- Mount cable holder ⑤ to the frame.

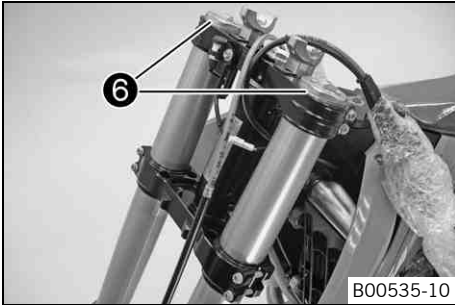

B00535-10

- Route the clutch line with the clutch master cylinder toward the front between the upper and lower triple clamps.
- Position the fork legs and tighten the screws of the triple clamp.

Guideline

Screw, top triple clamp	M8	17 Nm (12.5 lbf ft)
Screw, bottom triple clamp	M8	12 Nm (8.9 lbf ft)

**i** Info

Grooves are milled into the side of the top end of the fork legs. The second milled groove (from the top) in the fork leg must be flush with the upper edge of the upper triple clamp.  
Position bleeder screws ⑥ toward the front.

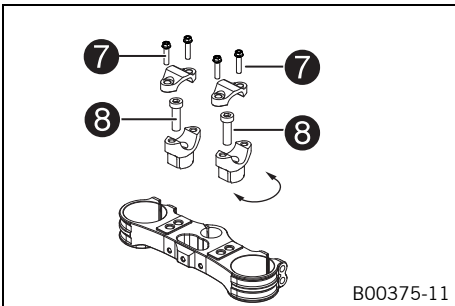

B00375-11

- Remove screws ⑦. Take off the handlebar clamps.
- Remove screws ⑧. Remove the handlebar holders.
- Place the handlebar holders in the required position. Mount and tighten screws ⑧.

Guideline

Screw, handlebar support	M10	40 Nm (29.5 lbf ft)	<b>Loctite® 243™</b>
--------------------------	-----	------------------------	----------------------

**i** Info

Position the left and right handlebar holders evenly.

- Position the handlebar.

**i** Info

Make sure the cables and wiring are positioned correctly.

- Position the handlebar clamps. Mount and tighten the screws evenly.

Guideline

Screw, handlebar clamp	M8	20 Nm (14.8 lbf ft)
------------------------	----	------------------------

**i** Info

The markings on the handlebar should be at the center of the handlebar clamps.  
Keep the gap widths equal when tightening.

- Position the controls on the right half of the handlebar.

**i** Info

The routing of the cables is shown in the figure.



101020-10

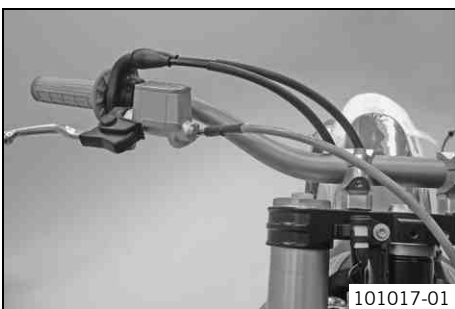

101017-01



- Position the controls on the left half of the handlebar.



**Info**

The figure shows how to route the clutch line and wiring harness.

- Install the front fender. (☛ p. 7)
- Install the front wheel. (☛ p. 6)
- Correctly mount the fuel tank breather.



- Mount the handlebar cushion.
- Install the start number plate. (☛ p. 7)

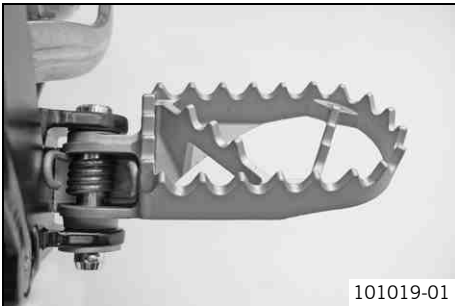

- Mount the footrests with the springs and pins. Secure the pins using the washers and cotter pins.

Pliers for footrest spring (58429083000)



- Mount the footrests with the springs and pins. Secure the pins using the washers and cotter pins.



**Warning**

**Risk of injury** Battery acid and battery gases cause serious chemical burns.

- Keep batteries out of the reach of children.
- Wear suitable protective clothing and goggles.
- Avoid contact with battery acid and battery gases.
- Keep the battery away from sparks or open flames. Charge only in well-ventilated areas.
- In the event of skin contact, rinse with large amounts of water. If battery acid gets in the eyes, rinse with water for at least 15 minutes and contact a physician.

- Fill the battery.



**Info**

Read the notes in the battery package.

- Recharge the battery. (☛ p. 9)
- Install the battery. (☛ p. 8)
- Unpack and mount the **KTM PowerParts** included in the delivery (optional).



**Info**

Read the accompanying **KTM PowerParts** fitting instructions.

- Apply the label included in the delivery (optional).
- Refuel. (☛ p. 11)
- Position all controls in their exact positions on the handlebar. Tighten all screws.
- Print out the current **PDI** form found on **KTM DEALER.NET** and perform the delivery inspection.

## 3.1 Raising the motorcycle with the lift stand

**Note**

**Danger of damage** The parked vehicle may roll away or fall over.

- Always place the vehicle on a firm and even surface.

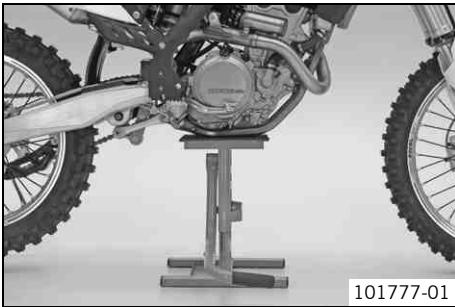

- Raise the motorcycle at the frame underneath the engine.
  - ✓ The wheels must no longer touch the ground.
- Secure the motorcycle against falling over.

Lift stand (54829055000)

## 3.2 Removing the motorcycle from the lift stand

**Note**

**Danger of damage** The parked vehicle may roll away or fall over.

- Always place the vehicle on a firm and even surface.

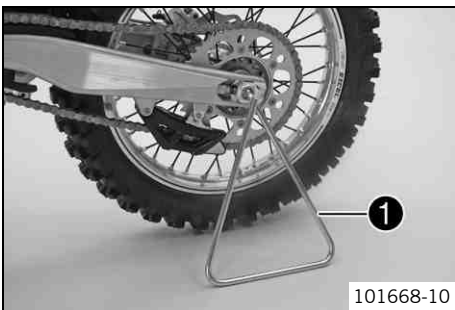

**(All SX-F models)**

- Remove the motorcycle from the lift stand.
- Remove the lift stand.
- To park the motorcycle, insert plug-in stand ❶ into the left side of the wheel spindle.



**Info**

Remove the plug-in stand before starting on a trip.

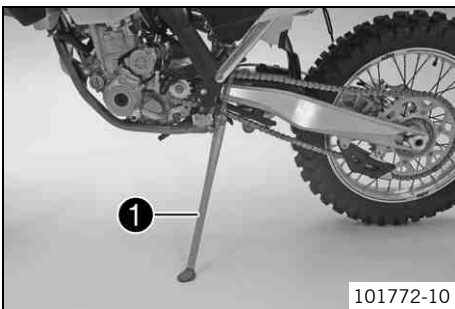

**(XC-F)**

- Remove the motorcycle from the lift stand.
- Remove the lift stand.
- To park the motorcycle, press side stand ❶ to the ground with your foot and lean the motorcycle on it.



**Info**

When you are riding, the side stand must be folded up and secured with the rubber band.

## 3.3 Installing the front wheel



**Warning**

**Danger of accidents** Reduced braking efficiency due to oil or grease on the brake discs.

- Always keep the brake discs free of oil and grease, and clean them with brake cleaner when necessary.

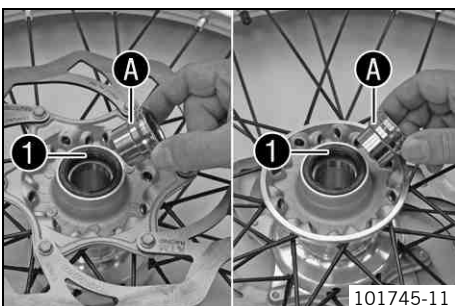

- Check the wheel bearing for damage and wear.
  - » If the wheel bearing is damaged or worn:
    - Change the wheel bearing.
- Clean and grease the shaft seal rings ❶ and contact surface A of the spacers.

Long-life grease (☛ p. 14)

- Insert the spacers.
- Lift the front wheel into the fork, position it, and insert the wheel spindle.



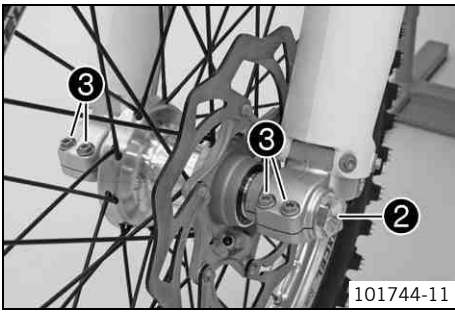

- Mount and tighten screw ②.

Guideline

Screw, front wheel spindle	M24x1.5	45 Nm (33.2 lbf ft)
----------------------------	---------	------------------------

- Activate the hand brake lever multiple times until the brake linings are in contact with the brake disc.
- Remove the motorcycle from the lift stand. (☛ p. 6)
- Pull the front brake and compress the fork powerfully a few times.
  - ✓ The fork legs straighten.
- Tighten screws ③.

Guideline

Screw, fork stub	M8	15 Nm (11.1 lbf ft)
------------------	----	------------------------

## 3.4 Installing the front fender

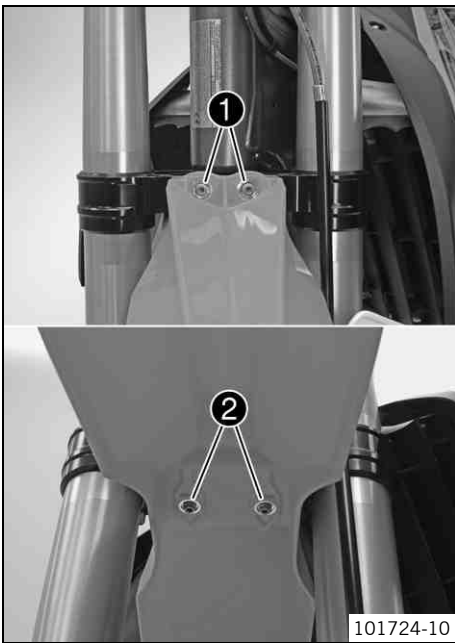

### Main work

- Ensure that the spacers are mounted in the fender.
- Position the front fender. Mount and tighten screws ① and ②.

Guideline

Remaining screws, chassis	M6	10 Nm (7.4 lbf ft)
---------------------------	----	--------------------

### Finishing work

- Install the start number plate. (☛ p. 7)

## 3.5 Installing the start number plate

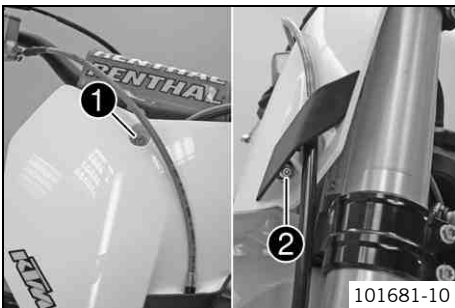

- Position the start number plate. Mount and tighten screw ①.

Guideline

Remaining screws, chassis	M6	10 Nm (7.4 lbf ft)
---------------------------	----	--------------------



### Info

Make sure that the holding lugs engage in the fender.

- Position the brake line and clamp. Mount and tighten screw ②.

## 3.6 Removing the seat

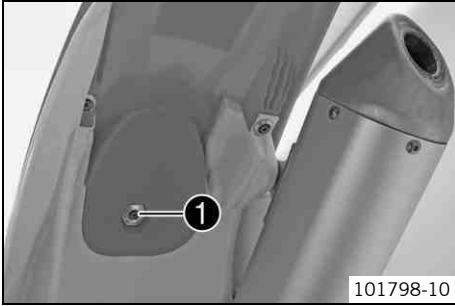

- Remove screw ❶.
- Lift up the seat at the rear, pull it back and then remove it from above.

## 3.7 Mounting the seat



- Hook in the front of the seat at the collar bushing of the fuel tank, lower it at the rear and simultaneously it push forward.
- Make sure that the seat is correctly locked in.
- Mount and tighten the screw of the seat fixation.

Guideline

Remaining screws, chassis	M6	10 Nm (7.4 lbf ft)
---------------------------	----	--------------------

## 3.8 Installing the battery

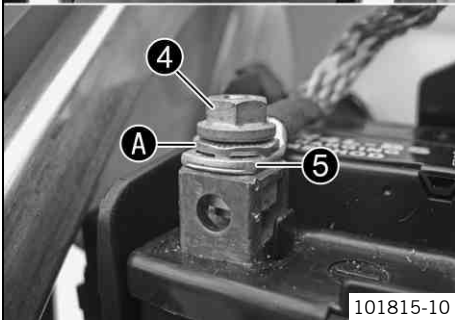
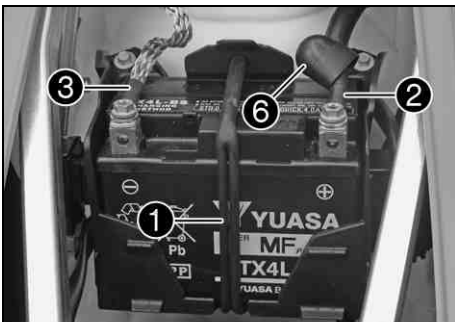

### Main work

- Insert the battery into the battery compartment with the terminals facing to the front.

(All SX-F models)

Battery (YTX4L-BS)

(XC-F)

Battery (YTX5L-BS)

- Reconnect rubber band ❶.
- Connect positive cable ❷.

Guideline

Screw, battery terminal	M5	2.5 Nm (1.84 lbf ft)
-------------------------	----	-------------------------

**i** Info

Contact disks **A** must be mounted between screws ❹ and cable sockets ❺ with the claws facing down.

- Slide positive terminal cover ❸ over the positive terminal.
- Connect negative cable ❸.

Guideline

Screw, battery terminal	M5	2.5 Nm (1.84 lbf ft)
-------------------------	----	-------------------------

**i** Info

Contact disk **A** must be mounted between screw ❹ and cable socket ❺ with the claws facing down.

### Finishing work

- Mount the seat. (☛ p. 8)

## 3.9 Recharging the battery

- Warning**  
**Risk of injury** Battery acid and battery gases cause serious chemical burns.
- Keep batteries out of the reach of children.
  - Wear suitable protective clothing and goggles.
  - Avoid contact with battery acid and battery gases.
  - Keep the battery away from sparks or open flames. Charge only in well-ventilated areas.
  - In the event of skin contact, rinse with large amounts of water. If battery acid gets in the eyes, rinse with water for at least 15 minutes and contact a physician.

- Warning**  
**Environmental hazard** The battery contains elements that are harmful to the environment.
- Do not discard batteries with the household trash. Dispose of a defective battery in an environmentally compatible manner. Give the battery to your KTM dealer or to a recycling center that accepts used batteries.

- Warning**  
**Environmental hazard** Hazardous substances cause environmental damage.
- Oil, grease, filters, fuel, cleaners, brake fluid, etc., should be disposed of as stipulated in applicable regulations.

**i Info**  
 Even when there is no load on the battery, it still loses power steadily.  
 The charge state and the type of charge are very important for the service life of the battery.  
 Rapid recharging with a high charging current shortens the battery's service life.  
 If the charging current, charging voltage and charging time are exceeded, electrolyte escapes through the safety valves. This reduces the battery capacity.  
 If the battery is depleted from starting the vehicle repeatedly, the battery must be charged immediately.  
 If the battery is left in a discharged state for an extended period, it will become over-discharged and sulfate, destroying the battery.  
 The battery is maintenance-free, i.e., the acid level does not have to be checked.

### Preparatory work

- Switch off all power consumers and switch off the engine.
- Remove the seat. (☛ p. 8)
- Disconnect the negative (minus) cable of the battery to avoid damage to the motorcycle's electronics.

### Main work

- Connect the battery charger to the battery. Switch on the battery charger.

Battery charger (58429074000)

You can also use the battery charger to test rest potential and start potential of the battery, and to test the alternator. With this device, you cannot overcharge the battery.

**i Info**  
 Never remove cover ①.  
 Charge the battery with a maximum of 10% of the capacity specified on the battery housing ②.

- Switch off the charger after charging. Disconnect the battery.

### Guideline

The charge current, charge voltage and charge time must not be exceeded.

Charge the battery regularly when the motorcycle is not in use	3 months
--	----------

### Finishing work

- Mount the seat. (☛ p. 8)



## 3.10 Opening the filler cap



### Danger

**Fire hazard** Fuel is highly flammable.

- Never refuel the vehicle near open flames or burning cigarettes, and always switch off the engine first. Be careful that no fuel is spilt, especially on hot vehicle components. Clean up spilt fuel immediately.
- Fuel in the fuel tank expands when warm and can escape if the tank is overfilled. See the notes on refueling.



### Warning

**Danger of poisoning** Fuel is poisonous and a health hazard.

- Avoid contact between fuel and skin, eyes and clothing. Do not inhale fuel vapors. If fuel gets into your eyes, rinse immediately with water and contact a doctor. Wash affected skin areas immediately with soap and water. If fuel is swallowed, contact a doctor immediately. Change clothing that has come into contact with fuel. Store fuel in a suitable canister according to regulations and keep it out of the reach of children.



### Warning

**Environmental hazard** Improper handling of fuel is a danger to the environment.

- Do not allow fuel to get into the ground water, the ground, or the sewage system.

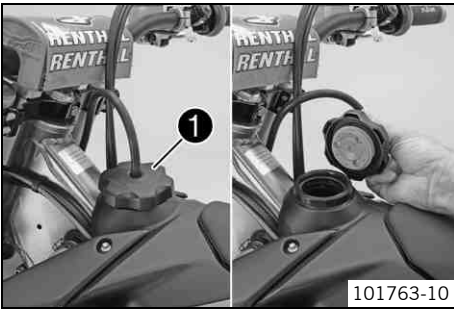

### (All SX-F models)

- Turn filler cap ❶ counterclockwise and lift it off.

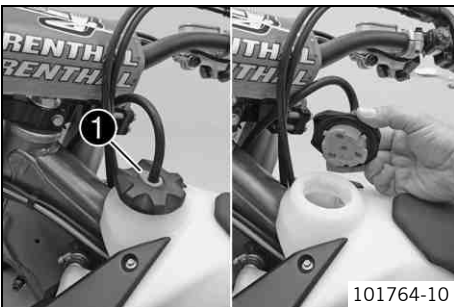

### (XC-F)

- Press release button ❶, turn the filler cap counterclockwise, and lift it off.

## 3.11 Closing the filler cap

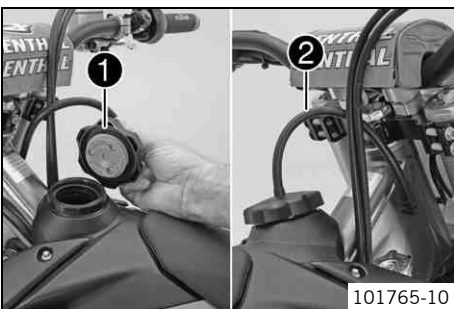

### (All SX-F models)

- Mount filler cap ❶ and turn it clockwise until the fuel tank is tightly closed.



### Info

Run the fuel tank breather hose ❷ without kinks.

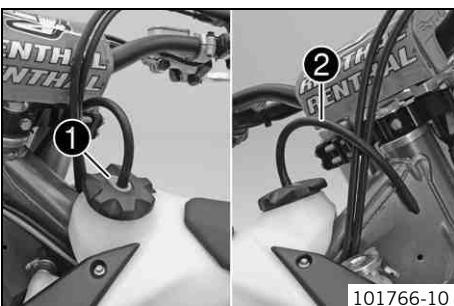

### (XC-F)

- Replace the filler cap and turn clockwise until the release button ❶ locks in place.



### Info

Run the fuel tank breather hose ❷ without kinks.

## 3.12 Refueling



### Danger

**Fire hazard** Fuel is highly flammable.

- Never refuel the vehicle near open flames or burning cigarettes, and always switch off the engine first. Be careful that no fuel is spilt, especially on hot vehicle components. Clean up spilt fuel immediately.
- Fuel in the fuel tank expands when warm and can escape if the tank is overfilled. See the notes on refueling.



### Warning

**Danger of poisoning** Fuel is poisonous and a health hazard.

- Avoid contact of the fuel with skin, eyes and clothing. Do not inhale fuel vapors. If fuel gets into your eyes, rinse immediately with water and contact a doctor. Wash affected skin areas immediately with soap and water. If fuel is swallowed, contact a doctor immediately. Change clothing that has come into contact with fuel.

### Note

**Material damage** Premature clogging of the fuel filter.

- In some countries and regions, the available fuel quality and cleanliness may not be sufficient. This will result in problems with the fuel system.
- Only refuel with clean fuel that meets the specified standards.



### Warning

**Environmental hazard** Improper handling of fuel is a danger to the environment.

- Do not allow fuel to get into the ground water, the ground, or the sewage system.

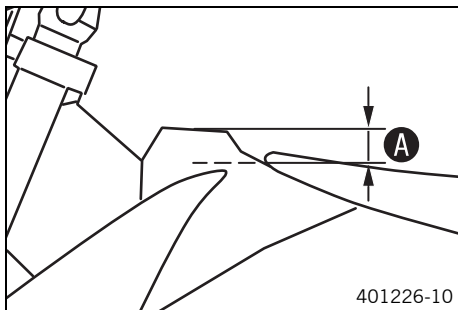

- Switch off the engine.
- Open the filler cap. (☛ p. 10)
- Fill the fuel tank with fuel up to measurement **A**.

Guideline

Measurement of <b>A</b>	35 mm (1.38 in)	
Total fuel tank capacity, approx. (All SX-F models)	7.5 l (1.98 US gal)	Super unleaded (ROZ 95/RON 95/PON 91) (☛ p. 13)
Total fuel tank capacity, approx. (XC-F)	9 l (2.4 US gal)	Super unleaded (ROZ 95/RON 95/PON 91) (☛ p. 13)

- Close the filler cap. (☛ p. 10)

# 4 TECHNICAL DATA - TIGHTENING TORQUES FOR CHASSIS

Screw, air filter box lid	EJOT PT® K60x20-Z	3 Nm (2.2 lbf ft)	–
Spoke nipple, front wheel	M4.5	5... 6 Nm (3.7... 4.4 lbf ft)	–
Spoke nipple, rear wheel	M4.5	5... 6 Nm (3.7... 4.4 lbf ft)	–
Screw, battery terminal	M5	2.5 Nm (1.84 lbf ft)	–
Screw, intake air temperature sensor	M5	2 Nm (1.5 lbf ft)	–
Screw, shock absorber adjusting ring	M5	5 Nm (3.7 lbf ft)	–
Remaining nuts, chassis	M6	10 Nm (7.4 lbf ft)	–
Remaining screws, chassis	M6	10 Nm (7.4 lbf ft)	–
Screw, ball joint of push rod on foot brake cylinder	M6	10 Nm (7.4 lbf ft)	Loctite® 243™
Screw, chain sliding guard	M6	6 Nm (4.4 lbf ft)	Loctite® 243™
Screw, front brake disc	M6	14 Nm (10.3 lbf ft)	Loctite® 243™
Screw, rear brake disc	M6	14 Nm (10.3 lbf ft)	Loctite® 243™
Screw, throttle grip	M6	3 Nm (2.2 lbf ft)	–
Fuel connection on fuel tank	M8	10 Nm (7.4 lbf ft)	–
Nut, foot brake lever stop	M8	20 Nm (14.8 lbf ft)	–
Nut, rear sprocket screw	M8	35 Nm (25.8 lbf ft)	Loctite® 2701
Nut, rim lock	M8	10 Nm (7.4 lbf ft)	–
Remaining nuts, chassis	M8	25 Nm (18.4 lbf ft)	–
Remaining screws, chassis	M8	25 Nm (18.4 lbf ft)	–
Screw, bottom triple clamp	M8	12 Nm (8.9 lbf ft)	–
Screw, chain sliding piece	M8	15 Nm (11.1 lbf ft)	–
Screw, engine brace	M8	33 Nm (24.3 lbf ft)	–
Screw, fork stub	M8	15 Nm (11.1 lbf ft)	–
Screw, front brake caliper	M8	25 Nm (18.4 lbf ft)	Loctite® 243™
Screw, handlebar clamp	M8	20 Nm (14.8 lbf ft)	–
Screw, side stand attachment (XC-F)	M8	45 Nm (33.2 lbf ft)	Loctite® 2701
Screw, subframe	M8	35 Nm (25.8 lbf ft)	Loctite® 2701
Screw, top steering stem	M8	17 Nm (12.5 lbf ft)	Loctite® 243™
Screw, top triple clamp	M8	17 Nm (12.5 lbf ft)	–
Engine carrying screw	M10	60 Nm (44.3 lbf ft)	–
Remaining nuts, chassis	M10	45 Nm (33.2 lbf ft)	–
Remaining screws, chassis	M10	45 Nm (33.2 lbf ft)	–
Screw, bottom shock absorber	M10	60 Nm (44.3 lbf ft)	Loctite® 2701
Screw, handlebar support	M10	40 Nm (29.5 lbf ft)	Loctite® 243™
Screw, top shock absorber	M10	60 Nm (44.3 lbf ft)	Loctite® 2701
Nut, fuel pump	M12	15 Nm (11.1 lbf ft)	–
Nut, seat fixing	M12x1	20 Nm (14.8 lbf ft)	–
Nut, frame to linkage lever	M14x1.5	80 Nm (59 lbf ft)	Loctite® 2701
Nut, linkage lever on swingarm	M14x1.5	80 Nm (59 lbf ft)	–
Nut, linkage lever to angle lever	M14x1.5	80 Nm (59 lbf ft)	–
Nut, swingarm pivot	M16x1.5	100 Nm (73.8 lbf ft)	–
Screw, top steering head	M20x1.5	12 Nm (8.9 lbf ft)	–
Screw-in nozzles, cooling system	M20x1.5	12 Nm (8.9 lbf ft)	Loctite® 243™
Screw, front wheel spindle	M24x1.5	45 Nm (33.2 lbf ft)	–
Nut, rear wheel spindle	M25x1.5	80 Nm (59 lbf ft)	–

## Super unleaded (ROZ 95/RON 95/PON 91)

### According to

- DIN EN 228 (ROZ 95/RON 95/PON 91)

### Guideline

- Only use unleaded super fuel that matches or is equivalent to the specified fuel grade.
- Fuel with an ethanol content of up to 10 % (E10 fuel) is safe to use.



### Info

Do **not** use fuel containing methanol (e. g. M15, M85, M100) or more than 10 % ethanol (e. g. E15, E25, E85, E100).

## Long-life grease

### Guideline

- KTM recommends **Motorex®** products.

### Supplier

#### Motorex®

- **Bike Grease 2000**





3211914en

07/2012

