

1190 Adventure EU
1190 Adventure FR
1190 Adventure AUS
1190 Adventure JP

Art. no. 3211955en



DEAR KTM CUSTOMER

Congratulations on your decision to purchase a KTM motorcycle. You are now the owner of a state-of-the-art sports motorcycle that will give you enormous pleasure if you service and maintain it accordingly.

We wish you a lot of enjoyment in riding this vehicle.

Please enter the serial numbers of your vehicle below.

| | |
|--------------------------|----------------|
| Chassis number (☛ p. 20) | Dealer's stamp |
| Engine number (☛ p. 21) | |
| Key number (☛ p. 21) | |

The owner's manual contained the latest information for this model at the time of going to print. Minor differences due to developments in design cannot be ruled out completely.

All specifications are non-binding. KTM Sportmotorcycle AG specifically reserves the right to modify or delete technical specifications, prices, colors, forms, materials, services, designs, equipment, etc., without prior notice and without specifying reasons, to adapt these to local conditions, as well as to stop production of a particular model without prior notice. KTM accepts no liability for delivery options, deviations from illustrations and descriptions, as well as misprints and other errors. The models portrayed partly contain special equipment that does not belong to the regular scope of supply.

© 2013 KTM-Sportmotorcycle AG, Mattighofen Austria

All rights reserved

Reproduction, even in part, as well as copying of all kinds, is permitted only with the express written permission of the copyright owner.

DEAR KTM CUSTOMER



ISO 9001(12 100 6061)

According to the international quality management standard ISO 9001, KTM uses quality assurance processes that lead to the maximum possible quality of the products.

Issued by: TÜV Management Service

REG.NO. 12 100 6061

KTM-Sportmotorcycle AG
5230 Mattighofen, Austria

TABLE OF CONTENTS

| | | | | | |
|---|--|----|-------|---|----|
| 1 | MEANS OF REPRESENTATION | 8 | 5.6 | Shock absorber part number | 22 |
| | 1.1 Symbols used | 8 | 6 | CONTROLS..... | 24 |
| | 1.2 Formats used..... | 8 | 6.1 | Clutch lever | 24 |
| 2 | SAFETY ADVICE..... | 9 | 6.2 | Hand brake lever..... | 24 |
| | 2.1 Use definition - intended use | 9 | 6.3 | Throttle grip | 25 |
| | 2.2 Safety advice..... | 9 | 6.4 | Switch on the left side of the handlebar | 25 |
| | 2.3 Degrees of risk and symbols | 10 | 6.4.1 | Combination switch..... | 25 |
| | 2.4 Tampering warning..... | 10 | 6.4.2 | Light switch | 26 |
| | 2.5 Safe operation | 11 | 6.4.3 | Hazard warning flasher switch..... | 26 |
| | 2.6 Protective clothing | 12 | 6.4.4 | Menu switch..... | 27 |
| | 2.7 Work rules | 12 | 6.4.5 | Turn signal switch..... | 27 |
| | 2.8 Environment..... | 12 | 6.4.6 | Horn button | 28 |
| | 2.9 Owner's Manual | 13 | 6.5 | Switch on the right side of the handlebar | 28 |
| 3 | IMPORTANT NOTES..... | 14 | 6.5.1 | Emergency OFF switch | 28 |
| | 3.1 Warranty | 14 | 6.5.2 | Electric starter button | 29 |
| | 3.2 Operating and auxiliary substances | 14 | 6.6 | Ignition/steering lock | 29 |
| | 3.3 Spare parts, accessories | 14 | 6.7 | immobilizer | 30 |
| | 3.4 Service | 14 | 6.8 | Socket for electrical accessories | 30 |
| | 3.5 Figures | 15 | 6.9 | Opening the filler cap..... | 31 |
| | 3.6 Customer service..... | 15 | 6.10 | Closing the filler cap | 32 |
| 4 | VIEW OF VEHICLE | 16 | 6.11 | Fuel cocks..... | 33 |
| | 4.1 View of vehicle, front left side (example) | 16 | 6.12 | Opening the storage compartment | 34 |
| | 4.2 View of vehicle, rear right side (example)..... | 18 | 6.13 | Closing the storage compartment..... | 34 |
| 5 | SERIAL NUMBERS | 20 | 6.14 | Seat lock..... | 35 |
| | 5.1 Chassis number | 20 | 6.15 | Tool set..... | 36 |
| | 5.2 Type label | 20 | 6.16 | Grab handles | 36 |
| | 5.3 Key number..... | 21 | 6.17 | Luggage rack plate | 37 |
| | 5.4 Engine number | 21 | 6.18 | Passenger footrests | 37 |
| | 5.5 Fork part number | 22 | 6.19 | Shift lever | 38 |

TABLE OF CONTENTS





| | | | | | |
|--------|--|----|--------|--|----|
| 6.20 | Side stand..... | 39 | 7.9.18 | "Volume"..... | 55 |
| 6.21 | Center stand (Option: Center stand)..... | 39 | 7.9.19 | "Pressure"..... | 56 |
| 7 | COMBINATION INSTRUMENT..... | 40 | 7.9.20 | "Clock/Date"..... | 56 |
| 7.1 | Overview..... | 40 | 7.9.21 | "Fuel Cons"..... | 57 |
| 7.2 | Activation and test..... | 40 | 7.9.22 | "DRL"..... | 57 |
| 7.3 | Matrix display..... | 41 | 7.9.23 | "Shift Light"..... | 58 |
| 7.4 | Segment display..... | 41 | 7.9.24 | "Quick Shift"..... | 58 |
| 7.5 | Indicator lamps..... | 42 | 7.9.25 | "Heat Grips"..... | 59 |
| 7.6 | Message on the matrix display..... | 43 | 8 | ERGONOMICS..... | 60 |
| 7.7 | Shift warning light..... | 44 | 8.1 | Adjusting the driver's seat..... | 60 |
| 7.8 | Service display..... | 45 | 8.2 | Handlebar position..... | 61 |
| 7.9 | Matrix display menu..... | 45 | 8.3 | Adjusting the handlebar position  | 61 |
| 7.9.1 | "Favorites"..... | 45 | 8.4 | Adjusting the wind shield..... | 62 |
| 7.9.2 | "Trip 1"..... | 46 | 8.5 | Adjusting the basic setting of the clutch lever..... | 64 |
| 7.9.3 | "Trip 2"..... | 46 | 8.6 | Adjusting the basic position of the hand brake lever..... | 64 |
| 7.9.4 | "General Info"..... | 47 | 8.7 | Rider footrests..... | 65 |
| 7.9.5 | "TPMS" (optional)..... | 47 | 8.8 | Adjusting the footrests  | 65 |
| 7.9.6 | "Set Favorites"..... | 48 | 8.9 | Foot brake lever..... | 67 |
| 7.9.7 | "Settings"..... | 48 | 8.10 | Adjusting the basic position of the foot brake lever  | 67 |
| 7.9.8 | "Warnings"..... | 49 | 8.11 | Checking the basic position of the shift lever..... | 69 |
| 7.9.9 | "Heat Grip" (optional)..... | 49 | 8.12 | Adjusting the basic position of the shift lever  | 69 |
| 7.9.10 | "MTC/ABS"..... | 50 | 9 | PREPARING FOR USE..... | 71 |
| 7.9.11 | "Load"..... | 50 | 9.1 | Advice on first use..... | 71 |
| 7.9.12 | "Damping"..... | 51 | 9.2 | Running in the engine..... | 72 |
| 7.9.13 | "Drive Mode"..... | 51 | 9.3 | Loading the vehicle..... | 73 |
| 7.9.14 | Menu overview..... | 52 | | | |
| 7.9.15 | "Language"..... | 54 | | | |
| 7.9.16 | "Distance"..... | 54 | | | |
| 7.9.17 | "Temp"..... | 55 | | | |

TABLE OF CONTENTS





| | | | | | |
|------|---|-----|-------|--|-----|
| 10 | RIDING INSTRUCTIONS..... | 75 | 13.2 | Removing the vehicle from the center stand (Option: Center stand)..... | 98 |
| 10.1 | Checks and maintenance measures when preparing for use..... | 75 | 13.3 | Removing the passenger seat | 99 |
| 10.2 | Starting..... | 76 | 13.4 | Mounting the passenger seat..... | 100 |
| 10.3 | Starting off..... | 77 | 13.5 | Removing the driver's seat | 100 |
| 10.4 | Shifting, riding | 77 | 13.6 | Mounting the driver's seat..... | 101 |
| 10.5 | Applying the brakes..... | 81 | 13.7 | Checking for chain dirt | 101 |
| 10.6 | Stopping, parking..... | 83 | 13.8 | Cleaning the chain | 102 |
| 10.7 | Transport | 85 | 13.9 | Checking the chain tension..... | 103 |
| 10.8 | Refueling | 86 | 13.10 | Adjusting the chain tension..... | 104 |
| 11 | SERVICE SCHEDULE | 88 | 13.11 | Checking the chain, rear sprocket and engine sprocket..... | 106 |
| 11.1 | Additional information..... | 88 | 13.12 | Checking/rectifying the fluid level of the hydraulic clutch..... | 109 |
| 11.2 | Required work | 88 | 13.13 | Checking the steering head bearing play..... | 110 |
| 11.3 | Recommended work | 91 | 13.14 | Removing the bottom triple clamp cover..... | 111 |
| 12 | SUSPENSION SETTING..... | 92 | 13.15 | Installing the bottom triple clamp cover  | 111 |
| 12.1 | "Damping" (Option: With EDS) | 92 | 13.16 | Removing the front side cover | 112 |
| 12.2 | "Load" (Option: With EDS) | 92 | 13.17 | Installing the front side cover | 113 |
| 12.3 | Fork/shock absorber | 93 | 13.18 | Removing the mask spoiler  | 114 |
| 12.4 | Adjusting the compression damping of the fork (Option: Without EDS)..... | 93 | 13.19 | Installing the mask spoiler  | 117 |
| 12.5 | Adjusting the rebound damping of the fork (Option: Without EDS)..... | 94 | 13.20 | Removing the front fender | 119 |
| 12.6 | Adjusting the rebound damping of the shock absorber (Option: Without EDS)..... | 95 | 13.21 | Installing the front fender  | 120 |
| 12.7 | Adjusting the spring preload of the shock absorber (Option: Without EDS)..... | 96 | 13.22 | Removing the tank cover..... | 120 |
| 13 | SERVICE WORK ON THE CHASSIS..... | 98 | 13.23 | Installing the tank cover | 122 |
| 13.1 | Raising the vehicle with the center stand (Option: Center stand)..... | 98 | 13.24 | Removing the wind shield | 123 |
| | | | 13.25 | Installing the wind shield..... | 124 |
| 14 | BRAKE SYSTEM | 125 | 14.1 | ABS/antilock brake system..... | 125 |

TABLE OF CONTENTS











| | | | | | |
|------|--|-----|--------|---|-----|
| 14.2 | Checking the brake discs | 126 | 16.10 | Changing the high beam bulb..... | 166 |
| 14.3 | Checking the brake fluid level of the front brake | 127 | 16.11 | Checking the headlight setting | 168 |
| 14.4 | Adding front brake fluid  | 128 | 16.12 | Adjusting the headlight range..... | 168 |
| 14.5 | Checking the front brake linings | 130 | 17 | COOLING SYSTEM | 170 |
| 14.6 | Checking the rear brake fluid level..... | 130 | 17.1 | Checking the coolant level in the compensating tank..... | 170 |
| 14.7 | Adding rear brake fluid  | 131 | 17.2 | Correcting the coolant level in the compensating tank..... | 171 |
| 14.8 | Checking the rear brake linings | 133 | 18 | ENGINE TUNING | 173 |
| 15 | WHEELS, TIRES | 135 | 18.1 | "Drive Mode"..... | 173 |
| 15.1 | Removing the front wheel  | 135 | 18.2 | MTC/motorcycle traction control | 173 |
| 15.2 | Installing the front wheel  | 137 | 19 | SERVICE WORK ON THE ENGINE | 175 |
| 15.3 | Removing the rear wheel  | 139 | 19.1 | Checking the engine oil level..... | 175 |
| 15.4 | Installing the rear wheel  | 141 | 19.2 | Changing the engine oil and filter, cleaning the oil screens  | 176 |
| 15.5 | Checking the rear hub rubber dampers  | 143 | 19.3 | Adding engine oil | 180 |
| 15.6 | Checking the tire condition | 145 | 20 | CLEANING, CARE | 183 |
| 15.7 | Checking the tire air pressure..... | 146 | 20.1 | Cleaning motorcycle | 183 |
| 15.8 | Checking spoke tension | 147 | 20.2 | Checks and maintenance steps for winter operation..... | 185 |
| 16 | ELECTRICAL SYSTEM | 149 | 21 | STORAGE | 186 |
| 16.1 | daytime running light | 149 | 21.1 | Storage | 186 |
| 16.2 | Removing the battery  | 149 | 21.2 | Preparing for use after storage..... | 187 |
| 16.3 | Installing the battery  | 151 | 22 | TROUBLESHOOTING | 188 |
| 16.4 | Recharging the battery  | 153 | 23 | TECHNICAL DATA..... | 190 |
| 16.5 | Changing the main fuse..... | 157 | 23.1 | Engine | 190 |
| 16.6 | Changing the fuses in the fuse box | 159 | 23.2 | Engine tightening torques | 191 |
| 16.7 | Removing the headlight mask with the headlight..... | 162 | 23.3 | Capacities | 194 |
| 16.8 | Refitting the headlight mask with the headlight..... | 163 | 23.3.1 | Engine oil | 194 |
| 16.9 | Changing the low beam bulb | 164 | 23.3.2 | Coolant | 195 |

TABLE OF CONTENTS

| | | |
|--------|----------------------------------|-----|
| 23.3.3 | Fuel | 195 |
| 23.4 | Chassis | 195 |
| 23.4.1 | Option: With EDS | 195 |
| 23.4.2 | Option: Without EDS | 195 |
| 23.5 | Electrical system..... | 197 |
| 23.5.1 | Option: Without EDS | 197 |
| 23.5.2 | Option: With EDS | 197 |
| 23.6 | Tires | 198 |
| 23.7 | Fork..... | 198 |
| 23.7.1 | Option: With EDS | 198 |
| 23.7.2 | Option: Without EDS | 199 |
| 23.8 | Shock absorber..... | 200 |
| 23.8.1 | Option: With EDS | 200 |
| 23.8.2 | Option: Without EDS..... | 200 |
| 23.9 | Chassis tightening torques | 201 |
| 24 | SUBSTANCES | 205 |
| 25 | AUXILIARY SUBSTANCES | 209 |
| 26 | STANDARDS | 212 |
| | INDEX | 213 |

1 MEANS OF REPRESENTATION

1.1 Symbols used

The meaning of specific symbols is described below.



Indicates an expected reaction (e.g. of a work step or a function).



Indicates an unexpected reaction (e.g. of a work step or a function).



All work marked with this symbol requires specialist knowledge and technical understanding. In the interest of your own safety, have these jobs performed by an authorized KTM workshop. There, your motorcycle will be optimally cared for by specially trained experts using the specialist tools required.



Indicates a page reference (more information is provided on the specified page).

1.2 Formats used

The typographical formats used in this document are explained below.

Specific name Identifies a proprietary name.

Name® Identifies a protected name.

Brand™ Identifies a brand available on the open market.

2.1 Use definition - intended use

KTM sport motorcycles are designed and constructed to meet the normal demands of regular road and light offroad operation (dirt roads), but not for use on race courses.



Info

The motorcycle is only authorized for operation on public roads in the homologated version.

2.2 Safety advice

A number of safety instructions need to be followed to operate the vehicle safely. Therefore, read this manual carefully. The safety instructions are highlighted in the text and are referred to at the relevant passages.



Info

The vehicle has various information and warning labels at prominent locations. Do not remove information/warning labels. If they are missing, you or others may not recognize dangers and may therefore be injured.

2.3 Degrees of risk and symbols

**Danger**

Identifies a danger that will immediately and invariably lead to fatal or serious permanent injury if the appropriate measures are not taken.

**Warning**

Identifies a danger that is likely to lead to fatal or serious injury if the appropriate measures are not taken.

**Caution**

Identifies a danger that may lead to minor injuries if the appropriate measures are not taken.

Note

Identifies a danger that will lead to considerable machine and material damage if the appropriate measures are not taken.

**Warning**

Identifies a danger that will lead to environmental damage if the appropriate measures are not taken.

2.4 Tampering warning

Tampering with the noise control system is prohibited. Federal law prohibits the following acts or the causing thereof:

- 1 The removal or rendering inoperative by any person other than for purposes of maintenance, repair, or replacement, of any device or element of design incorporated into any new vehicle for the purpose of noise control prior to its sale or delivery to the ultimate purchaser or while it is in use, or
- 2 the use of the vehicle after such device or element of design has been removed or rendered inoperative by any person.

Among those acts presumed to constitute tampering are the acts listed below:

- 1 Removal or puncturing of the main silencer, baffles, header pipes or any other components which conduct exhaust gases.
- 2 Removal or puncturing of parts of the intake system.
- 3 Lack of proper maintenance.
- 4 Replacing moving part of the vehicle, or parts of the exhaust or intake system, with parts other than those specified by the manufacturer.

2.5 Safe operation



Danger

Danger of accidents Danger arising from the rider's judgement being impaired.

- Do not operate the vehicle while under the influence of alcohol, drugs and certain medications or physically or mentally impaired.



Danger

Danger of poisoning Exhaust gases are toxic and inhaling them may result in unconsciousness and/or death.

- When running the engine, always make sure there is sufficient ventilation, and do not start or run the engine in an enclosed space without an effective exhaust extraction system.



Warning

Danger of burns Some vehicle components become very hot when the vehicle is operated.

- Do not touch hot components such as exhaust system, radiator, engine, shock absorber, and the brake system. Allow these components to cool down before starting work on them.

Only operate the vehicle when it is in perfect technical condition, in accordance with its intended use, and in a safe and environmentally compatible manner.

The vehicle should only be used by trained persons. An appropriate driver's license is needed to ride the vehicle on public roads.

Have malfunctions that impair safety promptly eliminated by an authorized KTM workshop.

Adhere to the information and warning labels on the vehicle.

2.6 Protective clothing



Warning

Risk of injury Missing or poor protective clothing presents an increased safety risk.

- Wear protective clothing (helmet, boots, gloves, pants and jacket with protectors) every time you ride the vehicle. Always wear protective clothing that is in good condition and meets the legal requirements.

In the interest of your own safety, KTM recommends that you only operate the vehicle while wearing protective clothing.

2.7 Work rules

Special tools are necessary for some of the work. These are not included with the vehicle and can be ordered under the number in parentheses. Ex: valve spring mounter (59029019000)

During assembly, non-reusable parts (e.g. self-locking screws and nuts, seals and seal rings, O-rings, pins, lock washers) must be replaced by new parts.

Where thread lockers are used on screw connections (e.g., **Loctite**®), follow the instructions for use from the manufacturer.

Parts that you want to reuse following repairs and servicing should be cleaned and checked for damage and wear. Change damaged or worn parts.

Following repairs or servicing, the vehicle must be checked for roadworthiness.

2.8 Environment

Motorcycling is a wonderful sport and we naturally hope that you can enjoy it to the full. However, it can also lead to problems with the environment and conflict with other persons. Responsible behavior in handling the motorcycle can help to avoid such problems and conflicts. To protect the future of motorcycle sport, make sure that you use your motorcycle legally, display environmental consciousness, and respect the rights of others.

2.9 Owner's Manual

It is important that you read this Owner's Manual carefully and completely before making your first trip. The Owner's Manual contains useful information and many tips on how to operate, handle, and maintain your motorcycle. Only then will you find out how to customize the vehicle ideally for your own use and how you can protect yourself from injury.

Keep the Owner's Manual in an accessible place to enable you to refer to it as needed.

If you would like to know more about the vehicle or have questions on the material you read, please contact an authorized KTM dealer.

The Owner's Manual is an important component of the vehicle and should be handed over to the new owner if the vehicle is sold.

3.1 Warranty

The work prescribed in the service schedule must be carried out by an authorized KTM workshop only and confirmed in the customer's Service and Warranty Booklet and in the **KTM dealer.net**; otherwise, all warranty claims will be void. No warranty claims can be considered for damage resulting from manipulations and/or alterations to the vehicle.

Additional information on the guarantee or warranty and the procedures involved can be found in the Service and Warranty Booklet.

3.2 Operating and auxiliary substances



Warning

Environmental hazard Improper handling of fuel is a danger to the environment.

- Do not allow fuel to get into the ground water, the ground, or the sewage system.

Use operating and auxiliary substances (such as fuel and lubricants) as specified in the Owner's Manual.

3.3 Spare parts, accessories

For your own safety, only use spare parts and accessory products that are approved and/or recommended by KTM and have them installed by an authorized KTM workshop. KTM accepts no liability for other products and any resulting damage or loss.

Certain spare parts and accessory products are specified in parentheses in the descriptions. Your authorized KTM dealer will be glad to advise you.

The current **KTM PowerParts** for your vehicle can be found on the KTM website.

International KTM Website: <http://www.ktm.com>

3.4 Service

A prerequisite for perfect operation and prevention of premature wear is that the service, care and tuning work on the engine and chassis are properly carried out as described in the owner's manual. Poor adjustment and tuning of the engine and suspension can lead to damage and breakage of components.

Using the motorcycle in extreme conditions such as very muddy or wet roads can lead to above-average wear of components such as the drive train or the brakes. For this reason, it may be necessary to service or replace worn parts before the limit specified in the service schedule is reached.

It is imperative that you adhere to the stipulated run-in times and service intervals. If you observe these exactly, you will ensure a much longer service life for your motorcycle.

3.5 Figures

The figures contained in the manual may depict special equipment.

In the interest of clarity, some components may be shown disassembled or may not be shown at all. It is not always necessary to disassemble the component to perform the activity in question. Please follow the instructions in the text.

3.6 Customer service

Your authorized KTM dealer will be happy to answer any questions you may have on your vehicle and KTM.

A list of authorized KTM dealers can be found on the KTM website.

International KTM Website: <http://www.ktm.com>

4 VIEW OF VEHICLE

4.1 View of vehicle, front left side (example)

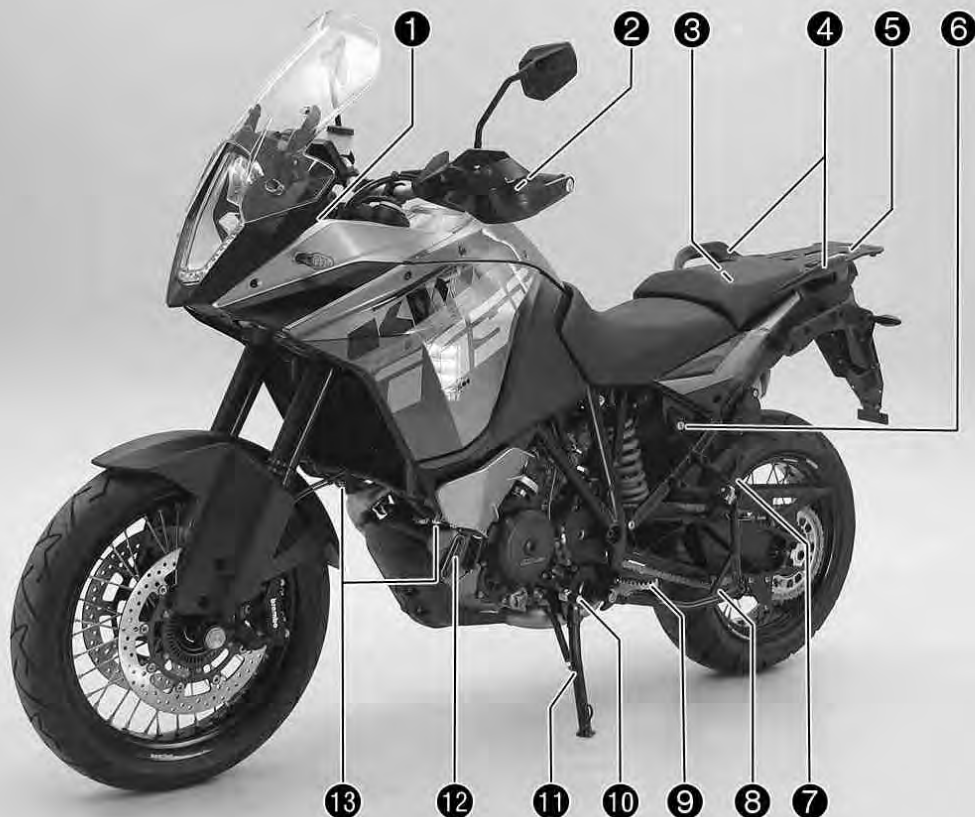

4 VIEW OF VEHICLE

| | |
|----|---|
| 1 | Socket for electrical accessories (☛ p. 30) |
| 2 | Clutch lever (☛ p. 24) |
| 3 | Tool set (☛ p. 36) |
| 4 | Grab handles (☛ p. 36) |
| 5 | Luggage rack plate (☛ p. 37) |
| 6 | Seat lock (☛ p. 35) |
| 7 | Passenger footrests (☛ p. 37) |
| 8 | Center stand (☛ p. 39) |
| 9 | Rider footrests (☛ p. 65) |
| 10 | Shift lever (☛ p. 38) |
| 11 | Side stand (☛ p. 39) |
| 12 | Engine oil level viewer |
| 13 | Fuel cocks (☛ p. 33) |

4 VIEW OF VEHICLE

4.2 View of vehicle, rear right side (example)



4 VIEW OF VEHICLE

| | |
|----|-----------------------------------|
| 1 | Combination switch (☛ p. 25) |
| 2 | Filler cap |
| 3 | Ignition/steering lock (☛ p. 29) |
| 4 | Electric starter button (☛ p. 29) |
| 5 | Emergency OFF switch (☛ p. 28) |
| 6 | Throttle grip (☛ p. 25) |
| 7 | Hand brake lever (☛ p. 24) |
| 8 | Storage compartment |
| 9 | Cooling system compensating tank |
| 10 | Foot brake lever (☛ p. 67) |

5.1 Chassis number



The chassis number ❶ is stamped on the bottom right of the frame behind the steering head.

The chassis number is also shown on the type label.

5.2 Type label

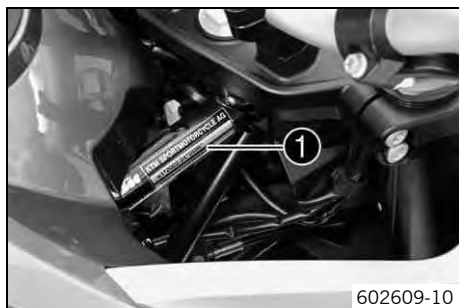

The type label ❶ is on the top right of the frame behind the steering head.

5.3 Key number

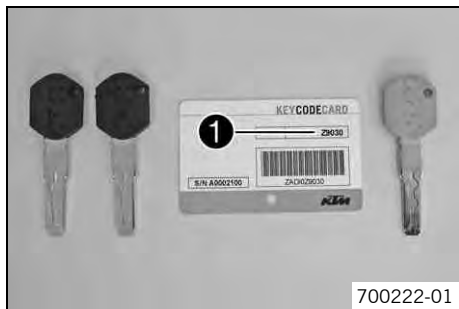

The key number **Code number 1** can be found on the **KEYCODECARD**.



Info

You need the key number to order a spare key. Keep the **KEYCODECARD** in a safe place.

Use the orange programming key to activate and deactivate the black ignition key. Keep the orange programming key in a safe place: it must only be used for learning and programming functions.

5.4 Engine number

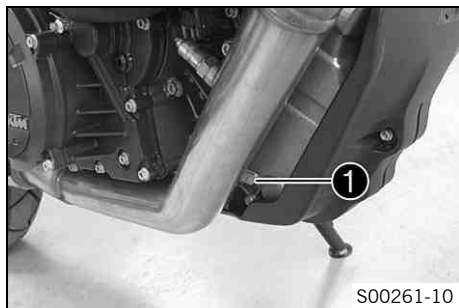

The engine number **1** is stamped on the right side of the engine.

5.5 Fork part number

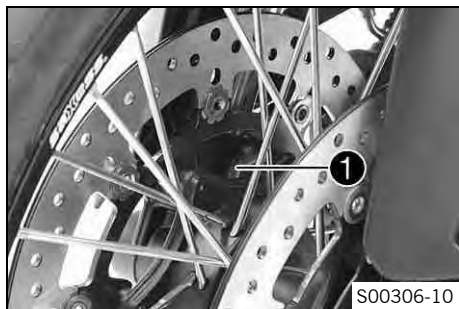

The fork part number ❶ is stamped on the inner side of the fork stub.

5.6 Shock absorber part number



(Option: Without EDS)

The shock absorber part number ❶ is stamped on the top part of the shock absorber.

5 SERIAL NUMBERS

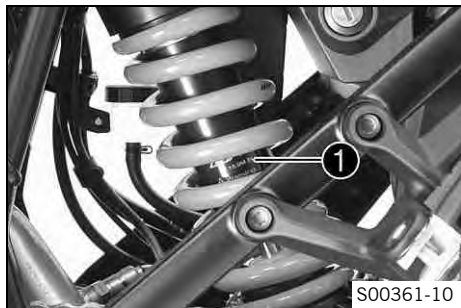

(Option: With EDS)

The shock absorber part number ❶ is shown on a sticker applied to the shock absorber case below the spring.

6.1 Clutch lever

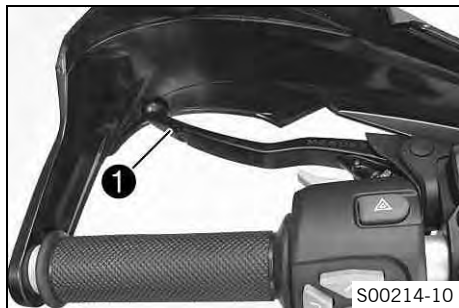

The clutch lever ❶ is fitted on the left side of the handlebar. The clutch is hydraulically operated and self-adjusting.

6.2 Hand brake lever



The hand brake lever ❶ is fitted on the right side of the handlebar. The hand brake lever is used to activate both the front brake and rear brake at the same time.



Info

When the **Offroad** ABS mode is switched on, only the front brake is activated. When ABS is switched off, only the front brake is activated.

6.3 Throttle grip

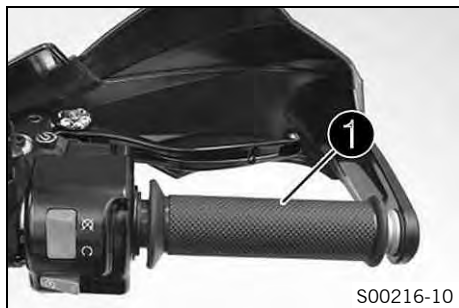

The throttle grip ❶ is fitted on the right side of the handlebar.

6.4 Switch on the left side of the handlebar

6.4.1 Combination switch

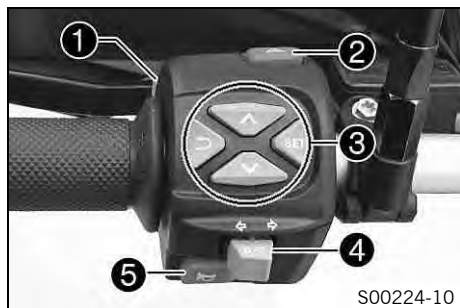

The combination switch is fitted on the left side of the handlebar.

Overview of the left combination switch

| | |
|---|---|
| 1 | Light switch (☛ p. 26) |
| 2 | Hazard warning flasher switch (☛ p. 26) |
| 3 | Menu switch (☛ p. 27) |
| 4 | Turn signal switch (☛ p. 27) |
| 5 | Horn button (☛ p. 28) |

6.4.2 Light switch

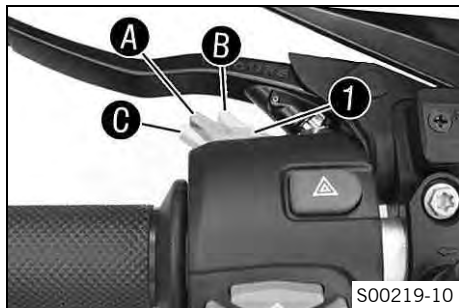

The light switch ❶ is fitted on the combination switch on the left.

Possible states

| | |
|--|--|
| | Low beam on – Light switch in position ❶. In this position, the low beam and tail light are switched on. |
| | High beam on – Light switch in position ❷. In this position, the high beam and tail light are switched on. |
| | Headlight flasher. – Push the light switch into position ❸. |

6.4.3 Hazard warning flasher switch



The hazard warning flasher switch ❶ is fitted on the combination switch on the left. The hazard warning flasher is used to indicate emergency situations.



Info

The hazard warning flasher can be activated or deactivated while the ignition is switched on or up to 60 seconds after the ignition is switched off. Only keep the hazard warning flasher activated as long as necessary as it depletes the battery.

Possible states

| | |
|--|---|
| | Hazard warning flasher on – All four turn signals and the green turn signal indicator lights in the combination instrument flash. |
|--|---|

6.4.4 Menu switch



The menu switch is fitted in the middle of the left combination switch. The menu buttons are used to control the matrix display on the combination instrument. Button ❶ is the **UP** button. Button ❷ is the **DOWN** button. Button ❸ is the **SET** button. Button ❹ is the **BACK** button.

6.4.5 Turn signal switch



The turn signal switch ❶ is fitted on the combination switch on the left.

Possible states

| | |
|-----|---|
| OFF | Turn signal off – Press the turn signal switch. |
| ← | Turn signal, left, on – Turn signal switch pressed to the left. The turn signal switch returns automatically to the central position after use. |
| → | Turn signal, right, on – Turn signal switch pressed to the right. The turn signal switch returns automatically to the central position after use. |

To switch off the turn signal, press the turn signal switch towards the switch case.

6.4.6 Horn button



The horn button ❶ is fitted on the combination switch on the left.

Possible states

- Horn button ❶ in basic position.
- Horn button ❶ pressed – The horn is operated in this position.

6.5 Switch on the right side of the handlebar

6.5.1 Emergency OFF switch



The emergency OFF switch ❶ is fitted on the right side of the handlebar.

Possible states

| | |
|--|---|
| | <p>Emergency OFF switch off – In this position, the ignition circuit is interrupted, a running engine stops, and a non-running engine cannot be started. A message appears on the matrix display.</p> |
| | <p>Emergency OFF switch on – This position is required for operation; the ignition circuit is closed.</p> |

6.5.2 Electric starter button



The electric starter button ❶ is fitted on the right side of the handlebar.

Possible states

- Electric starter button ❸ in basic position.
- Electric starter button ❸ is pressed – In this position, the electric starter is actuated.

6.6 Ignition/steering lock



The ignition/steering lock ❶ is located in front of the upper triple clamp.



Info

The ignition may only be switched on using a black ignition key. With the orange programming key, you can activate or deactivate the black ignition key.

Possible states

| | |
|--|---|
| | <p>Ignition off OFF – In this position, the ignition circuit is interrupted, a running engine stops, and a non-running engine will not start. The black ignition key can be removed.</p> |
| | <p>Ignition on ON – In this position, the ignition circuit is closed and the engine can be started.</p> |
| | <p>Steering locked – In this position, the ignition circuit is interrupted and the steering locked. The black ignition key can be removed.</p> |

6.7 immobilizer

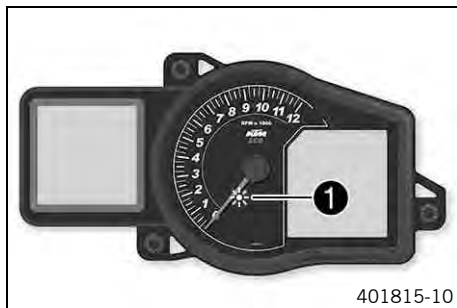

The electronic immobilizer secures the vehicle against unauthorized use. The immobilizer is activated automatically and the engine electronics are locked when the ignition key is withdrawn. The immobilizer indicator lamp ❶ can indicate errors by flashing. If the optional alarm system is installed, the immobilizer indicator lamp ❶ flashes when the alarm system is switched on.



Info

The ignition key contains electronic components. Never attach multiple ignition keys to a single key ring; this may cause mutual interference.

A lost black ignition key must be deactivated to prevent unauthorized persons from operating the vehicle.

The black ignition keys are activated when delivered.

Another two spare ignition keys (key number on the **KEYCODECARD**) can be ordered from an authorized KTM workshop; they need to be activated for use.

6.8 Socket for electrical accessories

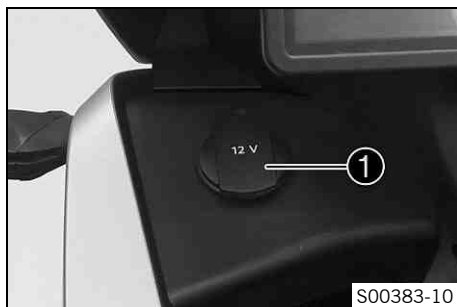

Socket ❶ for electrical accessories is fitted to the left of the combination instrument. It is connected to permanent positive and fuse-protected.

| Socket for electrical accessories | |
|-----------------------------------|------|
| Voltage | 12 V |
| Maximum current consumption | 10 A |

6.9 Opening the filler cap



Danger

Fire hazard Fuel is highly flammable.

- Never refuel the vehicle near open flames or burning cigarettes, and always switch off the engine first. Be careful that no fuel is spilt, especially on hot vehicle components. Clean up spilt fuel immediately.
- The fuel in the fuel tank expands when warm and may emerge if overfilled. Follow the instructions on refueling.



Warning

Danger of poisoning Fuel is poisonous and a health hazard.

- Fuel must not come into contact with the skin, eyes, or clothing. Do not breathe in the fuel vapors. If contact occurs with the eyes, rinse with water immediately and contact a physician. Immediately clean contaminated areas on the skin with soap and water. If fuel is swallowed, contact a physician immediately. Change clothing that is contaminated with fuel. Store fuel properly in a suitable canister and keep away from children.



Warning

Environmental hazard Improper handling of fuel is a danger to the environment.

- Do not allow fuel to get into the ground water, the ground, or the sewage system.

- Lift cover **1** of the filler cap and insert ignition key **2** in the fuel tank lock.

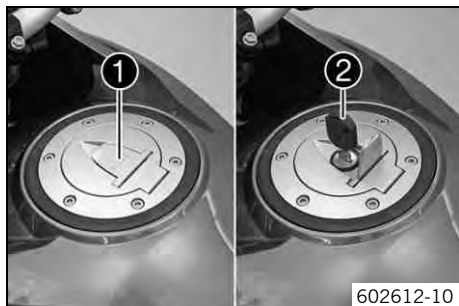

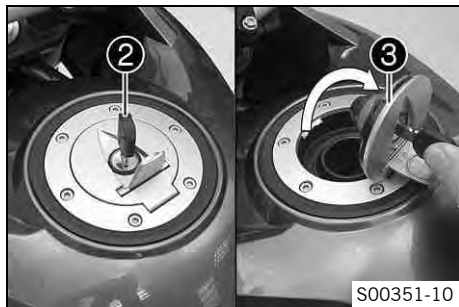
**Note**

Danger of damage Ignition key breakage.

- To take pressure off of the ignition key, push down on the filler cap. Damaged ignition keys must be replaced.

- Turn ignition key ② clockwise.
- Fold open filler cap ③.

6.10 Closing the filler cap

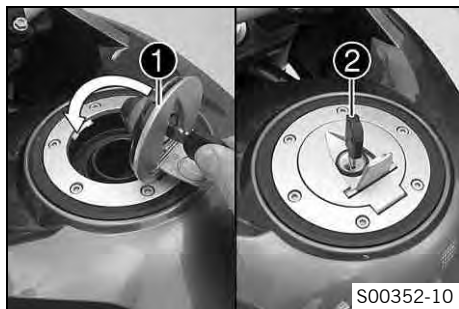

- Fold down filler cap ①.
- Turn ignition key ② clockwise.

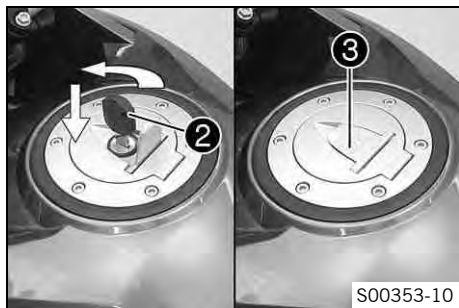

- Press down the filler cap and turn back ignition key ② until the fuel tank lock locks.



Warning

Fire hazard Fuel is highly flammable, poisonous and harmful to your health.

- After closing the filler cap, ensure that it is locked properly. Change clothing that has been contaminated with fuel. Immediately clean contaminated areas on the skin with soap and water.
-
- Remove ignition key ② and close cover ③.

6.11 Fuel cocks

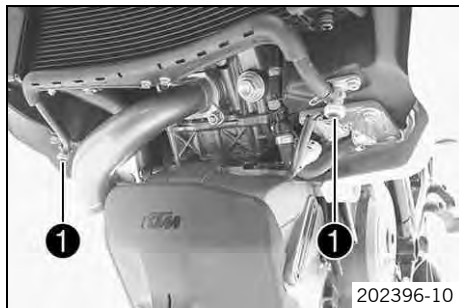

A fuel cock ① is located on each side of the fuel tank.



Info

The fuel cocks must always be open during operation.
The fuel cocks are only closed to remove the fuel tank.

Possible states

- Fuel cocks are closed – A level equalization cannot take place and fuel cannot flow out of the fuel tank.
- Fuel cocks are open – A level equalization can take place and fuel can flow out of the fuel tank.

6.12 Opening the storage compartment

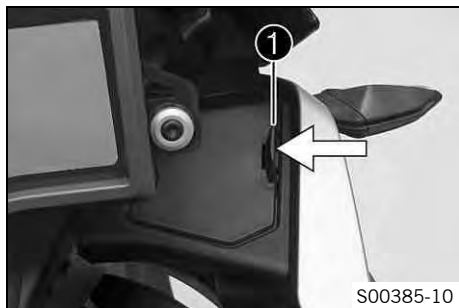

- Press button ❶ in the direction of the arrow and lift the cover at the same time.

6.13 Closing the storage compartment



- Press down cover ❶ until the lock engages audibly.

6.14 Seat lock



(Option: Without EDS)

The seat lock ❶ is located on the left side of the vehicle.

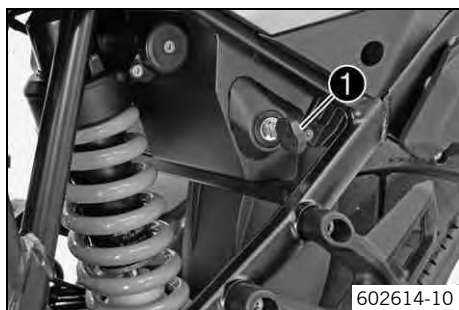

(Option: With EDS)

The seat lock ❶ is located on the left side of the vehicle.
It can be unlocked using the ignition key.

6.15 Tool set

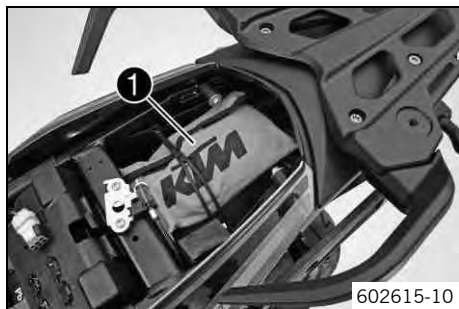

The tool set ❶ is located in the storage compartment under the seat.

6.16 Grab handles



The passenger can hold onto grab handles ❶ during the trip.

6.17 Luggage rack plate

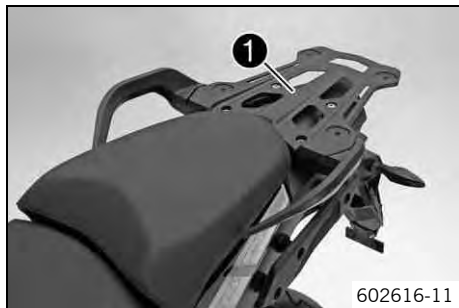

The luggage rack plate ❶ is located behind the seat.
The base plate of a luggage system (optional) can be attached to the luggage rack plate.
The luggage rack plate may not be loaded with more than the specified weight.

| | |
|---|---------------|
| Maximum permissible load on luggage rack plate | 8 kg (18 lb.) |
|---|---------------|



Info

Note the information provided by the luggage manufacturer.

6.18 Passenger footrests

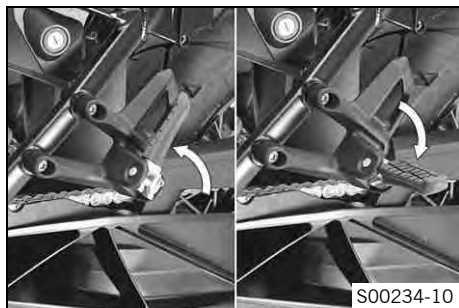

The passenger footrests can be folded up and down.

Possible states

- Passenger footrests folded up – For operation without a passenger.
- Passenger footrests folded down – For operation with a passenger.

6.19 Shift lever

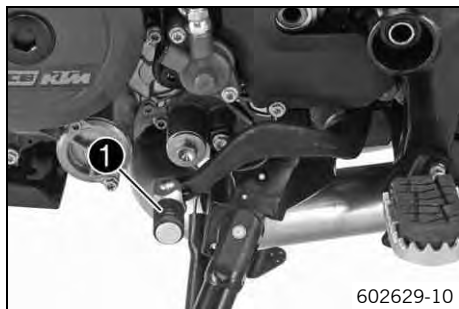

The shift lever ❶ is fitted on the left side of the engine.

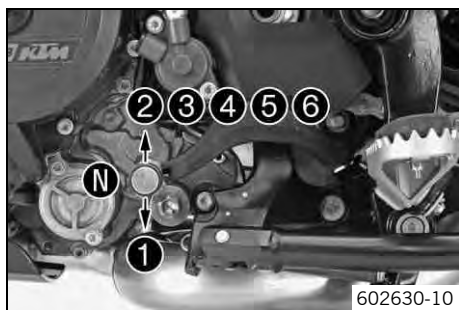

The gear positions can be seen in the figure.
The idle position is between the first and second gears.

6.20 Side stand

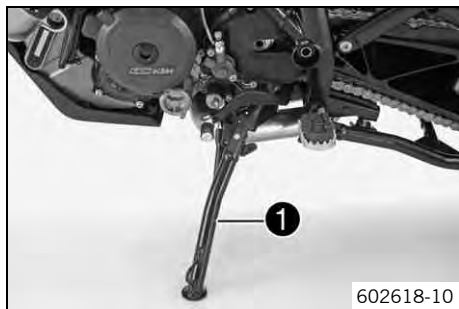

The side stand ❶ is located on the left side of the vehicle. The side stand is used for parking the motorcycle.



Info

The side stand must be folded up during motorcycle use. The side stand is coupled with the safety start system; see the instructions in the "Stopping, parking" chapter.

Possible states

- Side stand folded out – The vehicle can be supported on the side stand. The safety starting system is active.
- Side stand folded in – This position is mandatory when riding the motorcycle. The safety starting system is inactive.

6.21 Center stand (Option: Center stand)

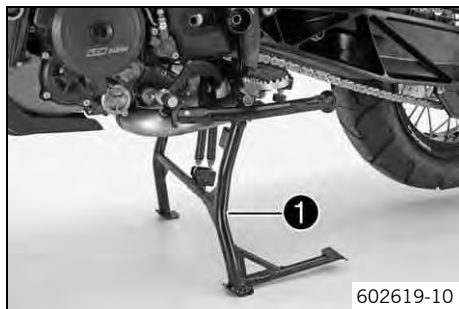

In addition to the side stand, the vehicle is equipped with a center stand ❶.

7.1 Overview

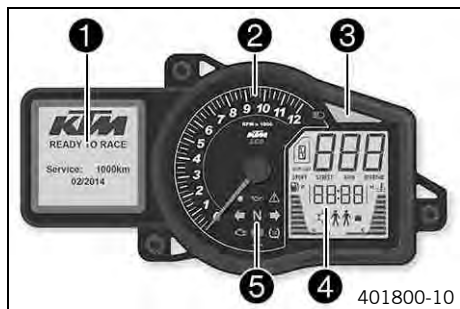

- 1 Matrix display (☛ p. 41)
- 2 Tachometer
- 3 Shift warning light (☛ p. 44)
- 4 Segment display
- 5 Indicator lamps (☛ p. 42)

7.2 Activation and test



Activation

The combination instrument is activated when the ignition is switched on.

i Info

The brightness of the displays is controlled by a brightness sensor in the combination instrument.

Test

The segment display, the indicator lamps, and the tachometer are briefly activated for a function test.

The welcome text and information on the next service (☛ p. 45) appear on the matrix display.

i Info

If the battery was disconnected, the time and date must be set.

7.3 Matrix display



401821-01

The matrix display is controlled using the menu switch (☛ p. 27). After the ignition is switched on, the display shows when the next service (☛ p. 45) is due. If the General warning lamp  lights up among the indicator lamps (☛ p. 42), the corresponding message appears in the matrix display. The **Set** button is used to confirm receipt of the information and the message is cleared.

| | |
|-----------------|------|
| Messages appear | 10 s |
|-----------------|------|

7.4 Segment display













401854-10

| | |
|---|---------------------------------|
| 1 | Fuel level |
| 2 | Time |
| 3 | Unit for the speedometer |
| 4 | Gear display |
| 5 | Speed |
| 6 | "Drive Mode" (☛ p. 173) |
| 7 | Coolant temperature |
| 8 | Set load status (only with EDS) |
| 9 | Ice warning |

7.5 Indicator lamps









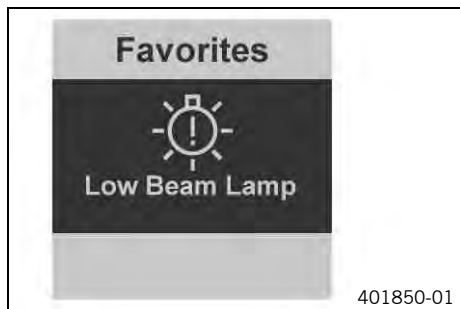



Possible states



| | |
|---|---|
|  | The high beam indicator lamp lights up blue – The high beam is switched on. |
|  | The immobilizer indicator lamp lights up/flashs red – Status or error message for immobilizer/alarm system. |
|  | The oil pressure warning lamp lights up red – Engine oil pressure is too low. |
|  | The general warning lamp lights up yellow – An operating safety (warning) message was detected. This is also shown on the matrix display. |
|  | The left turn signal lamp flashes green simultaneously with the turn signal – The left turn signal is switched on. |
|  | The idle indicator lamp lights up green – The transmission is shifted to idle. |
|  | The right turn signal lamp flashes green simultaneously with the turn signal – The right turn signal is switched on. |
|  | The engine warning lamp lights up/flashs yellow – The engine control unit has detected a fault. |
|  | The ABS lamp lights up/flashs yellow – ABS is not active. The ABS lamp also lights up when a fault is detected. |
|  | The TC lamp lights up/flashs yellow – Traction control is not enabled or is currently intervening. The TC lamp also lights up when a fault is detected. |

7.6 Message on the matrix display



Possible states

| | |
|--|--|
|  | Engine malfunction – The engine control unit has detected a fault. Visit an authorized KTM workshop. |
|  | General message – General message on operating safety. Visit an authorized KTM workshop. |
|  | ABS warning – ABS is not available. Visit an authorized KTM workshop. |
|  | Traction control – Traction control is not available. Visit an authorized KTM workshop. |
|  | Engine oil pressure – Engine oil pressure is too low. Switch off the engine immediately. Contact an authorized KTM workshop. |
|  | Engine oil level – The engine oil level is too low. Check the engine oil level and correct it. |
|  | Tire air pressure – The tire pressure is incorrect, or the system has failed. Check the tire pressure. |
|  | Lighting system – Lights up if an element of the lighting system has failed. Change the faulty light, or visit an authorized KTM workshop. |
|  | Cooling water temperature – The cooling water temperature is too high. Switch off the engine. Contact an authorized KTM workshop. |
|  | Fuel reserve – The fuel supply is dwindling. Refuel at the next opportunity. |
|  | Icy road symbol – The roads may be icy. Adjust your speed to the road conditions. |

| | |
|---|---|
|  | Battery voltage – The battery voltage is too low. Recharge the battery with a suitable battery charger. |
|  | Service – A service is due. Contact an authorized KTM workshop. |
|  | Emergency OFF switch – The emergency OFF switch is off. |

The messages are displayed in the **"Warnings"** menu.

7.7 Shift warning light



The shift warning light flashes or lights up when the transmission should be shifted. In the **"Shift Light"** menu, the engine speed for the shift warning light can be set. The shift warning light flashes at **"RPM1"** and lights up at **"RPM2"**.

| | |
|---|-------------------|
| Engine oil temperature | > 35 °C (> 95 °F) |
| "RPM1" shift warning light | Flashes |
| "RPM2" shift warning light | Lights up |
| Engine oil temperature | ≤ 35 °C (≤ 95 °F) |
| The shift warning light always lights up at | 6,500 rpm |

7.8 Service display



After the ignition is switched on, the service display appears briefly. The service intervals depend on the distance traveled or the elapsed time. The event that occurs first applies. The exact service intervals can be found in the service schedule.

7.9 Matrix display menu

7.9.1 "Favorites"



- Press the **UP** or **DOWN** button until the **"Favorites"** menu appears on the matrix display. Pressing the **SET** button opens the menu.
- Press the **UP** or **DOWN** button to select the menu item and activate it with the **SET** button.
- Pressing the **BACK** button twice always opens the **"Favorites"** menu.

In the **"Favorites"** menu, you can directly open five menus.

In the **"Set Favorites"** menu, the **"Favorites"** menu can be configured.

7.9.2 "Trip 1"

| Trip 1 | |
|-------------|--------|
| Trip 1 | 973km |
| Ø Speed 1 | 89km/h |
| Ø Cons 1 | 10.3l |
| Trip Time 1 | 15:23h |
| Fuel Range | 240km |

401826-01

- Press the **UP** or **DOWN** button until the **"Trip 1"** menu appears on the matrix display. **"Trip 1"** shows the distance since the last reset, such as between two refueling stops. **"Trip 1"** runs continuously and counts the distance up to **9999**. **"Ø Speed 1"** indicates the average speed based on **"Trip 1"** and **"Trip Time 1"**. **"Ø Cons 1"** indicates the average fuel consumption based on **"Trip 1"** and **"Trip Time 1"**. **"Trip Time 1"** indicates the riding time based on **"Trip 1"** and starts running as soon as a speed signal comes in. **"Fuel Range"** indicates the possible range with the fuel reserve.

| | |
|---|--|
| Press and hold the button SET for 3–5 seconds. | All entries in the "Trip 1" menu are cleared. |
|---|--|

7.9.3 "Trip 2"

| Trip 2 | |
|-------------|--------|
| Trip 2 | 973km |
| Ø Speed 2 | 89km/h |
| Ø Cons 2 | 10.3l |
| Trip Time 2 | 15:23h |
| Fuel Range | 240km |

401825-01

- Press the **UP** or **DOWN** button until the **"Trip 2"** menu appears on the matrix display. **"Trip 2"** shows the distance since the last reset, such as between two refueling stops. **"Trip 2"** runs continuously and counts the distance up to **9999**. **"Ø Speed 2"** indicates the average speed based on **"Trip 2"** and **"Trip Time 2"**. **"Ø Cons 2"** indicates the average fuel consumption based on **"Trip 2"** and **"Trip Time 2"**. **"Trip Time 2"** indicates the riding time based on **"Trip 2"** and starts running as soon as a speed signal comes in. **"Fuel Range"** indicates the possible range with the fuel reserve.

| | |
|---|--|
| Press and hold the button SET for 3–5 seconds. | All entries in the "Trip 2" menu are cleared. |
|---|--|

7.9.4 "General Info"



| General Info | |
|--------------|------------|
| Air Temp | 14.0°C |
| Date | 01.04.2013 |
| ODO | 677km |
| Battery | 13.0V |
| Oil Temp | 75°C |

401824-01

- Press the **UP** oder **DOWN** button until the **"General Info"** menu appears on the matrix display.

"Air Temp" indicates the ambient air temperature.

"Date" indicates the date.

"ODO" indicates the total distance covered.

"Battery" indicates the battery voltage.

"Oil Temp" indicates the engine oil temperature.

7.9.5 "TPMS" (optional)



| TPMS | |
|-------|-----|
| Front | 2.0 |
| Rear | 2.1 |

401845-01

- Press the **UP** or **DOWN** button until the **"TPMS"** menu appears on the matrix display.

Guideline

| Tire air pressure, solo/with passenger/full payload | |
|---|------------------|
| Front: with cold tires | 2.4 bar (35 psi) |
| Rear: with cold tires | 2.9 bar (42 psi) |

The **"TPMS"** menu displays the tire pressure of the front and rear tires.

"Front" indicates the tire air pressure at the front.

"Rear" indicates the tire air pressure at the rear.

7.9.6 "Set Favorites"



Condition

- The vehicle is stationary.
- Press the **UP** or **DOWN** button until the "**Set Favorites**" menu appears on the matrix display. Pressing the **SET** button opens the menu.
- Press the **UP** or **DOWN** button to select the menu. Press the **SET** button to set the menu for quick selection.

In the "**Set Favorites**" menu, the "**Favorites**" menu can be configured.

7.9.7 "Settings"

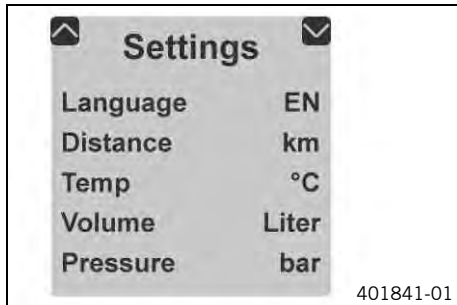

Condition

- The vehicle is stationary.
- Press the **UP** or **DOWN** button until the "**Settings**" menu appears on the matrix display. Pressing the **SET** button opens the menu.

Setting for units or various values are made in the "**Settings**" menu. Some functions can be enabled or disabled.

7.9.8 "Warnings"

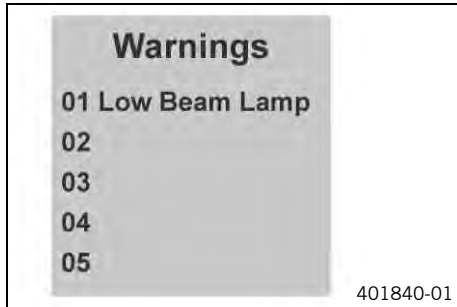

Condition

- Message or warning
 - Press the **UP** or **DOWN** button until the "**Warnings**" menu appears on the matrix display. Pressing the **SET** button opens the menu.
 - Use the **UP** or **DOWN** button to navigate through the warnings.

In the "**Warnings**" menu, warnings that occurred are displayed and stored until they are no longer active.

7.9.9 "Heat Grip" (optional)

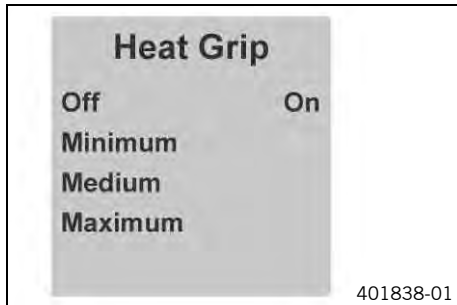

- Press the **UP** or **DOWN** button until the "**Heat Grip**" menu appears on the matrix display. Pressing the **SET** button opens the menu.
- Use the **UP** or **DOWN** button to navigate through the menu. Use the **SET** button to select a heating level or to switch off the heated grips.

7.9.10 "MTC/ABS"

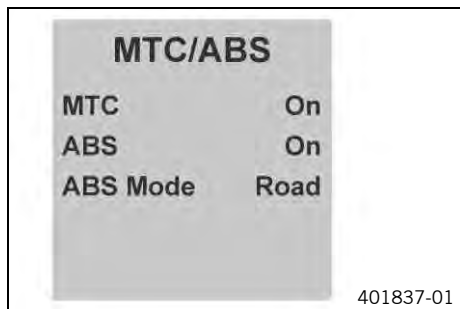

Condition

- The vehicle is stationary.
- Press the **UP** or **DOWN** button until the **"MTC/ABS"** menu appears on the matrix display.

In the **"MTC/ABS"** menu, **"MTC"** and **"ABS"** can be switched off.

In **"ABS mode"**, a choice can be made between **"Road"** and **"Offroad"**.

Info

After the ignition is switched on, traction control and ABS are enabled again. When the **"Offroad"** ABS mode is enabled, ABS only controls the front wheel. The rear wheel is not controlled by ABS and may block during braking maneuvers. When the **"Road"** ABS mode is enabled, the brakes are also applied to the rear wheel when the front brake is activated. ABS can intervene on both wheels.

7.9.11 "Load"

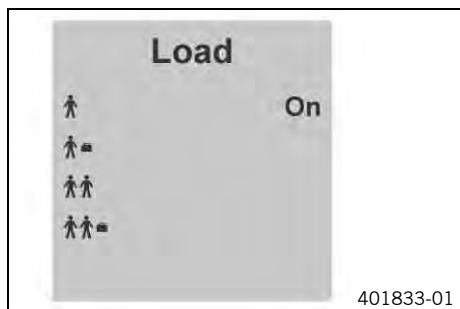

Condition

- Model with **EDS**.
- The vehicle is stationary.
- Engine is running.
- Press the **UP** or **DOWN** button until the **"Load"** menu appears on the matrix display. Pressing the **SET** button opens the menu.
- Use the **UP** or **DOWN** button to select a load status. Press the **SET** button to confirm the selection.

In the **"Load"** menu, you can choose between four load states.

7.9.12 "Damping"



Condition

- Model with **EDS**.
- Press the **UP** or **DOWN** button until the "**Damping**" menu appears on the matrix display. Pressing the **SET** button opens the menu.
- Use the **UP** or **DOWN** button to navigate through the menu. The **SET** button can be used to adjust the damping.

In the "**Damping**" menu, you can choose between "**SPORT**", "**STREET**", and "**COMFORT**".

7.9.13 "Drive Mode"

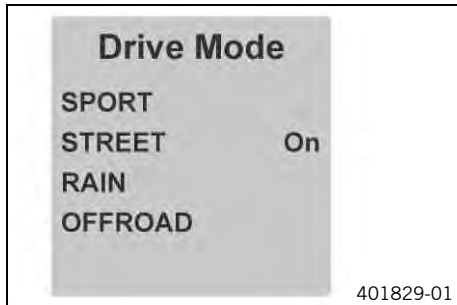

- Press the **UP** or **DOWN** button until the "**Drive Mode**" menu appears on the matrix display. Pressing the **SET** button opens the menu.
- Use the **UP** or **DOWN** button to navigate through the menu. The **SET** button can be used to select engine and traction control settings that are coordinated with each other.
 - ✓ **SPORT** – homologated performance with very direct response; the traction control allows greater slip on the rear wheel
 - ✓ **STREET** – homologated performance with very direct response; the traction control allows normal slip on the rear wheel
 - ✓ **RAIN** – reduced homologated performance for better ridability; the traction control allows normal slip on the rear wheel
 - ✓ **OFFROAD** – reduced homologated performance for better ridability; the traction control allows high slip on the rear wheel

7.9.14 Menu overview

General Info

| | |
|----------|------------|
| Air Temp | 14.0°C |
| Date | 01.04.2013 |
| ODO | 677km |
| Battery | 13.0V |

Trip 1

| | |
|-------------|--------|
| Trip 1 | 973km |
| Ø Speed 1 | 89km/h |
| Ø Cons 1 | 10.3l |
| Trip Time 1 | 15:23h |

Trip 2

| | |
|-------------|--------|
| Trip 2 | 973km |
| Ø Speed 2 | 89km/h |
| Ø Cons 2 | 10.3l |
| Trip Time 2 | 15:23h |

TPMS

| | |
|-------|-----|
| Front | 2.0 |
| Rear | 2.1 |

Set Favorites

| | |
|-------------|--------|
| Trip 1 | 486km |
| Trip 2 | 973km |
| Fuel Range | 240km |
| Trip Time 2 | 15:23h |

Favorites

| | |
|-------------|--------|
| Trip 1 | 486km |
| Trip 2 | 973km |
| Fuel Range | 240km |
| Trip Time 2 | 15:23h |

Settings

| | |
|----------|-------|
| Language | EN |
| Distance | km |
| Temp | °C |
| Volume | litre |

Drive Mode

| | |
|---------|----|
| SPORT | On |
| STREET | |
| RAIN | |
| OFFROAD | |

Damping

| | |
|---------|----|
| SPORT | On |
| STREET | |
| COMFORT | |

Load

| | |
|-----|----|
| On | On |
| Off | |
| Off | |
| Off | |
| Off | |

MTC/ABS

| | |
|----------|-----|
| MTC | On |
| ABS | Off |
| ABS Mode | |

Heat Grip

| | |
|---------|----|
| Off | On |
| Minimum | |
| Medium | |
| Maximum | |

Warnings

| |
|------------------|
| 01 Low Beam Lamp |
| 02 ... |
| 03 ... |
| 04 ... |

"KTM" start screen

Menu buttons

"Favorites"

"Trip 1"

"Trip 2"

"General Info"

"TPMS" (optional)

"Set Favorites"

"Settings"

"Warnings" (only active if there are messages)

"Heat Grip" (optional)

"MTC/ABS"

"Load" (model with EDS)

"Damping" (model with EDS)

"Drive Mode"

7.9.15 "Language"

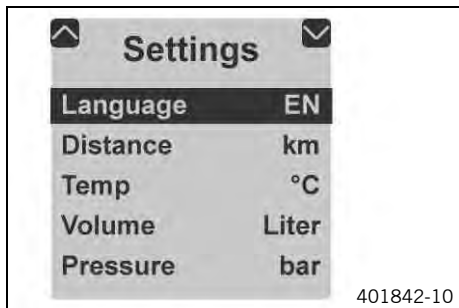

Condition

- The vehicle is stationary.
- Press the **UP** or **DOWN** button until the "**Settings**" menu appears on the matrix display. Pressing the **SET** button opens the menu.
- Press the **SET** button again to select the language.

The menu languages are English, German, Italian, French, and Spanish.

7.9.16 "Distance"

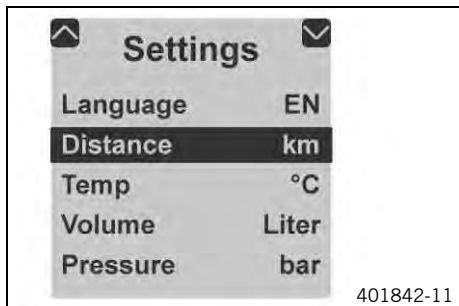

Condition

- The vehicle is stationary.
- Press the **UP** or **DOWN** button until the "**Settings**" menu appears on the matrix display. Pressing the **SET** button opens the menu.
- Press the **UP** or **DOWN** button until "**Distance**" is highlighted in black on the matrix display. Pressing the **SET** button again sets the unit of measure.

Select kilometers "**km**" or miles "**mi**" for the distance.

7.9.17 "Temp"

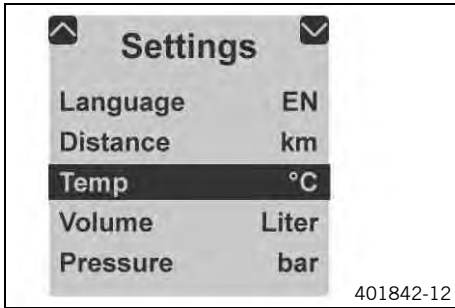

Condition

- The vehicle is stationary.
- Press the **UP** or **DOWN** button until the **"Settings"** menu appears on the matrix display. Pressing the **SET** button opens the menu.
- Press the **UP** or **DOWN** button until **"Temp"** is highlighted in black on the matrix display. Pressing the **SET** button again sets the unit of measure.

Select **"°C"** or **"°F"** for the temperature indicator.

7.9.18 "Volume"

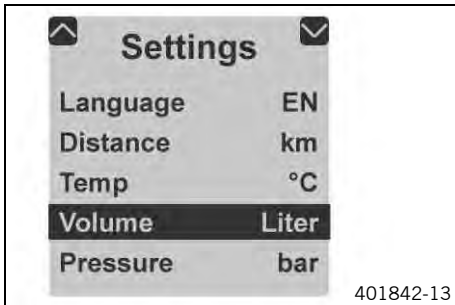

Condition

- The vehicle is stationary.
- Press the **UP** or **DOWN** button until the **"Settings"** menu appears on the matrix display. Pressing the **SET** button opens the menu.
- Press the **UP** or **DOWN** button until **"Volume"** is highlighted in black on the matrix display. Pressing the **SET** button again sets the unit of measure.

Select **"liters"** or **"gallons"** for the fuel consumption display.

7.9.19 "Pressure"

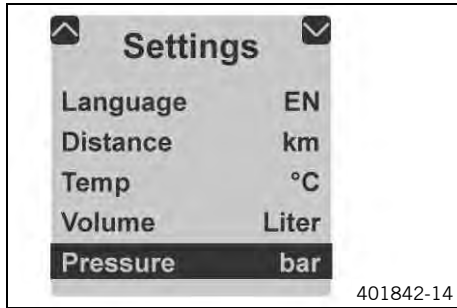

Condition

- The vehicle is stationary.
- Press the **UP** or **DOWN** button until the "**Settings**" menu appears on the matrix display. Pressing the **SET** button opens the menu.
- Press the **UP** or **DOWN** button until "**>Pressure**" is highlighted in black on the matrix display. Pressing the **SET** button again sets the unit of measure.

Select "**bar**" or "**psi**" for the tire pressure display.

7.9.20 "Clock/Date"

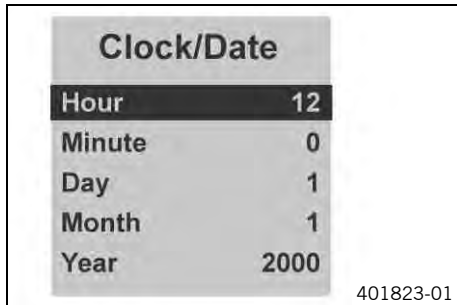

Condition

- The vehicle is stationary.
- Press the **UP** or **DOWN** button until the "**Settings**" menu appears on the matrix display. Pressing the **SET** button opens the menu.
- Press the **UP** or **DOWN** button until "**Clock/Date**" is highlighted in black on the matrix display. Pressing the **SET** button again opens the menu.
- Use the **UP** or **DOWN** button to navigate through the menu. Use the **SET** button to set the time and date.

If the battery was disconnected, the time and date must be set in the matrix display.

7.9.21 "Fuel Cons"

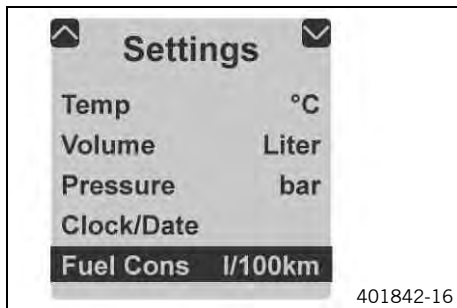

Condition

- The vehicle is stationary.
- Press the **UP** or **DOWN** button until the "**Settings**" menu appears on the matrix display. Pressing the **SET** button opens the menu.
- Press the **UP** or **DOWN** button until "**Fuel Cons**" is highlighted in black on the matrix display. Pressing the **SET** button again sets the unit of measure.

Select one of the available consumption displays.

7.9.22 "DRL"

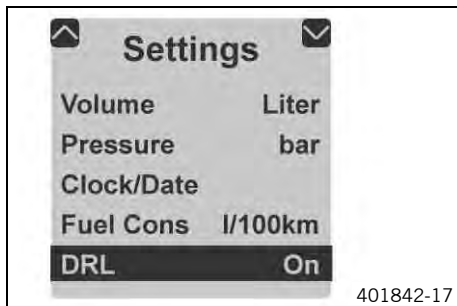

Condition

- The vehicle is stationary.
- Press the **UP** or **DOWN** button until the "**Settings**" menu appears on the matrix display. Pressing the **SET** button opens the menu.
- Press the **UP** or **DOWN** button until "**DRL**" is highlighted in black on the matrix display. Pressing the **SET** button again switches daytime running light on or off.

Switch the daytime running light on or off.



Info

Note the legal regulations regarding the daytime running light.

7.9.23 "Shift Light"

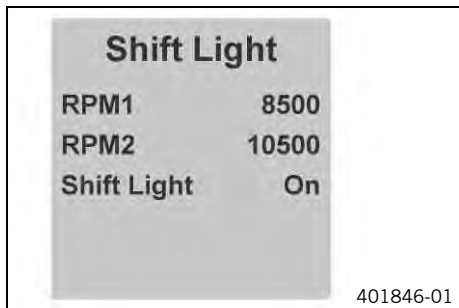

Condition

- The vehicle is stationary.
 - Press the **UP** or **DOWN** button until the **"Settings"** menu appears on the matrix display. Pressing the **SET** button opens the menu.
 - Press the **UP** or **DOWN** button until **"Shift Light"** is highlighted in black on the matrix display. Pressing the **SET** button again opens the menu.
 - Press the **UP** or **DOWN** button to select the function. Use the **SET** button to set the engine speed for the shift warning light.

When the engine speed reaches **"RPM 1"**, the shift warning light flashes.

When the engine speed reaches **"RPM 2"**, the shift warning light lights up continuously.

Switch the **"Shift Light"** function on or off.

7.9.24 "Quick Shift"

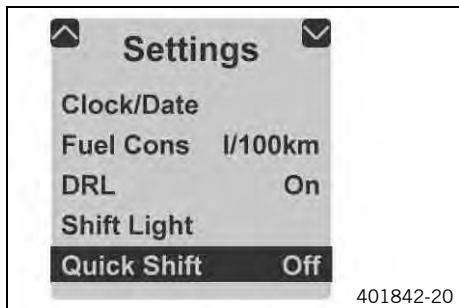

Condition

- The vehicle is stationary.
 - Press the **UP** or **DOWN** button until the **"Settings"** menu appears on the matrix display. Pressing the **SET** button opens the menu.
 - The **"Quick Shift"** function cannot be activated.



Info

This function is not available in this model.

7.9.25 "Heat Grips"

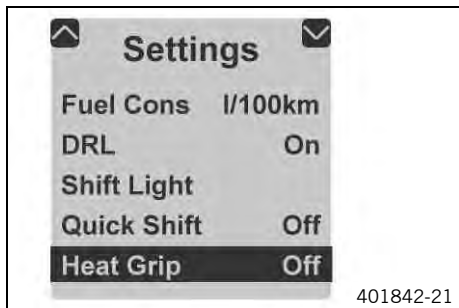

Condition

- The vehicle is stationary.
 - Press the **UP** or **DOWN** button until the "**Settings**" menu appears on the matrix display. Pressing the **SET** button opens the menu.
 - Press the **UP** or **DOWN** button until "**Heat Grips**" is highlighted in black on the matrix display. Pressing the **SET** button again switches the heat grips menu on or off.
- Switch the heat grips menu on and off.

8.1 Adjusting the driver's seat

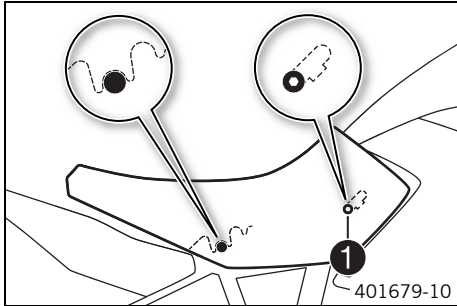
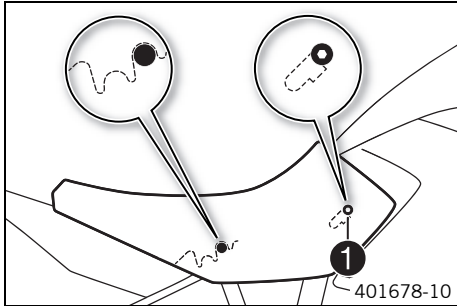

Preparatory work

- Remove the passenger seat. (☛ p. 99)

Alternative 1

- Attach the driver's seat to the fuel tank at the recesses ❶, and push the driver's seat down and forward at the same time.

Alternative 2

- Attach the driver's seat to the fuel tank at the recesses ❶, and push the driver's seat up and forward at the same time.
- Finally, check that the driver's seat is correctly mounted.

Finishing work

- Mount the passenger seat. (☛ p. 100)

8.2 Handlebar position

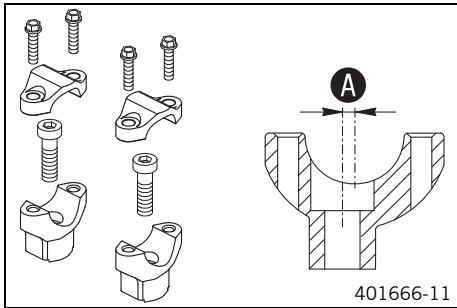

The holes on the handlebar support are placed at a distance of **A** from the center.

| | |
|------------------------|-------------------|
| Hole distance A | 3.5 mm (0.138 in) |
|------------------------|-------------------|

The handlebar can be mounted in two different positions. In this way, the handlebar can be mounted in the position that is most comfortable for the rider.

8.3 Adjusting the handlebar position

 **Warning**
Danger of accidents Handlebar breakage.

- If the handlebar is bent or straightened it will cause material fatigue, and the handlebar can break. Always replace handlebar.

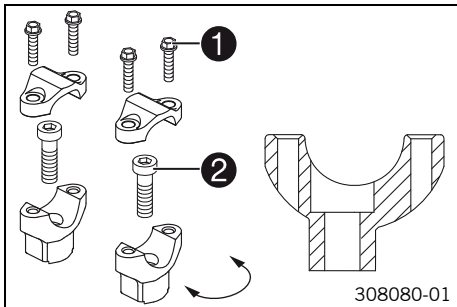

- Remove screws **1**. Remove the handlebar clamps. Remove the handlebar and lay it to one side.

 **Info**
 Protect the motorcycle and its attachments against damage by covering them. Do not bend the cables and lines.

- Remove screws **2**. Remove the handlebar support.
- Place the handlebar support in the required position. Mount and tighten screws **2**.

Guideline

| | | | |
|--------------------------|-----|------------------------|----------------------|
| Screw, handlebar support | M10 | 40 Nm (29.5 lbf ft) | Loctite® 243™ |
|--------------------------|-----|------------------------|----------------------|



Info

Position the left and right handlebar supports evenly.

- Position the handlebar.



Info

Make sure cables and wiring are positioned correctly.

- Position the handlebar clamps. Mount and evenly tighten screws ❶.

Guideline

| | | |
|------------------------|----|------------------------|
| Screw, handlebar clamp | M8 | 20 Nm (14.8 lbf ft) |
|------------------------|----|------------------------|

8.4 Adjusting the wind shield

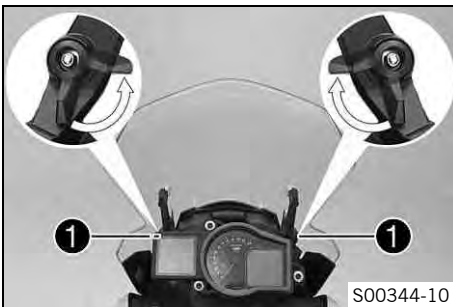

- Release clamping lever ❶ by pulling in the direction of the arrow.

8 ERGONOMICS

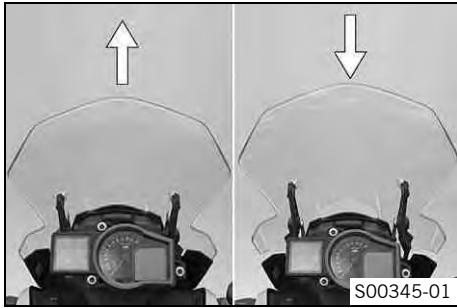

- Move the wind shield in the required position.

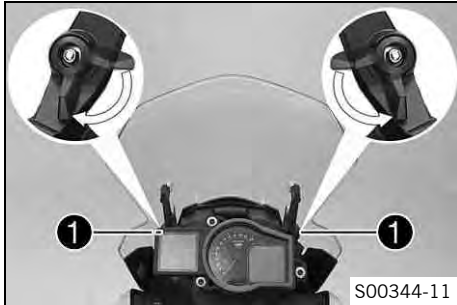

- Lock clamping lever ❶ by pushing in the direction of the arrow.

8.5 Adjusting the basic setting of the clutch lever



- Adjust the basic setting of the clutch lever to your hand size by turning adjusting screw ❶.

i Info

Turn the adjusting screw clockwise to increase the distance between the clutch lever and the handlebar.
Turn the adjusting screw counterclockwise to decrease the distance between the clutch lever and the handlebar.
The range of adjustment is limited.
Turn the adjusting screw by hand only, and do not apply any force.
Do not make any adjustments while riding!

8.6 Adjusting the basic position of the hand brake lever



- Adjust the basic position of the hand brake lever to your hand size by turning adjusting wheel ❶.

i Info

Push the hand brake lever forward and turn the adjusting wheel.
Do not make any adjustments while riding.

8.7 Rider footrests

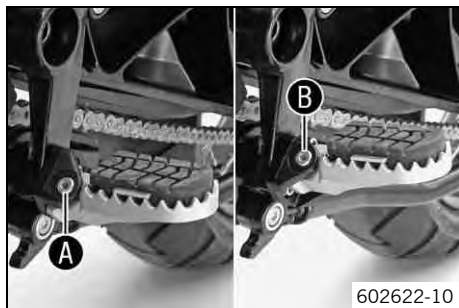

The rider footrests can be mounted in one of two positions.

Possible states

- Rider footrests, low **A**
- Rider footrests, high **B**

8.8 Adjusting the footrests



Info

The operations are the same for the left and right sides.

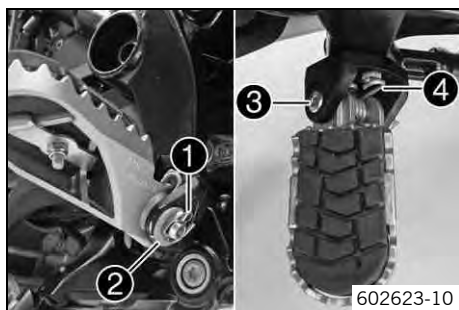

- Remove cotter pin **1** with washer **2**.
- Remove pin **3** of the rider footrest.
- Take off the rider footrest **4** with the spring.

8 ERGONOMICS

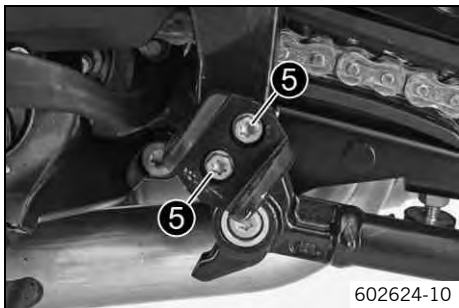

- Remove screws ⑤.



- Adjust the footrest bracket to the desired position.

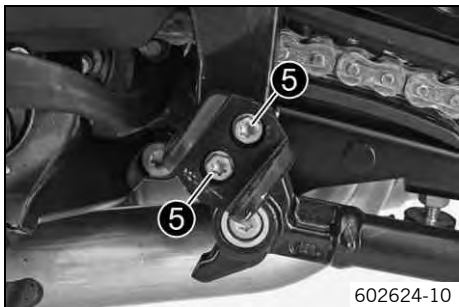

- Mount and tighten screws ⑤.

Guideline

| | | | |
|-------------------------------|----|------------------------|---------------|
| Screw, front footrest bracket | M8 | 25 Nm (18.4 lbf ft) | Loctite® 243™ |
|-------------------------------|----|------------------------|---------------|



- Mount the rider footrest with spring ④ and pin ③.

Pliers for footrest spring (58429083000)

- Mount washer ② and cotter pin ①.

8.9 Foot brake lever



Foot brake lever ① is located in front of the right footrest.
The rear brake is activated using the foot brake lever.

8.10 Adjusting the basic position of the foot brake lever 🛠️



Warning

Danger of accidents Brake system failure.

- If there is no free travel on the foot brake lever, pressure builds up on the rear brake circuit. The rear brake can fail due to overheating. Adjust the free travel on foot brake lever according to specifications.

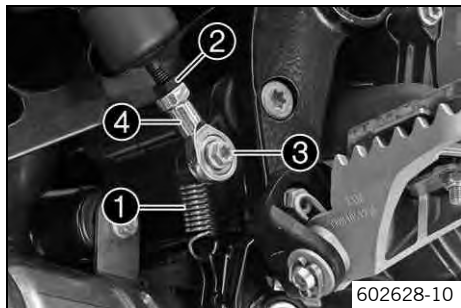

- Disconnect spring ①.
- Loosen nut ②.
- Remove screw ③.
- To adjust the basic position of the foot brake lever to individual requirements, turn ball joint ④ accordingly.



Info

The range of adjustment is limited.
The screw must be screwed into the ball joint by at least 5 turns.

- Hold ball joint ④ and tighten nut ②.

Guideline

| | | |
|------------------------|----|--------------------|
| Remaining chassis nuts | M6 | 10 Nm (7.4 lbf ft) |
|------------------------|----|--------------------|

- Mount and tighten screw ③.

Guideline

| | | |
|------------------------|----|--------------------|
| Remaining chassis nuts | M6 | 10 Nm (7.4 lbf ft) |
|------------------------|----|--------------------|

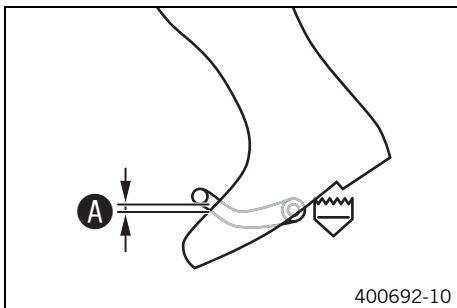

- Attach spring ①.

8.11 Checking the basic position of the shift lever



- Sit on the vehicle in the riding position and determine distance **A** between the upper edge of your boot and the shift lever.

| | |
|---|-------------------------------|
| Distance between shift lever and upper edge of boot | 10... 20 mm (0.39... 0.79 in) |
|---|-------------------------------|

- » If the distance does not meet specifications:
 - Adjust the basic position of the shift lever.  ( p. 69)

8.12 Adjusting the basic position of the shift lever

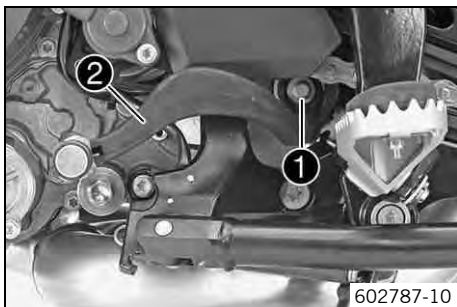

- Remove screw **1** and take off shift lever **2**.

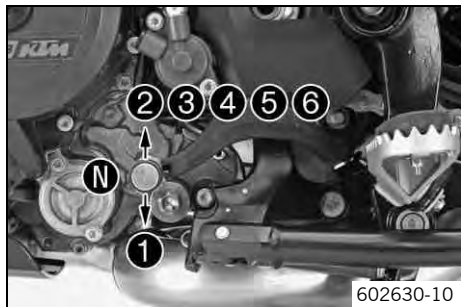

- Clean gear teeth **A** of the shift lever and shift shaft.
- Mount the shift lever on the shift shaft in the required position and engage the gearing.



Info

The range of adjustment is limited.
The shift lever must not come into contact with any other vehicle components during the shift procedure.

- Mount and tighten the screw.

Guideline

| | | | |
|--------------------|----|------------------------|----------------------|
| Screw, shift lever | M6 | 18 Nm (13.3 lbf ft) | Loctite® 243™ |
|--------------------|----|------------------------|----------------------|

9.1 Advice on first use



Danger

Danger of accidents Danger arising from the rider's judgement being impaired.

- Do not operate the vehicle while under the influence of alcohol, drugs and certain medications or physically or mentally impaired.



Warning

Risk of injury Missing or poor protective clothing presents an increased safety risk.

- Wear protective clothing (helmet, boots, gloves, pants and jacket with protectors) every time you ride the vehicle. Always wear protective clothing that is in good condition and meets the legal requirements.



Warning

Danger of crashing Poor vehicle handling due to different tire tread patterns on front and rear wheels.

- The front and rear wheels must be fitted with tires with similar tread patterns to prevent loss of control over the vehicle.



Warning

Danger of accidents Uncontrollable handling characteristic due to non-approved and/or non-recommended tires/wheels.

- Only tires/wheels approved by KTM and with the corresponding speed index should be used.



Warning

Danger of accidents Reduced road grip with new tires.

- New tires have a smooth rolling surface and therefore cannot provide full road grip. The entire rolling surface must be roughened in the first 200 kilometers (124.3 miles) by moderate riding at alternating angles. The full grip levels are not achieved until the tires have been run in.



Warning

Danger of accidents Failure of brake system.

- If the foot brake lever is not released, the brake linings drag continuously. The rear brake may fail due to overheating. Take your foot off the foot brake lever when you are not braking.



Info

When using your vehicle, remember that others may feel disturbed by excessive noise.

- Make sure that the pre-delivery inspection work has been carried out by an authorized KTM workshop.
 - ✓ You receive a delivery certificate and the Service and Warranty Booklet at vehicle handover.
- Before your first trip, read the entire Owner's Manual carefully.
- Get to know the controls.
- Adjust the motorcycle to your requirements, as described in the "Ergonomics" chapter.
- Get used to handling the motorcycle on a suitable piece of land before making a longer trip. Try also to ride as slowly as possible and in a standing position to get a better feeling for the motorcycle.
- Hold the handlebar firmly with both hands and keep your feet on the footrests when riding.
- Run the engine in.

9.2 Running in the engine

- During the running-in phase, do not exceed the specified engine speed.

Guideline

| | |
|-------------------------------------|------------|
| Maximum engine speed | |
| During the first: 1,000 km (620 mi) | 6,500 rpm |
| After the first: 1,000 km (620 mi) | 10,250 rpm |

- Avoid fully opening the throttle!

**Info**

If the maximum engine speed is exceeded before the first service, the shift warning light flashes.

9.3 Loading the vehicle

**Warning**

Danger of accidents Unstable handling characteristics.

- Do not exceed the maximum permitted weight and axle loads. The overall weight consists of: motorcycle operational and with a full tank, driver and passenger with protective clothing and helmet, baggage.

**Warning**

Danger of accidents Unstable handling characteristics due to incorrect mounting of suitcase and/or tank rucksack.

- Mount and secure suitcase and tank rucksack according to the manufacturer's instructions.

**Warning**

Danger of accidents Unstable handling characteristics at high speed.

- Adapt your speed according to your payload. Ride more slowly if your motorcycle is loaded with cases or other baggage.
Maximum speed with luggage 150 km/h (93.2 mph)

**Warning**

Danger of accidents Risk of breakage of suitcase system.

- If you have fitted suitcases on your motorcycle, read the manufacturer's specifications concerning the maximum payload.

**Warning**

Danger of accidents Poor visibility for other road users due to slipped baggage.

- If the tail light is covered, you are less visible to traffic behind you, especially in the dark. Check that your baggage is fixed properly at regular intervals.

9 PREPARING FOR USE

 **Warning**
Danger of accidents Changed handling characteristics and longer stopping distance with excessive payload.
– Adapt your speed according to your payload.

 **Warning**
Danger of accidents Unstable handling characteristics due to slipped baggage.
– Check the way your baggage is fixed regularly.

 **Warning**
Danger of burns A hot exhaust system can burn baggage.
– Fasten your baggage in such a way that it cannot be burned or singed by the hot exhaust system.

-
- If you are carrying baggage, make sure it is fixed firmly as close as possible to the center of the vehicle and ensure even weight distribution between the front and rear wheels.
 - Do not exceed the maximum permitted total weight and the axle loads.

Guideline

| | |
|-------------------------------------|------------------|
| Maximum permissible total weight | 440 kg (970 lb.) |
| Maximum permissible front axle load | 159 kg (351 lb.) |
| Maximum permissible rear axle load | 281 kg (619 lb.) |

10.1 Checks and maintenance measures when preparing for use



Info

Before every trip, check the condition of the vehicle and ensure that it is roadworthy. The vehicle must be in perfect technical condition when it is being operated.

- Check the engine oil level. (☞ p. 175)
- Check the brake fluid level of the front brake. (☞ p. 127)
- Check the rear brake fluid level. (☞ p. 130)
- Check the front brake linings. (☞ p. 130)
- Check the rear brake linings. (☞ p. 133)
- Check that the brake system is functioning properly.
- Check the coolant level in the compensating tank. (☞ p. 170)
- Check the chain for dirt. (☞ p. 101)
- Check the chain tension. (☞ p. 103)
- Check the tire condition. (☞ p. 145)
- Check the tire air pressure. (☞ p. 146)
- Check the spoke tension. (☞ p. 147)
- Check the settings of all controls and ensure that they can be operated smoothly.
- Check that the electrical equipment is functioning properly.
- Check that baggage is correctly secured.
- Check the setting of the rear mirror.
- Check the fuel level.

10.2 Starting

 **Danger**
Danger of poisoning Exhaust gases are toxic and inhaling them may result in unconsciousness and/or death.

- When running the engine, always make sure there is sufficient ventilation, and do not start or run the engine in an enclosed space without an effective exhaust extraction system.

 **Caution**
Danger of accidents If the vehicle is operated with a discharged battery or without a battery, electronic components and safety equipment may be damaged.



- Never operate the vehicle with a discharged battery or without a battery.

Note

Engine failure High engine speeds in cold engines have a negative effect on the service life of the engine.

- Always warm up the engine at low engine speeds.



- Press the emergency OFF switch to the position **ON** .
- Switch on the ignition by turning the black ignition key to the position **ON** .
- ✓ After you switch on the ignition, you can hear the fuel pump working for about two seconds. The function check of the combination instrument is run at the same time.
- ✓ The ABS lamp lights up and goes back out after starting off.
- Shift the transmission to idle **N**.
- ✓ The green idling speed indicator lamp **N** lights up.



- Press the electric starter button (⚡).

i Info

Do not press the electric starter button until the combination instrument function check is finished.

When starting, **DO NOT** open the throttle. If you open the throttle during the starting procedure, fuel is not injected by the engine management system and the engine cannot start.

Press the electric starter button (⚡) for at most 5 seconds. Wait for a least 5 seconds before trying again.

This motorcycle is equipped with a safety starting system. You can only start the engine if the transmission is in neutral or if the clutch lever is pulled when a gear is engaged. If the side stand is folded out and you shift into gear, the engine stops.

- Remove the motorcycle from the center stand or side stand.

10.3 Starting off

- Pull the clutch lever, engage 1st gear, release the clutch lever slowly and simultaneously open the throttle carefully.

10.4 Shifting, riding



Warning

Danger of accidents Abrupt load alterations can cause the vehicle to get out of control.

- Avoid abrupt load alterations and sudden braking actions, and adapt your speed to the road conditions.



Warning

Danger of accidents If you change down at high engine speed, the rear wheel can lock up.

- Do not change into a low gear at high engine speed. The engine races and the rear wheel can lock up.



Warning

Danger of accidents Malfunctions caused by incorrect ignition key position.

- Do not change the ignition key position during a journey.



Warning

Danger of accidents Distraction from traffic activity by adjustments to the vehicle.

- Make all adjustments when the vehicle is at a standstill.



Warning

Risk of injury Falling off of the passenger.

- The passenger must be seated properly on the passenger seat and hold on to the front rider or the grab handles. The feet must be positioned on the passenger footrests. Note the regulations governing the minimum age of passengers.



Warning

Danger of accidents Danger of accidents caused by dangerous driving.

- Comply with traffic regulations and ride defensively and foresightedly to detect sources of danger early on.



Warning

Danger of accidents Reduced road grip with cold tires.

- On every journey, take the first miles carefully at moderate speed until the tires reach operating temperature and optimal road grip is ensured.



Warning

Danger of accidents Reduced road grip with new tires.

- New tires have a smooth rolling surface and therefore cannot provide full road grip. The entire rolling surface must be roughened in the first 200 kilometers (124.3 miles) by moderate riding at alternating angles. The full grip levels are not achieved until the tires have been run in.



Warning

Danger of accidents Unstable handling characteristics.

- Do not exceed the maximum permitted weight and axle loads. The overall weight consists of: motorcycle operational and with a full tank, driver and passenger with protective clothing and helmet, baggage.



Warning

Danger of accidents Unstable handling characteristics due to slipped baggage.

- Check the way your baggage is fixed regularly.



Warning

Danger of accidents Lack of roadworthiness.

- After a fall, check the vehicle as usual before preparing for use.

Note

Engine failure Unfiltered intake air has a negative effect on the service life of the engine.

- Never ride the vehicle without an air filter since dust and dirt can get into the engine and result in increased wear.

Note

Engine failure Overheating of engine.

- If the coolant temperature warning lamp lights up, stop and switch off the engine. Allow the engine to cool down and check the coolant level in the radiator, and top up if necessary. If you continue with the coolant temperature warning lamp alight, you may have engine failure.



Info

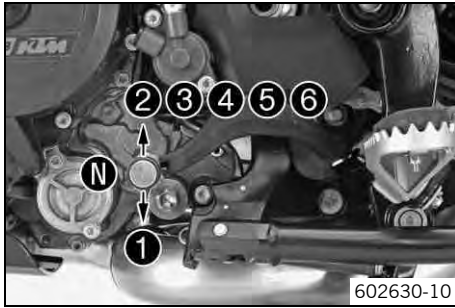

If you hear unusual noises while riding, stop immediately, switch off the engine and contact an authorized KTM workshop.



- When conditions allow (incline, road situation, etc.), you can shift into a higher gear.
- Release the throttle while simultaneously pulling the clutch lever, shift into the next gear, release the clutch lever, and open the throttle.

i Info

You can see the positions of the 6 forward gears in the figure. The idle position is between the first and second gears. First gear is used for starting off or for steep inclines.

-
- After reaching maximum speed by fully opening the throttle grip, turn the throttle back so it is $\frac{3}{4}$ open. This will barely reduce the speed but fuel consumption will be considerably lower.
 - Accelerate only up to a speed suitable for the road surface and weather conditions. Particularly in bends, do not shift, and accelerate very carefully.
 - To shift down, brake if necessary and close the throttle at the same time.
 - Pull the clutch lever and shift into a lower gear, release the clutch lever slowly, and open the throttle or shift again.
 - If the engine stalls (e.g. at a crossroads), just pull the clutch lever and press the electric starter button. You do not have to shift into neutral.
 - Switch off the engine if you expect to be standing for a long time.
 - If the oil pressure warning lamp  lights up during a trip, stop immediately and switch off the engine. Contact an authorized KTM workshop.
 - If the engine warning lamp  lights up during a trip, please contact an authorized KTM workshop as soon as possible.

i Info

From the flash rhythm you can deduce a two-digit number, the so-called blink code. The blink code tells you which component is affected by a malfunction.

-
- If the general warning lamp  lights up during a trip, the matrix display shows a message for 10 seconds.



Info

Very important messages are stored in the **"Warnings"** menu.

- If the icy road symbol ❄ appears in the combination instrument, the roads may be icy. Adjust your speed to the road conditions.

10.5 Applying the brakes



Warning

Danger of accidents Reduced braking efficiency due to a wet or dirty brake system.

- Clean or dry a dirty or wet brake system by riding and braking gently.



Warning

Danger of accidents Reduced braking efficiency caused by spongy pressure point of front or rear brake.

- Check the brake system and do not continue riding. (Your authorized KTM workshop will be glad to help.)



Warning

Danger of accidents Failure of brake system.

- If the foot brake lever is not released, the brake linings drag continuously. The rear brake may fail due to overheating. Take your foot off the foot brake lever when you are not braking.



Warning

Danger of accidents Longer stopping distance due to higher overall weight.

- Take the longer stopping distance into account when carrying a passenger and baggage.



Warning

Danger of accidents Delayed brake action on salted roads.

- There may be salt deposits on the brake discs. In order to restore the normal braking efficiency, you will need to remove the deposits from the discs by carefully applying the brakes.



Warning

Danger of accidents Greater stopping distance due to ABS.

- Braking should be appropriate to the driving situation and the road conditions.



Warning

Danger of accidents Excessively forceful braking can cause the wheels to block.

- ABS must be switched on to be effective.



Warning

Danger of accidents Vehicle rollover

- It is not always possible to prevent vehicle rollover in extreme riding situations (e. g. luggage loaded with a high center of gravity, varying road surfaces, steep descents, full braking without disengaging the gear). Adapt your riding style to the road conditions and your riding ability.

-
- When braking, release the throttle and apply the front and rear brakes at the same time.



Info

When ABS is enabled, you can achieve maximum braking power even on low grip surfaces such as sandy, wet, or slippery terrain without locking of the wheels.



Warning

Danger of accidents Locking of the wheels due to braking action of the engine.

- Pull the clutch during emergency braking, full brake application and when braking on a slippery surface.



Warning

Danger of accidents Road grip is reduced when braking with the motorcycle at an angle or on a laterally inclined surface.

- Braking should be completed before you enter into a bend.

-
- Braking should always be completed before you go into a bend. Change down to a lower gear appropriate to your road speed.

- On long downhill stretches, use the braking effect of the engine. Change down one or two gears, but do not over-rev the engine. In this way, you have to brake far less and the brakes do not overheat.

10.6 Stopping, parking



Warning

Risk of misappropriation Usage by unauthorized persons.

- Never leave the vehicle while the engine is running. Secure the vehicle against use by unauthorized persons. If you leave the vehicle, lock the steering and remove the ignition key.



Warning

Danger of burns Some vehicle components become very hot when the vehicle is operated.

- Do not touch hot components such as exhaust system, radiator, engine, shock absorber, and the brake system. Allow these components to cool down before starting work on them.

Note

Danger of damage The parked vehicle may roll away or fall over.

- Always place the vehicle on a firm and even surface.

Note

Fire hazard Some vehicle components become very hot when the vehicle is operated.

- Do not park the vehicle near flammable or explosive substances. Do not place objects on the vehicle while it is still warm from being run. Always let the vehicle cool first.

Note



Material damage Damage to or destruction of components due to excessive load.

- The side stand is only designed for the weight of the motorcycle. Do not sit on the motorcycle when it is resting on the side stand. The side stand or the frame may become damaged and the motorcycle may fall over.

Note

Material damage Damage and destruction of components from excessive load.

- The center stand is only designed for the weight of the motorcycle and the baggage. Do not sit on the motorcycle when it is resting on the center stand. The center stand or the frame may become damaged and the motorcycle may fall over.
 - Pull the motorcycle up onto the center stand at the grab handles.
-

- Apply the brakes on the motorcycle.
 - Shift the transmission to idle .
 - Switch off the ignition by turning the black ignition key to the position **OFF** .
-

Info

If the engine is switched off with the emergency OFF switch and the ignition remains switched on at the ignition lock, power continues to flow to most power consumers. This discharges the battery. You should therefore always switch off the engine with the ignition key – the emergency OFF switch is intended for emergencies only.



- Park the motorcycle on a firm surface.

Alternative 1

- Swing the side stand forward with your foot as far as it will go and lean the vehicle on it.

Alternative 2

(Option: Center stand)

- Raise the vehicle with the center stand. (👉 p. 98)
- Lock the steering by turning the handlebar to the left, pressing the black ignition key down in the position **OFF**  and turning it to the position **LOCK** . To make the steering lock engage more easily, move the handlebar a little to the left and right. Remove the black ignition key.

10.7 Transport

Note

Danger of damage The parked vehicle may roll away or fall over.

- Always place the vehicle on a firm and even surface.

Note

Fire hazard Some vehicle components become very hot when the vehicle is operated.

- Do not park the vehicle near flammable or explosive substances. Do not place objects on the vehicle while it is still warm from being run. Always let the vehicle cool first.

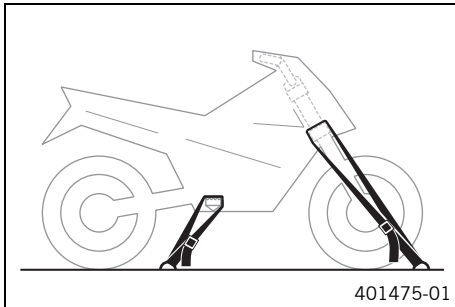

- Switch off the engine.
- Use tension belts or other suitable devices to secure the motorcycle against accidents or falling over.

10.8 Refueling



Danger

Fire hazard Fuel is highly flammable.

- Never refuel the vehicle near open flames or burning cigarettes, and always switch off the engine first. Be careful that no fuel is spilt, especially on hot vehicle components. Clean up spilt fuel immediately.
- The fuel in the fuel tank expands when warm and may emerge if overfilled. Follow the instructions on refueling.



Warning

Danger of poisoning Fuel is poisonous and a health hazard.

- Fuel must not come into contact with the skin, eyes, or clothing. Do not breathe in the fuel vapors. If contact occurs with the eyes, rinse with water immediately and contact a physician. Immediately clean contaminated areas on the skin with soap and water. If fuel is swallowed, contact a physician immediately. Change clothing that is contaminated with fuel.

Note

Material damage Premature clogging of the fuel filter.

- In some countries and regions, the available fuel quality and cleanliness may not be sufficient. This will result in problems with the fuel system. (Your authorized KTM workshop will be glad to help.)
- Only refuel with clean fuel that meets the specified standards.



Warning

Environmental hazard Improper handling of fuel is a danger to the environment.

- Do not allow fuel to get into the ground water, the ground, or the sewage system.

10 RIDING INSTRUCTIONS

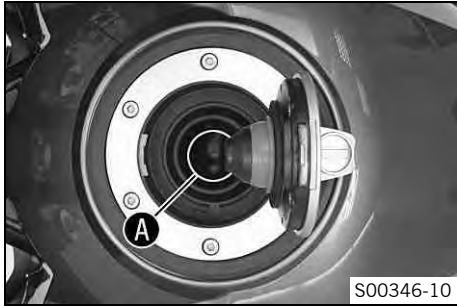

- Switch off the engine.
- Open the filler cap. (☛ p. 31)
- Fill the fuel tank with fuel up to the lower edge **A** of the filler neck.













| | | |
|-----------------------------------|-------------------|--|
| Total fuel tank capacity, approx. | 23 l (6.1 US gal) | Super unleaded (ROZ 95/RON 95/PON 91) (☛ p. 207) |
|-----------------------------------|-------------------|--|

- Close the filler cap. (☛ p. 32)

11.1 Additional information

Any further work that results from the required work or from the recommended work must be ordered separately and can be invoiced separately.

11.2 Required work

| | Every two years | Every year | Every 30,000 km (18,600 mi) | Every 15,000 km (9,300 mi) | After 1,000 km (620 mi) |
|--|-----------------|------------|-----------------------------|----------------------------|-------------------------|
| Read out the trouble code memory using the KTM diagnostics tool.  | ○ | ● | ● | ● | ● |
| Check the fuel pressure.  | | ● | ● | ● | ● |
| Check the functioning of the electrical equipment. | ○ | ● | ● | ● | ● |
| Change the engine oil and filter, clean the oil screens.  ( p. 176) | ○ | ● | ● | ● | ● |
| Check the brake discs. ( p. 126) | ○ | ● | ● | ● | ● |
| Check the front brake linings. ( p. 130) | ○ | ● | ● | ● | ● |
| Check the rear brake linings. ( p. 133) | ○ | ● | ● | ● | ● |
| Retighten the spokes.  | ○ | | | | |
| Check the spoke tension. ( p. 147) | | ● | ● | ● | ● |
| Check the rim run-out.  | ○ | ● | ● | ● | ● |
| Check the tire condition. ( p. 145) | ○ | ● | ● | ● | ● |
| Check the tire air pressure. ( p. 146) | ○ | ● | ● | ● | ● |
| Check the rear brake fluid level. ( p. 130) | ○ | ● | ● | ● | |

11 SERVICE SCHEDULE











| | | Every two years | | | |
|---|---|-----------------------------|---|---|---|
| | | Every year | | | |
| | | Every 30,000 km (18,600 mi) | | | |
| | | Every 15,000 km (9,300 mi) | | | |
| | | After 1,000 km (620 mi) | | | |
| Check the shock absorber and fork for leaks. Perform a fork service and shock absorber service as needed and depending on how the vehicle will be used. | ○ | ● | ● | ● | ● |
| Check the chain, rear sprocket and engine sprocket. (🔧 p. 106) | | ● | ● | ● | ● |
| Check the chain tension. (🔧 p. 103) | ○ | ● | ● | ● | ● |
| Check the brake lines for damage and leakage. | ○ | ● | ● | ● | ● |
| Check the brake fluid level of the front brake. (🔧 p. 127) | ○ | ● | ● | ● | |
| Check the coolant level in the compensating tank. (🔧 p. 170) | ○ | ● | ● | ● | ● |
| Change the air filter. Clean the air filter box. 🛠️ | | ● | ● | | |
| Check the cables for damage and routing without sharp bends. (fuel tank removed) 🛠️ | | ● | ● | ● | ● |
| Change the spark plugs. (air filter removed) 🛠️ | | | ● | | |
| Check the valve clearance. (air filter and spark plugs removed) 🛠️ | | | ● | | |
| Change the secondary air system membranes. 🛠️ | | | ● | | |
| Change the front brake fluid. 🛠️ | | | | | ● |
| Change the rear brake fluid. 🛠️ | | | | | ● |
| Check the steering head bearing play. (🔧 p. 110) | ○ | ● | ● | ● | ● |

11 SERVICE SCHEDULE

| | Every two years | | | | |
|--|-----------------------------|---|---|---|---|
| | Every year | | | | |
| | Every 30,000 km (18,600 mi) | | | | |
| | Every 15,000 km (9,300 mi) | | | | |
| | After 1,000 km (620 mi) | | | | |
| Check the headlight setting. (☞ p. 168) | ○ | ● | ● | | |
| Final check: Check the vehicle for roadworthiness and take a test ride. | ○ | ● | ● | ● | ● |
| Read out the error memory after the test ride using the KTM diagnostics tool. ☞ | ○ | ● | ● | ● | ● |
| Check the CO adjustment with the KTM diagnostics tool. ☞ | ○ | ● | ● | | |
| Make the service entry in the KTM DEALER.NET and in the Service and Warranty Booklet. ☞ | ○ | ● | ● | ● | ● |

- One-time interval
- Periodic interval

11.3 Recommended work

| | Every four years | | | | |
|---|----------------------------|---|---|---|---|
| | Every two years | | | | |
| | Every year | | | | |
| | Every 15,000 km (9,300 mi) | | | | |
| | After 1,000 km (620 mi) | | | | |
| Check the oil jet for the clutch lubrication.  | ○ | ● | | | |
| Check the swingarm bearing.  | | ● | | | |
| Check the wheel bearing for play.  | | ● | | | |
| Grease all moving parts (e.g., side stand, hand lever, chain, ...) and check for smooth operation.  | ○ | ● | ● | ● | ● |
| Check all hoses (e.g. fuel, cooling, bleeder, drainage, etc.) and sleeves for cracking, leaks, and incorrect routing.  | | ● | ● | ● | ● |
| Check the antifreeze.  | ○ | ● | ● | ● | ● |
| Check/rectify the fluid level of the hydraulic clutch. ( p. 109) | | ● | ● | | |
| Change the hydraulic clutch fluid.  | | | | ● | ● |
| Check the screws and nuts for tightness.  | ○ | ● | ● | ● | ● |
| Change the coolant.  | | | | | ● |

- One-time interval
- Periodic interval

12.1 "Damping" (Option: With EDS)



401831-01

Possible states

- SPORT – Firm tuning of the spring elements with very direct feedback from the chassis
- STREET – Normal tuning of the spring elements with direct feedback from the chassis
- COMFORT – Soft tuning of the spring elements with good feedback from the chassis

Different tunings for the damping of the spring elements can be selected in the "**Damping**" menu. You can choose from "**SPORT**", "**STREET**", and "**COMFORT**".

12.2 "Load" (Option: With EDS)

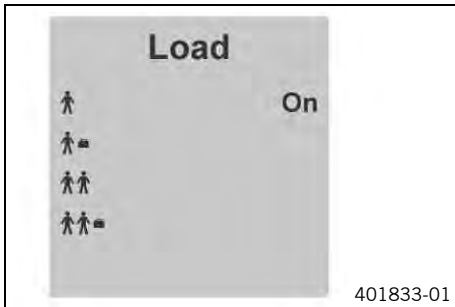

401833-01

Different vehicle loading states can be selected in the "**Load**" menu. A selection can be made between one-person operation, one-person operation with luggage, two-person operation, and two-person operation with luggage.

The load mode selected last is displayed on the right in the segment display.

Info

For the setting to be accepted by the motorcycle, the motorcycle must be stationary and the engine must be running.

The symbol of the last load status flashes until the new setting is adopted.

12.3 Fork/shock absorber

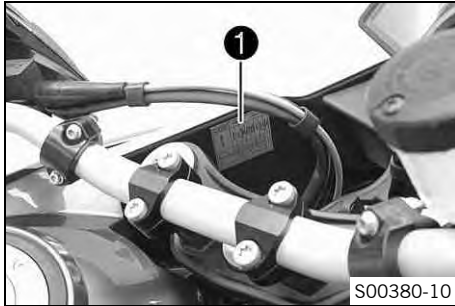

(Option: Without EDS)

The fork and the shock absorber offer many options of adapting the suspension to the riding style and the payload.



Info

The recommendations for the suspension setting are shown in Table 1. The table is found on the left inside cover of the fuel tank.

These adjustments are guidelines and should always be the basis for a suspension setting. If the guidelines are not adhered to, the riding characteristics could deteriorate, particularly at high speeds.

(Option: With EDS)

The **EDS (Electronic Damping System)** can be used to tune the suspension individually without the use of tools.

Always adapt the suspension to your riding style and the payload.

In the "**Load**" menu, the suspension can be set to the payload.

In the "**Damping**" menu, the damping behavior of the suspension can be set.



12.4 Adjusting the compression damping of the fork (Option: Without EDS)



Info

The hydraulic compression damping determines the fork suspension behavior.

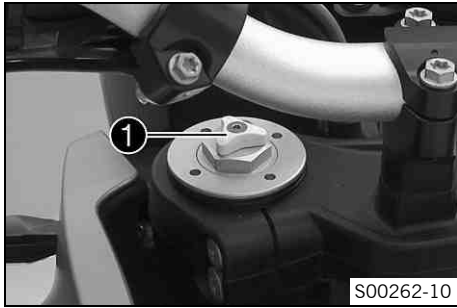

- Turn the white adjusting screw ❶ all the way clockwise.

i **Info**

Adjusting screw ❶ is located at the upper end of the left fork leg. The compression damping is located in the left fork leg **COMP** (white adjusting screw). The rebound damping is located in the right fork leg **REB** (red adjusting screw).

- Turn counterclockwise by the number of clicks corresponding to the fork type.

Guideline

| Compression damping | |
|---------------------|-----------|
| Comfort | 17 clicks |
| Standard | 12 clicks |
| Sport | 7 clicks |
| Full payload | 7 clicks |

i **Info**

Turn clockwise to increase damping; turn counterclockwise to reduce damping.

12.5 Adjusting the rebound damping of the fork (Option: Without EDS)

i **Info**

The hydraulic rebound damping determines the fork suspension behavior.

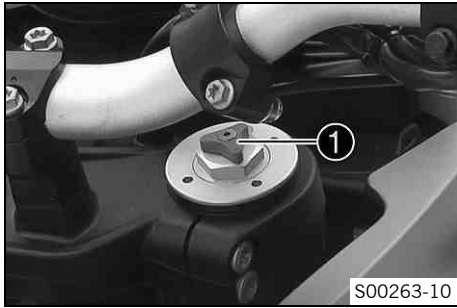

- Turn the red adjusting screw ❶ all the way clockwise.

i **Info**

Adjusting screw ❶ is located at the upper end of the right fork leg. The rebound damping is located in the right fork leg **REB** (red adjusting screw). The compression damping is located in the left fork leg **COMP** (white adjusting screw).

- Turn counterclockwise by the number of clicks corresponding to the fork type.

Guideline

| | |
|-----------------|-----------|
| Rebound damping | |
| Comfort | 17 clicks |
| Standard | 12 clicks |
| Sport | 7 clicks |
| Full payload | 7 clicks |

i **Info**

Turn clockwise to increase damping; turn counterclockwise to reduce damping.

12.6 Adjusting the rebound damping of the shock absorber (Option: Without EDS)

! Caution

Danger of accidents Disassembly of pressurized parts can lead to injury.

- The shock absorber is filled with high density nitrogen. Adhere to the description provided. (Your authorized KTM workshop will be glad to help.)

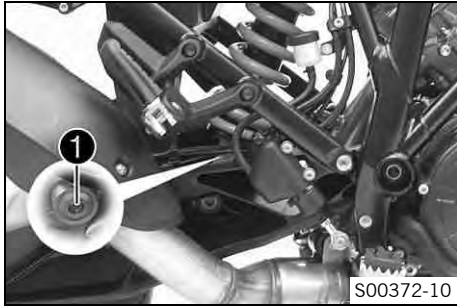

- Turn adjusting screw ❶ clockwise up to the last perceptible click.
- Turn counterclockwise by the number of clicks corresponding to the shock absorber type.

Guideline

| Rebound damping | |
|-----------------|-----------|
| Comfort | 17 clicks |
| Standard | 12 clicks |
| Sport | 7 clicks |
| Full payload | 7 clicks |

i Info Turn clockwise to increase damping; turn counterclockwise to reduce damping.

12.7 Adjusting the spring preload of the shock absorber (Option: Without EDS)

! Caution
Danger of accidents Disassembly of pressurized parts can lead to injury.

- The shock absorber is filled with high density nitrogen. Adhere to the description provided. (Your authorized KTM workshop will be glad to help.)

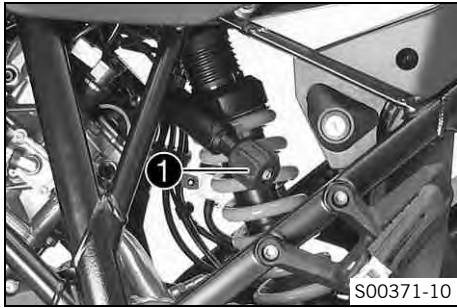

- Turn handwheel ❶ counterclockwise as far as it will go.
- Turn it clockwise by the number of turns corresponding to the shock absorber type and use.

Guideline

| Spring preload | |
|----------------|----------|
| Comfort | 4 turns |
| Standard | 4 turns |
| Sport | 4 turns |
| Full payload | 12 turns |

i **Info** Turn clockwise to increase the spring preload; turn counterclockwise to reduce the spring preload.

13.1 Raising the vehicle with the center stand (Option: Center stand)

Note

Danger of damage The parked vehicle may roll away or fall over.

- Always place the vehicle on a firm and even surface.

Note

Material damage Damage and destruction of components from excessive load.

- The center stand is only designed for the weight of the motorcycle and the baggage. Do not sit on the motorcycle when it is resting on the center stand. The center stand or the frame may become damaged and the motorcycle may fall over.
- Pull the motorcycle up onto the center stand at the grab handles.



- Stand to the left of the vehicle.
- Hold the handlebar with your left hand and push the center stand onto the ground with your right foot.
- Put your entire weight on arm ❶ of the center stand while pulling the vehicle up at the left grab handle until the center stand folds out all the way.

13.2 Removing the vehicle from the center stand (Option: Center stand)

Note

Danger of damage The parked vehicle may roll away or fall over.

- Always place the vehicle on a firm and even surface.

13 SERVICE WORK ON THE CHASSIS

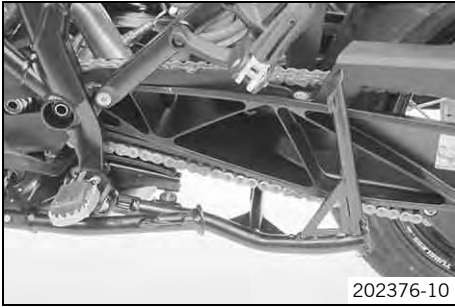

- Unlock the steering and move the vehicle forward with both hands on the handlebar.
- While the vehicle tips off of the center stand, activate the front brake to stop the vehicle from rolling away.
- Check that the center stand is folded all the way up.

13.3 Removing the passenger seat

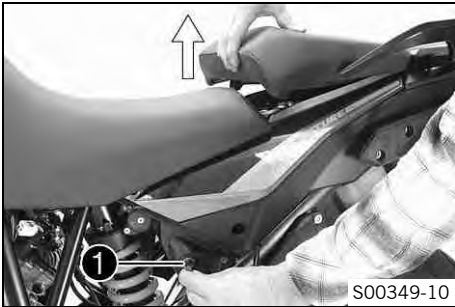

- Insert the ignition key in seat lock ❶ and turn it clockwise.
- Raise the front of the passenger seat, pull it toward the tank, and remove it upward.
- Remove the ignition key.

13.4 Mounting the passenger seat

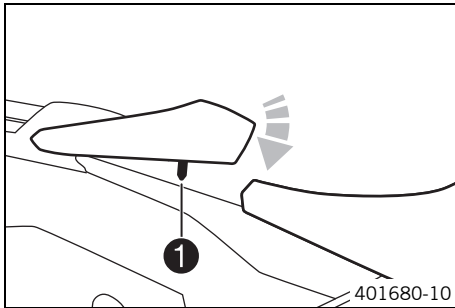

- Attach the hooks on the passenger seat to the brackets on the subframe, and lower at the front while pushing toward the rear.
- Insert locking pin ❶ into the lock housing and push down the front of the passenger seat until the locking pin engages with a click.
- Check that the passenger seat is correctly mounted.

13.5 Removing the driver's seat



Preparatory work

- Remove the passenger seat. (👉 p. 99)

Main work

- Raise the rear of the driver's seat.
- Detach the front of the driver's seat and remove it.

13.6 Mounting the driver's seat

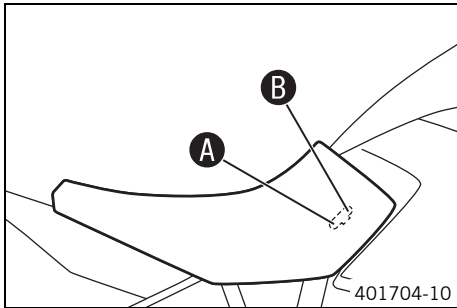

Main work

- Attach the recesses on the driver's seat to the fuel tank at the desired seat position **A** or **B**, and push the driver's seat forward while lowering it at the rear.
- Finally, check that the driver's seat is correctly mounted.

Finishing work

- Mount the passenger seat. (👉 p. 100)

13.7 Checking for chain dirt

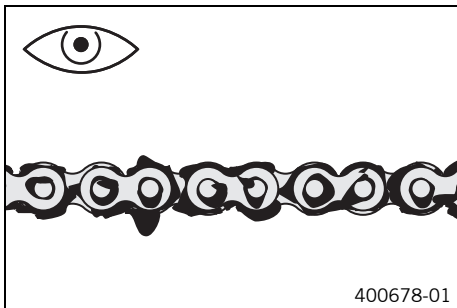

- Check the chain for coarse dirt accumulation.
 - » If the chain is very dirty:
 - Clean the chain. (👉 p. 102)

13.8 Cleaning the chain



Warning

Danger of accidents Oil or grease on the tires reduces their grip.

- Remove oil and grease with a suitable cleaning material.



Warning

Danger of accidents Reduced braking efficiency due to oil or grease on the brake discs.

- Always keep the brake discs free of oil and grease, and clean them with brake cleaner when necessary.



Warning

Environmental hazard Hazardous substances cause environmental damage.

- Oil, grease, filters, fuel, cleaners, brake fluid, etc., should be disposed of as stipulated in applicable regulations.



Info

The service life of the chain depends largely on its maintenance.

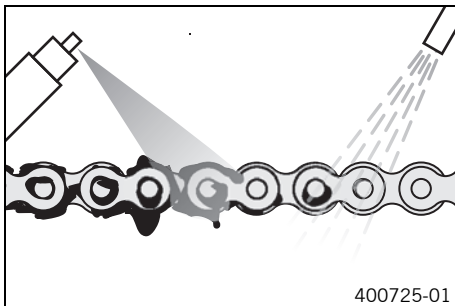

- Clean the chain regularly.
- Rinse off loose dirt with a soft jet of water.
- Remove old grease remains with chain cleaner.

Chain cleaner (☛ p. 209)

- After drying, apply chain spray.

Chain lube for road use (☛ p. 209)

13.9 Checking the chain tension



Warning

Danger of accidents Danger caused by incorrect chain tension.

- If the chain is too taut, the components of the secondary power transmission (chain, engine sprocket, rear sprocket, bearings in the transmission and in the rear wheel) will be under additional load. In addition to premature wear, this can cause the chain or the countershaft of the transmission to break in extreme cases. If the chain is too loose, however, it may fall off the engine sprocket or rear sprocket and block the rear wheel or damage the engine. Ensure that the chain tension is correct and adjust it if necessary.

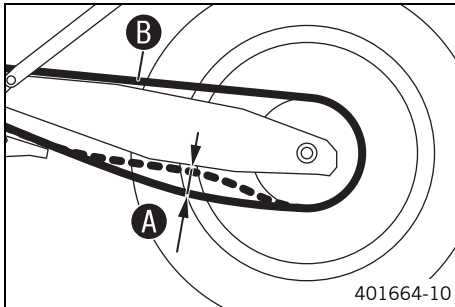

- Place the motorcycle onto the side stand.
- Shift the transmission to idle **N**.
- In the area in front of the chain guide, push the chain up and determine chain tension **A**.



Info

The upper part of the chain **B** must be taut.

Chain wear is not always even, so you should repeat this measurement at different chain positions.

| | |
|---------------|-------------------------------|
| Chain tension | 40... 45 mm (1.57... 1.77 in) |
|---------------|-------------------------------|

- » If the chain tension does not meet the specification:
 - Adjust the chain tension. (🔧 p. 104)

13.10 Adjusting the chain tension



Warning

Danger of accidents Danger caused by incorrect chain tension.

- If the chain is too taut, the components of the secondary power transmission (chain, engine sprocket, rear sprocket, bearings in the transmission and in the rear wheel) will be under additional load. In addition to premature wear, this can cause the chain or the countershaft of the transmission to break in extreme cases. If the chain is too loose, however, it may fall off the engine sprocket or rear sprocket and block the rear wheel or damage the engine. Ensure that the chain tension is correct and adjust it if necessary.

Preparatory work

- Check the chain tension. (👉 p. 103)

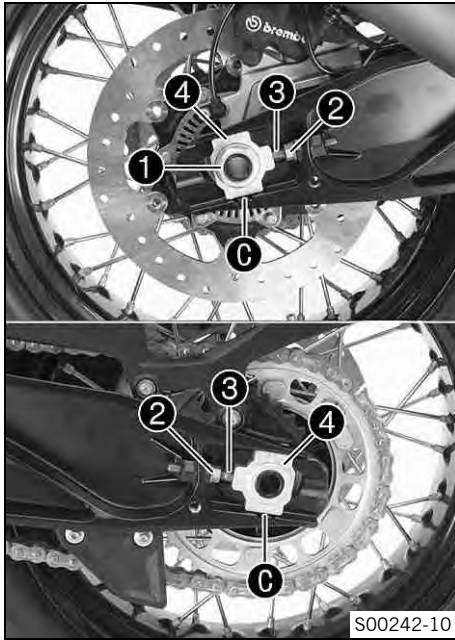

Main work

- Loosen nut ❶.
- Loosen nuts ❷.
- Adjust the chain tension by turning the adjusting screws ❸ on the left and right.

Guideline

| | |
|---|-------------------------------|
| Chain tension | 40... 45 mm (1.57... 1.77 in) |
| Turn adjusting screws ❸ on the left and right so that the markings on the left and right chain adjusters ❹ are in the same position in relation to reference marks ❷. The rear wheel is then correctly aligned. | |

i Info

The upper part of the chain must be taut.
Chain wear is not always even, so you should check the setting at different chain positions.

- Tighten nuts ❷.
- Make sure that chain adjusters ❹ are resting against adjusting screws ❸.
- Tighten nut ❶.

Guideline

| | | | |
|-------------------------|---------|------------------------|----------------|
| Nut, rear wheel spindle | M25x1.5 | 90 Nm (66.4 lbf ft) | Thread greased |
|-------------------------|---------|------------------------|----------------|

i Info

Chain adjusters ❹ can be turned through 180°.

13.11 Checking the chain, rear sprocket and engine sprocket

Preparatory work

(Option: Center stand)

- Raise the vehicle with the center stand. (🔧 p. 98)

Main work

- Check the rear sprocket and engine sprocket for wear.
 - » If the rear sprocket or engine sprocket is worn:
 - Change the power set. 🛠️

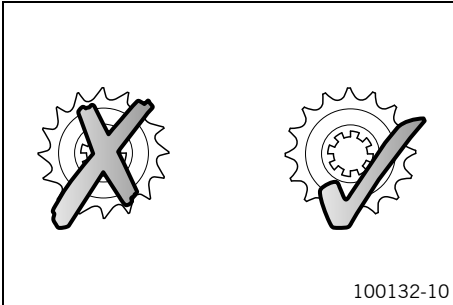

Info

The rear sprocket, engine sprocket and chain should always be changed together.

13 SERVICE WORK ON THE CHASSIS

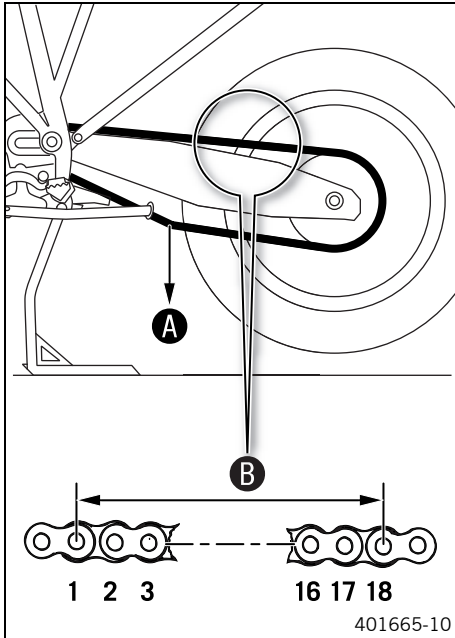

- Shift the transmission to idle **N**.
- Pull the lower chain section with specified weight **A**.

Guideline

| | |
|--------------------------------|----------------|
| Weight, chain wear measurement | 15 kg (33 lb.) |
|--------------------------------|----------------|

- Measure the distance **B** of 18 chain links in the lower chain section.

i Info
Chain wear is not always even, so you should repeat this measurement at different chain positions.

| | |
|--|-------------------|
| Maximum distance B at the longest chain section | 272 mm (10.71 in) |
|--|-------------------|

- » If distance **B** is greater than the specified measurement:
 - Change the power set.

i Info
When the chain is replaced, the rear sprocket and engine sprocket should also be changed.
New chains wear out faster on old, worn sprockets.
For safety reasons, the chain has no chain joint.

13 SERVICE WORK ON THE CHASSIS

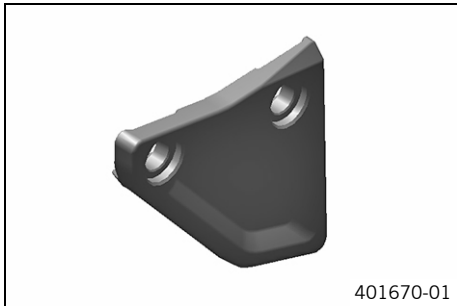
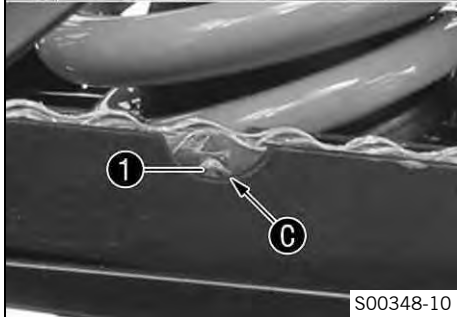
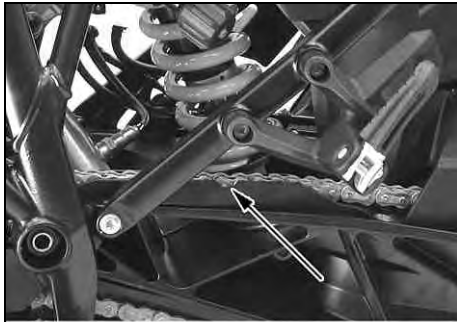

- Check the chain sliding guard for wear at the cutout.
 - » If rivet 1 of the chain is no longer visible at the lower edge C of the recess of the chain sliding guard:
 - Change the chain sliding guard. 🛠️
- Check the chain sliding guard for tightness.
 - » If the chain sliding guard is loose:
 - Tighten the chain sliding guard.

Guideline

| | | |
|----------------------------|----|-------------------|
| Screw, chain sliding guard | M5 | 5 Nm (3.7 lbf ft) |
|----------------------------|----|-------------------|

- Check the chain guide for wear.
 - » If the chain guide is worn:
 - Change the chain guide. 🛠️
- Check the chain guide for tightness.
 - » If the chain guide is loose:
 - Tighten the chain guide.

Guideline

| | | | |
|--------------------|----|----------------------|---------------|
| Screw, chain guide | M6 | 5 Nm (3.7 lbf ft) | Loctite® 243™ |
|--------------------|----|----------------------|---------------|

Finishing work

(Option: Center stand)

- Remove the vehicle from the center stand. (☛ p. 98)

13.12 Checking/rectifying the fluid level of the hydraulic clutch



Info

The fluid level rises with increasing wear of the clutch lining disc.
Do not use brake fluid.

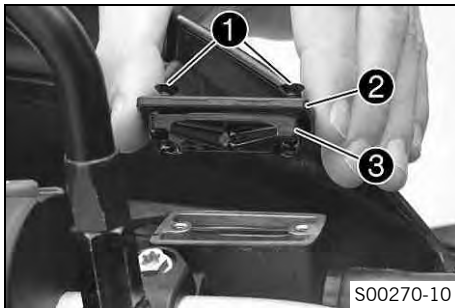

- Move the clutch fluid reservoir mounted on the handlebar to a horizontal position.
- Remove screws ①.
- Remove cover ② with membrane ③.
- Check the fluid level.

| | |
|---|----------------|
| Fluid level below top edge of container | 4 mm (0.16 in) |
|---|----------------|

- » If the coolant level does not meet specifications:
 - Correct the fluid level of the hydraulic clutch.

| |
|---------------------------------|
| Hydraulic fluid (15) (☛ p. 207) |
|---------------------------------|

- Position the cover with the membrane. Mount and tighten the screws.

13.13 Checking the steering head bearing play

- Warning**
Danger of accidents Unstable vehicle handling from incorrect steering head bearing play.
- Adjust the steering head bearing play without delay. (Your authorized KTM workshop will be glad to help.)

- Info**
If the vehicle is operated for a lengthy period with play in the steering head bearing, the bearings and the bearing seats in the frame can become damaged over time.

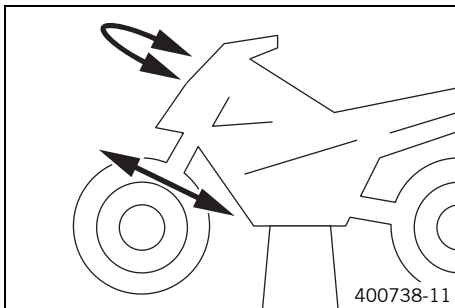

Preparatory work (Option: Center stand)

- Raise the vehicle with the center stand. (☛ p. 98)

Main work

- Place a load on the rear of the vehicle.
 - ✓ The front wheel is not in contact with the ground.
- Move the handlebar to the straight-ahead position. Move the fork legs back and forth in the direction of travel.

Play should not be detectable on the steering head bearing.

- » If there is no detectable play:
 - Adjust the steering head bearing play. ☛
- Move the handlebar to and fro over the entire steering range.

It must be possible to move the handlebar easily over the entire steering range. There should be no detectable detent positions.

- » If detent positions are detected:
 - Adjust the steering head bearing play. ☛

- Check the steering head bearing and adjust if necessary.

13.14 Removing the bottom triple clamp cover

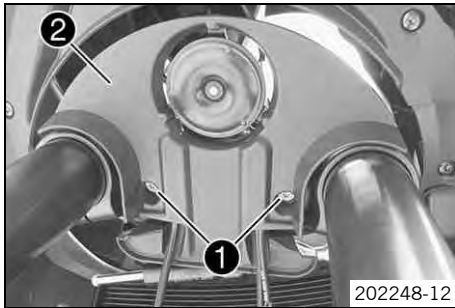

- Remove screws ❶.
- Plug out the horn.
- Remove the triple clamp cover ❷.

13.15 Installing the bottom triple clamp cover

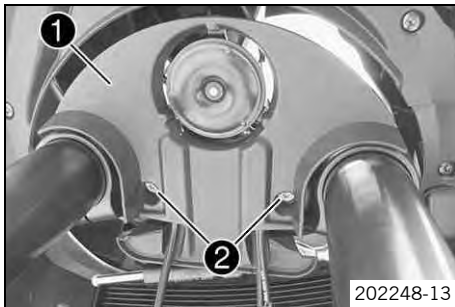

- Position the triple clamp cover ❶.
- Plug in the horn.
- Mount and tighten screws ❷.

Guideline

| | | |
|--------------------------|----|--------------------|
| Remaining chassis screws | M6 | 10 Nm (7.4 lbf ft) |
|--------------------------|----|--------------------|

13.16 Removing the front side cover

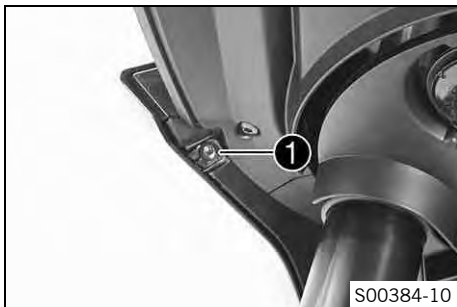

- Remove screw ❶.

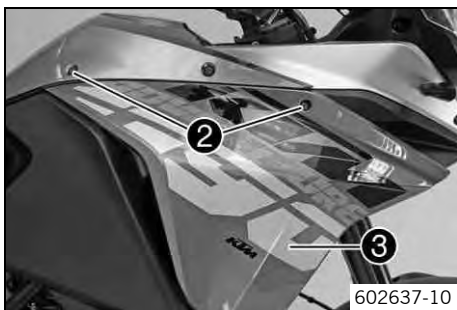

- Remove screws ❷.
- Remove side cover ❸.
- Repeat the operation on the opposite side.

13.17 Installing the front side cover

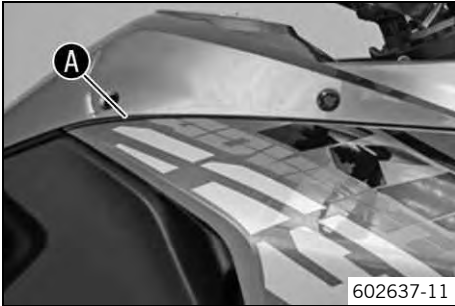

- Position the side cover in the **A** area under the tank cover.

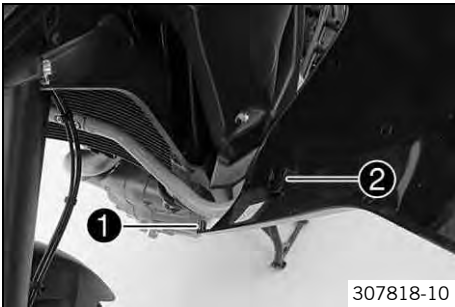

- Attach catch **1** and bracket **2** of the side cover to the fuel tank and position the side cover.

13 SERVICE WORK ON THE CHASSIS

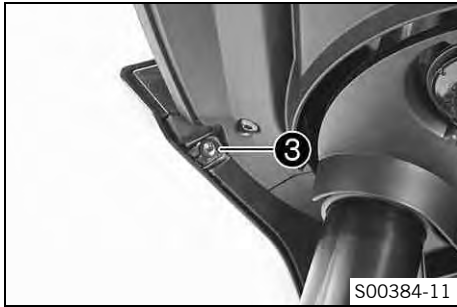

- Mount and tighten screw ③.

Guideline

| | | |
|-------------------|-------|-------------------------|
| Screw, cover part | M5x12 | 3.5 Nm (2.58 lbf ft) |
|-------------------|-------|-------------------------|

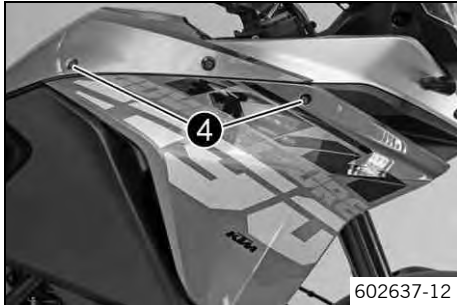

- Mount and tighten screws ④.

Guideline

| | | |
|-------------------|-------|-------------------------|
| Screw, cover part | M5x12 | 3.5 Nm (2.58 lbf ft) |
|-------------------|-------|-------------------------|

- Repeat the operation on the opposite side.

13.18 Removing the mask spoiler 🛠️

Preparatory work

- Remove the passenger seat. (👉 p. 99)
- Remove the driver's seat. (👉 p. 100)
- Remove the front side cover. (👉 p. 112)
- Remove the tank cover. (👉 p. 120)

13 SERVICE WORK ON THE CHASSIS



Main work

- Remove screw ❶.



- Remove screw ❷.



- Loosen holding lug ❸ from the inside cover.

13 SERVICE WORK ON THE CHASSIS

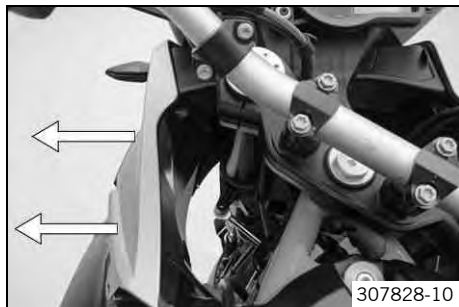

- Remove the mask spoiler laterally from the supports.

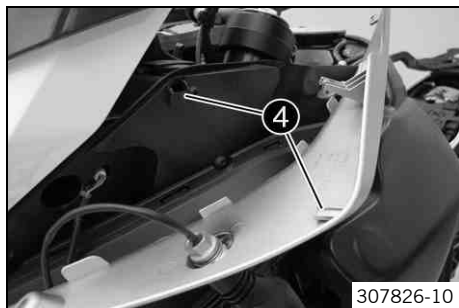

- Pull the mask spoiler upward from bracket ④.

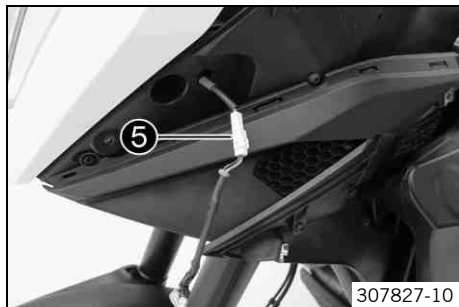

- Detach connector ⑤.
- Remove the mask spoiler with the turn signal.
- Repeat the operation on the opposite side.

13.19 Installing the mask spoiler

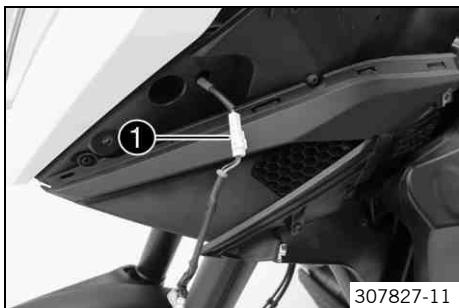

Main work

- Plug in connector ❶.

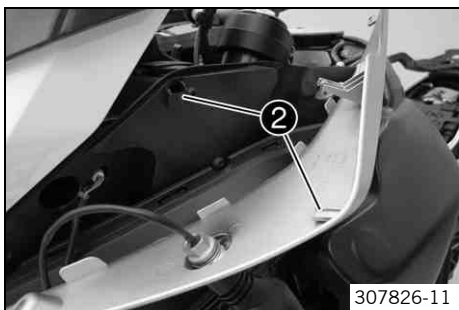

- Position the mask spoiler in bracket ❷.



Info

Ensure that the turn signal cable is placed correctly.

13 SERVICE WORK ON THE CHASSIS

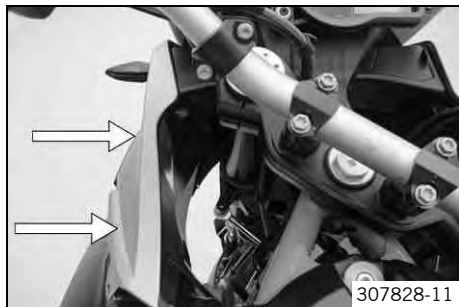

- Press the mask spoiler laterally into the supports.

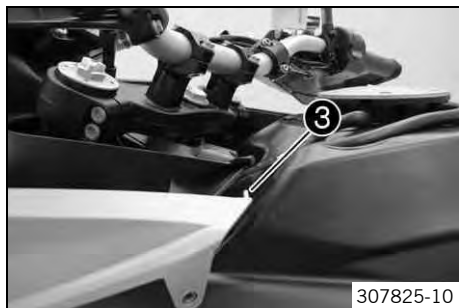

- Position holding lug ③ in the drill hole.



- Mount and tighten screw ④.

Guideline

| | | |
|---------------------|-------|-------------------------|
| Screw, mask spoiler | M5x17 | 3.5 Nm (2.58 lbf ft) |
|---------------------|-------|-------------------------|

13 SERVICE WORK ON THE CHASSIS

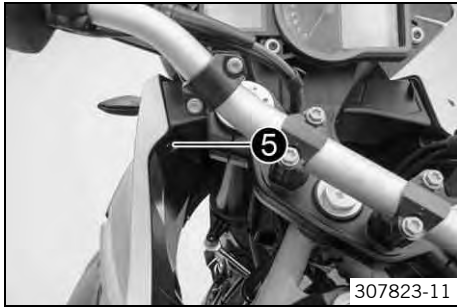

- Mount and tighten screw ⑤.

Guideline

| | | |
|---------------------|-------|-------------------------|
| Screw, mask spoiler | M5x17 | 3.5 Nm (2.58 lbf ft) |
|---------------------|-------|-------------------------|

- Repeat the operation on the opposite side.

Finishing work

- Install the tank cover. (☞ p. 122)
- Install the front side cover. (☞ p. 113)
- Mount the driver's seat. (☞ p. 101)
- Mount the passenger seat. (☞ p. 100)

13.20 Removing the front fender

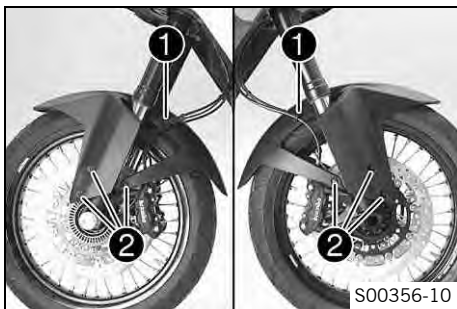

- Remove holder ① from the front fender.
- Remove screws ②.
- Remove the fender in a forward direction.



Info

Pay attention to the brake lines.

13.21 Installing the front fender

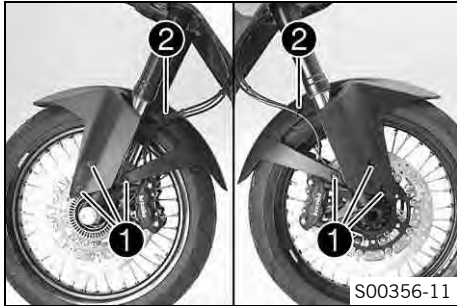

- Position the fender.



Info

Pay attention to where the brake lines are placed.

- Mount and tighten screws ①.

Guideline

| | | |
|---------------|-------|-------------------------|
| Screw, fender | M5x12 | 3.5 Nm (2.58 lbf ft) |
|---------------|-------|-------------------------|

- Mount holder ② with the brake line on the fender.

13.22 Removing the tank cover

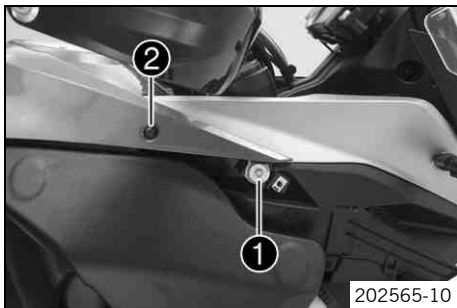

Preparatory work

- Remove the passenger seat. (☛ p. 99)
- Remove the driver's seat. (☛ p. 100)
- Remove the front side cover. (☛ p. 112)

Main work

- Remove screw ①.
- Remove screw ②.

13 SERVICE WORK ON THE CHASSIS

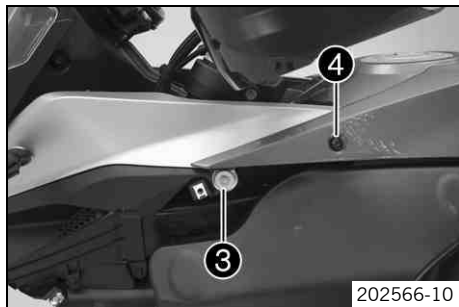

- Remove screw ③.
- Remove screw ④.

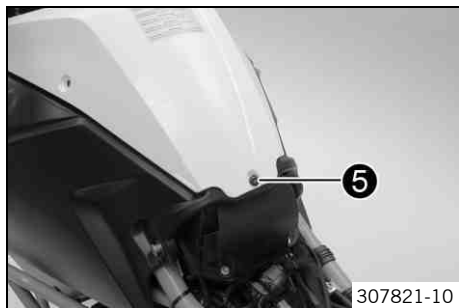

- Remove screw ⑤.



- Raise the tank cover at the rear and remove it in a forward direction.

13.23 Installing the tank cover

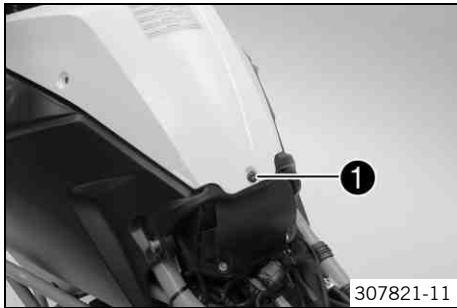

Main work

- Position the tank cover.



Info

Note the sealing lip.

- Mount and tighten screw ❶.

Guideline

| | | |
|-------------------|-------|-------------------------|
| Screw, cover part | M5x12 | 3.5 Nm (2.58 lbf ft) |
|-------------------|-------|-------------------------|

- Mount and tighten screw ❷.

Guideline

| | | |
|-------------------|----|-------------------|
| Screw, cover part | M6 | 6 Nm (4.4 lbf ft) |
|-------------------|----|-------------------|

- Mount and tighten screw ❸.

Guideline

| | | |
|-------------------|-------|-------------------------|
| Screw, cover part | M5x12 | 3.5 Nm (2.58 lbf ft) |
|-------------------|-------|-------------------------|

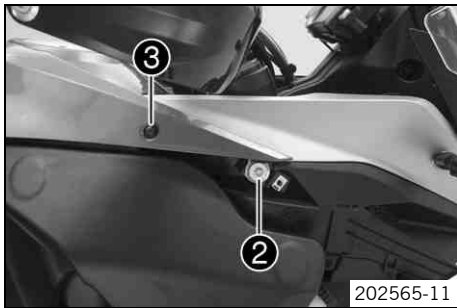

13 SERVICE WORK ON THE CHASSIS

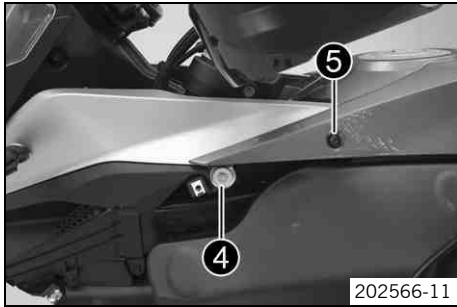

- Mount and tighten screw ④.

Guideline

| | | |
|-------------------|----|-------------------|
| Screw, cover part | M6 | 6 Nm (4.4 lbf ft) |
|-------------------|----|-------------------|

- Mount and tighten screw ⑤.

Guideline

| | | |
|-------------------|-------|-------------------------|
| Screw, cover part | M5x12 | 3.5 Nm (2.58 lbf ft) |
|-------------------|-------|-------------------------|

Finishing work

- Install the front side cover. (☛ p. 113)
- Mount the driver's seat. (☛ p. 101)
- Mount the passenger seat. (☛ p. 100)

13.24 Removing the wind shield

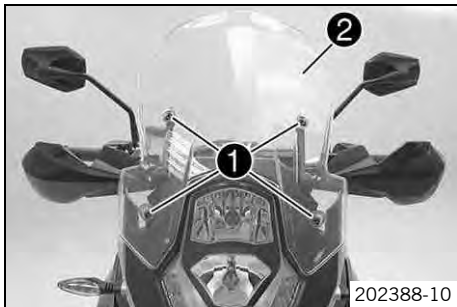

- Remove screws ① and wind shield ②.

13.25 Installing the wind shield

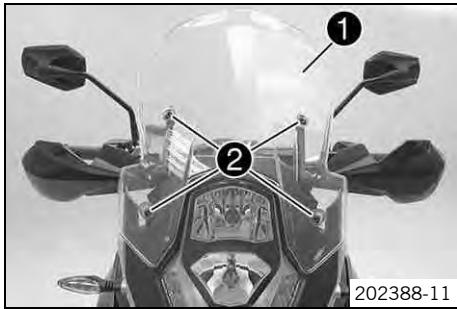

- Position wind shield ❶.
- Mount and tighten screws ❷.

Guideline

| | | |
|--------------------|----|-------------------------|
| Screw, wind shield | M5 | 3.5 Nm (2.58 lbf ft) |
|--------------------|----|-------------------------|

14.1 ABS/antilock brake system

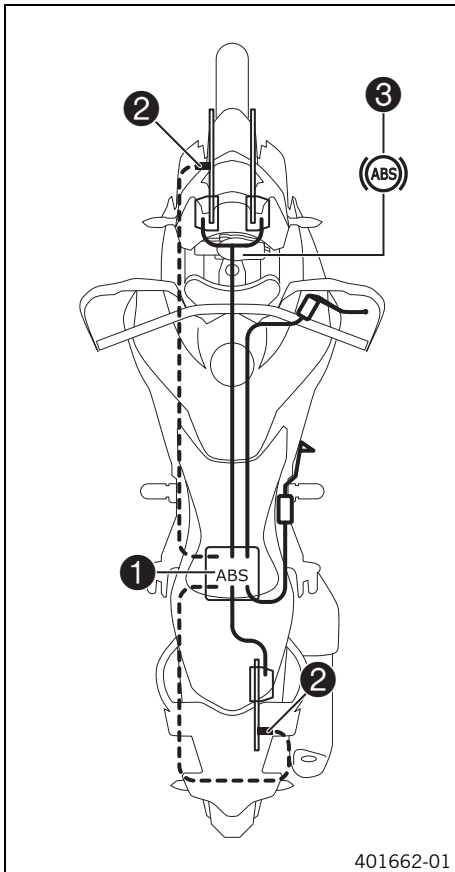

The ABS unit ❶, which consists of a hydraulic unit, ABS control unit, and return pump, is installed under the seat. A wheel speed sensor ❷ is located at the front and rear wheels.



Warning

Danger of accidents Functional limitations of the ABS

- The rear wheel may only be spun with the front brake applied (burn out) if the ABS is switched off.
- If the vehicle has been modified, such as shortened or lengthened spring deflections, different rim diameters, different tires, the wrong tire air pressure, different brake linings, etc., the ABS will not function optimally. Optimal functioning of the ABS is only ensured if the brake system only contains spare parts and tires that have been approved and/or recommended by KTM.
- Service work and repairs must be performed properly. (Your authorized KTM workshop will be glad to help.)

The ABS is a safety system that prevents locking of the wheels when driving straight ahead without the influence of lateral forces.



Warning

Danger of accidents Vehicle rollover

- It is not always possible to prevent vehicle rollover in extreme riding situations (e. g. luggage loaded with a high center of gravity, varying road surfaces, steep descents, full braking without disengaging the gear). Adapt your riding style to the road conditions and your riding ability.

ABS has two operating modes: the **"Road"** and **"Offroad"** ABS modes.

In the **"Road"** ABS mode, the brakes are also applied to the rear wheel when the front brake is applied. ABS can intervene on both wheels.

In the **"Offroad"** ABS mode, the front brake slows the front wheel. The rear brake slows the rear wheel. There is no ABS intervention on the rear wheel. The ABS lamp  flashes slowly to remind you that the **"Offroad"** ABS mode is enabled.



Info

In the **"Offroad"** ABS mode, the rear wheel may block and there is a risk of falling.

The ABS operates with two independent brake circuits (front and rear brakes). When the ABS control unit detects a locking tendency in a wheel, ABS begins regulating the brake pressure. The regulating process causes a slight pulsing of the hand and foot brake levers. ABS lamp  must light up after the ignition is switched on and go out after starting off. If it does not go out after starting off or if it is lit while riding, this indicates a fault in the ABS system. In this case, the ABS is no longer enabled and the wheels may lock during braking. The brake system itself stays functional; only ABS control is not available.

The ABS lamp may also light up if the rotating speeds of the front and rear wheels differ greatly under extreme riding conditions, for example when making wheelies or if the rear wheel spins. This causes the ABS to switch off.

To reenble the ABS, the vehicle must be stopped and the ignition switched off. The ABS is reenbled when the vehicle is switched on again. The ABS lamp goes out when you start off.

In the **"MTC/ABS"** menu, ABS can be switched off manually.



Info

After the ignition is switched back on, ABS is enabled again.

14.2 Checking the brake discs



Warning

Danger of accidents Reduced braking efficiency due to worn brake disc(s).

- Change the worn brake disc(s) without delay. (Your authorized KTM workshop will be glad to help.)

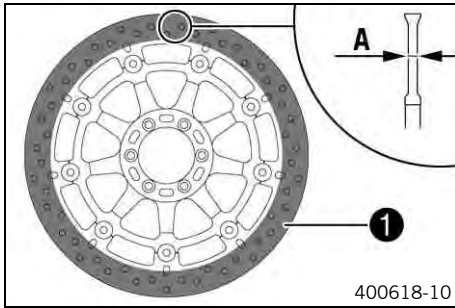

- Check the thickness of the front and rear brake discs at multiple points on each brake disc to ensure it is at least thickness **1**.



Info

Wear will reduce the thickness of the brake disc at the contact surface **1** of the brake linings.

| Brake discs - wear limit | |
|--------------------------|-------------------|
| Front | 4 mm (0.16 in) |
| Rear | 4.5 mm (0.177 in) |

- » If the brake disc thickness is less than the specified value.
 - Change the brake disc.
- Check the front and rear brake discs for damage, cracking, and deformation.
 - » If the brake disc exhibits damage, cracking, or deformation:
 - Change the brake disc.

14.3 Checking the brake fluid level of the front brake



Warning

Danger of accidents Failure of the brake system.

- If the brake fluid level falls below the **MIN** mark, this indicates a leakage in the brake system or worn-out brake linings. Check the brake system and do not continue riding. (Your authorized KTM workshop will be glad to help.)



Warning

Danger of accidents Reduced braking efficiency due to old brake fluid.

- Change the brake fluid of the front and rear brake according to the service schedule. (Your authorized KTM workshop will be glad to help.)

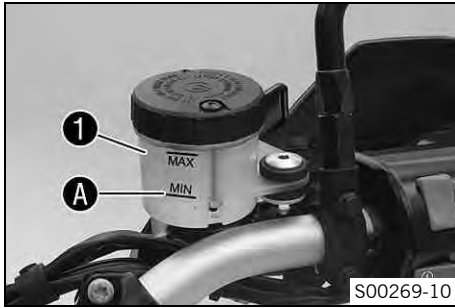

- Move the brake fluid reservoir mounted on the handlebar to a horizontal position.
- Check the brake fluid level in the brake fluid reservoir ①.
 - » If the brake fluid has dropped below marking **MIN** A:
 - Add front brake fluid. 🛠️ (📖 p. 128)

14.4 Adding front brake fluid 🛠️



Warning

Danger of accidents Failure of the brake system.

- If the brake fluid level falls below the **MIN** mark, this indicates a leakage in the brake system or worn-out brake linings. Check the brake system and do not continue riding. (Your authorized KTM workshop will be glad to help.)



Warning

Skin irritation Brake fluid can cause skin irritation on contact.

- Avoid contact with skin and eyes, and keep out of the reach of children.
- Wear suitable protective clothing and goggles.
- If brake fluid comes into contact with the eyes, flush the eyes thoroughly with water and consult a physician immediately.



Warning

Danger of accidents Reduced braking efficiency due to old brake fluid.

- Change the brake fluid of the front and rear brake according to the service schedule. (Your authorized KTM workshop will be glad to help.)



Warning

Environmental hazard Hazardous substances cause environmental damage.

- Oil, grease, filters, fuel, cleaners, brake fluid, etc., should be disposed of as stipulated in applicable regulations.



Info

Never use DOT 5 brake fluid! It is silicone-based and purple in color. Oil seals and brake lines are not designed for DOT 5 brake fluid.

Avoid contact between brake fluid and painted parts. Brake fluid attacks paint!

Use only clean brake fluid from a sealed container.

Preparatory work

- Check the front brake linings. (☛ p. 130)

Main work

- Move the brake fluid reservoir mounted on the handlebar to a horizontal position.
- Remove screws ❶.
- Remove cover ❷ with membrane ❸.
- Add brake fluid to the **MAX** mark ❹.

Brake fluid DOT 4 / DOT 5.1 (☛ p. 205)

- Position cover ❷ with membrane ❸.
- Mount and tighten screws ❶.



Info

Clean up overflowed or spilt brake fluid immediately with water.

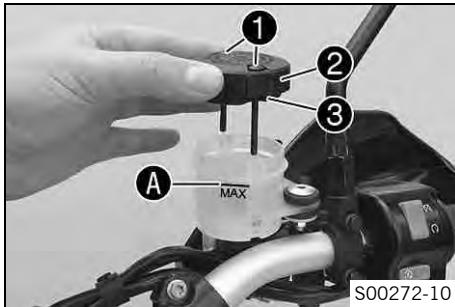

14.5 Checking the front brake linings



Warning

Danger of accidents Reduced braking efficiency caused by worn brake linings.

- Change worn brake linings immediately. (Your authorized KTM workshop will be glad to help.)

Note

Danger of accidents Reduced braking efficiency caused by damaged brake discs.

- If the brake linings are not changed in time, the steel brake lining carriers grind on the brake disc. The braking effect is greatly reduced and the brake discs are destroyed. Check the brake linings regularly.

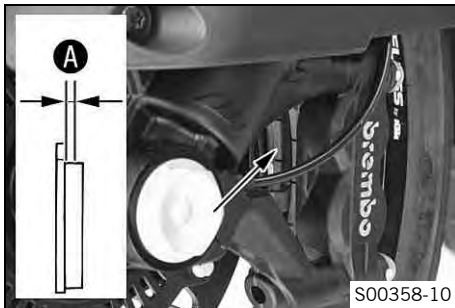

- Check all brake linings on both brake calipers to ensure they have minimum thickness **A**.

| | |
|-------------------|---|
| Minimum thickness | $\geq 1 \text{ mm } (\geq 0.04 \text{ in})$ |
|-------------------|---|

- » If the minimum thickness is less than specified:
 - Change the front brake linings. 🛠️
- Check all brake linings on both brake calipers for damage and cracking.
 - » If there is damage or cracking:
 - Change the front brake linings. 🛠️

14.6 Checking the rear brake fluid level



Warning

Danger of accidents Failure of the brake system.

- If the brake fluid level falls below the **MIN** mark, this indicates a leakage in the brake system or worn-out brake linings. Check the brake system and do not continue riding. (Your authorized KTM workshop will be glad to help.)



Warning

Danger of accidents Reduced braking efficiency due to old brake fluid.

- Change the brake fluid of the front and rear brake according to the service schedule. (Your authorized KTM workshop will be glad to help.)

Preparatory work

(Option: Center stand)

- Raise the vehicle with the center stand. (☞ p. 98)

Main work

- Check the brake fluid level in the brake fluid reservoir ❶.
 - » If the fluid level reaches the **MIN** marking ❷:
 - Add rear brake fluid. ☞ (☞ p. 131)

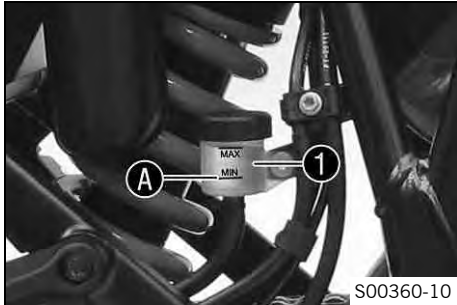

14.7 Adding rear brake fluid ☞



Warning

Danger of accidents Failure of the brake system.

- If the brake fluid level falls below the **MIN** mark, this indicates a leakage in the brake system or worn-out brake linings. Check the brake system and do not continue riding. (Your authorized KTM workshop will be glad to help.)



Warning

Skin irritation Brake fluid can cause skin irritation on contact.

- Avoid contact with skin and eyes, and keep out of the reach of children.
- Wear suitable protective clothing and goggles.
- If brake fluid comes into contact with the eyes, flush the eyes thoroughly with water and consult a physician immediately.



Warning

Danger of accidents Reduced braking efficiency due to old brake fluid.

- Change the brake fluid of the front and rear brake according to the service schedule. (Your authorized KTM workshop will be glad to help.)



Warning

Environmental hazard Hazardous substances cause environmental damage.

- Oil, grease, filters, fuel, cleaners, brake fluid, etc., should be disposed of as stipulated in applicable regulations.



Info

Never use DOT 5 brake fluid! It is silicone-based and purple in color. Oil seals and brake lines are not designed for DOT 5 brake fluid.

Avoid contact between brake fluid and painted parts. Brake fluid attacks paint!

Use only clean brake fluid from a sealed container.

Preparatory work

(Option: Center stand)

- Raise the vehicle with the center stand. (👉 p. 98)
- Check the rear brake linings. (👉 p. 133)

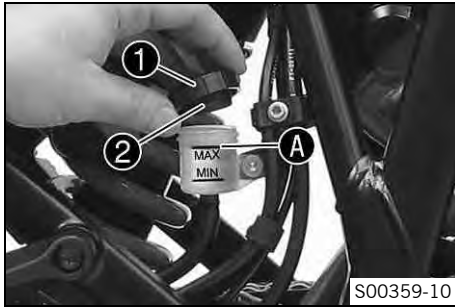

Main work

- Remove screw cap ❶ with membrane ❷.
- Add brake fluid to the **MAX** mark ❸.

Brake fluid DOT 4 / DOT 5.1 (☞ p. 205)

- Mount and tighten screw cap ❶ with membrane ❷.

Info

Clean up overflowed or spilt brake fluid immediately with water.

14.8 Checking the rear brake linings



Warning

Danger of accidents Reduced braking efficiency caused by worn brake linings.

- Change worn brake linings immediately. (Your authorized KTM workshop will be glad to help.)

Note

Danger of accidents Reduced braking efficiency caused by damaged brake discs.

- If the brake linings are not changed in time, the steel brake lining carriers grind on the brake disc. The braking effect is greatly reduced and the brake discs are destroyed. Check the brake linings regularly.

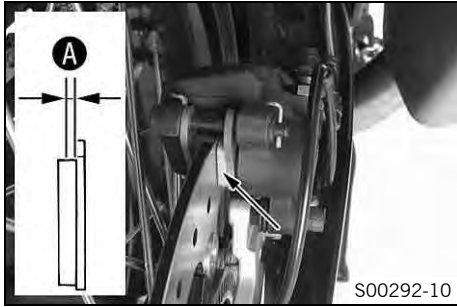

- Check the brake linings for minimum thickness **A**.

| | |
|----------------------------|---|
| Minimum thickness A | $\geq 1 \text{ mm } (\geq 0.04 \text{ in})$ |
|----------------------------|---|

- » If the minimum thickness is less than specified:
 - Change the rear brake linings. 🔧
- Check the brake linings for damage and cracking.
 - » If there is wear or tearing:
 - Change the rear brake linings. 🔧

15.1 Removing the front wheel 🛠️

Preparatory work

(Option: Center stand)

- Raise the vehicle with the center stand. (🔧 p. 98)

Main work

- Place a load on the rear of the vehicle.
 - ✓ The front wheel is not in contact with the ground.
- Remove screw ❶ and pull wheel speed sensor ❷ out of the hole.

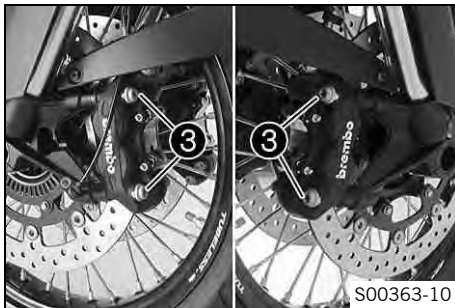
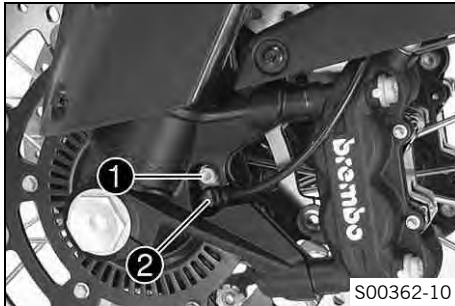

- Remove screws ❸ from both brake calipers.
- Press back the brake linings with a light lateral tilting of the brake calipers on the brake disc. Pull the brake calipers carefully back from the brake discs and hang them to one side.

i Info

Do not pull the hand brake lever when the brake caliper has been removed.

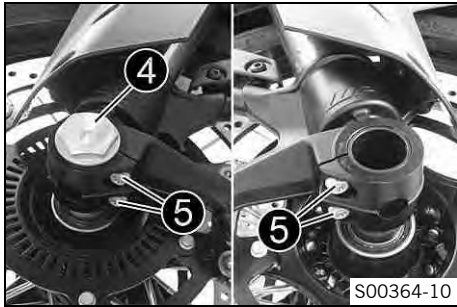

- Loosen screws ④ and ⑤.
- Unscrew screw ④ about six turns and press your hand on the screw to push the wheel spindle out of the axle clamp. Remove screw ④.



Warning

Danger of accidents Reduced braking efficiency due to damaged brake discs.

- Always lay down the wheel in such a way that the brake discs are not damaged.

- Holding the front wheel, withdraw the wheel spindle. Take the front wheel out of the fork.



Info

Do not pull the hand brake lever when the front wheel is removed.

- Remove spacers ⑥.

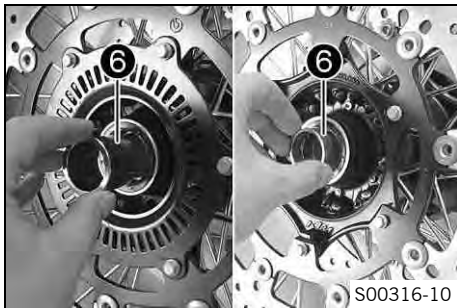

15.2 Installing the front wheel 🛠️



Warning

Danger of accidents Reduced braking efficiency due to oil or grease on the brake discs.

- Always keep the brake discs free of oil and grease, and clean them with brake cleaner when necessary.

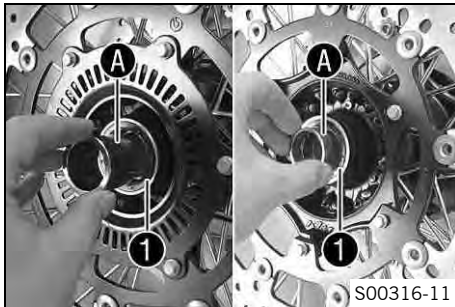

- Check the wheel bearing for damage and wear.
 - » If the wheel bearing is damaged or worn:
 - Change the wheel bearing. 🛠️
- Clean and grease the shaft seal rings ❶ and contact surface ❸ of the spacers.

Long-life grease (🛠️ p. 210)

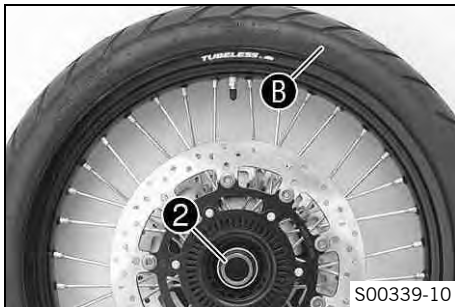

- Insert the wide spacer ❷ on the left in the direction of travel.

i Info

The arrow ❸ indicates the direction of travel of the front wheel.

The ABS sensor wheel is on the left-hand side when looking in the direction of travel.

- Insert the narrow spacer on the right in the direction of travel.

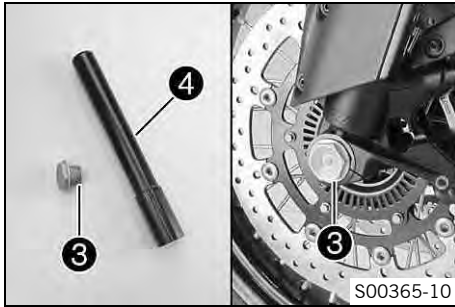

Warning

Danger of accidents Reduced braking efficiency due to oil or grease on the brake discs.

- Always keep the brake discs free of oil and grease, and clean them with brake cleaner when necessary.

- Clean screw ③ and wheel spindle ④.
- Lift the front wheel into the fork, position it, and insert the wheel spindle.
- Mount and tighten screw ③.

Guideline

| | | |
|----------------------------|---------|------------------------|
| Screw, front wheel spindle | M25x1.5 | 45 Nm (33.2 lbf ft) |
|----------------------------|---------|------------------------|

- Position the brake calipers and check that the brake linings are seated correctly.
- Mount screws ⑤ on both brake calipers but do not tighten yet.
- Operate the hand brake lever repeatedly until the brake linings are in contact with the brake disc and there is a pressure point. Fix the hand brake lever in the activated position.

✓ The brake calipers straighten.

- Tighten screws ⑤ on both brake calipers.

Guideline

| | | | |
|----------------------------|-----|------------------------|----------------------|
| Screw, front brake caliper | M10 | 45 Nm (33.2 lbf ft) | Loctite® 243™ |
|----------------------------|-----|------------------------|----------------------|

- Remove the fixation of the hand brake lever.

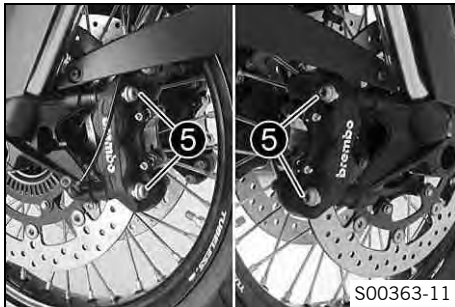

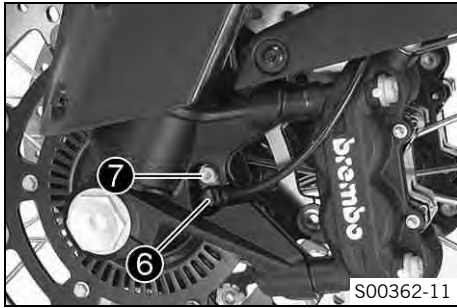

- Insert wheel speed sensor ⑥ into the hole and position it.
- Mount and tighten screw ⑦.

Guideline

| | | |
|--------------------------|----|--------------------|
| Remaining chassis screws | M6 | 10 Nm (7.4 lbf ft) |
|--------------------------|----|--------------------|

(Option: Center stand)

- Remove the vehicle from the center stand. (🔧 p. 98)

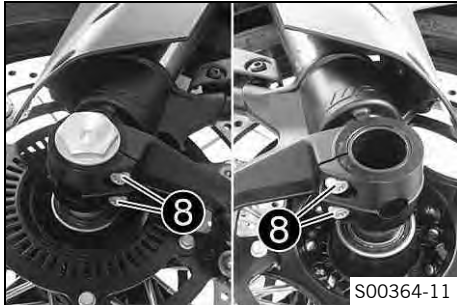

- Pull the front brake and compress the fork forcefully a few times.
✓ The fork legs straighten.
- Tighten screws ⑧.

Guideline

| | | |
|------------------|----|------------------------|
| Screw, fork stub | M8 | 15 Nm (11.1 lbf ft) |
|------------------|----|------------------------|

15.3 Removing the rear wheel 🛠️

Preparatory work

(Option: Center stand)

- Raise the vehicle with the center stand. (🔧 p. 98)

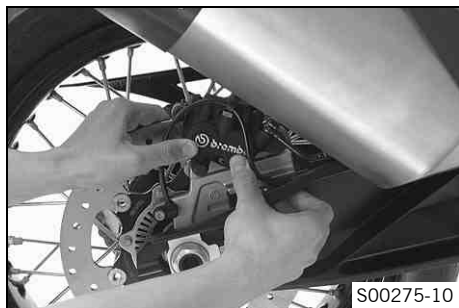

Main work

- Press the brake caliper by hand on to the brake disc in order to press back the brake pistons.

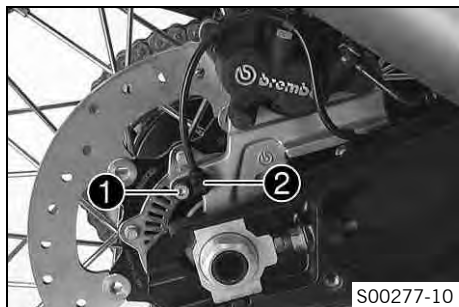

- Remove screw ❶ and pull wheel speed sensor ❷ out of the hole.

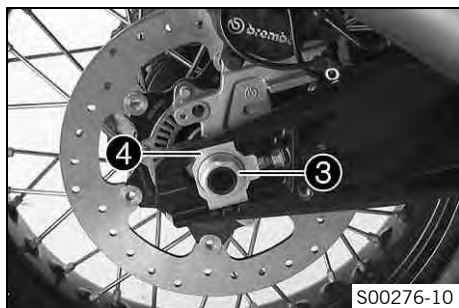

- Remove nut ❸. Remove chain adjuster ❹.

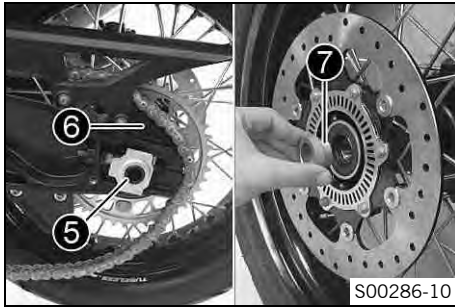

- Pull out wheel spindle ⑤ only far enough to allow the rear wheel to be pushed forward.
- Push the rear wheel forward as far as possible. Take the chain off of the rear sprocket and place it on chain sprocket guard ⑥.



Warning

Danger of accidents Reduced braking effect caused by damaged brake discs.

- Always lay the wheel down in such a way that the brake discs are not damaged.

- Holding the rear wheel, withdraw the wheel spindle. Take the rear wheel out of the swing arm.



Info

Do not operate the foot brake when the rear wheel is removed.

- Remove the spacer ⑦.

15.4 Installing the rear wheel 🛠️



Warning

Danger of accidents Reduced braking efficiency due to oil or grease on the brake discs.

- Always keep the brake discs free of oil and grease, and clean them with brake cleaner when necessary.



Warning

Danger of accidents No braking effect when operating the rear brake.

- After installing the rear wheel, always operate the foot brake until the pressure point is reached.

- Check the rear hub rubber dampers. 🛠️ (👉 p. 143)

15 WHEELS, TIRES

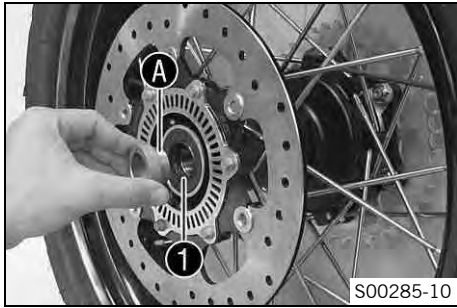

- Check the wheel bearing for damage and wear.
 - » If the wheel bearing is damaged or worn:
 - Change the wheel bearing. 🛠️
- Clean and grease shaft seal ring ❶ and contact surface ❸ of the spacer.

Long-life grease (🛠️ p. 210)

- Clean and grease the thread of the wheel spindle and nut.

Long-life grease (🛠️ p. 210)

- Mount the rubber dampers and rear sprocket carrier in the rear wheel.
- Place the rear wheel in the swingarm and bring the brake disc on the brake caliper into contact.
- Mount wheel spindle ❷ but do not push it in all the way.
- Push the rear wheel as far forward as possible and place the chain on the rear sprocket.

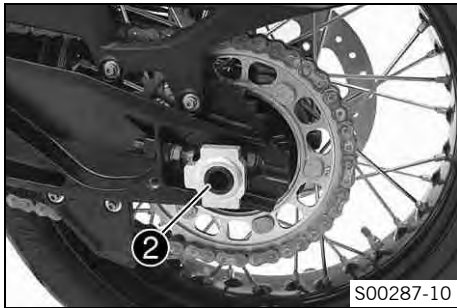

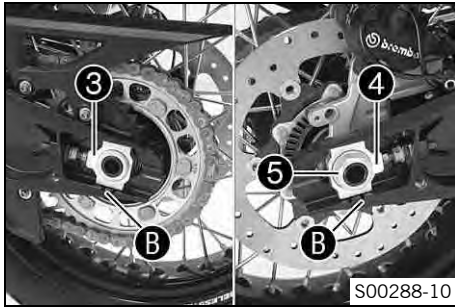

S00288-10

- Push the wheel spindle in all the way and mount chain adjuster ④ and nut ⑤.



Info

Mount chain adjusters ③ and ④ in the same position.

- Push the rear wheel forward so that the chain adjusters are in contact with the tensioning screws, and tighten nut ⑤.

Guideline

In order for the rear wheel to be correctly aligned, the markings on the left and right chain adjusters must be in the same position relative to the reference marks ②.

| | | | |
|-------------------------|---------|------------------------|----------------|
| Nut, rear wheel spindle | M25x1.5 | 90 Nm (66.4 lbf ft) | Thread greased |
|-------------------------|---------|------------------------|----------------|

- Insert wheel speed sensor ⑥ into the hole. Mount and tighten screw ⑦.

Guideline

| | | |
|--------------------------|----|--------------------|
| Remaining chassis screws | M6 | 10 Nm (7.4 lbf ft) |
|--------------------------|----|--------------------|

- Operate the foot brake lever repeatedly until the brake linings are in contact with the brake disc and there is a pressure point.

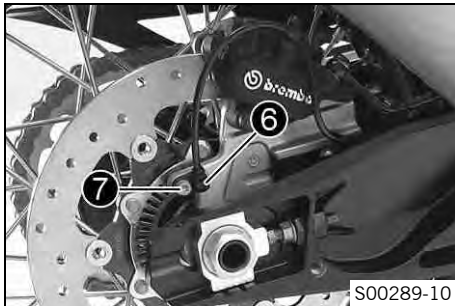

S00289-10

15.5 Checking the rear hub rubber dampers 🛠️



Info

The engine power is transmitted from the rear sprocket to the rear wheel via 6 rubber dampers. The rubber dampers wear out during operation. If the rubber dampers are not changed in time, the rear sprocket carrier and the rear hub will be damaged.

Preparatory work

(Option: Center stand)

- Raise the vehicle with the center stand. (☞ p. 98)
- Remove the rear wheel. ☞ (☞ p. 139)

Main work

- Check the rubber dampers ❶ of the rear hub for damage and wear.
 - » If the rubber dampers of the rear hub are damaged or worn:
 - Change all rubber dampers in the rear hub.

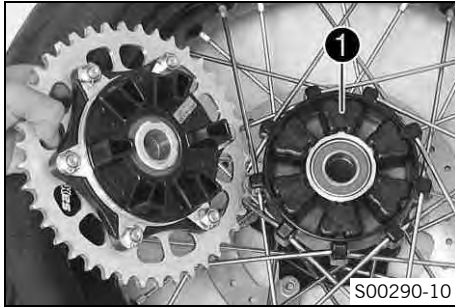

- Lay the rear wheel on a workbench with the rear sprocket facing upwards and insert the wheel spindle in the hub.
- Check the rear sprocket play A.



Info

Measure the play on the outside of the rear sprocket.

| | |
|------------------------------------|-------------------|
| Play in rubber dampers, rear wheel | ≤ 5 mm (≤ 0.2 in) |
|------------------------------------|-------------------|

- » If clearance A larger than the specified value:
 - Change all rubber dampers in the rear hub.

Finishing work

- Install the rear wheel. ☞ (☞ p. 141)

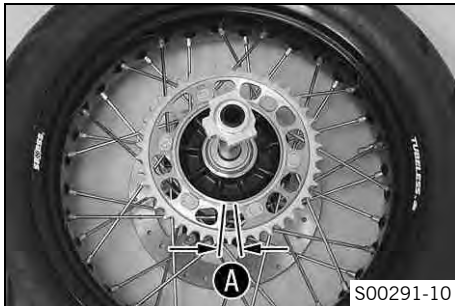

15.6 Checking the tire condition



Warning

Danger of accidents Uncontrollable vehicle handling in the event of a flat tire.

- In the interest of safety, replace damaged or worn tires immediately. (Your authorized KTM workshop will be glad to help.)



Warning

Danger of crashing Poor vehicle handling due to different tire tread patterns on front and rear wheels.

- The front and rear wheels must be fitted with tires with similar tread patterns to prevent loss of control over the vehicle.



Warning

Danger of accidents Uncontrollable handling characteristic due to non-approved and/or non-recommended tires/wheels.

- Only tires/wheels approved by KTM and with the corresponding speed index should be used.



Warning

Danger of accidents Reduced road grip with new tires.

- New tires have a smooth rolling surface and therefore cannot provide full road grip. The entire rolling surface must be roughened in the first 200 kilometers (124.3 miles) by moderate riding at alternating angles. The full grip levels are not achieved until the tires have been run in.



Info

The type, condition and air pressure of the tires all have an impact on the braking and riding response of the vehicle. Worn tires have a negative effect on vehicle handling, especially on wet surfaces.

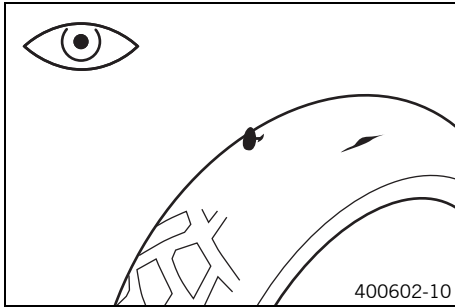

- Check the front and rear tires for cuts, run-in objects and other damage.
 - » If the tires exhibit cuts, run-in objects or other damage:
 - Change the tires.
- Check the depth of the tread.

i **Info**

Note local national regulations concerning the minimum tread depth.

| | |
|---------------------|---|
| Minimum tread depth | $\geq 2 \text{ mm } (\geq 0.08 \text{ in})$ |
|---------------------|---|

- » If the tread depth is less than the minimum permissible depth:
 - Change the tires.
- Check the age of the tires.

i **Info**

The tire's date of manufacture is usually part of the tire markings and is indicated by the last four digits of the **DOT** marking. The first two digits refer to the week of manufacture and last two digits refer to the year of manufacture. KTM recommends that the tires be changed after 5 years at the latest, regardless of the actual state of wear.

-
- » If a tire is more than five years old:
 - Change the tires.

15.7 Checking the tire air pressure

i **Info**

Low tire air pressure leads to abnormal wear and overheating of the tire. Correct tire air pressure ensures optimal riding comfort and maximum tire service life.

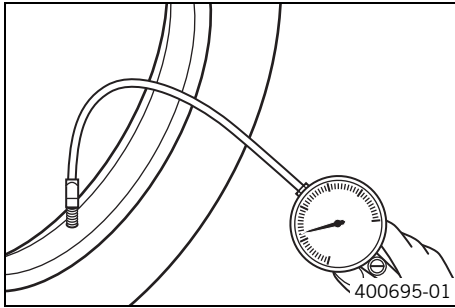

- Remove the dust cap.
- Check the tire air pressure when the tires are cold.

| Tire air pressure, solo/with passenger/full payload | |
|---|------------------|
| Front: with cold tires | 2.4 bar (35 psi) |
| Rear: with cold tires | 2.9 bar (42 psi) |

- » If the tire pressure does not meet specifications:
 - Correct the tire pressure.
- Mount the dust cap.

15.8 Checking spoke tension



Warning

Danger of accidents Instable handling due to incorrect spoke tension.

- Ensure that the spoke tension is correct. (Your authorized KTM workshop will be glad to help.)



Info

A loose spoke can easily cause lateral or radial runout on the wheel. More spokes loosen in a short period. If the spokes are too tight, they can break due to local overload. Check the spoke tension regularly, especially on a new motorcycle.

15 WHEELS, TIRES

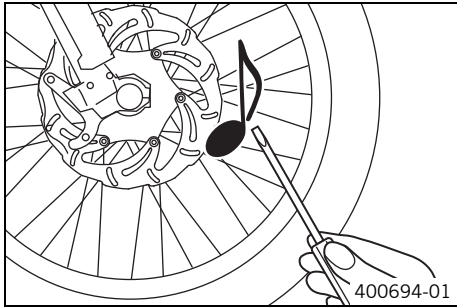

- Strike each spoke briefly using a screwdriver blade.



Info

The frequency of the sound is a function of the spoke length and spoke diameter.

If spokes of the same length and diameter vibrate with a different tone, this is an indication that the spoke tensions differ.

You should hear a high note.

- » If the spoke tension differs:
 - Correct the spoke tension. 🛠️

16.1 daytime running light



The daytime running light/parking light is integrated in the main headlight. The daytime running light can be switched on when visibility conditions are good. Activate the daytime running light in the combination instrument. Control is provided by the brightness sensor in the combination instrument. When visibility conditions are good, the low beam is switched off and the daytime running light is switched on. It is four times brighter than the parking light. When the daytime running light is switched off, it serves as a parking light.



Info

Note the legal regulations regarding the daytime running light.

16.2 Removing the battery 🔧



Warning

Risk of injury Battery acid and battery gases cause serious chemical burns.

- Keep batteries out of the reach of children.
- Wear suitable protective clothing and goggles.
- Avoid contact with battery acid and battery gases.
- Keep sparks and open flames away from the battery. Only charge in well-ventilated rooms.
- In the event of skin contact, rinse with large amounts of water. If battery acid gets in the eyes, rinse with water for at least 15 minutes and contact a physician.



Caution

Danger of accidents If the vehicle is operated with a discharged battery or without a battery, electronic components and safety equipment may be damaged.

- Never operate the vehicle with a discharged battery or without a battery.

Preparatory work

- Switch off all power consumers and switch off the engine.
- Remove the passenger seat. (☛ p. 99)
- Remove the driver's seat. (☛ p. 100)

Main work

- Pull locking mechanism ① in the direction of the arrow.
- Fold open cover ②.

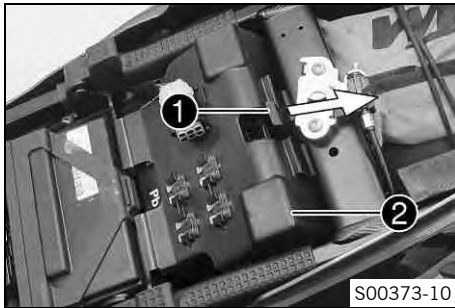

- Disconnect negative cable ③ of the battery.
- Disconnect the positive cable ④ of the battery.
- Take the battery and battery case ⑤ out of the battery compartment.

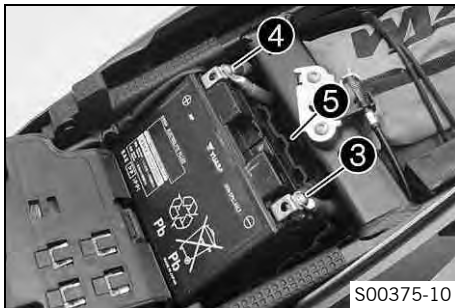

16.3 Installing the battery



Warning

Risk of injury Battery acid and battery gases cause serious chemical burns.

- Keep batteries out of the reach of children.
- Wear suitable protective clothing and goggles.
- Avoid contact with battery acid and battery gases.
- Keep sparks and open flames away from the battery. Only charge in well-ventilated rooms.
- In the event of skin contact, rinse with large amounts of water. If battery acid gets in the eyes, rinse with water for at least 15 minutes and contact a physician.



Caution

Danger of accidents If the vehicle is operated with a discharged battery or without a battery, electronic components and safety equipment may be damaged.

- Never operate the vehicle with a discharged battery or without a battery.



Main work

- Insert the battery into battery case **1**.



Info

The even side of the battery case must be opposite the poles.

- Insert the battery and battery case into the battery compartment.
- Connect both positive cables **2**.

Guideline

| | | |
|-------------------------|----|-------------------------|
| Screw, battery terminal | M6 | 4.5 Nm (3.32 lbf ft) |
|-------------------------|----|-------------------------|

- Connect both negative cables ③.

Guideline

| | | |
|-------------------------|----|-------------------------|
| Screw, battery terminal | M6 | 4.5 Nm (3.32 lbf ft) |
|-------------------------|----|-------------------------|

- Fold down cover ④ and let it lock by pushing down lightly.

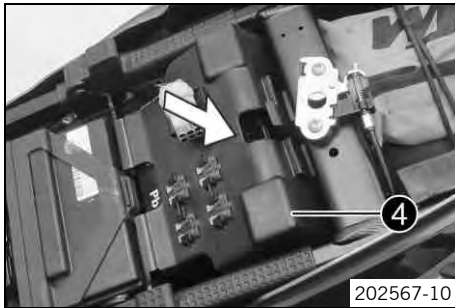

Finishing work

- Mount the driver's seat. (☛ p. 101)
- Mount the passenger seat. (☛ p. 100)
- Set the time and date.

16.4 Recharging the battery



Warning

Risk of injury Battery acid and battery gases cause serious chemical burns.

- Keep batteries out of the reach of children.
- Wear suitable protective clothing and goggles.
- Avoid contact with battery acid and battery gases.
- Keep sparks and open flames away from the battery. Only charge in well-ventilated rooms.
- In the event of skin contact, rinse with large amounts of water. If battery acid gets in the eyes, rinse with water for at least 15 minutes and contact a physician.



Warning

Environmental hazard The battery contains elements that are harmful to the environment.

- Do not discard batteries with the household waste. Dispose of faulty batteries in an environmentally compatible manner. Give the battery to your authorized KTM dealer or dispose of it at a collection point for used batteries.



Warning

Environmental hazard Hazardous substances cause environmental damage.

- Oil, grease, filters, fuel, cleaners, brake fluid, etc., should be disposed of as stipulated in applicable regulations.
-

i Info

Even when there is no load on the battery, it discharges steadily.

The charge state and the type of charge are very important for the service life of the battery.

Rapid recharging with a high charging current shortens the battery's service life.

If the charging current, charging voltage, and charging time are exceeded, electrolyte escapes through the safety valves. This reduces the battery capacity.

If the battery is depleted from starting the vehicle repeatedly, the battery must be charged immediately.

If the battery is left in a discharged state for an extended period, it will become over-discharged and sulfate, destroying the battery.

The battery is maintenance-free, i.e., the acid level does not have to be checked.

If the battery is not charged using the KTM battery charger, the battery must be removed for charging. Otherwise, overvoltage may damage electronic components. Charge the battery according to the instructions on the battery housing.

Preparatory work

- Switch off all power consumers and switch off the engine.
- Remove the passenger seat. (☛ p. 99)
- Remove the driver's seat. (☛ p. 100)

Main work

- Pull locking mechanism **1** in the direction of the arrow.
- Fold open cover **2**.

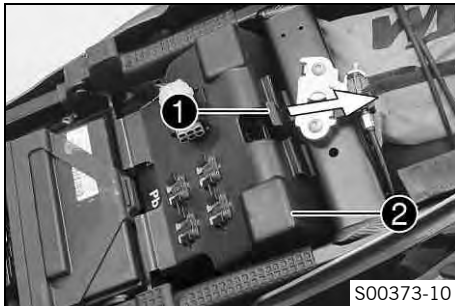



602677-11

- Disconnect the negative cable ③ of the battery to avoid damage to the motorcycle's electronics.



602678-01

- Connect the battery charger to the battery. Switch on the battery charger.

| |
|-------------------------------|
| Battery charger (58429074000) |
|-------------------------------|

You can also use the battery charger to test the open-circuit voltage and start potential of the battery, and to test the alternator. With this device, you cannot overcharge the battery.



Info

Charge the battery with a maximum of 10% of the capacity specified on the battery housing.

- Switch off and disconnect the battery charger after charging.

Guideline

| | |
|---|----------|
| The charging current, charging voltage, and charging time must not be exceeded. | |
| Charge the battery regularly when the motorcycle is not in use | 3 months |



- Connect both negative cables ③.

Guideline

| | | |
|-------------------------|----|-------------------------|
| Screw, battery terminal | M6 | 4.5 Nm (3.32 lbf ft) |
|-------------------------|----|-------------------------|

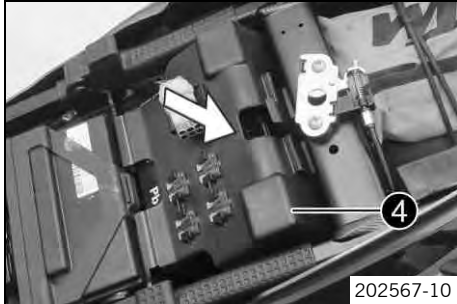

- Fold down cover ④ and let it lock by pushing down lightly.

Finishing work

- Mount the driver's seat. (☛ p. 101)
- Mount the passenger seat. (☛ p. 100)
- Set the time and date.

16.5 Changing the main fuse



Warning

Fire hazard The electrical system can be overloaded if the wrong fuses are used.

- Use only fuses with the prescribed amperage. Never by-pass or repair fuses.

Preparatory work

- Switch off all power consumers and switch off the engine.
- Remove the passenger seat. (☛ p. 99)
- Remove the driver's seat. (☛ p. 100)

Main work

- Remove screws ❶.
- Raise rear fairing ❷ slightly.

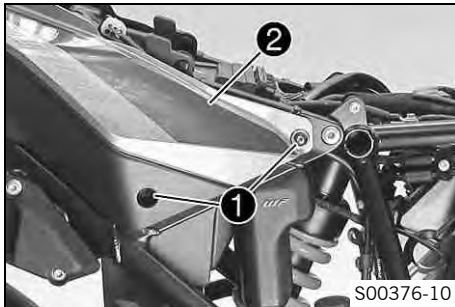

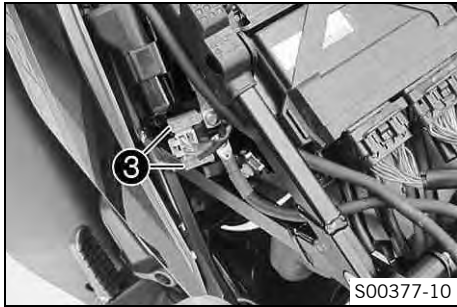

- Remove protection caps ③.

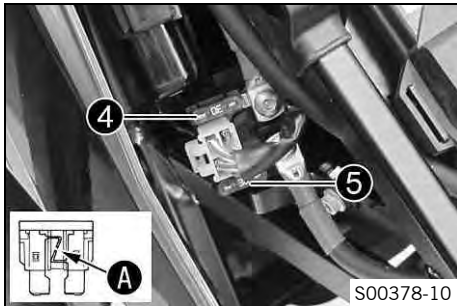

- Remove the faulty main fuse ④.



Info

A defective fuse is indicated by a burned-out fuse wire **A**.
A reserve fuse ⑤ is located in the starter relay.
The main fuse protects all power consumers of the vehicle.

- Install a new main fuse.

Fuse (58011109130) (☞ p. 197)

- Check that the electrical equipment is functioning properly.
- Mount protection covers.



Tip

Insert a new spare fuse into the starter relay to have it available when needed.

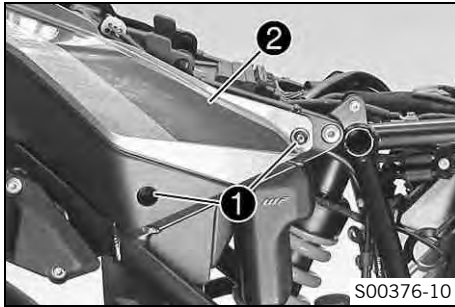

- Position rear fairing ②.
- Mount and tighten screws ①.

Guideline

| | | |
|-------------------|-------|-------------------------|
| Screw, cover part | M5x12 | 3.5 Nm (2.58 lbf ft) |
|-------------------|-------|-------------------------|

Finishing work

- Mount the driver's seat. (☛ p. 101)
- Mount the passenger seat. (☛ p. 100)
- Set the time and date.

16.6 Changing the fuses in the fuse box



Warning

Fire hazard The electrical system can be overloaded if the wrong fuses are used.

- Use only fuses with the prescribed amperage. Never by-pass or repair fuses.



Info

The fuse box containing the fuses of individual power consumers is located under the seat.

Preparatory work

- Switch off all power consumers and switch off the engine.
- Remove the passenger seat. (☛ p. 99)

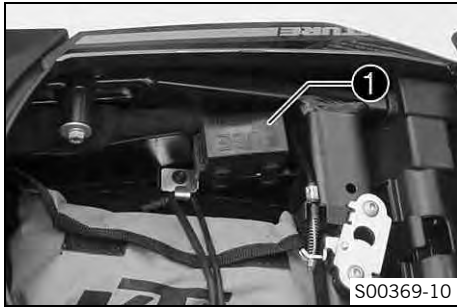

Main work

- Open fuse box cover ❶.



(Option: Without EDS)

- Check the fuses.

i Info

A defective fuse is indicated by a burned-out fuse wire ❸.

- Remove the defective fuse.

Guideline

| |
|--|
| Fuse res - 10 A - spare fuses |
| Fuse 1 - 10 A - power supply for control units and components |
| Fuse 2 - 10 A - socket (ACC1) |
| Fuse 3 - 25 A - ABS hydraulic unit |
| Fuse 4 - 40 A - ABS return pump |
| Fuse 5 - not used |

- Use spare fuses with the correct rating only.

| |
|-------------------------------|
| Fuse (58011109110) (☛ p. 197) |
| Fuse (58011109125) (☛ p. 197) |

Fuse (58011109140) (☛ p. 197)



Tip

Insert a spare fuse so that it is available if needed.

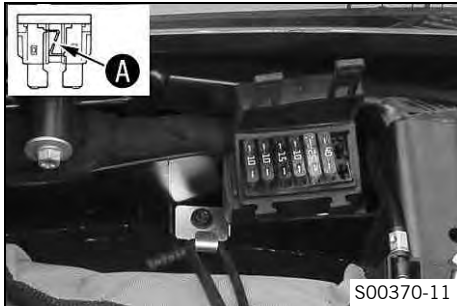

(Option: With EDS)

- Check the fuses.



Info

A defective fuse is indicated by a burned-out fuse wire **A**.

- Remove the defective fuse.

Guideline

Fuse **res** - 10 A - spare fuse

Fuse **res** - 15 A - spare fuse

Fuse **1** - 15 A - power supply for control units and components

Fuse **2** - 10 A - socket (ACC1)

Fuse **3** - 25 A - ABS hydraulic unit

Fuse **4** - 40 A - ABS return pump

Fuse **5** - not used

- Use spare fuses with the correct rating only.

Fuse (58011109110) (☛ p. 197)

Fuse (58011109115) (☛ p. 197)

Fuse (58011109125) (☛ p. 197)

Fuse (58011109140) (☛ p. 197)

**Tip**

Insert a spare fuse so that it is available if needed.

- Check that the power consumer is functioning properly.
- Close the fuse box cover.

Finishing work

- Mount the driver's seat. (☞ p. 101)
- Mount the passenger seat. (☞ p. 100)

16.7 Removing the headlight mask with the headlight

Preparatory work

- Switch off all power consumers and switch off the engine.
- Remove the passenger seat. (☞ p. 99)
- Remove the driver's seat. (☞ p. 100)
- Remove the front side cover. (☞ p. 112)
- Remove the tank cover. (☞ p. 120)
- Remove the mask spoiler. (☞ p. 114)
- Remove the wind shield. (☞ p. 123)

Main work

- Remove screws ❶.
- Remove the headlight mask forward.

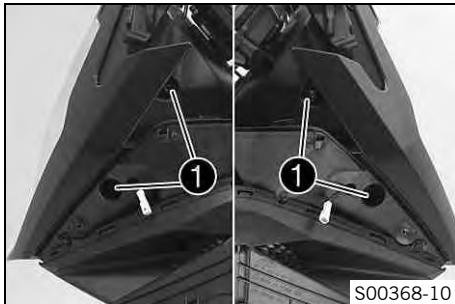

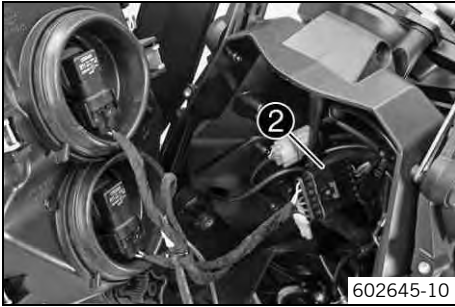

- Disconnect plug ②.
- Place the headlight mask onto a soft cloth so that the headlight is not damaged.

16.8 Refitting the headlight mask with the headlight



Main work

- Connect connector ① of the headlight.
- Check that the lighting is functioning properly.
- Position the headlight mask.

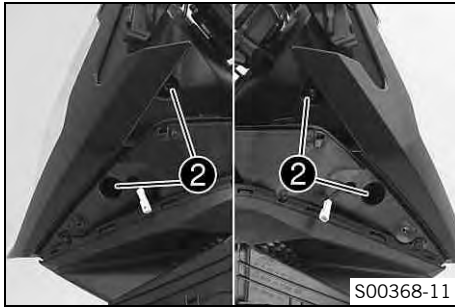

- Mount and tighten screws ②.

Guideline

| | | |
|--------------------------|----|--------------------|
| Remaining chassis screws | M6 | 10 Nm (7.4 lbf ft) |
|--------------------------|----|--------------------|

Finishing work

- Install the wind shield. (☞ p. 124)
- Install the mask spoiler. ☞ (☞ p. 117)
- Install the tank cover. (☞ p. 122)
- Install the front side cover. (☞ p. 113)
- Mount the driver's seat. (☞ p. 101)
- Mount the passenger seat. (☞ p. 100)
- Check the headlight setting. (☞ p. 168)

16.9 Changing the low beam bulb

Note

Damage to reflector Reduced brightness.

- Grease on the lamp will evaporate due to the heat and be deposited on the reflector. Clean the lamp and keep it free of grease before mounting.

Preparatory work

- Switch off all power consumers and switch off the engine.

- Remove the passenger seat. (☞ p. 99)
- Remove the driver's seat. (☞ p. 100)
- Remove the front side cover. (☞ p. 112)
- Remove the tank cover. (☞ p. 120)
- Remove the mask spoiler. (☞ p. 114)
- Remove the wind shield. (☞ p. 123)
- Remove the headlight mask with the headlight. (☞ p. 162)

Main work

- Push headlight bulb ❶ lightly into the bulb socket, turn it all the way counterclockwise, and pull it out.
- Disconnect plug ❷.

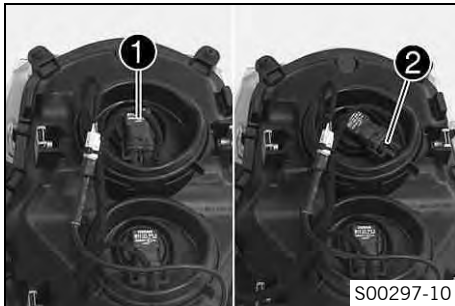

- Plug connector ❷ into the new headlight bulb.

Low beam (H11/socket PGJ19-2) (☞ p. 197)

- Position headlight bulb ❶ into the bulb socket and turn it all the way clockwise.
✓ The headlight bulb is locked into the bulb socket.

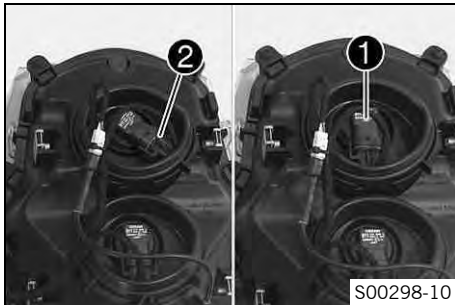

Finishing work

- Refit the headlight mask with the headlight. (☞ p. 163)

- Install the wind shield. (🔧 p. 124)
- Install the mask spoiler. 🛠️ (🔧 p. 117)
- Install the tank cover. (🔧 p. 122)
- Install the front side cover. (🔧 p. 113)
- Mount the driver's seat. (🔧 p. 101)
- Mount the passenger seat. (🔧 p. 100)
- Check the headlight setting. (🔧 p. 168)

16.10 Changing the high beam bulb

Note

Damage to reflector Reduced brightness.

- Grease on the lamp will evaporate due to the heat and be deposited on the reflector. Clean the lamp and keep it free of grease before mounting.

Preparatory work

- Switch off all power consumers and switch off the engine.
- Remove the passenger seat. (🔧 p. 99)
- Remove the driver's seat. (🔧 p. 100)
- Remove the front side cover. (🔧 p. 112)
- Remove the tank cover. (🔧 p. 120)
- Remove the mask spoiler. 🛠️ (🔧 p. 114)
- Remove the wind shield. (🔧 p. 123)
- Remove the headlight mask with the headlight. (🔧 p. 162)

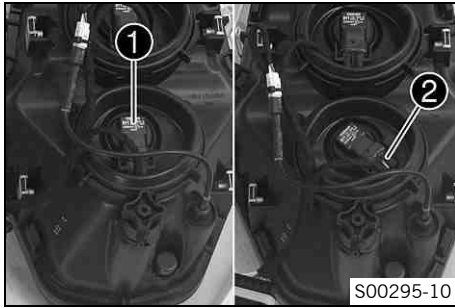

Main work

- Push headlight bulb ❶ lightly into the bulb socket, turn it all the way counterclockwise, and pull it out.
- Disconnect plug ❷.

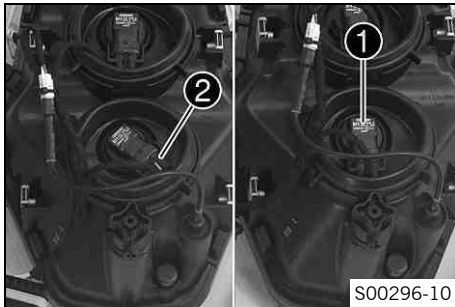

- Plug connector ❷ into the new headlight bulb.

High beam (H11/socket PGJ19-2) (☞ p. 198)

- Position headlight bulb ❶ into the bulb socket and turn it all the way clockwise.
✓ The headlight bulb is locked into the bulb socket.

Finishing work

- Refit the headlight mask with the headlight. (☞ p. 163)
- Install the wind shield. (☞ p. 124)
- Install the mask spoiler. 🛠️ (☞ p. 117)
- Install the tank cover. (☞ p. 122)
- Install the front side cover. (☞ p. 113)
- Mount the driver's seat. (☞ p. 101)
- Mount the passenger seat. (☞ p. 100)
- Check the headlight setting. (☞ p. 168)

16.11 Checking the headlight setting

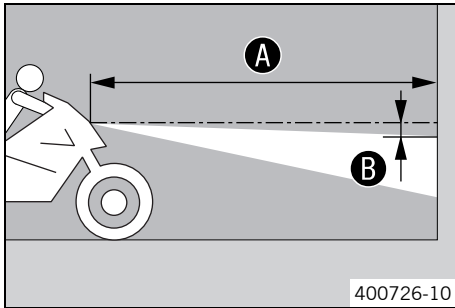

- Park the vehicle on a horizontal surface in front of a light-colored wall and make a mark at the height of the center of the low beam headlight.
- Make another mark at a distance **B** under the first mark.

Guideline

| | |
|-------------------|-------------|
| Distance B | 5 cm (2 in) |
|-------------------|-------------|

- Position the vehicle perpendicular to the wall at a distance **A** from the wall and switch on the low beam.

Guideline

| | |
|-------------------|-------------|
| Distance A | 5 m (16 ft) |
|-------------------|-------------|

- The rider, with luggage and passenger if applicable, now mounts the motorcycle.
- Check the headlight setting.

The light-dark boundary must lie exactly on the lower mark when the motorcycle is ready to operate with the rider mounted along with any baggage and a passenger if applicable.

- » If the boundary between light and dark does not meet specifications:
 - Adjust the headlight range. (☛ p. 168)

16.12 Adjusting the headlight range

Preparatory work

- Check the headlight setting. (☛ p. 168)
- Remove the bottom triple clamp cover. (☛ p. 111)

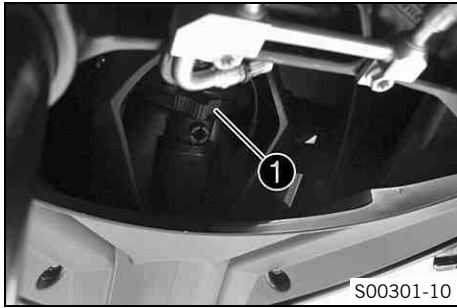

S00301-10

Main work

- Turn adjusting screw ❶ to adjust the headlight range.

i Info

Turn clockwise to increase the headlight range; turn counterclockwise to reduce the headlight range.

If you have a payload, you may have to correct the headlight range.

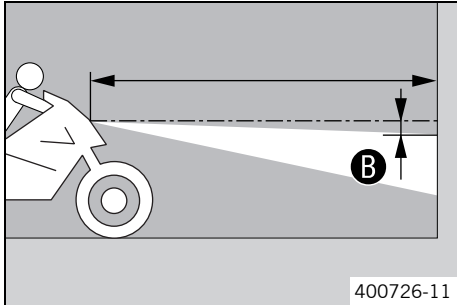

400726-11

- Set the headlight to marking ❷.

Guideline

The light-dark boundary must lie exactly on the lower mark ❷ when the motorcycle is ready to operate with the rider mounted along with any luggage and a passenger if applicable.

Finishing work

- Install the bottom triple clamp cover. 🛠️ (📄 p. 111)

17.1 Checking the coolant level in the compensating tank



Warning

Danger of scalding During motorcycle operation, the coolant gets very hot and is under pressure.

- Do not remove the radiator cap, radiator hoses or other cooling system components when the engine is hot. Allow the engine and cooling system to cool down. In case of scalding, rinse immediately with lukewarm water.



Warning

Danger of poisoning Coolant is poisonous and a health hazard.

- Coolant must not come into contact with the skin, eyes, or clothing. If contact occurs with the eyes, rinse with water immediately and contact a physician. Immediately clean contaminated areas on the skin with soap and water. If coolant is swallowed, contact a physician immediately. Change clothing that is contaminated with coolant. Keep coolant out of reach of children.



Condition

The engine is cold.

The radiator is completely full.

- Park the motorcycle on a horizontal surface.
- Check the coolant level in the compensating tank ❶.

The coolant level must be between **MIN** and **MAX**.

- » If there is no coolant in the compensating tank:
 - Check the cooling system for leaks. 🛠️



Info

Do not start up the motorcycle!

- Add coolant/bleed the cooling system. 🛠️
- » If the coolant in the compensating tank is not at the required level, but the tank is not empty:

- Correct the coolant level in the compensating tank. (🔧 p. 171)

17.2 Correcting the coolant level in the compensating tank



Warning

Danger of scalding During motorcycle operation, the coolant gets very hot and is under pressure.

- Do not remove the radiator cap, radiator hoses or other cooling system components when the engine is hot. Allow the engine and cooling system to cool down. In case of scalding, rinse immediately with lukewarm water.



Warning

Danger of poisoning Coolant is poisonous and a health hazard.

- Coolant must not come into contact with the skin, eyes, or clothing. If contact occurs with the eyes, rinse with water immediately and contact a physician. Immediately clean contaminated areas on the skin with soap and water. If coolant is swallowed, contact a physician immediately. Change clothing that is contaminated with coolant. Keep coolant out of reach of children.

Condition

The engine is cold.

The radiator is completely full.

Preparatory work

- Check the coolant level in the compensating tank. (🔧 p. 170)
- Remove the front side cover. (🔧 p. 112)



Info

Only disassemble the right-hand side.



Main work

- Remove cover ❶ of the compensating tank.



- Add coolant until the coolant reaches the specified level.

Guideline

The coolant level must be between **MIN** and **MAX**.

Alternative 1

Coolant (☛ p. 205)

Alternative 2

Coolant (mixed ready to use) (☛ p. 205)

- Mount the cover of the compensating tank.

Finishing work

- Install the front side cover. (☛ p. 113)

18.1 "Drive Mode"

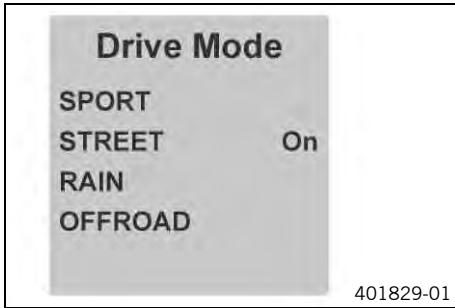

Possible states

- Sport – Homologated performance with very direct response; the traction control allows greater slip on the rear wheel
- Street – Homologated performance with very direct response; the traction control allows normal slip on the rear wheel
- RAIN – Reduced homologated performance for better ridability; the traction control allows normal slip on the rear wheel
- Offroad – Reduced homologated performance for better ridability; the traction control allows high slip on the rear wheel

Various vehicle tunings can be selected in the **"Drive Mode"** menu. You can choose from **"SPORT"**, **"STREET"**, **"RAIN"** and **"OFFROAD"**.

The drive mode selected last is displayed on the right in the segment display.



Info

The drive mode selection has no influence on the ABS.

18.2 MTC/motorcycle traction control

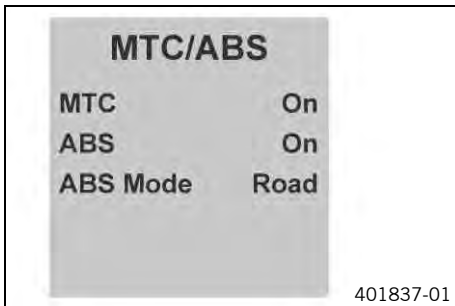

The traction control lowers the tightening torque in case of loss of traction in the rear wheel. Depending on the traction control setting, a slight slip on the rear wheel may be desirable. Example: Offroad.



Info

When traction control is switched off, the rear wheel may spin during high acceleration and on surfaces with low grip.
After the ignition is switched back on, traction control is enabled again.

Traction control is controlled via the **"Drive Mode"** (☛ p. 173) menu on the combination instrument. Traction control can be switched off in the **"MTC/ABS"** menu.

**Info**

When traction control is active, the TC lamp  flashes.

When traction control is switched off, the TC lamp  is lit.

19.1 Checking the engine oil level



Info

Oil consumption depends on the riding style and the operating conditions.

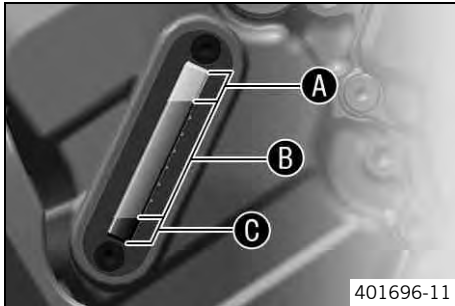

Condition

The engine is at operating temperature.

Preparatory work

- Stand the motorcycle upright on a horizontal surface.

Main work

- Check the engine oil level in the engine oil level viewer.



Info

After switching off the engine, wait one minute before checking the level.

The engine oil level should be in the upper area **B** of the engine oil level viewer.

- » When the engine oil level is in area **A** of the engine oil level viewer:
 - Do not add engine oil.
- » When the engine oil level is in area **B** of the engine oil level viewer:
 - Engine oil can be added.
- » When the engine oil level is in area **C** of the engine oil level viewer:
 - Add engine oil. (🔧 p. 180)

19.2 Changing the engine oil and filter, cleaning the oil screens



Warning

Danger of scalding Engine oil and gear oil get very hot when the motorcycle is ridden.

- Wear appropriate protective clothing and safety gloves. In case of burns, rinse immediately with lukewarm water.



Warning

Environmental hazard Hazardous substances cause environmental damage.

- Oil, grease, filters, fuel, cleaners, brake fluid, etc., should be disposed of as stipulated in applicable regulations.

Preparatory work

- Remove the engine guard. 

Main work

- Stand the motorcycle on its side stand on a horizontal surface.
- Place a suitable container under the engine.
- Remove oil drain plugs , O-rings, and oil screen.

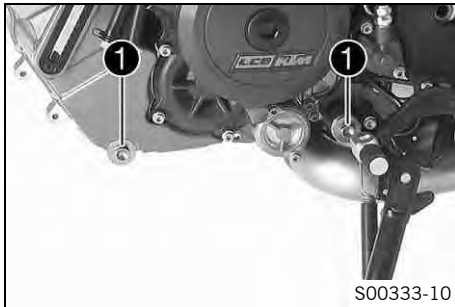

19 SERVICE WORK ON THE ENGINE

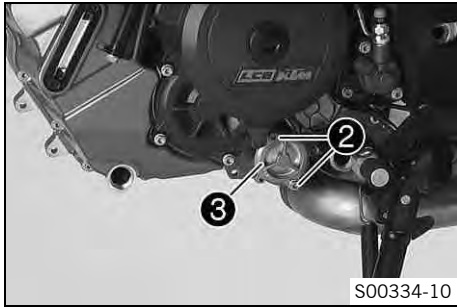

- Remove screws ②. Remove the oil filter cover ③ with the O-ring.

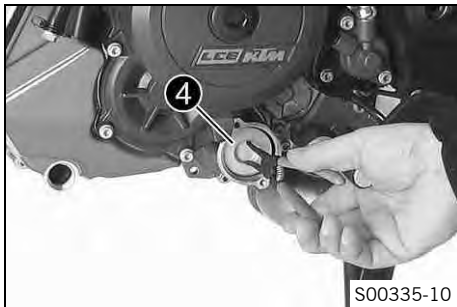

- Pull oil filter ④ out of the oil filter housing.

Circlip pliers reverse (51012011000)

- Completely drain the engine oil.
- Thoroughly clean the parts and sealing surface.

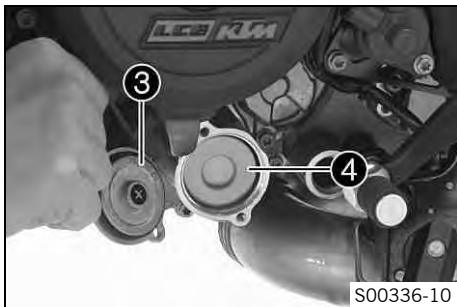

- Insert oil filter ④.
- Lubricate the O-ring of the oil filter cover. Mount the oil filter cover ③.

19 SERVICE WORK ON THE ENGINE

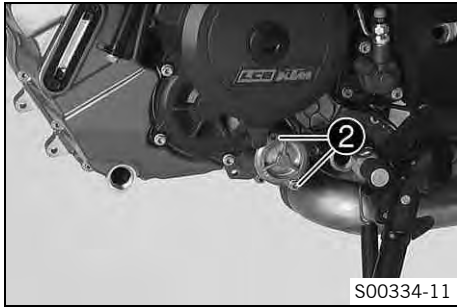

- Mount and tighten screws ②.

Guideline

| | | |
|-------------------------|----|-------------------|
| Remaining engine screws | M5 | 6 Nm (4.4 lbf ft) |
|-------------------------|----|-------------------|

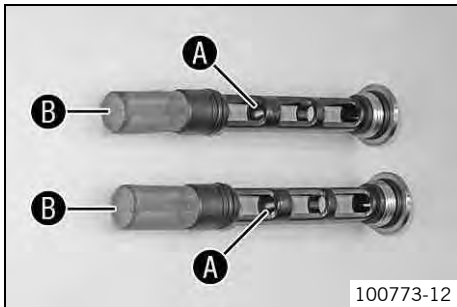

- Thoroughly clean magnet ① and oil screen ② of the oil drain plugs.

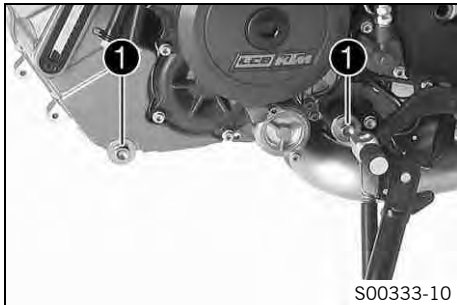

- Mount and tighten oil drain plugs ① with the magnet, O-rings, and oil screen.

Guideline

| | | |
|----------------|---------|------------------------|
| Oil drain plug | M20x1.5 | 20 Nm (14.8 lbf ft) |
|----------------|---------|------------------------|

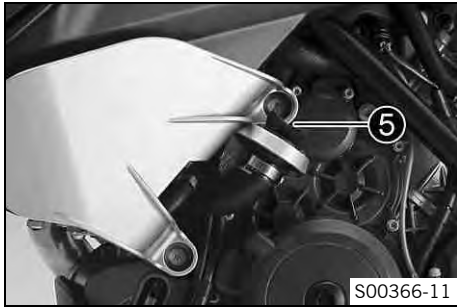

- The oil must be added in two steps.

| | | | |
|------------|------------------|--|------------------------------------|
| Engine oil | 3.60 l (3.8 qt.) | Outside temperature: ≥ 0 °C (≥ 32 °F) | Engine oil (SAE 10W/50) (☛ p. 206) |
| | | Outside temperature: < 0 °C (< 32 °F) | Engine oil (SAE 5W/40) (☛ p. 206) |

- Remove screw plug 5 and fill in engine oil.

| | | | |
|-----------------------------------|-----------------|--|------------------------------------|
| Engine oil (1st quantity) approx. | 3.0 l (3.2 qt.) | Outside temperature: ≥ 0 °C (≥ 32 °F) | Engine oil (SAE 10W/50) (☛ p. 206) |
| | | Outside temperature: < 0 °C (< 32 °F) | Engine oil (SAE 5W/40) (☛ p. 206) |

- Mount screw plug 5.



Danger

Danger of poisoning Exhaust gases are toxic and inhaling them may result in unconsciousness and/or death.

- When running the engine, always make sure there is sufficient ventilation, and do not start or run the engine in an enclosed space without an effective exhaust extraction system.

- Start the engine and check that it is oil-tight.

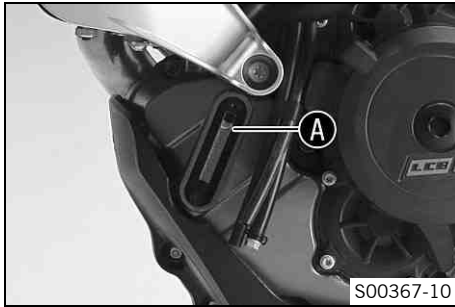

- Remove the screw plug and add the remaining engine oil to the upper marking **A** on the engine oil level viewer.
- Mount the screw plug.

**Danger**

Danger of poisoning Exhaust gases are toxic and inhaling them may result in unconsciousness and/or death.

- When running the engine, always make sure there is sufficient ventilation, and do not start or run the engine in an enclosed space without an effective exhaust extraction system.
-
- Start the engine and check that it is oil-tight.

Finishing work

- Check the engine oil level. (👉 p. 175)
- Install the engine guard. 🔧

19.3 Adding engine oil

**Info**

Too little engine oil or poor-quality engine oil results in premature wear to the engine. The engine may be damaged if the engine oil level is too high.

Condition

The engine is at operating temperature.

Preparatory work

- Stand the motorcycle upright on a horizontal surface.
- Check the engine oil level. (👉 p. 175)

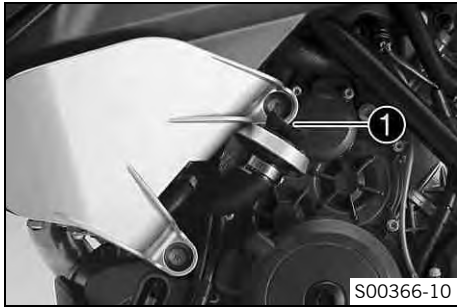

Main work

- Remove screw plug 1.

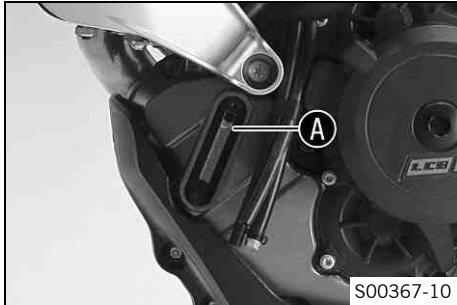

- Add engine oil to the upper marking A on the engine oil level viewer.

Condition

Outside temperature: $\geq 0\text{ }^{\circ}\text{C}$ ($\geq 32\text{ }^{\circ}\text{F}$)

Engine oil (SAE 10W/50) (☛ p. 206)

Condition

Outside temperature: $< 0\text{ }^{\circ}\text{C}$ ($< 32\text{ }^{\circ}\text{F}$)

Engine oil (SAE 5W/40) (☛ p. 206)



Info

In order to achieve optimal engine performance, it is not advisable to mix different engine oils.

KTM recommends changing the engine oil.

- Mount the screw plug.



Danger

Danger of poisoning Exhaust gases are toxic and inhaling them may result in unconsciousness and/or death.

- When running the engine, always make sure there is sufficient ventilation, and do not start or run the engine in an enclosed space without an effective exhaust extraction system.

-
- Start the engine and check that it is oil-tight.

Finishing work

- Check the engine oil level. (👉 p. 175)

20.1 Cleaning motorcycle

Note

Material damage Damage and destruction of components by high-pressure cleaning equipment.

- When cleaning the vehicle with a pressure cleaner, do not point the water jet directly onto electrical components, connectors, cables, bearings, etc. Maintain a minimum distance of 60 cm between the nozzle of the pressure cleaner and the component. Excessive pressure can cause malfunctions or destroy these parts.



Warning

Environmental hazard Hazardous substances cause environmental damage.

- Oil, grease, filters, fuel, cleaners, brake fluid, etc., should be disposed of as stipulated in applicable regulations.



Info

If you clean the motorcycle regularly, its value and appearance will be maintained over a long period.
Avoid direct sunshine on the motorcycle during cleaning.

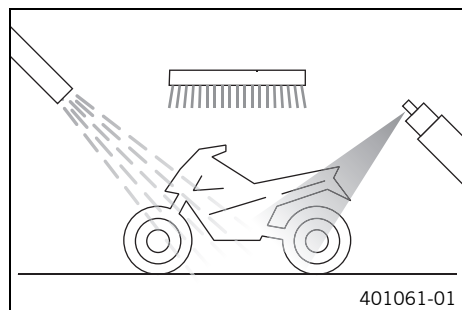

- Close off the exhaust system to keep water from entering.
- First remove coarse dirt particles with a gentle spray of water.
- Spray very dirty areas with a normal motorcycle cleaner and then clean with a brush.

Motorcycle cleaner (☛ p. 210)



Info

Use warm water containing normal motorcycle cleaner and a soft sponge.
Never apply motorcycle cleaner to a dry vehicle; always rinse the vehicle with water first.
If the vehicle was operated in road salt, clean it with cold water. Warm water would enhance the corrosive effects of salt.

- After rinsing the motorcycle with a gentle spray of water, allow it to dry thoroughly.
- Remove the closure of the exhaust system.



Warning

Danger of accidents Reduced braking efficiency due to a wet or dirty brake system.

- Clean or dry a dirty or wet brake system by riding and braking gently.

- After cleaning, ride the vehicle a short distance until the engine warms up.



Info

The heat produced causes water at inaccessible locations in the engine and on the brake system to evaporate.

- Push back the protection caps of the handlebar controls to allow any water that has penetrated to evaporate.
- After the motorcycle has cooled off, lubricate all moving parts and bearings.
- Clean the chain. (☛ p. 102)
- Treat bare metal parts (except for brake discs and exhaust system) with corrosion inhibitor.

Cleaning and preserving materials for metal, rubber and plastic (☛ p. 209)

- Treat the painted parts with a mild paint polish.

High-luster polish for paint (☛ p. 210)

- Treat the plastic parts and powder-coated parts with a mild cleaning and care product.

Paint cleaner and polish for high-gloss and matte finishes, bare metal and plastic surfaces (☛ p. 210)

- Oil the ignition/steering lock, tank lock, and seat lock.

Universal oil spray (☛ p. 211)

20.2 Checks and maintenance steps for winter operation

i Info

If you use the motorcycle in winter, you must expect salt on the roads. You should therefore take precautions against aggressive road salt.

If the vehicle was operated in road salt, clean it with cold water after riding. Warm water would enhance the corrosive effects of salt.

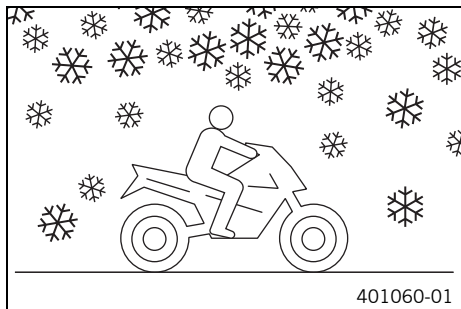

- Clean the motorcycle. (☛ p. 183)
- Clean the brakes.

i Info

After **EVERY** trip on salted roads, thoroughly wash the brake calipers and brake linings with cold water and dry carefully. This should be done after the parts are cooled down and while they are installed.

After riding on salted roads, thoroughly wash the motorcycle with cold water and dry it well.

- Treat the engine, the swingarm, and all other bare or galvanized parts (except brake discs) with a wax-based corrosion inhibitor.

i Info

Corrosion inhibitor must not come into contact with the brake discs. This would severely lower the braking effect.

- Clean the chain. (☛ p. 102)

21.1 Storage

i Info

If you plan to garage the motorcycle for a longer period, perform the following steps or have them performed. Before storing the motorcycle, check all parts for function and wear. If service, repairs or replacements are necessary, you should do this during the storage period (less workshop overload). In this way, you can avoid long workshop waiting times at the start of the new season.

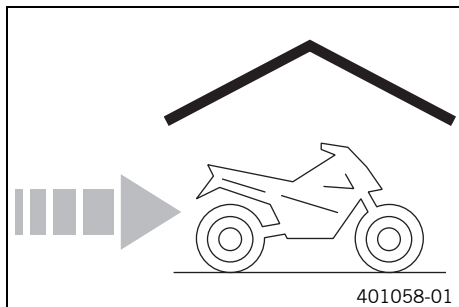

- When refueling for the last time before taking the motorcycle out of service, add fuel additive.

| |
|--------------------------|
| Fuel additive (☞ p. 209) |
|--------------------------|

- Clean the motorcycle. (☞ p. 183)
- Change the engine oil and filter, clean the oil screens. 🛠️ (☞ p. 176)
- Check the coolant fill level and antifreeze. 🛠️
- Check the tire air pressure. (☞ p. 146)
- Remove the battery. 🛠️ (☞ p. 149)

Guideline

| | |
|--|--------------------------|
| Storage temperature of battery without direct sunshine | 0... 35 °C (32... 95 °F) |
|--|--------------------------|

- Recharge the battery. 🛠️ (☞ p. 153)
- Store the vehicle in a dry location that is not subject to large fluctuations in temperature.

(Option: Center stand)

- Raise the vehicle with the center stand. (☞ p. 98)
- Cover the vehicle with a tarp or similar cover that is permeable to air.

i Info

Do not use non-porous materials since they prevent humidity from escaping, thus causing corrosion.

Avoid running the engine for a short time only. Since the engine cannot warm up properly, the water vapor produced during combustion condenses and causes valves and the exhaust system to rust.

21.2 Preparing for use after storage

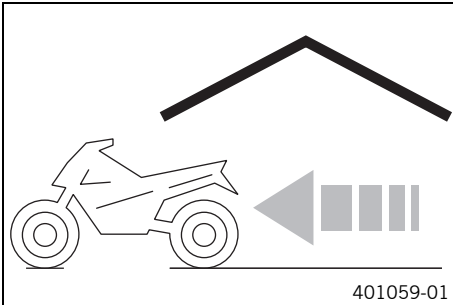
**(Option: Center stand)**

- Remove the vehicle from the center stand. (🔧 p. 98)
- Recharge the battery. (🔌 (🔧 p. 153)
- Install the battery. (🔌 (🔧 p. 151)

i Info

If the battery was disconnected, the time and date must be set.

- Refuel. (🔧 p. 86)
- Perform checks and maintenance measures when preparing for use. (🔧 p. 75)
- Take a test ride.

| Faults | Possible cause | Action |
|---|----------------------------------|--|
| Combination instrument shows nothing on the display | Fuse 1 blown | – Change the fuses in the fuse box. (☞ p. 159) |
| | Main fuse burned out | – Change the main fuse. (☞ p. 157) |
| | Battery discharged | – Recharge the battery. 🛠️ (☞ p. 153) – Check the quiescent current. 🛠️ |
| | Ignition/steering lock is faulty | – Check the ignition/steering lock. 🛠️ |
| Engine does not crank when the electric starter button is pressed | Emergency OFF switch is off | – Press the emergency OFF switch to the position ON ○. |
| | Operating error | – Carry out the start procedure. (☞ p. 76) |
| | Battery discharged | – Recharge the battery. 🛠️ (☞ p. 153) – Check the quiescent current. 🛠️ |
| | Safety start system is faulty | – Read out the fault memory using the KTM diagnostics tool. 🛠️ |
| | ICU is not enabled | – Activate the ICU. 🛠️ |
| | CAN bus communication error | – Read out the fault memory using the KTM diagnostics tool. 🛠️ |
| | Fault in EFI control unit. | – Read out the fault memory using the KTM diagnostics tool. 🛠️ |
| | Fault in MCU control unit. | – Read out the fault memory using the KTM diagnostics tool. 🛠️ |
| Engine turns only if the clutch lever is drawn | The vehicle is in gear | – Shift the transmission to idle N . |
| | Safety start system is faulty | – Read out the fault memory using the KTM diagnostics tool. 🛠️ |
| Engine turns although a gear is engaged | Safety start system is faulty | – Read out the fault memory using the KTM diagnostics tool. 🛠️ |

| Faults | Possible cause | Action |
|---|--|--|
| Engine turns but does not start | Coupling of fuel hose connection not connected | – Reconnect coupling of fuel hose connection. |
| | Defect in fuel injection system | – Read out the fault memory using the KTM diagnostics tool. 🛠️ |
| | Fuel quality is insufficient | – Add suitable fuel. |
| Engine dies during the trip | Lack of fuel | – Refuel. (🔧 p. 86) |
| | Defect in fuel injection system | – Read out the fault memory using the KTM diagnostics tool. 🛠️ |
| The engine warning lamp lights up/flashes | Defect in fuel injection system | – Read out the fault memory using the KTM diagnostics tool. 🛠️ |
| The ABS warning lamp lights up | ABS fuse is blown | – Change the fuses in the fuse box. (🔧 p. 159) |
| | Wheel speeds of front and rear wheels differ greatly | – Stop, switch off the ignition, start again. |
| | Malfunction in ABS | – Read out the fault memory using the KTM diagnostics tool. 🛠️ |
| High oil consumption | Engine oil level too high | – Check the engine oil level. (🔧 p. 175) |
| | Engine oil too thin (low viscosity) | – Change the engine oil and filter, clean the oil screens. 🛠️ (🔧 p. 176) |
| The battery is discharged | A power consumer is connected to the socket/ACC1. | – Disconnect the power consumer from the socket/ACC1. – Recharge the battery. 🛠️ (🔧 p. 153) |
| | The hazard warning flasher is switched on | – Switch off the hazard warning flasher. – Recharge the battery. 🛠️ (🔧 p. 153) |
| | Battery is not charged by alternator | – Check the charging voltage. 🛠️ |
| | Ignition not switched off when vehicle was parked | – Recharge the battery. 🛠️ (🔧 p. 153) |

23.1 Engine

| | |
|-----------------------------|--|
| Design | 2-cylinder 4-stroke Otto engine, 75° V arrangement, water-cooled |
| Displacement | 1,195 cm ³ (72.92 cu in) |
| Stroke | 69 mm (2.72 in) |
| Bore | 105 mm (4.13 in) |
| Compression ratio | 12.5:1 |
| Idle speed | 1,300... 1,500 rpm |
| Control | DOHC, 4 valves per cylinder, chain-driven |
| Valve - valve stem diameter | |
| Intake | 42 mm (1.65 in) |
| Exhaust | 34 mm (1.34 in) |
| Valve clearance | |
| Exhaust at: 20 °C (68 °F) | 0.25... 0.30 mm (0.0098... 0.0118 in) |
| Intake at: 20 °C (68 °F) | 0.10... 0.15 mm (0.0039... 0.0059 in) |
| Crankshaft bearing | Sleeve bearing |
| Conrod bearing | Sleeve bearing |
| Piston | Forged light alloy |
| Piston ring | 1 upper compression (rectangular) ring, 1 lower compression ring, 1 oil scraper ring |
| Engine lubrication | Dry sump lubrication system with three rotor pumps |
| Primary transmission | 40:76 |
| Clutch | Antihopping clutch in oil bath/hydraulically operated |
| Transmission | 6-speed claw gears |
| Transmission ratio | |

| | |
|---------------------------|---|
| 1st gear | 12:35 |
| 2nd gear | 15:32 |
| 3rd gear | 18:30 |
| 4th gear | 20:27 |
| 5th gear | 24:27 |
| 6th gear | 27:26 |
| Mixture preparation | Electronically controlled fuel injection |
| Ignition system | Contactless controlled fully electronic ignition with digital ignition adjustment |
| Alternator | 12 V, 450 W |
| Spark plug | |
| Inside spark plug | NGK LKAR9BI9 |
| Outside spark plug | NGK LMAR7A-9 |
| Electrode gap, spark plug | 0.8... 0.9 mm (0.031... 0.035 in) |
| Cooling | Water cooling, permanent circulation of coolant by water pump |
| Cold start device | Electric starter |

23.2 Engine tightening torques

| | | | |
|---|--------------------|----------------------|----------------------|
| Screw, retaining bracket, valve cover, rear | EJOT Altracs M6x10 | 10 Nm (7.4 lbf ft) | – |
| Hose clip, intake flange | M4 | 1.5 Nm (1.11 lbf ft) | – |
| Remaining engine screws | M5 | 6 Nm (4.4 lbf ft) | – |
| Screw, bearing retainer | M5 | 6 Nm (4.4 lbf ft) | Loctite® 243™ |
| Screw, bearing shell retaining bracket | M5 | 6 Nm (4.4 lbf ft) | Loctite® 243™ |
| Screw, engine oil level viewer | M5 | 4 Nm (3 lbf ft) | – |

| | | | |
|--|-----------|---------------------|---------------|
| Screw, gear sensor | M5 | 6 Nm (4.4 lbf ft) | Loctite® 243™ |
| Screw, pulse generator | M5 | 6 Nm (4.4 lbf ft) | Loctite® 243™ |
| Bleeder screw, water pump cover | M6 | 10 Nm (7.4 lbf ft) | – |
| Freewheel ring bolt | M6 – 10.9 | 15 Nm (11.1 lbf ft) | Loctite® 648™ |
| Nut, cylinder head | M6 | 9 Nm (6.6 lbf ft) | – |
| Plug, vacuum connection | M6 | 5 Nm (3.7 lbf ft) | Loctite® 243™ |
| Remaining engine screws | M6 | 10 Nm (7.4 lbf ft) | – |
| Screw, camshaft bearing support | M6 – 10.9 | 10 Nm (7.4 lbf ft) | – |
| Screw, clutch cover | M6 | 10 Nm (7.4 lbf ft) | – |
| Screw, clutch spring | M6 | 12 Nm (8.9 lbf ft) | – |
| Screw, coolant connection on cylinder head | M6 | 10 Nm (7.4 lbf ft) | – |
| Screw, damping plate | M6 | 10 Nm (7.4 lbf ft) | Loctite® 243™ |
| Screw, engine case | M6x60 | 10 Nm (7.4 lbf ft) | – |
| Screw, engine case | M6x80 | 10 Nm (7.4 lbf ft) | – |
| Screw, engine case | M6x90 | 10 Nm (7.4 lbf ft) | – |
| Screw, freewheel holder | M6 | 10 Nm (7.4 lbf ft) | Loctite® 243™ |
| Screw, locking lever | M6 | 10 Nm (7.4 lbf ft) | Loctite® 243™ |
| Screw, oil pump cover | M6 | 10 Nm (7.4 lbf ft) | Loctite® 243™ |
| Screw, shift drum locating | M6 | 10 Nm (7.4 lbf ft) | Loctite® 243™ |
| Screw, shift lever | M6 | 18 Nm (13.3 lbf ft) | Loctite® 243™ |
| Screw, starter motor | M6 | 10 Nm (7.4 lbf ft) | – |
| Screw, stator | M6 | 10 Nm (7.4 lbf ft) | Loctite® 243™ |
| Screw, valve cover | M6 | 10 Nm (7.4 lbf ft) | – |

| | | | |
|---------------------------------------|-----------|---|----------------------|
| Screw, water pump cover | M6 | 10 Nm (7.4 lbf ft) | – |
| Screw, water pump wheel | M6 | 10 Nm (7.4 lbf ft) | Loctite® 243™ |
| Stud, chain shaft | M6 | 8 Nm (5.9 lbf ft) | – |
| Vacuum connection | M6 | 2.5 Nm (1.84 lbf ft) | Loctite® 243™ |
| Nozzle 100 | M6x0.75 | 4 Nm (3 lbf ft) | Loctite® 243™ |
| Oil nozzle | M6x0.75 | 4 Nm (3 lbf ft) | Loctite® 243™ |
| Plug, crankshaft retainer | M8 | 15 Nm (11.1 lbf ft) | – |
| Screw, camshaft bearing support | M8 – 10.9 | Step 1 10 Nm (7.4 lbf ft) Step 2 18 Nm (13.3 lbf ft) | – |
| Screw, engine case | M8 | 18 Nm (13.3 lbf ft) | – |
| Screw, engine console | M8 | 20 Nm (14.8 lbf ft) | Loctite® 243™ |
| Screw, timing chain guide rail | M8 | 15 Nm (11.1 lbf ft) | Loctite® 243™ |
| Screw, timing chain tensioning rail | M8 | 15 Nm (11.1 lbf ft) | Loctite® 243™ |
| Stud, exhaust flange | M8 | 10 Nm (7.4 lbf ft) | – |
| Oil pressure sensor | M10x1 | 10 Nm (7.4 lbf ft) | – |
| Plug, cam lever axis | M10x1 | 15 Nm (11.1 lbf ft) | – |
| Plug, clutch lubrication | M10x1 | 12 Nm (8.9 lbf ft) | – |
| Screw, conrod bearing | M10x1 | Step 1 25 Nm (18.4 lbf ft) Step 2 30 Nm (22.1 lbf ft) Step 3 90° | – |
| Screw, timing chain tensioner release | M10x1 | 10 Nm (7.4 lbf ft) | – |

| | | | |
|------------------------------|-----------|--|----------------------------|
| Spark plug | M10x1 | 15 Nm (11.1 lbf ft) | – |
| Cylinder head screw | M11x1.5 | Tightening sequence: Using a crisscross pattern Step 1 15 Nm (11.1 lbf ft) Step 2 30 Nm (22.1 lbf ft) Step 3 90° Step 4 90° | Lubricated with engine oil |
| Coolant temperature sensor | M12x1.5 | 12 Nm (8.9 lbf ft) | – |
| Rotor screw | M12x1.5 | 90 Nm (66.4 lbf ft) | – |
| Spark plug | M12x1.5 | 15 Nm (11.1 lbf ft) | – |
| Nut of engine sprocket | M20x1.5 | 100 Nm (73.8 lbf ft) | Loctite® 243™ |
| Oil drain plug | M20x1.5 | 20 Nm (14.8 lbf ft) | – |
| Nut, inner clutch hub | M22x1.5 | 130 Nm (95.9 lbf ft) | Loctite® 243™ |
| Plug, timing-chain tensioner | M24x1.5 | 25 Nm (18.4 lbf ft) | – |
| Screw in alternator cover | M24x1.5 | 8 Nm (5.9 lbf ft) | – |
| Nut, primary gear | M33LHx1.5 | 130 Nm (95.9 lbf ft) | Loctite® 243™ |

23.3 Capacities

23.3.1 Engine oil

| | | | |
|------------|------------------|--|---------------------------------------|
| Engine oil | 3.60 l (3.8 qt.) | Outside temperature: ≥ 0 °C (≥ 32 °F) | Engine oil (SAE 10W/50) (☛ p. 206) |
|------------|------------------|--|---------------------------------------|

| | | | |
|------------|------------------|---------------------------------------|-----------------------------------|
| Engine oil | 3.60 l (3.8 qt.) | Outside temperature: < 0 °C (< 32 °F) | Engine oil (SAE 5W/40) (☛ p. 206) |
|------------|------------------|---------------------------------------|-----------------------------------|

23.3.2 Coolant

| | | |
|---------|-------------------|---|
| Coolant | 2.40 l (2.54 qt.) | Coolant (☛ p. 205) |
| | | Coolant (mixed ready to use) (☛ p. 205) |

23.3.3 Fuel

| | |
|-----------------------------------|--|
| Fuel reserve, approx. | 3.5 l (3.7 qt.) |
| Total fuel tank capacity, approx. | 23 l (6.1 US gal) Super unleaded (ROZ 95/RON 95/PON 91) (☛ p. 207) |

23.4 Chassis

| | |
|-------|---|
| Frame | Lattice frame made of chrome molybdenum steel tubing, powder-coated |
|-------|---|

23.4.1 Option: With EDS

| | |
|----------------|--------------------------------------|
| Fork | WP Suspension 4860 ROTA SPLIT |
| Shock absorber | WP Suspension 4614 WAD EDS |

23.4.2 Option: Without EDS

| | |
|----------------|--------------------------------------|
| Fork | WP Suspension 4860 ROTA SPLIT |
| Shock absorber | WP Suspension 4618 Emulsion |

| | |
|---|---|
| Suspension travel | |
| Front | 190 mm (7.48 in) |
| Rear | 190 mm (7.48 in) |
| Brake system | |
| Front | Double disc brake with radially mounted four-pot brake calipers, floating brake discs |
| Rear | Single disc brake with dual-piston brake caliper, floating brake disc |
| Brake discs - diameter | |
| Front | 320 mm (12.6 in) |
| Rear | 267 mm (10.51 in) |
| Brake discs - wear limit | |
| Front | 4 mm (0.16 in) |
| Rear | 4.5 mm (0.177 in) |
| Tire air pressure, solo/with passenger/full payload | |
| Front: with cold tires | 2.4 bar (35 psi) |
| Rear: with cold tires | 2.9 bar (42 psi) |
| Secondary drive ratio | 17:42 |
| Chain | 5/8 x 5/16" (525) X-ring |
| Steering head angle | 64° |
| Wheelbase | 1,560 mm (61.42 in) |
| Seat height, unloaded | 860/875 mm (860/875 in) |
| Ground clearance, unloaded | 220 mm (8.66 in) |
| Weight without fuel, approx. | 212 kg (467 lb.) |
| Maximum permissible front axle load | 159 kg (351 lb.) |

| | |
|------------------------------------|------------------|
| Maximum permissible rear axle load | 281 kg (619 lb.) |
| Maximum permissible total weight | 440 kg (970 lb.) |

23.5 Electrical system

23.5.1 Option: Without EDS

| | | |
|---------|-------------|--|
| Battery | YTZ14S | Battery voltage: 12 V Nominal capacity: 11.2 Ah maintenance-free |
| Fuse | 58011109110 | 10 A |
| Fuse | 58011109125 | 25 A |
| Fuse | 58011109130 | 30 A |
| Fuse | 58011109140 | 40 A |

23.5.2 Option: With EDS

| | | |
|---------|-------------|--|
| Battery | YTZ14S | Battery voltage: 12 V Nominal capacity: 11.2 Ah maintenance-free |
| Fuse | 58011109110 | 10 A |
| Fuse | 58011109115 | 15 A |
| Fuse | 58011109125 | 25 A |
| Fuse | 58011109130 | 30 A |
| Fuse | 58011109140 | 40 A |

| | | |
|----------|--------------------|--------------|
| Low beam | H11/socket PGJ19-2 | 12 V 55 W |
|----------|--------------------|--------------|

| | | |
|---------------------------------------|--------------------|--------------|
| High beam | H11/socket PGJ19-2 | 12 V 55 W |
| Parking light | LED | |
| Instrument lights and indicator lamps | LED | |
| Turn signal | LED | |
| Tail light | LED | |
| Brake light | LED | |
| License plate lamp | LED | |

23.6 Tires

| Front tires | Rear tires |
|--|--|
| 120/70 ZR 19 M/C 60W TL Continental ContiTrailATTACK 2 K | 170/60 ZR 17 M/C 72W TL Continental ContiTrailATTACK 2 K |
| Additional information is available in the Service section under: http://www.ktm.com | |

23.7 Fork

23.7.1 Option: With EDS

| | |
|--------------------------------------|--------------------------------------|
| Fork part number | 14.18.9M.24 |
| Fork | WP Suspension 4860 ROTA SPLIT |
| Spring length with preload spacer(s) | 393 mm (15.47 in) |
| Spring rate | |
| Medium (standard) | 6.0 N/mm (34.3 lb/in) |
| Fork length | 885 mm (34.84 in) |

| | | |
|-----------------------|-------------------------|--|
| Air chamber length | 70±20 mm (2.76±0.79 in) | |
| Fork oil per fork leg | 675 ml (22.82 fl. oz.) | Fork oil (SAE 4) (48601166S1) (☛ p. 207) |

23.7.2 Option: Without EDS

| | | |
|--------------------------------------|--------------------------------------|--|
| Fork part number | 14.18.8M.24 | |
| Fork | WP Suspension 4860 ROTA SPLIT | |
| Compression damping | | |
| Comfort | 17 clicks | |
| Standard | 12 clicks | |
| Sport | 7 clicks | |
| Full payload | 7 clicks | |
| Rebound damping | | |
| Comfort | 17 clicks | |
| Standard | 12 clicks | |
| Sport | 7 clicks | |
| Full payload | 7 clicks | |
| Spring length with preload spacer(s) | 393 mm (15.47 in) | |
| Spring rate | | |
| Medium (standard) | 6.0 N/mm (34.3 lb/in) | |
| Fork length | 885 mm (34.84 in) | |
| Air chamber length | 70±20 mm (2.76±0.79 in) | |
| Fork oil per fork leg | 675 ml (22.82 fl. oz.) | Fork oil (SAE 4) (48601166S1) (☛ p. 207) |

23.8 Shock absorber

23.8.1 Option: With EDS

| | |
|-------------------------------|-----------------------------------|
| Shock absorber part number | 11.18.9M.24 |
| Shock absorber | WP Suspension 4614 WAD EDS |
| Spring rate | |
| Medium (standard) | 160 N/mm (914 lb/in) |
| Spring length | 205 mm (8.07 in) |
| Static sag | 25 mm (0.98 in) |
| Riding sag | 55 mm (2.17 in) |
| Fitted length | 403 mm (15.87 in) |
| Shock absorber oil (☛ p. 207) | SAE 2.5 |

23.8.2 Option: Without EDS

| | |
|----------------------------|------------------------------------|
| Shock absorber part number | 01.18.7M.24 |
| Shock absorber | WP Suspension 4618 Emulsion |
| Rebound damping | |
| Comfort | 17 clicks |
| Standard | 12 clicks |
| Sport | 7 clicks |
| Full payload | 7 clicks |
| Spring preload | |
| Comfort | 4 turns |
| Standard | 4 turns |

| | |
|-------------------------------|----------------------|
| Sport | 4 turns |
| Full payload | 12 turns |
| Spring preload | |
| Comfort | 10 mm (0.39 in) |
| Standard | 10 mm (0.39 in) |
| Sport | 10 mm (0.39 in) |
| Full payload | 14 mm (0.55 in) |
| Spring rate | |
| Medium (standard) | 170 N/mm (971 lb/in) |
| Spring length | 205 mm (8.07 in) |
| Static sag | 25 mm (0.98 in) |
| Riding sag | 55 mm (2.17 in) |
| Fitted length | 402 mm (15.83 in) |
| Shock absorber oil (☛ p. 207) | SAE 2.5 |

23.9 Chassis tightening torques

| | | | |
|--|----|-------------------|---|
| Screw, combination switch, left | M4 | 2 Nm (1.5 lbf ft) | – |
| Screw, side stand switch | M4 | 2 Nm (1.5 lbf ft) | – |
| Remaining screws, chassis | M5 | 5 Nm (3.7 lbf ft) | – |
| Screw, brake line holder on swingarm | M5 | 5 Nm (3.7 lbf ft) | – |
| Screw, cable channel | M5 | 5 Nm (3.7 lbf ft) | – |
| Screw, cable guide, wheel speed sensor, rear | M5 | 3 Nm (2.2 lbf ft) | – |
| Screw, chain sliding guard | M5 | 5 Nm (3.7 lbf ft) | – |

| | | | |
|---|-------|-----------------------------|----------------------|
| Screw, combination switch, right | M5 | 3.5 Nm (2.58 lbf ft) | – |
| Screw, cover part | M5x12 | 3.5 Nm (2.58 lbf ft) | – |
| Screw, filler cap | M5 | 5 Nm (3.7 lbf ft) | – |
| Screw, foot brake lever stub | M5 | 6 Nm (4.4 lbf ft) | Loctite® 243™ |
| Screw, fuel level indicator | M5 | 3 Nm (2.2 lbf ft) | – |
| Screw, heat guard on main silencer | M5 | 4 Nm (3 lbf ft) | – |
| Screw, wind shield | M5 | 3.5 Nm (2.58 lbf ft) | – |
| Spoke nipple | M5 | 4... 6 Nm (3... 4.4 lbf ft) | – |
| Ground fitting on frame | M6 | 6 Nm (4.4 lbf ft) | – |
| Nut, ABS unit fixation | M6 | 8 Nm (5.9 lbf ft) | – |
| Remaining chassis nuts | M6 | 10 Nm (7.4 lbf ft) | – |
| Remaining chassis screws | M6 | 10 Nm (7.4 lbf ft) | – |
| Screw, battery terminal | M6 | 4.5 Nm (3.32 lbf ft) | – |
| Screw, brake line holder on bottom triple clamp | M6 | 8 Nm (5.9 lbf ft) | Loctite® 243™ |
| Screw, cable channel | M6 | 5 Nm (3.7 lbf ft) | – |
| Screw, chain guide | M6 | 5 Nm (3.7 lbf ft) | Loctite® 243™ |
| Screw, clutch assembly | M6 | 5 Nm (3.7 lbf ft) | – |
| Screw, cooler retaining bracket | M6 | 7 Nm (5.2 lbf ft) | – |
| Screw, cover part | M6 | 6 Nm (4.4 lbf ft) | – |
| Screw, engine guard | M6 | 10 Nm (7.4 lbf ft) | – |
| Screw, foot brake cylinder | M6 | 10 Nm (7.4 lbf ft) | Loctite® 243™ |
| Screw, front brake disc | M6 | 14 Nm (10.3 lbf ft) | Loctite® 243™ |
| Screw, fuel pump | M6 | 6 Nm (4.4 lbf ft) | – |
| Screw, fuel tank | M6 | 10 Nm (7.4 lbf ft) | – |

| | | | |
|---|-----|---------------------|----------------------|
| Screw, fuel tap | M6 | 6 Nm (4.4 lbf ft) | – |
| Screw, lower rear part | M6 | 6 Nm (4.4 lbf ft) | – |
| Screw, magnetic holder on side stand | M6 | 6 Nm (4.4 lbf ft) | Loctite® 243™ |
| Screw, manifold holder | M6 | 12 Nm (8.9 lbf ft) | Loctite® 243™ |
| Screw, rear brake disc | M6 | 14 Nm (10.3 lbf ft) | Loctite® 243™ |
| Screw, voltage regulator | M6 | 6 Nm (4.4 lbf ft) | – |
| Screw, wheel speed sensor, front | M6 | 10 Nm (7.4 lbf ft) | – |
| Screw, wheel speed sensor, rear | M6 | 10 Nm (7.4 lbf ft) | – |
| Remaining chassis nuts | M8 | 25 Nm (18.4 lbf ft) | – |
| Remaining chassis screws | M8 | 25 Nm (18.4 lbf ft) | – |
| Screw, bottom triple clamp | M8 | 12 Nm (8.9 lbf ft) | – |
| Screw, exhaust clamp | M8 | 12 Nm (8.9 lbf ft) | – |
| Screw, foot brake lever | M8 | 25 Nm (18.4 lbf ft) | Loctite® 243™ |
| Screw, fork stub | M8 | 15 Nm (11.1 lbf ft) | – |
| Screw, front footrest bracket | M8 | 25 Nm (18.4 lbf ft) | Loctite® 243™ |
| Screw, handlebar clamp | M8 | 20 Nm (14.8 lbf ft) | – |
| Screw, ignition lock (tamper-proof screw) | M8 | 25 Nm (18.4 lbf ft) | Loctite® 243™ |
| Screw, rear footrest bracket | M8 | 25 Nm (18.4 lbf ft) | Loctite® 243™ |
| Screw, steering damper clamp | M8 | 12 Nm (8.9 lbf ft) | – |
| Screw, suitcase hook | M8 | 20 Nm (14.8 lbf ft) | – |
| Screw, top triple clamp | M8 | 15 Nm (11.1 lbf ft) | – |
| Engine carrying screw | M10 | 45 Nm (33.2 lbf ft) | – |
| Remaining chassis nuts | M10 | 45 Nm (33.2 lbf ft) | – |
| Remaining chassis screws | M10 | 45 Nm (33.2 lbf ft) | – |

23 TECHNICAL DATA

| | | | |
|------------------------------|----------|----------------------|----------------|
| Screw, front brake caliper | M10 | 45 Nm (33.2 lbf ft) | Loctite® 243™ |
| Screw, handlebar support | M10 | 40 Nm (29.5 lbf ft) | Loctite® 243™ |
| Screw, side stand | M10 | 35 Nm (25.8 lbf ft) | Loctite® 243™ |
| Screw, side stand bracket | M10 | 45 Nm (33.2 lbf ft) | Loctite® 243™ |
| Banjo bolt, brake line | M10x1 | 25 Nm (18.4 lbf ft) | – |
| Nut, tire pressure sensor | M10x1 | 12 Nm (8.9 lbf ft) | – |
| Screw, subframe | M10x1.25 | 45 Nm (33.2 lbf ft) | Loctite® 243™ |
| Lambda sensor | M12x1.25 | 25 Nm (18.4 lbf ft) | – |
| Screw, bottom shock absorber | M14x1.5 | 80 Nm (59 lbf ft) | Thread greased |
| Screw, top shock absorber | M14x1.5 | 80 Nm (59 lbf ft) | Thread greased |
| Nut, socket | M18x1 | 4 Nm (3 lbf ft) | – |
| Nut, swingarm pivot | M19x1.5 | 130 Nm (95.9 lbf ft) | Thread greased |
| Screw, steering head, top | M22x1.5 | 50 Nm (36.9 lbf ft) | – |
| Nut, rear wheel spindle | M25x1.5 | 90 Nm (66.4 lbf ft) | Thread greased |
| Screw, front wheel spindle | M25x1.5 | 45 Nm (33.2 lbf ft) | – |
| Nut, steering head, top | M28x1.0 | 12 Nm (8.9 lbf ft) | – |

Brake fluid DOT 4 / DOT 5.1

According to

- DOT

Guideline

- Use only brake fluid that complies with the specified standard (see specifications on the container) and that possesses the corresponding properties. KTM recommends **Castrol** and **Motorex®** products.

Supplier

Castrol

- **RESPONSE BRAKE FLUID SUPER DOT 4**

Motorex®

- **Brake Fluid DOT 5.1**

Coolant

Guideline

- Use only suitable coolant (also in countries with high temperatures). Use of low-quality antifreeze can lead to corrosion and foaming. KTM recommends **Motorex®** products.

Mixture ratio

| | |
|--|---|
| Antifreeze protection: -25... -45 °C (-13... -49 °F) | 50 % corrosion inhibitor/antifreeze 50 % distilled water |
|--|---|

Coolant (mixed ready to use)

| | |
|------------|-----------------|
| Antifreeze | -40 °C (-40 °F) |
|------------|-----------------|

Supplier

Motorex®

- **COOLANT G48**

Engine oil (SAE 10W/50)

According to

- JASO T903 MA (☛ p. 212)
- SAE (☛ p. 212) (SAE 10W/50)

Guideline

- Use only engine oils that comply with the specified standards (see specifications on the container) and that possess the corresponding properties. KTM recommends **Motorex®** products.

Fully synthetic engine oil

Supplier

Motorex®

- **Power Synt 4T**

Engine oil (SAE 5W/40)

According to

- JASO T903 MA (☛ p. 212)
- SAE (☛ p. 212) (SAE 5W/40)

Guideline

- Use only engine oils that comply with the specified standards (see specifications on the container) and that possess the corresponding properties. KTM recommends **Motorex®** products.

Synthetic engine oil

Supplier

Motorex®

- **Power Synt 4T**

Fork oil (SAE 4) (48601166S1)

According to

- SAE (☛ p. 212) (SAE 4)

Guideline

- Use only oils that comply with the specified standards (see specifications on the container) and that possess the corresponding properties.

Hydraulic fluid (15)

According to

- ISO VG (15)

Guideline

- Use only hydraulic oil that complies with the specified standard (see specifications on the container) and that possesses the corresponding properties. KTM recommends **Motorex**® products.

Supplier

Motorex®

- Hydraulic Fluid 75

Shock absorber oil (SAE 2.5) (50180342S1)

According to

- SAE (☛ p. 212) (SAE 2.5)

Guideline

- Use only oils that comply with the specified standards (see specifications on the container) and that possess the corresponding properties.

Super unleaded (ROZ 95/RON 95/PON 91)

According to

- DIN EN 228 (ROZ 95/RON 95/PON 91)

Guideline

- Only use unleaded super fuel that matches or is equivalent to the specified fuel grade.
 - Fuel with an ethanol content of up to 10 % (E10 fuel) is safe to use.
-



Info

Do **not** use fuel containing methanol (e. g. M15, M85, M100) or more than 10 % ethanol (e. g. E15, E25, E85, E100).

Chain cleaner

Guideline

- KTM recommends **Motorex®** products.

Supplier

Motorex®

- **Chain Clean**

Chain lube for road use

Guideline

- KTM recommends **Motorex®** products.

Supplier

Motorex®

- **Chainlube Road**

Cleaning and preserving materials for metal, rubber and plastic

Guideline

- KTM recommends **Motorex®** products.

Supplier

Motorex®

- **Protect & Shine**

Fuel additive

Guideline

- KTM recommends **Motorex®** products.

Supplier

Motorex®

- **Fuel Stabilizer**

High-luster polish for paint

Guideline

- KTM recommends **Motorex®** products.

Supplier

Motorex®

- **Moto Polish**

Long-life grease

Guideline

- KTM recommends **Motorex®** products.

Supplier

Motorex®

- **Bike Grease 2000**

Motorcycle cleaner

Guideline

- KTM recommends **Motorex®** products.

Supplier

Motorex®

- **Moto Clean 900**

Paint cleaner and polish for high-gloss and matte finishes, bare metal and plastic surfaces

Guideline

- KTM recommends **Motorex®** products.

Supplier

Motorex®

- **Clean & Polish**

Universal oil spray

Guideline

- KTM recommends **Motorex®** products.

Supplier

Motorex®

- **Joker 440 Synthetic**

JASO T903 MA

Different technical development directions required a new specification for 4-stroke motorcycles – the JASO T903 MA Standard. Earlier, engine oils from the automobile industry were used for 4-stroke motorcycles because there was no separate motorcycle specification. Whereas long service intervals are demanded for automobile engines, high performance at high engine speeds are in the foreground for motorcycle engines. In most motorcycles, the gearbox and the clutch are lubricated with the same oil as the engine. The JASO MA Standard meets these special requirements.

SAE

The SAE viscosity classes were defined by the Society of Automotive Engineers and are used for classifying oils according to their viscosity. The viscosity describes only one property of oil and says nothing about quality.

A

| | |
|--|-----|
| ABS | 125 |
| Accessories | 14 |
| Antilock brake system | 125 |
| Auxiliary substances | 14 |

B

| | |
|-----------------------------------|---------|
| Battery | |
| installing | 151 |
| recharging | 153 |
| removing | 149 |
| Brake discs | |
| checking | 126 |
| Brake fluid | |
| front brake, adding | 128 |
| rear brake, adding | 131 |
| Brake fluid level | |
| front brake, checking | 127 |
| rear brake, checking | 130 |
| Brake linings | |
| front brake, checking | 130 |
| rear brake, checking | 133 |
| Brake system | 125-134 |
| Brakes | 81 |
| Brakes, applying | 81 |

C

| | |
|--|--------------|
| Capacity | |
| coolant | 195 |
| engine oil | 179, 194-195 |
| fuel | 87, 195 |
| Center stand | 39 |
| Chain | |
| checking | 106 |
| checking for dirt | 101 |
| cleaning | 102 |
| Chain tension | |
| adjusting | 104 |
| checking | 103 |
| Chassis number | 20 |
| Clutch | |
| fluid level, checking/rectifying | 109 |
| Clutch lever | 24 |
| adjusting | 64 |
| Combination instrument | 40-59 |
| "ABS" | 50 |
| Activation and test | 40 |
| "Clock/Date" | 56 |
| "Damping" | 92 |
| "Damping" menu | 51 |
| "Distance" | 54 |
| "Drive Mode" | 51, 173 |
| "DRL" | 57 |

INDEX

214

| | |
|---|----|
| "Favorites" | 45 |
| "Fuel Cons" | 57 |
| "General Info" | 47 |
| "Heat Grip" menu | 49 |
| "Heat Grips" | 59 |
| Indicator lamps | 42 |
| "Language" | 54 |
| "Load" | 92 |
| "Load" menu | 50 |
| matrix display | 41 |
| menu overview | 52 |
| Message on the matrix display | 43 |
| "MTC" | 50 |
| Overview | 40 |
| "Pressure" | 56 |
| "Quick Shift" | 58 |
| segment display | 41 |
| service display | 45 |
| "Set Favorites" | 48 |
| "Settings" | 48 |
| shift warning light | 44 |
| "Shift Light" | 58 |
| "Temp" | 55 |
| "TPMS" | 47 |
| "Trip 1" | 46 |
| "Trip 2" | 46 |
| "Volume" | 55 |
| "Warnings" | 49 |

| | |
|-------------------------------------|-----------|
| Combination switch | 25 |
| Overview | 25 |

| | |
|---|-----|
| Coolant level | |
| compensating tank, checking | 170 |
| compensating tank, correcting | 171 |

| | |
|-----------------------------------|----|
| Customer service | 15 |
|-----------------------------------|----|

D

| | |
|----------------------|-----|
| Driver's seat | |
| adjusting | 60 |
| mounting | 101 |
| removing | 100 |

E

| | |
|--|----|
| Electric starter button | 29 |
| Emergency OFF switch | 28 |

| | |
|----------------------|----|
| Engine | |
| running in | 72 |

| | |
|--------------------------------|----|
| Engine number | 21 |
|--------------------------------|----|

| | |
|--------------------|-----|
| Engine oil | |
| adding | 180 |
| changing | 176 |

| | |
|-------------------------|-----|
| Engine oil level | |
| checking | 175 |

| | |
|------------------------|-----|
| Engine sprocket | |
| checking | 106 |

| | |
|------------------------------|----|
| Environment | 12 |
|------------------------------|----|

| | |
|------------------------------------|-----------|
| F | |
| Figures | 15 |
| Filler cap | |
| Closing | 32 |
| Opening | 31 |
| Foot brake lever | 67 |
| basic position, adjusting | 67 |
| Footrests | |
| adjusting | 65 |
| Fork | 93 |
| compression damping, setting | 93 |
| rebound, adjusting | 94 |
| Fork part number | 22 |
| Front fender, front | |
| installing | 120 |
| removing | 119 |
| Front wheel | |
| installing | 137 |
| removing | 135 |
| Fuel cocks | 33 |
| Fuses | |
| in fuse box, changing | 159 |
| G | |
| Grab handles | 36 |

| | |
|--|-----------|
| H | |
| Hand brake lever | 24 |
| basic position, adjusting | 64 |
| Handlebar position | 61 |
| adjusting | 61 |
| Hazard warning flasher | 26 |
| Hazard warning flasher switch | 26 |
| Headlight | |
| daytime running light | 149 |
| headlight range, adjusting | 168 |
| Headlight mask with headlight | |
| installing | 163 |
| removing | 162 |
| Headlight setting | |
| checking | 168 |
| High beam bulb | |
| changing | 166 |
| Horn button | 28 |
| I | |
| Ignition lock | 29 |
| immobilizer | 30 |
| Intended use | 9 |
| K | |
| Key number | 21 |

L

| | |
|-------------------------------------|-----|
| Light switch | 26 |
| Low beam bulb | |
| changing | 164 |
| Luggage | 73 |
| Luggage rack plate | 37 |

M

| | |
|--|-----|
| Main fuse | |
| changing | 157 |
| Mask spoiler | |
| installing | 117 |
| removing | 114 |
| Matrix display | |
| menu | 45 |
| Motorcycle | |
| cleaning | 183 |
| Motorcycle traction control | 173 |
| MTC | 173 |

O

| | |
|---------------------------------------|-----|
| Oil filter | |
| changing | 176 |
| Oil screens | |
| cleaning | 176 |
| Operating substances | 14 |
| Owner's Manual | 13 |

P

| | |
|--|-----|
| Parking | 83 |
| Passenger footrests | 37 |
| Passenger seat | |
| mounting | 100 |
| removing | 99 |
| Preparing for use | |
| advice on first use | 71 |
| after storage | 187 |
| checks and maintenance measures when preparing for use | 75 |
| Protective clothing | 12 |

R

| | |
|----------------------------------|-----------|
| Rear hub rubber dampers | |
| checking | 143 |
| Rear sprocket | |
| checking | 106 |
| Rear wheel | |
| installing | 141 |
| removing | 139 |
| Refueling | |
| fuel | 86 |
| Rider footrests | 65 |
| Riding | 77 |
| starting off | 77 |

INDEX

217

| | |
|--|-----------|
| S | |
| Safe operation | 11 |
| Seat lock | 35 |
| Service | 14 |
| Service schedule | 88-91 |
| Shift lever | 38 |
| basic position, adjusting | 69 |
| basic position, checking | 69 |
| Shifting | 77 |
| Shock absorber | 93 |
| rebound damping, adjusting | 95 |
| spring preload, adjusting | 96 |
| Shock absorber part number | 22 |
| Side cover, front | |
| removing | 112 |
| Side cover, front, | |
| installing | 113 |
| Side stand | 39 |
| Socket for electrical accessories | 30 |
| Spare parts | 14 |
| Spoke tension | |
| checking | 147 |
| Starting | 76 |
| Steering head bearing play | |
| checking | 110 |
| Steering lock | 29 |

| | |
|--|-------|
| Stopping | 83 |
| Storage | 186 |
| Storage compartment | |
| Closing | 34 |
| Opening | 34 |
| Suspension setting | 92-97 |
| Switch | |
| on the left side of the handlebar | 25 |
| on the right side of the handlebar | 28 |

| | |
|----------------------------------|---------|
| T | |
| Tank cover | |
| installing | 122 |
| removing | 120 |
| Technical data | |
| capacities | 194 |
| chassis | 195 |
| chassis tightening torques | 201 |
| electrical system | 197 |
| engine | 190-204 |
| engine tightening torques | 191 |
| fork | 198 |
| shock absorber | 200 |
| tires | 198 |
| Throttle grip | 25 |
| Tire air pressure | |
| checking | 146 |

| | |
|-----------------------------------|---------|
| Tire condition | |
| checking | 145 |
| Tool set | 36 |
| Transport | 85 |
| Triple clamp cover, bottom | |
| installing | 111 |
| removing | 111 |
| Troubleshooting | 188-189 |
| Turn signal switch | 27 |
| Type label | 20 |
| U | |
| Use definition | 9 |
| V | |
| Vehicle | |
| loading | 73 |
| raising with the center stand | 98 |
| removing from the center stand | 98 |
| View of vehicle | |
| front left side | 16 |
| rear right side | 18 |
| W | |
| Warranty | 14 |
| Wind shield | |
| adjusting | 62 |
| installing | 124 |
| removing | 123 |
| Winter operation | |
| checks and maintenance steps | 185 |
| Work rules | 12 |



3211955en

07/2013



KTM-Sportmotorcycle AG
3230 Mattighofen/Austria
<http://www.ktm.com>



Photo: Mitterbauer/KTM