



125 Duke EU  
200 Duke EU  
200 Duke AR  
200 Duke ASIA  
200 Duke CN  
200 Duke MY

Art. no. 3213117en





# DEAR KTM CUSTOMER

Congratulations on your decision to purchase a KTM motorcycle. You are now the owner of a state-of-the-art sports motorcycle that will give you enormous pleasure if you service and maintain it accordingly.

We wish you a lot of enjoyment in riding this vehicle.

Enter the serial numbers of your vehicle below.

Chassis number/type label (☛ p. 20)	Dealer's stamp
Engine number (☛ p. 20)	
Key number (☛ p. 21)	

The Owner's Manual contained the latest information for this model series at the time of going to print. Minor differences due to developments in design cannot be ruled out completely.

All specifications are non-binding. KTM Sportmotorcycle AG specifically reserves the right to modify or delete technical specifications, prices, colors, forms, materials, services, designs, equipment, etc., without prior notice and without specifying reasons, to adapt these to local conditions, as well as to stop production of a particular model without prior notice. KTM accepts no liability for delivery options, deviations from illustrations and descriptions, as well as misprints and other errors. The models portrayed partly contain special equipment that does not belong to the regular scope of supply.

© 2014 KTM-Sportmotorcycle AG, Mattighofen Austria

All rights reserved

Reproduction, even in part, as well as copying of all kinds, is permitted only with the express written permission of the copyright owner.

# DEAR KTM CUSTOMER



ISO 9001(12 100 6061)

According to the international quality management standard ISO 9001, KTM uses quality assurance processes that lead to the maximum possible quality of the products.

Issued by: TÜV Management Service

REG.NO. 12 100 6061

KTM-Sportmotorcycle AG  
5230 Mattighofen, Austria

















# TABLE OF CONTENTS

1	MEANS OF REPRESENTATION .....	7	6.2	Hand brake lever.....	22
	1.1 Symbols used .....	7	6.3	Throttle grip .....	23
	1.2 Formats used.....	7	6.4	Horn button.....	23
2	SAFETY ADVICE.....	8	6.5	Light switch .....	24
	2.1 Use definition.....	8	6.6	High beam flasher button .....	24
	2.2 Safety advice.....	8	6.7	Turn signal switch.....	25
	2.3 Degrees of risk and symbols .....	9	6.8	Emergency OFF switch .....	25
	2.4 Tampering warning.....	9	6.9	Electric starter button.....	26
	2.5 Safe operation .....	10	6.10	Ignition/steering lock.....	26
	2.6 Protective clothing .....	11	6.11	Combination instrument .....	27
	2.7 Work rules.....	11	6.11.1	Overview .....	27
	2.8 Environment.....	11	6.11.2	Activation and test.....	28
	2.9 Owner's Manual .....	12	6.11.3	Warning notes .....	29
3	IMPORTANT INFORMATION .....	13	6.11.4	Function buttons .....	32
	3.1 Guarantee, warranty .....	13	6.11.5	Indicator lamps .....	33
	3.2 Operating and auxiliary substances .....	13	6.11.6	Display .....	34
	3.3 Spare parts, accessories .....	13	6.11.7	Filling level display in fuel tank.....	35
	3.4 Service .....	13	6.11.8	TRIP F display.....	36
	3.5 Figures .....	14	6.11.9	Coolant temperature indicator .....	37
	3.6 Customer service.....	14	6.11.10	Info display.....	38
4	VIEW OF VEHICLE .....	16	6.11.11	Riding time/average speed menu .....	39
	4.1 View of vehicle, front left (example) .....	16	6.11.12	Average speed/average fuel consumption 1 menu.....	39
	4.2 View of vehicle, rear right (example) .....	18	6.11.13	Average fuel consumption 1/average fuel consumption 2 menu .....	40
5	SERIAL NUMBERS .....	20	6.11.14	Average fuel consumption 2/service menu .....	41
	5.1 Chassis number/type label .....	20	6.11.15	Service/range menu.....	42
	5.2 Engine number .....	20	6.11.16	Range/riding time menu .....	43
	5.3 Key number.....	21	6.11.17	Total distance menu ODO .....	44
6	CONTROLS.....	22			
	6.1 Clutch lever.....	22			

# TABLE OF CONTENTS

6.11.18	Distance menu 1 TRIP 1 .....	44	9	SERVICE SCHEDULE .....	71
6.11.19	Distance menu 2 TRIP 2 .....	45	9.1	Service schedule.....	71
6.11.20	Setting kilometers or miles .....	45	10	TUNING THE CHASSIS .....	73
6.11.21	Setting the time.....	46	10.1	Adjusting the spring preload of the shock absorber  .....	73
6.11.22	Adjusting the shift speed RPM 1 .....	47	10.2	Adjusting the shift lever.....	74
6.11.23	Adjusting the shift speed RPM 2 .....	47	11	SERVICE WORK ON THE CHASSIS.....	75
6.12	Opening the filler cap.....	48	11.1	Raising the motorcycle with the rear wheel stand .....	75
6.13	Closing the filler cap .....	50	11.2	Taking the motorcycle off of the rear wheel stand .....	75
6.14	Seat lock.....	50	11.3	Raising the motorcycle with the front wheel stand .....	76
6.15	Tool set.....	51	11.4	Taking the motorcycle off of the front wheel stand .....	77
6.16	Grab handles.....	51	11.5	Removing the passenger seat .....	78
6.17	Passenger footrests .....	52	11.6	Mounting the passenger seat.....	79
6.18	Shift lever .....	52	11.7	Removing the seat .....	79
6.19	Foot brake lever .....	53	11.8	Mounting the seat .....	80
6.20	Side stand.....	54	11.9	Checking for chain dirt accumulation .....	81
7	PREPARING FOR USE.....	55	11.10	Cleaning the chain .....	81
7.1	Advice on first use .....	55	11.11	Checking the chain tension .....	82
7.2	Running in the engine .....	56	11.12	Adjusting the chain tension.....	84
7.3	Loading the vehicle .....	57	11.13	Checking the chain, rear sprocket, and engine sprocket.....	87
8	RIDING INSTRUCTIONS.....	59	11.14	Removing the front spoiler .....	94
8.1	Checks and maintenance when preparing for use .....	59	11.15	Fitting front spoiler .....	95
8.2	Starting.....	60	12	BRAKE SYSTEM .....	96
8.3	Starting off.....	62	12.1	ABS/antilock brake system (Option: With ABS) ....	96
8.4	Shifting, riding .....	62	12.2	Checking the brake discs .....	97
8.5	Applying the brakes.....	65			
8.6	Stopping, parking.....	67			
8.7	Transport .....	68			
8.8	Refueling .....	69			

# TABLE OF CONTENTS

12.3	Checking the brake fluid level of the front brake ...	98	15	COOLING SYSTEM .....	142
12.4	Adding front brake fluid  .....	99	15.1	Cooling system .....	142
12.5	Checking the front brake linings .....	100	15.2	Checking the antifreeze and coolant level .....	143
12.6	Checking the free travel of foot brake lever .....	101	15.3	Checking the coolant level .....	145
12.7	Adjusting the free travel of the foot brake lever  .....	102	15.4	Draining the coolant  .....	147
12.8	Checking the rear brake fluid level .....	103	15.5	Filling/bleeding the cooling system  .....	148
12.9	Adding rear brake fluid  .....	105	16	TUNING THE ENGINE .....	151
12.10	Checking the rear brake linings .....	106	16.1	Checking the play in the throttle cable .....	151
13	WHEELS, TIRES .....	108	16.2	Adjusting the play in the throttle cable  .....	152
13.1	Removing the front wheel  .....	108	16.3	Checking the clutch lever play .....	152
13.2	Installing the front wheel  .....	109	16.4	Adjusting the clutch cable play  .....	153
13.3	Removing the rear wheel  .....	112	17	SERVICE WORK ON THE ENGINE .....	154
13.4	Installing the rear wheel  .....	113	17.1	Checking the engine oil level .....	154
13.5	Checking the rear hub rubber dampers  .....	117	17.2	Changing the engine oil and oil filter, cleaning the oil screen  .....	154
13.6	Checking the tire condition .....	118	17.3	Adding engine oil .....	157
13.7	Checking the tire air pressure .....	119	18	CLEANING, CARE .....	159
14	ELECTRICAL SYSTEM .....	121	18.1	Cleaning the motorcycle .....	159
14.1	Removing the battery  .....	121	18.2	Checks and maintenance steps for winter operation .....	161
14.2	Installing the battery  .....	122	19	STORAGE .....	163
14.3	Recharging the battery  .....	123	19.1	Storage .....	163
14.4	Changing the ABS fuses (Option: With ABS) .....	126	19.2	Preparing for use after storage .....	164
14.5	Changing the fuses of individual power consumers .....	127	20	TROUBLESHOOTING .....	165
14.6	Changing the headlight bulb .....	131	21	TECHNICAL DATA .....	168
14.7	Changing the parking light bulb .....	134	21.1	Engine .....	168
14.8	Checking the headlight setting .....	138	21.1.1	125 Duke .....	168
14.9	Adjusting the headlight range .....	139	21.1.2	200 Duke, 200 Duke CN .....	169
			21.2	Engine tightening torques .....	171

# TABLE OF CONTENTS

21.3	Capacities .....	173
21.3.1	Engine oil .....	173
21.3.2	Coolant .....	173
21.3.3	Fuel .....	173
21.4	Chassis .....	173
21.5	Electrical system.....	175
21.6	Tires .....	176
21.7	Fork.....	176
21.8	Shock absorber .....	176
21.9	Chassis tightening torques .....	177
22	SUBSTANCES .....	181
23	AUXILIARY SUBSTANCES .....	184
24	STANDARDS .....	186
	INDEX .....	187



# 1 MEANS OF REPRESENTATION

## 1.1 Symbols used

The meaning of specific symbols is described below.

---



Indicates an expected reaction (e.g. of a work step or a function).



Indicates an unexpected reaction (e.g. of a work step or a function).



All work marked with this symbol requires specialist knowledge and technical understanding. In the interest of your own safety, have these jobs performed by an authorized KTM workshop. There, your motorcycle will be optimally cared for by specially trained experts using the specialist tools required.



Indicates a page reference (more information is provided on the specified page).

---

## 1.2 Formats used

The typographical formats used in this document are explained below.

---

**Specific name** Identifies a proprietary name.

**Name®** Identifies a protected name.

**Brand™** Identifies a brand available on the open market.

---

### 2.1 Use definition

KTM sport motorcycles are designed and constructed to meet the normal demands of regular road operation but not for use on race courses or offroad.

---



#### Info

The motorcycle is authorized for public road traffic in the homologous version only.

---

### 2.2 Safety advice

A number of safety instructions need to be followed to operate the vehicle safely. Therefore, read this manual carefully. The safety instructions are highlighted in the text and are referred to at the relevant passages.

---



#### Info

The vehicle has various information and warning labels at prominent locations. Do not remove information/warning labels. If they are missing, you or others may not recognize dangers and may therefore be injured.

---

### 2.3 Degrees of risk and symbols

---



#### **Danger**

Identifies a danger that will immediately and invariably lead to fatal or serious permanent injury if the appropriate measures are not taken.



#### **Warning**

Identifies a danger that is likely to lead to fatal or serious injury if the appropriate measures are not taken.



#### **Caution**

Identifies a danger that may lead to minor injuries if the appropriate measures are not taken.

#### **Note**

Identifies a danger that will lead to considerable machine and material damage if the appropriate measures are not taken.



#### **Warning**

Identifies a danger that will lead to environmental damage if the appropriate measures are not taken.

---

### 2.4 Tampering warning

Tampering with the noise control system is prohibited. Federal law prohibits the following acts or the causing thereof:

- 1 The removal or rendering inoperative by any person other than for purposes of maintenance, repair, or replacement, of any device or element of design incorporated into any new vehicle for the purpose of noise control prior to its sale or delivery to the ultimate purchaser or while it is in use, or
- 2 the use of the vehicle after such device or element of design has been removed or rendered inoperative by any person.

Among those acts presumed to constitute tampering are the acts listed below:

- 1 Removal or puncturing of the main silencer, baffles, header pipes or any other components which conduct exhaust gases.
- 2 Removal or puncturing of parts of the intake system.
- 3 Lack of proper maintenance.
- 4 Replacing moving part of the vehicle, or parts of the exhaust or intake system, with parts other than those specified by the manufacturer.

### 2.5 Safe operation



#### **Danger**

**Danger of accidents** Danger arising from the rider's judgement being impaired.

- Do not operate the vehicle while under the influence of alcohol, drugs and certain medications or physically or mentally impaired.



#### **Danger**

**Danger of poisoning** Exhaust gases are toxic and inhaling them may result in unconsciousness and/or death.

- When running the engine, always make sure there is sufficient ventilation, and do not start or run the engine in an enclosed space without an effective exhaust extraction system.



#### **Warning**

**Danger of burns** Some vehicle components become very hot when the vehicle is operated.

- Do not touch hot components such as exhaust system, radiator, engine, shock absorber, and the brake system. Allow these components to cool down before starting work on them.

---

Only operate the vehicle when it is in perfect technical condition, in accordance with its intended use, and in a safe and environmentally compatible manner.

An appropriate driver's license is needed to ride the vehicle on public roads.

Have malfunctions that impair safety promptly eliminated by an authorized KTM workshop.

Adhere to the information and warning labels on the vehicle.

### 2.6 Protective clothing



#### Warning

**Risk of injury** Missing or poor protective clothing presents an increased safety risk.

- Wear protective clothing (helmet, boots, gloves, pants and jacket with protectors) every time you ride the vehicle. Always wear protective clothing that is in good condition and meets the legal requirements.

In the interest of your own safety, KTM recommends that you only operate the vehicle while wearing protective clothing.

### 2.7 Work rules

Special tools are necessary for certain tasks. The tools are not contained in the vehicle but can be ordered under the number in parentheses. E.g.: bearing puller (15112017000)

During assembly, non-reusable parts (e.g. self-locking screws and nuts, seals and seal rings, O-rings, pins, lock washers) must be replaced by new parts.

In some instances, a thread locker (e.g. **Loctite**®) is required. The manufacturer instructions for use must be followed.

After disassembly, clean the parts that are to be reused and check them for damage and wear. Change damaged or worn parts.

After you complete the repair or service work, check the operating safety of the vehicle.

### 2.8 Environment

If you use your motorcycle responsibly, you can ensure that problems and conflicts do not occur. To protect the future of the motorcycle sport, make sure that you use your motorcycle legally, display environmental consciousness, and respect the rights of others. When disposing of used oil, other operating and auxiliary fluids, and used components, comply with the laws and regulations of the respective country.

Because motorcycles are not subject to the EU regulations governing the disposal of used vehicles, there are no legal regulations that pertain to the disposal of an end-of-life motorcycle. Your authorized KTM dealer will be glad to advise you.

### 2.9 Owner's Manual

It is important that you read this Owner's Manual carefully and completely before making your first trip. The Owner's Manual contains useful information and many tips on how to operate, handle, and maintain your motorcycle. Only then will you find out how to customize the vehicle ideally for your own use and how you can protect yourself from injury.

Keep the Owner's Manual in an accessible place to enable you to refer to it as needed.

If you would like to know more about the vehicle or have questions on the material you read, please contact an authorized KTM dealer.

The Owner's Manual is an important component of the vehicle and should be handed over to the new owner if the vehicle is sold.

## 3.1 Guarantee, warranty

The work prescribed in the service schedule must be carried out by an authorized KTM workshop only and confirmed in the customer's Service & Warranty Booklet and in the **KTM dealer.net**; otherwise, all warranty claims will be void. No warranty claims can be considered for damage resulting from manipulations and/or alterations to the vehicle.

Additional information on the guarantee or warranty and the procedures involved can be found in the Service & Warranty Booklet.

## 3.2 Operating and auxiliary substances



### Warning

**Environmental hazard** Improper handling of fuel is a danger to the environment.

- Do not allow fuel to get into the ground water, the ground, or the sewage system.

Use operating and auxiliary substances (such as fuel and lubricants) as specified in the Owner's Manual.

## 3.3 Spare parts, accessories

For your own safety, only use spare parts and accessory products that are approved and/or recommended by KTM and have them installed by an authorized KTM workshop. KTM accepts no liability for other products and any resulting damage or loss.

Certain spare parts and accessory products are specified in parentheses in the descriptions. Your authorized KTM dealer will be glad to advise you.

The current **KTM PowerParts** for your vehicle can be found on the KTM website.

International KTM Website: <http://www.ktm.com>

## 3.4 Service

A prerequisite for perfect operation and prevention of premature wear is that the service, care, and tuning work on the engine and chassis is properly carried out as described in the Owner's Manual. Incorrect adjustment and tuning of the engine and chassis can lead to damage and breakage of components.

Use of the vehicle under difficult conditions, such in rain, high heat or with a heavy load, can lead to considerably more rapid wear of components such as the drive train, brake system, or suspension components. For this reason, it may be necessary to inspect or replace parts before the next scheduled service.

It is imperative that you adhere to the stipulated run-in times and service intervals. If you observe these exactly, you will ensure a much longer service life for your motorcycle.

### 3.5 Figures

The figures contained in the manual may depict special equipment.

In the interest of clarity, some components may be shown disassembled or may not be shown at all. It is not always necessary to disassemble the component to perform the activity in question. Please follow the instructions in the text.

### 3.6 Customer service

Your authorized KTM dealer will be happy to answer any questions you may have on your vehicle and KTM.

A list of authorized KTM dealers can be found on the KTM website.

International KTM Website: <http://www.ktm.com>





# 4 VIEW OF VEHICLE

## 4.1 View of vehicle, front left (example)



# 4 VIEW OF VEHICLE

1	Combination instrument
2	Rear mirror
3	Clutch lever (☛ p. 22)
4	Seat
5	Passenger seat
6	Seat lock (☛ p. 50)
7	Grab handles (☛ p. 51)
8	Engine number (☛ p. 20)
9	Side stand (☛ p. 54)
10	Shift lever (☛ p. 52)

# 4 VIEW OF VEHICLE

## 4.2 View of vehicle, rear right (example)

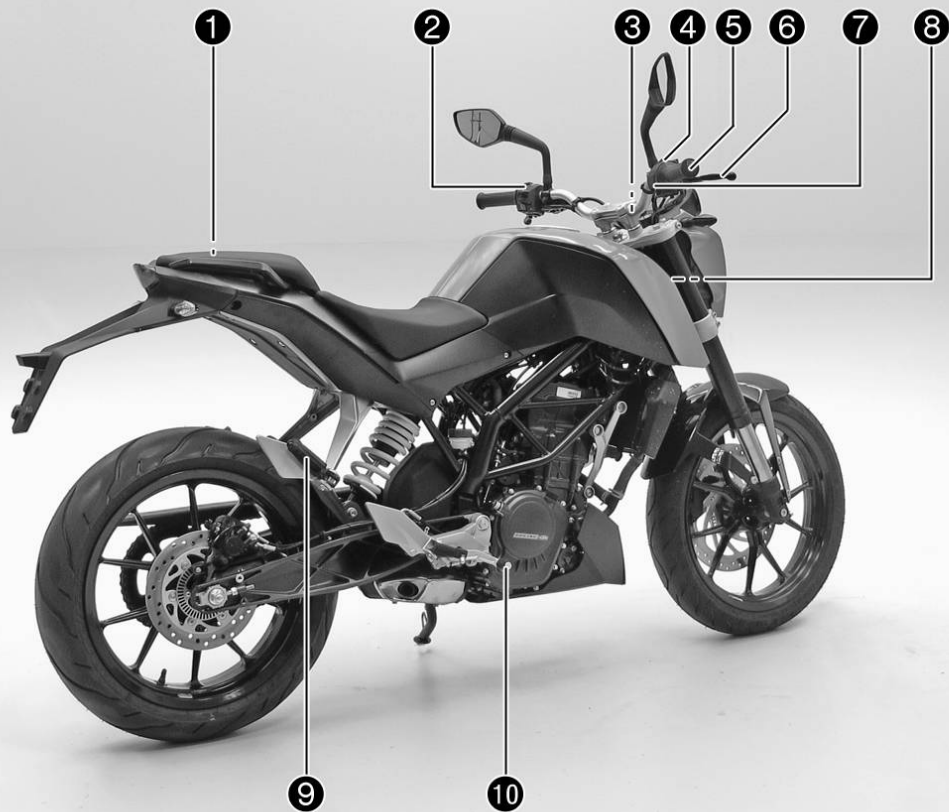

# 4 VIEW OF VEHICLE

1	Tool set (☛ p. 51)
2	Light switch (☛ p. 24)
2	High beam flasher button (☛ p. 24)
2	Turn signal switch (☛ p. 25)
2	Horn button (☛ p. 23)
3	Filler cap
4	Ignition/steering lock (☛ p. 26)
5	Emergency OFF switch (☛ p. 25)
6	Hand brake lever (☛ p. 22)
7	Electric starter button (☛ p. 26)
8	Chassis number/type label (☛ p. 20)
9	Passenger footrests (☛ p. 52)
10	Foot brake lever (☛ p. 53)

# 5 SERIAL NUMBERS

## 5.1 Chassis number/type label

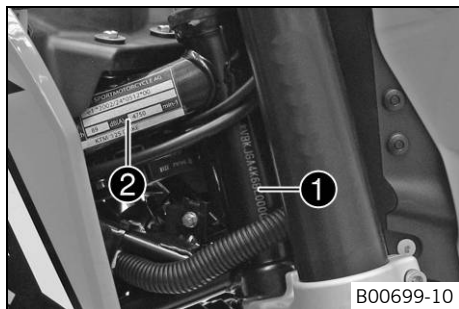

The chassis number ❶ is stamped on the right of the steering head.  
The type label ❷ is on the right of the frame behind the steering head.

## 5.2 Engine number

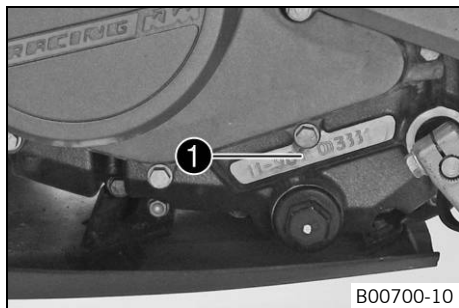

The engine number ❶ is stamped on the left side of the engine under the engine sprocket.

## 5.3 Key number

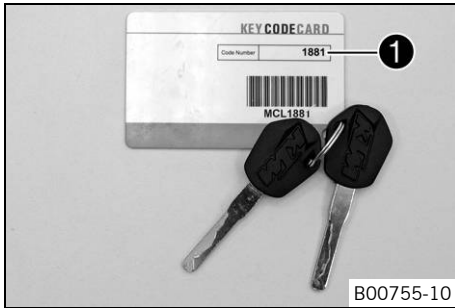

The key number ① can be found on the **KEYCODECARD**.



### Info

You need the key number to order a spare key. Keep the **KEYCODECARD** in a safe place.

## 6.1 Clutch lever

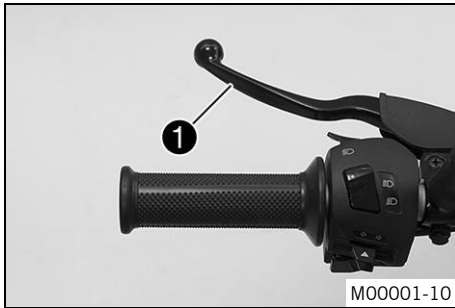

The clutch lever ❶ is fitted on the left side of the handlebar.

## 6.2 Hand brake lever

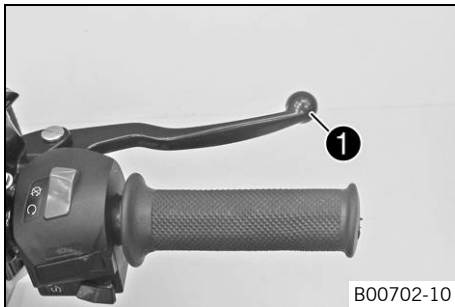

The hand brake lever ❶ is fitted on the right side of the handlebar.  
The front brake is engaged using the hand brake lever.



## 6.3 Throttle grip

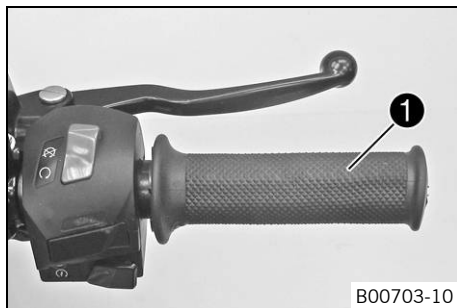



The throttle grip ❶ is fitted on the right side of the handlebar.

## 6.4 Horn button



The horn button ❶ is fitted on the left side of the handlebar.

### Possible states

- Horn button  in neutral position
- Horn button  pressed – The horn is operated in this position.



## 6.5 Light switch



M00003-10

The light switch ❶ is fitted on the left side of the handlebar.

### Possible states

	Low beam on – Light switch is turned downward. In this position, the low beam and tail light are switched on.
	High beam on – Light switch is turned upward. In this position, the high beam and the tail light are switched on.

## 6.6 High beam flasher button



M00004-10

The high beam flasher button ❶ is fitted on the left side of the handlebar.

### Possible states

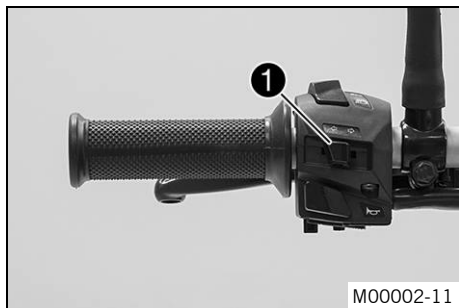

- High beam flasher button in neutral position
- High beam flasher button pressed – In this position, the headlight flasher (high beam) is actuated.

## 6.7 Turn signal switch



The turn signal switch ❶ is fitted on the left side of the handlebar.

### Possible states

	Turn signal off
	Turn signal, left, on – Turn signal switch pressed to the left. The turn signal switch returns automatically to the central position after use.
	Turn signal, right, on – Turn signal switch pressed to the right. The turn signal switch returns automatically to the central position after use.

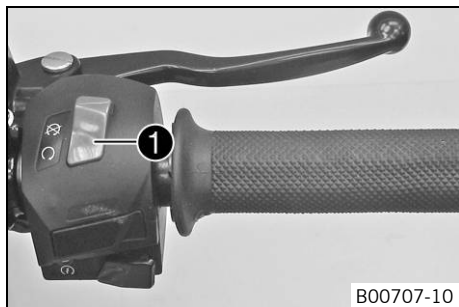

To switch off the turn signal, press the turn signal switch towards the switch case.

## 6.8 Emergency OFF switch



The emergency OFF switch ❶ is fitted on the right side of the handlebar.

### Possible states

	Emergency OFF switch off – In this position, the ignition circuit is interrupted, a running engine stops, and a non-running engine cannot be started.
	Emergency OFF switch on – This position is required for operation; the ignition circuit is closed.

## 6.9 Electric starter button

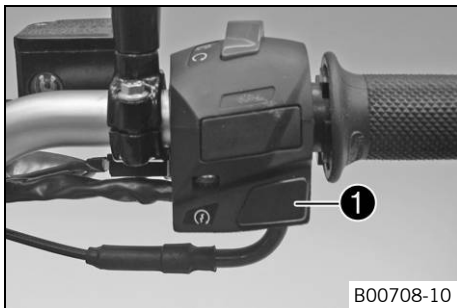

The electric starter button **1** is fitted on the right side of the handlebar.

### Possible states

- Electric starter button **1** in basic position
- Electric starter button **1** pressed – In this position, the electric starter is actuated.

## 6.10 Ignition/steering lock

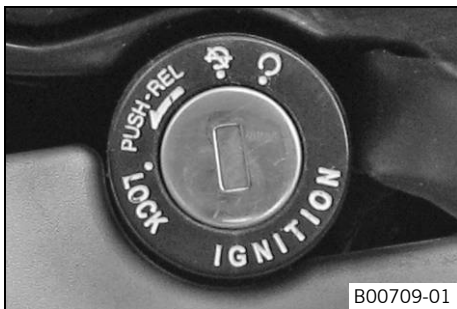

The ignition/steering lock is in front of the upper triple clamp.

### Possible states

	Ignition <b>OFF</b> – In this position, the ignition circuit is interrupted, a running engine stops, and a non-running engine will not start. The ignition key can be removed.
	Ignition <b>ON</b> – In this position, the ignition circuit is closed and the engine can be started.
<b>LOCK</b>	Steering locked – In this position, the ignition circuit is interrupted and the steering locked. The ignition key can be removed.

## 6.11 Combination instrument

### 6.11.1 Overview

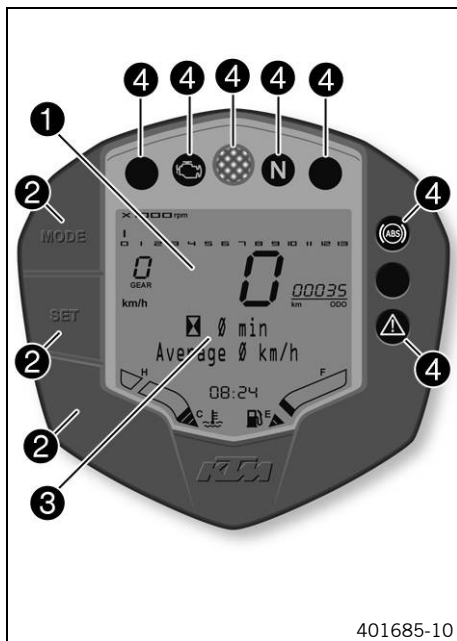

401685-10

- |   |                            |
|---|----------------------------|
| 1 | Display (☛ p. 34)          |
| 2 | Function buttons (☛ p. 32) |
| 3 | Info display (☛ p. 38)     |
| 4 | Indicator lamps (☛ p. 33)  |

## 6.11.2 Activation and test



401686-01

### Activation

The combination instrument is activated when the ignition is switched on.

### Test

The segments of the tachometer and the gear display light up and switch off in sequence.

The speed display counts from 0 to 199 and back.

The remaining display segments outside the info display light up briefly.

The **READY TO RACE >>** logo appears on the info display.

The display then changes to the last selected mode.

## 6.11.3 Warning notes

**Low Oil Pressure** appears on the info display if the oil pressure is too low.

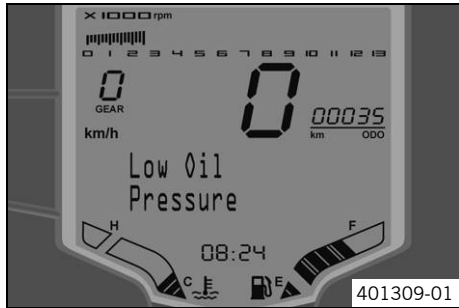

**Low Fuel Level** appears on the info display if the fuel level reaches the reserve mark.

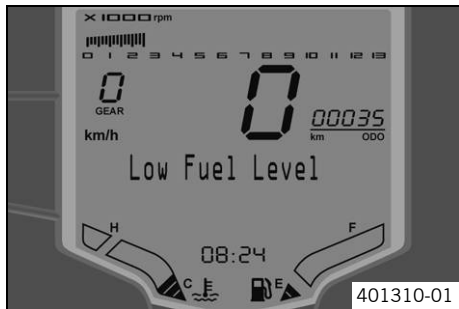

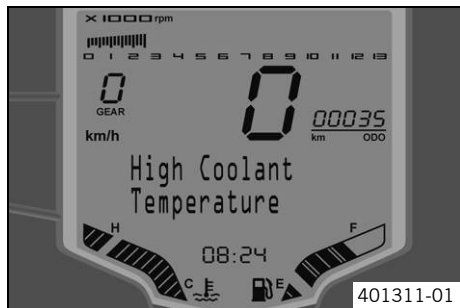

**High Coolant Temperature** appears on the info display if the coolant temperature rises above the specified value.

Coolant temperature	125 °C (257 °F)
---------------------	-----------------

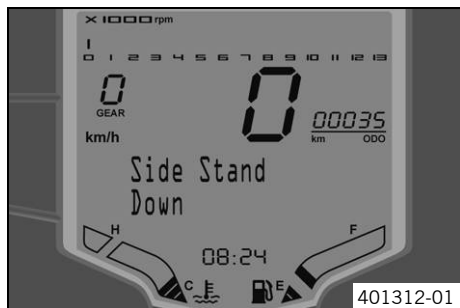

**Side Stand Down** appears on the info display if the side stand is folded down.



**Low Battery** appears on the info display if the battery voltage falls below the specified value.

Battery voltage	10.80 V
-----------------	---------



# 6 CONTROLS

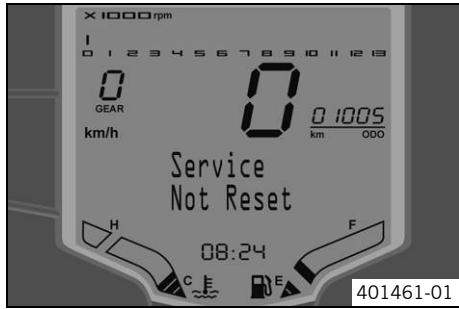

**Service Not Reset** appears on the info display for 10 seconds when the ignition is switched on and the distance interval between service appointments has been exceeded or the service interval display was not reset during a service appointment.

## 6.11.4 Function buttons



401685-12

You can change the display mode with the **MODE** button **1**.

Possible display modes are total distance traveled (**TRIP 1**), distance 1 (**ODO**) and distance 2 (**TRIP 2**).

Pressing and holding the **SET** button **2** resets the distance 1 (**TRIP 1**) and distance 2 (**TRIP 2**) functions to **0.0** and briefly pressing the **SET** button **2** changes the info display to the next display mode.

**(Option: With ABS)**

The ABS can be switched off using button **3**.







**(Option: Without ABS)**

Button **3** has no function.

## 6.11.5 Indicator lamps



### Possible states

	The turn signal indicator light flashes green simultaneously with the turn signal – The turn signal is switched on.
	The engine diagnosis warning lamp ( <b>MIL</b> ) lights up red – The OBD (on-board diagnosis) has detected an emission- or safety-critical error.
	The shift warning lights up/flashes red – The set shift speed has been reached.
	The idling speed indicator lamp lights up green – The transmission is shifted to idle.
	The high beam indicator lamp lights up blue – The high beam is switched on.
	The immobilizer indicator lamp lights up or flashes red – Status or error message for immobilizer/alarm system. (OPTIONAL)
	The general warning lamp lights up yellow – An operating safety (warning) message was detected. This is also shown in the info display.

### (Option: With ABS)

	ABS warning lamp lights up/flashes yellow – Status or error messages relating to ABS (antilock brake system).
---	---

## 6.11.6 Display

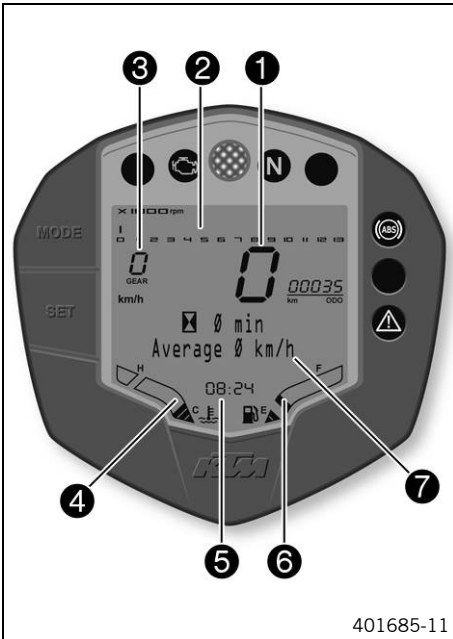

The speed **1** is shown in kilometers per hour **km/h** or in miles per hour **mph**.

The tachometer **2** shows the engine speed in revolutions per minute.

The gear display **3** shows the engaged gear.

The coolant temperature appears in segment **4**.

The time appears in segment **5**.

The filling level in the fuel tank is displaced in segment **6**.

The info display **7** shows additional information.



### Info

After reconnecting the battery or changing the fuse, the time must be reset.

The intensity of the LED display depends on the ambient brightness.

## 6.11.7 Filling level display in fuel tank



The filling level display consists of 9 bars. The more bars are lit, the more fuel is in the fuel tank.

## 6.11.8 TRIP F display



If the fuel level drops to the reserve mark, the display mode automatically changes to **TRIP F** and starts to count from **0.0**, regardless of the previous display mode.



### Info

At the same time as the display mode **TRIP F**, the general warning lamp  lights up and the warning note **Low Fuel Level** appears on the info display.

## 6.11.9 Coolant temperature indicator



The temperature display consists of 13 bars. The more bars that light up, the hotter the coolant. When all bars light up, the following warning note appears on the info display:

### High Coolant Temperature.

#### Possible states

- Engine cold – Up to three bars light up.
- Engine warm – Four to ten bars light up.
- Engine hot – Eleven to thirteen bars light up.

## 6.11.10 Info display



Various warning notes appear on info display **1**.

If the general warning lamp  lights up, the corresponding warning note is shown on the info display.



## 6.11.11 Riding time/average speed menu

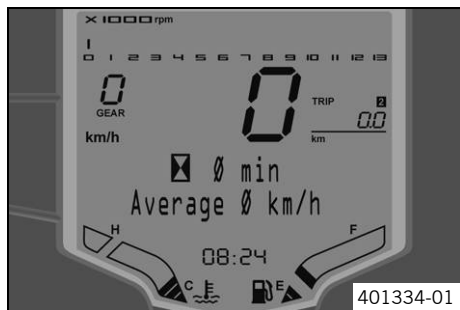

### Condition

#### Alternative 1

- The ignition is on.
- The motorcycle is stationary.

#### Alternative 2

- The ignition is on.
  - The motorcycle is moving.
- Press the **SET** button briefly and repeatedly until the desired info display appears.

The riding time and average speed are displayed in this menu.



### Info

If the ignition was switched off for over 60 minutes, the display is reset to 0.

Press the **SET** button briefly.

Next display mode on the info display

## 6.11.12 Average speed/average fuel consumption 1 menu

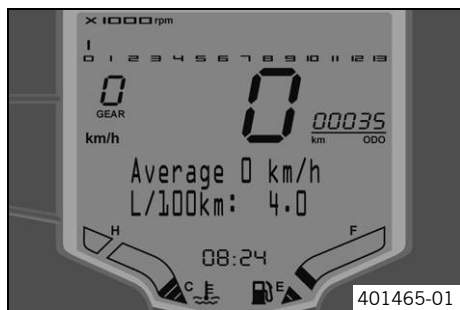

### Condition

#### Alternative 1

- The ignition is on.
- The motorcycle is stationary.

#### Alternative 2

- The ignition is on.
  - The motorcycle is moving.
- Press the **SET** button briefly and repeatedly until the desired info display appears.

In this menu, the average speed and the average fuel consumption 1 are displayed in L/100 km (or L/100 miles).



**Info**

The average fuel consumption 1 is displayed after several 100 meters of travel after the ignition is switched on.  
If the ignition was switched off for over 60 minutes, the display of the average speed and average fuel consumption 1 is reset to 0.

Press the <b>SET</b> button briefly.	Next display mode on the info display
--------------------------------------	---------------------------------------

### 6.11.13 Average fuel consumption 1/average fuel consumption 2 menu



**Condition**

**Alternative 1**

- The ignition is on.
- The motorcycle is stationary.

**Alternative 2**

- The ignition is on.
- The motorcycle is moving.
- Press the **SET** button briefly and repeatedly until the desired info display appears.

In this menu, the average fuel consumption 1 in L/100 km (or L/100 miles) and the average fuel consumption 2 in km/L (or miles/L) are displayed.



**Info**

The average fuel consumptions 1 and 2 are displayed after several 100 meters of travel after the ignition is switched on.  
If the ignition was switched off for over 60 minutes, the display of the average fuel consumption 1 and 2 is reset to 0.

Press the <b>SET</b> button briefly.	Next display mode on the info display
--------------------------------------	---------------------------------------

## 6.11.14 Average fuel consumption 2/service menu



### Condition

#### Alternative 1

- The ignition is on.
- The motorcycle is stationary.

#### Alternative 2

- The ignition is on.
  - The motorcycle is moving.
- Press the **SET** button briefly and repeatedly until the desired info display appears.

The average fuel consumption 2 in km/L (or miles/L) and the distance to the next service are displayed in this menu.



### Info

The average fuel consumption 2 is displayed after several 100 meters of travel after the ignition is switched on.

If the ignition was switched off for over 60 minutes, the display of the average fuel consumption 2 is reset to 0.

Press the **SET** button briefly.

Next display mode on the info display

## 6.11.15 Service/range menu

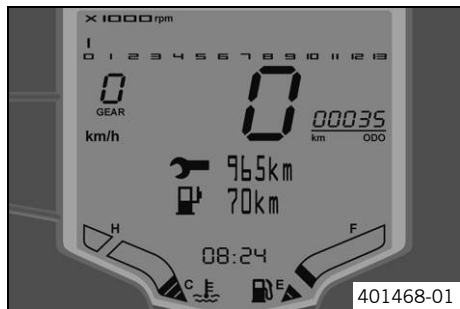

### Condition

#### Alternative 1

- The ignition is on.
- The motorcycle is stationary.

#### Alternative 2

- The ignition is on.
  - The motorcycle is moving.
- Press the **SET** button briefly and repeatedly until the desired info display appears.

This menu shows the distance to the next service and the range.



### Info

The range depends on the average fuel consumption and the fuel quantity in the fuel tank.

The range is displayed after several 100 meters of travel after the ignition is switched on.

If the ignition was switched off for over 60 minutes, the display of the range and riding time is reset to 0.

Press the **SET** button briefly.

Next display mode on the info display

## 6.11.16 Range/riding time menu



### Condition

#### Alternative 1

- The ignition is on.
- The motorcycle is stationary.

#### Alternative 2

- The ignition is on.
  - The motorcycle is moving.
- Press the **SET** button briefly and repeatedly until the desired info display appears.

The range and the riding time are displayed in this menu.



### Info

The range depends on the average fuel consumption and the fuel quantity in the fuel tank.

The range is displayed after several 100 meters of travel after the ignition is switched on.

If the ignition was switched off for over 60 minutes, the display of the range and riding time is reset to 0.

Press the **SET** button briefly.

Next display mode on the info display

## 6.11.17 Total distance menu ODO

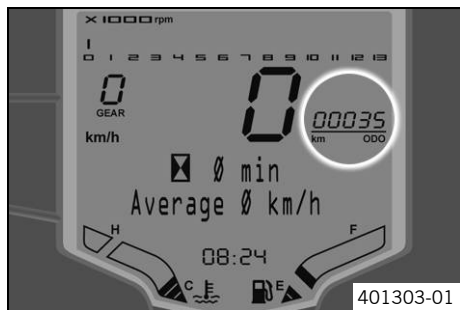

### Condition

#### Alternative 1

- The ignition is on.
- The motorcycle is stationary.

#### Alternative 2

- The ignition is on.
  - The motorcycle is moving.
- Press the **MODE** button briefly and repeatedly until **ODO** appears on the display.

**ODO** shows the total distance covered.



### Info

This value is retained, even if the battery is disconnected and/or the fuse blows.

Press the **MODE** button.

Next display mode on the display

## 6.11.18 Distance menu 1 TRIP 1

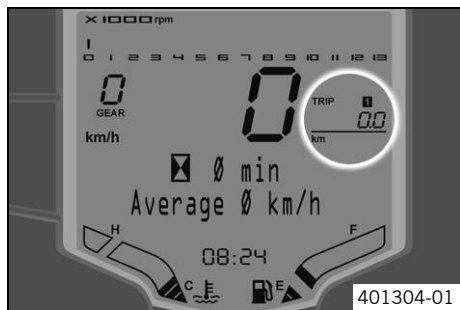

### Condition

#### Alternative 1

- The ignition is on.
- The motorcycle is stationary.

#### Alternative 2

- The ignition is on.
  - The motorcycle is moving.
- Press the **MODE** button briefly and repeatedly until **TRIP 1** appears on the display.

**TRIP 1** shows the distance covered since the last reset. For example, the distance from one refueling stop to the next. **TRIP 1** is always running and counts up to **999.9**.

Press the <b>SET</b> button for 5 - 10 seconds.	Display of <b>TRIP 1</b> is reset
Press the <b>MODE</b> button.	Next display mode on the display

## 6.11.19 Distance menu 2 TRIP 2

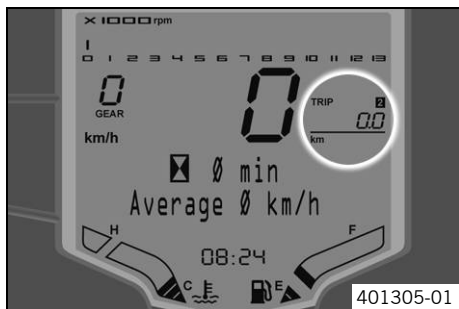

### Condition

#### Alternative 1

- The ignition is on.
- The motorcycle is stationary.

#### Alternative 2

- The ignition is on.
  - The motorcycle is moving.
- Press the **MODE** button briefly and repeatedly until **TRIP 2** appears on the display.

**TRIP 2** shows the distance covered since the last reset. For example, the distance from one refueling stop to the next. **TRIP 2** is always running and counts up to **999.9**.

Press the <b>SET</b> button for 5 - 10 seconds.	Display of <b>TRIP 2</b> is reset
Press the <b>MODE</b> button.	Next display mode on the display

## 6.11.20 Setting kilometers or miles



### Info

Make the country-specific setting.

### Condition

The ignition is on.



The motorcycle is stationary.

- Press the **MODE** button briefly and repeatedly until **ODO** appears on the display.
- Press the **MODE** button for 5 - 10 seconds.
- ✓ The display changes from **km/h** to **mph** or from **mph** to **km/h**.

## 6.11.21 Setting the time

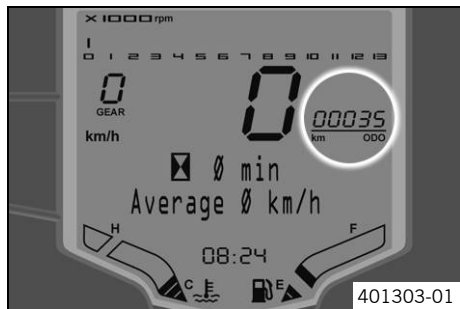

### Condition

The ignition is on.

The motorcycle is stationary.

- Press the **MODE** button briefly and repeatedly until **ODO** appears on the display.
- Press the **MODE** and **SET** buttons for 5 - 10 seconds.
- ✓ The time display begins to flash.
- Set the hours display using the **MODE** button.
- Set the minutes display using the **SET** button.
- Press the **MODE** and **SET** buttons for 5 - 10 seconds.
- ✓ The time is set.



## 6.11.22 Adjusting the shift speed RPM 1

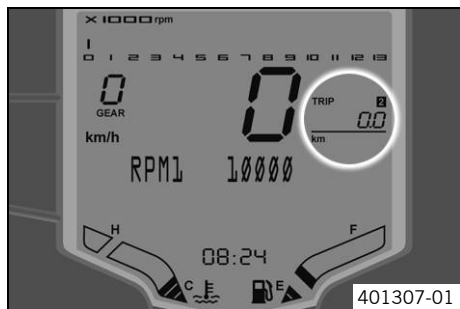

### Condition

The ignition is on.

The motorcycle is stationary.

- Press the **MODE** button briefly and repeatedly until **TRIP 2** appears on the display.
- Press the **MODE** button for 5 - 10 seconds.
- ✓ The display **RPM 1** appears.

### Info

The engine speed can be set at intervals of 50.

**RPM 1** is the engine speed above which the shift warning light starts to flash.

- Set the speed with the **MODE** and **SET** buttons.

### Info

The **MODE** button increases the value.

The **SET** button decreases the value.

- Do not activate the two buttons for approx. 15 seconds.
- ✓ The display **RPM 1** goes out and the set speed is stored.

## 6.11.23 Adjusting the shift speed RPM 2

### Condition

The ignition is on.

The motorcycle is stationary.

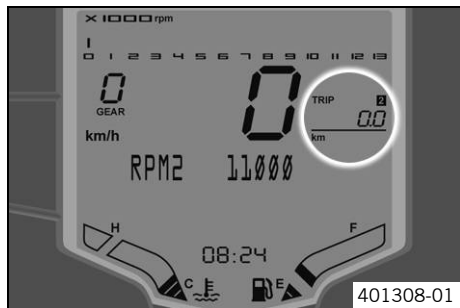

- Press the **MODE** button briefly and repeatedly until **TRIP 2** appears on the display.
- Press the **SET** button for 5 - 10 seconds.
- ✓ The display **RPM 2** appears.

### Info

The engine speed can be set at intervals of 50.

**RPM 2** is the engine speed above which the shift warning light lights up constantly.

The speed **RPM 2** must always be higher than the speed **RPM 1**.

- Set the speed with the **MODE** and **SET** buttons.

### Info

The **MODE** button increases the value.

The **SET** button decreases the value.

- Do not activate the two buttons for approx. 15 seconds.
- ✓ The display **RPM 2** goes out and the set speed is stored.

## 6.12 Opening the filler cap

### Danger

**Fire hazard** Fuel is highly flammable.

- Never refuel the vehicle near open flames or burning cigarettes, and always switch off the engine first. Be careful that no fuel is spilled, especially on hot vehicle components. Clean up spilt fuel immediately.
- The fuel in the fuel tank expands when warm and may emerge if overfilled. Follow the instructions on refueling.



## Warning

**Danger of poisoning** Fuel is poisonous and a health hazard.

- Fuel must not come into contact with the skin, eyes, or clothing. Do not breathe in the fuel vapors. If contact occurs with the eyes, rinse with water immediately and contact a physician. Immediately clean contaminated areas on the skin with soap and water. If fuel is swallowed, contact a physician immediately. Change clothing that is contaminated with fuel. Store fuel properly in a suitable canister and keep away from children.



## Warning

**Environmental hazard** Improper handling of fuel is a danger to the environment.

- Do not allow fuel to get into the ground water, the ground, or the sewage system.

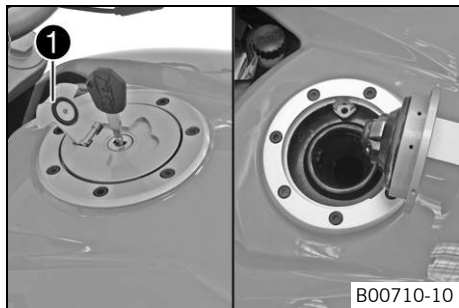

- Lift the cover **1** of the filler cap and insert the ignition key in the lock.

---

### Note

**Danger of damage** Ignition key breakage.

- To take pressure off of the ignition key, push down on the filler cap. Damaged ignition keys must be replaced.
- 
- Turn the ignition key 90° clockwise.
  - Open the filler cap.
  - Remove the ignition key.

## 6.13 Closing the filler cap

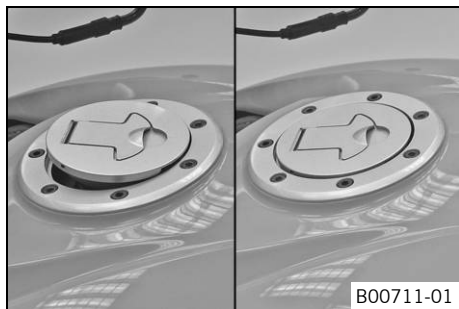

### Warning

**Fire hazard** Fuel is highly flammable, poisonous and harmful to your health.

- After closing the filler cap, ensure that it is locked properly. Change clothing that has been contaminated with fuel. Immediately clean contaminated areas on the skin with soap and water.
- 
- Close the filler cap.
  - Push down the filler cap until the lock engages.

## 6.14 Seat lock



The seat lock **1** is located to the left of the seat.  
It can be locked with the ignition key.

## 6.15 Tool set



The tool set **1** is located under the passenger seat.

## 6.16 Grab handles

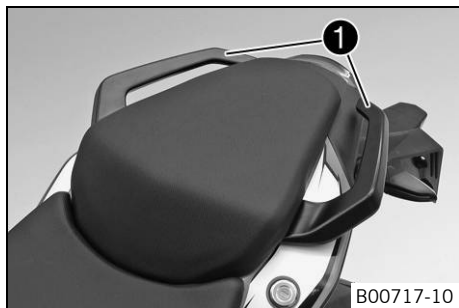

The grab handles **1** are used for moving the motorcycle around.  
If you carry a passenger, the passenger can hold onto the grab handles during the trip.

## 6.17 Passenger footrests

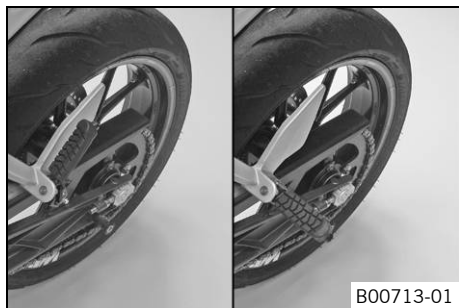

The passenger footrests can be folded in and out.

### Possible states

- Passenger footrests folded up – For operation without a passenger.
- Passenger footrests folded down – For operation with a passenger.

## 6.18 Shift lever

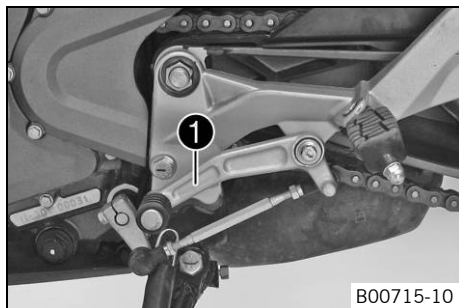

Shift lever ❶ is mounted on the left side of the engine.

## 6 CONTROLS

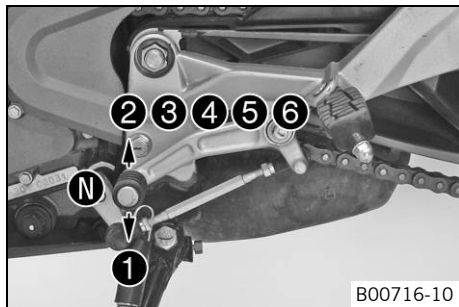

The gear positions can be seen in the photograph.  
The neutral or idle position is between the first and second gears.

### 6.19 Foot brake lever

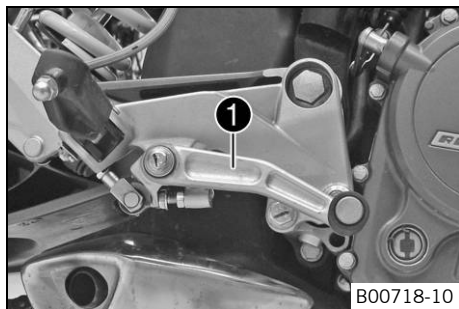

Foot brake lever ① is located in front of the right footrest.  
The foot brake lever is used to activate the rear brake.

## 6.20 Side stand

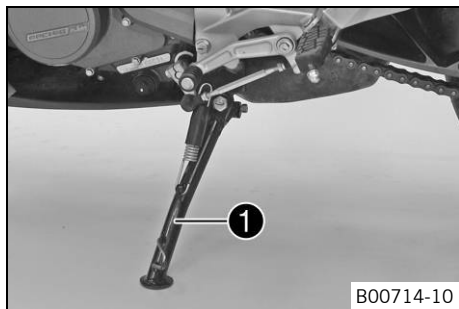

The side stand **1** is on the left side of the vehicle.  
The side stand is used to park the motorcycle.



### Info

The side stand must be folded up during motorcycle use.  
Side stand is coupled with the safety start system; see the riding instructions.

### Possible states

- Side stand folded out – The vehicle can be leaned on the side stand. The safety start system is active.
- Side stand folded in – This position is mandatory for all trips. The safety start system is inactive.



## 7.1 Advice on first use



### **Danger**

**Danger of accidents** Danger arising from the rider's judgement being impaired.

- Do not operate the vehicle while under the influence of alcohol, drugs and certain medications or physically or mentally impaired.



### **Warning**

**Risk of injury** Missing or poor protective clothing presents an increased safety risk.

- Wear protective clothing (helmet, boots, gloves, pants and jacket with protectors) every time you ride the vehicle. Always wear protective clothing that is in good condition and meets the legal requirements.



### **Warning**

**Danger of crashing** Poor vehicle handling due to different tire tread patterns on front and rear wheels.

- The front and rear wheels must be fitted with tires with similar tread patterns to prevent loss of control over the vehicle.



### **Warning**

**Danger of accidents** Uncontrollable handling characteristic due to non-approved and/or non-recommended tires/wheels.

- Only tires/wheels approved by KTM and with the corresponding speed index should be used.



### **Warning**

**Danger of accidents** Reduced road grip with new tires.

- New tires have a smooth rolling surface and therefore cannot provide full road grip. The entire rolling surface must be roughened in the first 200 kilometers (124.3 miles) by moderate riding at alternating angles. The full grip levels are not achieved until the tires have been run in.



### **Info**

When using your vehicle, remember that others may feel disturbed by excessive noise.

- Make sure that the pre-delivery inspection work has been carried out by an authorized KTM workshop.
  - ✓ You receive a delivery certificate and the service record at vehicle handover.
- Before your first trip, read the entire operating instructions carefully.
- Get to know the controls.
- Get used to handling the motorcycle on a suitable piece of land before making a longer trip. Try also to ride as slowly as possible to get a better feel for the vehicle.
- Hold the handlebar firmly with both hands and keep your feet on the footrests when riding.
- Run the engine in. (👉 p. 56)

## 7.2 Running in the engine

- During the running-in phase, do not exceed the specified engine speed.

Guideline

Maximum engine speed	
During the first: 1,000 km (620 mi)	7,500 rpm



### Tip

During the running-in phase, set the shift warning light to the specified engine speed.

- Adjust the shift speed **RPM 1**. (👉 p. 47)
- Adjust the shift speed **RPM 2**. (👉 p. 47)
- Avoid fully opening the throttle!

## 7.3 Loading the vehicle



### Warning

**Danger of accidents** Unstable handling characteristics.

- Do not exceed the maximum permitted weight and axle loads. The overall weight consists of: motorcycle operational and with a full tank, driver and passenger with protective clothing and helmet, baggage.



### Warning

**Danger of accidents** Unstable handling characteristics due to incorrect mounting of suitcase and/or tank rucksack.

- Mount and secure suitcase and tank rucksack according to the manufacturer's instructions.



### Warning

**Danger of accidents** Risk of breakage of suitcase system.

- If you have fitted suitcases on your motorcycle, read the manufacturer's specifications concerning the maximum payload.



### Warning

**Danger of accidents** Poor visibility for other road users due to slipped baggage.

- If the tail light is covered, you are less visible to traffic behind you, especially in the dark. Check that your baggage is fixed properly at regular intervals.



### Warning

**Danger of accidents** Changed handling characteristics and longer stopping distance with excessive payload.

- Adapt your speed according to your payload.



### Warning

**Danger of accidents** Unstable handling characteristics due to slipped baggage.

- Check the way your baggage is fixed regularly.

# 7 PREPARING FOR USE

- If you carry any baggage, make sure it is fixed firmly as close as possible to the center of the vehicle and ensure even weight distribution between the front and rear wheels.
- Do not exceed the overall maximum permitted weight and the axle loads.

### Guideline

Maximum permissible overall weight	335 kg (739 lb.)
Maximum permissible front axle load	125 kg (276 lb.)
Maximum permissible rear axle load	210 kg (463 lb.)

## 8.1 Checks and maintenance when preparing for use



### Info

Before every trip, check the condition of the vehicle and ensure that it is roadworthy. The vehicle must be in perfect technical condition when used.

- Check the engine oil level. (☞ p. 154)
- Check the brake fluid level of the front brake. (☞ p. 98)
- Check the rear brake fluid level. (☞ p. 103)
- Check the front brake linings. (☞ p. 100)
- Check the rear brake linings. (☞ p. 106)
- Check the brake system function.
- Check the coolant level. (☞ p. 145)
- Check for chain dirt accumulation. (☞ p. 81)
- Check the chain tension. (☞ p. 82)
- Check the tire condition. (☞ p. 118)
- Check the tire air pressure. (☞ p. 119)
- Check the settings of all controls and ensure that they can be operated smoothly.
- Check the functioning of the electrical equipment.
- Check that baggage is correctly secured.
- Sit on the motorcycle and check the rear mirror setting.
- Check the fuel level.

## 8.2 Starting

 **Danger**  
**Danger of poisoning** Exhaust gases are toxic and inhaling them may result in unconsciousness and/or death.

- When running the engine, always make sure there is sufficient ventilation, and do not start or run the engine in an enclosed space without an effective exhaust extraction system.

 **Caution**  
**Danger of accidents** If the vehicle is operated with a discharged battery or without a battery, electronic components and safety equipment may be damaged.

- Never operate the vehicle with a discharged battery or without a battery.

### Note

**Engine failure** Unfiltered intake air has a negative effect on the service life of the engine.



- Never operate the vehicle without an air filter as dust and dirt will enter the engine and lead to increased wear.

### Note

**Engine failure** High engine speeds in cold engines have a negative effect on the service life of the engine.

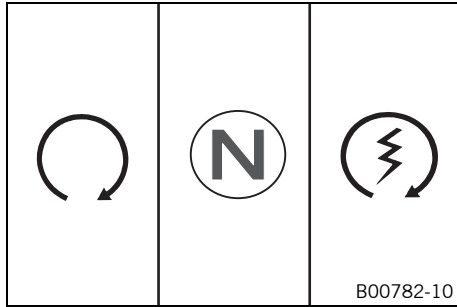
- Always warm up the engine at low engine speeds.
-



- Sit on the vehicle, take the weight off of the side stand, and move up all the way.
- Turn the emergency OFF switch to the position .
- Switch on the ignition by turning the ignition key to the position .
- ✓ After you switch on the ignition, you can hear the fuel pump working for about two seconds. The function check of the combination instrument is run at the same time.
- Shift gear to neutral.
- ✓ The green idling speed indicator lamp **N** lights up.
- (Option: With ABS)**
- ✓ The ABS warning lamp lights up and goes back out after starting off.
- Press the electric starter button .

## Info

Do not press the electric starter button until the combination instrument function check is finished.

When starting, **DO NOT** open the throttle. If you open the throttle during the starting procedure, fuel is not injected by the engine management system and the engine cannot start.

Press the starter for a maximum of 5 seconds. Wait for a least 5 seconds before trying again.

This motorcycle is equipped with a safety starting system. You can only start the engine if the transmission is in neutral or if the clutch is pulled when a gear is engaged. If the side stand is folded out and you shift into gear and release the clutch, the engine stops.

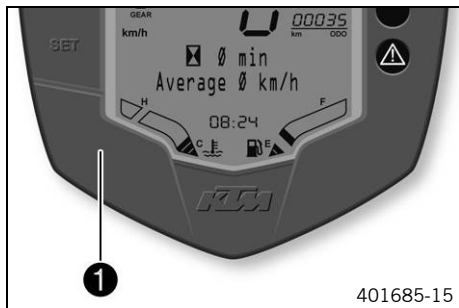

## Switching off ABS (Option: With ABS)

KTM recommends riding with ABS at all times. However, situations may arise in which ABS is not advantageous.

### Condition

Vehicle stationary, engine running.

- Press the **1** button for 3 – 5 seconds.
- ✓ The ABS warning lamp starts flashing; ABS is deactivated.

## 8.3 Starting off

- Pull the clutch lever, engage 1st gear, release the clutch lever slowly, and simultaneously open the throttle carefully.

### Tip

If the engine dies while starting off, only pull the clutch lever and press the electric starter button. You do not need to shift into neutral.

## 8.4 Shifting, riding



### Warning

**Danger of accidents** Abrupt load alterations can cause the vehicle to get out of control.

- Avoid abrupt load alterations and sudden braking actions, and adapt your speed to the road conditions.



### Warning

**Danger of accidents** If you change down at high engine speed, the rear wheel can lock up.

- Do not change into a low gear at high engine speed. The engine races and the rear wheel can lock up.





## Warning

**Danger of accidents** Malfunctions caused by incorrect ignition key position.

- Do not change the ignition key position during a journey.



## Warning

**Danger of accidents** Distraction from traffic activity by adjustments to the vehicle.

- Make all adjustments when the vehicle is at a standstill.



## Warning

**Risk of injury** Falling off of the passenger.

- The passenger must be seated properly on the passenger seat and hold on to the front rider or the grab handles. The feet must be positioned on the passenger footrests. Note the regulations governing the minimum age of passengers.



## Warning

**Danger of accidents** Danger of accidents caused by dangerous driving.

- Comply with traffic regulations and ride defensively and foresightedly to detect sources of danger early on.



## Warning

**Danger of accidents** Reduced road grip with cold tires.

- On every journey, take the first miles carefully at moderate speed until the tires reach operating temperature and optimal road grip is ensured.



## Warning

**Danger of accidents** Reduced road grip with new tires.

- New tires have a smooth rolling surface and therefore cannot provide full road grip. The entire rolling surface must be roughened in the first 200 kilometers (124.3 miles) by moderate riding at alternating angles. The full grip levels are not achieved until the tires have been run in.



## Warning

**Danger of accidents** Unstable handling characteristics due to slipped baggage.

- Check the way your baggage is fixed regularly.



## Warning

**Danger of accidents** Lack of roadworthiness.

- After a fall, check the vehicle as usual before preparing for use.

## Note

**Engine failure** Overheating of engine.

- If the coolant temperature warning lamp lights up, stop and switch off the engine. Allow the engine to cool down and check the coolant level in the radiator, and top up if necessary. If you continue with the coolant temperature warning lamp alight, you may have engine failure.



## Info

If you hear unusual noises while riding, stop immediately, switch off the engine and contact an authorized KTM workshop.

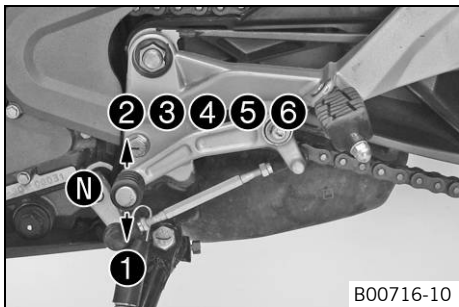

- When conditions allow (incline, road situation, etc.), you can shift into a higher gear.
- Release the throttle while simultaneously pulling the clutch lever, shift into the next gear, release the clutch and open the throttle.



## Info

You can see the positions of the 6 forward gears in the figure. The neutral or idle position is between the first and second gears. First gear is used for starting off or for steep inclines.

The operating temperature is reached when 4 bars of the temperature indicator light up.

- Accelerate only up to a speed suitable for the road surface and weather conditions. Particularly in bends, do not shift, and accelerate very carefully.
- To shift down, brake if necessary and close the throttle at the same time.
- Pull the clutch lever and shift into a lower gear, release the clutch lever slowly and open the throttle or shift again.
- Switch off the engine if you expect to be standing for a long time.
- If the engine diagnosis warning lamp  lights up during a trip, stop immediately, switch off the engine, and contact an authorized KTM workshop.

## 8.5 Applying the brakes



### Warning

**Danger of accidents** Reduced braking efficiency due to a wet or dirty brake system.

- Clean or dry a dirty or wet brake system by riding and braking gently.



### Warning

**Danger of accidents** Reduced braking efficiency caused by spongy pressure point of front or rear brake.

- Check the brake system and do not continue riding. (Your authorized KTM workshop will be glad to help.)



### Warning

**Danger of accidents** Failure of brake system.

- If the foot brake lever is not released, the brake linings drag continuously. The rear brake may fail due to overheating. Take your foot off the foot brake lever when you are not braking.



### Warning

**Danger of accidents** Longer stopping distance due to higher overall weight.

- Take the longer stopping distance into account when carrying a passenger and baggage.



## Warning

**Danger of accidents** Delayed brake action on salted roads.

- There may be salt deposits on the brake discs. In order to restore the normal braking efficiency, you will need to remove the deposits from the discs by carefully applying the brakes.
- 

### (Option: With ABS)

---



## Warning

**Danger of accidents** Greater stopping distance due to ABS.

- Braking should be appropriate to the driving situation and the road conditions.



## Warning

**Danger of accidents** Excessively forceful braking can cause the wheels to block.

- ABS must be switched on to be effective.
- 

- When braking, release the throttle and apply the front and rear brakes at the same time.
- 



## Info

When ABS is active, you can achieve maximum braking power even on low grip surfaces such as sandy, wet, or slippery terrain without locking of the wheels.

---



## Warning

**Danger of accidents** Locking of the wheels due to braking action of the engine.

- Pull the clutch during emergency braking, full brake application and when braking on a slippery surface.



## Warning

**Danger of accidents** Road grip is reduced when braking with the motorcycle at an angle or on a laterally inclined surface.

- Braking should be completed before you enter into a bend.
- 

- Braking should always be completed before you go into a bend. Change down to a lower gear appropriate to your road speed.

- On long downhill stretches, use the braking effect of the engine. Change down one or two gears, but do not over rev the engine. In this way, you have to brake far less and the brakes do not overheat.

**(Option: Without ABS)**



**Warning**

**Danger of accidents** If you brake too hard, the wheels can lock.

- Adapt your braking to the traffic situation and the road conditions.

- 
- When braking, release the throttle and apply the front and rear brakes at the same time.
  - On sandy, wet, or slippery surfaces, use the rear brake.
  - Braking should always be completed before you go into a bend. Change down to a lower gear appropriate to your road speed.
  - On long downhill stretches, use the braking effect of the engine. Change down one or two gears, but do not over rev the engine. In this way, you have to brake far less and the brakes do not overheat.

## 8.6 Stopping, parking



**Warning**

**Risk of misappropriation** Usage by unauthorized persons.

- Never leave the vehicle while the engine is running. Secure the vehicle against use by unauthorized persons. If you leave the vehicle, lock the steering and remove the ignition key.



**Warning**

**Danger of burns** Some vehicle components become very hot when the vehicle is operated.

- Do not touch hot components such as exhaust system, radiator, engine, shock absorber, and the brake system. Allow these components to cool down before starting work on them.

**Note**

**Danger of damage** The parked vehicle may roll away or fall over.

- Always place the vehicle on a firm and even surface.

## Note

**Fire hazard** Some vehicle components become very hot when the vehicle is operated.

- Do not park the vehicle near flammable or explosive substances. Do not place objects on the vehicle while it is still warm from being run. Always let the vehicle cool first.

## Note

**Material damage** Damage to or destruction of components due to excessive load.

- The side stand is only designed for the weight of the motorcycle. Do not sit on the motorcycle when it is resting on the side stand. The side stand or the frame may become damaged and the motorcycle may fall over.

- 
- Brake the motorcycle.
  - Shift gear to neutral.
  - Switch off the ignition by turning the ignition key to the position ☒.



## Info

If the engine is switched off with the emergency OFF switch and the ignition remains switched on at the ignition lock, power continues to flow to most power consumers and the battery will discharge. You should therefore always switch off the engine with the ignition key - the emergency OFF switch is intended for emergencies only.

- 
- Park the motorcycle on a firm surface.
  - Swing the side stand forward with your foot as far as it will go and lean the vehicle on it.
  - Lock the steering by turning the handlebar fully to the left, pressing down the ignition key to position ☒ and turning it to position LOCK. To make the steering lock engage more easily, move the handlebar a little to the left and right. Remove the ignition key.

## 8.7 Transport

## Note

**Danger of damage** The parked vehicle may roll away or fall over.

- Always place the vehicle on a firm and even surface.

## Note

**Fire hazard** Some vehicle components become very hot when the vehicle is operated.

- Do not park the vehicle near flammable or explosive substances. Do not place objects on the vehicle while it is still warm from being run. Always let the vehicle cool first.

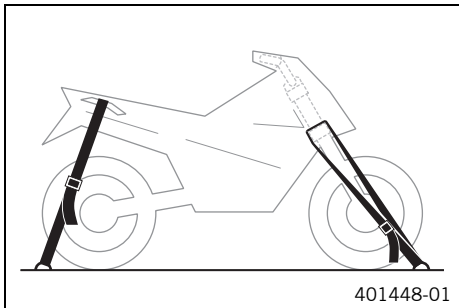

- Switch off the engine and remove the ignition key.
- Use tension belts or other suitable devices to secure the motorcycle against accidents or falling over.

## 8.8 Refueling



### Danger

**Fire hazard** Fuel is highly flammable.

- Never refuel the vehicle near open flames or burning cigarettes, and always switch off the engine first. Be careful that no fuel is spilt, especially on hot vehicle components. Clean up spilt fuel immediately.
- The fuel in the fuel tank expands when warm and may emerge if overfilled. Follow the instructions on refueling.



### Warning

**Danger of poisoning** Fuel is poisonous and a health hazard.

- Fuel must not come into contact with the skin, eyes, or clothing. Do not breathe in the fuel vapors. If contact occurs with the eyes, rinse with water immediately and contact a physician. Immediately clean contaminated areas on the skin with soap and water. If fuel is swallowed, contact a physician immediately. Change clothing that is contaminated with fuel.

## Note

**Material damage** Premature clogging of the fuel filter.

- In some countries and regions, the available fuel quality and cleanliness may not be sufficient. This will result in problems with the fuel system. (Your authorized KTM workshop will be glad to help.)
- Only refuel with clean fuel that meets the specified standards.



## Warning

**Environmental hazard** Improper handling of fuel is a danger to the environment.

- Do not allow fuel to get into the ground water, the ground, or the sewage system.

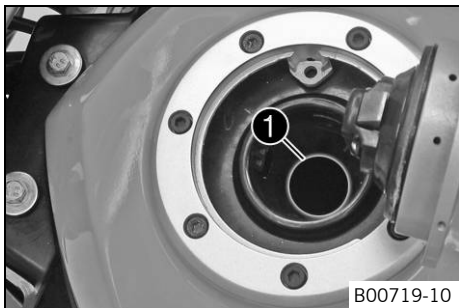

- Switch off the engine.
- Open the filler cap. (☛ p. 48)
- Fill the fuel tank with fuel up to the lower edge **1** of the fuel filler.

Total fuel tank capacity, approx.	10.5 l (2.77 US gal)	Super unleaded (ROZ 95/RON 95/PON 91) (☛ p. 183)
-----------------------------------	-------------------------	--











- Close the filler cap. (☛ p. 50)



## 9.1 Service schedule

	Every 15,000 km (9,321 mi) or every 2 years	Every 7,500 km (4,660 mi) or annually	Once after 1,000 km (621.4 mi)
Check the functioning of the electrical equipment.	○	●	●
Read out the fault memory using the KTM diagnostics tool. 🛠️	○	●	●
Change the engine oil and oil filter, clean the oil screen. 🛠️ (📖 p. 154)	○	●	●
Check the front brake linings. (📖 p. 100)	○	●	●
Check the rear brake linings. (📖 p. 106)	○	●	●
Check the brake discs. (📖 p. 97)	○	●	●
Check the brake lines for damage and leakage.	○	●	●
Check the rear brake fluid level. (📖 p. 103)	○	●	●
Check the shock absorber and fork for leaks.	○	●	●
Check the swingarm bearing. 🛠️		●	●
Check the wheel bearing for play. 🛠️		●	●
Check the tire condition. (📖 p. 118)	○	●	●
Check the tire air pressure. (📖 p. 119)	○	●	●
Check the chain, rear sprocket, and engine sprocket. (📖 p. 87)		●	●
Check the chain tension. (📖 p. 82)	○	●	●
Grease all moving parts (e.g. side stand, hand lever, chain, ...) and check for smooth operation. 🛠️	○	●	●
Clean the dust boots of the fork legs.		●	●
Check the brake fluid level of the front brake. (📖 p. 98)	○	●	●
Check the steering head bearing play.	○	●	●
Change the spark plugs. 🛠️			●

# 9 SERVICE SCHEDULE

	Every 15,000 km (9,321 mi) or every 2 years	Every 7,500 km (4,660 mi) or annually	Once after 1,000 km (621.4 mi)
Check the valve clearance. 	○		●
Check all hoses (e.g. fuel, cooling, bleeder, drainage, etc.) and bellows for cracking, leaks, and correct routing. 	○	●	●
Check the antifreeze and coolant level. (🔧 p. 143)	○	●	●
Check the cables for damage and routing without sharp bends. 		●	●
Check that the throttle cables are undamaged, routed without sharp bends, and set correctly. 	○	●	●
Change the air filter. Clean the air filter box. 		●	●
Check the screws and nuts for tightness. 	○	●	●
Change the front brake fluid. 			●
Change the rear brake fluid. 			●
Check the headlight setting. (🔧 p. 138)	○	●	●
Check that the radiator fan is functioning properly. 	○	●	●
Final check: Check the vehicle for roadworthiness and take a test ride.	○	●	●
Read out the fault memory using the KTM diagnostics tool after a test ride. 	○	●	●
Make the service entry in <b>KTM DEALER.NET</b> and in the service record. 	○	●	●

- One-time interval
- Periodic interval

## 10.1 Adjusting the spring preload of the shock absorber

-  **Warning**  
**Danger of accidents** Modifications to the suspension settings can seriously alter the vehicle's ride behavior.
- Following modifications, ride slowly at first to get the feel of the new ride behavior.

-  **Info**  
The spring preload defines the initial situation of the spring process on the shock absorber. The best spring preload setting is achieved when it is set for the weight of the rider and that of any baggage and a passenger, thus ensuring an ideal compromise between maneuverability and stability.

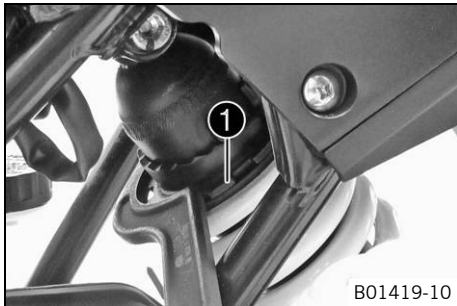

- Turn adjusting ring **1** to adjust the spring preload.

### Guideline

Spring preload	
Standard	3 clicks
Full payload	6 clicks

Hook wrench (T106S)

-  **Info**  
The spring preload can be set to 10 different positions.

## 10.2 Adjusting the shift lever

**i** **Info**

The adjustment range of the shift lever is limited.

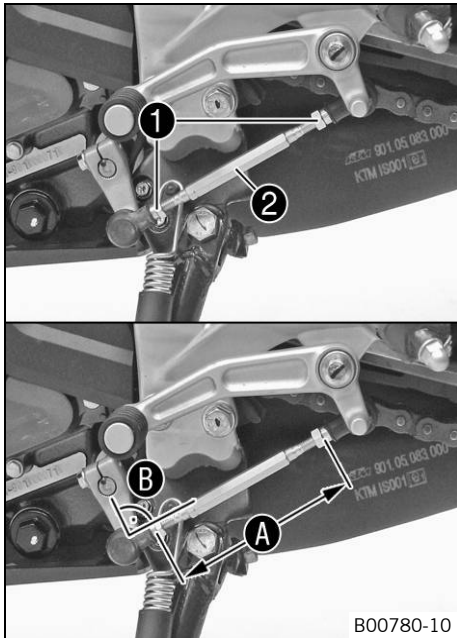

- Loosen nuts **1**.
- Adjust the shift lever by turning shift rod **2**.

**Guideline**

Shift rod adjustment range <b>A</b>	100... 112 mm (3.94... 4.41 in)
-------------------------------------	---------------------------------

**i** **Info**

Make the same adjustments on both sides.  
At least five screw threads must be screwed into the seating.

- Check adjusting angle **B**.

**Guideline**

Adjusting angle <b>B</b> shift rod, deflector, shift lever	90°
--	-----

- Tighten nuts **1**.

**i** **Info**

After the nuts have been tightened, the bearings of the shift rod must be centrally and identically aligned to each other in order to ensure freedom of movement in the bearing shells.

- Check the shift lever to ensure it is functioning properly and can move freely.

## 11.1 Raising the motorcycle with the rear wheel stand

### Note

**Danger of damage** The parked vehicle may roll away or fall over.

- Always place the vehicle on a firm and even surface.



- Mount the supports of the wheel stand.
- Insert the adapter in the rear wheel stand.

Bushing kit for lifting gear (90229955044)
--

Universal V adapter (61029955244)
-----------------------------------

Rear wheel stand (61029055400)
--------------------------------

- Stand the motorcycle upright, align the lifting gear with the swingarm and the adapters, and lift the motorcycle.

## 11.2 Taking the motorcycle off of the rear wheel stand

### Note

**Danger of damage** The parked vehicle may roll away or fall over.

- Always place the vehicle on a firm and even surface.

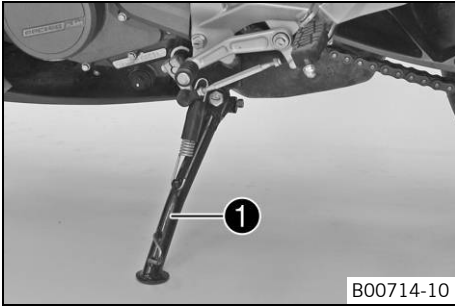

- Secure the motorcycle against falling over.
- Remove the rear wheel stand and lean the vehicle on the side stand ①.
- Remove the support of the wheel stand.

## 11.3 Raising the motorcycle with the front wheel stand

### Note

**Danger of damage** The parked vehicle may roll away or fall over.

- Always place the vehicle on a firm and even surface.

### Preparatory work

- Raise the motorcycle with the rear wheel stand. (🔧 p. 75)

### Condition

- Remove cap ①.

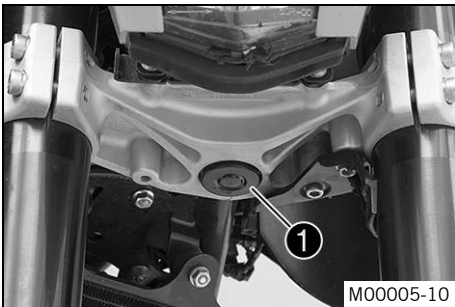

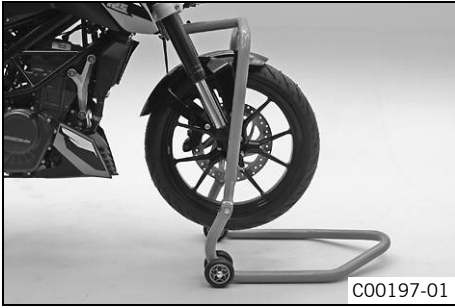

- Move the handlebar to the straight-ahead position. Attach the lifting gear to the steering stem.

Adapter (61029955620)
-----------------------

Front wheel stand (61029055500)
---------------------------------

**Info**

Always raise the rear of the motorcycle first.

- Raise the front of the motorcycle.

## 11.4 Taking the motorcycle off of the front wheel stand

**Note**

**Danger of damage** The parked vehicle may roll away or fall over.

- Always place the vehicle on a firm and even surface.



- Secure the motorcycle against falling over.
- Remove the front wheel stand.

# 11 SERVICE WORK ON THE CHASSIS

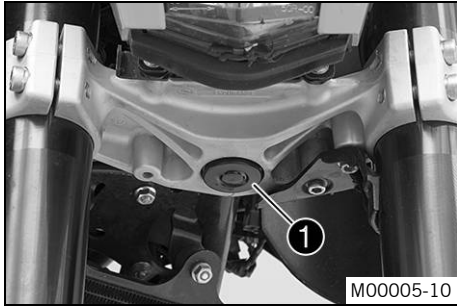

- Mount cap ①.

## 11.5 Removing the passenger seat



- Insert the ignition key in seat lock ① and turn it clockwise.
- Raise the rear of the seat, push it towards the rear, and remove it upwards.
- Remove the ignition key from the seat lock.



## 11.6 Mounting the passenger seat

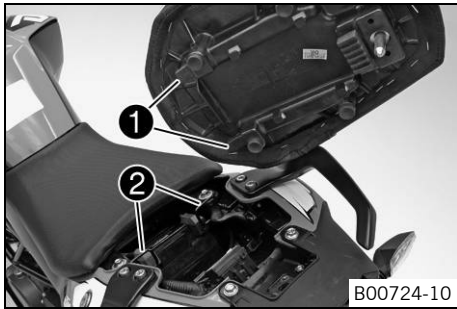

- Attach hooks **1** on the passenger seat to brackets **2** on the subframe, and lower it at the rear while pushing forward.
- Press down the passenger seat until it clicks into place.



### Warning

**Danger of accidents** The passenger seat can come loose from the anchoring if it is not mounted correctly.

- After mounting the passenger seat, check that it is locked correctly by pulling up.
- 
- Finally, check that the passenger seat is correctly mounted.

## 11.7 Removing the seat

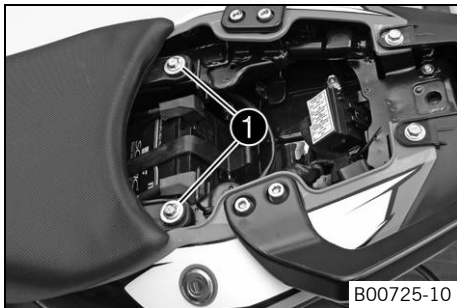

### Preparatory work

- Remove the passenger seat. (☞ p. 78)

### Main work

- Remove screws **1**.
- Raise the rear of the seat, pull it towards the rear, and remove it upwards.

## 11.8 Mounting the seat

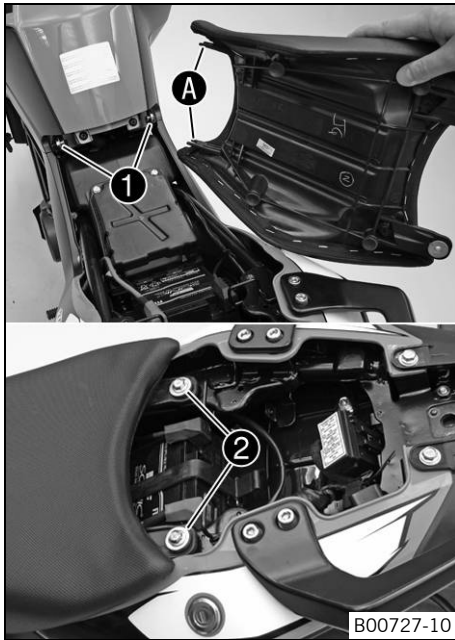

### Main work

- Attach seat recesses **A** at screws **1** and lower at the rear.
- Mount and tighten screws **2**.

### Guideline

Screw, seat	M6	11 Nm (8.1 lbf ft)
-------------	----	--------------------

### Finishing work

- Mount the passenger seat. (👉 p. 79)

## 11.9 Checking for chain dirt accumulation

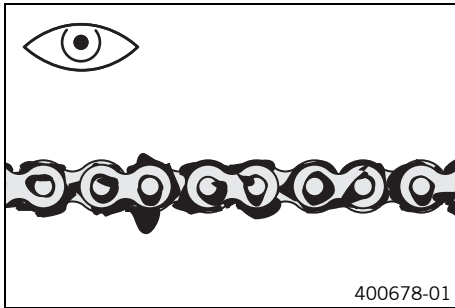

- Check the chain for coarse dirt accumulation.
  - » If the chain is very dirty:
    - Clean the chain. (☛ p. 81)

## 11.10 Cleaning the chain



### Warning

**Danger of accidents** Oil or grease on the tires reduces their grip.

- Remove oil and grease with a suitable cleaning material.



### Warning

**Danger of accidents** Reduced braking efficiency due to oil or grease on the brake discs.

- Always keep the brake discs free of oil and grease, and clean them with brake cleaner when necessary.



### Warning

**Environmental hazard** Hazardous substances cause environmental damage.

- Oil, grease, filters, fuel, cleaners, brake fluid, etc., should be disposed of as stipulated in applicable regulations.



## Info

The service life of the chain depends largely on its maintenance.

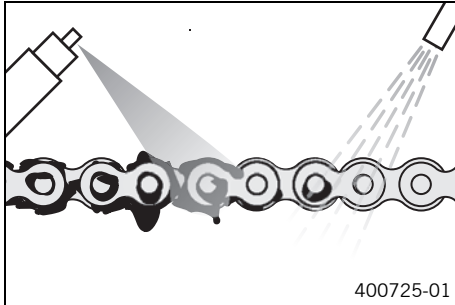

- Clean the chain regularly.
- Rinse off loose dirt with a soft jet of water.
- Remove old grease remains with chain cleaner.

Chain cleaner (☛ p. 184)

- After drying, apply chain spray.

Chain lube for road use (☛ p. 184)

## 11.11 Checking the chain tension



## Warning

**Danger of accidents** Danger caused by incorrect chain tension.

- If the chain is too taut, the components of the secondary power transmission (chain, engine sprocket, rear sprocket, bearings in the transmission and in the rear wheel) will be under additional load. In addition to premature wear, this can cause the chain or the countershaft of the transmission to break in extreme cases. If the chain is too loose, however, it may fall off the engine sprocket or rear sprocket and block the rear wheel or damage the engine. Ensure that the chain tension is correct and adjust it if necessary.

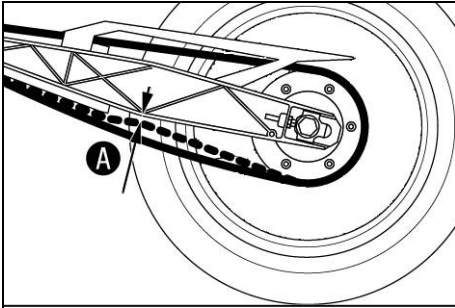

- Lean the motorcycle on the side stand.
- Shift gear to neutral.
- In the area of chain sliding guard, press the chain upward toward the swingarm and determine chain tension **A**.



### Info

The upper chain section **B** must be taut.

Chain wear is not always even, so you should repeat this measurement at different chain positions.

Chain tension	5... 7 mm (0.2... 0.28 in)
---------------	----------------------------

- » If the chain tension does not meet specifications:
  - Adjust the chain tension. (🔧 p. 84)

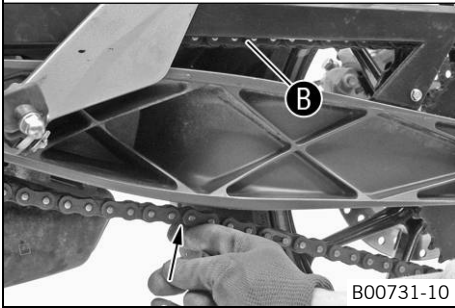

## 11.12 Adjusting the chain tension



### Warning

**Danger of accidents** Danger caused by incorrect chain tension.

- If the chain is too taut, the components of the secondary power transmission (chain, engine sprocket, rear sprocket, bearings in the transmission and in the rear wheel) will be under additional load. In addition to premature wear, this can cause the chain or the countershaft of the transmission to break in extreme cases. If the chain is too loose, however, it may fall off the engine sprocket or rear sprocket and block the rear wheel or damage the engine. Ensure that the chain tension is correct and adjust it if necessary.

### Preparatory work

- Check the chain tension. (👉 p. 82)
- Raise the motorcycle with the rear wheel stand. (👉 p. 75)

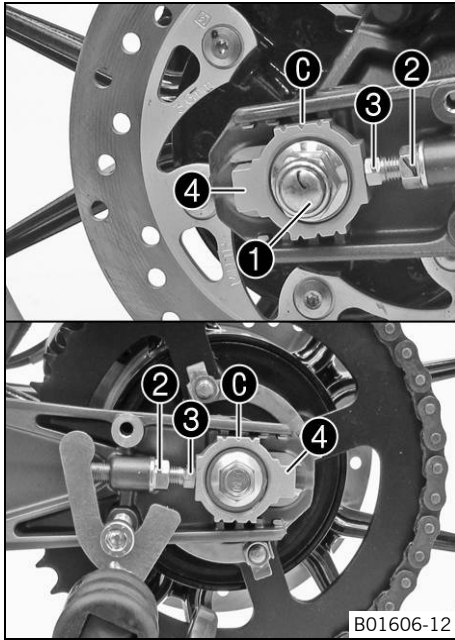

### Main work

#### (Option: Without ABS)

- Loosen nut **1**.
- Loosen nuts **2**.
- Adjust the chain tension by turning adjusting screws **3** on the left and right.

#### Guideline

Chain tension	5... 7 mm (0.2... 0.28 in)
Turn adjusting screws <b>3</b> on the left and right so that the markings on the left and right chain adjuster <b>4</b> are in the same position in relation to reference marks <b>C</b> . The rear wheel is then correctly aligned.	

#### **i** Info

The upper chain section must be taut.

Chain wear is not always even, so you should check the setting at different chain positions.

- Tighten nuts **2**.
- Make sure that chain adjusters **4** are fitted correctly on adjusting screws **3**.
- Tighten nut **1**.

#### Guideline

Nut, rear wheel spindle	M14x1.5	90 Nm (66.4 lbf ft)
-------------------------	---------	------------------------

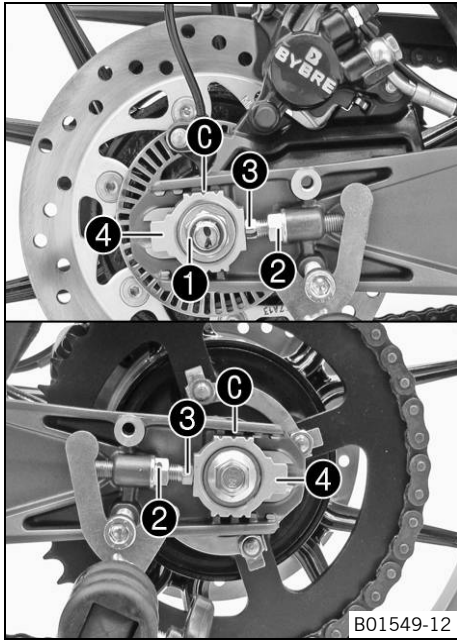

**(Option: With ABS)**

- Loosen nut **1**.
- Loosen nuts **2**.
- Adjust the chain tension by turning adjusting screws **3** on the left and right.

Guideline

Chain tension	5... 7 mm (0.2... 0.28 in)
Turn adjusting screws <b>3</b> on the left and right so that the markings on the left and right chain adjuster <b>4</b> are in the same position in relation to reference marks <b>C</b> . The rear wheel is then correctly aligned.	

**i Info**

The upper chain section must be taut.

Chain wear is not always even, so you should check the setting at different chain positions.

- Tighten nuts **2**.
- Make sure that chain adjusters **4** are fitted correctly on adjusting screws **3**.
- Tighten nut **1**.

Guideline

Nut, rear wheel spindle	M14x1.5	90 Nm (66.4 lbf ft)
-------------------------	---------	------------------------

**Finishing work**

- Take the motorcycle off of the rear wheel stand. (🔧 p. 75)



## 11.13 Checking the chain, rear sprocket, and engine sprocket

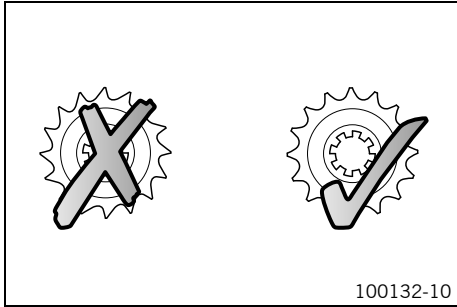

(Option: Without ABS)

- Check the rear sprocket and engine sprocket for wear.
  - » If the rear sprocket and engine sprocket are worn:
    - Change the power set. 



### Info

The engine sprocket, rear sprocket, and chain should always be replaced together.

# 11 SERVICE WORK ON THE CHASSIS

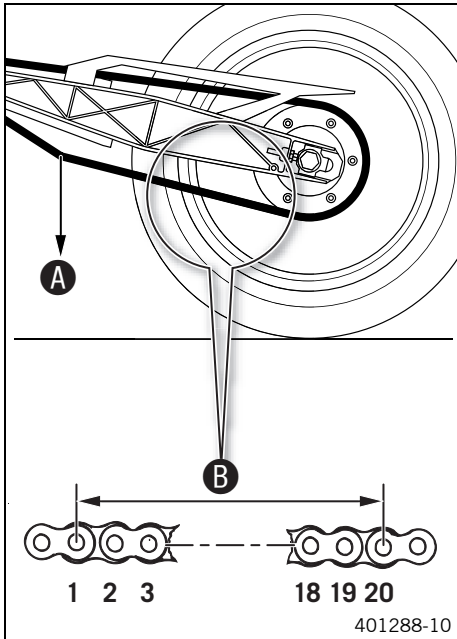

- Shift gear to neutral.
- Pull the lower chain section with specified weight **A**.

Guideline

Weight, chain wear measurement	15 kg (33 lb.)
--------------------------------	----------------

- Measure the distance **B** of 20 chain links in the lower chain section.



### Info

Chain wear is not always even, so you should repeat this measurement at different chain positions.

Maximum distance <b>B</b> at the longest chain section	301.6 mm (11.874 in)
--	----------------------

- » If the distance **B** is greater than the specified measurement:
  - Change the power set. 



### Info

When the chain is replaced, the rear sprocket and engine sprocket should also be changed.  
New chains wear out faster on old, worn sprockets.

# 11 SERVICE WORK ON THE CHASSIS

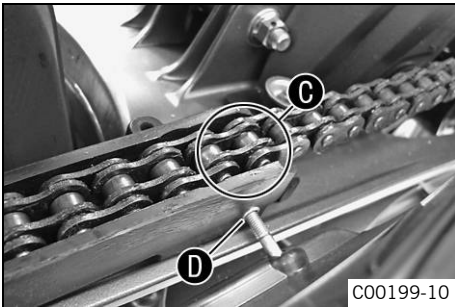
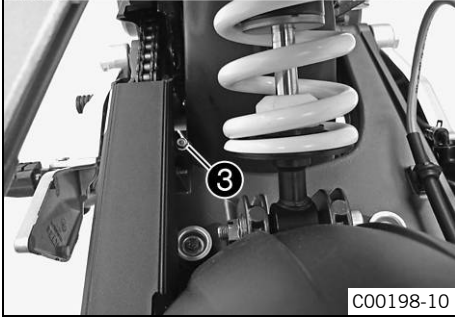
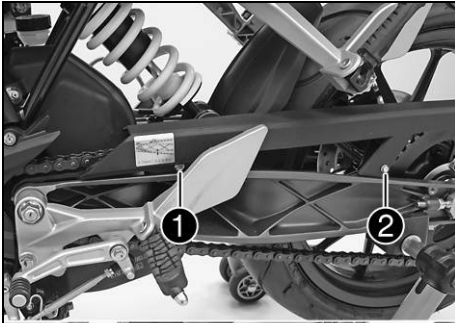

- Remove screws ② and ③ and release screw ①. Push the chain guard aside.

- Check the chain sliding guard for wear.
  - » If the chain sliding guard has lost material due to wear to the extent that, in area ①, drilled hole ② is visible from above:
    - Change the chain sliding guard. 🔧
- Check that the chain sliding guard is firmly seated.
  - » If the chain sliding guard is loose:
    - Tighten the chain sliding guard.

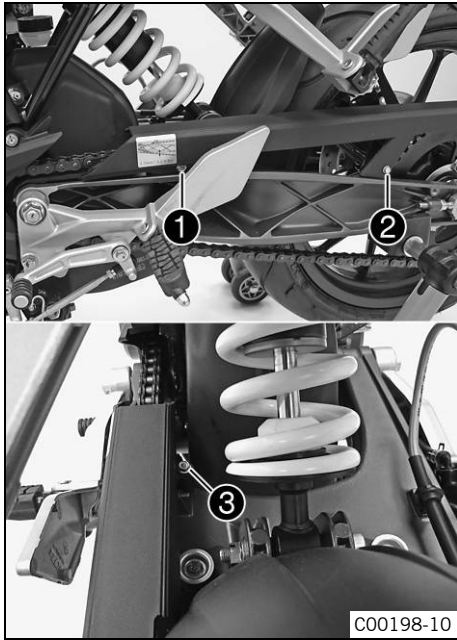

- Position the chain guard and tighten screw **1**.

Guideline

Screw, chain guard	EJOT PT®	4 Nm (3 lbf ft)
--------------------	----------	-----------------

- Tighten screw **2**.

Guideline

Screw, chain guard	EJOT PT®	4 Nm (3 lbf ft)
--------------------	----------	-----------------

- Tighten screw **3**.

Guideline

Remaining screws, chassis	M5	5 Nm (3.7 lbf ft)
---------------------------	----	-------------------

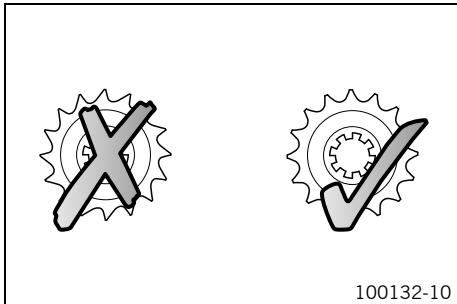

**(Option: With ABS)**

- Check the rear sprocket and engine sprocket for wear.
  - » If the rear sprocket and engine sprocket are worn:
    - Change the power set. 



**Info**

The engine sprocket, rear sprocket, and chain should always be replaced together.

# 11 SERVICE WORK ON THE CHASSIS

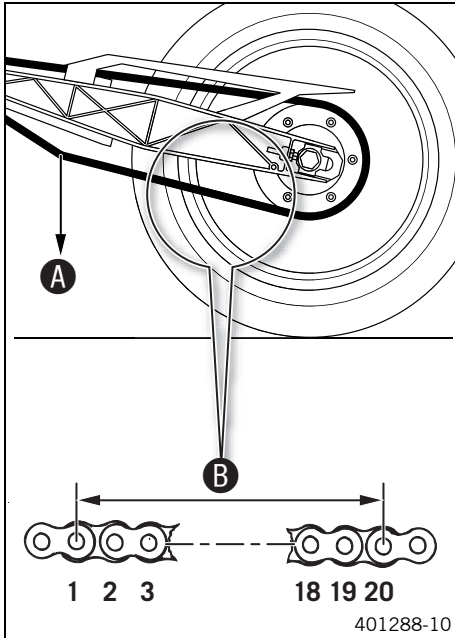

401288-10

- Shift gear to neutral.
- Pull the lower chain section with specified weight **A**.

Guideline

Weight, chain wear measurement	15 kg (33 lb.)
--------------------------------	----------------

- Measure the distance **B** of 20 chain links in the lower chain section.



### Info

Chain wear is not always even, so you should repeat this measurement at different chain positions.

Maximum distance <b>B</b> at the longest chain section	301.6 mm (11.874 in)
--	----------------------

- » If the distance **B** is greater than the specified measurement:
  - Change the power set. 



### Info

When the chain is replaced, the rear sprocket and engine sprocket should also be changed.  
New chains wear out faster on old, worn sprockets.

# 11 SERVICE WORK ON THE CHASSIS

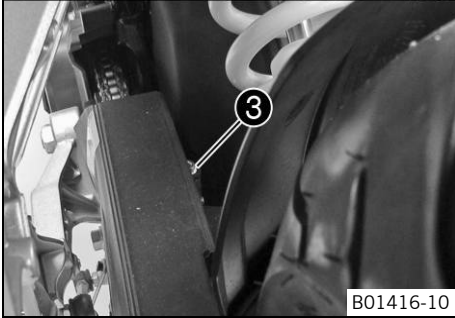
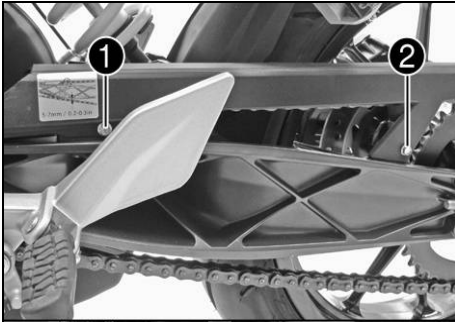

B01416-10

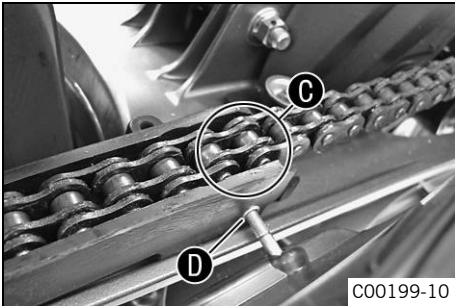

C00199-10

- Remove screws ② and ③ and release screw ①. Push the chain guard aside.

- Check the chain sliding guard for wear.
  - » If the chain sliding guard has lost material due to wear to the extent that, in area ①, drilled hole ② is visible from above:
    - Change the chain sliding guard. 🔧
- Check that the chain sliding guard is firmly seated.
  - » If the chain sliding guard is loose:
    - Tighten the chain sliding guard.

# 11 SERVICE WORK ON THE CHASSIS

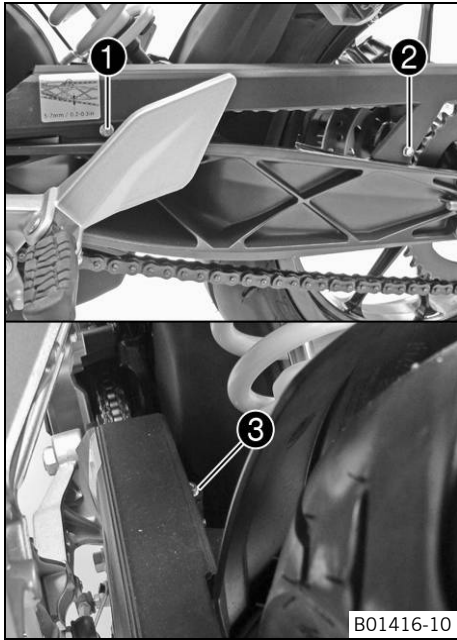

- Position the chain guard and tighten screw **1**.

Guideline

Screw, chain guard	EJOT PT®	4 Nm (3 lbf ft)
--------------------	----------	-----------------

- Tighten screw **2**.

Guideline

Screw, chain guard	EJOT PT®	4 Nm (3 lbf ft)
--------------------	----------	-----------------

- Tighten screw **3**.

Guideline

Remaining screws, chassis	M5	5 Nm (3.7 lbf ft)
---------------------------	----	-------------------

## 11.14 Removing the front spoiler

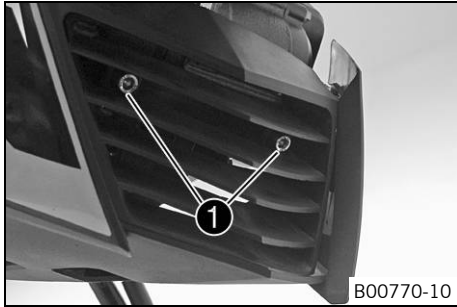

- Remove screws ①.

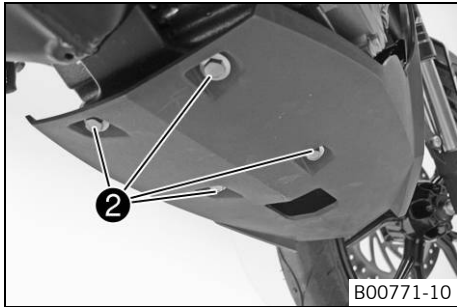

- Remove screws ②.
- Take off the front spoiler.



## 11.15 Fitting front spoiler

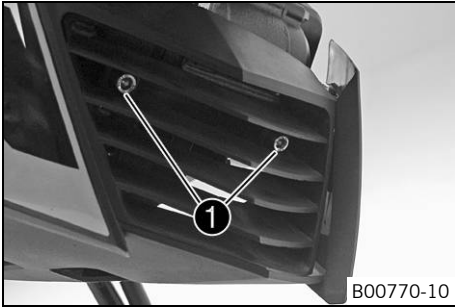

- Position the front spoiler. Mount screws ❶ but do not tighten yet.

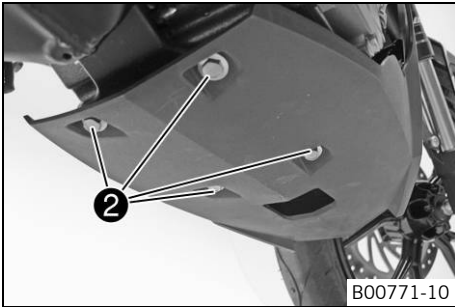

- Mount and tighten screws ❷.

Guideline

Remaining screws, chassis	M6	10 Nm (7.4 lbf ft)
---------------------------	----	--------------------

- Tighten screw ❶.

Guideline

Remaining screws, chassis	M6	10 Nm (7.4 lbf ft)
---------------------------	----	--------------------

## 12.1 ABS/antilock brake system (Option: With ABS)

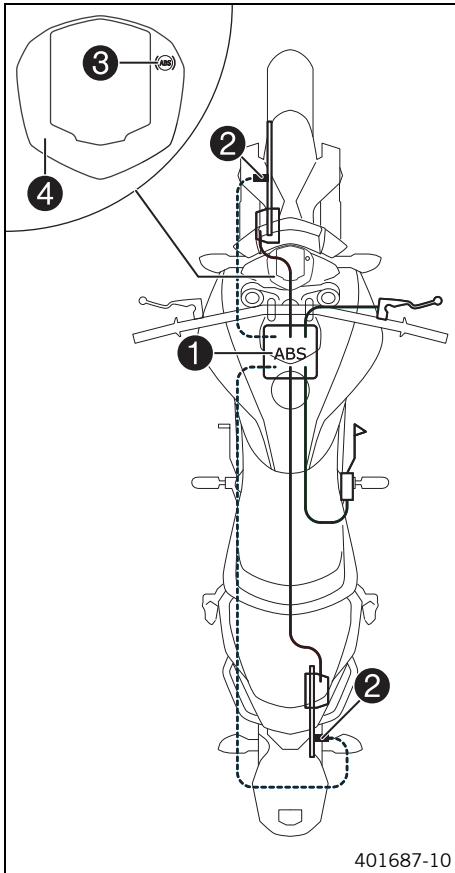

401687-10

The ABS unit **1**, which consists of a hydraulic unit, ABS control unit, and return pump, is installed under the seat. A wheel speed sensor **2** is located at the front and rear wheels.



### Warning

**Danger of accidents** Functional limitations of the ABS

- The rear wheel may only be spun with the front brake applied (burn out) if the ABS is switched off.
- If the vehicle has been modified, such as shortened or lengthened spring deflections, different rim diameters, different tires, the wrong tire air pressure, different brake linings, etc., the ABS will not function optimally. Optimal functioning of the ABS is only ensured if the brake system only contains spare parts and tires that have been approved and/or recommended by KTM.
- Service work and repairs must be performed properly. (Your authorized KTM workshop will be glad to help.)

The ABS is a safety system that prevents locking of the wheels when the vehicle is traveling straight ahead without the action of lateral forces.



### Warning

**Danger of accidents** Vehicle rollover

- It is not always possible to prevent vehicle rollover in extreme riding situations (e. g. luggage loaded with a high center of gravity, varying road surfaces, steep descents, full braking without disengaging the gear). Adapt your riding style to the road conditions and your riding ability.

The ABS operates with two independent brake circuits (front and rear brakes). During normal operation, the brake system operates like a conventional brake system without ABS. When the ABS control unit detects the tendency of a wheel to lock, the ABS begins regulating the braking pressure. The control process causes the hand and foot brake levers to vibrate slightly.

The ABS warning lamp **3** must light up briefly after the ignition is switched on and should then go out after starting off. If it does not go out after starting off or if it lights up while riding, this indicates a fault in the ABS system. In this case, the ABS is no longer enabled and the wheels may lock during braking. The brake system itself stays functional; only ABS control is not available.

The ABS warning lamp may also light up if the rotating speeds of the front and rear wheels differ greatly under extreme riding conditions, for example when making wheelies or if the rear wheel spins. This causes the ABS to switch off.

To reenale the ABS, the vehicle must be stopped and the ignition switched off. The ABS is reenaled when the vehicle is switched on again. The ABS warning lamp goes out when you start off.

Button **4** can be used to switch ABS off manually (see Starting).

## 12.2 Checking the brake discs



### Warning

**Danger of accidents** Reduced braking efficiency due to worn brake disc(s).

- Change the worn brake disc(s) without delay. (Your authorized KTM workshop will be glad to help.)

- Check the thickness of the front and rear brake discs at several places on the disk to see if it conforms to measurement **A**.

### Info

Wear reduces the thickness of the brake disc in area **1** of the brake disc.

#### Brake discs - wear limit

Front	3.6 mm (0.142 in)
Rear	3.6 mm (0.142 in)

- » If the brake disc thickness is less than the specified value:

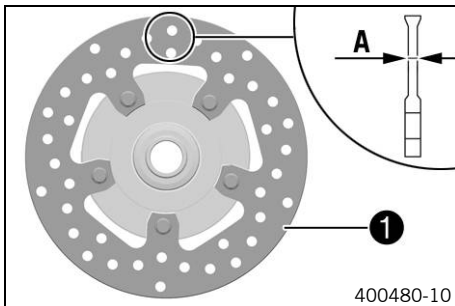

- Change the brake discs. 🛠️
- Check the front and rear brake discs for damage, cracking, and deformation.
  - » If the brake disc shows signs of damage, cracking, or deformation:
    - Change the brake discs. 🛠️

## 12.3 Checking the brake fluid level of the front brake



### Warning

**Danger of accidents** Failure of the brake system.

- If the brake fluid level falls below the **MIN** mark, this indicates a leakage in the brake system or worn-out brake linings. Check the brake system and do not continue riding. (Your authorized KTM workshop will be glad to help.)



### Warning

**Danger of accidents** Reduced braking efficiency due to old brake fluid.

- Change the brake fluid of the front and rear brake according to the service schedule. (Your authorized KTM workshop will be glad to help.)

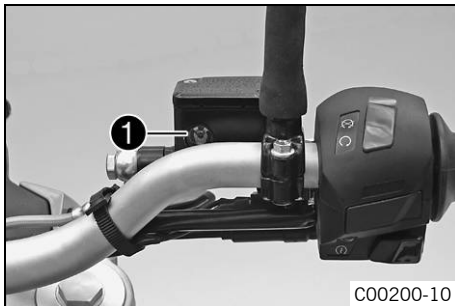

- Move the brake fluid reservoir mounted on the handlebar to a horizontal position.
- Check the brake fluid level in viewer ①.
  - » If the brake fluid is below the **MIN** marking:
    - Add front brake fluid. 🛠️ (👉 p. 99)

## 12.4 Adding front brake fluid



### Warning

**Danger of accidents** Failure of the brake system.

- If the brake fluid level falls below the **MIN** mark, this indicates a leakage in the brake system or worn-out brake linings. Check the brake system and do not continue riding. (Your authorized KTM workshop will be glad to help.)



### Warning

**Skin irritation** Brake fluid can cause skin irritation on contact.

- Avoid contact with skin and eyes, and keep out of the reach of children.
- Wear suitable protective clothing and goggles.
- If brake fluid comes into contact with the eyes, flush the eyes thoroughly with water and consult a physician immediately.



### Warning

**Danger of accidents** Reduced braking efficiency due to old brake fluid.

- Change the brake fluid of the front and rear brake according to the service schedule. (Your authorized KTM workshop will be glad to help.)



### Warning

**Environmental hazard** Hazardous substances cause environmental damage.

- Oil, grease, filters, fuel, cleaners, brake fluid, etc., should be disposed of as stipulated in applicable regulations.



### Info

Avoid contact between brake fluid and painted parts. Brake fluid attacks paint!  
Use only clean brake fluid from a sealed container.

### Preparatory work

- Check the front brake linings. ( p. 100)

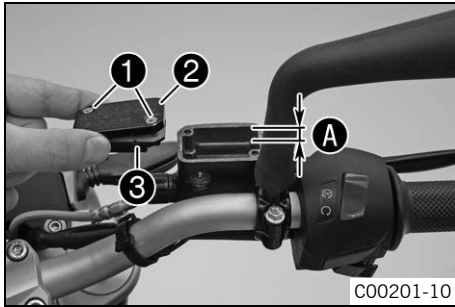

## Main work

- Move the brake fluid reservoir mounted on the handlebar to a horizontal position.
- Remove screws ①.
- Remove cover ② with membrane ③.
- Add brake fluid to level A.

## Guideline

Level A	5 mm (0.2 in)
---------	---------------

Brake fluid DOT 4 / DOT 5.1 (☞ p. 181)
--

- Position the cover with the membrane. Mount and tighten the screws.

## Info

Clean up overflowed or spilt brake fluid immediately with water.

## 12.5 Checking the front brake linings



### Warning

**Danger of accidents** Reduced braking efficiency caused by worn brake linings.

- Change worn brake linings immediately. (Your authorized KTM workshop will be glad to help.)

### Note

**Danger of accidents** Reduced braking efficiency caused by damaged brake discs.

- If the brake linings are not changed in time, the steel brake lining carriers grind on the brake disc. The braking effect is greatly reduced and the brake discs are destroyed. Check the brake linings regularly.

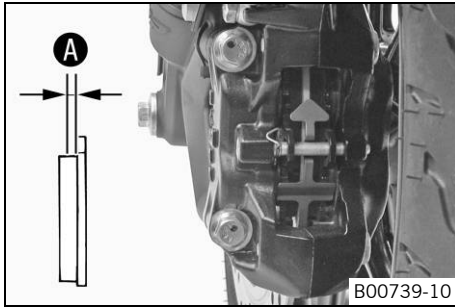

- Check the brake linings for minimum thickness **A**.

Minimum thickness <b>A</b>	$\geq 1 \text{ mm } (\geq 0.04 \text{ in})$
----------------------------	---

- » If the minimum thickness is less than specified:
  - Change the front brake linings. 🛠️
- Check the brake linings for damage and cracking.
  - » If there is wear or tearing:
    - Change the front brake linings. 🛠️

## 12.6 Checking the free travel of foot brake lever



### Warning

**Danger of accidents** Brake system failure.

- If there is no free travel on the foot brake lever, pressure builds up on the rear brake circuit. The rear brake can fail due to overheating. Adjust the free travel on foot brake lever according to specifications.

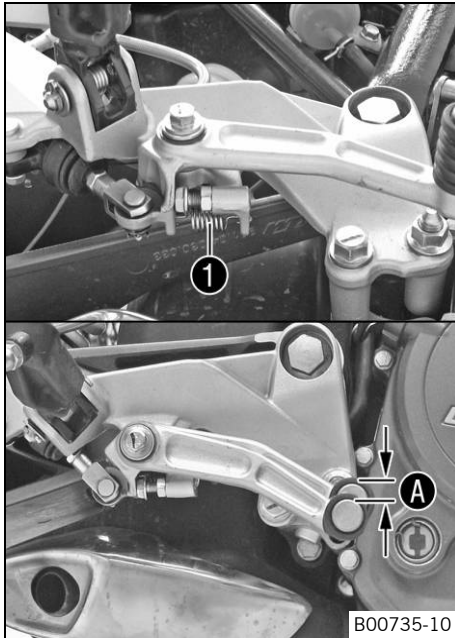

- Disconnect spring ❶.
- Move the foot brake lever back and forth between the end stop and the contact to the foot brake cylinder piston and check free travel ❸.

Guideline

Free travel at foot brake lever	3... 5 mm (0.12... 0.2 in)
---------------------------------	----------------------------

- » If the free travel does not meet specifications:
  - Adjust the free travel of the foot brake lever. 🛠️ (📄 p. 102)
- Reconnect spring ❶.

## 12.7 Adjusting the free travel of the foot brake lever 🛠️



### Warning

**Danger of accidents** Brake system failure.

- If there is no free travel on the foot brake lever, pressure builds up on the rear brake circuit. The rear brake can fail due to overheating. Adjust the free travel on foot brake lever according to specifications.



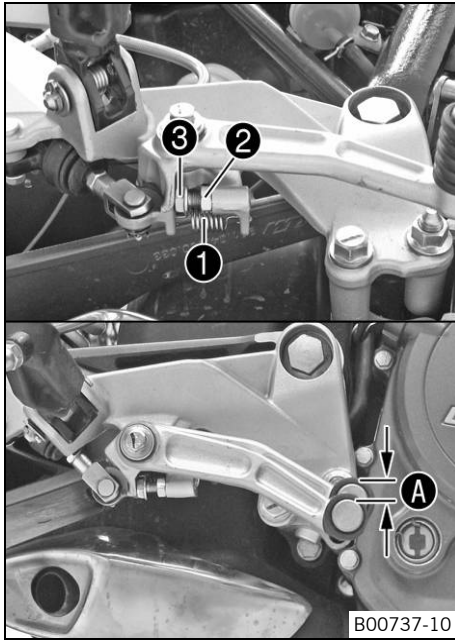

- Disconnect spring ①.
- Release nut ② and use screw ③ to adjust the specified free travel A.

Guideline

Free travel at foot brake lever	3... 5 mm (0.12... 0.2 in)
---------------------------------	----------------------------



### Info

The range of adjustment is limited.

- Hold screw ③ and tighten nut ②.
- Attach spring ①.

## 12.8 Checking the rear brake fluid level



### Warning

**Danger of accidents** Failure of the brake system.

- If the brake fluid level falls below the **MIN** mark, this indicates a leakage in the brake system or worn-out brake linings. Check the brake system and do not continue riding. (Your authorized KTM workshop will be glad to help.)



## Warning

**Danger of accidents** Reduced braking efficiency due to old brake fluid.

- Change the brake fluid of the front and rear brake according to the service schedule. (Your authorized KTM workshop will be glad to help.)



### (Option: Without ABS)

- Stand the vehicle upright.
- Check the brake fluid level in the brake fluid reservoir.
  - » If the fluid level reaches the **MIN** marking **1**:
    - Add rear brake fluid. 🛠️ (👉 p. 105)

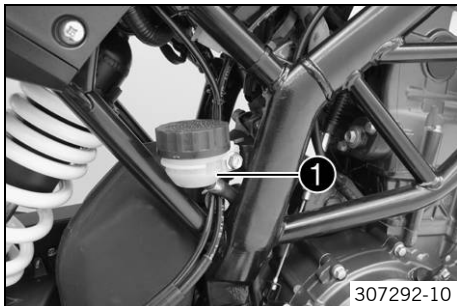

### (Option: With ABS)

- Stand the vehicle upright.
- Check the brake fluid level in the brake fluid reservoir.
  - » If the fluid level reaches the **MIN** marking **1**:
    - Add rear brake fluid. 🛠️ (👉 p. 105)

## 12.9 Adding rear brake fluid



### Warning

**Danger of accidents** Failure of the brake system.

- If the brake fluid level falls below the **MIN** mark, this indicates a leakage in the brake system or worn-out brake linings. Check the brake system and do not continue riding. (Your authorized KTM workshop will be glad to help.)



### Warning

**Skin irritation** Brake fluid can cause skin irritation on contact.

- Avoid contact with skin and eyes, and keep out of the reach of children.
- Wear suitable protective clothing and goggles.
- If brake fluid comes into contact with the eyes, flush the eyes thoroughly with water and consult a physician immediately.



### Warning

**Danger of accidents** Reduced braking efficiency due to old brake fluid.

- Change the brake fluid of the front and rear brake according to the service schedule. (Your authorized KTM workshop will be glad to help.)



### Warning

**Environmental hazard** Hazardous substances cause environmental damage.

- Oil, grease, filters, fuel, cleaners, brake fluid, etc., should be disposed of as stipulated in applicable regulations.



### Info

Avoid contact between brake fluid and painted parts. Brake fluid attacks paint!  
Use only clean brake fluid from a sealed container.

### Preparatory work

- Check the rear brake linings. ( p. 106)

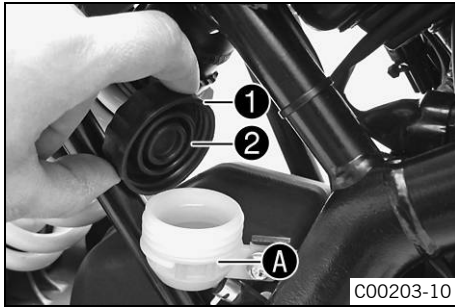

## Main work

### (Option: Without ABS)

- Stand the vehicle upright.
- Remove screw cap ① with membrane ②.
- Add brake fluid to level A.

Brake fluid DOT 4 / DOT 5.1 (☞ p. 181)

- Refit screw cap with membrane.

### Info

Clean up overflowed or spilt brake fluid immediately with water.

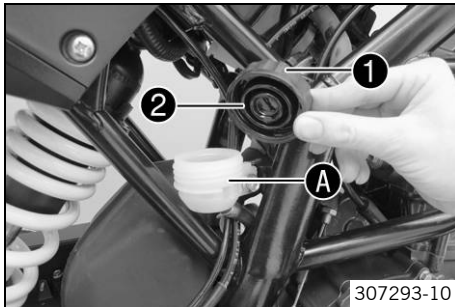

### (Option: With ABS)

- Stand the vehicle upright.
- Remove screw cap ① with membrane ②.
- Add brake fluid to level A.

Brake fluid DOT 4 / DOT 5.1 (☞ p. 181)

- Refit screw cap with membrane.

### Info

Clean up overflowed or spilt brake fluid immediately with water.

## 12.10 Checking the rear brake linings



### Warning

**Danger of accidents** Reduced braking efficiency caused by worn brake linings.

- Change worn brake linings immediately. (Your authorized KTM workshop will be glad to help.)

## Note

**Danger of accidents** Reduced braking efficiency caused by damaged brake discs.

- If the brake linings are not changed in time, the steel brake lining carriers grind on the brake disc. The braking effect is greatly reduced and the brake discs are destroyed. Check the brake linings regularly.

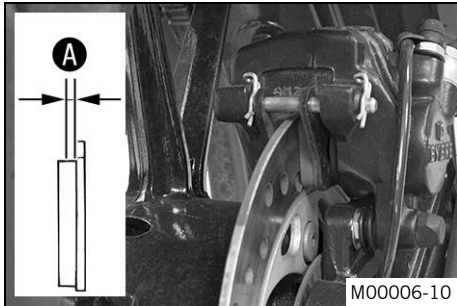

- Check the brake linings for minimum thickness **A**.

Minimum thickness <b>A</b>	$\geq 1 \text{ mm } (\geq 0.04 \text{ in})$
----------------------------	---

- » If the minimum thickness is less than specified:
  - Change the rear brake linings. 🔧
- Check the brake linings for damage and cracking.
  - » If there is wear or tearing:
    - Change the rear brake linings. 🔧

## 13.1 Removing the front wheel 🛠️



### Preparatory work

- Raise the motorcycle with the rear wheel stand. (🔧 p. 75)
- Raise the motorcycle with the front wheel stand. (🔧 p. 76)

### Main work

#### (Option: Without ABS)

- Loosen screw ① and screws ②.
- Unscrew screw ① about six turns and press your hand on the screw to push the wheel spindle out of the axle clamp. Remove screw ①.



### Warning

**Danger of accidents** Reduced braking effect caused by damaged brake discs.

- Always lay the wheel down in such a way that the brake discs are not damaged.

- Holding the front wheel, withdraw the wheel spindle. Take the front wheel out of the fork.



### Info

Do not pull the hand brake lever when the front wheel is removed.

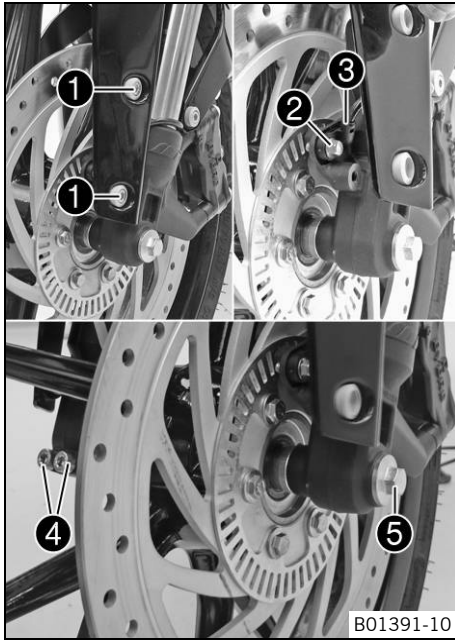

## (Option: With ABS)

- Remove screws ① and push the fender to the side.
- Remove screw ② and pull wheel speed sensor ③ out of the hole.
- Loosen screws ④ and screw ⑤.
- Unscrew screw ⑤ about six turns and press your hand on the screw to push the wheel spindle out of the axle clamp. Remove screw ⑤.



### Warning

**Danger of accidents** Reduced braking effect caused by damaged brake discs.

- Always lay the wheel down in such a way that the brake discs are not damaged.
- 
- Holding the front wheel, withdraw the wheel spindle. Take the front wheel out of the fork.



### Info

Do not pull the hand brake lever when the front wheel is removed.

## 13.2 Installing the front wheel



### Warning

**Danger of accidents** Reduced braking efficiency due to oil or grease on the brake discs.

- Always keep the brake discs free of oil and grease, and clean them with brake cleaner when necessary.

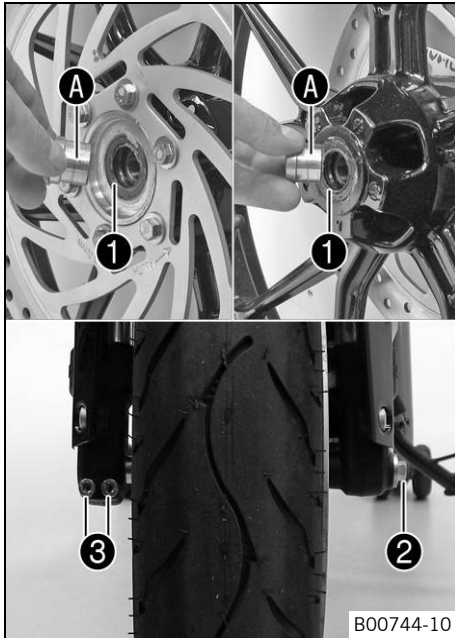

### Main work

#### (Option: Without ABS)

- Check the wheel bearing for damage and wear.
  - » If the wheel bearing is damaged or worn:
    - Change the wheel bearing. 🛠️
- Clean and grease the shaft seal rings **1** and mating surfaces **A** of the spacers.

Long-life grease (👉 p. 184)

- Insert the spacers.
- Clean the thread of the wheel spindle and screw **2**.
- Position the front wheel and insert the wheel spindle.
  - ✓ The brake linings are correctly positioned.
- Mount and tighten screw **2**.

#### Guideline

Screw, front wheel spindle	M8	30 Nm (22.1 lbf ft)
----------------------------	----	------------------------

- Operate the hand brake lever repeatedly until the brake linings are in contact with the brake disc and there is a pressure point.
- Take the motorcycle off of the front wheel stand. (👉 p. 77)
- Pull the front brake and push down hard on the fork several times to align the fork legs.
- Tighten screws **3**.

#### Guideline

Screw, fork stub	M8	15 Nm (11.1 lbf ft)
------------------	----	------------------------



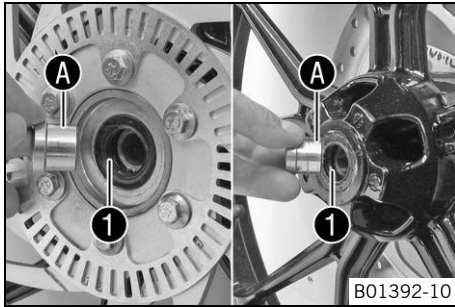

B01392-10

**(Option: With ABS)**

- Check the wheel bearing for damage and wear.
  - » If the wheel bearing is damaged or worn:
    - Change the wheel bearing. 🛠️
- Clean and grease the shaft seal rings **1** and mating surfaces **A** of the spacers.

Long-life grease (🔧 p. 184)

- Insert the spacers.

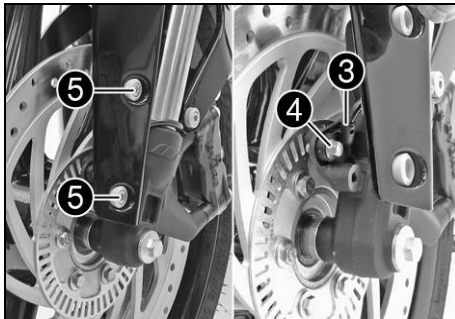

- Clean the thread of the wheel spindle and screw **2**.
- Position the front wheel and insert the wheel spindle.
  - ✓ The brake linings are correctly positioned.
- Mount and tighten screw **2**.

Guideline

Screw, front wheel spindle	M8	30 Nm (22.1 lbf ft)
----------------------------	----	------------------------

- Insert wheel speed sensor **3** into the hole. Mount and tighten screw **4**.

Guideline

Screw, wheel speed sensor holder	M6	8 Nm (5.9 lbf ft)
----------------------------------	----	-------------------

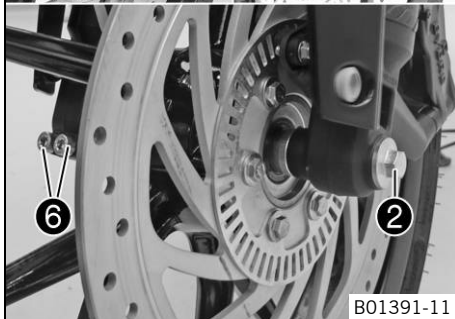

B01391-11

- Mount and tighten screws **5**.
- Take the motorcycle off of the front wheel stand. (🔧 p. 77)
- Pull the front brake and push down hard on the fork several times to align the fork legs.
- Tighten screws **6**.

Guideline

Screw, fork stub	M8	15 Nm (11.1 lbf ft)
------------------	----	------------------------

**Finishing work**

- Take the motorcycle off of the rear wheel stand. (👉 p. 75)

## 13.3 Removing the rear wheel 🛠️

**Preparatory work**

- Raise the motorcycle with the rear wheel stand. (👉 p. 75)

**Main work**

**(Option: Without ABS)**

- Remove nut ❶ and the washer. Remove chain adjuster ❷.
- Holding the rear wheel, withdraw wheel spindle ❸ with the washer and chain adjuster ❷.
- Push the rear wheel forward as far as possible and take the chain off the rear sprocket.



**Warning**

**Danger of accidents** Reduced braking effect caused by damaged brake discs.

- Always lay the wheel down in such a way that the brake discs are not damaged.

- Pull the rear wheel back and take it out of the swingarm.



**Info**

Do not operate the foot brake when the rear wheel is removed.

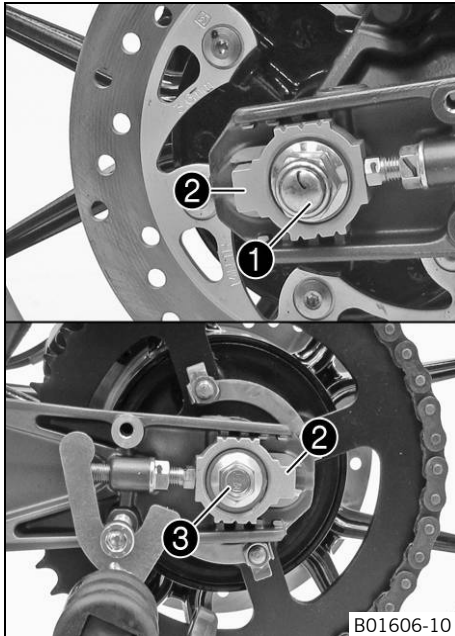

## (Option: With ABS)

- Remove screw ① and pull wheel speed sensor ② out of the hole.
- Remove nut ③ and the washer. Remove chain adjuster ④.
- Holding the rear wheel, withdraw wheel spindle ⑤ ④ with the washer and chain adjuster.
- Push the rear wheel forward as far as possible and take the chain off the rear sprocket.



### Warning

**Danger of accidents** Reduced braking effect caused by damaged brake discs.

- Always lay the wheel down in such a way that the brake discs are not damaged.

- Pull the rear wheel back and take it out of the swingarm.



### Info

Do not operate the foot brake when the rear wheel is removed.

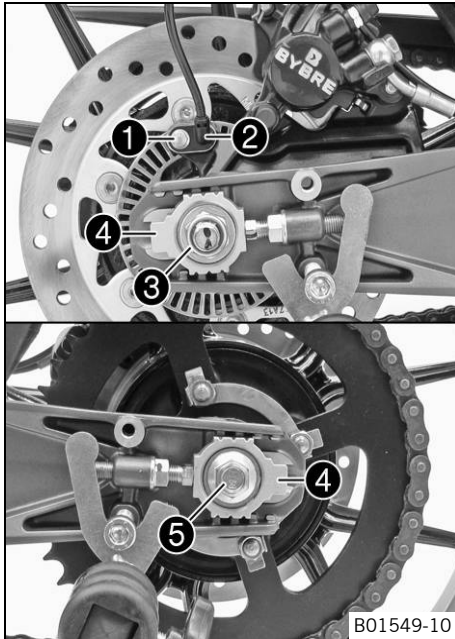

## 13.4 Installing the rear wheel 🛠️



### Warning

**Danger of accidents** Reduced braking efficiency due to oil or grease on the brake discs.

- Always keep the brake discs free of oil and grease, and clean them with brake cleaner when necessary.



## Warning

**Danger of accidents** No braking effect when operating the rear brake.

- After installing the rear wheel, always operate the foot brake until the pressure point is reached.

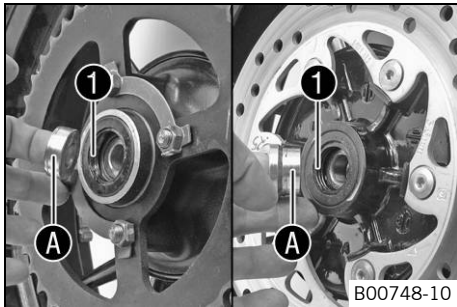

## Main work (Option: Without ABS)

- Check the rear hub rubber dampers. 🛠️ (🔧 p. 117)
- Check the wheel bearing for damage and wear.
  - » If the wheel bearing is damaged or worn:
    - Change the wheel bearing. 🛠️
- Clean and grease the shaft seal rings ① and mating surfaces ② of the spacers.

Long-life grease (🔧 p. 184)

- Clean the thread of the wheel spindle and nut ②.
- Clean the fixing locations on the brake caliper support and swingarm.
- Install the rubber damper and rear sprocket carrier on the rear wheel.
- Position the rear wheel.
  - ✓ The brake linings are correctly positioned.
- Position the rear wheel on the contact surfaces in the swingarm.
- Push the rear wheel as far forward as possible and place the chain on the rear sprocket.

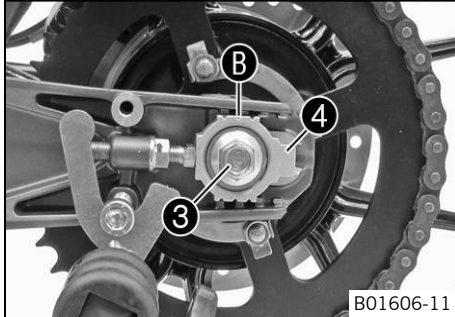
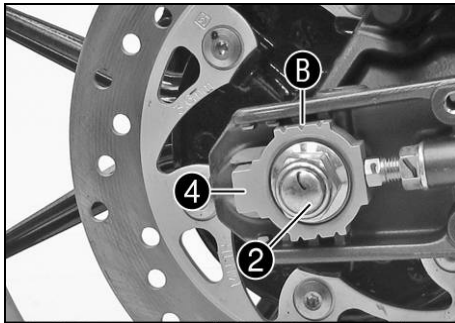

B01606-11

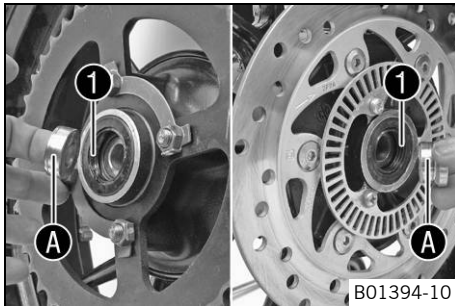

B01394-10

- Pull the rear wheel back and mount wheel spindle ③ with the washer and chain adjuster ④.



**Info**

Mount the left and right chain adjusters ④ in the same position.

- Mount nut ② and washer.
- Push the rear wheel forward so that the chain adjusters are on the screws, and tighten nut ②.

**Guideline**

In order for the rear wheel to be correctly aligned, the markings on the left and right chain adjusters must be in the same position relative to the reference marks ⑤.

Nut, rear wheel spindle	M14x1.5	90 Nm (66.4 lbf ft)
-------------------------	---------	------------------------

**(Option: With ABS)**

- Check the rear hub rubber dampers. 🛠️ (📖 p. 117)
- Check the wheel bearing for damage and wear.
  - » If the wheel bearing is damaged or worn:
    - Change the wheel bearing. 🛠️
- Clean and grease the shaft seal rings ① and mating surfaces ①A of the spacers.

Long-life grease (📖 p. 184)

- Clean the thread of the wheel spindle and nut ②.
- Clean the fixing locations on the brake caliper support and swingarm.

- Install the rubber damper and rear sprocket carrier on the rear wheel.
- Position the rear wheel.
  - ✓ The brake linings are correctly positioned.
- Push the rear wheel as far forward as possible and place the chain on the rear sprocket.
- Pull the rear wheel back and mount wheel spindle **3** with the washer and chain adjuster **4**.

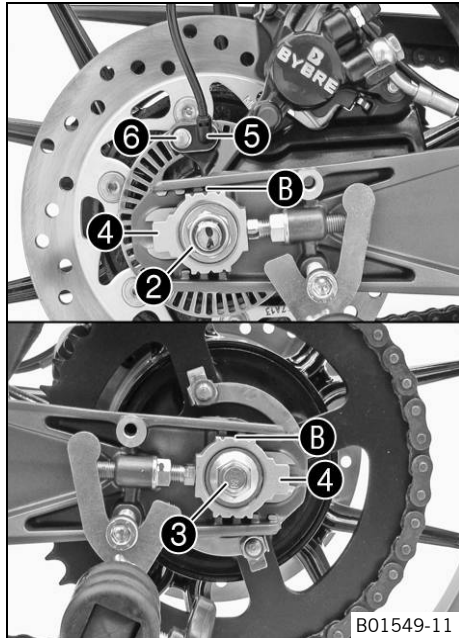

### Info

Mount the left and right chain adjusters **4** in the same position.

- Mount nut **2** and washer.
- Push the rear wheel forward so that the chain adjusters are on the screws, and tighten nut **2**.

### Guideline

In order for the rear wheel to be correctly aligned, the markings on the left and right chain adjusters must be in the same position relative to the reference marks **B**.

Nut, rear wheel spindle	M14x1.5	90 Nm (66.4 lbf ft)
-------------------------	---------	------------------------

- Insert wheel speed sensor **5** into the hole. Mount and tighten screw **6**.

### Guideline

Screw, wheel speed sensor holder	M6	8 Nm (5.9 lbf ft)
----------------------------------	----	-------------------

### Finishing work

- Take the motorcycle off of the rear wheel stand. (🔧 p. 75)

## 13.5 Checking the rear hub rubber dampers 🛠️

### **i** Info

The engine power is transmitted from the rear sprocket to the rear wheel via 6 rubber dampers. They eventually wear out during operation. If the rubber dampers are not changed in time, the rear sprocket carrier and the rear hub will be damaged.

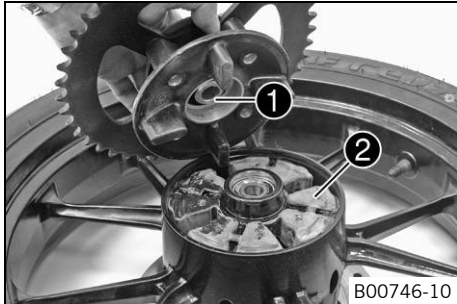

### Preparatory work

- Raise the motorcycle with the rear wheel stand. (🔧 p. 75)
- Remove the rear wheel. 🛠️ (🔧 p. 112)

### Main work

- Check bearing ①.
  - » If the bearing is damaged or worn:
    - Change the bearing. 🛠️
- Check the rubber dampers ② of the rear hub for damage and wear.
  - » If the rubber dampers of the rear hub are damaged or worn:
    - Change all rubber dampers in the rear hub.

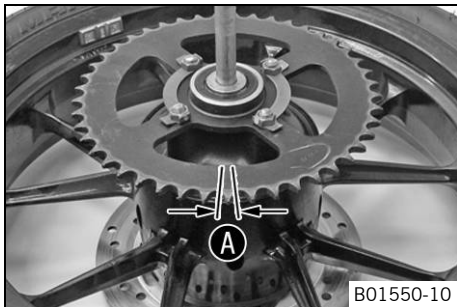

- Lay the rear wheel on a workbench with the rear sprocket facing upwards and insert the wheel spindle in the hub.
- To check the play **A**, hold the rear wheel tight and try to rotate the rear sprocket.

### **i** Info

Measure the play on the outside of the rear sprocket.

Play in rubber dampers, rear wheel	≤ 5 mm (≤ 0.2 in)
------------------------------------	-------------------

- » If play **A** is larger than the specified value:

- Change all rubber dampers in the rear hub.

## Finishing work

- Install the rear wheel.  (🔧 p. 113)
- Take the motorcycle off of the rear wheel stand. (🔧 p. 75)

## 13.6 Checking the tire condition



### Warning

**Danger of accidents** Uncontrollable vehicle handling in the event of a flat tire.

- In the interest of safety, replace damaged or worn tires immediately. (Your authorized KTM workshop will be glad to help.)



### Warning

**Danger of crashing** Poor vehicle handling due to different tire tread patterns on front and rear wheels.

- The front and rear wheels must be fitted with tires with similar tread patterns to prevent loss of control over the vehicle.



### Warning

**Danger of accidents** Uncontrollable handling characteristic due to non-approved and/or non-recommended tires/wheels.

- Only tires/wheels approved by KTM and with the corresponding speed index should be used.



### Info

The type, condition and air pressure of the tires all have a major impact on the riding behavior of the motorcycle. Worn tires have a negative effect on riding behavior, especially on wet surfaces.



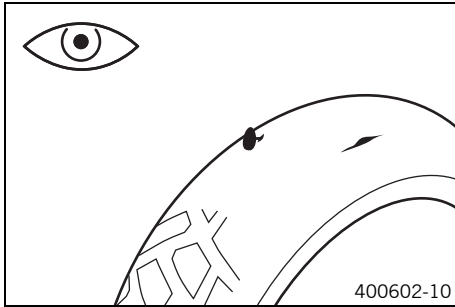

- Check the front and rear tires for cuts, run-in objects and other damage.
  - » If the tires exhibit cuts, run-in objects or other damage:
    - Change the tires.
- Check the depth of the tread.



### Info

Note local national regulations concerning the minimum tread depth.

Minimum tread depth	≥ 2 mm (≥ 0.08 in)
---------------------	--------------------

- » If the tread depth is less than the minimum permissible depth:
  - Change the tires.
- Check the age of the tires.



### Info

The tire's date of the manufacture is usually part of the tire markings and is indicated by the last four digits of the **DOT** marking. The first two digits refer to the week of manufacture and last two digits refer to the year of manufacture. KTM recommends that the tires are changed regardless of the actual wear, at the latest after 5 years.

- » If a tire is more than 5 years old:
  - Change the tires.

## 13.7 Checking the tire air pressure



### Info

Low tire air pressure leads to abnormal wear and overheating of the tire. Correct tire air pressure ensures optimal riding comfort and maximum tire service life.

# 13 WHEELS, TIRES

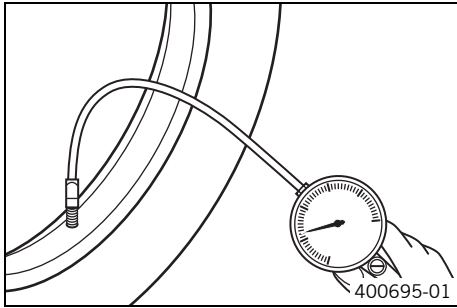

- Remove the dust cap.
- Check tire air pressure when the tires are cold.

Tire air pressure, solo	
Front	2.0 bar (29 psi)
Rear	2.0 bar (29 psi)

Tire air pressure with passenger/full payload	
Front	2.0 bar (29 psi)
Rear	2.2 bar (32 psi)

- » If the tire air pressure does not meet specifications:
  - Correct the tire air pressure.
- Mount the dust cap.

## 14.1 Removing the battery ↩



### Warning

**Risk of injury** Battery acid and battery gases cause serious chemical burns.

- Keep batteries out of the reach of children.
- Wear suitable protective clothing and goggles.
- Avoid contact with battery acid and battery gases.
- Keep sparks and open flames away from the battery. Only charge in well-ventilated rooms.
- In the event of skin contact, rinse with large amounts of water. If battery acid gets in the eyes, rinse with water for at least 15 minutes and contact a physician.

### Preparatory work

- Remove the passenger seat. (↩ p. 78)
- Remove the seat. (↩ p. 79)

### Main work

- Pull back the negative terminal cover ①.
- Disconnect the negative cable ② of the battery.

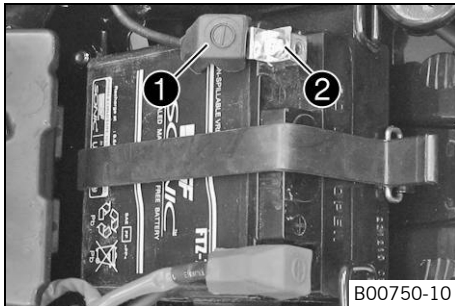

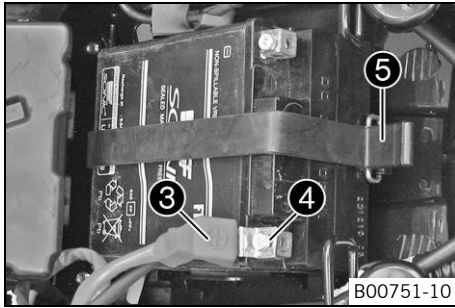

- Pull back the positive terminal cover ③.
- Disconnect the positive cable ④ of the battery.
- Detach rubber band ⑤.
- Pull the battery up and out of the battery holder.

## **i** Info

Never operate the motorcycle with a discharged battery or without a battery. In both cases, electrical components and safety devices can be damaged. The vehicle is therefore no longer roadworthy.

## 14.2 Installing the battery 🛠️

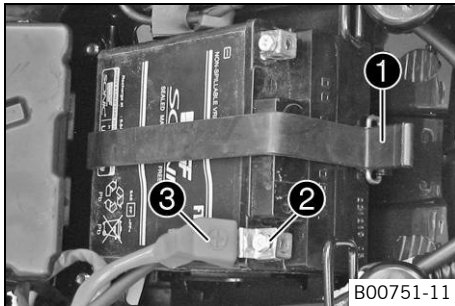

### Main work

- Position the battery in the battery holder.

## **i** Info

The battery terminals must be at the top.

- Attach rubber band ①.
- Reconnect the positive cable ② of the battery.
- Position positive terminal cover ③.

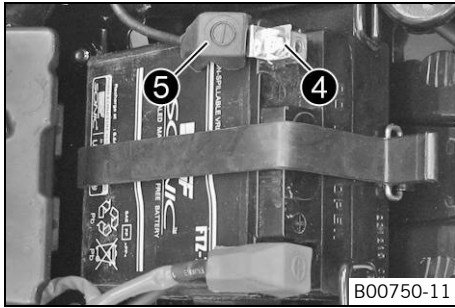

- Connect the negative cable ④ of the battery.
- Position the negative terminal cover ⑤.

### Finishing work

- Mount the seat. (👉 p. 80)
- Mount the passenger seat. (👉 p. 79)
- Set the clock. (👉 p. 46)

## 14.3 Recharging the battery 🛠️



### Warning

**Risk of injury** Battery acid and battery gases cause serious chemical burns.

- Keep batteries out of the reach of children.
- Wear suitable protective clothing and goggles.
- Avoid contact with battery acid and battery gases.
- Keep sparks and open flames away from the battery. Only charge in well-ventilated rooms.
- In the event of skin contact, rinse with large amounts of water. If battery acid gets in the eyes, rinse with water for at least 15 minutes and contact a physician.



## Warning

**Environmental hazard** The battery contains elements that are harmful to the environment.

- Do not discard batteries with the household waste. Dispose of faulty batteries in an environmentally compatible manner. Give the battery to your authorized KTM dealer or dispose of it at a collection point for used batteries.
- 



## Info

Even when there is no load on the battery, it still loses power steadily.

The charge state and the type of charge are very important for the service life of the battery.

Rapid recharging with a high charging current shortens the battery's service life.

If the charging current, charging voltage, and charging time are exceeded, electrolyte escapes through the safety valves. This reduces the battery capacity.

If the battery is depleted from starting the vehicle repeatedly, the battery must be charged immediately.

If the battery is left in a discharged state for an extended period, it will become over-discharged and sulfate, destroying the battery. The battery is maintenance-free, which means that the acid level does not need to be checked.

---

## Preparatory work

- Switch off all power consumers and switch off the engine.
- Remove the passenger seat. (☛ p. 78)
- Remove the seat. (☛ p. 79)
- Disconnect the negative cable of the battery to avoid damage to the motorcycle's electronics.

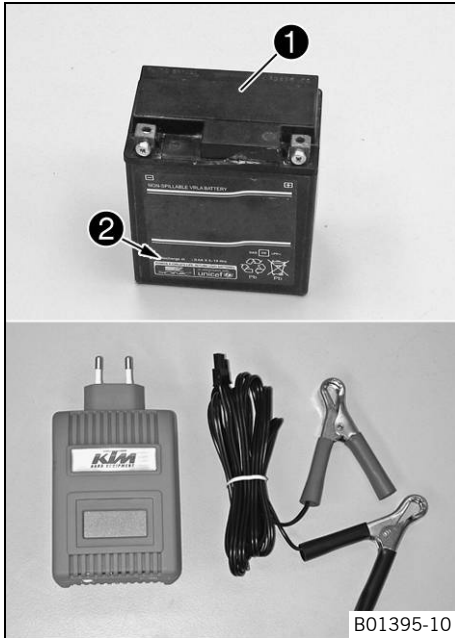

### Main work

- Connect the battery charger to the battery. Switch on the battery charger.

Battery charger (58429074000)
-------------------------------

You can also use the battery charger to test rest potential and start potential of the battery, and to test the alternator. With this device, you cannot overcharge the battery.



### Info

Never remove lid **1**.

Charge the battery with a maximum of 10% of the capacity specified on battery housing **2**.

- Switch off the charger after charging. Disconnect the battery.

### Guideline

The charge current, charge voltage and charge time must not be exceeded.	
Charge the battery regularly when the motorcycle is not in use	3 months

### Finishing work

- Mount the seat. (☛ p. 80)
- Mount the passenger seat. (☛ p. 79)
- Set the clock. (☛ p. 46)

## 14.4 Changing the ABS fuses (Option: With ABS)



### Warning

**Fire hazard** The electrical system can be overloaded if the wrong fuses are used.

- Use only fuses with the prescribed amperage. Never by-pass or repair fuses.



### Info

Two fuses for the ABS are located under the passenger seat. These fuses protect the return pump and the hydraulic unit of the ABS. The third fuse, which protects the ABS control unit, is located in the fuse box.

### Preparatory work

- Switch off all power consumers and the engine.
- Remove the passenger seat. (☛ p. 78)

### To change the fuse of the ABS hydraulic unit:

- Take off the protection cap and remove fuse ①.



### Info

A defective fuse is indicated by a burned-out fuse wire **A**.



### Warning

**Fire hazard** The electrical system can be overloaded if the wrong fuses are used.

- Use only fuses with the prescribed amperage. Never by-pass or repair fuses.
- Use spare fuses with the correct rating only.

Fuse (75011088015) (☛ p. 175)

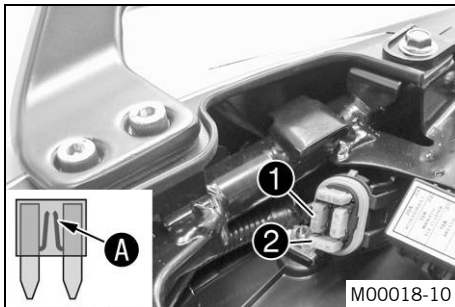

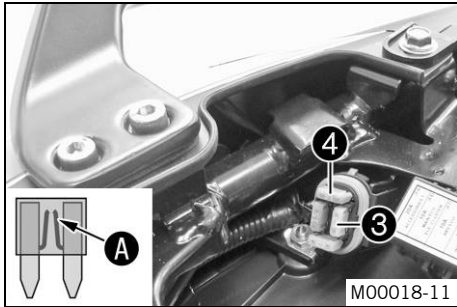

**Tip**

Replace spare fuse ② in the fuse box so that it is available if needed.

- Mount the protection cap.

**To change the fuse of the ABS return pump:**

- Take off the protection cap and remove fuse ③.

**Warning**

**Fire hazard** The electrical system can be overloaded if the wrong fuses are used.

- Use only fuses with the prescribed amperage. Never by-pass or repair fuses.
- Use spare fuses with the correct rating only.

Fuse (90111088025)

**Tip**

Replace spare fuse ④ in the fuse box so that it is available if needed.

- Mount the protection cap.

**Finishing work**

- Mount the passenger seat. (🔧 p. 79)

## 14.5 Changing the fuses of individual power consumers

**Info**

The fuse box with the main fuse and the fuses of the individual power consumers is located under the passenger seat.

### Preparatory work

- Switch off all power consumers and switch off the engine.
- Remove the passenger seat. (👉 p. 78)

### Main work

(Option: Without ABS)

- Open fuse box cover ❶.

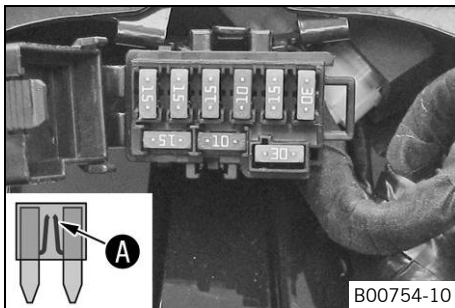
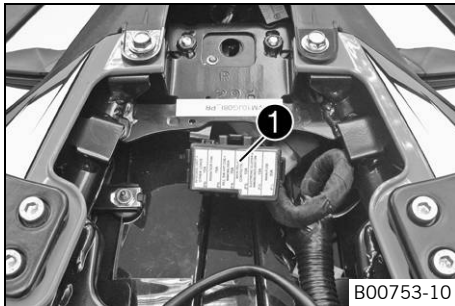

- Remove the defective fuse.

### Guideline

Fuse 1 - 30 A - main fuse
Fuse 2 - 15 A - combination instrument
Fuse 3 - 10 A - control unit, power relay
Fuse 4 - 15 A - ignition coil, alarm system (OPTIONAL)
Fuse 5 - 15 A - radiator fan
Fuse 6 - 15 A - horn, brake light, turn signal, high beam, low beam, parking light, tail light, license plate lamp

### Info

A defective fuse is indicated by a burned-out fuse wire ❶.



### Warning

**Fire hazard** The electrical system can be overloaded if the wrong fuses are used.

- Use only fuses with the prescribed amperage. Never by-pass or repair fuses.

- Use spare fuses with the correct rating only.

Fuse (75011088010) (☛ p. 175)
-------------------------------

Fuse (75011088015) (☛ p. 175)
-------------------------------

Fuse (75011088030) (☛ p. 175)
-------------------------------



### Tip

Replace the spare fuse in the fuse box so that it is available if needed.

- Check that the power consumer is functioning properly.
- Close the fuse box cover.

### (Option: With ABS)

- Open fuse box cover.
- Remove the defective fuse.

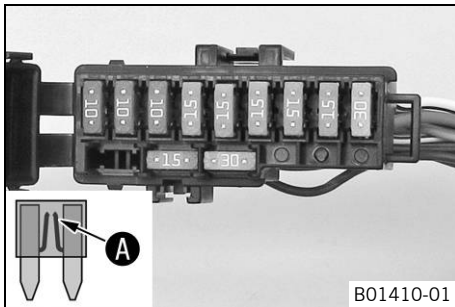

## Guideline

Fuse <b>1</b> - 30 A - main fuse
Fuse <b>2</b> - 15 A - start auxiliary relay, alarm system (OPTIONAL)
Fuse <b>3</b> - 15 A - control unit, power relay
Fuse <b>4</b> - 15 A - ignition coil
Fuse <b>5</b> - 15 A - radiator fan
Fuse <b>6</b> - 15 A - horn, brake light, turn signal, high beam, low beam, parking light, tail light, license plate lamp
Fuse <b>7</b> - 10 A - ABS control unit
Fuse <b>8</b> - 10 A - combination instrument, control unit
Fuse <b>9</b> - 10 A - auxiliary equipment



### Info

A defective fuse is indicated by a burned-out fuse wire .





### Warning

**Fire hazard** The electrical system can be overloaded if the wrong fuses are used.

- Use only fuses with the prescribed amperage. Never by-pass or repair fuses.

- Use spare fuses with the correct rating only.

Fuse (75011088010) (  p. 175)
Fuse (75011088015) (  p. 175)
Fuse (75011088030) (  p. 175)

**Tip**

Replace the spare fuse in the fuse box so that it is available if needed.

- Check that the power consumer is functioning properly.
- Close the fuse box cover.

**Finishing work**

- Mount the passenger seat. (🔧 p. 79)

## 14.6 Changing the headlight bulb

**Note**

**Damage to reflector** Reduced brightness.

- Grease on the lamp will evaporate due to the heat and be deposited on the reflector. Clean the lamp and keep it free of grease before mounting.

**Preparatory work**

- Switch off all power consumers and switch off the engine.

**Main work**

- Remove expanding rivets ❶.

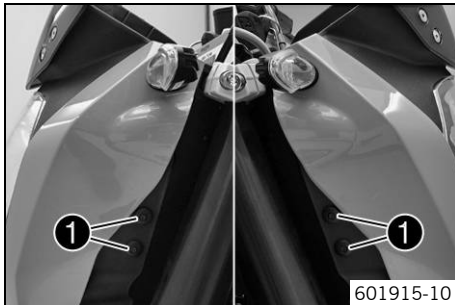

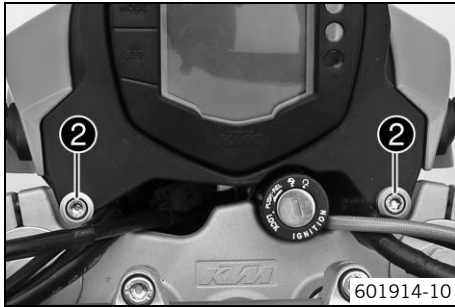

- Remove screws ②.
- Lift the headlight mask slightly and swing forward.

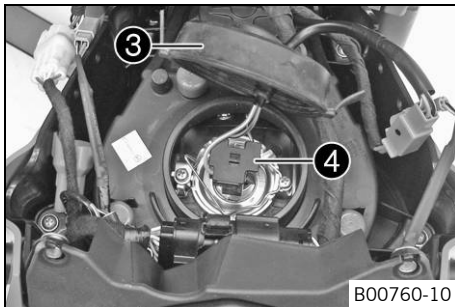

- Take off protection cap ③.
- Disconnect plug-in connector ④.

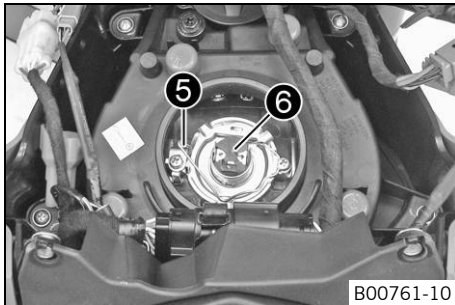

- Detach retaining clamp ⑤.
- Remove headlight bulb ⑥.
- Position the new headlight bulb in the headlight housing.

Headlight (H4/socket P43t) (☛ p. 175)



### Info

Insert the headlight bulb so that the catches latch into the recesses.

# 14 ELECTRICAL SYSTEM

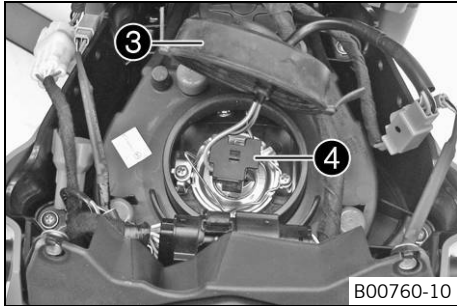

- Attach retaining clamp ⑤.
- Connect plug-in connection ④.
- Mount protection cap ③.

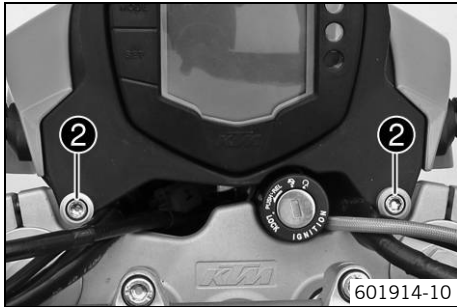

- Fold the headlight mask up.
- Mount and tighten screws ②.

### Guideline

Screw, headlight mask	M6	11 Nm (8.1 lbf ft)
-----------------------	----	--------------------

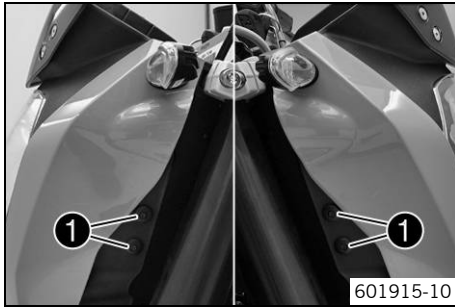

- Mount expanding rivets ❶ on both sides.
- Check that the lighting is functioning properly.

## 14.7 Changing the parking light bulb

### Note

**Damage to reflector** Reduced brightness.

- Grease on the lamp will evaporate due to the heat and be deposited on the reflector. Clean the lamp and keep it free of grease before mounting.

### Preparatory work

- Switch off all power consumers and switch off the engine.

### Main work

- Remove expanding rivets ❶.

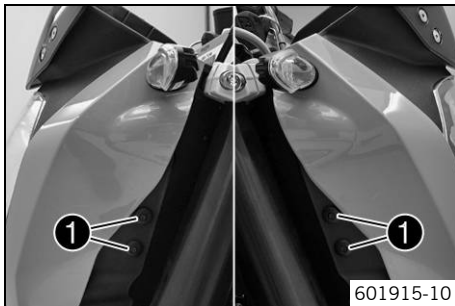



# 14 ELECTRICAL SYSTEM

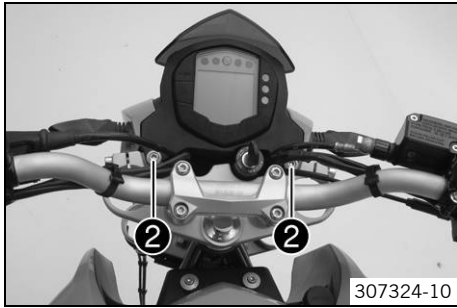

- Remove screws ②.
- Lift the headlight mask slightly and swing forward.

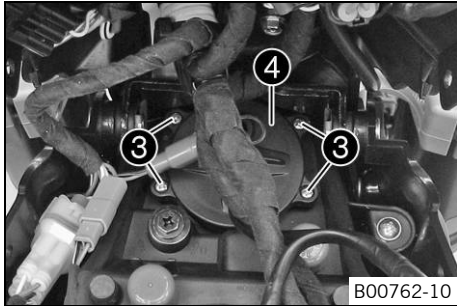

- Remove screws ③.
- Take off cover ④.

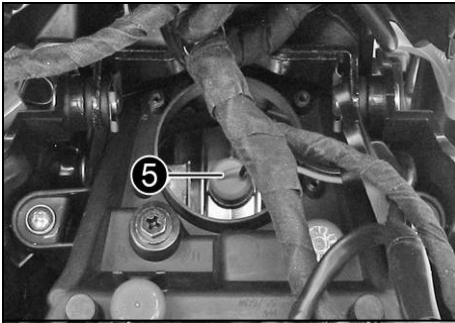

- Pull the socket with bulb 5 out of the housing.
- Remove the bulb.
- Position a new light bulb in the socket.

Parking light (W5W/socket W2.1x9.5d) ( p. 175)



- Position the socket with bulb 5 in the housing.

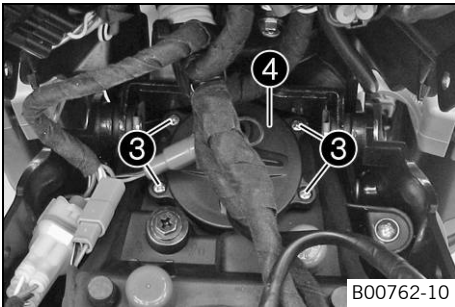

- Position cover 4.
- Mount and tighten screws 3.

# 14 ELECTRICAL SYSTEM

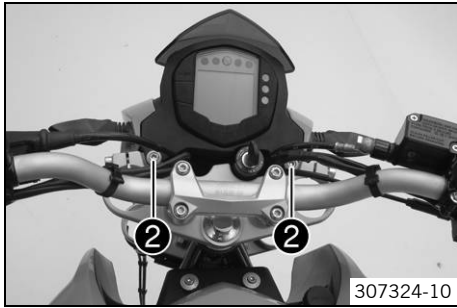

- Fold the headlight mask up.
- Mount and tighten screws **2**.

Guideline

Screw, headlight mask	M6	11 Nm (8.1 lbf ft)
-----------------------	----	--------------------

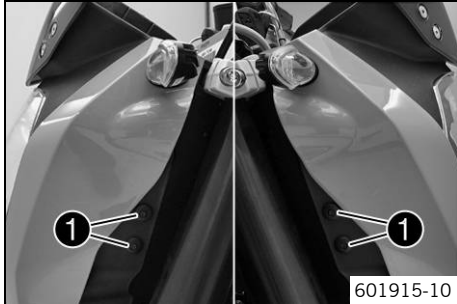

- Mount expanding rivets **1** on both sides.
- Check that the lighting is functioning properly.

## 14.8 Checking the headlight setting

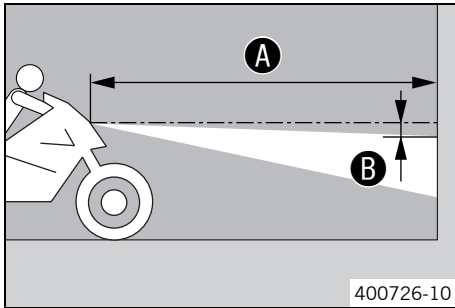

- Position the vehicle upright on a horizontal surface in front of a light wall and make a mark at the height of the center of the low beam headlight.
- Make another mark at a distance **B** under the first mark.

### Guideline

Distance <b>B</b>	5 cm (2 in)
-------------------	-------------

- Position the vehicle vertically at a distance **A** in front of the wall and switch on the low beam.

### Guideline

Distance <b>A</b>	5 m (16 ft)
-------------------	-------------

- The rider, with luggage and passenger if applicable, now mounts the motorcycle.
- Check the headlight setting.

The light-dark boundary must lie exactly on the lower mark when the motorcycle is ready to operate with the rider mounted along with any luggage and a passenger if applicable.

- » If the boundary between light and dark does not meet specifications:
  - Adjust the headlight range. (☛ p. 139)

## 14.9 Adjusting the headlight range

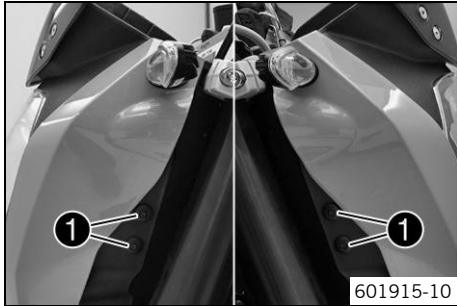

### Main work

- Remove expanding rivets ①.

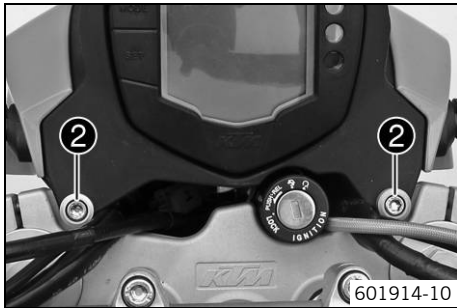

- Remove screws ②.
- Lift the headlight mask slightly and swing forward.

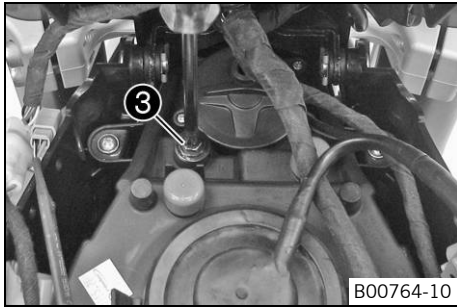

- Adjust the beam distance of the headlight by turning screw ③.

Guideline

For a motorcycle with rider, and with luggage and a passenger if applicable, the light/dark boundary must be exactly on the lower mark (applied in: Checking headlight adjustment).

**i** Info

Turn clockwise to increase the headlight range; turn counterclockwise to reduce the headlight range.



- Fold the headlight mask up.
- Mount and tighten screws ②.

Guideline

Screw, headlight mask	M6	11 Nm (8.1 lbf ft)
-----------------------	----	--------------------

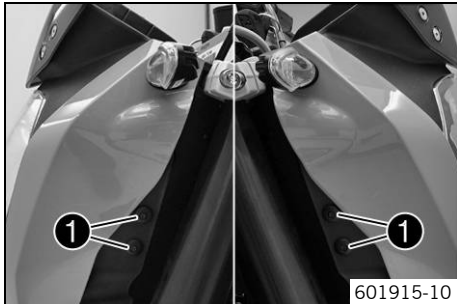

- Mount expanding rivets ① on both sides.

# 14 ELECTRICAL SYSTEM

141

## Finishing work

- Check the headlight setting. (☛ p. 138)

## 15.1 Cooling system

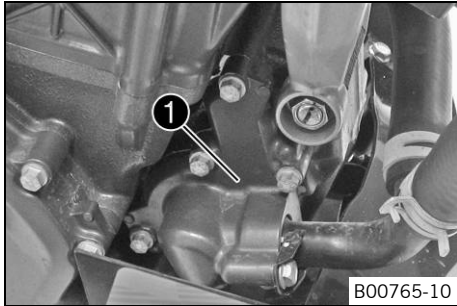

Water pump ① in the engine circulates the coolant.

The pressure resulting from the warming of the cooling system is regulated by a valve in radiator cap ②. Heat expansion causes excess coolant to flow into compensating tank ③. When the temperature falls, this surplus coolant is sucked back into the cooling system. This ensures that operating the vehicle at the specified coolant temperature will not result in a risk of malfunctions.

125 °C (257 °F)



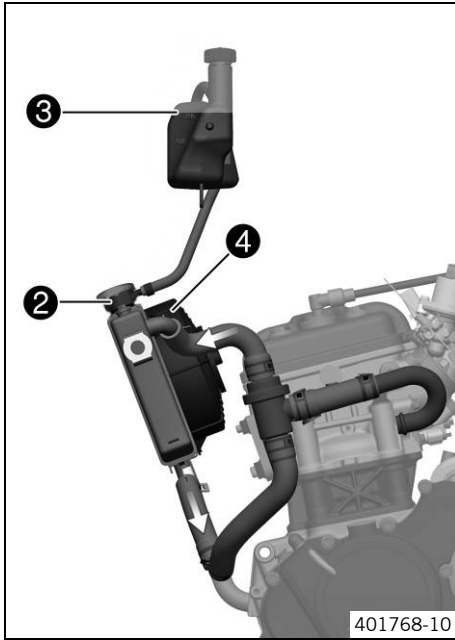

The coolant is cooled by the air stream and a radiator fan ④, which is controlled by a thermostat.

The lower the speed, the less the cooling effect. Dirty cooling fins also reduce the cooling effect.

## 15.2 Checking the antifreeze and coolant level



### Warning

**Danger of scalding** During motorcycle operation, the coolant gets very hot and is under pressure.

- Do not remove the radiator cap, radiator hoses or other cooling system components when the engine is hot. Allow the engine and cooling system to cool down. In case of scalding, rinse immediately with lukewarm water.



## Warning

**Danger of poisoning** Coolant is poisonous and a health hazard.

- Coolant must not come into contact with the skin, eyes, or clothing. If contact occurs with the eyes, rinse with water immediately and contact a physician. Immediately clean contaminated areas on the skin with soap and water. If coolant is swallowed, contact a physician immediately. Change clothing that is contaminated with coolant. Keep coolant out of reach of children.

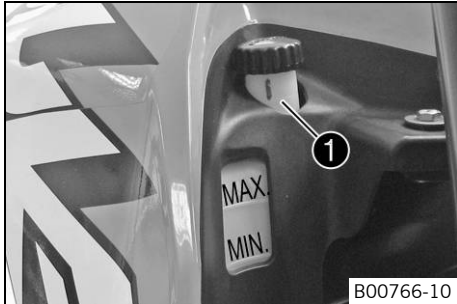

## Condition

The engine is cold.

- Stand the motorcycle upright on a horizontal surface.
- Remove the cap of the compensating tank ❶.
- Check the coolant antifreeze.

-25... -45 °C (-13... -49 °F)

- » If the coolant antifreeze does not meet specifications:
  - Correct the coolant antifreeze.

- Check the coolant level in the compensating tank.

The coolant level must be between **MIN** and **MAX**.

- » If the coolant level does not meet specifications:
  - Correct the coolant level.

## Alternative 1

Coolant (☛ p. 181)

## Alternative 2

Coolant (mixed ready to use) (☛ p. 181)

- Mount the cap of the compensating tank.

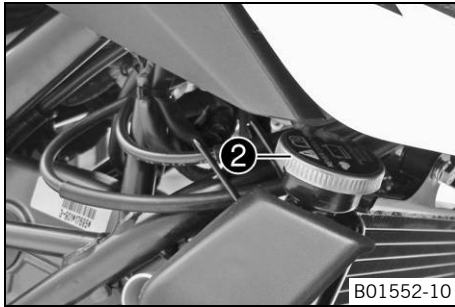

– Remove radiator cap ②.

– Check the coolant antifreeze.

–25... -45 °C (-13... -49 °F)

» If the coolant antifreeze does not meet specifications:

– Correct the coolant antifreeze.

– Check the coolant level in the radiator.

The radiator must be completely filled.

» If the coolant level does not meet specifications:

– Correct the coolant level and find out the cause of the loss.

#### Alternative 1

Coolant (☞ p. 181)

#### Alternative 2

Coolant (mixed ready to use) (☞ p. 181)

» If you had to add more coolant than the specified amount:

> 0.20 l (> 0.21 qt.)

– Fill/bleed the cooling system. ☞ (☞ p. 148)

– Mount the radiator cap.

## 15.3 Checking the coolant level



### Warning

**Danger of scalding** During motorcycle operation, the coolant gets very hot and is under pressure.

- Do not remove the radiator cap, radiator hoses or other cooling system components when the engine is hot. Allow the engine and cooling system to cool down. In case of scalding, rinse immediately with lukewarm water.



## Warning

**Danger of poisoning** Coolant is poisonous and a health hazard.

- Coolant must not come into contact with the skin, eyes, or clothing. If contact occurs with the eyes, rinse with water immediately and contact a physician. Immediately clean contaminated areas on the skin with soap and water. If coolant is swallowed, contact a physician immediately. Change clothing that is contaminated with coolant. Keep coolant out of reach of children.

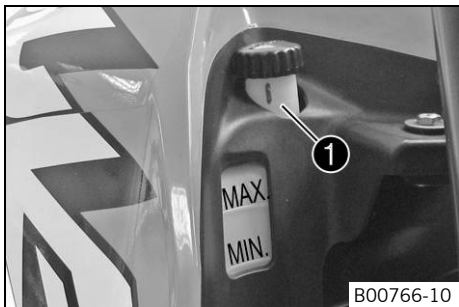

## Condition

The engine is cold.

- Stand the motorcycle upright on a horizontal surface.
- Check the coolant level in the compensating tank **1**.

The coolant level must be between **MIN** and **MAX**.

- » If the coolant level does not meet specifications:
  - Correct the coolant level.

### Alternative 1

Coolant (☞ p. 181)

### Alternative 2

Coolant (mixed ready to use) (☞ p. 181)

- Remove radiator cap **2** and check the coolant level in the radiator.

The radiator must be completely filled.

- » If the coolant level does not meet specifications:
  - Correct the coolant level and find out the cause of the loss.

### Alternative 1

Coolant (☞ p. 181)

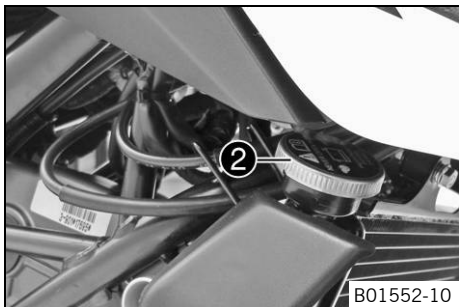

## Alternative 2

Coolant (mixed ready to use) (☞ p. 181)

- » If you had to add more coolant than the specified amount:
  - > 0.20 l (> 0.21 qt.)
    - Fill/bleed the cooling system. 🛠️ (☞ p. 148)
- Mount the radiator cap.

## 15.4 Draining the coolant 🛠️



### Warning

**Danger of scalding** During motorcycle operation, the coolant gets very hot and is under pressure.

- Do not remove the radiator cap, radiator hoses or other cooling system components when the engine is hot. Allow the engine and cooling system to cool down. In case of scalding, rinse immediately with lukewarm water.



### Warning

**Danger of poisoning** Coolant is poisonous and a health hazard.

- Coolant must not come into contact with the skin, eyes, or clothing. If contact occurs with the eyes, rinse with water immediately and contact a physician. Immediately clean contaminated areas on the skin with soap and water. If coolant is swallowed, contact a physician immediately. Change clothing that is contaminated with coolant. Keep coolant out of reach of children.

### Condition

The engine is cold.

### Preparatory work

- Remove the front spoiler. (☞ p. 94)

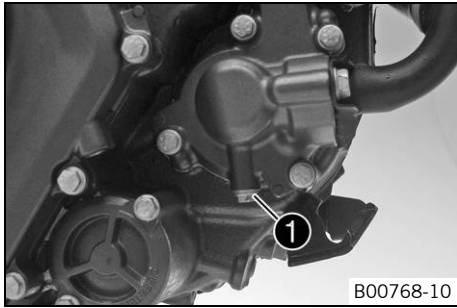

### Main work

- Stand the motorcycle upright.
- Place a suitable container under the engine.
- Remove screw ❶.
- Remove the radiator cap.
- Completely drain the coolant.
- Mount screw ❶ with a new seal ring and tighten it.

### Guideline

Plug, water pump drain hole (125 Duke)	M6	8 Nm (5.9 lbf ft)
Plug, water pump drain hole (200 Duke, 200 Duke CN)	M6	8 Nm (5.9 lbf ft)

## 15.5 Filling/bleeding the cooling system 🛠️



### Warning

**Danger of poisoning** Coolant is poisonous and a health hazard.

- Coolant must not come into contact with the skin, eyes, or clothing. If contact occurs with the eyes, rinse with water immediately and contact a physician. Immediately clean contaminated areas on the skin with soap and water. If coolant is swallowed, contact a physician immediately. Change clothing that is contaminated with coolant. Keep coolant out of reach of children.

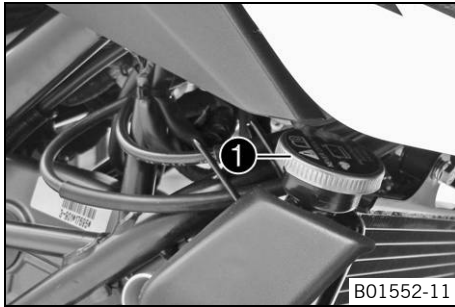

- Remove radiator cap ❶.

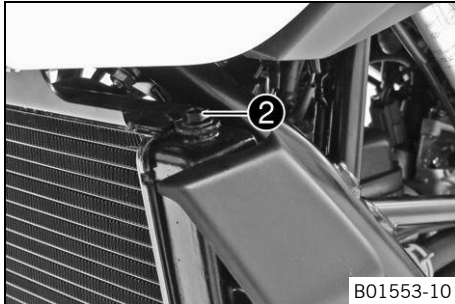

- Open bleeder screw ❷ by three turns.
- Tilt the vehicle slightly to the right.
- Pour in coolant until it emerges without bubbles at the bleeder screw, and then mount and tighten the bleeder screw immediately.

### Alternative 1

Coolant (☛ p. 181)

### Alternative 2

Coolant (mixed ready to use) (☛ p. 181)

- Fill the radiator completely with coolant. Mount the radiator cap.
- Rest the vehicle on the side stand.



### Danger

**Danger of poisoning** Exhaust gases are toxic and inhaling them may result in unconsciousness and/or death.

- When running the engine, always make sure there is sufficient ventilation, and do not start or run the engine in an enclosed space without an effective exhaust extraction system.

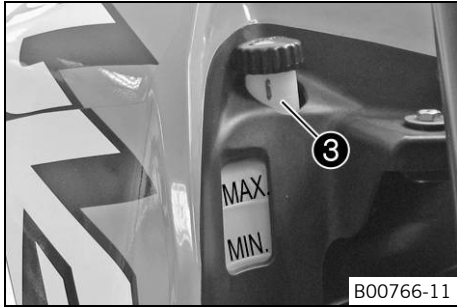

- Start the engine and let it run warm.
- Stop the engine and allow it to cool down.
- When the engine is cool, check the coolant level in the radiator and, if necessary, add coolant.
- Remove the cap of the compensating tank ③ and add coolant until the coolant level is up to the **MAX** mark.
- Mount the cap of the compensating tank.
- Fit the front spoiler. (👉 p. 95)



## 16.1 Checking the play in the throttle cable

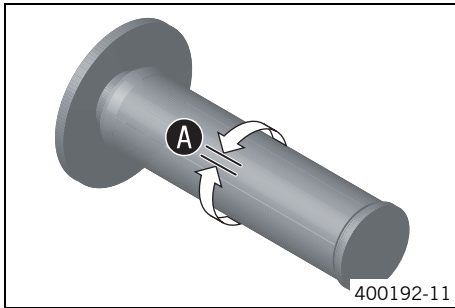

- Check the throttle grip for smooth operation.
- Move the handlebar to the straight-ahead position. Move the throttle grip back and forth to ascertain play **A** in the throttle cable.

Throttle cable play	3... 5 mm (0.12... 0.2 in)
---------------------	----------------------------

- » If the throttle cable play does not meet specifications:
  - Adjust the play in the throttle cable. 🛠️ (📄 p. 152)



### **Danger**

**Danger of poisoning** Exhaust gases are toxic and inhaling them may result in unconsciousness and/or death.

- When running the engine, always make sure there is sufficient ventilation, and do not start or run the engine in an enclosed space without an effective exhaust extraction system.
- 
- Start the engine and let it run idle. Move the handlebar to and fro over the entire steering range.

The idle speed must not change.
---------------------------------

- » If the idle speed changes:
  - Check the throttle cable routing.

## 16.2 Adjusting the play in the throttle cable 🛠️

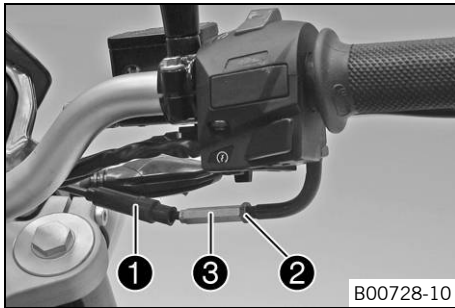

- Move the handlebar to the straight-ahead position.
- Push back sleeve ❶.
- Loosen lock nut ❷.
- Adjust the play in the throttle cable by turning adjusting screw ❸.

Guideline

Throttle cable play	3... 5 mm (0.12... 0.2 in)
---------------------	----------------------------

- Tighten lock nut ❷.
- Slide on sleeve ❶.

## 16.3 Checking the clutch lever play

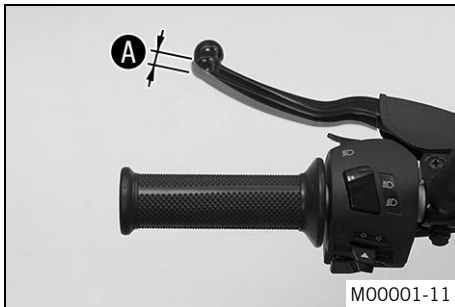

- Check the clutch lever for smooth operation.
- Move the handlebar to the straight-ahead position. Lightly pull the clutch lever and ascertain the clutch lever play A.

Clutch lever play	1... 3 mm (0.04... 0.12 in)
-------------------	-----------------------------

- » If the clutch lever play does not meet specifications:
  - Adjust the clutch cable play. 🛠️ (👉 p. 153)

### Note

**Clutch damage** If there is no play on the clutch lever, the clutch will begin to slip.

- Before operating the motorcycle, always check the clutch lever play.

- Move the handlebar to and fro over the entire steering range.

The clutch lever play must not change.
--

- » If the clutch lever play changes:
  - Check the routing of the clutch cable.

## 16.4 Adjusting the clutch cable play

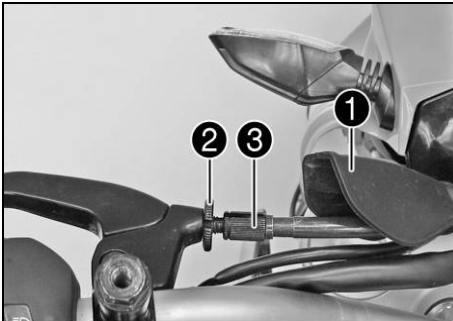

- Move the handlebar to the straight-ahead position.
- Push back sleeve ①.
- Loosen lock nut ②.
- Adjust the play in the clutch level **A** by turning adjusting screw ③.

Guideline

Clutch lever play	1... 3 mm (0.04... 0.12 in)
-------------------	-----------------------------

- Tighten lock nut ②.
- Slide on sleeve ①.

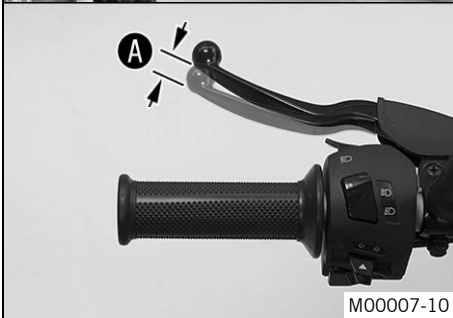

M00007-10

## 17.1 Checking the engine oil level

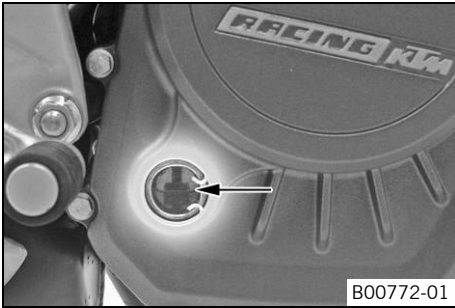

### Condition

The engine is at operating temperature.

### Preparatory work

- Stand the motorcycle upright on a horizontal surface.

### Main work

- Check the engine oil level.

### Info

After switching off the engine, wait one minute before checking the level.

The engine oil must be between the lower and upper edge of the oil level viewer.

- » If the engine oil level is not at the specified level:
  - Add the engine oil. (🔧 p. 157)

## 17.2 Changing the engine oil and oil filter, cleaning the oil screen 🛠️



### Warning

**Danger of scalding** Engine oil and gear oil get very hot when the motorcycle is ridden.

- Wear appropriate protective clothing and safety gloves. In case of burns, rinse immediately with lukewarm water.



### Warning

**Environmental hazard** Hazardous substances cause environmental damage.

- Oil, grease, filters, fuel, cleaners, brake fluid, etc., should be disposed of as stipulated in applicable regulations.

**i Info**

Drain the engine oil only when the engine is warm.

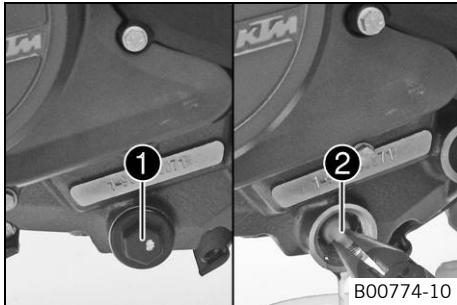

**Preparatory work**

- Remove the front spoiler. (☞ p. 94)
- Stand the motorcycle on its side stand on a horizontal surface.

**Main work**

- Place a suitable container under the engine.
- Remove the oil drain plug ❶ with the O-ring.
- Remove oil screen ❷ with the O-ring.
- Completely drain the engine oil.
- Clean the oil drain plug and oil screen thoroughly.
- Position oil screen ❷ and mount and tighten oil drain plug ❶ with the O-ring.

**Guideline**

Oil drain plug (125 Duke)	M24x1.5	15 Nm (11.1 lbf ft)
Oil drain plug (200 Duke, 200 Duke CN)	M24x1.5	15 Nm (11.1 lbf ft)

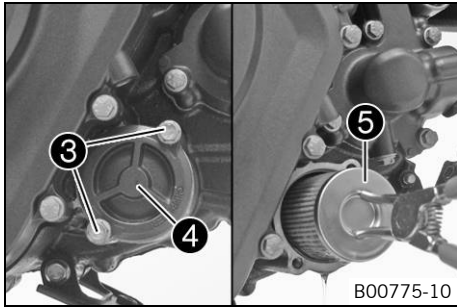

- Remove screws **3**. Remove the oil filter cover **4** with the O-ring.
- Pull oil filter **5** out of the oil filter housing.

Circlip pliers reverse (51012011000)

- Completely drain the engine oil.
- Thoroughly clean the parts and sealing area.

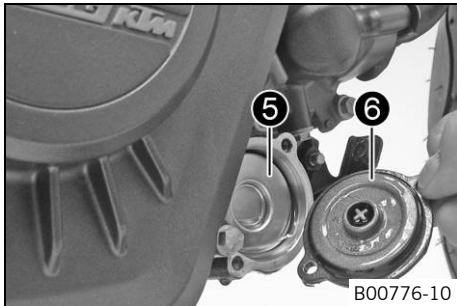

- Insert oil filter **5**.
- Oil the O-ring of the oil filter cover. Mount oil filter cover **6**.
- Mount and tighten the screws.

Guideline

Screw, oil filter cover (125 Duke)	M5	8 Nm (5.9 lbf ft)
Screw, oil filter cover (200 Duke, 200 Duke CN)	M5	8 Nm (5.9 lbf ft)



**Info**

Too little engine oil or poor-quality engine oil results in premature wear to the engine.

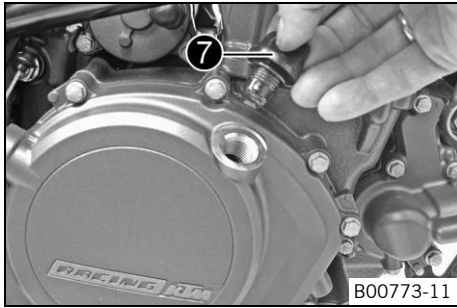

- Remove the oil filler plug **7** with the O-ring from the clutch cover and fill up with engine oil.

Engine oil	1.5 l (1.6 qt.)	External temperature: 0... 50 °C (32... 122 °F)	Engine oil (SAE 15W/50) (☛ p. 182)
		External temperature: -10... 40 °C (14... 104 °F)	Engine oil (SAE 10W/40) (☛ p. 182)

- Install and tighten the oil filler plug with the O-ring.



**Danger**

**Danger of poisoning** Exhaust gases are toxic and inhaling them may result in unconsciousness and/or death.

- When running the engine, always make sure there is sufficient ventilation, and do not start or run the engine in an enclosed space without an effective exhaust extraction system.

- Start the engine and check that it is oil-tight.

**Finishing work**

- Fit the front spoiler. (☛ p. 95)
- Check the engine oil level. (☛ p. 154)

## 17.3 Adding engine oil

**i Info**

Too little engine oil or poor-quality engine oil results in premature wear to the engine.

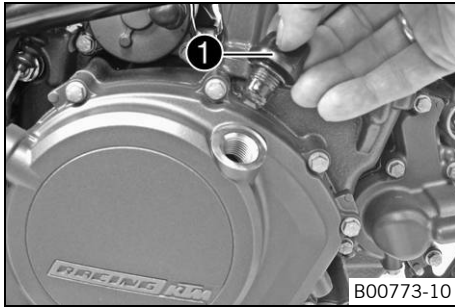

## Main work

- Remove the oil filler plug ① with the O-ring from the clutch cover and fill up with engine oil.

Engine oil (SAE 15W/50) (☛ p. 182)
------------------------------------

Engine oil (SAE 10W/40) (☛ p. 182)
------------------------------------

## Info

For optimal performance of the engine oil, do not mix different types of engine oil.

If appropriate, change the engine oil.

- Install and tighten the oil filler plug with O-ring.

## Danger

**Danger of poisoning** Exhaust gases are toxic and inhaling them may result in unconsciousness and/or death.

- When running the engine, always make sure there is sufficient ventilation, and do not start or run the engine in an enclosed space without an effective exhaust extraction system.

- Start the engine and check that it is oil-tight.

## Finishing work

- Check the engine oil level. (☛ p. 154)



## 18.1 Cleaning the motorcycle

### Note

**Material damage** Damage and destruction of components by high-pressure cleaning equipment.

- When cleaning the vehicle with a pressure cleaner, do not point the water jet directly onto electrical components, connectors, cables, bearings, etc. Maintain a minimum distance of 60 cm between the nozzle of the pressure cleaner and the component. Excessive pressure can cause malfunctions or destroy these parts.



### Warning

**Environmental hazard** Hazardous substances cause environmental damage.

- Oil, grease, filters, fuel, cleaners, brake fluid, etc., should be disposed of as stipulated in applicable regulations.



### Info

If you clean the motorcycle regularly, its value and appearance will be maintained over a long period.  
Avoid direct sunshine on the motorcycle during cleaning.

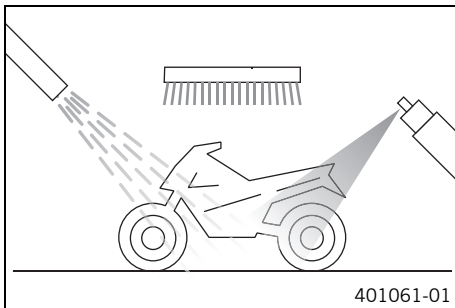

- Seal the exhaust system to keep water out.
- First remove coarse dirt particles with a gentle spray of water.
- Spray very dirty areas with a normal motorcycle cleaner and then clean with a paintbrush.

Motorcycle cleaner (☛ p. 184)

**Info**

Use warm water containing normal motorcycle cleaner and a soft sponge. Never apply motorcycle cleaner to a dry vehicle; always rinse the vehicle with water first.  
If the vehicle was operated in road salt, clean it with cold water. Warm water would enhance the corrosive effects of salt.

---

- After rinsing the motorcycle with a gentle spray of water, allow it to dry thoroughly.
  - Remove the closure of the exhaust system.
- 

**Warning**

**Danger of accidents** Reduced braking efficiency due to a wet or dirty brake system.

- Clean or dry a dirty or wet brake system by riding and braking gently.
- 
- After cleaning, ride the vehicle a short distance until the engine warms up.
- 

**Info**

The heat produced causes water at inaccessible locations in the engine and on the brake system to evaporate.

---

- Push back the sleeves of the handlebar controls to allow any water that has penetrated to evaporate.
  - After the motorcycle has cooled off, lubricate all moving parts and bearings.
  - Clean the chain. (☛ p. 81)
  - Treat bare metal parts (except for brake discs and exhaust system) with anti-corrosion materials.
- 

Preserving materials for paints, metal and rubber (☛ p. 185)

---

- Treat all painted parts with a mild paint polish.

Perfect Finish and high gloss polish for paints (☛ p. 185)

## **i** Info

Do not polish parts that were matte when delivered as this would strongly impair the material quality.

- Treat all plastic parts and powder-coated parts with a mild cleaning and care product.

Special cleaner for glossy and matte paint finishes, metal and plastic surfaces (☛ p. 185)

- Oil the ignition/steering lock.

Universal oil spray (☛ p. 185)

## 18.2 Checks and maintenance steps for winter operation

### **i** Info

If the motorcycle is used in the winter, salt can be expected on the roads. Precautions need to be taken against road salt corrosion. If the vehicle was operated in road salt, clean it with cold water after riding. Warm water would enhance the corrosive effects of salt.

- Clean the motorcycle. (☛ p. 159)
- Clean the brakes.

### **i** Info

After **EVERY** trip on salted roads, thoroughly wash the brake calipers and brake linings with cold water and dry carefully. This should be done after the parts are cooled down and while they are installed.

After riding on salted roads, thoroughly wash the motorcycle with cold water and dry it well.

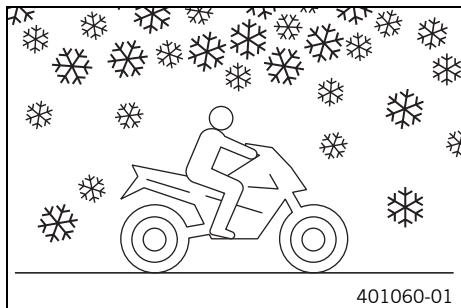

401060-01

- Treat the engine, swingarm, and all other bright and zinc-plated parts (except for the brake discs) with a wax-based corrosion inhibitor.
- 



### Info

Corrosion inhibitor is not permitted to come in contact with the brake discs as this would greatly reduce the braking force.

---

- Clean the chain. (🔧 p. 81)

## 19.1 Storage

### **i** Info

If you want to garage the motorcycle for a longer period, take the following steps. Before storing the motorcycle, check all parts for function and wear. If service, repairs or replacements are necessary, you should do this during the storage period (less workshop overload). In this way, you can avoid long workshop waiting times at the start of the new season.

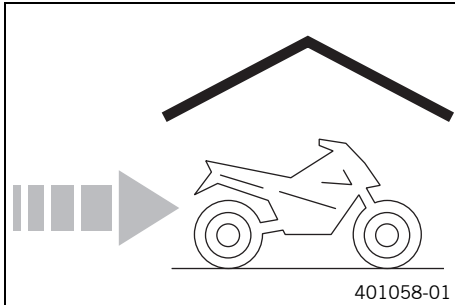

- When refueling for the last time before taking the motorcycle out of service, add fuel additive.

Fuel additive (☞ p. 184)
--------------------------

- Refuel. (☞ p. 69)
- Clean the motorcycle. (☞ p. 159)
- Change the engine oil and oil filter, clean the oil screen. 🛠️ (☞ p. 154)
- Check the antifreeze and coolant level. (☞ p. 143)
- Check the tire air pressure. (☞ p. 119)
- Remove the battery. 🛠️ (☞ p. 121)
- Recharge the battery. 🛠️ (☞ p. 123)

### Guideline

Storage temperature of battery without direct sunlight	0... 35 °C (32... 95 °F)
--	--------------------------

- Store the vehicle in a dry location that is not subject to large fluctuations in temperature.

### **i** Info

KTM recommends jacking up the motorcycle.

- Raise the motorcycle with the rear wheel stand. (🔧 p. 75)
- Raise the motorcycle with the front wheel stand. (🔧 p. 76)
- Cover the motorcycle with a tarp or similar cover that is permeable to air.



## Info

Do not use non-porous materials since they prevent humidity from escaping, thus causing corrosion.

Avoid running the engine for a short time only. Since the engine cannot warm up properly, the water vapor produced during combustion condenses and causes valves and exhaust system to rust.

## 19.2 Preparing for use after storage

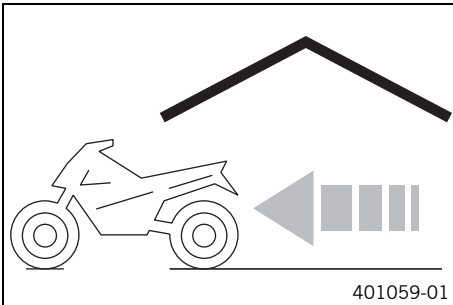

- Take the motorcycle off of the front wheel stand. (🔧 p. 77)
- Take the motorcycle off of the rear wheel stand. (🔧 p. 75)
- Recharge the battery. 🔌 (🔧 p. 123)
- Install the battery. 🔌 (🔧 p. 122)
- Set the clock. (🔧 p. 46)
- Perform checks and maintenance steps when preparing for use. (🔧 p. 59)
- Take a test ride.

Faults	Possible cause	Action
Engine does not crank when the electric starter button is pressed	Operating error	– Go through the steps of starting the engine. (☞ p. 60)
	Battery discharged	– Recharge the battery. 🛠️ (☞ p. 123)
	Fuse <b>1</b> , <b>3</b> , <b>4</b> , or <b>8</b> is blown	– Change the fuses of individual power consumers. (☞ p. 127)
	No ground connection present	– Check the ground connection.
Engine turns only if the clutch lever is drawn	The vehicle is in gear	– Shift gear to neutral.
	The vehicle is in gear and the side stand is folded out	– Shift gear to neutral.
Engine turns but does not start	Operating error	– Go through the steps of starting the engine. (☞ p. 60)
	Defect in fuel injection system	– Read out the fault memory using the KTM diagnostics tool. 🛠️
Engine has too little power	Air filter is very dirty	– Change the air filter.
	Fuel filter is very dirty	– Check the fuel pressure. 🛠️
	Defect in fuel injection system	– Read out the fault memory using the KTM diagnostics tool. 🛠️
Engine overheats	Too little coolant in cooling system	– Check the cooling system for leakage. – Check the coolant level. (☞ p. 145)
	Radiator fins very dirty	– Clean the radiator fins.
	Foam formation in cooling system	– Drain the coolant. 🛠️ (☞ p. 147) – Fill/bleed the cooling system. 🛠️ (☞ p. 148)
	Thermostat defective	– Check the thermostat. 🛠️
	Fuse <b>5</b> blown	– Change the fuses of individual power consumers. (☞ p. 127)

Faults	Possible cause	Action
Engine overheats	Defect in radiator fan system	– Check the radiator fan system. 🛠️
The engine diagnosis warning lamp (MIL) lights up red	Defect in fuel injection system	– Read out the fault memory using the KTM diagnostics tool. 🛠️
Engine dies during the trip	Lack of fuel	– Refuel. (🔧 p. 69)
	Fuse <b>1</b> , <b>3</b> , <b>4</b> , or <b>8</b> is blown	– Change the fuses of individual power consumers. (🔧 p. 127)
The ABS warning lamp lights up (Option: With ABS)	ABS fuse is blown	– Change the ABS fuses. (🔧 p. 126)
	Large difference in wheel speeds of the front and rear wheels	– Stop the vehicle, switch off the ignition, and start it again.
	Malfunction in ABS	– Read out the ABS fault memory using the KTM diagnostics tool. 🛠️
High oil consumption	Engine vent hose bent	– Route the vent hose without bends or change it if necessary.
	Engine oil level too high	– Check the engine oil level. (🔧 p. 154)
	Engine oil too thin (low viscosity)	– Change the engine oil and oil filter, clean the oil screen. 🛠️ (🔧 p. 154)
Headlight and parking light are not functioning	Fuse <b>6</b> blown	– Change the fuses of individual power consumers. (🔧 p. 127)
Turn signal, brake light, and horn are not functional	Fuse <b>6</b> blown	– Change the fuses of individual power consumers. (🔧 p. 127)
Time is not (correctly) displayed	Fuse <b>8</b> blown (Option: With ABS)	– Change the fuses of individual power consumers. (🔧 p. 127) – Set the clock. (🔧 p. 46)
	Fuse <b>2</b> blown (Option: Without ABS)	– Change the fuses of individual power consumers. (🔧 p. 127) – Set the clock. (🔧 p. 46)



Faults	Possible cause	Action
Battery discharged	Ignition not switched off when vehicle was parked	<ul style="list-style-type: none"> <li>- Recharge the battery. 🛠️ (🔧 p. 123)</li> </ul>
	Battery is not being charged by alternator	<ul style="list-style-type: none"> <li>- Check the charging voltage. 🛠️</li> <li>- Check the open-circuit current. 🛠️</li> </ul>
Combination instrument shows nothing on the display	Fuse <b>8</b> blown (Option: With ABS)	<ul style="list-style-type: none"> <li>- Change the fuses of individual power consumers. (🔧 p. 127)</li> <li>- Set the clock. (🔧 p. 46)</li> </ul>
	Fuse <b>2</b> blown (Option: Without ABS)	<ul style="list-style-type: none"> <li>- Change the fuses of individual power consumers. (🔧 p. 127)</li> <li>- Set the clock. (🔧 p. 46)</li> </ul>
Speedometer in combination instrument not functioning	Speedometer wiring harness is damaged or plug-in connection is oxidized	<ul style="list-style-type: none"> <li>- Check the wiring harness and plug-in connection.</li> </ul>

## 21.1 Engine

### 21.1.1 125 Duke

Design	1-cylinder 4-stroke engine, water-cooled
Displacement	125 cm <sup>3</sup> (7.63 cu in)
Stroke	47.2 mm (1.858 in)
Bore	58 mm (2.28 in)
Compression ratio	12.8:1
Control	DOHC, 4 valves controlled via cam lever, chain drive
Valve diameter, intake	22.5 mm (0.886 in)
Valve diameter, exhaust	19 mm (0.75 in)
Valve clearance, intake, cold	0.08... 0.12 mm (0.0031... 0.0047 in)
Valve clearance, exhaust, cold	0.13... 0.17 mm (0.0051... 0.0067 in)
Crankshaft bearing	Two ball bearings
Conrod bearing	Sleeve bearing
Pistons	Cast light alloy
Piston rings	1 L-ring, 1 tapered compression piston ring, 1 oil scraper ring
Engine lubrication	Pressure circulation lubrication with one rotary pump
Primary transmission	22:72
Clutch	Clutch in oil bath/mechanically activated
Transmission	6-gear, claw shifted
Transmission ratio	
1st gear	12:34
2nd gear	15:31
3rd gear	18:28

4th gear	21:26
5th gear	22:23
6th gear	24:22
Mixture preparation	Electronically controlled fuel injection
Ignition	Contactless controlled fully electronic ignition with digital ignition adjustment
Alternator	12 V, 238 W
Spark plug	BOSCH VR 5 NE
Spark plug electrode gap	0.8 mm (0.031 in)
Spark plug	BOSCH Super R6 VR 5 NEW
Spark plug electrode gap	1 mm (0.04 in)
Cooling	Water cooling, permanent circulation of coolant by water pump
Idle speed	1,450... 1,550 rpm
Starting aid	Electric starter

## 21.1.2 200 Duke, 200 Duke CN

Design	1-cylinder 4-stroke engine, water-cooled
Displacement	200 cm <sup>3</sup> (12.2 cu in)
Stroke	49 mm (1.93 in)
Bore	72 mm (2.83 in)
Compression ratio	11,5:1
Control	DOHC, 4 valves controlled via cam lever, chain drive
Valve diameter, intake	28.5 mm (1.122 in)
Valve diameter, exhaust	24 mm (0.94 in)

Valve clearance, intake, cold	0.08... 0.12 mm (0.0031... 0.0047 in)
Valve clearance, exhaust, cold	0.13... 0.17 mm (0.0051... 0.0067 in)
Crankshaft bearing	Two ball bearings
Conrod bearing	Sleeve bearing
Pistons	Cast light alloy
Piston rings	1 L-ring, 1 tapered compression piston ring, 1 oil scraper ring
Engine lubrication	Pressure circulation lubrication with one rotary pump
Primary transmission	22:72
Clutch	Clutch in oil bath/mechanically activated
Transmission	6-gear, claw shifted
Transmission ratio	
1st gear	12:34
2nd gear	15:31
3rd gear	18:28
4th gear	21:26
5th gear	22:23
6th gear	24:22
Mixture preparation	Electronically controlled fuel injection
Ignition	Contactless controlled fully electronic ignition with digital ignition adjustment
Alternator	12 V, 238 W
Spark plug	BOSCH VR 5 NE
Spark plug electrode gap	0.8 mm (0.031 in)
Spark plug	BOSCH Super R6 VR 5 NEW
Spark plug electrode gap	1 mm (0.04 in)

Cooling	Water cooling, permanent circulation of coolant by water pump
Idle speed	1,450... 1,550 rpm
Starting aid	Electric starter

## 21.2 Engine tightening torques

Oil nozzle	M5	6 Nm (4.4 lbf ft)	Loctite® 243™
Screw, engine vent plate	M5	7 Nm (5.2 lbf ft)	Loctite® 243™
Screw, oil filter cover	M5	8 Nm (5.9 lbf ft)	–
Screw, retaining bracket	M5	6 Nm (4.4 lbf ft)	Loctite® 243™
Screw, retaining bracket, stator cable	M5	8 Nm (5.9 lbf ft)	Loctite® 243™
Screw, stator	M5	8 Nm (5.9 lbf ft)	Loctite® 243™
Cylinder head screw	M6	12 Nm (8.9 lbf ft)	–
Nut, water pump impeller	M6	10 Nm (7.4 lbf ft)	Loctite® 243™
Plug, water pump drain hole	M6	8 Nm (5.9 lbf ft)	–
Screw, alternator cover	M6	12 Nm (8.9 lbf ft)	–
Screw, bearing retainer	M6	12 Nm (8.9 lbf ft)	Loctite® 243™
Screw, camshaft bearing bridge	M6	11 Nm (8.1 lbf ft)	–
Screw, chain securing guide	M6	11 Nm (8.1 lbf ft)	Loctite® 243™
Screw, clutch cover	M6	12 Nm (8.9 lbf ft)	–
Screw, engine case	M6x40	12 Nm (8.9 lbf ft)	–
Screw, engine case	M6x60	12 Nm (8.9 lbf ft)	Loctite® 243™
Screw, freewheel gear retaining bracket	M6	12 Nm (8.9 lbf ft)	Loctite® 243™
Screw, locking lever	M6	12 Nm (8.9 lbf ft)	Loctite® 243™
Screw, oil pump	M6	12 Nm (8.9 lbf ft)	Loctite® 243™

# 21 TECHNICAL DATA

Screw, retaining bracket, shaft seal ring, clutch cover	M6	11 Nm (8.1 lbf ft)	Loctite® 243™
Screw, shift drum locating	M6	12 Nm (8.9 lbf ft)	Loctite® 243™
Screw, starter motor	M6	12 Nm (8.9 lbf ft)	–
Screw, timing chain tensioner	M6	12 Nm (8.9 lbf ft)	–
Screw, timing chain tensioning rail	M6	12 Nm (8.9 lbf ft)	Loctite® 243™
Screw, valve cover	M6	12 Nm (8.9 lbf ft)	–
Screw, water pump cover	M6	12 Nm (8.9 lbf ft)	–
Nut, conrod bearing (125 Duke)	M7	24 Nm (17.7 lbf ft)	–
Screw, conrod bearing (200 Duke, 200 Duke CN)	M7	24 Nm (17.7 lbf ft)	–
Nut, exhaust flange	M8	22 Nm (16.2 lbf ft)	–
Screw, balancer shaft gear	M8	20 Nm (14.8 lbf ft)	Loctite® 243™
Screw, camshaft drive sprocket	M8	20 Nm (14.8 lbf ft)	Loctite® 243™
Screw, return spring, quick shifter	M8	12 Nm (8.9 lbf ft)	Loctite® 243™
Stud, exhaust flange	M8	22 Nm (16.2 lbf ft)	–
Cylinder head screw	M10	Step 1 20 Nm (14.8 lbf ft) Step 2 40 Nm (29.5 lbf ft)	Thread is oiled, head flat is greased
Oil pressure sensor	M10	14 Nm (10.3 lbf ft)	–
Rotor screw	M10	46 Nm (33.9 lbf ft)	Loctite® 243™
Water temperature sensor	M10	14 Nm (10.3 lbf ft)	–
Spark plug	M12	15 Nm (11.1 lbf ft)	–
Nut, inner clutch hub	M14LH	60 Nm (44.3 lbf ft)	Loctite® 243™
Nut, primary gear	M14	55 Nm (40.6 lbf ft)	–

Nut, timing chain sprocket	M14	55 Nm (40.6 lbf ft)	Loctite® 243™
Oil drain plug	M24x1.5	15 Nm (11.1 lbf ft)	–

## 21.3 Capacities

### 21.3.1 Engine oil

Engine oil	1.5 l (1.6 qt.)	External temperature: 0... 50 °C (32... 122 °F)	Engine oil (SAE 15W/50) (☛ p. 182)
		External temperature: –10... 40 °C (14... 104 °F)	Engine oil (SAE 10W/40) (☛ p. 182)

### 21.3.2 Coolant

Coolant	1 l (1 qt.)	Coolant (☛ p. 181)
		Coolant (mixed ready to use) (☛ p. 181)

### 21.3.3 Fuel

Total fuel tank capacity, approx.	10.5 l (2.77 US gal)	Super unleaded (ROZ 95/RON 95/PON 91) (☛ p. 183)
Fuel reserve, approx.	1.5 l (1.6 qt.)	

## 21.4 Chassis

Frame	Lattice frame of steel tubes, powder-coated
Fork	<b>WP Suspension</b>
Shock absorber	<b>WP Suspension</b>
Brake system	

# 21 TECHNICAL DATA

Front	Disc brake with four-pot brake caliper
Rear	Disc brake with single-piston brake caliper, floating
Suspension travel	
Front	150 mm (5.91 in)
Rear	150 mm (5.91 in)
Brake discs - diameter (Option: With ABS)	
Front	300 mm (11.81 in)
Rear	230 mm (9.06 in)
Brake discs - diameter (Option: Without ABS)	
Front	280 mm (11.02 in)
Rear	230 mm (9.06 in)
Brake discs - wear limit	
Front	3.6 mm (0.142 in)
Rear	3.6 mm (0.142 in)
Tire air pressure, solo	
Front	2.0 bar (29 psi)
Rear	2.0 bar (29 psi)
Tire air pressure with passenger/full payload	
Front	2.0 bar (29 psi)
Rear	2.2 bar (32 psi)
Secondary ratio (125 Duke)	14:45
Secondary ratio (200 Duke, 200 Duke CN)	14:42
Chain	5/8 x 1/4" (520) O-ring
Steering head angle	65°
Wheelbase	1,367±15 mm (53.82±0.59 in)



Seat height, unloaded	810 mm (31.89 in)
Ground clearance, unloaded	170 mm (6.69 in)
Weight without fuel, approx. (125 Duke)	129.5 kg (285.5 lb.)
Weight without fuel, approx. (200 Duke without ABS)	131 kg (289 lb.)
Weight without fuel, approx. (200 Duke with ABS)	132 kg (291 lb.)

## 21.5 Electrical system

Battery (125 Duke)	FTZ-7	Battery voltage: 12 V Nominal capacity: 6 Ah Maintenance-free
Battery (200 Duke, 200 Duke CN)	FTZ-9	Battery voltage: 12 V Nominal capacity: 8 Ah Maintenance-free
Fuse	75011088010	10 A
Fuse	75011088015	15 A
Fuse (Option: With ABS)	90111088025	25 A
Fuse	75011088030	30 A
Headlight	H4/socket P43t	12 V 60/55 W
Parking light	W5W/socket W2.1x9.5d	12 V 5 W
Instrument lights and indicator lamps	LED	
Turn signal	LED	
Brake/tail light	LED	
License plate lamp	LED	

## 21.6 Tires

<b>Front tires</b>	<b>Rear tires</b>
<b>110/70 R 17 M/C 54S TL</b> MRF revz FC	<b>150/60 R 17 M/C 66S TL</b> MRF revz C
Additional information is available in the Service section under: <a href="http://www.ktm.com">http://www.ktm.com</a>	

## 21.7 Fork

Fork part number	90101000044	
Fork	<b>WP Suspension</b>	
Fork length	736 mm (28.98 in)	
Fork oil	450 ml (15.21 fl. oz.)	Fork oil (SAE 4) (48601166S1) (☛ p. 183)

## 21.8 Shock absorber

Shock absorber part number	90604010000	
Shock absorber	<b>WP Suspension</b>	
Spring preload		
Standard	3 clicks	
Full payload	6 clicks	
Static sag	15 mm (0.59 in)	
Riding sag	45... 50 mm (1.77... 1.97 in)	
Fitted length	300 mm (11.81 in)	

## 21.9 Chassis tightening torques

Screw, chain guard	EJOT PT®	4 Nm (3 lbf ft)	–
Screw, headlight	EJOT PT®	4 Nm (3 lbf ft)	–
Remaining screws, chassis	M4	4 Nm (3 lbf ft)	–
Screw, EFI control unit	M4	4 Nm (3 lbf ft)	–
Screw, trim, subframe, bottom	M4	2 Nm (1.5 lbf ft)	–
Remaining screws, chassis	M5	5 Nm (3.7 lbf ft)	–
Screw, ABS hose clamp (Option: With ABS)	M5	8 Nm (5.9 lbf ft)	–
Screw, brake fluid reservoir of rear brake	M5	6 Nm (4.4 lbf ft)	Loctite® 243™
Screw, brake line holder, rear	M5	8 Nm (5.9 lbf ft)	Loctite® 243™
Screw, fuel pump	M5	5 Nm (3.7 lbf ft)	–
Screw, fuel tank closure flange	M5	3 Nm (2.2 lbf ft)	–
Screw, fuel tank cover	M5	4 Nm (3 lbf ft)	–
Screw, fuel tank trim	M5	5 Nm (3.7 lbf ft)	–
Screw, license plate holder	M5	11 Nm (8.1 lbf ft)	–
Screw, rollover sensor	M5	6 Nm (4.4 lbf ft)	Loctite® 243™
Screw, side stand switch	M5	5 Nm (3.7 lbf ft)	Loctite® 243™
Screw, spoiler	M5	5 Nm (3.7 lbf ft)	–
Screw, subframe cover, bottom	M5	5 Nm (3.7 lbf ft)	Loctite® 243™
Screw, windshield	M5	3 Nm (2.2 lbf ft)	–
Nut, foot brake lever adjustment	M6	10 Nm (7.4 lbf ft)	–
Nut, radiator	M6	5 Nm (3.7 lbf ft)	–
Remaining nuts, chassis	M6	15 Nm (11.1 lbf ft)	–

# 21 TECHNICAL DATA

Remaining screws, chassis	M6	10 Nm (7.4 lbf ft)	–
Screw, air filter box	M6	6 Nm (4.4 lbf ft)	–
Screw, bottom of rear part	M6	11 Nm (8.1 lbf ft)	–
Screw, brake fluid reservoir of rear brake	M6	9 Nm (6.6 lbf ft)	–
Screw, cable holder, side stand switch	M6	9 Nm (6.6 lbf ft)	<b>Loctite® 243™</b>
Screw, chain sliding guard	M6	9 Nm (6.6 lbf ft)	<b>Loctite® 243™</b>
Screw, compensating tank	M6	11 Nm (8.1 lbf ft)	–
Screw, foot brake cylinder	M6	9 Nm (6.6 lbf ft)	<b>Loctite® 243™</b>
Screw, front fender	M6	11 Nm (8.1 lbf ft)	–
Screw, front seat fixing	M6	5 Nm (3.7 lbf ft)	–
Screw, fuel tank	M6	11 Nm (8.1 lbf ft)	–
Screw, headlight holder	M6	11 Nm (8.1 lbf ft)	–
Screw, headlight mask	M6	11 Nm (8.1 lbf ft)	–
Screw, ignition coil	M6	9 Nm (6.6 lbf ft)	–
Screw, license plate holder	M6	14 Nm (10.3 lbf ft)	–
Screw, magnetic holder on side stand	M6	5 Nm (3.7 lbf ft)	<b>Loctite® 243™</b>
Screw, radiator bracket	M6	6 Nm (4.4 lbf ft)	–
Screw, radiator holder	M6	9 Nm (6.6 lbf ft)	–
Screw, rear splash protector	M6	9 Nm (6.6 lbf ft)	–
Screw, rollover sensor holder	M6	11 Nm (8.1 lbf ft)	–
Screw, seat	M6	11 Nm (8.1 lbf ft)	–
Screw, shift activation	M6	11 Nm (8.1 lbf ft)	<b>Loctite® 243™</b>
Screw, voltage regulator	M6	10 Nm (7.4 lbf ft)	–
Screw, voltage regulator holder	M6	15 Nm (11.1 lbf ft)	–

Screw, wheel speed sensor holder (Option: With ABS)	M6	8 Nm (5.9 lbf ft)	–
Remaining nuts, chassis	M8	30 Nm (22.1 lbf ft)	–
Remaining screws, chassis	M8	25 Nm (18.4 lbf ft)	–
Screw, bottom triple clamp	M8	15 Nm (11.1 lbf ft)	–
Screw, engine bearer on frame	M8	30 Nm (22.1 lbf ft)	–
Screw, foot brake lever	M8	15 Nm (11.1 lbf ft)	<b>Loctite® 243™</b>
Screw, fork stub	M8	15 Nm (11.1 lbf ft)	–
Screw, front brake disc	M8	30 Nm (22.1 lbf ft)	<b>Loctite® 243™</b>
Screw, front wheel spindle	M8	30 Nm (22.1 lbf ft)	–
Screw, handlebar clamp	M8	21 Nm (15.5 lbf ft)	–
Screw, handrail	M8	31 Nm (22.9 lbf ft)	–
Screw, horn	M8	7 Nm (5.2 lbf ft)	–
Screw, rear brake disc	M8	30 Nm (22.1 lbf ft)	<b>Loctite® 243™</b>
Screw, rear footrest bracket	M8	26 Nm (19.2 lbf ft)	<b>Loctite® 243™</b>
Screw, shift lever	M8	15 Nm (11.1 lbf ft)	<b>Loctite® 243™</b>
Screw, top triple clamp	M8	11 Nm (8.1 lbf ft)	–
Screw, front brake caliper	M8x1	27 Nm (19.9 lbf ft)	<b>Loctite® 243™</b>
Fitting side stand	M10	34 Nm (25.1 lbf ft)	–
Fitting, engine mounting bracket	M10	55 Nm (40.6 lbf ft)	–
Nut, mirror	M10	16 Nm (11.8 lbf ft)	–
Remaining nuts, chassis	M10	50 Nm (36.9 lbf ft)	–
Remaining screws, chassis	M10	45 Nm (33.2 lbf ft)	–
Fitting, handlebar support	M10x1.25	21 Nm (15.5 lbf ft)	–
Nut, rear sprocket screw	M10x1.25	32 Nm (23.6 lbf ft)	–

# 21 TECHNICAL DATA

Nut, turn signal	M10x1.25	6 Nm (4.4 lbf ft)	–
Screw, front footrest bracket	M10x1.25	46 Nm (33.9 lbf ft)	–
Screw, side stand bracket	M10x1.25	25 Nm (18.4 lbf ft)	<b>Loctite® 243™</b>
Screw, top shock absorber	M10x1.25	50 Nm (36.9 lbf ft)	–
Stud, rear sprocket	M10x1.25	50 Nm (36.9 lbf ft)	–
Nut, rear wheel spindle	M14x1.5	90 Nm (66.4 lbf ft)	–
Nut, swingarm pivot	M14x1.5	100 Nm (73.8 lbf ft)	–
Screw, top steering head	M16x1.5	52 Nm (38.4 lbf ft)	–
Swingarm bearing adjusting ring	M22x1	Tighten and ensure that there is no play	–
Nut, steering head	M30x1	Step 1 50 Nm (36.9 lbf ft) 2nd stage (loosen, counter-clockwise) 2 turns Step 3 5 Nm (3.7 lbf ft)	–

## Brake fluid DOT 4 / DOT 5.1

### Standard/classification

- DOT

### Guideline

- Use only brake fluid that complies with the specified standard (see specifications on the container) and that possesses the corresponding properties.

### Recommended supplier

#### Castrol

- RESPONSE BRAKE FLUID SUPER DOT 4

#### Motorex®

- Brake Fluid DOT 5.1

## Coolant

### Guideline

- Use only suitable coolant (even in countries with high temperatures). Using inferior antifreeze can result in corrosion and foaming.
- Use only coolant based on ethylene glycol.

### Mixture ratio

Antifreeze protection: -25... -45 °C (-13... -49 °F)	50 % corrosion inhibitor/antifreeze 50 % distilled water
--	---

## Coolant (mixed ready to use)

Antifreeze	-40 °C (-40 °F)
------------	-----------------

### Recommended supplier

#### Motorex®

- COOLANT M5.0

## Engine oil (SAE 15W/50)

### Standard/classification

- JASO T903 MA (☛ p. 186)
- SAE (☛ p. 186) (SAE 15W/50)

### Guideline

- Use only engine oils that comply with the specified standards (see specifications on the container) and that possess the corresponding properties.

Partially synthetic engine oil

### Recommended supplier

#### Motorex®

- **Formula 4T**

## Engine oil (SAE 10W/40)

### Standard/classification

- JASO T903 MA (☛ p. 186)
- SAE (☛ p. 186) (SAE 10W/40)

### Guideline

- Use only engine oils that comply with the specified standards (see specifications on the container) and that possess the corresponding properties.

Partially synthetic engine oil

### Recommended supplier

#### Motorex®

- **Formula 4T**



## Fork oil (SAE 4) (48601166S1)

### Standard/classification

- SAE (☛ p. 186) (SAE 4)

### Guideline

- Use only oils that comply with the specified standards (see specifications on the container) and that possess the corresponding properties.

## Super unleaded (ROZ 95/RON 95/PON 91)

### Standard/classification

- DIN EN 228 (ROZ 95/RON 95/PON 91)

### Guideline

- Only use unleaded super fuel that matches or is equivalent to the specified fuel grade.
- Fuel with an ethanol content of up to 10 % (E10 fuel) is safe to use.



### Info

Do **not** use fuel containing methanol (e. g. M15, M85, M100) or more than 10 % ethanol (e. g. E15, E25, E85, E100).

---

### Chain cleaner

Recommended supplier

Motorex®

- Chain Clean

### Chain lube for road use

Guideline

Recommended supplier

Motorex®

- Chainlube Road

### Fuel additive

Recommended supplier

Motorex®

- Fuel Stabilizer

### Long-life grease

Recommended supplier

Motorex®

- Bike Grease 2000

### Motorcycle cleaner

Recommended supplier

Motorex®

- Moto Clean

### Perfect Finish and high gloss polish for paints

Recommended supplier

Motorex®

- Moto Polish & Shine

### Preserving materials for paints, metal and rubber

Recommended supplier

Motorex®

- Moto Protect

### Special cleaner for glossy and matte paint finishes, metal and plastic surfaces

Recommended supplier

Motorex®

- Quick Cleaner

### Universal oil spray

Recommended supplier

Motorex®

- Joker 440 Synthetic

## JASO T903 MA

Different technical development directions required a new specification for 4-stroke motorcycles – the JASO T903 MA Standard. Earlier, engine oils from the automobile industry were used for 4-stroke motorcycles because there was no separate motorcycle specification. Whereas long service intervals are demanded for automobile engines, high performance at high engine speeds are in the foreground for motorcycle engines. In most motorcycles, the gearbox and the clutch are lubricated with the same oil as the engine. The JASO MA Standard meets these special requirements.

## SAE

The SAE viscosity classes were defined by the Society of Automotive Engineers and are used for classifying oils according to their viscosity. The viscosity describes only one property of oil and says nothing about quality.

# INDEX

187

## A

ABS	96
Accessories	13
<b>Antifreeze</b>	
checking	143
<b>Antilock brake system</b>	96
<b>Auxiliary substances</b>	13

## B

<b>Baggage</b>	57
<b>Battery</b>	
installing	122
recharging	123
removing	121
<b>Brake discs</b>	
checking	97
<b>Brake fluid</b>	
front brake, adding	99
rear brake, adding	105
<b>Brake fluid level</b>	
front brake, checking	98
rear brake, checking	103
<b>Brake linings</b>	
front brake, checking	100
rear brake, checking	106
<b>Brakes</b>	65

<b>Brakes, applying</b>	65
-------------------------	----

## C

<b>Capacity</b>	
coolant	173
engine oil	157, 173
fuel	70, 173
<b>Chain</b>	
chain dirt accumulation, checking	81
checking	87
cleaning	81
<b>Chain tension</b>	
adjusting	84
checking	82
<b>Chassis number</b>	20
<b>Clutch cable play</b>	
adjusting	153
<b>Clutch lever</b>	22
<b>Clutch lever play</b>	
checking	152
<b>Combination instrument</b>	
activation and test	28
average fuel consumption 1/average fuel consumption 2 menu	40
average fuel consumption 2/service menu	41
average speed/average fuel consumption 1 menu	39
coolant temperature indicator	37
display	34

display <b>TRIP F</b> .....	36	changing .....	154
distance menu 1 <b>TRIP 1</b> .....	44	<b>Engine oil level</b>	
distance menu 2 <b>TRIP 2</b> .....	45	checking .....	154
filling level display in fuel tank .....	35	<b>Engine sprocket</b>	
function buttons .....	32	checking .....	87
indicator lamps .....	33	<b>Environment</b> .....	11
info display .....	38	<b>F</b>	
range/riding time menu .....	43	<b>Figures</b> .....	14
riding time/average speed menu .....	39	<b>Filler cap</b>	
service/range menu .....	42	closing .....	50
total distance menu <b>ODO</b> .....	44	opening .....	48
warning notes .....	29	<b>Filling up</b>	
<b>Coolant</b>		fuel .....	69
draining .....	147	<b>Foot brake lever</b> .....	<b>53</b>
<b>Coolant level</b>		free travel, adjusting .....	102
checking .....	143, 145	free travel, checking .....	101
<b>Cooling system</b> .....	<b>142</b>	<b>Front spoiler</b>	
filling/bleeding .....	148	installing .....	95
<b>Customer service</b> .....	14	removing .....	94
<b>E</b>		<b>Front wheel</b>	
<b>Electric starter button</b> .....	26	installing .....	109
<b>Emergency OFF switch</b> .....	25	removing .....	108
<b>Engine</b>		<b>Fuse</b>	
running in .....	56	individual power consumers, changing .....	127
<b>Engine number</b> .....	20	<b>Fuses, ABS</b>	
<b>Engine oil</b>		changing .....	126
adding .....	157		

<b>G</b>	
Grab handles	51

<b>H</b>	
Hand brake lever	22

<b>Headlight adjustment</b>	
adjusting	139
checking	138

<b>Headlight bulb</b>	
changing	131

High beam flasher button	24
--------------------------	----

Horn button	23
-------------	----

<b>I</b>	
Ignition lock	26

Indicator lamps	33
-----------------	----

<b>K</b>	
Key number	21

<b>Kilometers or miles</b>	
adjusting	45

<b>L</b>	
Light switch	24
Loading the vehicle	57

<b>M</b>	
----------	--

<b>Motorcycle</b>	
cleaning	159
raising with the front wheel stand	76

raising with the rear wheel stand	75
taking off of the front wheel stand	77
taking off of the rear wheel stand	75

<b>O</b>	
<b>Oil filter</b>	
changing	154

<b>Oil screen</b>	
cleaning	154

Operating substances	13
----------------------	----

Owner's Manual	12
----------------	----

<b>P</b>	
Parking	67

<b>Parking light bulb</b>	
changing	134

Passenger footrests	52
---------------------	----

<b>Passenger seat</b>	
mounting	79
removing	78

<b>Play in throttle cable</b>	
adjusting	152
checking	151

<b>Preparing for use</b>	
advice on first use	55
after storage	164
checks and maintenance when preparing for use	59

Protective clothing	11
---------------------	----

## R

<b>Rear hub rubber dampers</b>	
checking	117
<b>Rear sprocket</b>	
checking	87
<b>Rear wheel</b>	
installing	113
Removing	112
<b>Riding</b>	<b>62</b>
starting off	62

## S

<b>Safe operation</b>	10
<b>Seat</b>	
mounting	80
removing	79
<b>Seat lock</b>	50
<b>Service</b>	13
<b>Service schedule</b>	71-72
<b>Shift lever</b>	<b>52</b>
adjusting	74
<b>Shift speed RPM 1</b>	
adjusting	47
<b>Shift speed RPM 2</b>	
adjusting	47
<b>Shifting</b>	62

<b>Shock absorber</b>	
spring preload, adjusting	73
<b>Side stand</b>	54
<b>Spare parts</b>	13
<b>Starting</b>	60
<b>Steering lock</b>	26
<b>Stopping</b>	67
<b>Storage</b>	163

## T

<b>Technical data</b>	
capacities	173
chassis	173
chassis tightening torques	177
electrical system	175
engine	168
engine tightening torques	171
fork	176
shock absorber	176
tires	176
<b>Throttle grip</b>	23
<b>Time</b>	
adjusting	46
<b>Tire air pressure</b>	
checking	119
<b>Tire condition</b>	
checking	118
<b>Tool set</b>	51



# INDEX

<b>Transport</b>	68
<b>Troubleshooting</b>	165-167
<b>Turn signal switch</b>	25
<b>Type label</b>	20

## U

<b>Use definition</b>	8
-----------------------	---

## V

### View of vehicle

front left	16
rear right	18

## W

<b>Warranty</b>	13
-----------------	----

### Winter operation

checks and maintenance steps	161
------------------------------	-----

<b>Work rules</b>	11
-------------------	----



3213117en

02/2014



**KTM-Sportmotorcycle AG**  
3230 Mattighofen/Austria  
<http://www.ktm.com>



Photo: Mitterbauer/KTM