

**350 EXC-F EU  
350 EXC-F SIX DAYS EU  
350 EXC-F AUS  
350 EXC-F USA  
350 XCF-W USA  
350 XCF-W SIX DAYS USA**

Art. no. 3213134en



**KTM**



The work described in these setup instructions must be performed before the vehicle is delivered to the customer.

Read the setup instructions in their entirety before beginning work.

Print out the current **PDI** form found on the **KTM DEALER.NET**.

These setup instructions were written to correspond to the latest state of this series. We reserve the right to make changes in the interest of technical advancement without at the same time updating these setup instructions.

We shall not provide a description of general workshop methods. Likewise, safety rules that apply in a workshop are not specified here. It is assumed that the work will be performed by a fully trained mechanic.

All specifications are non-binding. KTM Sportmotorcycle AG specifically reserves the right to modify or delete technical specifications, prices, colors, forms, materials, services, designs, equipment, etc., without prior notice and without specifying reasons, to adapt these to local conditions, as well as to stop production of a particular model without prior notice. KTM accepts no liability for delivery options, deviations from illustrations and descriptions, as well as misprints and other errors. The models portrayed partly contain special equipment that does not belong to the regular scope of supply.

© 2013 KTM-Sportmotorcycle AG, Mattighofen Austria

All rights reserved

Reproduction, even in part, as well as copying of all kinds, is permitted only with the express written permission of the copyright owner.



ISO 9001(12 100 6061)

According to the international quality management standard ISO 9001, KTM uses quality assurance processes that lead to the maximum possible quality of the products.

Issued by: TÜV Management Service

REG.NO. 12 100 6061

KTM-Sportmotorcycle AG  
5230 Mattighofen, Austria

## 1.1 Symbols used

The meaning of specific symbols is described below.



Indicates an expected reaction (e.g. of a work step or a function).



Indicates an unexpected reaction (e.g. of a work step or a function).



Indicates a page reference (more information is provided on the specified page).



Indicates information with more details or tips.



Indicates the result of a testing step.



Denotes a voltage measurement.



Denotes a current measurement.



Denotes a resistance measurement.

## 1.2 Formats used

The typographical formats used in this document are explained below.

**Proprietary name** Identifies a proprietary name.

**Name<sup>®</sup>** Identifies a protected name.

**Brand<sup>™</sup>** Identifies a trademark.

## 2.1 Unpacking and setting up the vehicle

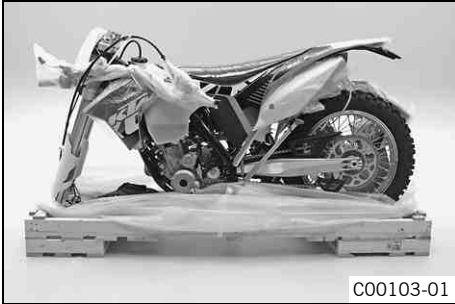

### Packaging 2

- Remove the box and the plastic packaging.

**i Info**

To avoid damaging the motorcycle during the setup, leave the protective film on the vehicle until you have finished.

- Remove the separate enclosure and unpack it. Check that the scope of delivery is complete on the basis of the enclosed packing list.
- Have a lift stand available.

Lift stand (54829055000)

- Carefully loosen and remove the footrest mount.

**i Info**

An assistant prevents the motorcycle from falling over.

- Together with an assistant, take the vehicle off the pallette.
- Position the vehicle on a lift stand.
- Check the vehicle for transport damage.
- Remove the headlight mask with the headlight. (☛ p. 8)

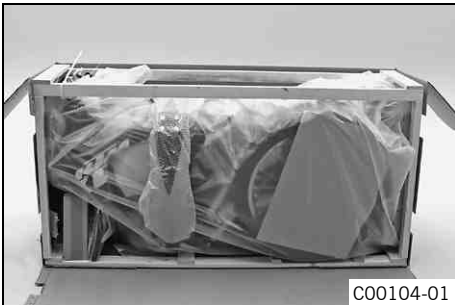

### Package 12

- Remove the box and the plastic packaging.

**i Info**

An assistant prevents the motorcycle from falling over.  
To avoid damaging the motorcycle during the setup, leave the protective film on the vehicle until you have finished.

- Remove the separate enclosure and unpack it. Check that the scope of delivery is complete on the basis of the enclosed packing list.

- Have a lift stand available.

Lift stand (54829055000)

- Together with an assistant, take the vehicle off the pallette.
- Position the vehicle on a lift stand.
- Check the vehicle for transport damage.
- Install the shock absorber. (☛ p. 10)



- Route the clutch line with the clutch master cylinder toward the front between the upper and lower triple clamps.

**(EXC-F EU, EXC-F AUS, EXC-F USA, XCF-W)**

- Position the fork legs and tighten the screws of the triple clamp.

Guideline

Screw, top triple clamp	M8	20 Nm (14.8 lbf ft)
Screw, bottom triple clamp	M8	15 Nm (11.1 lbf ft)



**i Info**

Grooves are milled into the side of the top end of the fork legs. The second milled groove (from the top) in the fork leg must be flush with the top edge of the upper triple clamp.  
Position the bleeder screws toward the front.

**(All SIXDAYS models)**

- Position the fork legs and tighten the screws of the triple clamp.

Guideline

Screw, top triple clamp	M8	17 Nm (12.5 lbf ft)
Screw, bottom triple clamp	M8	15 Nm (11.1 lbf ft)

**i Info**

The rebound damping is located in the right fork leg **REB** (red adjusting screw). The compression damping is located in the left fork leg **COMP** (white adjusting screw). Grooves are milled into the side of the top end of the fork legs. The topmost milled groove must be flush with the top edge of the upper triple clamp. Position the bleeder screws toward the front.

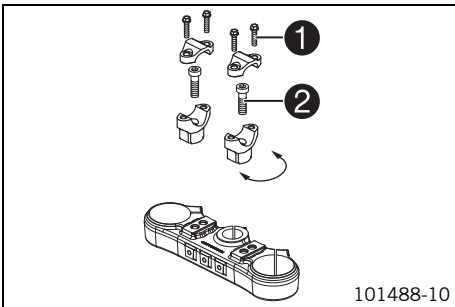

- Remove screws ❶. Take off the handlebar clamps.
- Remove screws ❷. Take off the handlebar supports.
- Place the handlebar supports in the required position. Mount and tighten screws ❷.

Guideline

Screw, handlebar holder	M10	40 Nm (29.5 lbf ft)	<b>Loctite® 243™</b>
-------------------------	-----	------------------------	----------------------

**i Info**

Position the left and right handlebar supports evenly.

- Position the handlebar.

**i Info**

Make sure the cables and wiring are positioned correctly.

- Position the handlebar clamps. Mount and tighten the screws evenly.

Guideline

Screw, handlebar clamp	M8	20 Nm (14.8 lbf ft)
------------------------	----	------------------------

**i Info**

The markings on the handlebar should be at the center of the handlebar clamps. Keep the gap widths equal when tightening.



**(EXC-F EU, EXC-F AUS, EXC-F USA)**

- Insert the indicator lamp with the black and black cable colors into socket ❸.
- Insert the indicator lamp with the black and violet cable colors into socket ❹.
- Insert the indicator lamp with the orange and brown cable colors into socket ❺.
- Insert indicator lamp **LED** with the black and black cable colors into socket ❻.

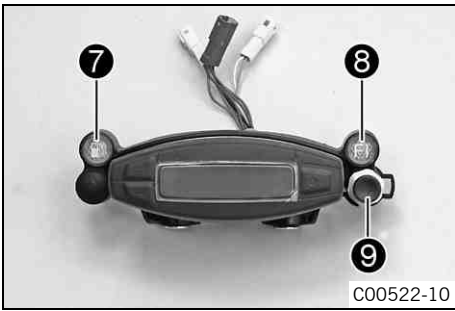

**(XCF-W)**

- Insert the indicator lamp with the orange and brown cable colors into socket 7.
- Insert indicator lamp **LED** with the black and black cable colors into socket 8.
- Connect pull switch 9 with the yellow and white cables.

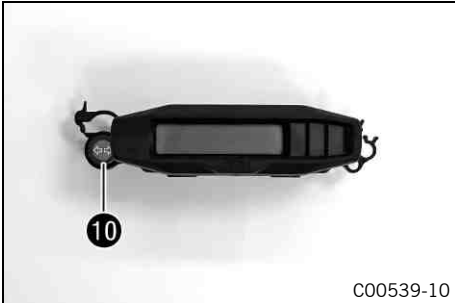

**(EXC-F SIX DAYS)**

- Insert the indicator lamp with the black and violet cable colors into socket 10.

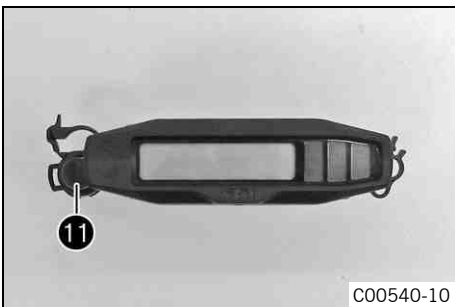

**(XCF-W SIX DAYS)**

- Connect pull switch 11 with the yellow and white cables.
- Position the speedometer and connector board. Mount and tighten screws.

Guideline

Remaining screws, chassis	M6	10 Nm (7.4 lbf ft)
---------------------------	----	-----------------------

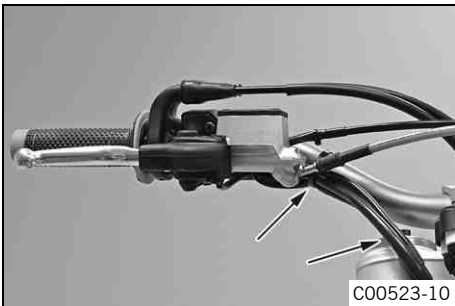

- Position the controls on the right half of the handlebar.

**i Info**  
The routing of the cables can be seen in the figure.

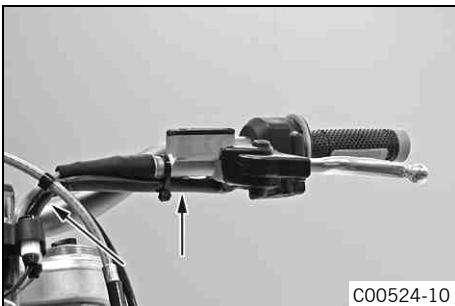

- Position the controls on the left half of the handlebar.

**i Info**  
The figure shows how to route the clutch line and wiring harness.



**(All EXC-F models)**

- Remove the fuel tank.
- Position the turn signal wiring harness against the main wiring harness and secure with cable binders.

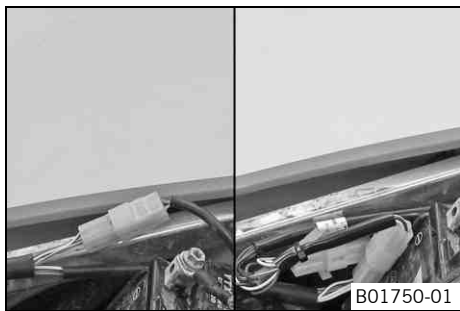

- Disconnect the plug-in connection from the main wiring harness and connect the turn signal wiring harness.
- Install the fuel tank.



- Position the turn signal on each side and mount and tighten nuts.
- Connect plug-in connection of the right turn signal using the black and brown cable colors.
- Connect plug-in connection of the left turn signal using the violet and brown cable colors.

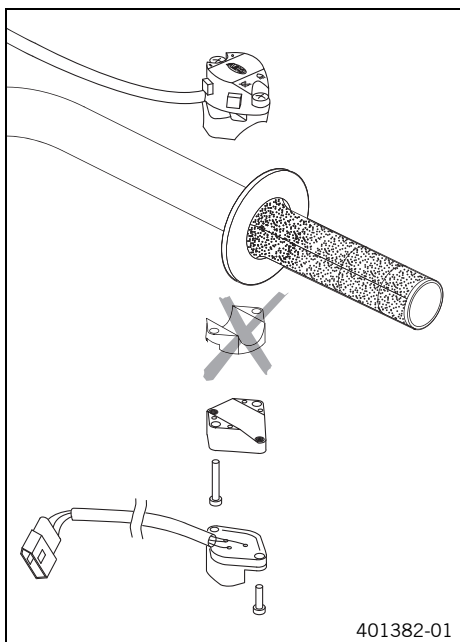

**(All EXC-F models)**

- Mount the turn signal switch.
- Install the front fender. (☛ p. 11)
- Refit the headlight mask with the headlight. (☛ p. 9)
- Install the front wheel. (☛ p. 10)
- Correctly mount the fuel tank breather.



- Secure the handlebar cushion with two cable binders.

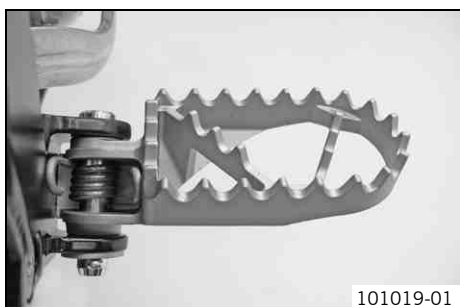

- Mount the footrests with the springs and bolts. Secure the bolts using the washers and pins.

Pliers for footrest spring (58429083000)





**(EXC-F EU, EXC-F AUS, EXC-F SIX DAYS)**

- Mount the license plate holder with the license plate lamp, turn signals, and reflector.
- Connect the electrical components.
- Connect the connector of the left turn signal with connector that is marked red.
- Connect the connector of the right turn signal with the connector that is marked green.



**(EXC-F USA)**

- Mount the license plate holder with the license plate lamp, turn signals, and reflector.
- Connect the electrical components.
- Connect the connector of the left turn signal with connector that is marked red.
- Connect the connector of the right turn signal with the connector that is marked green.



**Warning**

**Risk of injury** Battery acid and battery gases cause serious chemical burns.

- Keep batteries out of the reach of children.
- Wear suitable protective clothing and goggles.
- Avoid contact with battery acid and battery gases.
- Keep sparks and open flames away from the battery. Only charge in well-ventilated rooms.
- In the event of skin contact, rinse with large amounts of water. If battery acid gets in the eyes, rinse with water for at least 15 minutes and contact a physician.

- Fill the battery.



**Info**

Read the notes in the battery package.

- Charge the battery. (☛ p. 12)
- Install the battery. (☛ p. 12)
- Unpack and mount the **KTM PowerParts** included in the delivery (optional).



**Info**

Read the accompanying **KTM PowerParts** installation instructions.

- Apply the label included in the delivery (optional).

**(EXC-F EU, EXC-F AUS, EXC-F USA, XCF-W)**

- Set kilometers or miles. (☛ p. 15)
- Adjust the speedometer functions. (☛ p. 15)
- Set the clock. (☛ p. 15)

**(All SIXDAYS models)**

- Set kilometers or miles. (☛ p. 16)
- Set the speedometer functions. (☛ p. 16)
- Set the clock. (☛ p. 17)
- Refuel. (☛ p. 14)
- Position all controls in their exact positions on the handlebar. Tighten all screws.
- Print out the current **PDI** form found on **KTM DEALER.NET** and perform the delivery inspection.

## 3.1 Raising the motorcycle with the lift stand

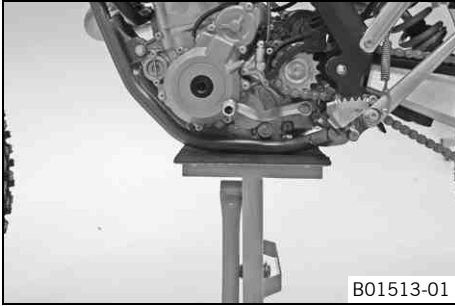

**Note**

**Danger of damage** The parked vehicle may roll away or fall over.

- Always place the vehicle on a firm and even surface.

- Raise the motorcycle at the frame underneath the engine.

Lift stand (54829055000)

- ✓ The wheels should no longer touch the ground.

- Secure the motorcycle against falling over.

## 3.2 Removing the motorcycle from the lift stand

**Note**

**Danger of damage** The parked vehicle may roll away or fall over.

- Always place the vehicle on a firm and even surface.

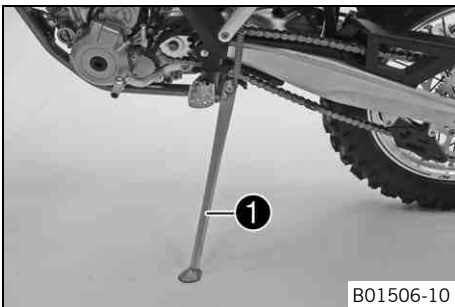

- Remove the motorcycle from the lift stand.
- Remove the lift stand.
- To park the motorcycle, press the side stand ❶ to the ground with your foot and lean the motorcycle on it.

**i Info**

When you are riding, the side stand must be folded up and secured with the rubber band.

## 3.3 Removing headlight mask with headlight

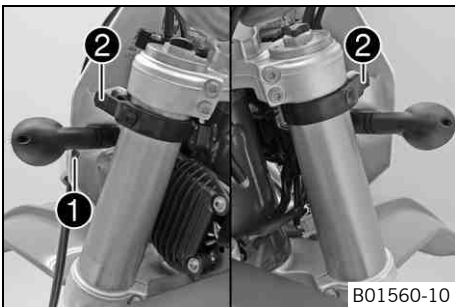

- Switch off all electrical equipment.
- Remove screw ❶ and take off clamp.
- Loosen the rubber band ❷. Push up the headlight mask and swing it forwards.

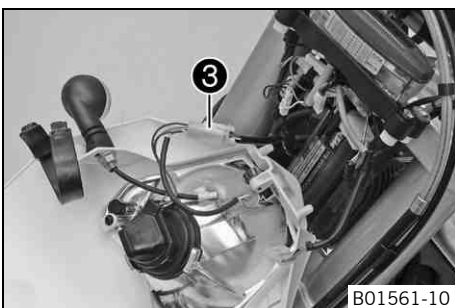

- Pull out the electric plug connector ❸ and remove the headlight mask with the headlight.

## 3.4 Refitting the headlight mask with the headlight

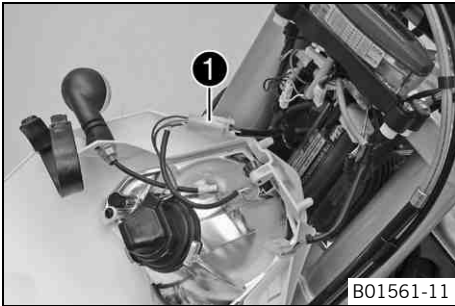

B01561-11

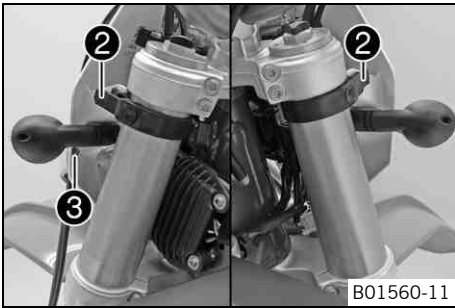

B01560-11

### Main work

- Connect the electric plug connector ❶.

- Position the headlight mask and fix it with the rubber band ❷.



### Info

Ensure that the retaining lugs engage in the fender.

- Position the brake line and wiring harness. Put the clamp on, mount and tighten screw ❸.

### Finishing work

- Check the headlight setting. (☛ p. 9)

## 3.5 Checking the headlight setting

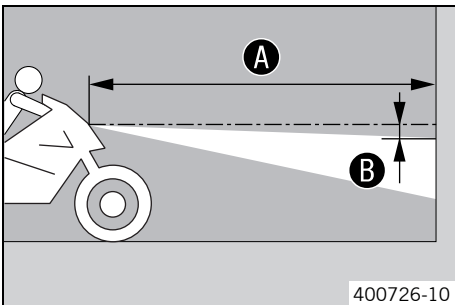

400726-10

- Position the vehicle upright on a horizontal surface in front of a light wall and make a mark at the height of the center of the low beam headlight.
- Make another mark a distance ❷ under the first mark.

### Guideline

Distance ❷	5 cm (2 in)
------------	-------------

- Position the vehicle vertically a distance ❶ away from the wall.

### Guideline

Distance ❶	5 m (16 ft)
------------	-------------

- The rider now sits down on the motorcycle.
- Switch on the low beam.
- Check the headlight setting.

The boundary between light and dark must be exactly on the lower mark for a motorcycle with driver.

- » If the light-dark border does not meet specifications:
  - Adjust the headlight range. (☛ p. 9)

## 3.6 Adjusting the headlight range



B01620-10

### Preparatory work

- Check the headlight setting. (☛ p. 9)

### Main work

- Loosen screw ❶.
- Adjust the headlight range of the headlight by moving it up or down.

### Guideline

The boundary between light and dark must be exactly on the lower mark for a motorcycle with driver (instructions on how to apply the mark: Checking the headlight setting).



### Info

A change in weight on the vehicle may require a correction of the headlight range.

- Tighten screw ❶.

## 3.7 Installing the shock absorber

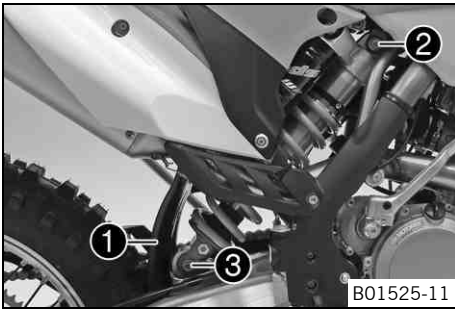

### Main work

- Push splash protector ❶ to the side and position the shock absorber. Mount and tighten screw ❷.

#### Guideline

Screw, top shock absorber	M12	80 Nm (59 lbf ft)	Loctite® 2701™
---------------------------	-----	----------------------	----------------

- Mount and tighten screw ❸.

#### Guideline

Screw, bottom shock absorber	M12	80 Nm (59 lbf ft)	Loctite® 2701™
------------------------------	-----	----------------------	----------------



### Info

The heim joint for the shock absorber at the swing arm is Teflon coated. It must not be greased with grease or with other lubricants. Lubricants dissolve the Teflon coating, thereby drastically reducing the service life.

### Finishing work

- Remove the motorcycle from the lift stand. (☛ p. 8)

## 3.8 Installing the front wheel



### Warning

**Danger of accidents** Reduced braking efficiency due to oil or grease on the brake discs.

- Always keep the brake discs free of oil and grease, and clean them with brake cleaner when necessary.

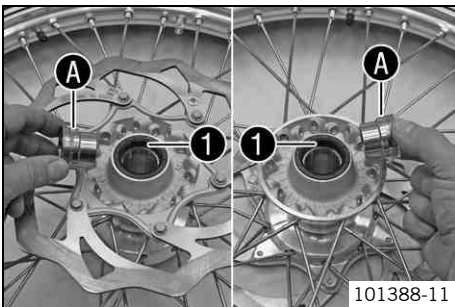

- Check the wheel bearing for damage and wear.
  - » If the wheel bearing is damaged or worn:
    - Change the wheel bearing.
- Clean and grease shaft seal rings ❶ and bearing surface A of the spacers.

Long-life grease (☛ p. 21)

- Insert the spacers.

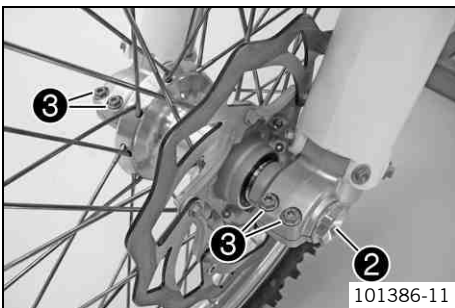

- Position the front wheel and insert the wheel spindle.
  - ✓ The brake linings are correctly positioned.
- Mount and tighten screw ❷.

#### Guideline

Screw, front wheel spindle	M24x1.5	45 Nm (33.2 lbf ft)
----------------------------	---------	------------------------

- Activate the hand brake lever multiple times until the brake linings are in contact with the brake disc.
- Remove the motorcycle from the lift stand. (☛ p. 8)
- Pull the front wheel brake and push down hard on the fork several times to align the fork legs.
- Fully tighten screw ❸.

#### Guideline

Screw, fork stub	M8	15 Nm (11.1 lbf ft)
------------------	----	------------------------

## 3.9 Installing the front fender

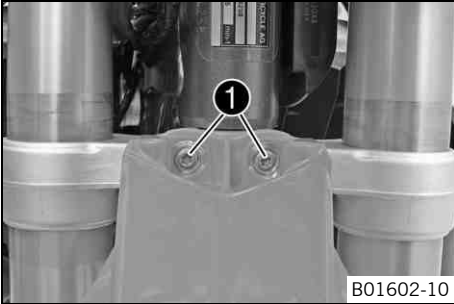

B01602-10

### Main work

- Position the front fender. Mount and tighten screws ❶.

#### Guideline

Remaining screws, chassis	M6	10 Nm (7.4 lbf ft)
---------------------------	----	--------------------

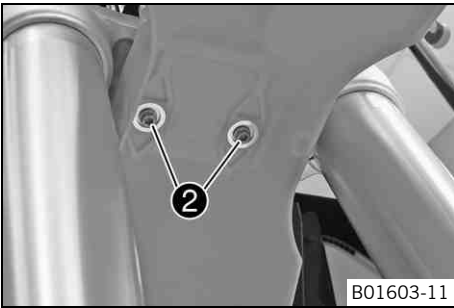

B01603-11

- Mount and tighten screws ❷.

#### Guideline

Remaining screws, chassis	M6	10 Nm (7.4 lbf ft)
---------------------------	----	--------------------

### Finishing work

- Refit the headlight mask with the headlight. (☛ p. 9)
- Check the headlight setting. (☛ p. 9)

## 3.10 Removing the seat

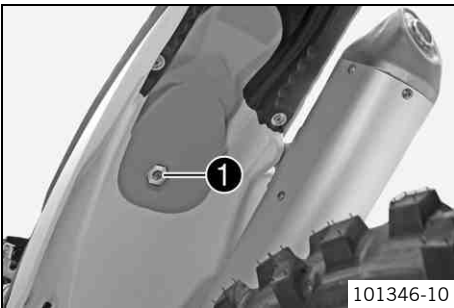

101346-10

- Remove screw ❶.
- Lift up the seat at the rear, pull it back and then remove it from above.

## 3.11 Mounting the seat



B01526-01

- Hook in the front of the seat at the collar sleeve of the fuel tank, lower it at the rear and simultaneously push it forward.
- Make sure that the seat is correctly locked in.
- Mount and tighten the screw of the seat fixing.

#### Guideline

Remaining screws, chassis	M6	10 Nm (7.4 lbf ft)
---------------------------	----	--------------------

## 3.12 Installing the battery

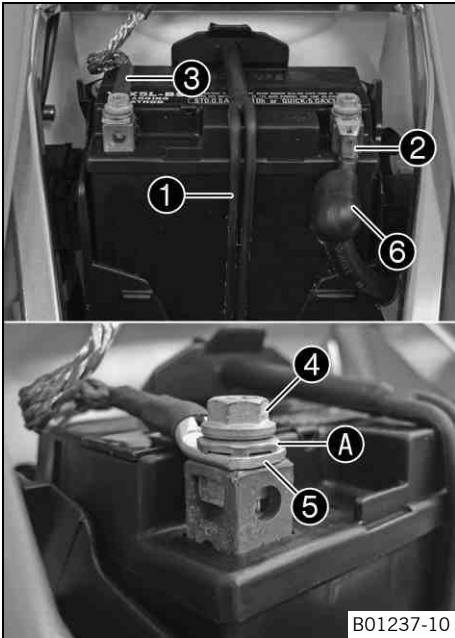

### Main work

- Insert battery into the battery compartment with the terminals facing to the front.

Battery (YTX4L-BS)

- Reconnect rubber band ①.
- Connect positive cable ②.

### Guideline

Screw, battery terminal	M5	2.5 Nm (1.84 lbf ft)
-------------------------	----	-------------------------



### Info

Contact disk **A** must be mounted between screw ④ and cable socket ⑤ with the claws facing down.

- Slide positive terminal cover ⑥ over the positive terminal.
- Connect negative cable ③.

### Guideline

Screw, battery terminal	M5	2.5 Nm (1.84 lbf ft)
-------------------------	----	-------------------------



### Info

Contact disk **A** must be mounted between screw ④ and cable socket ⑤ with the claws facing down.

### Finishing work

- Mount the seat. (☛ p. 11)

## 3.13 Charging the battery



### Warning

**Risk of injury** Battery acid and battery gases cause serious chemical burns.

- Keep batteries out of the reach of children.
- Wear suitable protective clothing and goggles.
- Avoid contact with battery acid and battery gases.
- Keep sparks and open flames away from the battery. Only charge in well-ventilated rooms.
- In the event of skin contact, rinse with large amounts of water. If battery acid gets in the eyes, rinse with water for at least 15 minutes and contact a physician.



### Warning

**Environmental hazard** The battery contains elements that are harmful to the environment.

- Do not discard batteries with the household waste. Dispose of faulty batteries in an environmentally compatible manner. Give the battery to your authorized KTM dealer or dispose of it at a collection point for used batteries.



### Warning

**Environmental hazard** Hazardous substances cause environmental damage.

- Oil, grease, filters, fuel, cleaners, brake fluid, etc., should be disposed of as stipulated in applicable regulations.



### Info

Even when there is no load on the battery, it still loses power steadily. The charge state and the type of charge are very important for the service life of the battery. Rapid recharging with a high charging current shortens the battery's service life. If the charging current, charging voltage and charging time are exceeded, electrolyte escapes through the safety valves. This reduces the battery capacity. If the battery is depleted from starting the vehicle repeatedly, the battery must be charged immediately. If the battery is left in a discharged state for an extended period, it will become over-discharged and sulfate, destroying the battery. The battery is maintenance-free, which means that the acid level does not need to be checked.

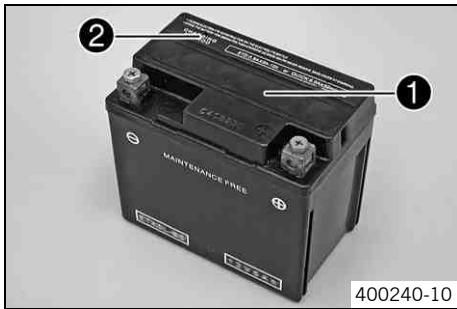

### Preparatory work

- Switch off all power consumers and switch off the engine.
- Remove the seat. (🔧 p. 11)
- Disconnect the negative cable of the battery to avoid damage to the onboard electronics.

### Main work

- Connect the battery charger to the battery. Switch on the battery charger.

Battery charger (58429074000)

You can also use the battery charger to test the open-circuit voltage and starting voltage of the battery, and to test the alternator. With this device, you cannot over-charge the battery.



### Info

Never remove lid ❶.  
Charge the battery with a maximum of 10% of the capacity specified on battery housing ❷.

- Switch off the battery charger after charging. Disconnect the battery.

### Guideline

The charge current, charge voltage, and charge time must not be exceeded.

Charge the battery regularly when the motorcycle is not in use	3 months
--	----------

### Finishing work

- Mount the seat. (🔧 p. 11)

## 3.14 Opening filler cap



### Danger

**Fire hazard** Fuel is highly flammable.

- Never refuel the vehicle near open flames or burning cigarettes, and always switch off the engine first. Be careful that no fuel is spilt, especially on hot vehicle components. Clean up spilt fuel immediately.
- The fuel in the fuel tank expands when warm and may emerge if overfilled. Follow the instructions on refueling.



### Warning

**Danger of poisoning** Fuel is poisonous and a health hazard.

- Fuel must not come into contact with the skin, eyes, or clothing. Do not breathe in the fuel vapors. If contact occurs with the eyes, rinse with water immediately and contact a physician. Immediately clean contaminated areas on the skin with soap and water. If fuel is swallowed, contact a physician immediately. Change clothing that is contaminated with fuel. Store fuel properly in a suitable canister and keep away from children.



### Warning

**Environmental hazard** Improper handling of fuel is a danger to the environment.

- Do not allow fuel to get into the ground water, the ground, or the sewage system.

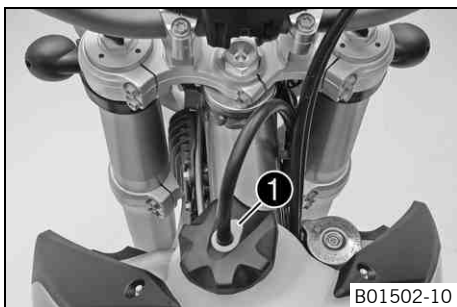

- Press release button ❶, turn filler cap counterclockwise and lift it upwards and remove.

## 3.15 Closing filler cap

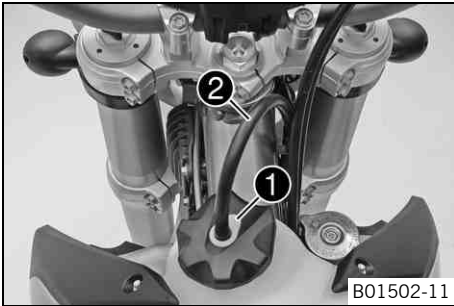

- Replace the filler cap and turn clockwise until the release button ❶ locks in place.



### Info

Route the fuel tank breather hose ❷ without kinking.

## 3.16 Refueling



### Danger

**Fire hazard** Fuel is highly flammable.

- Never refuel the vehicle near open flames or burning cigarettes, and always switch off the engine first. Be careful that no fuel is spilt, especially on hot vehicle components. Clean up spilt fuel immediately.
- The fuel in the fuel tank expands when warm and may emerge if overfilled. Follow the instructions on refueling.



### Warning

**Danger of poisoning** Fuel is poisonous and a health hazard.

- Fuel must not come into contact with the skin, eyes, or clothing. Do not breathe in the fuel vapors. If contact occurs with the eyes, rinse with water immediately and contact a physician. Immediately clean contaminated areas on the skin with soap and water. If fuel is swallowed, contact a physician immediately. Change clothing that is contaminated with fuel.

### Note

**Material damage** Premature clogging of the fuel filter.

- In some countries and regions, the available fuel quality and cleanliness may not be sufficient. This will result in problems with the fuel system.
- Only refuel with clean fuel that meets the specified standards.



### Warning

**Environmental hazard** Improper handling of fuel is a danger to the environment.

- Do not allow fuel to get into the ground water, the ground, or the sewage system.

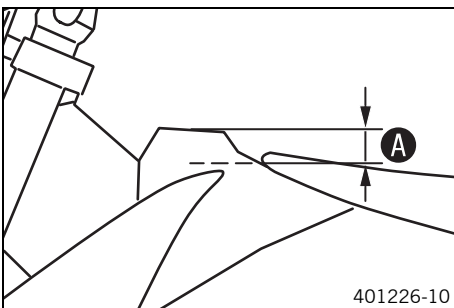

- Switch off engine.
- Open the filler cap. (☛ p. 13)
- Fill the fuel tank with fuel up to measurement A.

### Guideline

Measurement of A	35 mm (1.38 in)	
Total fuel tank capacity, approx. (EXC-F EU, EXC-F AUS, EXC-F SIX DAYS)	9 l (2.4 US gal)	Super unleaded (ROZ 95/RON 95/PON 91) (☛ p. 20)
Total fuel tank capacity, approx. (EXC-F USA, All XCF-W models)	8.5 l (2.25 US gal)	Super unleaded (ROZ 95/RON 95/PON 91) (☛ p. 20)

- Close the filler cap. (☛ p. 14)



## 3.17 EXC-F EU, EXC-F AUS, EXC-F USA, XCF-W

### 3.17.1 Setting kilometers or miles

#### **i** Info

If you change the unit of measure, the **ODO** value is retained and converted accordingly. The values **TR1**, **TR2**, **A1**, **A2** and **S1** are cleared when the unit of measure is changed.

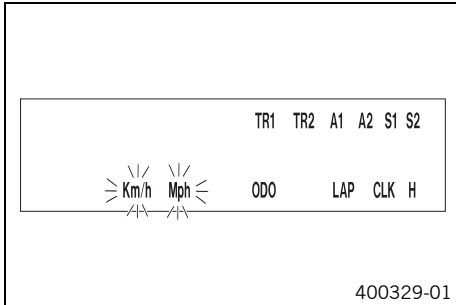

#### Condition

The motorcycle is stationary.

- Press the button briefly and repeatedly until **H** appears at the bottom right of the display.
- Press the button for 3 - 5 seconds.
  - ✓ The Setup menu is displayed and the active functions are shown.
- Press the button repeatedly until the **Km/h/Mph** display flashes.

#### Adjusting Km/h

- Press the button .

#### Adjusting Mph

- Press the button .
- Press the button for 3 - 5 seconds.
  - ✓ The settings are stored and the Setup menu is closed.

#### **i** Info

If no button is pressed for 20 seconds, or if no impulse comes from the wheel speed sensor, the settings are automatically saved and the Setup menu is closed.

### 3.17.2 Adjusting the speedometer functions

#### **i** Info

When the vehicle is delivered, only the **SPEED/H** and **SPEED/ODO** display modes are activated.

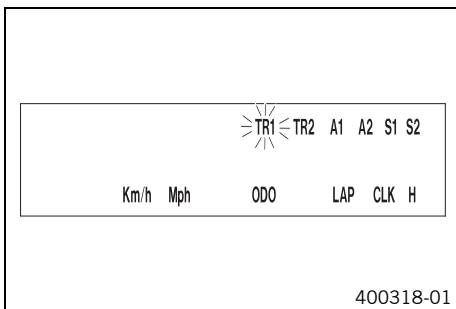

#### Condition

The motorcycle is stationary.

- Press the button briefly and repeatedly until **H** appears at the bottom right of the display.
- Press the button for 3 - 5 seconds.
  - ✓ The Setup menu is displayed and the activated functions are shown.
- Change to the desired function by pressing the button briefly.
  - ✓ The selected function flashes.

#### Activating a function

- Press the button .
  - ✓ The symbol remains on the screen and the display changes to the next function.

#### Deactivating the function

- Press the button .
  - ✓ The symbol on the screen goes out and the display changes to the next function.
- All desired functions are activated or deactivated accordingly.
- Press the button for 3 - 5 seconds.
  - ✓ The settings are stored and the Setup menu is closed.

#### **i** Info

If no button is pressed for 20 seconds, or if no impulse comes from the wheel speed sensor, the settings are automatically saved and the Setup menu is closed.

### 3.17.3 Setting the clock

#### Condition

The motorcycle is stationary.

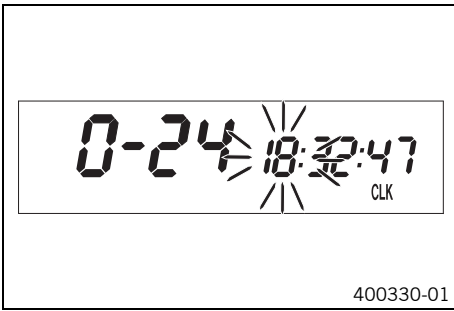

- Press the button briefly and repeatedly until **CLK** appears at the bottom right of the display.
- Press the button for 3 - 5 seconds.
  - ✓ The hour display flashes.
- Set the hour display with the button and/or button .
- Press the button briefly.
  - ✓ The next segment of the display flashes and can be set.
- You can set the following segments in the same way as the hours by pressing the button and the button .

**i Info**  
The seconds can only be set to zero.

- Press the button for 3 - 5 seconds.
  - ✓ The settings are stored and the Setup menu is closed.

**i Info**  
If no button is pressed for 20 seconds, or if no impulse comes from the wheel speed sensor, the settings are automatically saved and the Setup menu is closed.

## 3.18 All SIXDAYS models

### 3.18.1 Setting kilometers or miles

**i Info**  
If you change the unit, the value **ODO** is retained and converted accordingly. The values **TR1**, **TR2**, **A1**, **A2** and **S1** are cleared when the unit of measure is changed.

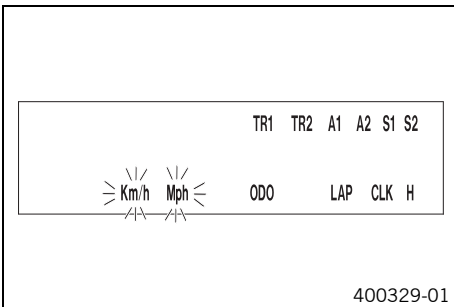

- Condition**  
The motorcycle is stationary.
- Repeatedly press the button briefly until **H** appears at the bottom right of the display.
  - Press the button for 2-3 seconds.
    - ✓ The Setup menu is displayed and the active functions are shown.
  - Repeatedly press the button briefly until **Km/h/Mph** flashes.

**Setting the Km/h**

- Press the button .

**Setting the Mph**

- Press the button .
- Wait 3-5 seconds
  - ✓ The settings are stored.

**i Info**  
If no button is actuated for 10-12 seconds or there is no signal from the wheel speed sensor, then the settings are automatically stored and the Setup menu is closed.

### 3.18.2 Setting the speedometer functions

**i Info**  
When the vehicle is delivered, only the **SPEED/H** and **SPEED/ODO** display modes are activated.

**Condition**  
The motorcycle is stationary.

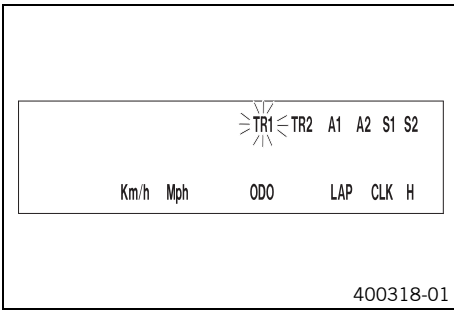

- Repeatedly press the button briefly until **H** appears at the bottom right of the display.
- Press the button for 2–3 seconds.
- ✓ The Setup menu is displayed and the active functions are shown.



**Info**

If no button is pressed for 10–12 seconds, the settings are automatically stored.  
 If no button is actuated for 20 seconds or there is no signal from the wheel speed sensor, then the settings are automatically stored and the Setup menu is closed.

- Repeatedly press the button briefly until the desired function flashes.
- ✓ The selected function flashes.

**Activating the function**

- Press the button .
- ✓ The symbol continues to appear in the display and the next function appears.

**Deactivating a function**

- Press the button .
- ✓ The symbol disappears in the display and the next function appears.

### 3.18.3 Setting the clock

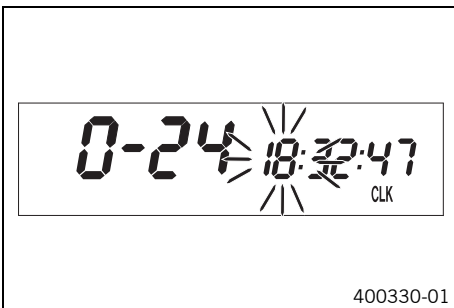

**Condition**

The motorcycle is stationary.

- Repeatedly press the button briefly until **CLK** appears at the bottom right of the display.
- Press the button for 2–3 seconds.
- ✓ The hour display flashes.
- Set the hour display with the button and/or button .
- Wait 3–5 seconds
- ✓ The next segment of the display flashes and can be set.
- You can set the following segments in the same way as the hours by pressing the button and the button .



**Info**

The seconds can only be set to zero.  
 If no button is actuated for 15–20 seconds or there is no signal from the wheel speed sensor, then the settings are automatically stored and the Setup menu is closed.

# 4 TECHNICAL DATA - TIGHTENING TORQUES FOR CHASSIS

Screw, pressure regulator	EJOT PT®	3 Nm (2.2 lbf ft)	–
Spoke nipple, front wheel	M4.5	5... 6 Nm (3.7... 4.4 lbf ft)	–
Spoke nipple, rear wheel	M4.5	5... 6 Nm (3.7... 4.4 lbf ft)	–
Screw, battery terminal	M5	2.5 Nm (1.84 lbf ft)	–
Screw, intake air temperature sensor	M5	2 Nm (1.5 lbf ft)	–
Screw, shock absorber adjusting ring	M5	5 Nm (3.7 lbf ft)	–
Screw, spoiler on fuel tank (EXC-F USA, All XCF-W models)	M5x12	1.5 Nm (1.11 lbf ft)	–
Nut, cable on starter motor	M6	4 Nm (3 lbf ft)	–
Remaining nuts, chassis	M6	10 Nm (7.4 lbf ft)	–
Remaining screws, chassis	M6	10 Nm (7.4 lbf ft)	–
Screw, ball joint of push rod on foot brake cylinder	M6	10 Nm (7.4 lbf ft)	Loctite® 243™
Screw, chain sliding guard	M6	6 Nm (4.4 lbf ft)	Loctite® 243™
Screw, front brake disc	M6	14 Nm (10.3 lbf ft)	Loctite® 243™
Screw, rear brake disc	M6	14 Nm (10.3 lbf ft)	Loctite® 243™
Screw, throttle grip	M6	5 Nm (3.7 lbf ft)	–
Fuel connection on fuel pump	M8	10 Nm (7.4 lbf ft)	–
Nut, foot brake lever stop	M8	20 Nm (14.8 lbf ft)	–
Nut, rear sprocket screw	M8	35 Nm (25.8 lbf ft)	Loctite® 2701™
Nut, rim lock	M8	12 Nm (8.9 lbf ft)	–
Remaining nuts, chassis	M8	25 Nm (18.4 lbf ft)	–
Remaining screws, chassis	M8	25 Nm (18.4 lbf ft)	–
Screw, bottom triple clamp (All SIX- DAYS models)	M8	15 Nm (11.1 lbf ft)	–
Screw, bottom triple clamp (EXC-F EU, EXC-F AUS, EXC-F USA, XCF-W)	M8	15 Nm (11.1 lbf ft)	–
Screw, chain sliding piece	M8	15 Nm (11.1 lbf ft)	–
Screw, engine brace	M8	33 Nm (24.3 lbf ft)	–
Screw, fork stub	M8	15 Nm (11.1 lbf ft)	–
Screw, front brake caliper	M8	25 Nm (18.4 lbf ft)	Loctite® 243™
Screw, handlebar clamp	M8	20 Nm (14.8 lbf ft)	–
Screw, side stand attachment	M8	45 Nm (33.2 lbf ft)	Loctite® 2701™
Screw, subframe	M8	35 Nm (25.8 lbf ft)	Loctite® 2701™
Screw, top steering stem (All SIXDAYS models)	M8	17 Nm (12.5 lbf ft)	Loctite® 243™
Screw, top steering stem (EXC-F EU, EXC-F AUS, EXC-F USA, XCF-W)	M8	20 Nm (14.8 lbf ft)	–
Screw, top triple clamp (All SIXDAYS models)	M8	17 Nm (12.5 lbf ft)	–
Screw, top triple clamp (EXC-F EU, EXC-F AUS, EXC-F USA, XCF-W)	M8	20 Nm (14.8 lbf ft)	–
Engine attachment bolt	M10	60 Nm (44.3 lbf ft)	–
Remaining nuts, chassis	M10	45 Nm (33.2 lbf ft)	–
Remaining screws, chassis	M10	45 Nm (33.2 lbf ft)	–
Screw, handlebar holder	M10	40 Nm (29.5 lbf ft)	Loctite® 243™
Nut, fuel pump fixation	M12	15 Nm (11.1 lbf ft)	–
Screw, bottom shock absorber	M12	80 Nm (59 lbf ft)	Loctite® 2701™
Screw, top shock absorber	M12	80 Nm (59 lbf ft)	Loctite® 2701™
Nut, seat fixing	M12x1	20 Nm (14.8 lbf ft)	–
Nut, swingarm pivot	M16x1.5	100 Nm (73.8 lbf ft)	–
Nut, rear wheel spindle	M20x1.5	80 Nm (59 lbf ft)	–
Screw, top steering head	M20x1.5	12 Nm (8.9 lbf ft)	–
Screw-in nozzles, cooling system	M20x1.5	12 Nm (8.9 lbf ft)	Loctite® 243™

## 4 TECHNICAL DATA - TIGHTENING TORQUES FOR CHASSIS

Screw, front wheel spindle	M24x1.5	45 Nm (33.2 lbf ft)	-
----------------------------	---------	---------------------	---

## Super unleaded (ROZ 95/RON 95/PON 91)

### According to

- DIN EN 228 (ROZ 95/RON 95/PON 91)

### Guideline

- Only use unleaded super fuel that matches or is equivalent to the specified fuel grade.
- Fuel with an ethanol content of up to 10 % (E10 fuel) is safe to use.



### Info

Do **not** use fuel containing methanol (e. g. M15, M85, M100) or more than 10 % ethanol (e. g. E15, E25, E85, E100).

## Long-life grease

### Guideline

- KTM recommends **Motorex®** products.

### Supplier

#### Motorex®

- **Bike Grease 2000**



3213134en

08/2013

