

85 SX 19/16  
85 SX 17/14

Art. no. 3213191en





The work described in these setup instructions must be performed before the vehicle is delivered to the customer.

Read the setup instructions in their entirety before beginning work.

Print out the current **PDI** form found on the **KTM DEALER.NET**.

These setup instructions were written to correspond to the latest state of this series. We reserve the right to make changes in the interest of technical advancement without at the same time updating this manual.

We shall not provide a description of general workshop methods. Likewise, safety rules that apply in a workshop are not specified here. It is assumed that the work will be performed by a fully trained mechanic.

All specifications are non-binding. KTM Sportmotorcycle AG specifically reserves the right to modify or delete technical specifications, prices, colors, forms, materials, services, designs, equipment, etc., without prior notice and without specifying reasons, to adapt these to local conditions, as well as to stop production of a particular model without prior notice. KTM accepts no liability for delivery options, deviations from illustrations and descriptions, misprints, and other errors. The models portrayed partly contain special equipment that does not belong to the regular scope of supply.

© 2014 KTM-Sportmotorcycle AG, Mattighofen Austria

All rights reserved

Reproduction, even in part, as well as copying of all kinds, is permitted only with the express written permission of the copyright owner.



ISO 9001(12 100 6061)

According to the international quality management standard ISO 9001, KTM uses quality assurance processes that lead to the maximum possible quality of the products.

Issued by: TÜV Management Service

REG.NO. 12 100 6061

KTM-Sportmotorcycle AG  
5230 Mattighofen, Austria

## 1.1 Symbols used

The meaning of specific symbols is described below.



Indicates an expected reaction (e.g. of a work step or a function).



Indicates an unexpected reaction (e.g. of a work step or a function).



Indicates a page reference (more information is provided on the specified page).



Indicates information with more details or tips.



Indicates the result of a testing step.



Denotes a voltage measurement.



Denotes a current measurement.



Denotes a resistance measurement.

## 1.2 Formats used

The typographical formats used in this document are explained below.

**Proprietary name** Identifies a proprietary name.

**Name<sup>®</sup>** Identifies a protected name.

**Brand<sup>™</sup>** Identifies a trademark.

## 2.1 Unpacking and setting up the vehicle

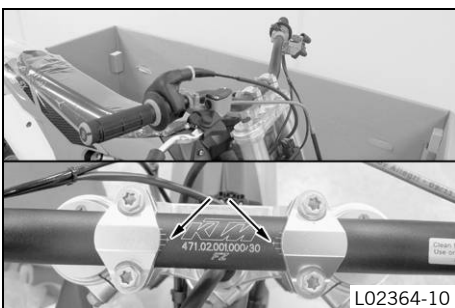
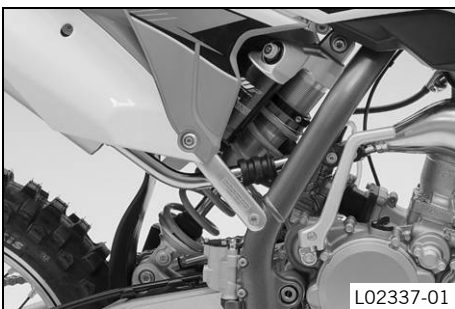
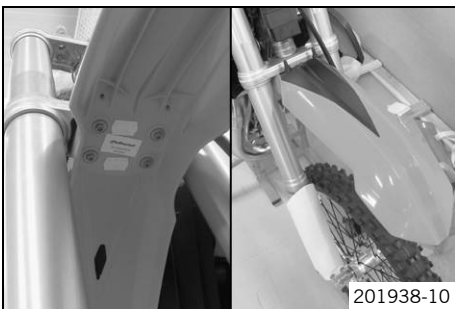
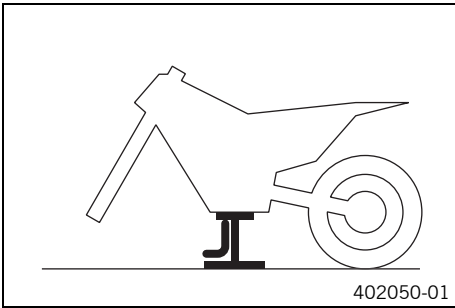
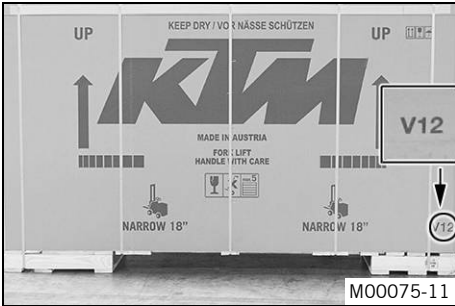

- Remove the box and the plastic packaging.

**i Info**

An assistant prevents the motorcycle from falling over. To avoid damaging the motorcycle during the setup, leave the protective film on the vehicle until you have finished.

- Remove the separate enclosure and unpack it. Check that the scope of supply is complete on the basis of the enclosed packing list.

- Have a lift stand available.

Lift stand (54829055000)

- Together with an assistant, take the vehicle off the palette.
- Position the vehicle on a lift stand.
- Check the vehicle for transport damage.

- Remove the tension belt.

✓ The fork rebounds.

- Remove screw ① and wheel spindle. Lift the front wheel into the fork, position it, and insert the wheel spindle.
- Mount and tighten the screw of the wheel spindle.

Guideline

Screw, front wheel spindle	M20x1.5	35 Nm (25.8 lbf ft)
----------------------------	---------	------------------------

- Position the fender. Mount and tighten screws.

Guideline

Remaining screws, chassis	M6	10 Nm (7.4 lbf ft)
---------------------------	----	--------------------

- Unpack the shock absorber.

- Position the shock absorber. Mount and tighten screws.

Guideline

Screw, top shock absorber	M12	60 Nm (44.3 lbf ft)	Loctite® 243™
Screw, bottom shock absorber	M12	60 Nm (44.3 lbf ft)	Loctite® 243™

✓ The longer screw is used at the bottom.

- Position the handlebar.

**i Info**

Make sure the cables and wiring are positioned correctly.

- Position the handlebar clamps. Mount and tighten the screws evenly.

Guideline

Screw, handlebar clamp	M8	20 Nm (14.8 lbf ft)
------------------------	----	------------------------

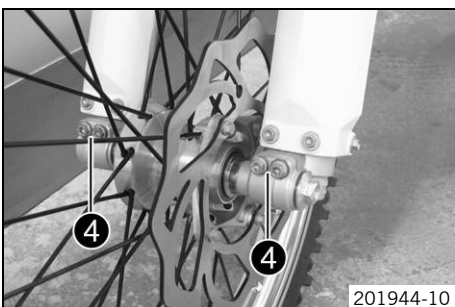
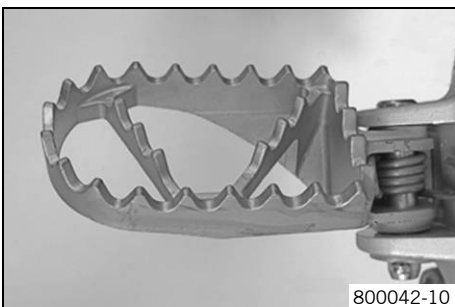
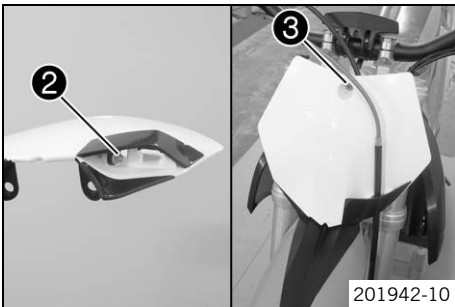

**i Info**

The markings on the handlebar should be at the center of the handlebar clamps.  
Keep the gap widths equal when tightening.

- Position the handlebar cushion and secure with a cable binder.

- Remove screw 2 with the guide from the start number plate.
- Position the start number plate. Mount and tighten screw 3.

Guideline

Remaining screws, chassis	M6	10 Nm (7.4 lbf ft)
---------------------------	----	--------------------

**i Info**

Ensure the holding lugs engage in the fender.

- Position the brake line and guide. Mount and tighten screw 2.
- Connect the fuel line to the fuel tap.

- Mount the footrests with the springs and pins. Secure the pins using the washers and cotter pins.

Pliers for footrest spring (58429083000)

- Take the vehicle off of the work stand.
- Activate the hand brake lever numerous times until the brake linings rest against the brake disc.
- Activate the front brake and compress the fork a number of times forcefully to align the fork legs.
- Tighten screws 4.

Guideline

Screw, fork stub	M8	15 Nm (11.1 lbf ft)
------------------	----	---------------------

- Refuel. (☛ p. 7)
- Print out the current **PDI** form found on **KTM DEALER.NET** and perform the delivery inspection.

## 3.1 Raising the motorcycle with the lift stand

**Note**

**Danger of damage** The parked vehicle may roll away or fall over.

- Always place the vehicle on a firm and even surface.

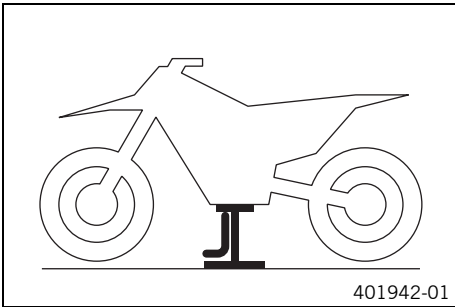

- Raise the motorcycle at the frame underneath the engine.

Lift stand (59229055000)

- ✓ Neither wheel is in contact with the ground.
- Secure the motorcycle against falling over.

## 3.2 Removing the motorcycle from the lift stand

**Note**

**Danger of damage** The parked vehicle may roll away or fall over.

- Always place the vehicle on a firm and even surface.

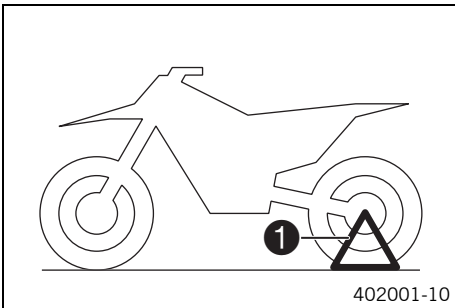

- Remove the motorcycle from the lift stand.
- Remove the lift stand.
- To park the motorcycle, insert plug-in stand ❶ into the left side of the wheel spindle.

**i Info**

Remove the plug-in stand before riding.

## 3.3 Installing the front wheel



**Warning**

**Danger of accidents** Reduced braking efficiency due to oil or grease on the brake discs.

- Always keep the brake discs free of oil and grease, and clean them with brake cleaner when necessary.

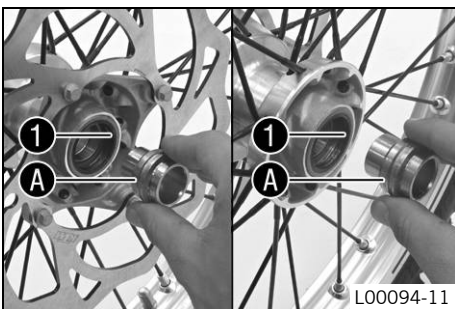

**Main work**

- Check the wheel bearing for damage and wear.
  - » If the wheel bearing is damaged or worn:
    - Change the wheel bearing.
- Clean and grease shaft seal rings ❶ and bearing surface A of the spacers.

Long-life grease (☛ p. 10)

- Insert the spacers.

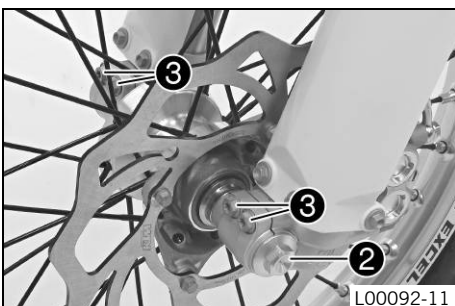

- Position the front wheel.
  - ✓ The brake linings are correctly positioned.
- Insert wheel spindle.
- Mount and tighten screw ❷.

**Guideline**

Screw, front wheel spindle	M20x1.5	35 Nm (25.8 lbf ft)
----------------------------	---------	------------------------

- Operate the hand brake lever several times until the brake linings are lying correctly against the brake disc.
- Remove the motorcycle from the lift stand. (👉 p. 5)
- Pull the front wheel brake and push down hard on the fork several times to align the fork legs.
- Tighten screws ③.

Guideline

Screw, fork stub	M8	15 Nm (11.1 lbf ft)
------------------	----	------------------------

### Finishing work

- Remove the motorcycle from the lift stand. (👉 p. 5)

## 3.4 Installing the front fender

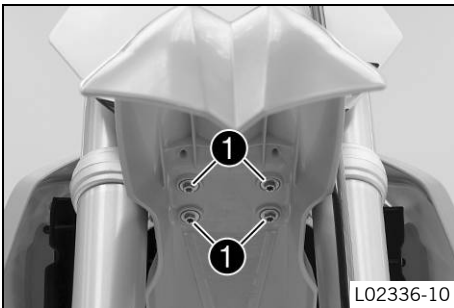

- Ensure that the spacers are mounted in the fender.
- Position the front fender. Mount and tighten screws ①.

Guideline

Remaining screws, chassis	M6	10 Nm (7.4 lbf ft)
---------------------------	----	--------------------

- ✓ The holding lugs engage.

## 3.5 Installing the start number plate

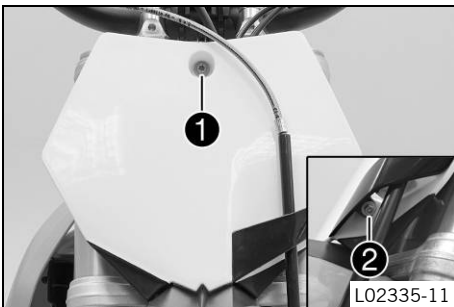

- Position the start number plate. Mount and tighten screw ①.

Guideline

Remaining screws, chassis	M6	10 Nm (7.4 lbf ft)
---------------------------	----	--------------------

- ✓ The holding lugs engage.

- Position the brake line. Position the clamp. Mount and tighten screw ②.

## 3.6 Opening the filler cap



### Danger

**Fire hazard** Fuel is highly flammable.

- Never refuel the vehicle near open flames or burning cigarettes, and always switch off the engine first. Be careful that no fuel is spilt, especially on hot vehicle components. Clean up spilt fuel immediately.
- The fuel in the fuel tank expands when warm and may emerge if overfilled. Follow the instructions on refueling.



### Warning

**Danger of poisoning** Fuel is poisonous and a health hazard.

- Fuel must not come into contact with the skin, eyes, or clothing. Do not breathe in the fuel vapors. If contact occurs with the eyes, rinse with water immediately and contact a physician. Immediately clean contaminated areas on the skin with soap and water. If fuel is swallowed, contact a physician immediately. Change clothing that is contaminated with fuel. Store fuel properly in a suitable canister and keep away from children.



### Warning

**Environmental hazard** Improper handling of fuel is a danger to the environment.

- Do not allow fuel to get into the ground water, the ground, or the sewage system.



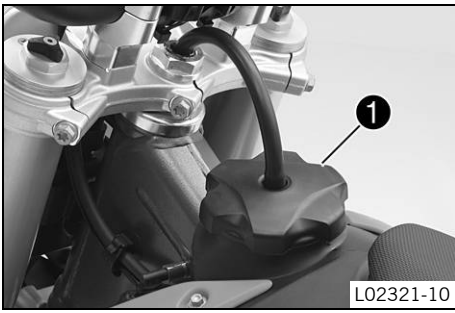

- Turn filler cap ❶ counterclockwise and lift it off.

### 3.7 Closing the filler cap

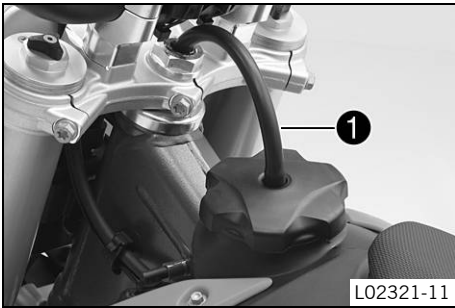

- Mount filler cap and turn it clockwise until the fuel tank is tightly closed.

**i Info**

Run fuel tank breather hose ❶ without kinks.

### 3.8 Refueling



**Danger**

**Fire hazard** Fuel is highly flammable.

- Never refuel the vehicle near open flames or burning cigarettes, and always switch off the engine first. Be careful that no fuel is spilt, especially on hot vehicle components. Clean up spilt fuel immediately.
- The fuel in the fuel tank expands when warm and may emerge if overfilled. Follow the instructions on refueling.



**Warning**

**Danger of poisoning** Fuel is poisonous and a health hazard.

- Fuel must not come into contact with the skin, eyes, or clothing. Do not breathe in the fuel vapors. If contact occurs with the eyes, rinse with water immediately and contact a physician. Immediately clean contaminated areas on the skin with soap and water. If fuel is swallowed, contact a physician immediately. Change clothing that is contaminated with fuel.



**Warning**

**Environmental hazard** Improper handling of fuel is a danger to the environment.

- Do not allow fuel to get into the ground water, the ground, or the sewage system.

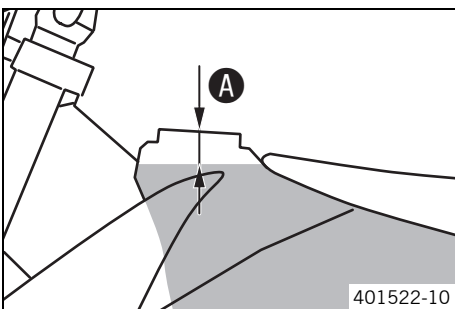

- Switch off the engine.
- Open the filler cap. (☛ p. 6)
- Fill the fuel tank with fuel up to measurement ❶.

Guideline

Measurement of ❶	35 mm (1.38 in)	
Fuel tank capacity, approx.	5.0 l (1.32 US gal)	Super unleaded (98 octane) mixed with 2-stroke engine oil (1:40) (☛ p. 9)
Engine oil, 2-stroke (☛ p. 9)		

- Close the filler cap. (☛ p. 7)

# 4 TECHNICAL DATA - TIGHTENING TORQUES FOR CHASSIS

Spoke nipple	M4.5	5 Nm (3.7 lbf ft)	–
Rear brake bolt	M6	12 Nm (8.9 lbf ft)	–
Remaining nuts, chassis	M6	10 Nm (7.4 lbf ft)	–
Remaining screws, chassis	M6	10 Nm (7.4 lbf ft)	–
Screw, ball joint of push rod on foot brake cylinder	M6	10 Nm (7.4 lbf ft)	–
Screw, foot brake cylinder	M6	10 Nm (7.4 lbf ft)	–
Screw, front brake disc	M6	14 Nm (10.3 lbf ft)	<b>Loctite® 243™</b>
Screw, rear brake disc	M6	14 Nm (10.3 lbf ft)	<b>Loctite® 243™</b>
Screw, throttle grip	M6	4.5 Nm (3.32 lbf ft)	–
Nut, rim lock	M8	10 Nm (7.4 lbf ft)	–
Remaining nuts, chassis	M8	25 Nm (18.4 lbf ft)	–
Remaining screws, chassis	M8	25 Nm (18.4 lbf ft)	–
Screw of brake caliper	M8	25 Nm (18.4 lbf ft)	<b>Loctite® 243™</b>
Screw, bottom triple clamp	M8	15 Nm (11.1 lbf ft)	–
Screw, fork stub	M8	15 Nm (11.1 lbf ft)	–
Screw, handlebar clamp	M8	20 Nm (14.8 lbf ft)	–
Screw, rear sprocket	M8	35 Nm (25.8 lbf ft)	<b>Loctite® 243™</b>
Screw, subframe	M8	30 Nm (22.1 lbf ft)	–
Screw, top triple clamp	M8	20 Nm (14.8 lbf ft)	–
Engine carrying screw	M10	45 Nm (33.2 lbf ft)	–
Remaining nuts, chassis	M10	45 Nm (33.2 lbf ft)	–
Remaining screws, chassis	M10	45 Nm (33.2 lbf ft)	–
Screw, foot brake lever	M10	45 Nm (33.2 lbf ft)	<b>Loctite® 243™</b>
Screw, handlebar support	M10	40 Nm (29.5 lbf ft)	<b>Loctite® 243™</b>
Screw, bottom shock absorber	M12	60 Nm (44.3 lbf ft)	<b>Loctite® 243™</b>
Screw, top shock absorber	M12	60 Nm (44.3 lbf ft)	<b>Loctite® 243™</b>
Nut, seat fixing	M12x1	20 Nm (14.8 lbf ft)	–
Nut, swingarm pivot	M14x1.5	75 Nm (55.3 lbf ft)	–
Nut, rear wheel spindle	M20x1.5	80 Nm (59 lbf ft)	–
Nut, steering stem	M20x1.5	10 Nm (7.4 lbf ft)	–
Screw, front wheel spindle	M20x1.5	35 Nm (25.8 lbf ft)	–

## Engine oil, 2-stroke

**Standard/classification**

- JASO FD (☛ p. 11)

**Guideline**

- Only use high grade 2-stroke engine oil of a reputable brand.

Fully synthetic
-----------------

**Recommended supplier****Motorex®**

- Cross Power 2T

## Super unleaded (ROZ 98 / RON 98 / PON 94)

**Standard/classification**

- DIN EN 228 (ROZ 98 / RON 98 / PON 94)

## Super unleaded (98 octane) mixed with 2-stroke engine oil (1:40)

**Standard/classification**

- DIN EN 228
- JASO FD (☛ p. 11) (1:40)

**Mixture ratio**

1:40	Engine oil, 2-stroke (☛ p. 9) Super unleaded (ROZ 98 / RON 98 / PON 94) (☛ p. 9)
------	---

**Recommended supplier****Motorex®**

- Cross Power 2T

## Long-life grease

Recommended supplier

Motorex®

– Bike Grease 2000

## JASO FD

JASO FD is a classification for a 2-stroke engine oil that was specifically developed for the extreme demands of racing. Thanks to first rate synthetic esters and specially designed additives, superb combustion is achieved even under extreme operating conditions.



3213191en

06/2014

