

1290 Super Adventure T

Art. no. 3213661en



KTM

Perform the work described in these setup instructions before the vehicle is delivered to the customer.

Read the setup instructions in their entirety before beginning work.

These setup instructions were written to correspond to the latest state of this series. We reserve the right to make changes in the interest of technical advancement without at the same time updating this manual.

We shall not provide a description of general workshop methods. Likewise, safety rules that apply in a workshop are not specified here. It is assumed that the work will be performed by a fully trained mechanic.

All specifications are non-binding. KTM Sportmotorcycle GmbH specifically reserves the right to modify or delete technical specifications, prices, colors, forms, materials, services, designs, equipment, etc., without prior notice and without specifying reasons, to adapt these to local conditions, as well as to stop production of a particular model without prior notice. KTM accepts no liability for delivery options, deviations from illustrations and descriptions, misprints, and other errors. The models portrayed partly contain special equipment that does not belong to the regular scope of supply.

© 2017 KTM Sportmotorcycle GmbH, Mattighofen Austria

All rights reserved

Reproduction, even in part, as well as copying of all kinds, is permitted only with the express written permission of the copyright owner.



ISO 9001(12 100 6061)

According to the international quality management standard ISO 9001, KTM uses quality assurance processes that lead to the maximum possible quality of the products.

Issued by: TÜV Management Service

REG.NO. 12 100 6061

KTM Sportmotorcycle GmbH

5230 Mattighofen, Austria

This document is valid for the following models:

1290 Super Adventure T EU (F9903QA)

1290 Super Adventure T US (F9975QA)



1.1 Symbols used

The meaning of specific symbols is described below.



Indicates an expected reaction (e.g. of a work step or a function).



Indicates an unexpected reaction (e.g. of a work step or a function).



Indicates a page reference (more information is provided on the specified page).



Indicates information with more details or tips.



Indicates the result of a testing step.



Indicates a voltage measurement.



Indicates a current measurement.



Indicates a resistance measurement.

1.2 Formats used

The typographical formats used in this document are explained below.

Proprietary name	Indicates a proprietary name.
Name[®]	Indicates a protected name.
Brand[™]	Indicates a brand available on the open market.
<u>Underlined terms</u>	Refer to technical details of the vehicle or indicate technical terms, which are explained in the glossary.

2.1 Unpacking and setting up the vehicle



S00694-10

- Remove the straps and box.



S00695-10

- Remove the adhesive tape in the upper area of the motorcycle.



S00696-10

- Roll down the film at the sides.

i Info

To avoid damaging the motorcycle during unpacking, leave the other films on the vehicle until you have finished work on the vehicle.

- Remove the separate enclosure and unpack it. Check the separate enclosure for completeness.
- Check the vehicle for transport damage.



S00697-10

- Remove the controls from the transport holder.
- Remove the screws and handlebar clamps.
- Remove the transport holder.

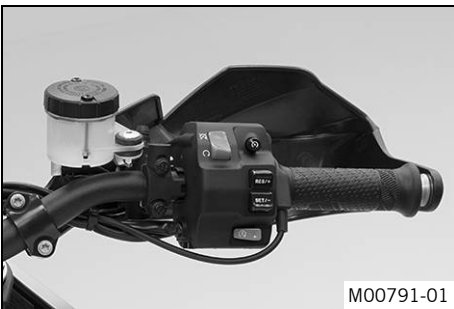

M00791-01

- Remove the right hand guard.
- Position the controls on the right half of the handlebar. Tighten the screws.

Guideline

Remaining screws, chassis	M5	5 Nm (3.7 lbf ft)
Remaining chassis screws	M6	10 Nm (7.4 lbf ft)

- Mount the right hand guard.

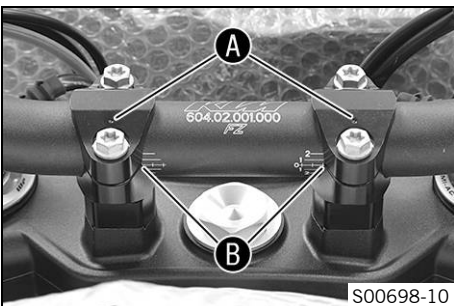

S00698-10

- Position the handlebar.
- Position the handlebar clamps. Tighten the screws evenly.

Guideline

Screw, handlebar clamp	M8	20 Nm (14.8 lbf ft)
------------------------	----	---------------------

- ✓ Markings **A** face backwards.
- ✓ Handlebar scale markings **B** are located centrally between the handlebar clamps.

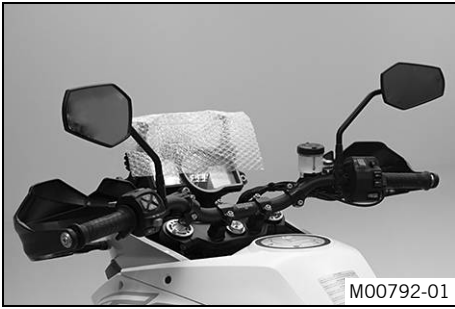

- Check the throttle grip for smooth operation.
- Mount and tighten the rear mirror on both sides.

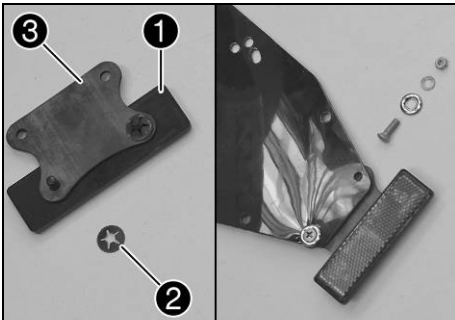

- Mount reflector ① with spring washers ② on holding plate ③.
- Mount the holding plate on the license plate bracket.
- Mount the license plate holder.
- Carefully loosen and remove the tension belt over the swingarm.

Guideline

An assistant prevents the motorcycle from falling over.

- Carefully loosen and remove the tensioning belts around the lower triple clamp.
 - ✓ The vehicle is released at the front.
- Together with an assistant, take the vehicle off the palette.
- Loosen the mask spoiler. (📖 p. 7)

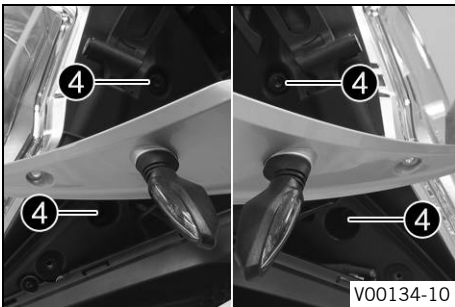

- Remove screws ④.

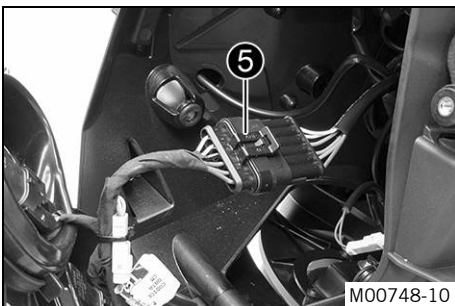

- Swing the headlight toward the front.
- Disconnect plug-in connector ⑤.
- Put down the headlight on a soft cloth.

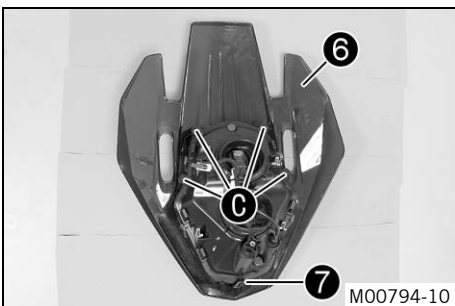

- Position headlight mask ⑥.
 - ✓ The screw connection points ① are correctly aligned to the headlight.
 - ✓ The holder ⑦ locks onto the headlight.

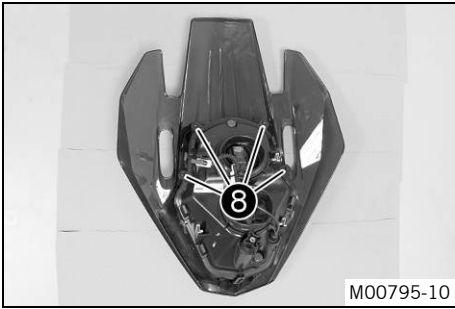

- Mount and tighten screws 8.
- Install the headlight mask with the headlight. (p. 10)
- Position the mask spoiler. (p. 8)

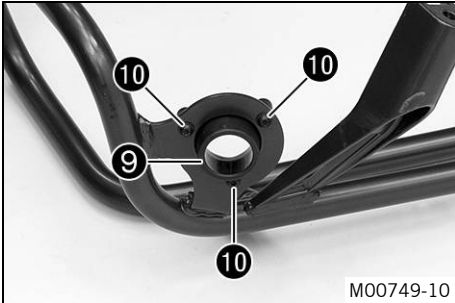

- Position fuel tank support ring 9 on the left and right crash bars.
- Mount and tighten screws 10 on the left and right crash bars.
- Install the crash bar. (p. 11)
- Install the wind shield. (p. 11)

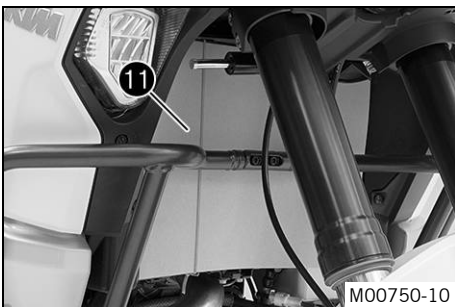

- Remove radiator shield 11.
- Recharge the battery. (p. 12)
- Remove the remaining films.
- Mount the front rider's seat. (p. 7)
- Mount the passenger seat. (p. 6)

(1290 Super Adventure T US)

- Mount reflector. (p. 19)
- Refuel. (p. 16)
- Prepare the vehicle according to the specifications in the **KTM Dealer.net** for hand-over to the customer.

3.1 Removing the passenger seat

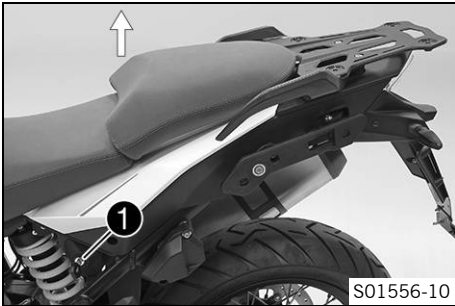

(1290 Super Adventure T EU)

- Insert the ignition key in seat lock ① and turn it clockwise.
- Raise front of the passenger seat, pull toward the tank, and remove upward.



Info

Pay attention to the seat heating cable.

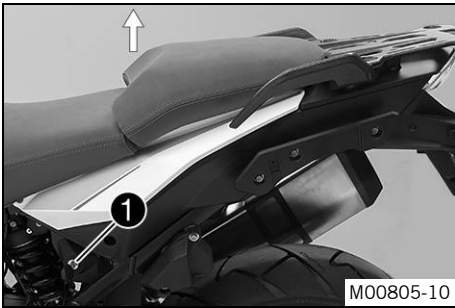

(1290 Super Adventure T US)

- Insert the ignition key in seat lock ① and turn it clockwise.
- Raise front of the passenger seat, pull toward the tank, and remove upward.



Info

Pay attention to the seat heating cable.

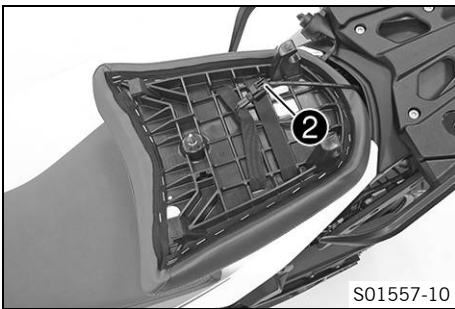

- Disconnect plug-in connector ②.
- Remove the ignition key.

3.2 Mounting the passenger seat

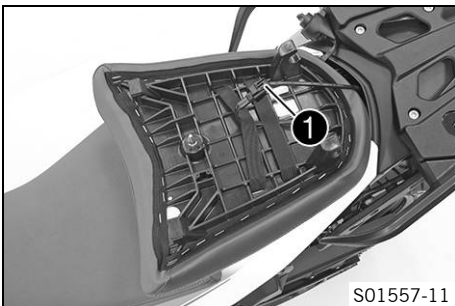

- Connect plug-in connector ①.

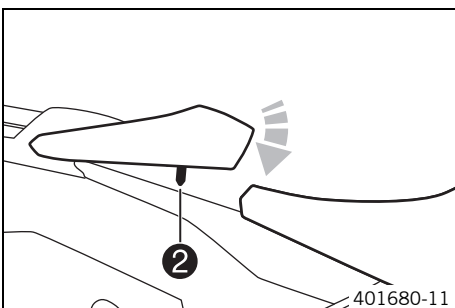

- Attach the hooks on the passenger seat to the hanger on the subframe.



Info

Ensure that the seat heating cable is correctly routed.

- Lower passenger seat and push back at the same time.
- Position locking pin ② in lock housing and press passenger seat forward until the locking pin engages with an audible click.
- Check that the passenger seat is correctly mounted.

3.3 Removing the front rider's seat

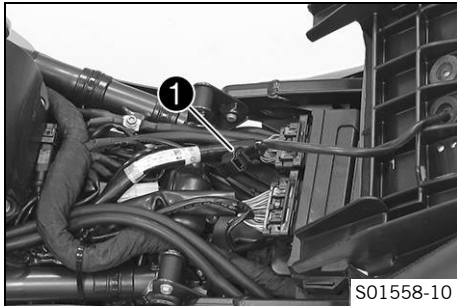
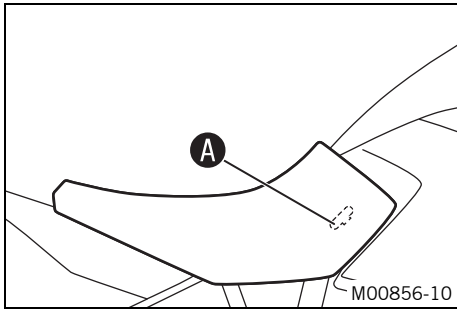

Preparatory work

- Remove the passenger seat. (📖 p. 6)

Main work

- Lift the rider's seat back and unhook in the **A** area.



Info

Pay attention to the seat heating cable.

- Disconnect plug-in connector **1**.

3.4 Mounting the front rider's seat

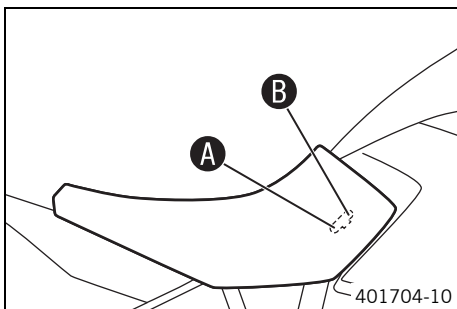
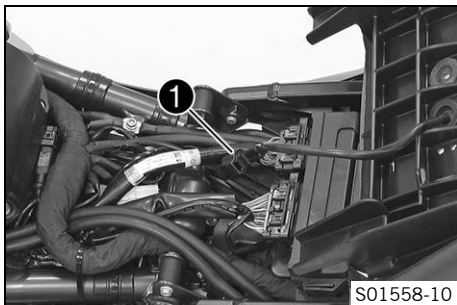

Main work

- Connect plug-in connector **1**.

- Attach the recesses on the driver's seat to the fuel tank at the desired seat position **A** or **B**, and push the driver's seat forward while lowering it at the rear.



Info

Ensure that the seat heating cable is correctly routed.

- Finally, check that the driver's seat is correctly mounted.

Finishing work

- Mount the passenger seat. (📖 p. 6)

3.5 Loosening the mask spoiler



- Remove screw **1**.



- Remove screw ②.

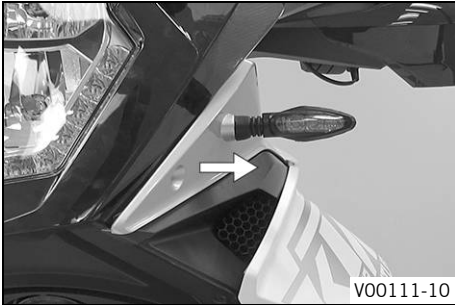

(1290 Super Adventure T EU)

- Pull the front part of the mask spoiler laterally out of the supports.

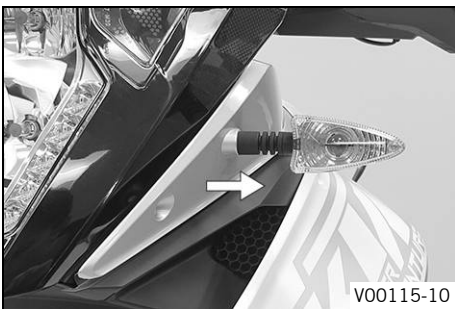

(1290 Super Adventure T US)

- Pull the front part of the mask spoiler laterally out of the supports.

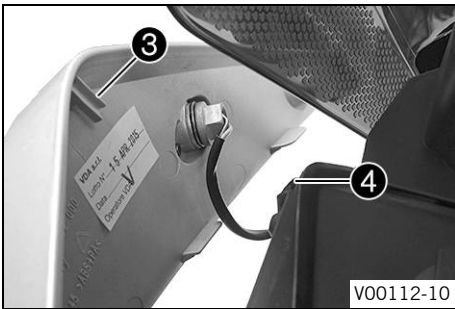

- Carefully remove catch ③ upward from bracket ④.

i Info
Pay attention to the turn signal cable.

- Repeat these steps on the opposite side.

3.6 Positioning the mask spoiler

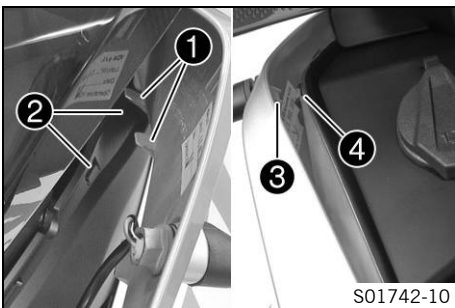

- Push the two rear catches ① on the mask spoiler into the supports ② provided.
- Push the mask spoiler up and position catch ③ in bracket ④.

i Info
Ensure that the turn signal cable is placed correctly.
Carefully push the mask spoiler up to avoid breaking the component or bending catch ③.
Make sure that the rear catches on the mask spoiler remain in the supports provided.

(1290 Super Adventure T EU)

- Push the front part of the mask spoiler laterally into the supports.

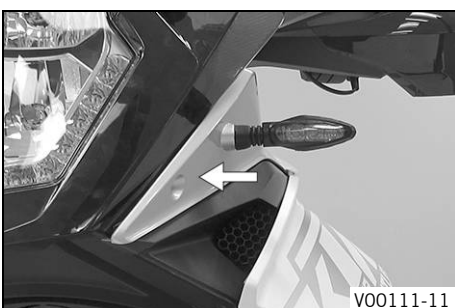

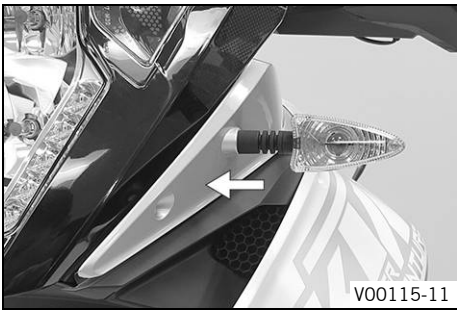

(1290 Super Adventure T US)

- Push the front part of the mask spoiler laterally into the supports.

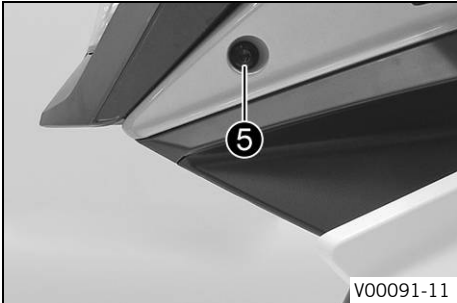

- Mount and tighten screw **5**.

Guideline

Screw, mask spoiler	M5x17	3.5 Nm (2.58 lbf ft)
---------------------	-------	-------------------------

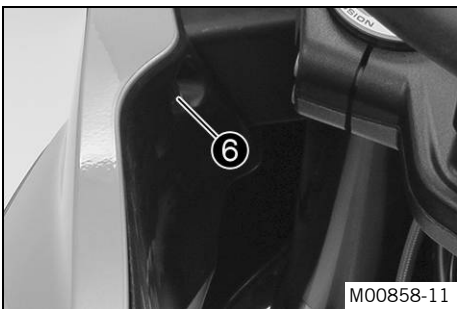

- Mount and tighten screw **6**.

Guideline

Screw, mask spoiler	M5x17	3.5 Nm (2.58 lbf ft)
---------------------	-------	-------------------------

- Repeat these steps on the opposite side.

3.7 Removing the bottom triple clamp cover

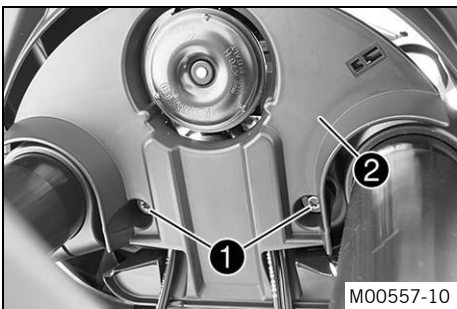

- Remove screws **1**.
- Lower triple clamp cover **2** slightly.

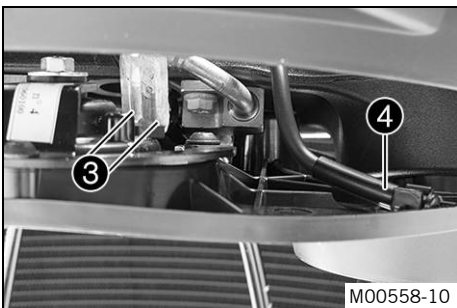

- Disconnect plugs **3** of the horn.
- Detach temperature sensor **4**.
- Remove the triple clamp cover.

3.8 Installing the bottom triple clamp cover

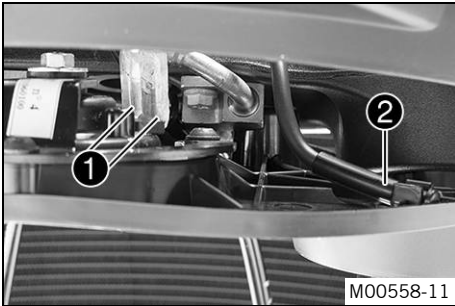

- Plug in connectors ① of the horn.
- Attach temperature sensor ②.

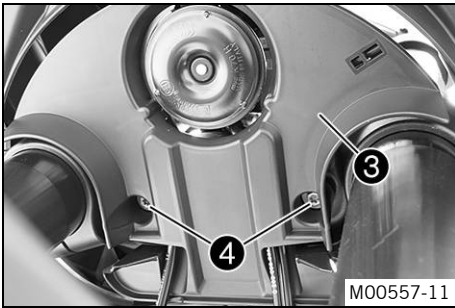

- Position the triple clamp cover ③.
- Mount and tighten screws ④.

Guideline

Remaining chassis screws	M6	10 Nm (7.4 lbf ft)
--------------------------	----	--------------------

3.9 Installing the headlight mask with the headlight

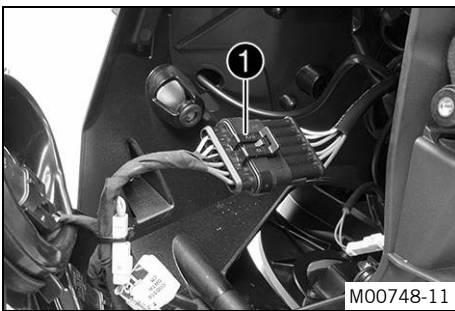

Main work

- Connect plug-in connector ① of the headlight.
- Check that the lighting is functioning properly.
- Position the headlight mask.

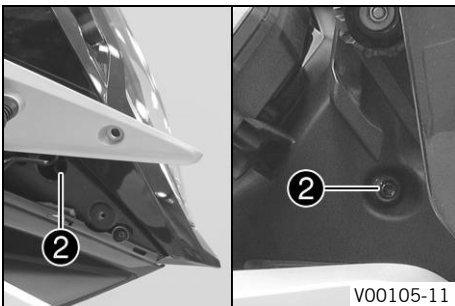

- Mount and tighten screws ②.

Guideline

Screw, headlight	M6	5 Nm (3.7 lbf ft)
------------------	----	-------------------

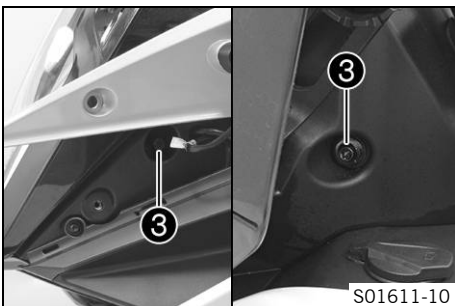

- Mount and tighten screws ③.

Guideline

Screw, headlight	M6	5 Nm (3.7 lbf ft)
------------------	----	-------------------

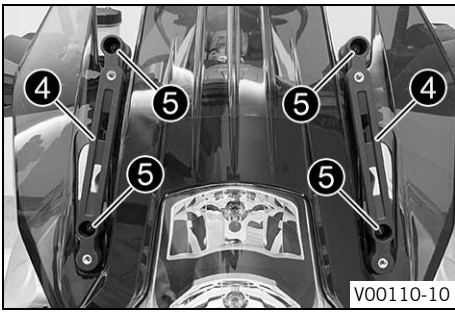

- Position windshield adapter **4**.
- Mount and tighten screws **5**.

Guideline

Screw, cover part	M5	3.5 Nm (2.58 lbf ft)
-------------------	----	-------------------------

Finishing work

- Position the mask spoiler. (📖 p. 8)
- Install the wind shield. (📖 p. 11)
- Check the setting of the lighting system. (📖 p. 16)

3.10 Installing the wind shield

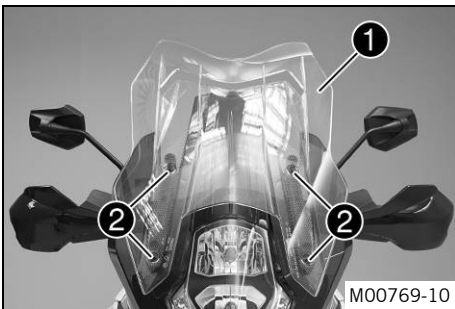

- Position wind shield **1**.
- Mount and tighten screws **2**.

Guideline

Screw, wind shield	M5	3.5 Nm (2.58 lbf ft)
--------------------	----	-------------------------

3.11 Installing the crash bar

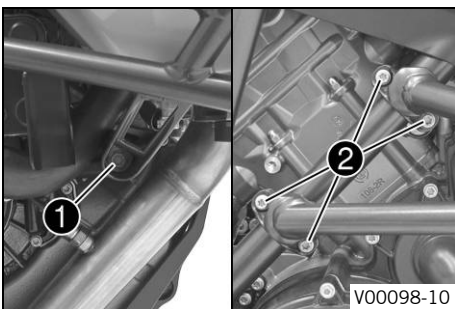

- Position the right crash bar with the frame protector.
- ✓ The fuel tank support ring should be correctly positioned on the fuel tank.

i Info

Cover the components to protect them against damage.

- Mount screw **1**, but do not tighten yet.

Guideline

Remaining chassis screws	M8	25 Nm (18.4 lbf ft)
--------------------------	----	------------------------

- Mount screws **2**, but do not tighten yet.

Guideline

Remaining chassis screws	M6	10 Nm (7.4 lbf ft)
--------------------------	----	--------------------

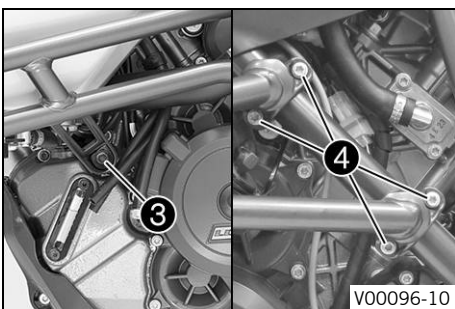

- Position the left crash bar with the frame protector.
- ✓ The fuel tank support ring should be correctly positioned on the fuel tank.

i Info

Cover the components to protect them against damage.

- Mount screw **3**, but do not tighten yet.

Guideline

Remaining chassis screws	M8	25 Nm (18.4 lbf ft)
--------------------------	----	------------------------

- Mount screws **4**, but do not tighten yet.

Guideline

Remaining chassis screws	M6	10 Nm (7.4 lbf ft)
--------------------------	----	--------------------

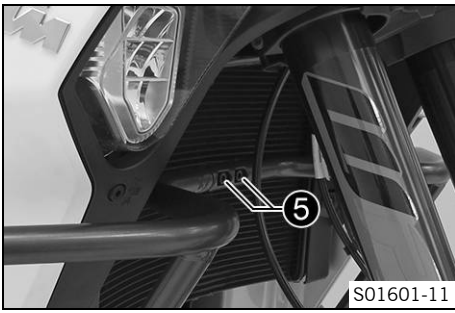

- Mount and tighten fittings **5**.

Guideline

Remaining chassis screws	M6	10 Nm (7.4 lbf ft)
--------------------------	----	--------------------

- ✓ The crash bars are evenly aligned with each other.

- Tighten all the screws of the crash bar.

Guideline

Remaining chassis screws	M6	10 Nm (7.4 lbf ft)
Remaining chassis screws	M8	25 Nm (18.4 lbf ft)

3.12 Recharging the battery



Warning

Risk of injury Battery acid and battery gases cause serious chemical burns.

- Keep batteries out of the reach of children.
- Wear suitable protective clothing and safety glasses.
- Avoid contact with battery acid and battery gases.
- Keep sparks or open flames away from the battery.
- Only charge batteries in well-ventilated rooms.
- Rinse the affected area immediately with plenty of water in the event of contact with the skin.
- Rinse eyes with water for at least 15 minutes and consult a doctor immediately if battery acid and battery gases get into the eyes.



Warning

Environmental hazard Batteries contain environmentally-hazardous materials.

- Do not dispose of batteries as household waste.
- Dispose of batteries at a collection point for used batteries.



Warning

Environmental hazard Hazardous substances cause environmental damage.

- Dispose of oils, grease, filters, fuel, cleaning agents, brake fluid, etc., correctly and in compliance with the applicable regulations.



Info

Even when there is no load on the battery, it discharges steadily. The charging level and the method of charging are very important for the service life of the battery. Rapid recharging with a high charging current shortens the service life of the battery. If the charging current, charging voltage, and charging time are exceeded, the battery will be destroyed. If the battery is depleted from starting the vehicle repeatedly, the battery must be charged immediately. If the battery is left in a discharged state for an extended period, it will become over-discharged and sulfated, destroying the battery. The battery is maintenance-free, i.e., the acid level does not have to be checked.

Preparatory work

- Switch off all power consumers and switch off the engine.
- Remove the passenger seat. (📖 p. 6)
- Remove the front rider's seat. (📖 p. 7)
- Remove the battery. (📖 p. 13)

Main work

- Connect the battery charger to the battery. Set the battery charger.

Alternative 1

Battery charger **XCharge-professional** EU (00029095050)

Alternative 2

Battery charger **XCharge-professional** US (00029095051)

Alternative 3

Battery charger **XCharge-professional** GB (00029095052)

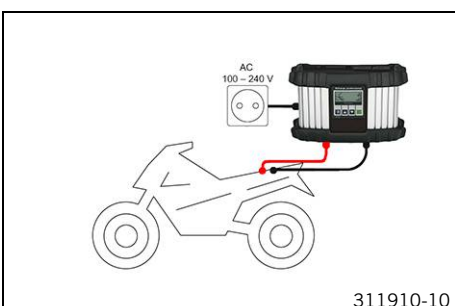

Alternative 4

Battery charger **XCharge-professional** CH (00029095053)



Info

Follow the instructions of the charger and the manual.

- Disconnect the battery charger after charging the battery.

Guideline

The charging current, charging voltage, and charging time must not be exceeded.

Charge the battery regularly when the motorcycle is not in use	3 months
--	----------

Finishing work

- Install the battery. (📖 p. 14)
- Mount the front rider's seat. (📖 p. 7)
- Mount the passenger seat. (📖 p. 6)
- Set the time and date.

3.13 Removing the battery



Warning

Risk of injury Battery acid and battery gases cause serious chemical burns.

- Keep batteries out of the reach of children.
- Wear suitable protective clothing and safety glasses.
- Avoid contact with battery acid and battery gases.
- Keep sparks or open flames away from the battery.
- Only charge batteries in well-ventilated rooms.
- Rinse the affected area immediately with plenty of water in the event of contact with the skin.
- Rinse eyes with water for at least 15 minutes and consult a doctor immediately if battery acid and battery gases get into the eyes.



Caution

Danger of accidents Electronic components and safety devices will be damaged if the battery is discharged or missing.

- Never operate the vehicle with a discharged battery or without a battery.

Preparatory work

- Switch off all power consumers and switch off the engine.
- Remove the passenger seat. (📖 p. 6)
- Remove the front rider's seat. (📖 p. 7)

Main work

- Pull locking mechanism **1** in the direction of the arrow.
- Fold open cover **2**.

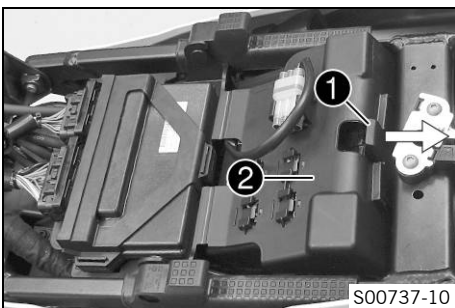

- Disconnect negative cable **3** from the battery.
- Disconnect positive cable **4** from the battery.
- Take the battery and battery case **5** out of the battery compartment.

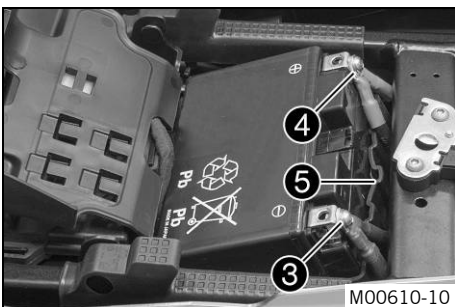

3.14 Installing the battery

- Warning**
Risk of injury Battery acid and battery gases cause serious chemical burns.
- Keep batteries out of the reach of children.
 - Wear suitable protective clothing and safety glasses.
 - Avoid contact with battery acid and battery gases.
 - Keep sparks or open flames away from the battery.
 - Only charge batteries in well-ventilated rooms.
 - Rinse the affected area immediately with plenty of water in the event of contact with the skin.
 - Rinse eyes with water for at least 15 minutes and consult a doctor immediately if battery acid and battery gases get into the eyes.

- Caution**
Danger of accidents Electronic components and safety devices will be damaged if the battery is discharged or missing.
- Never operate the vehicle with a discharged battery or without a battery.

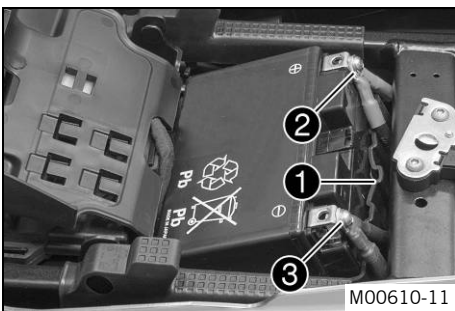

Main work

- Position the battery in battery case ①.

Guideline

The even side of the battery case must be opposite the poles.

- Position the battery and battery case in the battery compartment.
- Position the positive cable ② and mount and tighten the screw.

Guideline

Screw, battery terminal	M6	4.5 Nm (3.32 lbf ft)
-------------------------	----	-------------------------

- Position the negative cable ③ and mount and tighten the screw.

Guideline

Screw, battery terminal	M6	4.5 Nm (3.32 lbf ft)
-------------------------	----	-------------------------

- Close the cover ④ and push down slightly.
 ✓ The cover engages with an audible click.

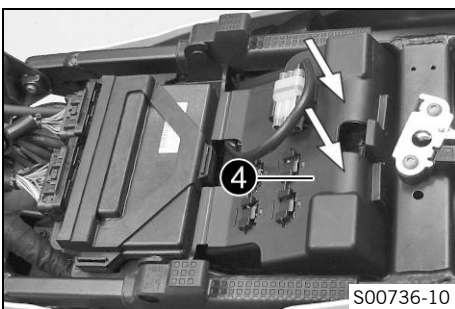

Finishing work

- Mount the front rider's seat. (📖 p. 7)
- Mount the passenger seat. (📖 p. 6)
- Set the time and date.

3.15 Opening the filler cap

- Danger**
Fire hazard Fuel is highly flammable.
 The fuel in the fuel tank expands when warm and can escape if overfilled.

- Do not refuel the vehicle in the vicinity of open flames or lit cigarettes.
- Switch off the engine for refueling.
- Make sure that no fuel is spilled; particularly not on hot parts of the vehicle.
- If any fuel is spilled, wipe it off immediately.
- Observe the specifications for refueling.



Warning

Danger of poisoning Fuel is poisonous and a health hazard.

- Avoid skin, eye and clothing contact with fuel.
- Immediately consult a doctor if you swallow fuel.
- Do not inhale fuel vapors.
- In case of skin contact, rinse the affected area with plenty of water.
- Rinse the eyes thoroughly with water, and consult a doctor in case of fuel contact with the eyes.
- Change your clothing in case of fuel spills on them.
- Keep fuels correctly in a suitable canister, and out of the reach of children.



Warning

Environmental hazard Improper handling of fuel is a danger to the environment.

- Do not allow fuel to enter the groundwater, the soil, or the sewage system.

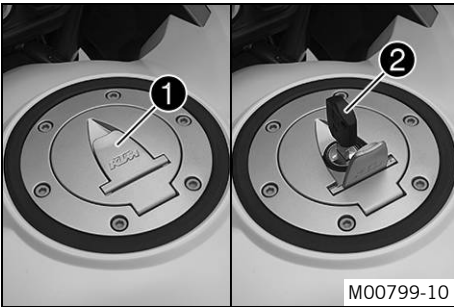

- Lift cover **1** of the filler cap and insert ignition key **2** in the fuel tank lock.

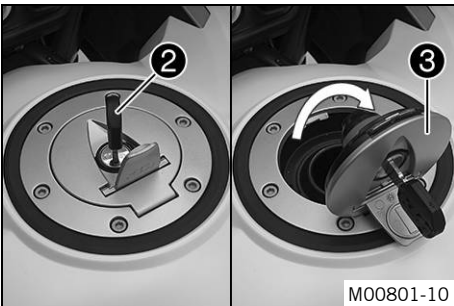

Note

Danger of damage The ignition key may break if overloaded. Damaged ignition keys must be replaced.

- Push down on the filler cap to take pressure off the ignition key.
- Turn ignition key **2** clockwise.
- Fold open filler cap **3**.

3.16 Closing the filler cap

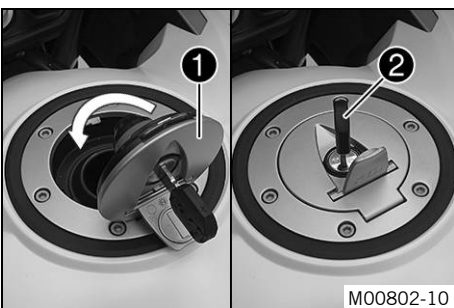

- Fold down filler cap **1**.
- Turn ignition key **2** clockwise.

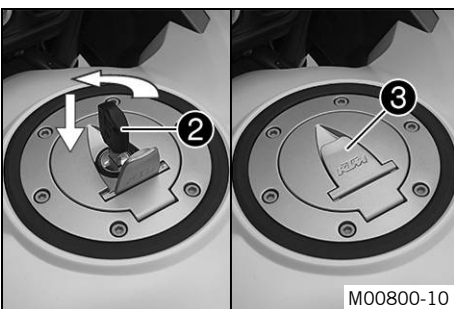

- Push down the filler cap and turn the ignition key **2** counterclockwise until the tank lock closes.



Warning

Fire hazard Fuel is highly flammable, toxic and a health hazard.

- Check the filler cap is locked correctly after closing.
- Change your clothing in case of fuel spills on them.
- Rinse the affected area immediately with plenty of water in the event of contact with the skin.

- Remove ignition key **2** and close cover **3**.

3.17 Refueling



Danger

Fire hazard Fuel is highly flammable.

The fuel in the fuel tank expands when warm and can escape if overfilled.

- Do not refuel the vehicle in the vicinity of open flames or lit cigarettes.
- Switch off the engine for refueling.
- Make sure that no fuel is spilled; particularly not on hot parts of the vehicle.
- If any fuel is spilled, wipe it off immediately.
- Observe the specifications for refueling.



Warning

Danger of poisoning Fuel is poisonous and a health hazard.

- Avoid skin, eye and clothing contact with fuel.
- Immediately consult a doctor if you swallow fuel.
- Do not inhale fuel vapors.
- In case of skin contact, rinse the affected area with plenty of water.
- Rinse the eyes thoroughly with water, and consult a doctor in case of fuel contact with the eyes.
- Change your clothing in case of fuel spills on them.

Note

Material damage Inadequate fuel quality causes the fuel filter to quickly become clogged.

In some countries and regions, the available fuel quality and cleanliness may not be sufficient. This will result in problems with the fuel system.

- Refuel only with clean fuel that meets the specified standards.



Warning

Environmental hazard Improper handling of fuel is a danger to the environment.

- Do not allow fuel to enter the groundwater, the soil, or the sewage system.

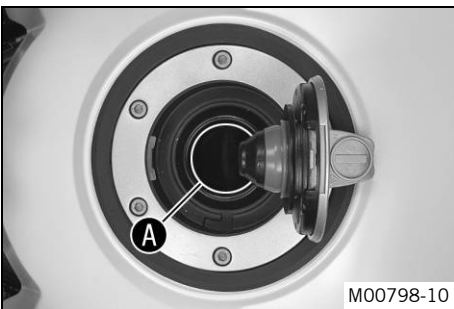

- Switch off the engine.
- Open the filler cap. (📖 p. 14)
- Fill the fuel tank with fuel up to the lower edge **A** of the filler neck.

Total fuel tank capacity, approx.	30 l (7.9 US gal)	Super unleaded (ROZ 95/RON 95/PON 91) (📖 p. 23)
-----------------------------------	-------------------	---

- Close the filler cap. (📖 p. 15)

3.18 Checking the setting of the lighting system

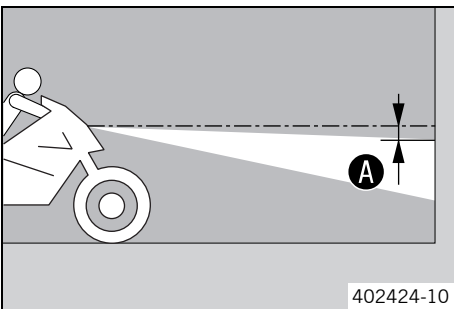

- Position the vehicle upright on a horizontal surface in front of a light wall and make a mark at the height of the center of the low beam headlight.
- Make a second mark at a distance **A** under the first mark.

Guideline

Distance A	5 cm (2 in)
-------------------	-------------

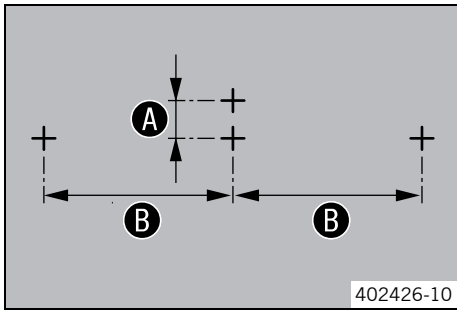

- Make two further marks spaced apart **B** to the left and the right of the second marking.

Guideline

Distance B	71.5 cm (28.15 in)
-------------------	--------------------

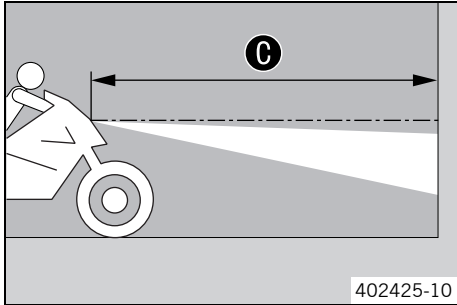

- Position the vehicle perpendicular to the wall at a distance **C** from the wall and switch on the low beam.

Guideline

Distance C	5 m (16 ft)
-------------------	-------------

- The rider, with luggage and passenger if applicable, now mounts the motorcycle.
- Check the headlight setting.

The light-dark boundary of the low beam must lie exactly on the lower mark when the motorcycle is ready to operate with the rider mounted along with any luggage and a passenger if applicable.

- » If the boundary between light and dark does not meet specifications:
 - Adjust the headlight range. (🔧 p. 18)

- Press the **UP** or **DOWN** button until the "**Settings**" menu appears on the matrix display. Pressing the **SET** button opens the menu.
- Press the **UP** or **DOWN** button until "**cLightTest**" is highlighted in black on the matrix display. Pressing the **SET** button again starts the cornering light test.
- Wait for a few seconds until the upper segment of the left cornering light lights up continuously.
- Checking the left cornering light setting.

The light-dark boundary of the upper segment must run exactly through the left marking.

- » If the boundary between light and dark does not meet specifications:
 - Adjust the cornering light range. (🔧 p. 18)

- Press the **SET** button.
 - ✓ The left cornering light is switched off.
 - ✓ The right cornering light test is started.
- Wait for a few seconds until the upper segment of the right cornering light lights up continuously.

- Checking the right cornering light setting.

The light-dark boundary of the upper segment must run exactly through the right marking.

- » If the boundary between light and dark does not meet specifications:
 - Adjust the cornering light range. (🔧 p. 18)

- Press the **SET** button.
 - ✓ The cornering light is switched off.

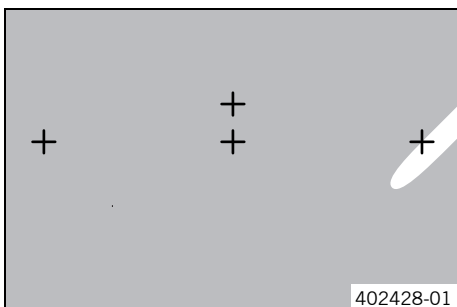
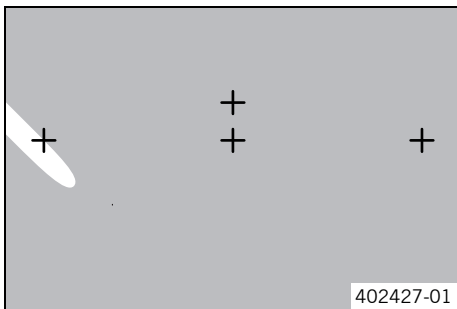

3.19 Adjusting the headlight range

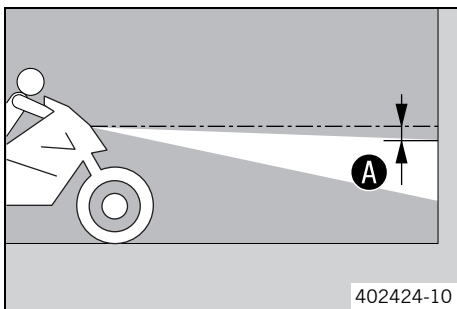
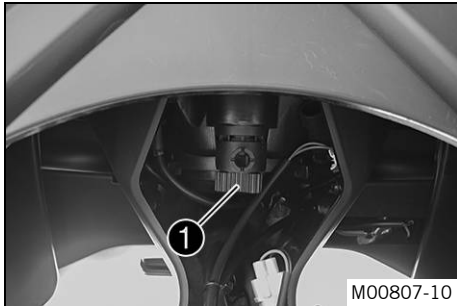

Preparatory work

- Check the setting of the lighting system. (📖 p. 16)
- Remove the bottom triple clamp cover. (📖 p. 9)

Main work

- Turn adjusting screw ❶ to adjust the headlight range.



Info

Turn clockwise to increase the headlight range; turn counterclockwise to reduce the headlight range.
If you have a payload, you may have to correct the headlight range.

- Set the headlight to marking A.

Guideline

The light-dark boundary must lie exactly on the lower mark A when the motorcycle is ready to operate with the rider mounted along with any luggage and a passenger if applicable.

Finishing work

- Install the bottom triple clamp cover. (📖 p. 10)

3.20 Adjusting the cornering light range

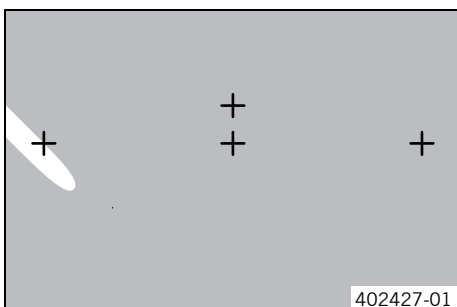

Preparatory work

- Check the setting of the lighting system. (📖 p. 16)

Main work

- Press the **UP** or **DOWN** button until the "Settings" menu appears on the matrix display. Pressing the **SET** button opens the menu.
- Press the **UP** or **DOWN** button until "cLightTest" is highlighted in black on the matrix display. Pressing the **SET** button again starts the cornering light test.
- Wait for a few seconds until the upper segment of the left cornering light lights up continuously.
- Turn adjusting screw ❶ to adjust the left cornering light range.



Info

Turn clockwise to increase the headlight range; turn counterclockwise to reduce the headlight range.

- Set the upper segment on the left marking.

Guideline

The light-dark boundary of the upper segment must run exactly through the left marking.

- Press the **SET** button.
 - ✓ The left cornering light is switched off.
 - ✓ The right cornering light test is started.
- Wait for a few seconds until the upper segment of the right cornering light lights up continuously.

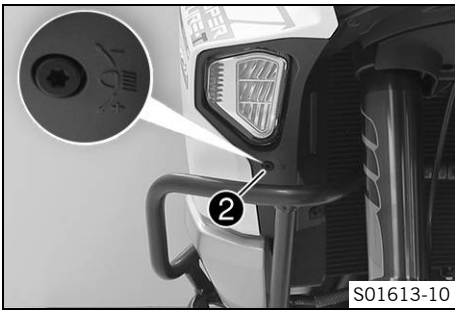

- Turn adjusting screw ② to adjust the right cornering light range.



Info

Turn clockwise to increase the headlight range; turn counterclockwise to reduce the headlight range.

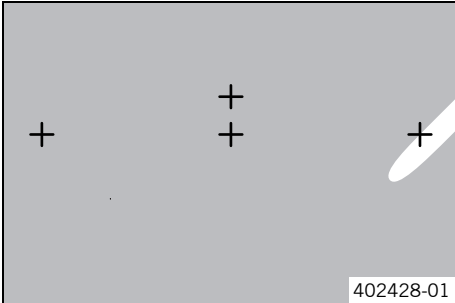

- Set the upper segment on the left marking.

Guideline

The light-dark boundary of the upper segment must run exactly through the right marking.

- Press the **SET** button.
- ✓ The cornering light is switched off.

3.21 Mount reflector (1290 Super Adventure T US)

Preparatory work

- Clean and degrease the surface of the suitcase.

Main work

- Remove protective film ① from the back of reflector ②.

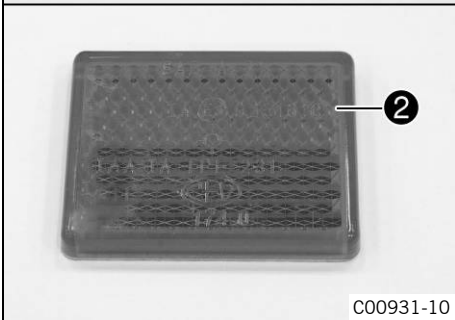
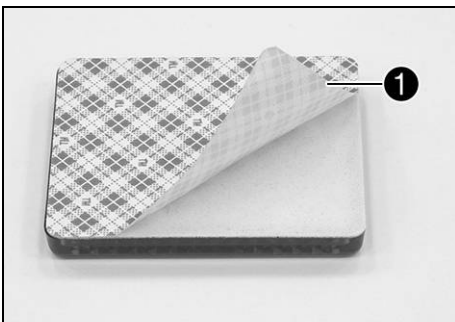



- Position reflector ② in the upper third of the rear recess of the left-hand suitcase, and then press down on the reflector.

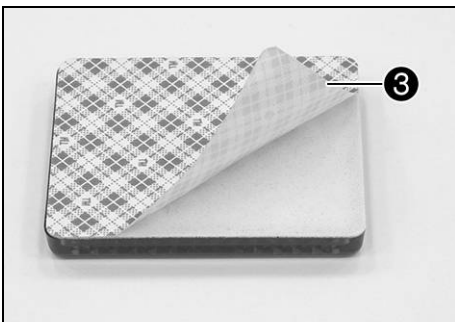

- Remove protective film ③ from the back of second reflector ④.

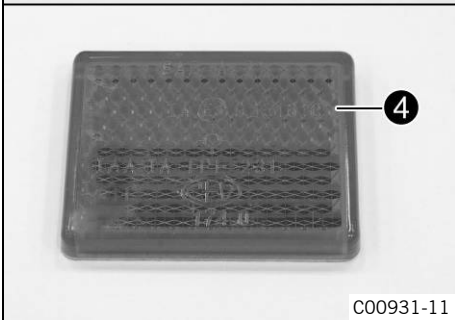

- Position reflector ④ in the upper third of the rear recess of the right-hand suitcase, and then press down on the reflector.



4.1 chassis tightening torques

Nut, passenger seat heating switch	PG21	2 Nm (1.5 lbf ft)	–
Nut, tire pressure sensor	ISO 10V2	12 Nm (8.9 lbf ft)	Loctite® 2701™
Screw, fixed grip handlebar	EJOT Spiralform® M4x6-K	2.7 Nm (1.99 lbf ft)	–
Screw, combination switch, left	M4	2 Nm (1.5 lbf ft)	–
Screw, side stand switch	M4	2 Nm (1.5 lbf ft)	–
Rear fairing screw	M5x12	3.5 Nm (2.58 lbf ft)	–
Rear fairing screw	M5x17	3.5 Nm (2.58 lbf ft)	–
Remaining screws for radiator	M5	3.5 Nm (2.58 lbf ft)	–
Remaining screws, chassis	M5	5 Nm (3.7 lbf ft)	–
Screw, brake line holder on frame	M5	2 Nm (1.5 lbf ft)	–
Screw, brake line holder on swingarm	M5	5 Nm (3.7 lbf ft)	–
Screw, cable channel	M5	5 Nm (3.7 lbf ft)	–
Screw, cable guide, wheel speed sensor, rear	M5	3 Nm (2.2 lbf ft)	–
Screw, chain sliding guard	M5	5 Nm (3.7 lbf ft)	–
Screw, combination switch, right	M5	3.5 Nm (2.58 lbf ft)	–
Screw, cover part	M5	3.5 Nm (2.58 lbf ft)	–
Screw, cross member for luggage support (1290 Super Adventure T EU)	M5	4 Nm (3 lbf ft)	–
Screw, filler cap	M5	3 Nm (2.2 lbf ft)	–
Screw, foot brake lever stub	M5	6 Nm (4.4 lbf ft)	Loctite® 243™
Screw, fuel level sensor	M5	3 Nm (2.2 lbf ft)	–
Screw, heat guard on main silencer	M5	4 Nm (3 lbf ft)	–
Screw, wind shield	M5	3.5 Nm (2.58 lbf ft)	–
Spoke nipple	M5	5 Nm (3.7 lbf ft)	–
Ground fitting on frame	M6	6 Nm (4.4 lbf ft)	–
Nut, ABS unit fixation	M6	8 Nm (5.9 lbf ft)	–
Remaining chassis nuts	M6	10 Nm (7.4 lbf ft)	–
Remaining chassis screws	M6	10 Nm (7.4 lbf ft)	–
Screw, acceleration sensor	M6	6 Nm (4.4 lbf ft)	–
Screw, angle sensor	M6	6 Nm (4.4 lbf ft)	Loctite® 243™
Screw, ball joint of push rod on foot brake cylinder	M6	10 Nm (7.4 lbf ft)	Loctite® 243™
Screw, battery terminal	M6	4.5 Nm (3.32 lbf ft)	–
Screw, cable channel	M6	5 Nm (3.7 lbf ft)	–
Screw, chain guide	M6	5 Nm (3.7 lbf ft)	–
Screw, clutch assembly	M6	5 Nm (3.7 lbf ft)	–
Screw, cooler retaining bracket	M6	7 Nm (5.2 lbf ft)	–
Screw, cover part	M6	6 Nm (4.4 lbf ft)	–
Screw, engine guard	M6	10 Nm (7.4 lbf ft)	–
Screw, exhaust clamp	M6	8 Nm (5.9 lbf ft)	–
Screw, foot brake cylinder	M6	10 Nm (7.4 lbf ft)	Loctite® 243™
Screw, front brake disc	M6	14 Nm (10.3 lbf ft)	Loctite® 243™
Screw, fuel pump	M6	6 Nm (4.4 lbf ft)	–
Screw, fuel tank	M6	10 Nm (7.4 lbf ft)	–
Screw, fuel tap	M6	6 Nm (4.4 lbf ft)	–
Screw, headlight	M6	5 Nm (3.7 lbf ft)	–
Screw, lower rear part	M6	6 Nm (4.4 lbf ft)	–
Screw, magnetic holder on side stand	M6	6 Nm (4.4 lbf ft)	Loctite® 243™
Screw, rear brake disc	M6	14 Nm (10.3 lbf ft)	Loctite® 243™
Screw, retaining bracket, angle sensor	M6	10 Nm (7.4 lbf ft)	–

Screw, voltage regulator	M6	6 Nm (4.4 lbf ft)	–
Screw, wheel speed sensor, front	M6	10 Nm (7.4 lbf ft)	–
Screw, wheel speed sensor, rear	M6	10 Nm (7.4 lbf ft)	–
Remaining chassis nuts	M8	25 Nm (18.4 lbf ft)	–
Remaining chassis screws	M8	25 Nm (18.4 lbf ft)	–
Screw, bottom triple clamp	M8	12 Nm (8.9 lbf ft)	–
Screw, exhaust clamp	M8	25 Nm (18.4 lbf ft)	–
Screw, foot brake lever	M8	25 Nm (18.4 lbf ft)	Loctite® 243™
Screw, fork stub	M8	15 Nm (11.1 lbf ft)	–
Screw, front footrest bracket	M8	25 Nm (18.4 lbf ft)	Loctite® 243™
Screw, handlebar clamp	M8	20 Nm (14.8 lbf ft)	–
Screw, ignition lock (tamper-proof screw)	M8	25 Nm (18.4 lbf ft)	Loctite® 243™
Screw, rail fitting (1290 Super Adventure T EU)	M8	20 Nm (14.8 lbf ft)	Loctite® 243™
Screw, rear footrest bracket	M8	25 Nm (18.4 lbf ft)	Loctite® 243™
Screw, steering damper	M8	25 Nm (18.4 lbf ft)	Loctite® 243™
Screw, steering damper clamp	M8	12 Nm (8.9 lbf ft)	–
Screw, steering stem	M8	20 Nm (14.8 lbf ft)	–
Screw, suitcase hook	M8	20 Nm (14.8 lbf ft)	Loctite® 243™
Screw, top triple clamp	M8	15 Nm (11.1 lbf ft)	–
Engine carrying screw	M10	45 Nm (33.2 lbf ft)	–
Remaining chassis nuts	M10	45 Nm (33.2 lbf ft)	–
Remaining chassis screws	M10	45 Nm (33.2 lbf ft)	–
Screw, front brake caliper	M10	45 Nm (33.2 lbf ft)	Loctite® 243™
Screw, handlebar support	M10	40 Nm (29.5 lbf ft)	Loctite® 243™
Screw, side stand	M10	35 Nm (25.8 lbf ft)	Loctite® 243™
Screw, side stand bracket	M10	45 Nm (33.2 lbf ft)	Loctite® 243™
Banjo bolt, brake line	M10x1	25 Nm (18.4 lbf ft)	–
Nut, rear sprocket screw	M10x1.25	50 Nm (36.9 lbf ft)	Loctite® 243™
Lambda sensor	M12x1.25	25 Nm (18.4 lbf ft)	–
Screw, bottom shock absorber	M14x1.5	80 Nm (59 lbf ft)	Thread greased
Screw, top shock absorber	M14x1.5	80 Nm (59 lbf ft)	Thread greased
Nut, socket	M18x1	4 Nm (3 lbf ft)	–
Nut, swingarm pivot	M19x1.5	130 Nm (95.9 lbf ft)	Thread greased
Screw, steering head, top	M22x1.5	18 Nm (13.3 lbf ft)	–
Nut, rear wheel spindle	M25x1.5	90 Nm (66.4 lbf ft)	Thread greased
Screw, front wheel spindle	M25x1.5	45 Nm (33.2 lbf ft)	Thread greased

Super unleaded (ROZ 95/RON 95/PON 91)

Standard/classification

- DIN EN 228 (ROZ 95/RON 95/PON 91)

Guideline

- Only use unleaded super fuel that matches or is equivalent to the specified fuel grade.
- Fuel with an ethanol content of up to 10 % (E10 fuel) is safe to use.



Info

Do **not** use fuel containing methanol (e. g. M15, M85, M100) or more than 10 % ethanol (e. g. E15, E25, E85, E100).



3213661en

01/2017

