

1290 Super Duke GT

Art. no. 3214112en



KTM

Congratulations on your decision to purchase a KTM motorcycle. You are now the owner of a state-of-the-art sports vehicle that will continue giving you pleasure for a long time if you maintain it properly.

We wish you good and safe riding at all times!

Enter the serial numbers of your vehicle below.

Vehicle identification number (📖 p. 26)	Dealer's stamp
Engine number (📖 p. 27)	
Key number (📖 p. 27)	

The Owner's Manual contained the latest information for this model series at the time of going to print. However, minor differences due to further developments in design cannot be ruled out completely.

All specifications contained herein are non-binding. KTM Sportmotorcycle GmbH specifically reserves the right to modify or delete technical specifications, prices, colors, forms, materials, services, designs, equipment, etc., without prior notice and without specifying reasons, to adapt these to local conditions, as well as to stop production of a particular model without prior notice. KTM accepts no liability for delivery options, deviations from figures and descriptions, misprints, and other errors. The models portrayed partly contain special equipment that does not belong to the regular scope of supply.

© 2019 KTM Sportmotorcycle GmbH, Mattighofen Austria
All rights reserved



3214112en

10/2019

Reproduction, even in part, as well as copying of all kinds, is permitted only with the express written permission of the copyright owner.



REG.NO. 12 100 6061

KTM Sportmotorcycle GmbH
Stallhofnerstraße 3
5230 Mattighofen, Austria

ISO 9001(12 100 6061)

KTM applies quality assurance processes that lead to the highest possible product quality as defined in the ISO 9001 international quality management standard.

Issued by: TÜV Management Service

This document is valid for the following models:

1290 Super Duke GT EU (F9903TE, F9903TF)

1290 Super Duke GT JP (F9986TE)

1	MEANS OF REPRESENTATION	10	4	VIEW OF VEHICLE	22
	1.1 Symbols used	10	4.1	View of vehicle, front left (example) ...	22
	1.2 Formats used.....	11	4.2	View of vehicle, rear right (example).....	24
2	SAFETY ADVICE.....	12	5	SERIAL NUMBERS	26
	2.1 Use definition – intended use.....	12	5.1	Vehicle identification number.....	26
	2.2 Misuse.....	12	5.2	Type label	26
	2.3 Safety advice.....	12	5.3	Key number.....	27
	2.4 Degrees of risk and symbols	13	5.4	Engine number	27
	2.5 Tampering warning.....	14	5.5	Fork part number	28
	2.6 Safe operation	14	5.6	Shock absorber article number	28
	2.7 Protective clothing	16	5.7	Steering damper article number	29
	2.8 Work rules.....	16	6	CONTROLS.....	30
	2.9 Environment.....	17	6.1	Clutch lever.....	30
	2.10 Owner's Manual	17	6.2	Hand brake lever.....	30
3	IMPORTANT NOTES.....	18	6.3	Throttle grip	31
	3.1 Manufacturer and implied warranty....	18	6.4	Combination switch, left side	31
	3.2 Fuel, auxiliary substances	18	6.5	Light switch	32
	3.3 Spare parts, accessories	18	6.6	Menu button.....	33
	3.4 Service	19	6.7	Turn signal switch.....	34
	3.5 Figures	19	6.8	Horn button.....	35
	3.6 Customer service.....	19	6.9	Cruise control system tip switch	35
			6.10	Combination switch, right	39

TABLE OF CONTENTS

6.11	Emergency OFF switch/electric starter button	40	6.32	Shift lever	58
6.12	Hazard warning flasher switch	41	6.33	Foot brake lever	59
6.13	RACE-ON button	42	6.34	Side stand.....	59
6.14	RACE-ON key	43	7	COMBINATION INSTRUMENT	61
6.15	Steering lock (antenna).....	44	7.1	Combination instrument	61
6.16	Immobilizer	45	7.2	Activation and test	62
6.17	Socket for electrical accessories	45	7.3	Day-night mode	64
6.18	USB socket	46	7.4	Warnings.....	65
6.19	Connecting the USB cable	46	7.5	Brake system, temperature warning ...	66
6.20	Disconnecting the USB cable.....	47	7.6	Ice warning	66
6.21	Opening the storage compartment on the left.....	49	7.7	Indicator lamps.....	68
6.22	Opening the storage compartment on the right.....	50	7.8	Display	72
6.23	Closing the storage compartment on the left.....	51	7.9	Track layout (optional).....	74
6.24	Closing the storage compartment on the right.....	51	7.10	Performance layout (optional).....	75
6.25	Opening fuel tank filler cap.....	52	7.11	Engine speed.....	75
6.26	Closing the fuel tank filler cap.....	54	7.12	Shift warning light	76
6.27	Seat lock.....	55	7.13	Cruise control indicator.....	77
6.28	Tool set.....	55	7.14	Speed	78
6.29	Grab handle	56	7.15	ABS display.....	79
6.30	Case holders.....	56	7.16	MTC display	79
6.31	Passenger foot pegs	57	7.17	Ride display	80
			7.18	Damp display	80
			7.19	Gear display	81
			7.20	Heated grip (optional).....	81
			7.21	Seat heater (optional).....	82

7.22	Load display	82	7.31.16	Service	107
7.23	Coolant temperature indicator	83	7.31.17	Extra Functions	108
7.24	Fuel level display	83	7.31.18	Motorcycle	109
7.25	Ambient air temperature indicator	84	7.31.19	Heated Grips (optional)	109
7.26	Time.....	85	7.31.20	Heated Seat (optional)	110
7.27	Favourites display	85	7.31.21	Load.....	111
7.28	Quick Selector 1 display.....	86	7.31.22	Damping.....	112
7.29	Quick Selector 2 display.....	86	7.31.23	Ride Mode	113
7.30	Navigation display (optional)	87	7.31.24	MTC	114
7.31	Menu.....	88	7.31.25	MTC+MSR (optional).....	115
7.31.1	KTM MY RIDE (optional)	88	7.31.26	ABS.....	116
7.31.2	Audio (optional).....	89	7.31.27	HHC (optional)	117
7.31.3	Navigation (optional).....	91	7.31.28	Settings	117
7.31.4	Navigation setup (optional)	92	7.31.29	Favourites	118
7.31.5	Navigation information (optional)	94	7.31.30	Quick Selector 1.....	119
7.31.6	Volume (optional)	95	7.31.31	Quick Selector 2.....	120
7.31.7	Bluetooth (optional)	96	7.31.32	Shift Light	121
7.31.8	Pairing (optional)	98	7.31.33	Units	122
7.31.9	Telephony (optional)	101	7.31.34	Distance	122
7.31.10	Info	102	7.31.35	Temperature.....	123
7.31.11	Trip 1	103	7.31.36	Pressure	123
7.31.12	Trip 2.....	104	7.31.37	Consumption.....	124
7.31.13	General Info	105	7.31.38	Language	125
7.31.14	TPMS	105	7.31.39	Setting the time and date.....	125
7.31.15	Warnings.....	107	7.31.40	Daytime Runn. Light	128
			7.31.41	Quickshift + (optional)	129

TABLE OF CONTENTS

7.31.42	Track (optional)	130	8.10	Checking the basic position of the shift lever.....	150
7.31.43	Layout (optional).....	130	8.11	Adjusting the basic position of the shift lever 🖱️.....	151
7.31.44	Launch Control (optional)	131	8.12	Setting the shift lever stub.....	152
7.31.45	Anti Wheelie Mode (optional)	132	9	PREPARING FOR USE.....	153
7.31.46	Heated Grips (optional)	133	9.1	Advice on preparing for first use	153
7.31.47	Heated Seat Rider (optional).....	134	9.2	Running in the engine	155
7.31.48	Heated Seat Pas (optional)	135	9.3	Loading the vehicle.....	155
7.31.49	Corner. Light Test	136	10	RIDING INSTRUCTIONS.....	158
8	ERGONOMICS	137	10.1	Checks and maintenance measures when preparing for use	158
8.1	Handlebar position.....	137	10.2	Starting the vehicle	159
8.2	Adjusting the handlebar position 🖱️.....	137	10.3	Launch Control (optional)	162
8.3	Adjusting the steering angle 🖱️.....	141	10.4	Starting off.....	162
8.4	Adjusting the windshield	142	10.5	Starting off with launch control (optional)	163
8.5	Adjusting the tilt of the combination instrument.....	144	10.6	Start off with HHC (Option: Hill-start assist)	164
8.6	Adjusting the basic position of the clutch lever	145	10.7	Anti wheelie mode (optional).....	165
8.7	Adjusting the basic position of the hand brake lever	146	10.8	Quickshifter + (optional).....	166
8.8	Adjusting the basic position of the foot brake lever 🖱️.....	147	10.9	Shifting, riding.	167
8.9	Setting the step plate of the foot brake lever	149	10.10	MSR (optional)	173
			10.11	Applying the brakes.....	174















10.12	Stopping, parking.....	176	13.8	Mounting the front rider's seat.....	195
10.13	Transporting.....	178	13.9	Removing the windshield.....	196
10.14	Refueling.....	180	13.10	Installing the windshield.....	196
11	SERVICE SCHEDULE.....	183	13.11	Removing the main silencer 	197
11.1	Additional information.....	183	13.12	Installing the main silencer 	199
11.2	Required work.....	183	13.13	Checking the chain for dirt.....	200
11.3	Recommended work.....	186	13.14	Cleaning the chain.....	201
12	SUSPENSION SETTING.....	187	13.15	Checking the chain tension.....	203
12.1	Fork/shock absorber.....	187	13.16	Adjusting the chain tension.....	205
12.2	"Load".....	187	13.17	Checking the chain, rear sprocket, engine sprocket, and chain guide	206
12.3	"Damping".....	188	13.18	Checking/correcting the fluid level of the hydraulic clutch.....	211
13	SERVICE WORK ON THE CHASSIS.....	189	13.19	Removing the fuel tank spoiler.....	214
13.1	Raising the motorcycle with the rear lifting gear.....	189	13.20	Installing the fuel tank spoiler.....	215
13.2	Removing the rear of motorcycle from the lifting gear.....	189	13.21	Removing front fender.....	216
13.3	Lifting the motorcycle with the front lifting gear.....	190	13.22	Installing front fender 	216
13.4	Taking the motorcycle off the front lifting gear.....	191	13.23	Cleaning the dust boots of the fork legs 	217
13.5	Removing the passenger seat.....	192	14	BRAKE SYSTEM.....	219
13.6	Mounting the passenger seat.....	193	14.1	Anti-lock braking system (ABS).....	219
13.7	Removing the front rider's seat.....	193	14.2	Rear brake temperature monitoring (BTM).....	222
			14.3	Checking the brake discs.....	223

TABLE OF CONTENTS

14.4	Checking the front brake fluid level	224	16.7	Changing the RACE-ON key battery	262
14.5	Adding front brake fluid 	225	16.8	Changing the main fuse	263
14.6	Checking the front brake linings	228	16.9	Changing the fuses in the fuse box	265
14.7	Checking the rear brake fluid level	229	16.10	Checking the setting of the lighting system	268
14.8	Adding rear brake fluid 	230	16.11	Adjusting the headlight range	272
14.9	Checking the brake linings of the rear brake	233	16.12	Adjusting the cornering light range	273
15	WHEELS, TIRES	234	16.13	Diagnostics connector	276
15.1	Removing the front wheel 	234	16.14	Front ACC1 and ACC2	277
15.2	Installing the front wheel 	236	16.15	ACC1 and ACC2 rear	278
15.3	Removing the rear wheel 	239	17	COOLING SYSTEM	279
15.4	Installing the rear wheel 	241	17.1	Checking the coolant level in the compensating tank	279
15.5	Checking the tire condition	244	17.2	Correcting the coolant level in the compensating tank	281
15.6	Checking tire pressure	246	18	ENGINE TUNING	283
15.7	Using tire repair spray	247	18.1	Ride Mode	283
16	ELECTRICAL SYSTEM	249	18.2	Motorcycle traction control (MTC)	284
16.1	Daytime running light (DRL)	249	18.3	Slip adjustment (optional)	285
16.2	Cornering light	250	18.4	Throttle Response (optional)	286
16.3	Socket for electrical accessories	251			
16.4	Removing 12-V battery 	252			
16.5	Installing the 12-V battery 	254			
16.6	Charging the 12-V battery 	257			

19	SERVICE WORK ON THE ENGINE	287	23.6	Tires	321
19.1	Checking the engine oil level.....	287	23.7	Fork.....	322
19.2	Changing the engine oil and oil filter, cleaning the oil screens 	288	23.8	Shock absorber	322
19.3	Adding engine oil	296	23.9	Chassis tightening torques	323
20	CLEANING, CARE	299	24	DECLARATIONS OF CONFORMITY	330
20.1	Cleaning the motorcycle	299	24.1	Declarations of conformity	330
20.2	Checks and maintenance steps for winter operation.....	302	24.2	Country-specific declarations of conformity.....	332
21	STORAGE.....	304	25	SUBSTANCES	333
21.1	Storage	304	26	AUXILIARY SUBSTANCES	337
21.2	Preparing for use after storage.....	306	27	STANDARDS	339
22	TROUBLESHOOTING	307	28	INDEX OF SPECIAL TERMS	340
23	TECHNICAL DATA	311	29	LIST OF ABBREVIATIONS.....	342
23.1	Engine	311	30	LIST OF SYMBOLS.....	343
23.2	Engine tightening torques	313	30.1	Red symbols.....	343
23.3	Capacities	318	30.2	Yellow and orange symbols.....	343
23.3.1	Engine oil	318	30.3	Green and blue symbols.....	344
23.3.2	Coolant	318	INDEX.....		345
23.3.3	Fuel	318			
23.4	Chassis	319			
23.5	Electrical system.....	320			

1 MEANS OF REPRESENTATION

1.1 Symbols used

The meaning of specific symbols is described below.



Indicates an expected reaction (e.g. of a work step or a function).



Indicates an unexpected reaction (e.g. of a work step or a function).



All work marked with this symbol requires specialist knowledge and technical understanding. In the interest of your own safety, have these jobs performed by an authorized KTM workshop! Your motorcycle will be optimally cared for there by specially trained experts using the auxiliary tools required.



Indicates a page reference (more information is provided on the specified page).



Indicates information with more details or tips.



Indicates the result of a testing step.

V	Indicates a voltage measurement.
A	Indicates a current measurement.
◀	Indicates the end of an activity, including potential rework.

1.2 Formats used

The typographical formats used in this document are explained below.

Proprietary name	Indicates a proprietary name.
Name®	Indicates a protected name.
Brand™	Indicates a brand available on the open market.
<u>Underlined terms</u>	Refer to technical details of the vehicle or indicate technical terms, which are explained in the glossary.

2 SAFETY ADVICE

2.1 Use definition – intended use

The vehicle is designed and constructed to withstand the usual demands of regular traffic and use on race courses. This vehicle is not suitable for offroad use.



Info

This vehicle is only authorized for operation on public roads in its homologated version.

2.2 Misuse

The vehicle must only be used as intended.

Dangers can arise for people, property and the environment through use not as intended.

Any use of the vehicle beyond the intended and defined use constitutes misuse.

Misuse also includes the use of operating and auxiliary fluids which do not meet the required specification for the respective use.

2.3 Safety advice

A number of safety instructions need to be followed to operate the product described safely. Therefore read this instruction and all further instructions included carefully. The safety instructions are highlighted in the text and are referred to at the relevant passages.

**Info**

Various information and warning labels are attached in prominent locations on the product described. Do not remove any information or warning labels. If they are missing, you or others may not recognize dangers and may therefore be injured.

2.4**Degrees of risk and symbols**

**Danger**

Identifies a danger that will immediately and invariably lead to fatal or serious permanent injury if the appropriate measures are not taken.

**Warning**

Identifies a danger that is likely to lead to fatal or serious injury if the appropriate measures are not taken.

**Caution**

Identifies a danger that may lead to minor injuries if the appropriate measures are not taken.

Note

Identifies a danger that will lead to considerable machine and material damage if the appropriate measures are not taken.

**Note**

Indicates a danger that will lead to environmental damage if the appropriate measures are not taken.

2.5 Tampering warning

Tampering with the noise control system is prohibited. Federal law prohibits the following acts or the causing thereof:

- 1 The removal or rendering inoperative by any person other than for purposes of servicing, repair, or replacement, of any device or element of design incorporated into any new vehicle for the purpose of noise control prior to its sale or delivery to the ultimate purchaser or while it is in use, or
- 2 the use of the vehicle after such device or element of design has been removed or rendered inoperative by any person.

Among those acts presumed to constitute tampering are the acts listed below:

- 1 Removal or puncturing of the main silencers, baffles, header pipes or any other components which conduct exhaust gases.
- 2 Removal or puncturing of parts of the intake system.
- 3 Lack of proper maintenance.
- 4 Replacing moving parts of the vehicle, or parts of the exhaust system or intake system, with parts other than those specified by the manufacturer.

2.6 Safe operation



Danger

Danger of accidents A rider who is not fit to ride poses a danger to him or herself and others.

- Do not operate the vehicle if you are not fit to ride due to alcohol, drugs or medication.
- Do not operate the vehicle if you are physically or mentally impaired.

**Danger**

Danger of poisoning Exhaust gases are toxic and inhaling them may result in unconsciousness and death.

- Always make sure there is sufficient ventilation when running the engine.
- Use effective exhaust extraction when starting or running the engine in an enclosed space.

**Warning**

Danger of burns Some vehicle components become very hot when the vehicle is operated.

- Do not touch any parts such as the exhaust system, radiator, engine, shock absorber, or brake system before the vehicle parts have cooled down.
- Let the vehicle parts cool down before you perform any work on the vehicle.

Only operate the vehicle when it is in perfect technical condition, in accordance with its intended use, and in a safe and environmentally compatible manner.

The vehicle should only be used by trained persons. An appropriate driver's license is needed to ride the vehicle on public roads.

Have malfunctions that impair safety promptly eliminated by an authorized KTM workshop.

Adhere to the information and warning labels on the vehicle.

2.7 Protective clothing



Warning

Risk of injury Missing or poor protective clothing presents an increased safety risk.

- Wear appropriate protective clothing such as helmet, boots, gloves as well as trousers and a jacket with protectors on all rides.
- Always wear protective clothing that is in good condition and meets the legal regulations.

In the interest of your own safety, KTM recommends that you only operate the vehicle while wearing protective clothing.

2.8 Work rules

Unless specified otherwise, the ignition must be turned off during all work (models with ignition lock, models with remote key) or the engine must be at a standstill (models without ignition lock or remote key).

Special tools are necessary for certain tasks. The tools are not a component of the vehicle, but can be ordered using the number in parentheses. Example: bearing puller (15112017000)

During assembly, use new parts to replace parts which cannot be reused (e.g. self-locking screws and nuts, seals, sealing rings, O-rings, pins, and lock washers).

In the case of certain screws, a screw adhesive (e.g. **Loctite**®) is required. Observe the manufacturer's instructions.

If thread locker (e.g., **Precote**®) has already been applied to a new part, do not apply any additional thread locker. After disassembly, clean the parts that are to be reused and check them for damage and wear. Change damaged or worn parts.

After completing a repair or service work, check the operating safety of the vehicle.

2.9 Environment

If you use your motorcycle responsibly, you can ensure that problems and conflicts do not occur. To protect the future of the motorcycle sport, make sure that you use your motorcycle legally, display environmental consciousness, and respect the rights of others.

When disposing of used oil, other operating and auxiliary fluids, and used components, comply with the laws and regulations of the respective country.

Because motorcycles are not subject to the EU regulations governing the disposal of used vehicles, there are no legal regulations that pertain to the disposal of an end-of-life motorcycle. Your authorized KTM dealer will be glad to advise you.

2.10 Owner's Manual

It is important that you read this Owner's Manual carefully and completely before making your first trip. The Owner's Manual contains useful information and many tips on how to operate, handle, and service your motorcycle. Only then will you find out how to customize the vehicle ideally for your own use and how you can protect yourself from injury.

Keep the Owner's Manual in an accessible place to enable you to refer to it as needed.

If you would like to know more about the vehicle or have questions on the material you read, please contact an authorized KTM dealer.

The Owner's Manual is an important component of the vehicle and must be handed over to the new owner if the vehicle is sold.

The Owner's Manual is also available for download from your authorized KTM dealer and on the KTM website.
International KTM Website: <http://www.ktm.com>

3 IMPORTANT NOTES

3.1 Manufacturer and implied warranty

The work specified in the service schedule may only be performed in an authorized KTM workshop and must be recorded in both the Service & Warranty Booklet and in the **KTM Dealer.net**, otherwise any warranty coverage will become void. Damage or secondary damage caused by tampering with and/or conversions on the vehicle is not covered by the manufacturer warranty.

Additional information on the manufacturer or manufacturer warranty and the procedures involved can be found in the Service & Warranty Booklet.

3.2 Fuel, auxiliary substances



Note

Environmental hazard Improper handling of fuel is a danger to the environment.

- Do not allow fuel to enter the groundwater, the soil, or the sewage system.

Use fuels and auxiliary substances in accordance with the Owner's Manual and specification.

3.3 Spare parts, accessories

For your own safety, only use spare parts and accessory products that are approved and/or recommended by KTM and have them installed by an authorized KTM workshop. KTM accepts no liability for other products and any resulting damage or loss.

Certain spare parts and accessory products are specified in parentheses in the descriptions. Your authorized KTM dealer will be glad to advise you.

The current **KTM PowerParts** for your vehicle can be found on the KTM website.
International KTM Website: <http://www.ktm.com>

3.4 Service

A prerequisite for perfect operation and prevention of premature wear is that the service, care, and tuning work on the engine and chassis is properly carried out as described in the Owner's Manual. An incorrect suspension setting can lead to damage and breakage of chassis components.

Use of the vehicle under difficult conditions, such as in heavy rain, intense heat or with a heavy payload, may result in significantly increased wear of components such as the drive train, brake system, or suspension components. For this reason, it may be necessary to inspect or replace parts before the next scheduled service.

It is imperative that you adhere to the stipulated run-in times and service intervals. If you observe these exactly, you will ensure a much longer service life for your motorcycle.

The relevant mileage or time interval is whichever occurs first.

3.5 Figures

The figures contained in the manual may depict special equipment.

In the interest of clarity, some components may be shown disassembled or may not be shown at all. It is not always necessary to disassemble the component to perform the activity in question. Please follow the instructions in the text.

3.6 Customer service

Your authorized KTM dealer will be happy to answer any questions you may have on your vehicle and KTM.

3 IMPORTANT NOTES

A list of authorized KTM dealers can be found on the KTM website.
International KTM Website: <http://www.ktm.com>

4 VIEW OF VEHICLE

4.1 View of vehicle, front left (example)

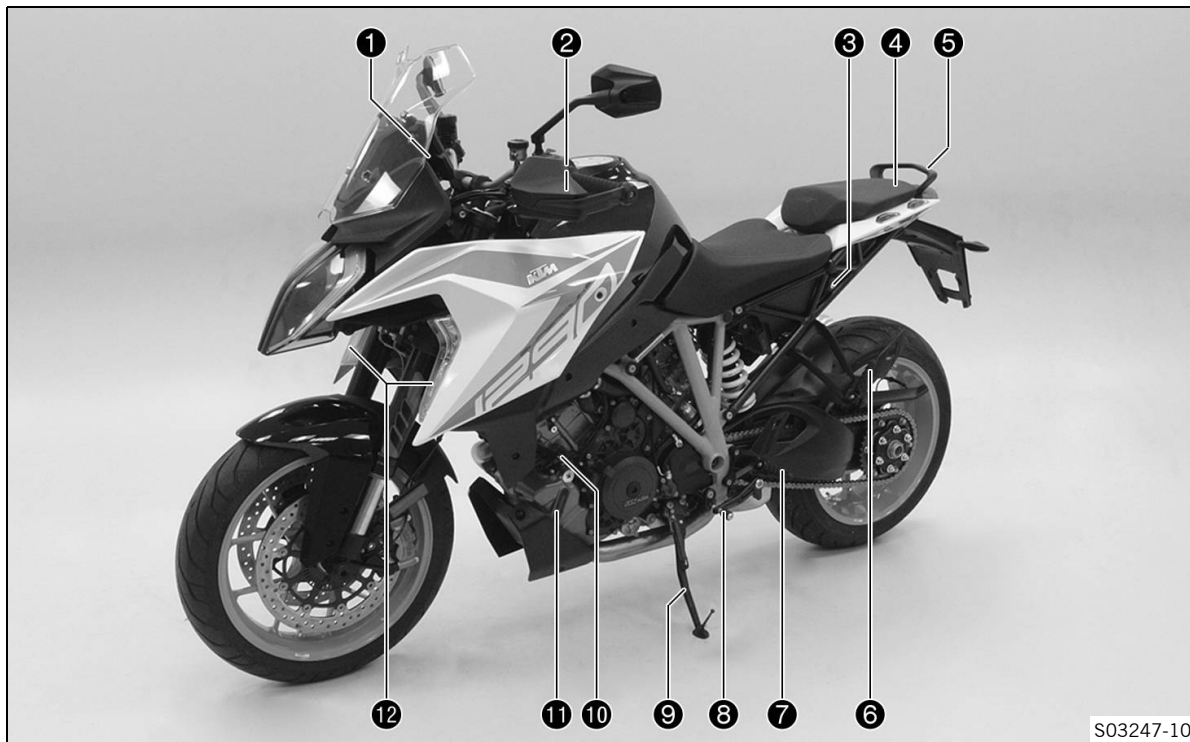

S03247-10

- ❶ Socket for electrical accessories (📖 p. 45)
- ❷ Clutch lever (📖 p. 30)
- ❸ Seat lock (📖 p. 55)
- ❹ Tool set (📖 p. 55)
- ❺ Grab handle (📖 p. 56)
- ❻ Passenger foot pegs (📖 p. 57)
- ❼ Rider footrests
- ❽ Shift lever (📖 p. 58)
- ❾ Side stand (📖 p. 59)
- ❿ Engine oil filler neck
- ⓫ Level viewer, engine oil
- ⓬ Cornering light (📖 p. 250)

4 VIEW OF VEHICLE

4.2 View of vehicle, rear right (example)

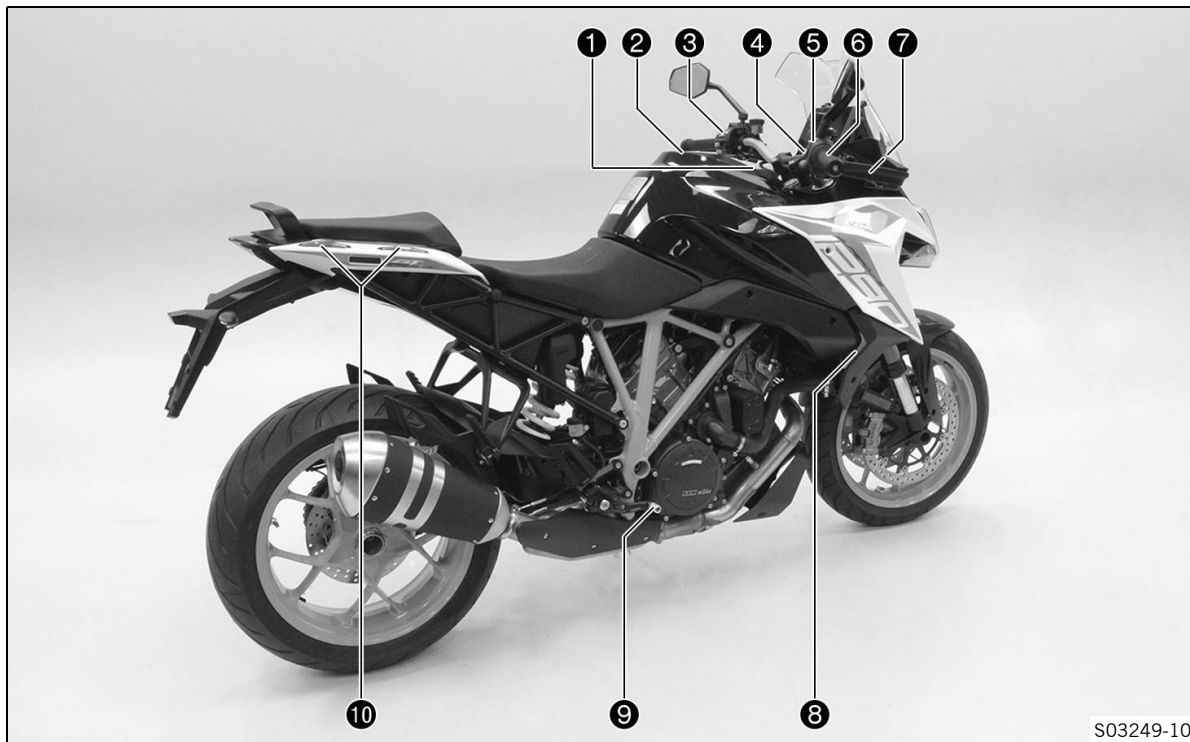

- ① Steering lock (antenna) (📖 p. 44)
- ② Fuel tank filler cap
- ③ Combination switch, left side (📖 p. 31)
- ④ RACE-ON button (📖 p. 42)
- ⑤ Emergency OFF switch/electric starter button (📖 p. 40)
- ⑥ Throttle grip (📖 p. 31)
- ⑦ Hand brake lever (📖 p. 30)
- ⑧ Cooling system compensating tank
- ⑨ Foot brake lever (📖 p. 59)
- ⑩ Case holders (📖 p. 56)

5 SERIAL NUMBERS

5.1 Vehicle identification number

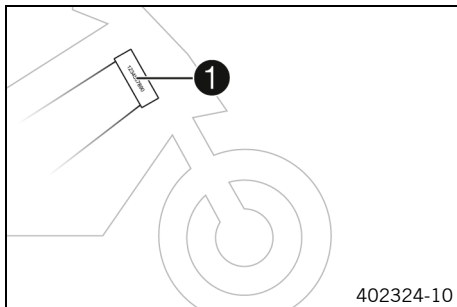

The vehicle identification number **1** is stamped on the right side of the steering head.

The vehicle identification number is also shown on the type label.

5.2 Type label

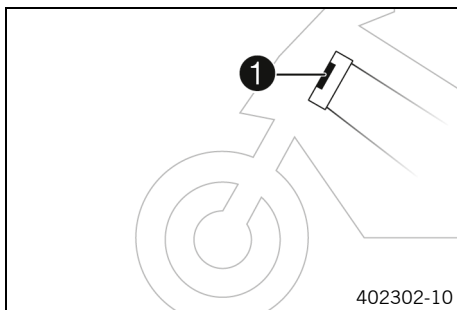

The type label **1** is located on the steering head.

5.3 Key number

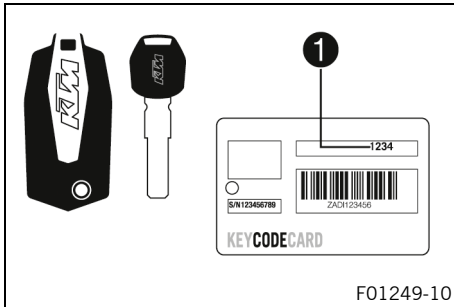

The key number **Code number 1** can be found on the **KEYCODECARD**.

i Info

You need the key number to order a spare key. Keep the **KEYCODECARD** in a safe place.

5.4 Engine number

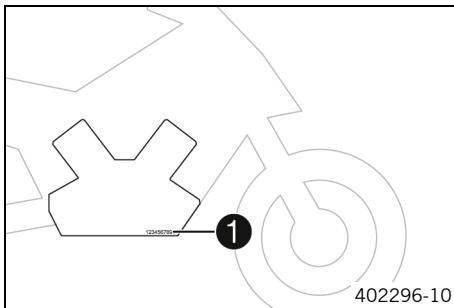

The engine number **1** is stamped on the right side of the engine.

5 SERIAL NUMBERS

5.5 Fork part number

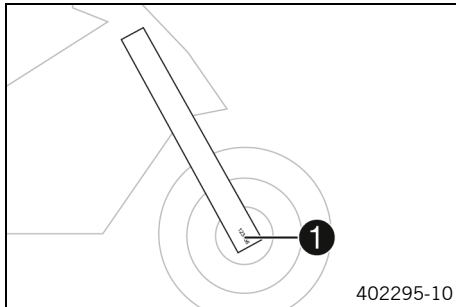

The fork part number **1** is stamped on the inside of the axle clamp.

5.6 Shock absorber article number

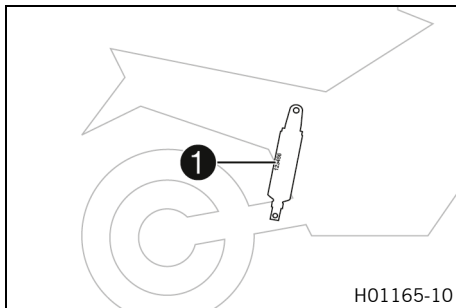

The shock absorber article number **1** is printed on a sticker on the shock absorber case under the spring.

5.7 Steering damper article number

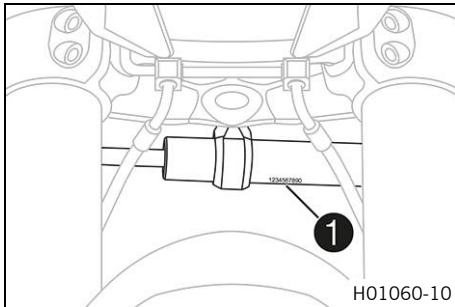

Steering damper item number ① is embossed on the underside of the steering damper.

6 CONTROLS

6.1 Clutch lever

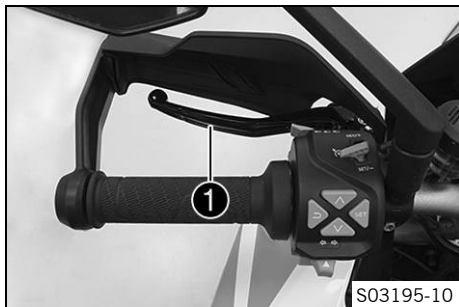

Clutch lever **1** is fitted on the handlebar on the left. The clutch is activated hydraulically and adjusts itself automatically.

6.2 Hand brake lever



The hand brake lever **1** is located on the right side of the handlebar. The front brake is engaged using the hand brake lever.

6.3 Throttle grip



The throttle grip **1** is fitted on the right side of the handlebar.

6.4 Combination switch, left side

The left combination switch is fitted on the left side of the handlebar.

6 CONTROLS

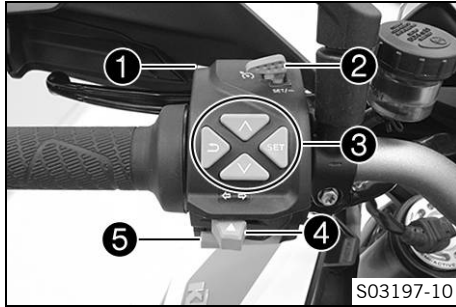

Overview of the left combination switch

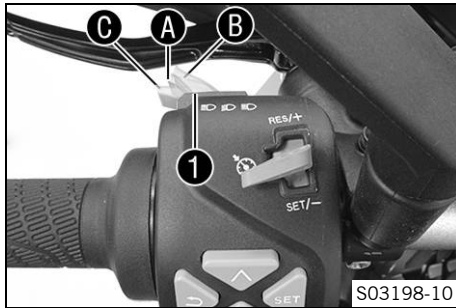

- ❶ Light switch (📖 p. 32)
- ❷ Cruise control system tip switch (📖 p. 35)
- ❸ Menu button (📖 p. 33)
- ❹ Turn signal switch (📖 p. 34)
- ❺ Horn button (📖 p. 35)

6.5 Light switch



The light switch ❶ is fitted on the combination switch on the left.

Possible states

	Low beam on – Light switch in position A . In this position, the low beam and the tail light are switched on.
	High beam on – Light switch in position B . In this position, the high beam and the tail light are switched on.



Headlight flasher – Light switch in position **C**. The headlight flasher is operated in this position. The light switch returns automatically to the position **A** after use.

6.6 Menu button

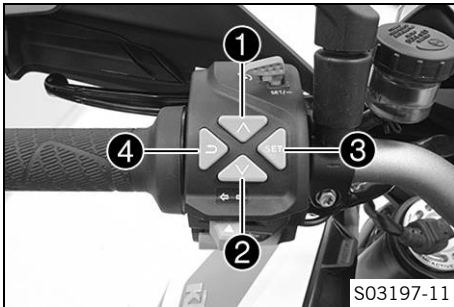

The menu switch is fitted in the middle on the left side of the combination switch.

The menu buttons are used to control the matrix display on the combination instrument.

Button **1** is the **UP** button.

Button **2** is the **DOWN** button.

Button **3** is the **SET** button.



Button **4** is the **BACK** button.

6.7 Turn signal switch



Turn signal switch ❶ is fitted on the combination switch on the left.

Possible states

	Turn signal off – Push the turn signal switch toward the switch housing.
	Left turn signal, on – Turn signal switch pressed to the left. The turn signal switch returns automatically to the central position after use.
	Right turn signal, on – Turn signal switch pressed to the right. The turn signal switch returns automatically to the central position after use.

i Info

An automatic turn signal switch-off function (**ATIR**) is available as a software feature.

The **ATIR** function uses a time and distance counter.

If the turn signal has been on for at least 10 seconds and 150 meters of riding distance, the turn signal is switched off.

If the vehicle is stationary, both counters are stopped.

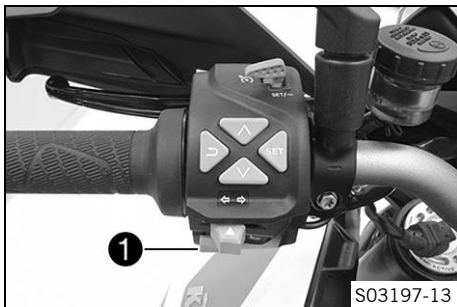

If the turn signal switch is reactivated, both counters are reset.

6.8 Horn button



Horn button **1** is fitted on the left side of the handlebar.

Possible states



- The horn button  is in the basic position
- The horn button  is pressed – The horn is operated in this position.



6.9 Cruise control system tip switch



The **1** cruise control system tip switch is fitted on the left side of the combination switch.

Possible states

- Cruise control system tip switch  in the basic position.
- Cruise control system tip switch  pressed to the left. – In this position, the cruise control system function is switched on and off. The operating mode is displayed in the combination instrument.
- Briefly press cruise control system tip switch  in position **RES/+**. – The last saved speed is reapplied. Every subsequent brief pressing increases the target speed by 1 km/h or 1 mph.

- Press and hold cruise control system tip switch  in position **RES/+**. – The target speed increases in increments of 5 km/h or 5 mph.
- Briefly press cruise control system tip switch  in position **SET/-**. – The cruise control system function is activated and the current speed is maintained. Every subsequent brief press reduces the target speed by 1 km/h or 1 mph.
- Press and hold the cruise control system tip switch  in position **SET/-**. – The target speed decreases in increments of 5 km/h or 5 mph.



Info

After activation of the cruise control system function, the throttle grip can be turned back to the home position. The selected speed will be maintained.

If the target speed is exceeded for less than 30 seconds by turning the throttle grip, the cruise control system remains activated.

To switch off the cruise control system function, press the cruise control system tip switch  to the left.

In addition, the cruise control system function is deactivated when one of the following events occurs:

- Operating the hand brake lever
- Operating the foot brake lever
- Operating the clutch lever
- Shifting gears
- Turning the throttle grip beyond the home position
- Control of the motorcycle traction control (**MTC**)
- Slip at the rear wheel or lifting front wheel
- A fault occurring, which impairs the cruise control system function
- Exceeding the target speed for more than 30 seconds when overtaking



Warning

Danger of accidents The cruise control system function is not suitable for all driving situations.

The selected target speed will not be reached, if the engine power is not sufficient for a gradient.

The selected target speed will be exceeded if the engine braking effect is not sufficient on a decline.

- Do not use the cruise control systems function on winding roads.
- Do not use the cruise control systems on slippery road surfaces (e.g. rain, ice or snow) or unpaved surfaces (e.g. sand, stones or gravel).
- Do not use the cruise control systems function if the traffic does not permit a constant speed.

The cruise control system function is only available when motorcycle traction control (**MTC**) is activated.

When motorcycle traction control (**MTC**) is switched off, the cruise control system function is also switched off.

The cruise control system function cannot be activated during rapid acceleration.

The cruise control system function can only be activated in third, fourth, fifth and sixth-gear.

The control range is from 40 to 200 km/h or from 25 to 125 mph.

6.10 Combination switch, right

The right combination switch is fitted on the right side of the handlebar.

Overview of the right combination switch

- ❶ Hazard warning flasher switch (📖 p. 41)
- ❷ Emergency OFF switch/electric starter button (📖 p. 40)
- ❸ RACE-ON button (📖 p. 42)

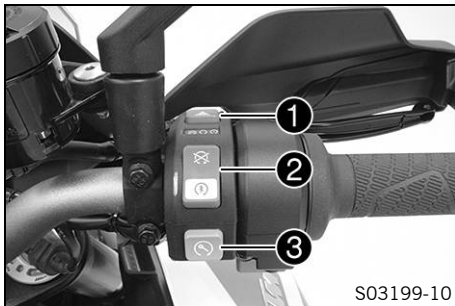

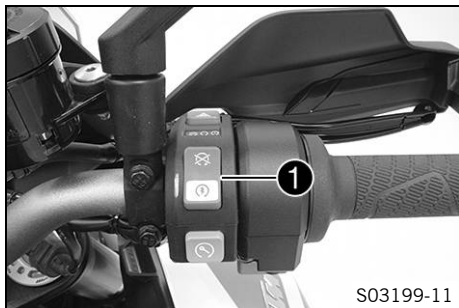

6.11 Emergency OFF switch/electric starter button



The emergency OFF switch/electric starter button **1** is fitted on the right side of the combination switch.

Possible states

	<p>Emergency OFF switch/electric starter button off (top position) – In this position, the ignition circuit is interrupted, a running engine stops, and a non-running engine cannot be started. A message appears on the display.</p>
	<p>Emergency OFF switch/electric starter button on (middle position) – This position is required for operation; the ignition circuit is closed.</p>
	<p>Starter motor on (lower position) – In this position, the starter motor is actuated.</p>

6.12 Hazard warning flasher switch

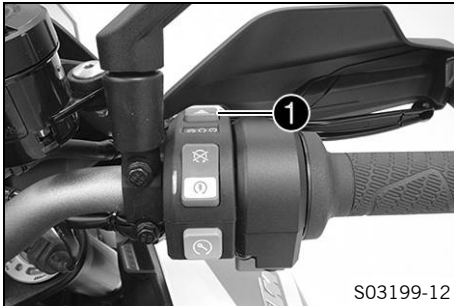

The hazard warning flasher switch ① is fitted on the right side of the combination switch.

The hazard warning flasher is used to indicate emergency situations.

i Info

The hazard warning flasher can be activated or deactivated while the ignition is switched on or up to 60 seconds after the ignition is switched off.

Only keep the hazard warning flasher activated as long as necessary as it depletes the 12-V battery.

Possible states



Hazard warning flasher on – All four turn signals and the green turn signal indicator lights in the combination instrument flash.

6.13 RACE-ON button

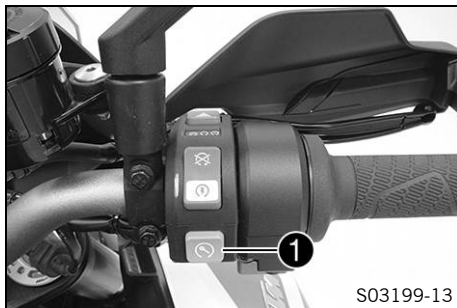



The RACE-ON button ① is fitted on the right side of the combination switch.

i Info

The RACE-ON button performs the ignition lock function on this vehicle.

The steering can only be locked if the handlebar is turned to the left.

Possible states

- RACE-ON button  in the basic position.
- RACE-ON button  pressed briefly – Pressing briefly switches the ignition on and unlocks the steering lock or switches the ignition off. The RACE-ON indicator lamp lights up briefly once for confirmation.
- RACE-ON button  pressed and held – Pressing and holding switches the ignition off and locks the steering lock.

6.14 RACE-ON key

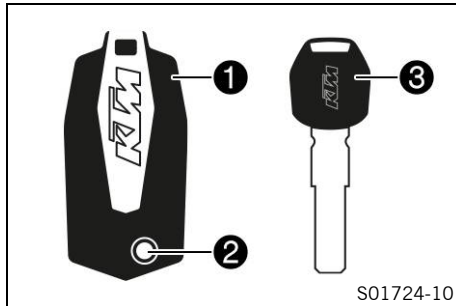

In this vehicle, the RACE-ON key ① performs all the functions of the conventional ignition key.

Press the ② button to fold out the key bit. The key bit is only used for unlocking the seat lock and for opening the cases (optional).

The black ignition key ③ is only intended for situations in which the RACE-ON key is not available or is not functional.

The black ignition key can be used to start the vehicle if the RACE-ON key battery voltage is too low and the transponder is not recognized by the vehicle. The black Race-on key can also be used to unlock the seat lock and open the cases (optional).

i **Info**

The ignition keys contain electronic components. Always maintain a distance of several centimeters to other devices with electronic components.

A lost ignition key must be deactivated by an authorized KTM workshop to prevent unauthorized persons from operating the vehicle.

The ignition keys supplied are activated when delivered.

Up to four ignition keys in total can be activated by an authorized KTM workshop. The key number must be provided in each case.

6.15 Steering lock (antenna)

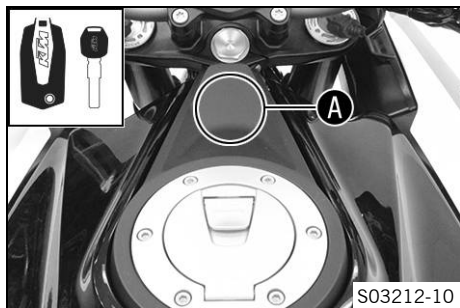

On this vehicle, the ignition/steering lock is replaced by a remote key with transponder (RACE-ON key (📖 p. 43)).

In order to activate the steering lock, the handlebar must be turned fully to the left.

The steering is locked and unlocked electromechanically via the RACE-ON button (📖 p. 42).

If the battery voltage of the RACE-ON key is too low, place either the RACE-ON key or the black ignition key in area **A** and repeat starting.

i Info

Store the ignition key safely again as soon as the engine has been started.

Possible states

- Ignition off, steering locked – In this operating mode, the ignition circuit is interrupted and the steering locked.
- Ignition off, steering unlocked – In this operating mode, the ignition circuit is interrupted and the steering unlocked.
- Ignition on, steering unlocked – In this operating mode, the ignition circuit is closed and the steering unlocked.

6.16 Immobilizer



The electronic immobilizer secures the vehicle against unauthorized use.

The immobilizer is activated and the engine electronics are locked as soon as the ignition is switched off via the RACE-ON button (📖 p. 42).

The RACE-ON indicator lamp **1** can indicate errors by flashing. If the optional alarm system is installed, the RACE-ON indicator lamp **1** flashes when the ignition is switched off and the alarm system is switched on.

6.17 Socket for electrical accessories

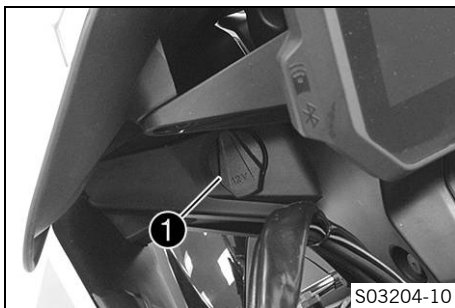

Socket **1** for electrical accessories is mounted on the left side of the instrument support.

It is connected to the permanent positive and is fuse-protected.

Socket for electrical accessories	
Voltage	12 V
Maximum current consumption	10 A

6.18 USB socket

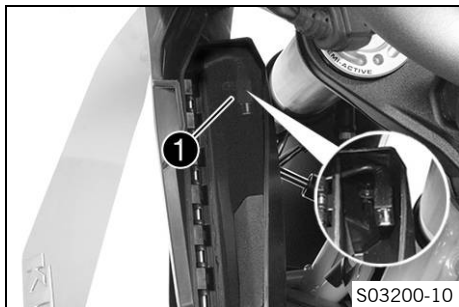

A USB socket **1** for supplying power to external devices is located in the left storage compartment. The USB socket is activated when the ignition is switched on.

USB socket	
Voltage	5 V
Maximum current consumption	2.1 A

6.19 Connecting the USB cable

Preliminary work

- Open storage compartment on the left. (📖 p. 49)

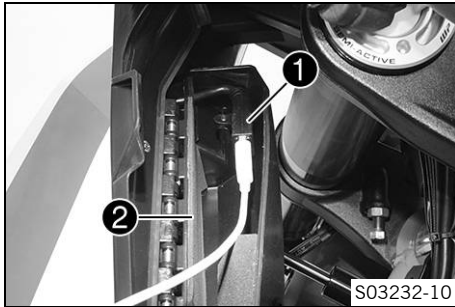

Main work

- Connect a suitable USB cable to the USB socket ①.
- Connect USB cable to the device and stow in the ② storage compartment.



Info

Depending on the size of the device, an angled plug is advantageous.
Always secure stowed objects additionally against moisture.
Stow cables so that no damage can result.

Final steps

- Close storage compartment on the left. (📖 p. 51)



6.20 Disconnecting the USB cable

Preliminary work

- Open storage compartment on the left. (📖 p. 49)

6 CONTROLS

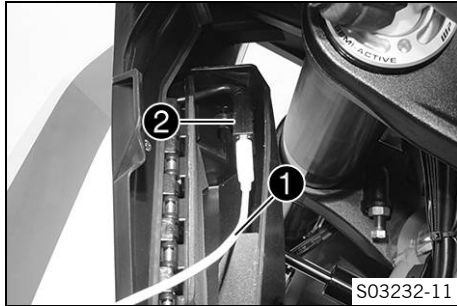

Main work

- Disconnect USB cable **1** from the device.
- Disconnect USB cable from the USB socket **2**.

Final steps

- Close storage compartment on the left. (📖 p. 51)

6.21 Opening the storage compartment on the left

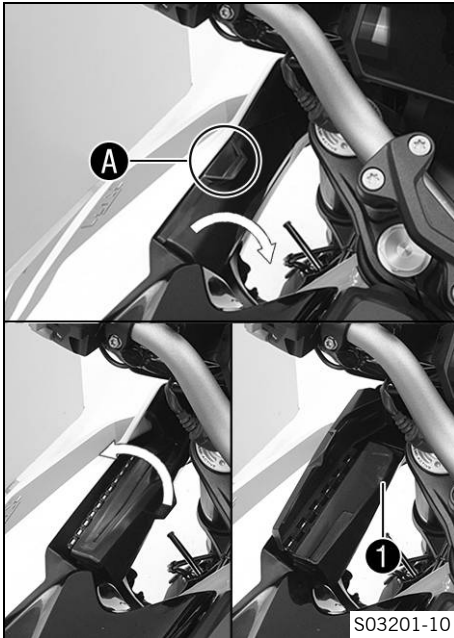

- Turn handlebar as far as possible to the right.
- Fold out storage compartment in area **A** toward the fork leg.
- Open storage compartment.

i Info

A USB socket (📖 p. 46) **1** is located in the storage compartment for supplying power to external devices. The storage compartment must be closed before going on a ride.

6.22 Opening the storage compartment on the right



- Turn handlebar all the way to the left.
- Fold out storage compartment in area **A** toward the fork leg.
- Open storage compartment.



Info

The storage compartment must be closed before going on a ride.

6.23 Closing the storage compartment on the left

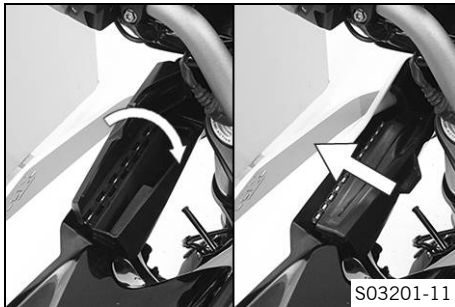

- Close storage compartment.
- Fold down storage compartment.



Info

With the handlebar turned all the way to the left and with locked steering, the storage compartment is hard to access, however the storage compartment is not lockable.

6.24 Closing the storage compartment on the right



- Close storage compartment.
- Fold down storage compartment.



Info

The storage compartment is not lockable.

6.25 Opening fuel tank filler cap



Danger

Fire hazard Fuel is highly flammable.

The fuel in the fuel tank expands when warm and can escape if overfilled.

- Do not refuel the vehicle in the vicinity of open flames or lit cigarettes.
- Switch off the engine for refueling.
- Make sure that no fuel is spilled; particularly not on hot parts of the vehicle.
- If any fuel is spilled, wipe it off immediately.
- Observe the specifications for refueling.



Warning

Danger of poisoning Fuel is poisonous and a health hazard.

- Avoid skin, eye and clothing contact with fuel.
- Immediately consult a doctor if you swallow fuel.
- Do not inhale fuel vapors.
- In case of skin contact, rinse the affected area with plenty of water.
- Rinse the eyes thoroughly with water, and consult a doctor in case of fuel contact with the eyes.
- Change your clothing in case of fuel spills on them.
- Keep fuels correctly in a suitable canister, and out of the reach of children.

**Note**

Environmental hazard Improper handling of fuel is a danger to the environment.

- Do not allow fuel to enter the groundwater, the soil, or the sewage system.

Condition

The motorcycle is stationary.

The engine is switched off.

The ignition has been switched on or off for less than 1 minute.

- Fold up cover ① slowly.
 - ✓ The fuel tank filler cap is unlocked.
- Fold up fuel tank filler cap ②.

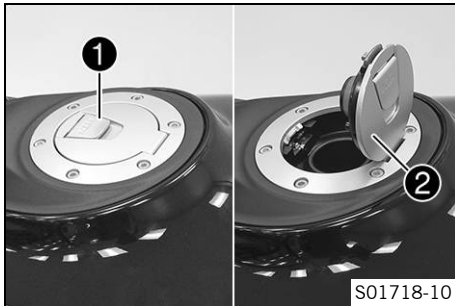

6.26 Closing the fuel tank filler cap

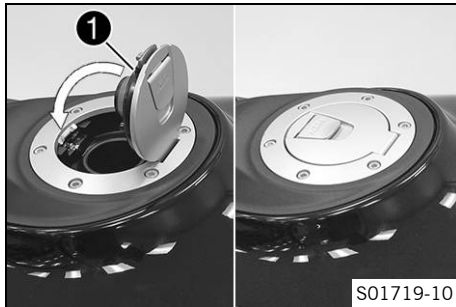

Warning

Fire hazard Fuel is highly flammable, toxic and a health hazard.

- Check that the fuel tank filler cap is locked correctly after closing.
- Change your clothing if fuel spills on them.
- Rinse the affected area immediately with plenty of water in the event of contact with the skin.

- Fold down fuel tank filler cap ① and push it down.
 - ✓ The fuel tank filler cap locks audibly in place.

6.27 Seat lock

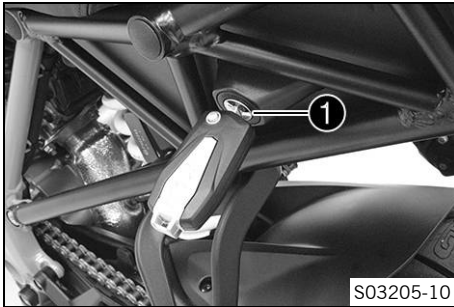

Seat lock **1** is located on the left side of the vehicle under the seat.

It can be unlocked using the RACE-ON key or the black ignition key.

6.28 Tool set

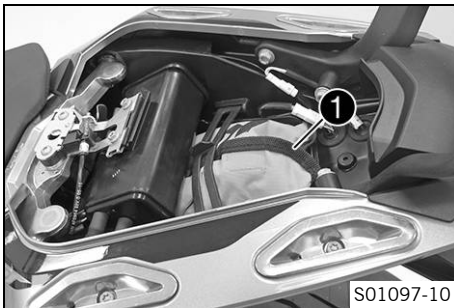

The storage compartment under the passenger seat contains tool set **1**.

6 CONTROLS

6.29 Grab handle

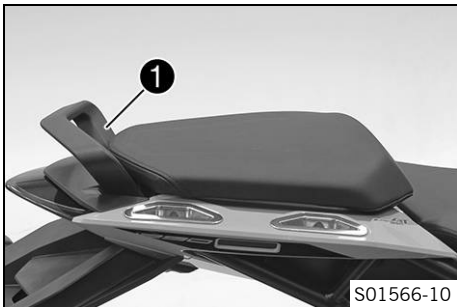

The passenger can hold onto the grab handle **1** during the trip.

6.30 Case holders

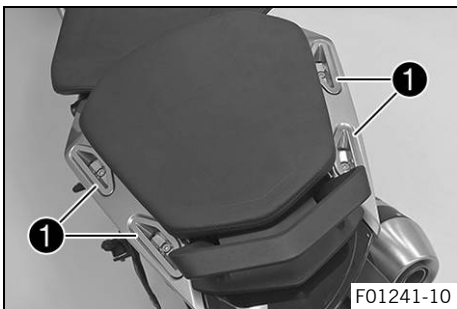

Case holders **1** are located on each side of the passenger seat. A case system (optional) can be attached on the case holders. The case holders may not be loaded with more than the specified weight.

Maximum permissible load of the case holders per side	7 kg (15 lb.)
---	---------------

**Info**

Follow the instructions provided by the luggage manufacturer.

6.31 Passenger foot pegs

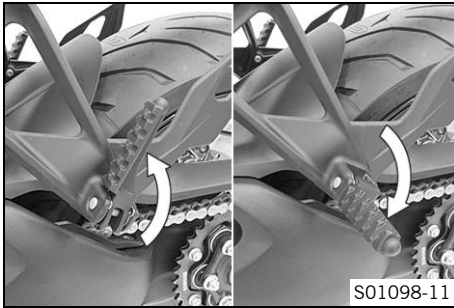

The passenger foot pegs can be folded up and down.

Possible states

- Passenger foot pegs folded up – For operation without a passenger.
- Passenger foot pegs folded down – For operation with a passenger.

6.32 Shift lever

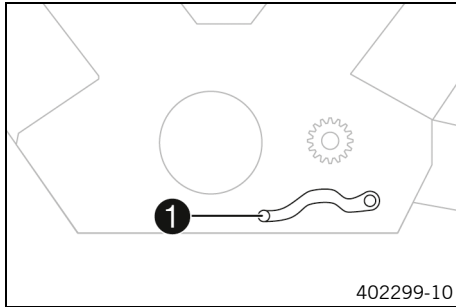

The shift lever **1** is fitted on the left side of the engine.

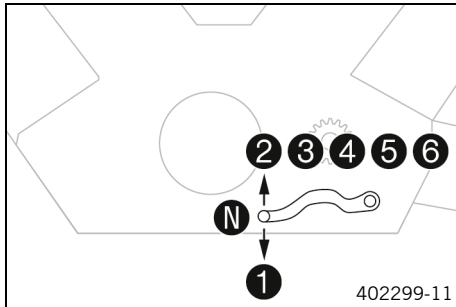

The gear positions can be seen in the figure.
The idle position is between first and second gears.

6.33 Foot brake lever

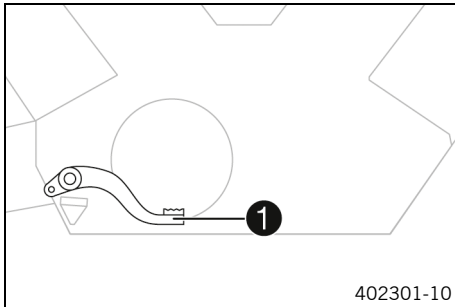

Foot brake lever **1** is located in front of the right footrest. The rear brake is engaged with the foot brake lever.

6.34 Side stand

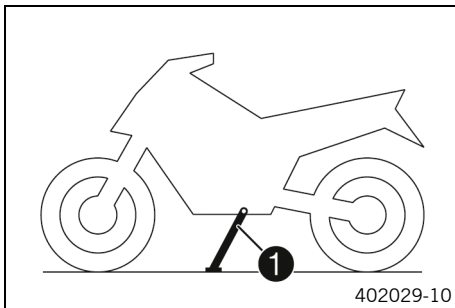

Side stand **1** is located on the left of the vehicle. The side stand is used for parking the motorcycle.

i Info

The side stand must be folded up during motorcycle use. The side stand is coupled with the safety starting system; see the instructions in the "Stopping, parking" chapter.

Possible states

- Side stand folded out – The vehicle can be supported on the side stand. The safety starting system is active.

6 CONTROLS

- Side stand folded in – This position is mandatory when riding the motorcycle. The safety starting system is inactive.

7.1 Combination instrument

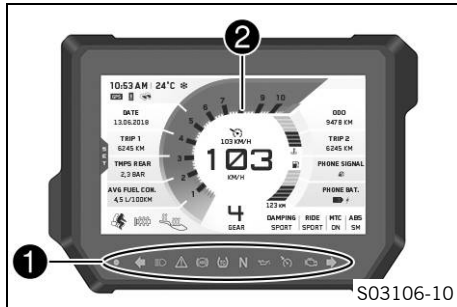

The combination instrument is attached in front of the handlebar. The combination instrument is divided into two function areas.

① indicator lamps (🔊 p. 68)

Display ②



Warning

Danger of burns Parts of the combination instrument become very hot in certain situations.

In particular, the display gets hot in ambient temperatures above 55 °C (131 °F), during extended stationary periods, e.g. at a traffic light, or in direct sunlight.

- Do not touch the combination instrument with bare hands in the situations referred to.
- Where appropriate protective clothing.
- If you have been burned, hold the area affected under lukewarm water immediately.

7 COMBINATION INSTRUMENT

7.2 Activation and test



Activation

The combination instrument is activated when the ignition is switched on.



Info

The brightness of the displays is controlled by an ambient light sensor in the combination instrument.

Test

The welcome text appears on the display and the indicator lamps are briefly activated for a function check.



Info

The malfunction indicator lamp always lights up as long as the engine is not running. If the engine is running and the malfunction indicator lamp lights up, stop (taking care not to endanger yourself or other road users in the process) and contact an authorized KTM workshop.

The oil pressure warning lamp always lights up as long as the engine is not running. If the engine is running and the oil pressure warning lamp lights up, stop immediately (taking care not to endanger yourself or other road users in the process) and switch off the engine.

The ABS warning lamp and TC indicator lamp light up until a speed of approx. 6 km/h (approx. 4 mph) or more has been reached.

7 COMBINATION INSTRUMENT

7.3 Day-night mode



Day mode is shown in a bright color.



Night mode is shown in a dark color.



Info

The ambient light sensor in the combination instrument measures the brightness of the environment and automatically switches the display to day or night mode. The display is brightened, darkened or switched to the other mode depending on the brightness measured by the ambient light sensor.

The display mode cannot be changed manually.

7.4 Warnings

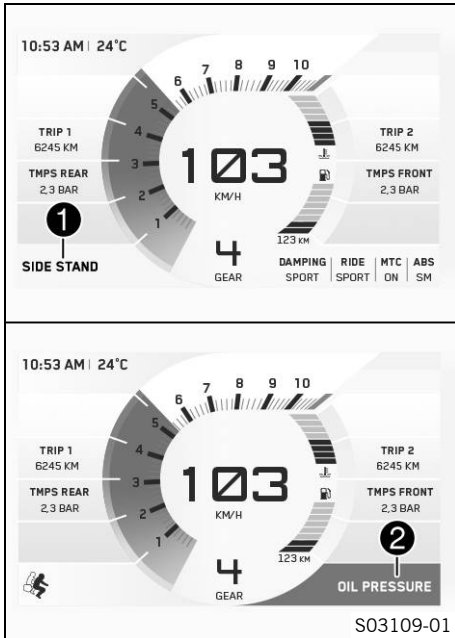

Warnings appear on the bottom edge of the display; these are marked yellow or red depending on their relevance. Yellow warnings ① indicate errors or information which require prompt intervention or an adjustment to the riding style. Red warnings ② indicate errors or information which require immediate intervention.

Info

Warnings can be hidden by pressing any button. All the existing warnings are displayed in the **Warnings** menu until they are no longer active.

7 COMBINATION INSTRUMENT

7.5 Brake system, temperature warning

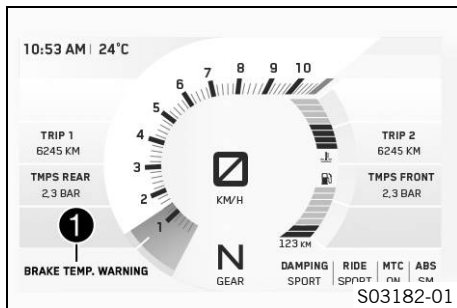

When the rear brake is used frequently and for excessively long periods, for example on long downhill stretches, the temperature of the brake system may increase.

The warning ① is displayed in the lower area of the combination instrument.

Combined use of the rear and front brake is recommended.

7.6 Ice warning

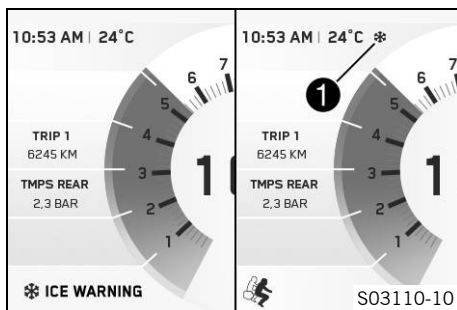

The ice warning ❄ goes on when there is an increased risk of ice on the roads.

The ice warning ❄ is shown in area ① of the display.

The ice warning ❄ appears on the display when the ambient temperature drops below the specified value.

Temperature	3 °C (37 °F)
-------------	--------------

The ice warning ❄ goes out on the display when the ambient temperature rises above the specified value again.

Temperature	4 °C (39 °F)
-------------	--------------



Info

When the ice warning ❄️ lights up, the warning **ICE WARNING** also appears.

7 COMBINATION INSTRUMENT

7.7 Indicator lamps



F01267-01

The indicator lamps offer additional information about the operating state of the motorcycle. When the ignition is switched on, all indicator lamps light up briefly.





i Info

The malfunction indicator lamp always lights up as long as the engine is not running. If the engine is running and the malfunction indicator lamp lights up, stop (taking care not to endanger yourself or other road users in the process) and contact an authorized KTM workshop.







The oil pressure warning lamp always lights up as long as the engine is not running. If the engine is running and the oil pressure warning lamp lights up, stop immediately (taking care not to endanger yourself or other road users in the process) and switch off the engine.

The ABS warning lamp and TC indicator lamp light up until a speed of approx. 6 km/h (approx. 4 mph) or more has been reached.

Possible states

	RACE-ON indicator lamp lights up/flashes yellow/orange/red – Status or error messages relating to Race-on system/alarm system.
	The left turn signal indicator lamp flashes green with a steady rhythmic flash – The left turn signal is switched on.
	The high beam indicator lamp lights up blue – The high beam is switched on.
	The general warning lamp lights up yellow – A note/warning note on operating safety has been detected. This is also shown in the display.
	The ABS warning lamp lights up yellow – Status or error messages relating to <u>ABS</u> . The ABS warning lamp flashes if the ABS mode Supermoto is enabled.

7 COMBINATION INSTRUMENT

	TC indicator lamp lights up/flashes yellow – The MTC (📖 p. 284) is not enabled or is currently intervening. The TC indicator lamp also lights up if an error is detected. Contact an authorized KTM workshop. The TC indicator lamp flashes if the motorcycle traction control actively engages or if the HHC (📖 p. 164) (optional) is activated.
	The idle indicator lamp lights up green – The transmission is in neutral.
	The oil pressure warning lamp lights up red – The oil pressure is too low. Stop immediately, taking care not to endanger yourself or other road users in the process, and switch off the engine.
	The cruise control system indicator lamp lights up yellow – The cruise control system function is switched on, but cruise control is not activated.
	The cruise control system indicator lamp lights up green – The cruise control system function is switched on and cruise control is activated.
	Malfunction indicator lamp lights up yellow – The OBD has detected an error in the vehicle electronics.
	The right turn signal indicator lamp flashes green with a steady rhythmic flash – The right turn signal is switched on.

7 COMBINATION INSTRUMENT

7.8 Display

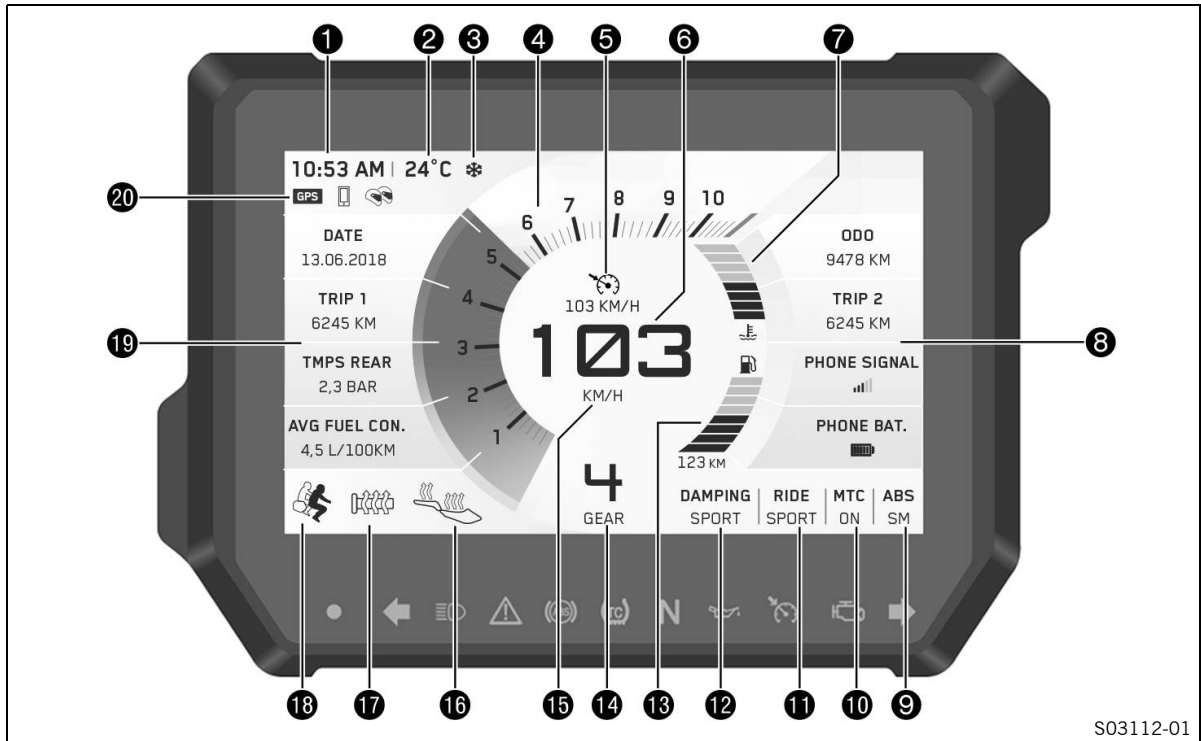

S03112-01

**Info**

The figure shows the start screen of the combination instrument. If the menu is opened, the speed is still displayed.

- ① Time (📖 p. 85)
 - ② Ambient air temperature indicator (📖 p. 84)
 - ③ Ice warning (📖 p. 66)
 - ④ Engine speed (📖 p. 75)
 - ④ Shift warning light
The shift warning light is integrated in the tachometer display.
 - ⑤ Cruise control indicator (📖 p. 77)
 - ⑥ Speed (📖 p. 78)
 - ⑦ Coolant temperature indicator (📖 p. 83)
 - ⑧ Favorites on the right
 - ⑨ **ABS** display (📖 p. 79)
 - ⑩ **MTC** display (📖 p. 79)
 - ⑪ **Ride** display (📖 p. 80)
 - ⑫ **Damp** display (📖 p. 80)
 - ⑬ Fuel level display (📖 p. 83)
 - ⑭ Gear display (📖 p. 81)
 - ⑮ Speedometer units
 - ⑯ Seat heater (optional) (📖 p. 82)
-

7 COMBINATION INSTRUMENT

- 17 Heated grip (optional) (📖 p. 81)
- 18 Load display (📖 p. 82)
- 19 Favorites on the left
- 20 Display for connection status (GPS, **Bluetooth®**, headset)

7.9 Track layout (optional)

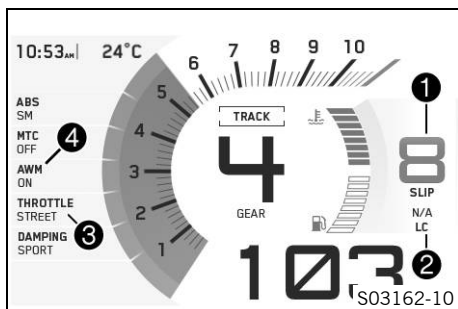

i Info

The figure shows the start screen of the combination instrument with drive mode **TRACK** (optional) activated in the performance layout. All favorites are hidden in the track layout.

KTM MY RIDE is not available in this mode.

If the menu is opened, the speed is still displayed.

- 1 Slip adjustment (optional) (📖 p. 285)
- 2 Launch Control (optional) (📖 p. 162)
- 3 **Throttle Response** (optional) (📖 p. 286)
- 4 Anti wheelie mode (optional) (📖 p. 165)

7.10 Performance layout (optional)

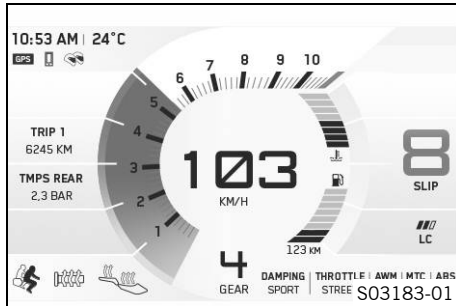

The figure shows the start screen of the combination instrument in active drive mode **TRACK** (optional) in the performance layout. In the performance layout, the standard view of the combination instrument is combined with the functions of the **TRACK** mode (optional). Only the favorites on the left are displayed. If the menu is opened, the speed is still displayed.

7.11 Engine speed

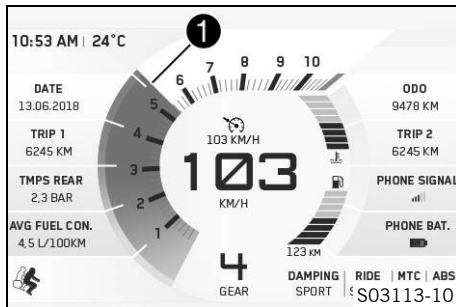

The engine speed is shown in area **1** of the display. The engine speed is measured in revolutions per minute.

7.12 Shift warning light

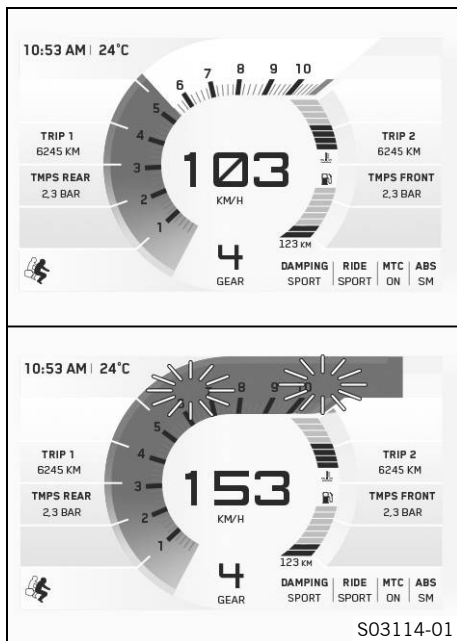

The shift warning light is integrated in the tachometer display. In the **Settings** menu under **Shift Light**, the engine speed for the shift warning light can be set. The shift warning light is always active during the running-in phase (up to 1,000 km / 621 mi). The shift warning light can only be deactivated, and the values for **Shines** and **Flashes** can only be adjusted after this. The shift warning light lights up red at **Shines** and flashes red at **Flashes**.



Info

In sixth-gear, the shift warning light is deactivated when the engine is warm after the first service.

Coolant temperature	$\leq 35\text{ °C}$ ($\leq 95\text{ °F}$)
ODO	< 1,000 km (< 620 mi)
The shift warning light always lights up at	6,500 rpm
Coolant temperature	$> 35\text{ °C}$ ($> 95\text{ °F}$)
ODO	> 1,000 km (> 620 mi)
Shines shift warning light	lights up

Flashes shift warning light	flashes
------------------------------------	---------

7.13 Cruise control indicator

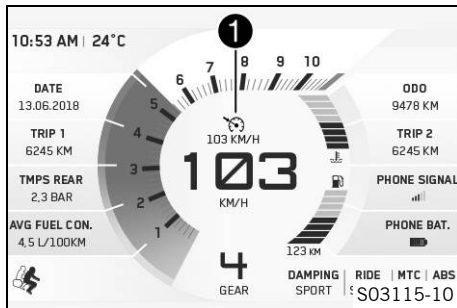

The operating state and active cruise control are shown in the **1** area of the display.

Cruise control is operated using the cruise control tip switch (📖 p. 35).

7 COMBINATION INSTRUMENT

7.14 Speed

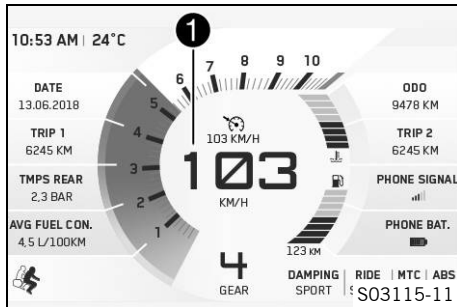

The speed is shown in area **1** of the display.
The unit of speed can be configured in the **Settings** menu under **UNITS**.
Speed is shown in kilometers per hour **km/h** or in miles per hour **mph**.



Info

From 160 km/h (100 mph), the font size of the indicator increases with the speed.
At 200 km/h (124 mph), the maximum font size is reached; afterwards, the contrast of the background is reduced.

7.15 ABS display

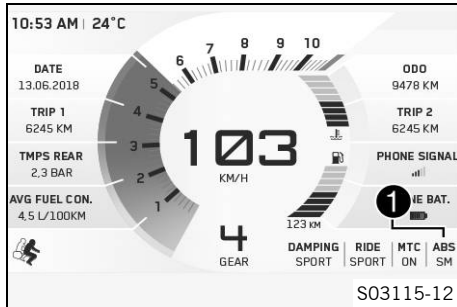

The ABS mode setting is shown in the ① area of the display. In the menu **Motorcycle**, the ABS can be configured under **ABS**.

7.16 MTC display

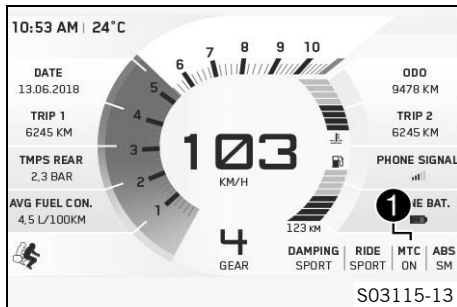

The ① area of the display indicates whether **MTC** the system is switched on or off. The motorcycle traction control can be switched on or off in the **Motorcycle** menu under **MTC**.

7 COMBINATION INSTRUMENT

7.17 Ride display

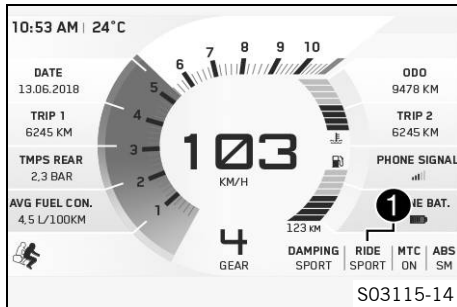

The **Ride Mode** setting is shown in area **1** of the display. The drive mode can be configured in the **Ride Mode** menu.

7.18 Damp display

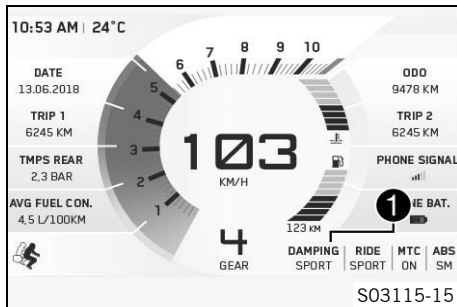

The **Damping** mode setting is shown in the **1** area of the display. The damping can be configured in the **Motorcycle** menu under **Damping**.

7.19 Gear display

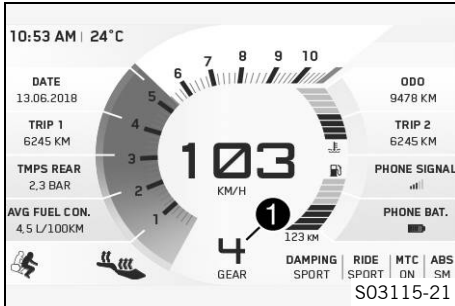

The current gear is shown in area ❶ of the display.

7.20 Heated grip (optional)

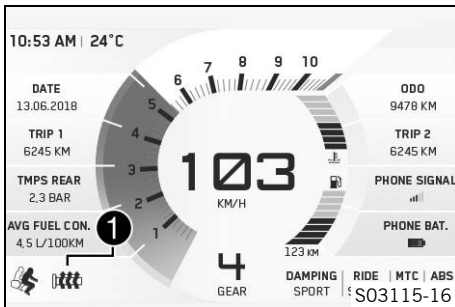

When the heated grip is activated, the **Heated Grips** symbol appears in the ❶ area of the display. The heated grip can be configured in the **Motorcycle** menu under **Heated Grips**.

7 COMBINATION INSTRUMENT

7.21 Seat heater (optional)

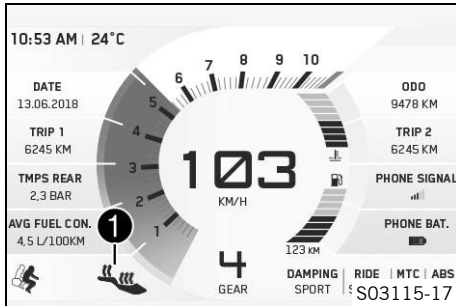

When the seat heating is activated, the **Heated Seat** symbol appears in the **1** area of the display. The seat heating can be configured in the **Motorcycle** menu under **Heated Seat**.



Info

The heating level for the passenger seat heating can be controlled by a switch next to the right grab handle.

7.22 Load display

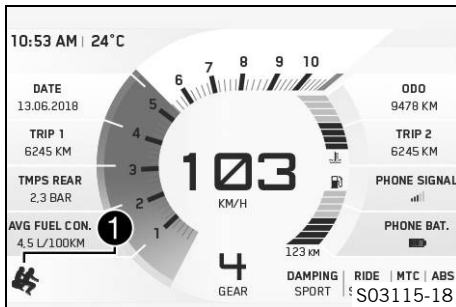

The payload setting is shown in area **1** of the display. The payload can be configured in the **Motorcycle** menu under **Load**. Only configure the payload in an unloaded state.

7.23 Coolant temperature indicator

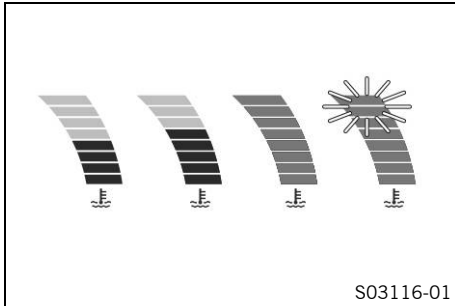

The coolant temperature indicator consists of bars. The more bars that light up, the hotter the coolant.

i Info

When all the bars flash, the warning **ENGINE TEMP HIGH** also appears.

Possible states

- The engine is cold – Up to three bars light up.
- Engine warm – Four bars light up.
- Engine hot – Five to eight bars light up.
- Engine very hot – all eight bars flash red.

7.24 Fuel level display

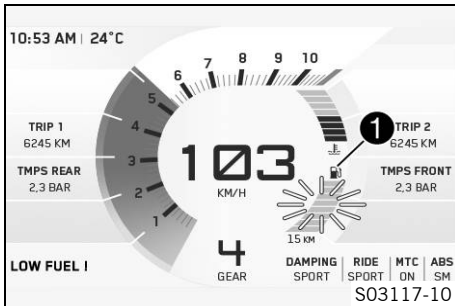

The fuel tank contents are shown in area ❶ of the display. The fuel level indicator consists of bars. The more bars are lit, the more fuel is in the fuel tank.

7 COMBINATION INSTRUMENT



Info

If the fuel level is getting low, all eight segments flash red and the following warning also appears **LOW FUEL**. The fuel level is displayed with a slight delay to prevent the indicator from constantly moving while riding. The fuel level display is not updated while the side stand is folded out or the emergency off switch is switched off. Once the side stand is folded up and the emergency OFF switch is switched on, the fuel level display is next updated after 2 minutes. The fuel level display flashes if the combination instrument does not receive a signal from the fuel level sensor.

7.25 Ambient air temperature indicator

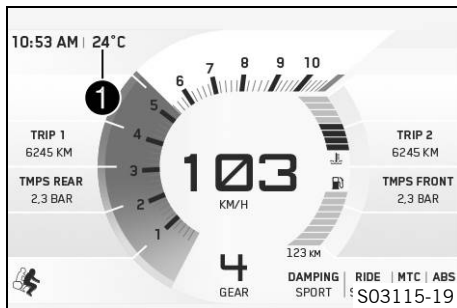

The ambient air temperature is displayed in the **1** area. The units of the ambient temperature can be configured in the **Settings** menu under **Units**. The ambient air temperature is displayed in **°C** or **°F**.

7.26 Time

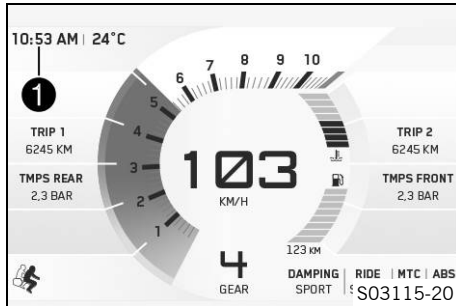

The time is shown in area ❶ of the display.
 The time can be displayed in 24-hour format or 12-hour format in all languages.
 The time can be configured in the **Settings** menu under **Clock/Date**

**Info**

The time must be reset if the 12-V battery was disconnected from the vehicle or the fuse was removed.

7.27 Favourites display

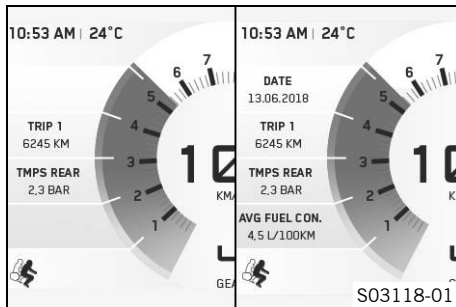

Up to four sets of information are displayed in the **Favourites** display on the left and right.
 The favourites on the left and right can be freely configured in the **Settings** menu under **Favourites**.

**Info**

Each set of information is displayed on two lines.
 Each set of information can be freely stored to a selected slot.

7 COMBINATION INSTRUMENT

7.28 Quick Selector 1 display

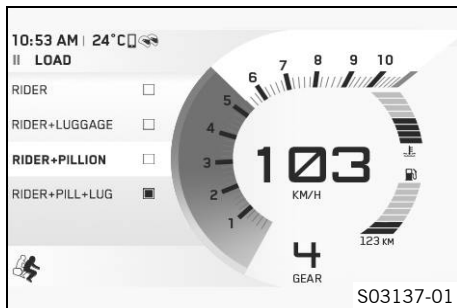

When the menu is closed, **Quick Selector 1** is opened by pressing the **UP** button.

Press the **BACK** button to close **Quick Selector 1**.



Info

The **Quick Selector 1** can be configured in the **Settings** menu. Any information can be selected.

7.29 Quick Selector 2 display

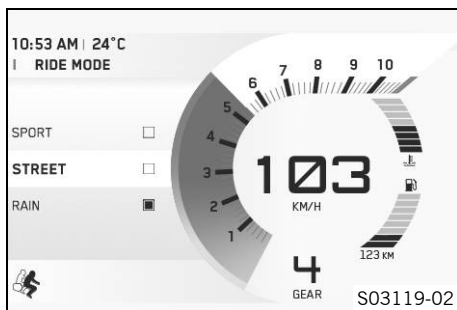

When the menu is closed, **Quick Selector 2** is opened by pressing the **DOWN** button.

Press the **BACK** button to close **Quick Selector 2**.



Info

The **Quick Selector 2** can be configured in the **Settings** menu. Any information can be selected.

7.30 Navigation display (optional)

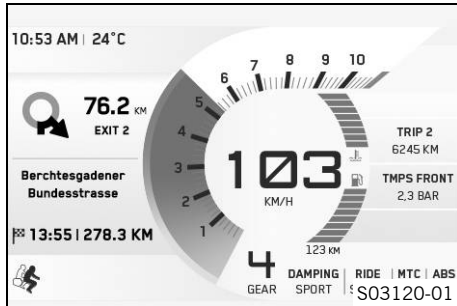

The **Navigation** display appears when the navigation function is active.

The **Navigation** display shows the direction arrow, the distance to the next waypoint, the road name, the arrival time as well as the distance to the destination.

The **Navigation** display can be configured in the **KTM MY RIDE** menu under **Navigation**.

i Info

If the navigation is activated and selected as the **Turn by Turn** setting, the favorites on the left are hidden. The favorites on the right continue to be displayed.

7 COMBINATION INSTRUMENT

7.31 Menu

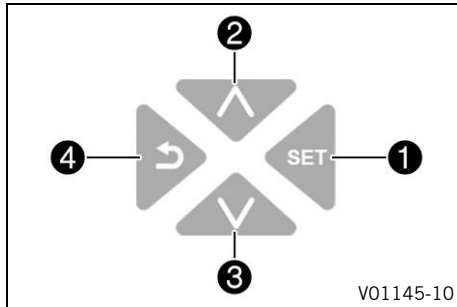

i Info

Press the **SET** button **1** in the start screen to open the menu.

Navigate through the menu using the **UP** button **2** or the **DOWN** button **3**.

Press the **BACK** button **4** to close the current menu or the menu overview.

If no button on the left combination switch is pressed when the menu is open, the menu closes automatically after about 20 seconds. Pressing the **SET** button again opens the last menu opened.

7.31.1 KTM MY RIDE (optional)

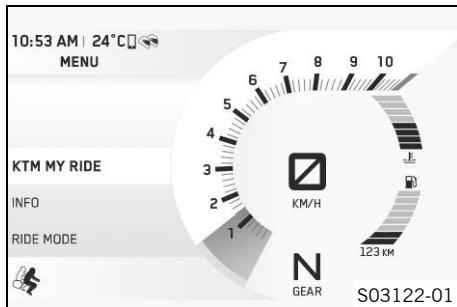

Condition

- The motorcycle is stationary.
- Function **KTM MY RIDE** (optional) activated.
 - Press **SET** button when the menu is closed.
 - Press **UP** or **DOWN** button until **KTM MY RIDE** is marked. Press **SET** button to open the menu.

In **KTM MY RIDE**, an appropriate cellphone or headset can be paired with the combination instrument via **Bluetooth®** and the navigation function can be configured.

**Info**

Not every cellphone and headset is suitable for pairing with the combination instrument.

The standard **Bluetooth®** 2.1 must be supported.

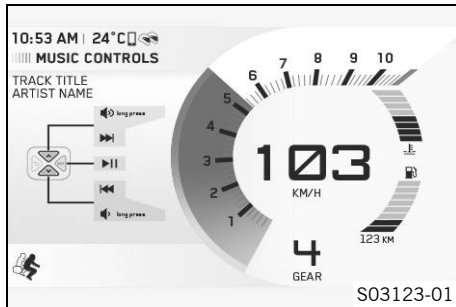
7.31.2 Audio (optional)**Condition**

- Function **KTM MY RIDE** (optional) activated.
- The combination instrument is connected to a suitable cellphone.
- The combination instrument is connected to a suitable headset.
 - Press **SET** button when the menu is closed.
 - Press **UP** or **DOWN** button until **KTM MY RIDE** is marked.
 - Press **SET** button to confirm the selection.

**Warning**

Danger of accidents Headphone volume which is too high distracts attention from traffic activity.

- Always select headphone volume which is low enough for you to still clearly hear acoustic signals.

7 COMBINATION INSTRUMENT

- Press **UP** or **DOWN** button until **Audio** is marked. Press **SET** button to open the menu.
 - Press and hold **UP** button to increase the audio volume.
 - Press and hold **DOWN** button to reduce the audio volume.
 - Press **UP** button briefly to change to the next audio track.
 - Briefly pressing **DOWN** button twice changes to the previous audio title or plays the current audio title, depending on the cellphone model.
 - Press **SET** button to play or pause the audio track.
-



Tip

With some cellphones, the audio player needs to be started before playback is possible.

The **Audio** function can be added to **Quick Selector 1** or **Quick Selector 2** for easier operation.

7.31.3 Navigation (optional)

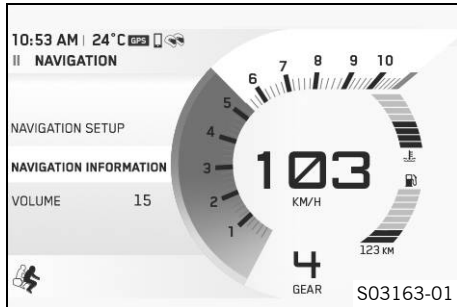

Condition

- Function **KTM MY RIDE** (optional) activated.
- The **KTM MY RIDE** app (optional) is installed and opened on a suitable cellphone (Android devices Version 6.0 and higher, iOS devices Version 10 and higher).
- The combination instrument is connected to a suitable cellphone.
- The GPS function is activated on the connected cellphone.
- For voice navigation: The combination instrument is connected to a suitable headset and an appropriate language package has been downloaded in the **KTM MY RIDE** app.
 - Press **SET** button when the menu is closed.
 - Press **UP** or **DOWN** button until **KTM MY RIDE** is marked. Press **SET** button to open the menu.
 - Press **UP** or **DOWN** button until **Navigation** is marked. Press **SET** button to confirm the selection.

The **Navigation** menu allows various settings to be made and general information on the navigation to be called up.

7 COMBINATION INSTRUMENT



Info

The **Audio** function can be used with the navigation function at the same time.

An incoming call is visualized in a small window at the top of the combination instrument display when the navigation function is active. You cannot navigate in the **Navigation** menu during an active phone conversation.

When the navigation function is switched on and the device is connected, the **GPS** symbol appears in the display of the combination instrument.

7.31.4 Navigation setup (optional)

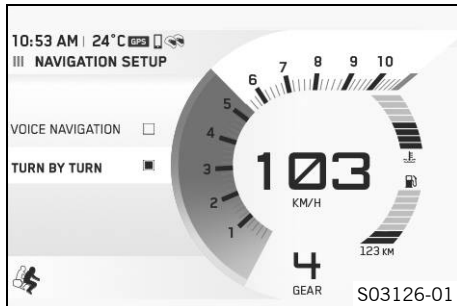

Condition

- Function **KTM MY RIDE** activated (optional).
- The **KTM MY RIDE** app (optional) is installed and opened on a suitable cellphone (Android devices Version 6.0 and higher, iOS devices Version 10 and higher).
- The combination instrument is connected to a suitable cellphone.
- The GPS function is activated on the connected cellphone.
 - Press **SET** button when the menu is closed.
 - Press **UP** or **DOWN** button until **KTM MY RIDE** is marked. Press **SET** button to open the menu.

- Press **UP** or **DOWN** button until **Navigation** is marked. Press **SET** button to confirm the selection.
- Press **UP** or **DOWN** button until **Navigation Setup** is marked. Press **SET** button to open the menu.
- Press **UP** or the **DOWN** button until the desired navigation mode **Voice Navigation** or **Turn by Turn** is marked.
- Press **SET** button to confirm the selection.



Info

The navigation can be changed to voice navigation with **Voice Navigation**.

The navigation can be changed to direction arrows with **Turn by Turn**.

Navigation mode can be set in the **Navigation Setup** submenu.

7.31.5 Navigation information (optional)

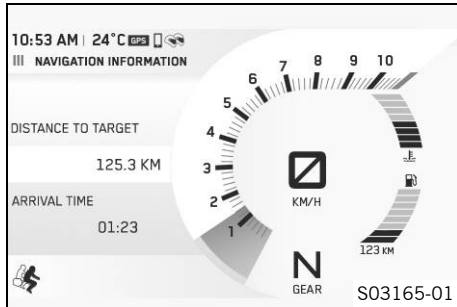

Condition

- Function **KTM MY RIDE** (optional) activated.
- The **KTM MY RIDE** app (optional) is installed and opened on a suitable cellphone (Android devices Version 6.0 and higher, iOS devices Version 10 and higher).
- The combination instrument is connected to a suitable cellphone.
- The GPS function is activated on the connected cellphone.
 - Press **SET** button when the menu is closed.
 - Press **UP** or **DOWN** button until **KTM MY RIDE** is marked. Press **SET** button to open the menu.
 - Press **UP** or **DOWN** button until **Navigation** is marked. Press **SET** button to confirm the selection.
 - Press **UP** or **DOWN** button until **Navigation Information** is marked. Press **SET** button to open the menu.



Info

- **Arrival Time** shows the arrival time of the cellphone.
- **Distance to Target** shows the distance to the destination.

Information on the current navigation can be viewed in the **Navigation Information** submenu.

7.31.6 Volume (optional)

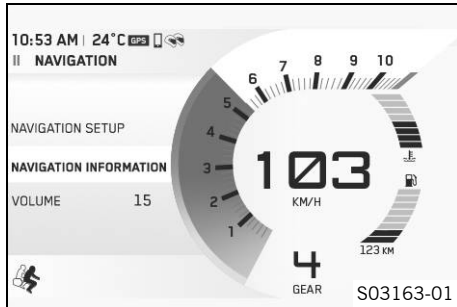

Condition

- Function **KTM MY RIDE** (optional) activated.
- The **KTM MY RIDE** app (optional) is installed and opened on a suitable cellphone (Android devices Version 6.0 and higher, iOS devices Version 10 and higher).
- The combination instrument is connected to a suitable cellphone.
- The GPS function is activated on the connected cellphone.
- For voice navigation: The combination instrument is connected to a suitable headset and an appropriate language package has been downloaded in the **KTM MY RIDE** app.
 - Press **SET** button when the menu is closed.
 - Press **UP** or **DOWN** button until **KTM MY RIDE** is marked. Press **SET** button to open the menu.
 - Press **UP** or **DOWN** button until **Navigation** is marked. Press **SET** button to confirm the selection.



Warning

Danger of accidents Headphone volume which is too high distracts attention from traffic activity.

- Always select headphone volume which is low enough for you to still clearly hear acoustic signals.

7 COMBINATION INSTRUMENT

- Press **UP** or **DOWN** button until **Volume** is marked. Press **SET** button to open the menu.
 - Press and hold **UP** button in order to increase the volume.
 - Press and hold **DOWN** button in order to reduce the volume.
- The volume of the navigation can be set in the **Volume** submenu.

7.31.7 Bluetooth (optional)

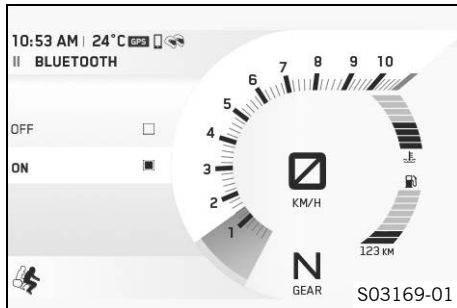

Condition

- The motorcycle is stationary.
- Press **SET** button when the menu is closed.
- Press **UP** or **DOWN** button until **Settings** is marked. Press **SET** button to open the menu.
- Press **UP** or **DOWN** button until **Bluetooth®** is marked. Press **SET** button to open the menu.
- Press **UP** or **DOWN** button until **Bluetooth®OFF** or **ON** is marked. Press **SET** button to confirm the selection.



Info

The **Bluetooth®** function can only be used in conjunction with **KTM MY RIDE** (optional).

When the **Bluetooth®** function is switched on, cellphone and helmet symbols appear in the upper section of the combination instrument. As soon as there is a connection between the cellphone and or a headset, the symbols are displayed filled in.

Not every cellphone and headset is suitable for pairing with the combination instrument.

7.31.8 Pairing (optional)

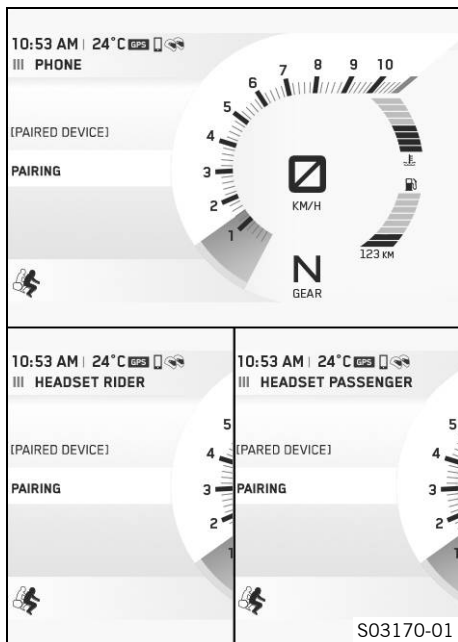

Condition

- The motorcycle is stationary.
- Function **KTM MY RIDE** (optional) activated.
- Function **Bluetooth®** (optional) activated.
- The **Bluetooth®** function should also be activated in the device to be paired.
 - Press **SET** button when the menu is closed.
 - Press **UP** or **DOWN** button until **KTM MY RIDE** is marked.
 - Press **SET** button to confirm the selection.
 - Press **UP** or **DOWN** button until **Pairing** is marked. Press **SET** button to open the menu.
 - Press **UP** or the **DOWN** button until menu item **Phone, Headset Rider** or **Headset Pass.** is marked.

Info

Two cellphones can never be paired simultaneously with the combination instrument. Only one cellphone and one headset per submenu item can be paired with the combination instrument at the same time.

- A suitable cellphone can be paired with the combination instrument in the **Phone** submenu.

- A suitable rider headset can be paired with the combination instrument in the **Headset Rider** submenu.
- A suitable passenger headset can be paired with the combination instrument in the **Headset Pass.** submenu.
- Press **SET** button.
- Press **SET** button again to confirm the **Pairing** submenu item.
- When pairing the combination instrument to a cellphone: A message appears on the combination instrument indicating that this is now ready for pairing. The pairing is completed successfully by confirming the **Passkey** on the cellphone and on the combination instrument.
- When pairing the combination instrument to a headset: The registered trademark of the headset appears on the combination instrument. Press **SET** button to select the device. Press **SET** button again to confirm the **Confirm** submenu item. The pairing of a headset with the combination instrument is now completed at this point.



Info

When a suitable device has been successfully paired, the registered trademark of the paired cellphone or headset appears in each case in the **Phone**, **Headset Rider** or **Headset Pass.** menu.

Press the **UP** or **DOWN** button until the paired device is marked. The paired device can be deleted by pressing the **SET** button.

Not every cellphone or headset is suitable for pairing with the combination instrument.

- If the device is in the range of the combination instrument and has not been deleted previously while the **Bluetooth®** function is active:
 - ✓ The device is automatically paired with the combination instrument.
 - ✗ If the device is not automatically paired with the combination instrument after approx. 30 seconds:
 - Restart combination instrument or **Pairing** repeat procedure.

7.31.9 Telephony (optional)

**Condition**

- Function **KTM MY RIDE** (optional) activated.
- The combination instrument is connected to a suitable cell-phone.
- The combination instrument is connected to a suitable headset.

**Warning**

Danger of accidents Headphone volume which is too high distracts attention from traffic activity.

- Always select headphone volume which is low enough for you to still clearly hear acoustic signals.

- Press **SET** button to accept an incoming call.
- Press and hold down **BACK** button to reject an incoming call.
- Press and hold **UP** button to increase the audio volume.
- Press and hold **DOWN** button to reduce the audio volume.

7 COMBINATION INSTRUMENT



Info

The call duration and contact are displayed. Depending on the cellphone settings, the contact is displayed with a picture and a name.

An incoming call is visualized in a small window at the top of the combination instrument display when the navigation function is active.

7.31.10 Info

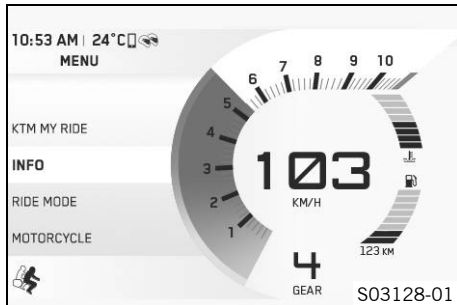

- Press **SET** button when the menu is closed.
- Press **UP** or **DOWN** button until **Info** is marked. Press **SET** button to open the menu.

General information can be accessed in **Info**.

7.31.11 Trip 1

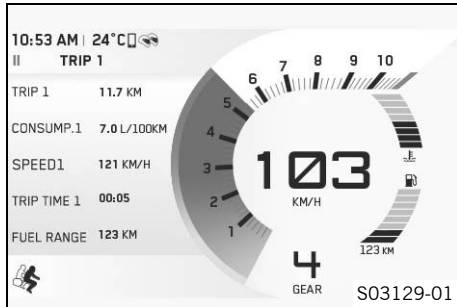

- Press **SET** button when the menu is closed.
- Press **UP** or **DOWN** button until **Info** is marked. Press **SET** button to open the menu.
- Press **UP** or **DOWN** button until **Trip 1** is marked. Press **SET** button to open the menu.

Trip 1 shows the distance since the last reset, such as between two refueling stops. **Trip 1** is running and counts up to **9999**.

ØCons1 indicates the average fuel consumption based on **Trip 1**.

ØSpeed1 indicates the average speed based on **Trip 1** and **Trip Time1**.

Trip Time1 shows the journey time on the basis of **Trip 1** and runs as soon as a speed signal is received.

Fuel Range indicates the possible distance you can cover with the fuel reserve.

Press and hold the SET button for 3-5 seconds.	All entries in the Trip 1 menu are reset.
---	--

7 COMBINATION INSTRUMENT

7.31.12 Trip 2

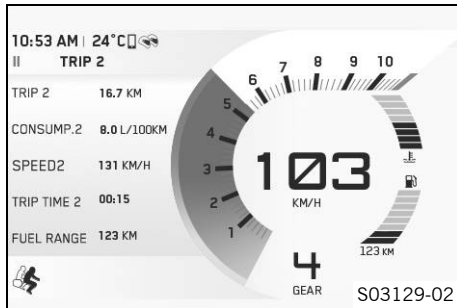

- Press **SET** button when the menu is closed.
- Press **UP** or **DOWN** button until **Info** is marked. Press **SET** button to open the menu.
- Press **UP** or **DOWN** button until **Trip 2** is marked. Press **SET** button to open the menu.

Trip 2 shows the distance since the last reset, such as between two refueling stops. **Trip 2** is running and counts up to **9999**.

ØCons2 indicates the average fuel consumption based on **Trip 2**.

ØSpeed2 indicates the average speed based on **Trip 2** and **Trip Time2**.

Trip Time2 shows the journey time on the basis of **Trip 2** and runs as soon as a speed signal is received.

Fuel Range indicates the possible distance you can cover with the fuel reserve.

Press and hold the **SET** button for 3-5 seconds.

All entries in the **Trip 2** menu are reset.

7.31.13 General Info

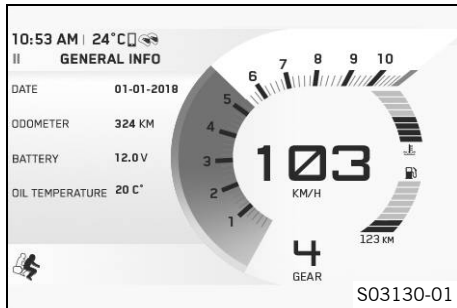

- Press **SET** button when the menu is closed.
- Press **UP** or **DOWN** button until **Info** is marked. Press **SET** button to open the menu.
- Press **UP** or **DOWN** button until **General Info** is marked. Press **SET** button to open the menu.

Date shows the date.

ODO shows the total distance covered.

Battery indicates the battery voltage.

Oil Temperature indicates the engine oil temperature.

7.31.14 TPMS

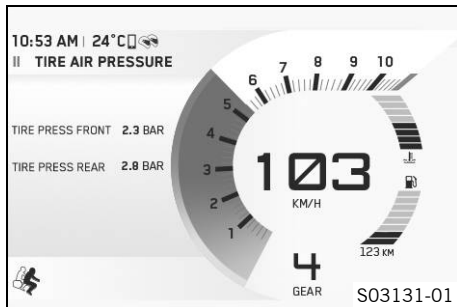
**Condition**

- Model with **TPMS**.
- Press **SET** button when the menu is closed.
- Press **UP** or **DOWN** button until **Info** is marked. Press **SET** button to open the menu.



Warning

Danger of accidents The tire pressure monitoring system does not eliminate the necessity to check the tires before going on a ride.

To avoid false alarms, the tire pressure values are evaluated over a period of several minutes.

- Check the tire pressure before every ride.
- Correct the tire pressure if the tire pressure deviates from the specified value.
- Even if the tire pressure values are correct, stop the vehicle immediately if its behavior indicates a loss of pressure in the tires.

- Press **UP** or **DOWN** button until **Tire Air Pressure** is marked. Press **SET** button to open the menu.

Guideline

Tire pressure, solo / with passenger / full payload	
front: with cold tires	2.5 bar (36 psi)
rear: with cold tires	2.9 bar (42 psi)

The **Tire Air Pressure** menu displays the tire pressure of the front and rear tires.

TIRE PRESS FRONT indicates the tire pressure at the front.

TIRE PRESS REAR indicates the tire pressure at the rear.

7.31.15 Warnings

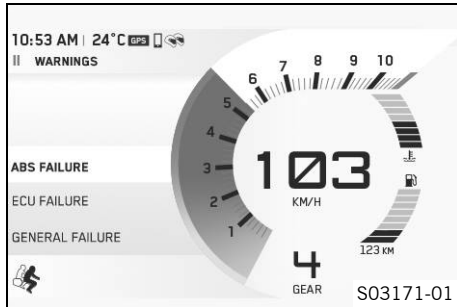
**Condition**

- Message or warning is present.
 - Press **SET** button when the menu is closed.
 - Press **UP** or **DOWN** button until **Info** is marked. Press **SET** button to open the menu.
 - Press **UP** or **DOWN** button until **Warnings** is marked. Press **SET** button to open the menu.
 - Use **UP** or **DOWN** button to navigate through the warnings.

All the warnings that have occurred are displayed and stored in the **Warnings** menu.

7.31.16 Service

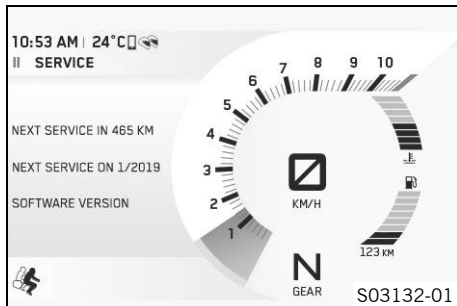
**Condition**

- The motorcycle is stationary.
 - Press **SET** button when the menu is closed.
 - Press **UP** or **DOWN** button until **Info** is marked. Press **SET** button to open the menu.
 - Press **UP** or **DOWN** button until **Service** is marked. Press **SET** button to open the menu.

The next service due is shown in the **Service** menu.

7.31.17 Extra Functions

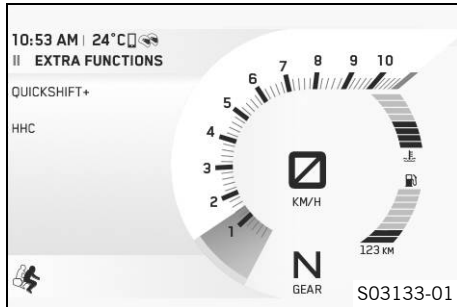

Condition

- The motorcycle is stationary.
- Motorcycle with optional supplementary function.
 - Press **SET** button when the menu is closed.
 - Press **UP** or **DOWN** button until **Info** is marked. Press **SET** button to open the menu.
 - Press **UP** or **DOWN** button until **Extra Functions** is marked. Press **SET** button to open the menu.
 - Use **UP** or **DOWN** button to navigate through the extra functions.

The optional extra functions are listed in **Extra Functions**.

i Info

The current **KTM PowerParts** and the available software for your vehicle can be found on the KTM website.

7.31.18 Motorcycle

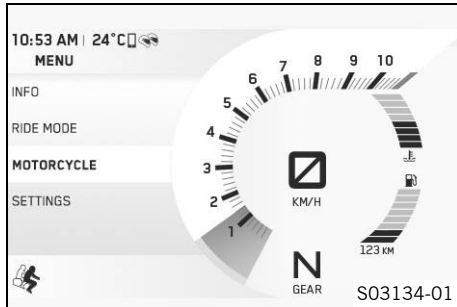
**Condition**

- The motorcycle is stationary.
- Press **SET** button when the menu is closed.
- Press **UP** or **DOWN** button until **Motorcycle** is marked. Press **SET** button to open the menu.

Motorcycle allows settings to be made for ABS, chassis, traction control and extra functions.

7.31.19 Heated Grips (optional)

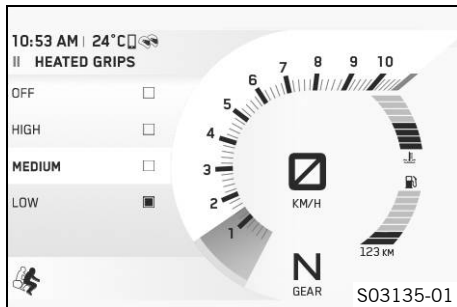
**Condition**

- The motorcycle is stationary.
- Menu **Heated Grips** activated.
- Press **SET** button when the menu is closed.
- Press the **UP** or **DOWN** button until **Motorcycle** is marked. Press the **SET** button to open the menu.
- Press the **UP** or **DOWN** button until **Heated Grips** is marked. Press the **SET** button to open the menu.
- Press **UP** or **DOWN** button to select the heating level or **OFF**.
- Press **SET** button to confirm the selection.

7.31.20 Heated Seat (optional)

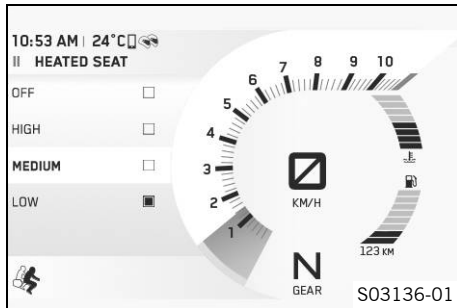

Condition

- The motorcycle is stationary.
- Menu **Heated Seat Rider** activated.
- Menu **Heated Seat Pas** activated.
- Press **SET** button when the menu is closed.
- Press the **UP** or **DOWN** button until **Motorcycle** is marked. Press the **SET** button to open the menu.
- Press the **UP** or **DOWN** button until **Heated Seat** is marked. Press the **SET** button to open the menu.
- Press **UP** or **DOWN** button to select the heating level or **OFF**.
- Press **SET** button to confirm the selection.



Info

The heating level for the passenger seat heating is selected using the switch next to the right grab handle.

7.31.21 Load

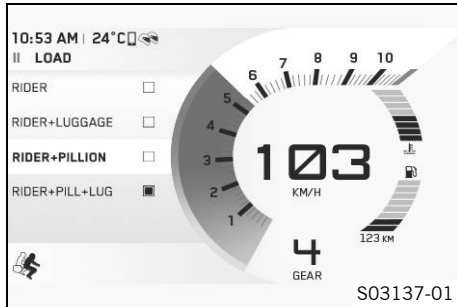
**Condition**

- The motorcycle is stationary and is unloaded.
 - Press **SET** button when the menu is closed.
 - Press the **UP** or **DOWN** button until **Motorcycle** is marked. Press the **SET** button to open the menu.
 - Press the **UP** or **DOWN** button until **Load** is marked. Press the **SET** button to open the menu.
 - Press **UP** or **DOWN** button to select the payload.
 - Press **SET** button to confirm the selection.

In the **Load** menu, you can select from four payloads. The setting of the spring preload and the rebound is adjusted for the payload.

7.31.22 Damping

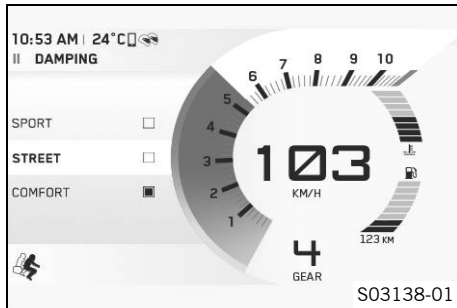

Condition

- The motorcycle is stationary.
 - Press **SET** button when the menu is closed.
 - Press the **UP** or **DOWN** button until **Motorcycle** is marked. Press the **SET** button to open the menu.
 - Press the **UP** or **DOWN** button until **Damping** is marked. Press the **SET** button to open the menu.
 - Press **UP** or **DOWN** button to select the damper setting.
 - Press **SET** button to confirm the selection.

The damping setting of the suspension components is shown in the **Damp** display.

In the **Damping** menu, you can select from the settings **SPORT**, **STREET**, and **COMFORT**.

7.31.23 Ride Mode

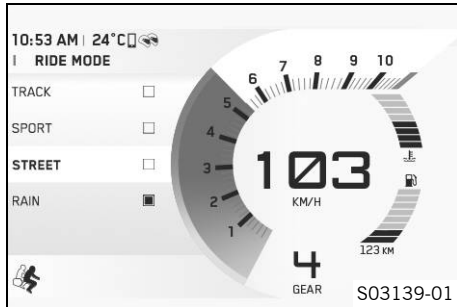
**Condition**

- Emergency OFF switch/electric starter button on (middle position) – This position is required for operation; the ignition circuit is closed. (📖 p. 40)
- Cruise control system function deactivated
 - Press **SET** button when the menu is closed.
 - Press the **UP** or **DOWN** button until **Ride Mode** is marked. Press the **SET** button to open the menu.
 - Press **UP** or **DOWN** button to select the desired **Ride Mode**.
 - Press **SET** button to confirm the selection.
 - Engine and motorcycle traction control settings that are coordinated with each other can be selected in the **Ride Mode** menu.
 - ✓ TRACK - Optional setting available with homologated performance and extremely direct response. The motorcycle traction control and the characteristic map of the throttle response can be individually set.
 - ✓ SPORT – homologated performance with very direct response; the motorcycle traction control allows greater slip on the rear wheel.
 - ✓ STREET – homologated performance with balanced response; the motorcycle traction control allows normal slip on the rear wheel.

7 COMBINATION INSTRUMENT

- ✓ RAIN – reduced homologated performance for better ride-ability; the motorcycle traction control allows normal slip on the rear wheel.



Info

Do not open the throttle during the selection.

7.31.24 MTC

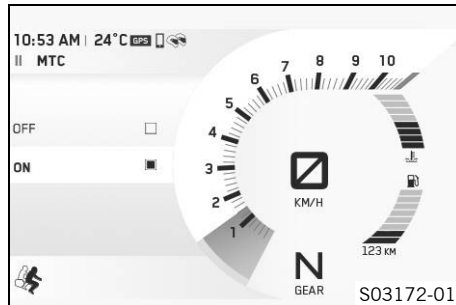

Condition

- The motorcycle is stationary.
- Cruise control system function deactivated
- Press **SET** button when the menu is closed.
- Press the **UP** or **DOWN** button until **Motorcycle** is marked. Press the **SET** button to open the menu.
- Press the **UP** or **DOWN** button until **MTC** is marked. Press the **SET** button to open the menu.
- Press **UP** or **DOWN** button until **MTCOFF** or **ON** is marked.
- Press **SET** button to confirm the selection.

Press and hold the **SET** button for 3-5 seconds.

Activation of the motorcycle traction control.

7.31.25 MTC+MSR (optional)

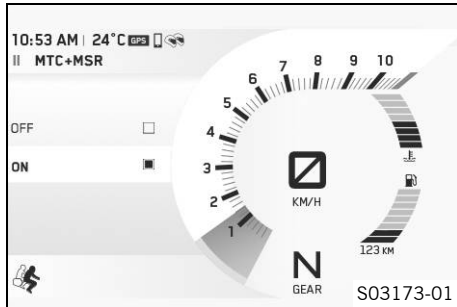
**Condition**

- The motorcycle is stationary.
- Cruise control system function deactivated
 - Press **SET** button when the menu is closed.
 - Press the **UP** or **DOWN** button until **Motorcycle** is marked. Press the **SET** button to open the menu.
 - Press the **UP** or **DOWN** button until **MTC+MSR** is marked. Press the **SET** button to open the menu.
 - Press **UP** or **DOWN** button until **MTC+MSROFF** or **ON** is marked.
 - Press **SET** button to confirm the selection.

**Info**

When the **Track** ride mode is active, the **MSR** is not active.

After the ignition is switched on, the motorcycle traction control and engine traction torque control are enabled again.

Press and hold the **SET** button for 3-5 seconds.

Activation of the motorcycle traction control and the engine traction torque control.

7.31.26 ABS

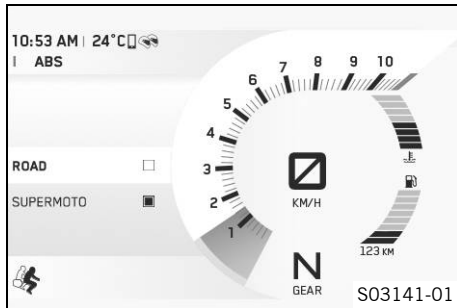

Condition

- The motorcycle is stationary.
 - Press **SET** button when the menu is closed.
 - Press the **UP** or **DOWN** button until **Motorcycle** is marked. Press the **SET** button to open the menu.
 - Press the **UP** or **DOWN** button until **ABS** is marked. Press the **SET** button to open the menu.
 - Press **UP** or **DOWN** button to select the desired **ABS** mode.
 - Press **SET** button to confirm the selection.

Info

When the **Road** ABS mode is active, ABS controls both wheels.
When the **Supermoto** ABS mode is active, ABS only controls the front wheel. The rear wheel is not controlled by ABS and may lock during braking maneuvers.

Press and hold the **SET** button for 3-5 seconds.

Activation of the different ABS modes.

7.31.27 HHC (optional)

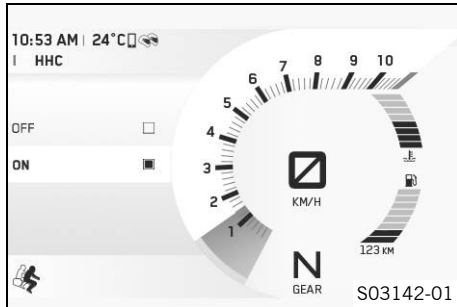
**Condition**

- The motorcycle is stationary.
- Press **SET** button when the menu is closed.
- Press the **UP** or **DOWN** button until **Motorcycle** is marked. Press the **SET** button to open the menu.
- Press the **UP** or **DOWN** button until **HHC** is marked. Press the **SET** button to open the menu.
- Press **UP** or **DOWN** button until **HHC OFF** or **ON** is marked.
- Press **SET** button to confirm the selection.

7.31.28 Settings

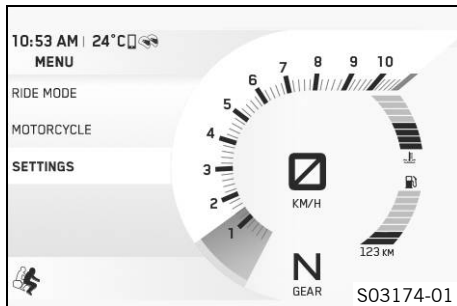
**Condition**

- The motorcycle is stationary.
- Press **SET** button when the menu is closed.
- Press **UP** or **DOWN** button until **Settings** is marked. Press **SET** button to open the menu.

The combination instrument display can be configured in **Settings**. Settings can be made for units or various values. Several functions can be enabled or disabled.

7 COMBINATION INSTRUMENT

7.31.29 Favourites

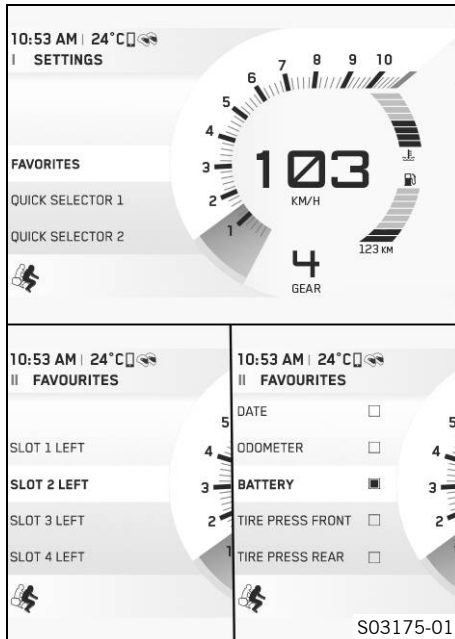

Condition

- The motorcycle is stationary.
 - Press **SET** button when the menu is closed.
 - Press **UP** or **DOWN** button until **Settings** is marked. Press **SET** button to open the menu.
 - Press **UP** or **DOWN** button until **Favourites** is marked. Press **SET** button to open the menu.
 - Press **UP** or **DOWN** button to select the desired slot. Press **SET** button to open the menu.
 - Press **UP** or **DOWN** button to select the desired favorite and confirm it with the **SET** button.

Up to eight items of information can be selected in the **Favourites** menu.

7.31.30 Quick Selector 1

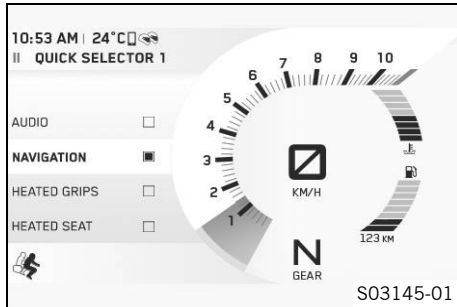
**Condition**

- The motorcycle is stationary.
 - Press **SET** button when the menu is closed.
 - Press **UP** or **DOWN** button until **Settings** is marked. Press **SET** button to open the menu.
 - Press **UP** or **DOWN** button until **Quick Selector 1** is marked. Press **SET** button to open the menu.
 - Press **UP** or **DOWN** button to select the desired menu item and confirm it with the **SET** button.

A menu can be defined for direct selection in the **Quick Selector 1** menu.

When the menu is closed, the menu defined in **Quick Selector 1** is opened by pressing the **UP** button.

7.31.31 Quick Selector 2

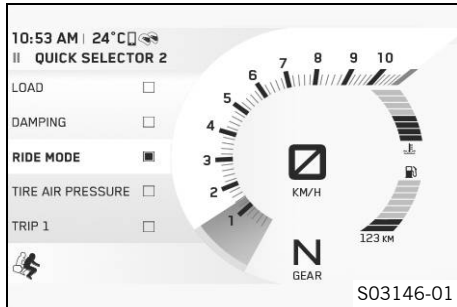

Condition

- The motorcycle is stationary.
 - Press **SET** button when the menu is closed.
 - Press **UP** or **DOWN** button until **Settings** is marked. Press **SET** button to open the menu.
 - Press **UP** or **DOWN** button until **Quick Selector 2** is marked. Press **SET** button to open the menu.
 - Press **UP** or **DOWN** button to select the desired menu item and confirm it with the **SET** button.

A menu can be defined for direct selection in the **Quick Selector 2** menu.

When the menu is closed, the menu defined in **Quick Selector 2** is opened by pressing the **DOWN** button.

7.31.32 Shift Light

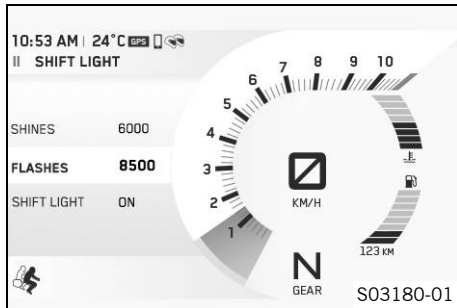
**Condition**

- The motorcycle is stationary.
- **ODO** > 1000 km (621 mi).
 - Press **SET** button when the menu is closed.
 - Press **UP** or **DOWN** button until **Settings** is marked. Press **SET** button to open the menu.
 - Press **UP** or **DOWN** button until **Shift Light** is marked. Press **SET** button to open the menu.
 - Press **UP** or **DOWN** button to select the desired menu subitems.
 - Press **SET** button to open the selected menu subitem.
 - Press **UP** or **DOWN** button to set the value for **Shines** and **Flashes** and press **SET** button to confirm.

**Info**

If the engine speed does not reach **Shines**, the initial value set, the engine speed display lights up red.
 If the engine speed does not reach **Flashes**, the second value set, the engine speed display flashes red.

- Switch shift warning light off or on using the menu subitems **OFF** or **ON**.

7 COMBINATION INSTRUMENT

7.31.33 Units

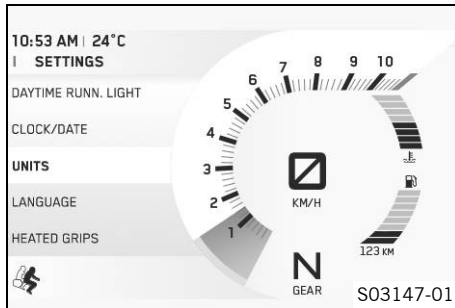

Condition

- The vehicle is stationary.
 - Press **SET** button when the menu is closed.
 - Press **UP** or **DOWN** button until **Settings** is marked. Press **SET** button to open the menu.
 - Press **UP** or **DOWN** button until **Units** is marked.
 - Press **SET** button to open the menu.

Units allows settings to be made for units or various values.

7.31.34 Distance

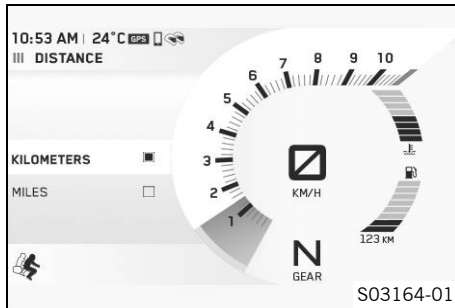

Condition

- The motorcycle is stationary.
 - Press **SET** button when the menu is closed.
 - Press **UP** or **DOWN** button until **Settings** is marked. Press **SET** button to open the menu.
 - Press **UP** or **DOWN** button until **Units** is marked.
 - Press **SET** button to open the menu.
 - Press **UP** or **DOWN** button until **Distance** is marked. Press **SET** button to open the menu.
 - Activate menu item using the **UP** or **DOWN** button.
 - Press **SET** button to confirm the desired unit.

7.31.35 Temperature

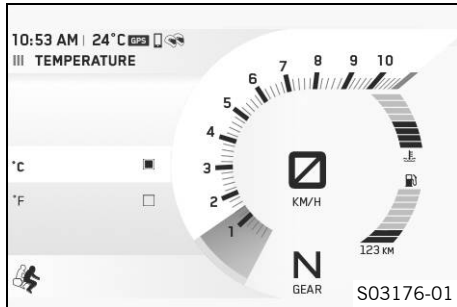
**Condition**

- The motorcycle is stationary.
 - Press **SET** button when the menu is closed.
 - Press **UP** or **DOWN** button until **Settings** is marked. Press **SET** button to open the menu.
 - Press **UP** or **DOWN** button until **Units** is marked.
 - Press **SET** button to open the menu.
 - Press **UP** or **DOWN** button until **Temperature** is marked. Press **SET** button to open the menu.
 - Activate menu item using the **UP** or **DOWN** button.
 - Press **SET** button to confirm the desired unit.

7.31.36 Pressure

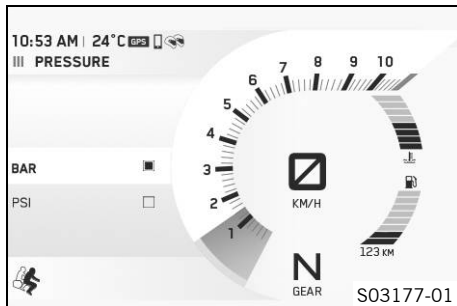
**Condition**

- The motorcycle is stationary.
 - Press **SET** button when the menu is closed.
 - Press **UP** or **DOWN** button until **Settings** is marked. Press **SET** button to open the menu.
 - Press **UP** or **DOWN** button until **Units** is marked.
 - Press **SET** button to open the menu.
 - Press **UP** or **DOWN** button until **Pressure** is marked. Press **SET** button to open the menu.

7 COMBINATION INSTRUMENT

- Activate menu item using the **UP** or **DOWN** button.
- Press **SET** button to confirm the desired unit.

7.31.37 Consumption

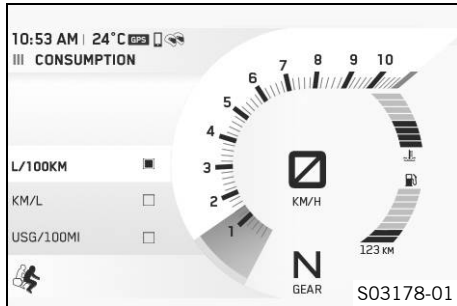

Condition

- The motorcycle is stationary.
- Press **SET** button when the menu is closed.
- Press **UP** or **DOWN** button until **Settings** is marked. Press **SET** button to open the menu.
- Press **UP** or **DOWN** button until **Units** is marked.
- Press **SET** button to open the menu.
- Press **UP** or **DOWN** button until **Consumption** is marked. Press **SET** button to open the menu.
- Activate menu item using the **UP** or **DOWN** button.
- Press **SET** button to confirm the desired unit.

7.31.38 Language

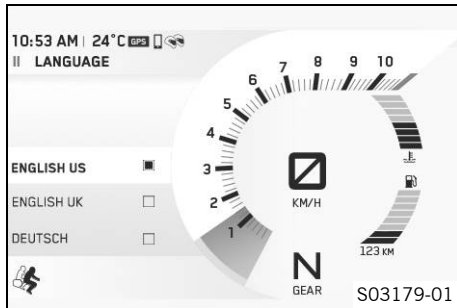

Condition

- The motorcycle is stationary.
 - Press **SET** button when the menu is closed.
 - Press **UP** or **DOWN** button until **Settings** is marked. Press **SET** button to open the menu.
 - Press **UP** or **DOWN** button until **Units** is marked. Press **SET** button to open the menu.
 - Press **UP** or **DOWN** button until **Language** is marked. Press **SET** button to open the menu.
 - Press **UP** or **DOWN** button to activate the menu item and select it with the **SET** button.

The menu languages are US English, UK English, German, Italian, French, and Spanish.

7.31.39 Setting the time and date

Condition

The motorcycle is stationary.

7 COMBINATION INSTRUMENT

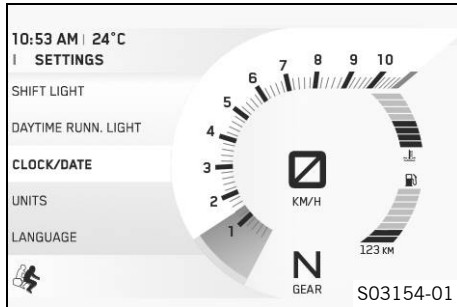

- Press **SET** button when the menu is closed.
- Press **UP** or **DOWN** button until **Settings** appears. Press the **SET** button to open the menu.
- Press the **UP** or **DOWN** button until **Clock/Date** is marked. Press the **SET** button to open the menu.

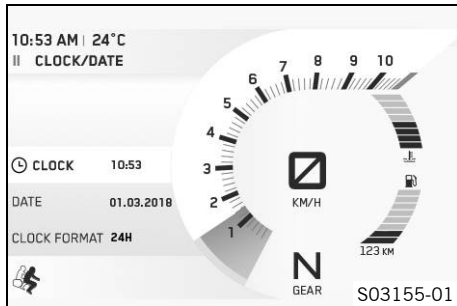

Setting the clock

- Press **UP** or **DOWN** button until the time is marked.
- Press **SET** button.
 - ✓ The hour next to **Clock** flashes.
- Press **UP** or **DOWN** button until the current hour is set.
- Press **SET** button.
 - ✓ The minute next to **Clock** flashes.
- Press **UP** or **DOWN** button until the current minute is set.
- Press **SET** button.
 - ✓ The time is stored.

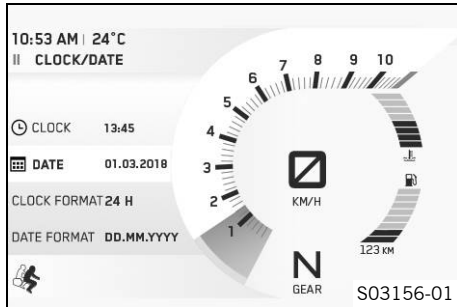

Setting the date

- Press **UP** or **DOWN** button until the date is marked.
- Press **SET** button.
 - ✓ The day next to **Date** flashes.
- Press **UP** or **DOWN** button until the current day is set.
- Press **SET** button.
 - ✓ The month next to **Date** flashes.
- Press **UP** or **DOWN** button until the current month is set.
- Press **SET** button.
 - ✓ The year next to **Date** flashes.
- Press **UP** or **DOWN** button until the current year is set.
- Press **SET** button.
 - ✓ The date is stored.



7.31.40 Daytime Runn. Light

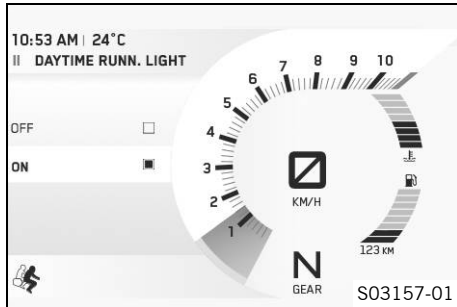

Condition

- The motorcycle is stationary.
- Press **SET** button when the menu is closed.
- Press **UP** or **DOWN** button until **Settings** is marked. Press **SET** button to open the menu.



Warning

Danger of accidents When visibility is poor, the daytime running light is not a substitute for the low beam. Automatic switching between the daytime running light and low beam may only be partially available when visibility is significantly impaired due to fog, snow or rain.

- Ensure that the appropriate type of lighting is always selected.
- If necessary switch off the daytime running lights using the menu before going on a ride or when stopped so that the low beam is switched on permanently.
- Note the legal regulations regarding the daytime running light.

- Press **UP** or **DOWN** button until **Daytime Runn. Light** is marked.
Press **SET** button to open the menu.
- Press **UP** or **DOWN** button until **Daytime Runn. LightOFF** or **ON** is marked.
- Press **SET** button to switch the daytime running light on or off.

7.31.41 Quickshift + (optional)

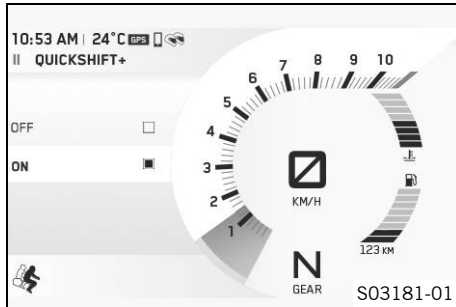

Condition

- The motorcycle is stationary.
- Press **SET** button when the menu is closed.
- Press **UP** or **DOWN** button until **Motorcycle** is marked.
Press **SET** button to open the menu.
- Press **UP** or **DOWN** button until **Quickshift +** is marked.
Press **SET** button to open the menu.
- Press **UP** or **DOWN** button until **Quickshift +OFF** or **ON** is marked.
- Press **SET** button to switch the quickshifter + on or off.

7.31.42 Track (optional)

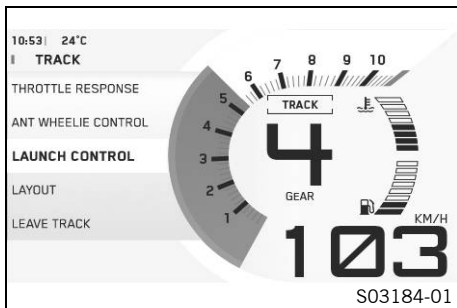

Condition

- The drive mode **TRACK** (optional) is activated.
 - Press **SET** button when the menu is closed.
 - Press **UP** or **DOWN** button until **TRACK** is marked. Press **SET** button to open the menu.

Info

TRACK Allows settings to be made for **TRACK** mode. The drive mode **TRACK** is ended via **Leave Track** and automatically switches to the drive mode **STREET**. Do not open the throttle when doing so.

7.31.43 Layout (optional)

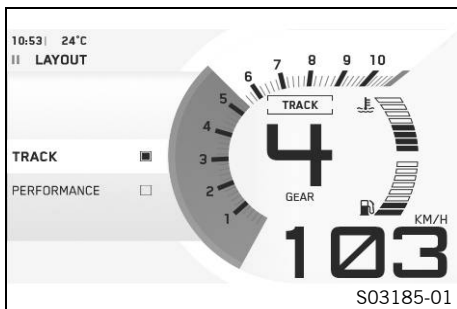

Condition

- The drive mode **TRACK** (optional) is activated.
 - Press **SET** button when the menu is closed.
 - Press **UP** or **DOWN** button until **TRACK** is marked. Press **SET** button to open the menu.
 - Press **UP** or **DOWN** button until **LAYOUT** is marked. Press **SET** button to open the menu.
 - Press **UP** or **DOWN** button until the desired layout is marked.
 - Press **SET** button to confirm the selection.

7.31.44 Launch Control (optional)

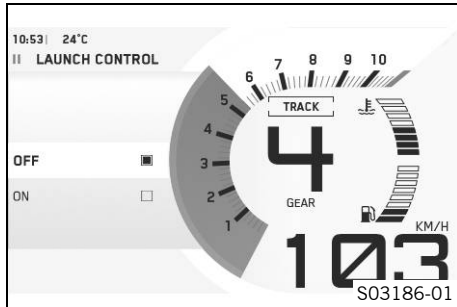
**Condition**

- The drive mode **TRACK** (optional) is activated.
 - Press **SET** button when the menu is closed.
 - Press **UP** or **DOWN** button until **TRACK** is marked. Press **SET** button to open the menu.
 - Press **UP** or **DOWN** button until **Launch Control** is marked. Press **SET** button to open the menu.

**Warning**

Danger of accidents Launch control enables very powerful acceleration which may ask too much of a novice rider.

- Only use the launch control if you have the appropriate experience.
- Do not use launch control on public roads.

- Press **UP** or **DOWN** button until **Launch Control** **OFF** or **ON** is marked.
- Press **SET** button to confirm the selection.

7.31.45 Anti Wheelie Mode (optional)

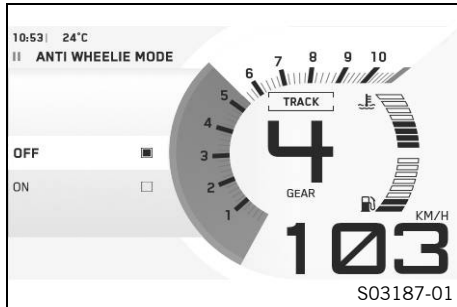

Condition

- The drive mode **TRACK** (optional) is activated.
 - Press **SET** button when the menu is closed.
 - Press **UP** or **DOWN** button until **TRACK** is marked. Press **SET** button to open the menu.
 - Press **UP** or **DOWN** button until **Anti Wheelie Mode** is marked. Press **SET** button to open the menu.



Warning

Danger of accidents When Anti Wheelie Mode is disabled, the motorcycle traction control no longer counteracts the raising of the front wheel.

- Only switch off the Anti Wheelie Mode if you have the appropriate experience.
-
- Press **UP** or **DOWN** button until **Anti Wheelie Mode** **OFF** or **ON** is marked.
 - Press **SET** button to confirm the selection.

7.31.46 Heated Grips (optional)

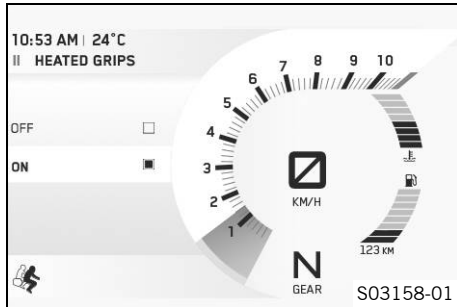
**Condition**

- The motorcycle is stationary.
 - Press **SET** button when the menu is closed.
 - Press **UP** or **DOWN** button until **Settings** is marked. Press **SET** button to open the menu.
 - Press **UP** or **DOWN** button until **Heated Grips** is marked. Press **SET** button to open the menu.
 - Press **UP** or **DOWN** button until **Heated GripsOFF** or **ON** is marked. Press **SET** button to confirm the selection.
 - Press **SET** button to confirm the selection.

**Info**

The heated grip is activated or deactivated in the **Settings** menu. The heated grip is controlled in the **Motorcycle** menu, in submenu **Heated Grips**.

7.31.47 Heated Seat Rider (optional)

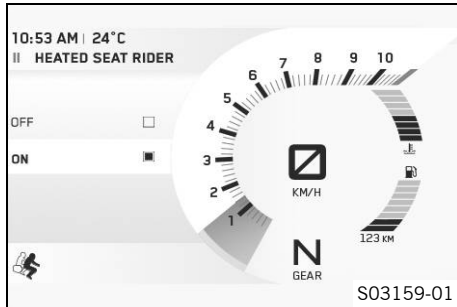

Condition

- The motorcycle is stationary.
 - Press **SET** button when the menu is closed.
 - Press **UP** or **DOWN** button until **Settings** is marked. Press **SET** button to open the menu.
 - Press **UP** or **DOWN** button until **Heated Seat Rider** is marked. Press **SET** button to open the menu.
 - Press **UP** or **DOWN** button until **Heated Set RiderOFF** or **ON** is marked.
 - Press **SET** button to confirm the selection.



Info

The seat heating is activated or deactivated in the **Settings** menu. The seat heating is controlled in the **Motorcycle** menu, in submenu **Heated Seat**.

7.31.48 Heated Seat Pas (optional)

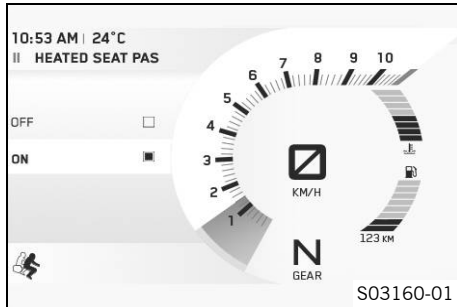
**Condition**

- The motorcycle is stationary.
 - Press **SET** button when the menu is closed.
 - Press **UP** or **DOWN** button until **Settings** is marked. Press **SET** button to open the menu.
 - Press **UP** or **DOWN** button until **Heated Seat Pas** is marked. Press **SET** button to open the menu.
 - Press **UP** or **DOWN** button until **Heated Set PasOFF** or **ON** is marked.
 - Press **SET** button to confirm the selection.

**Info**

The seat heating is activated or deactivated in the **Settings** menu. The seat heating is controlled via a switch next to the right grab handle.

7.31.49 Corner. Light Test

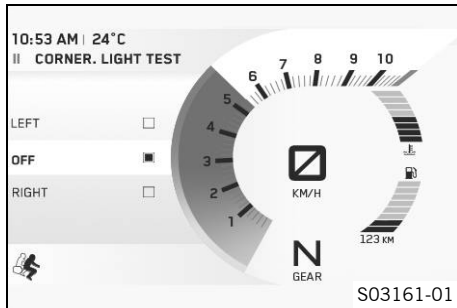

Condition

- The motorcycle is stationary.
 - Press **SET** button when the menu is closed.
 - Press **UP** or **DOWN** button until **Settings** is marked. Press **SET** button to open the menu.
 - Press **UP** or **DOWN** button until **Corner. Light Test** is marked. Press **SET** button to open the menu.
 - Activate menu item using the **UP** or **DOWN** button.

i Info

The test is performed on the left cornering light in the menu item **Left**.
The test is performed on the right cornering light in the menu item **Right**.
The test is ended in the menu item **Off**.

-
- Press **SET** button, in order to perform the required test.

i Info

The respective cornering light segments light up in succession, starting with the lower segment.
When the test of the respective cornering light is complete, the upper segment lights up continuously.

8.1 Handlebar position

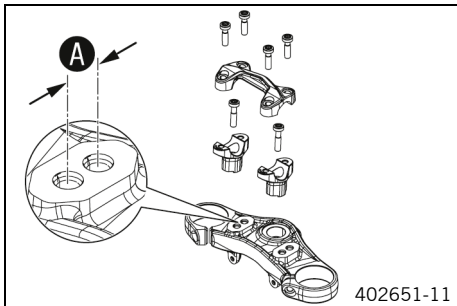

On the upper triple clamp there are two holes at a distance of **A** apart.

Hole distance A	15 mm (0.59 in)
------------------------	-----------------

The handlebar supports can be turned through 180 °. The handlebar can be mounted in four different positions. In this way, the handlebar can be mounted in the most comfortable position for the rider.

8.2 Adjusting the handlebar position 



Warning

Danger of accidents A repaired handlebar poses a safety risk.

If the handlebar is bent or straightened, the material becomes fatigued. The handlebar may break as a result.

- Change the handlebar if the handlebar is damaged or bent.

8 ERGONOMICS

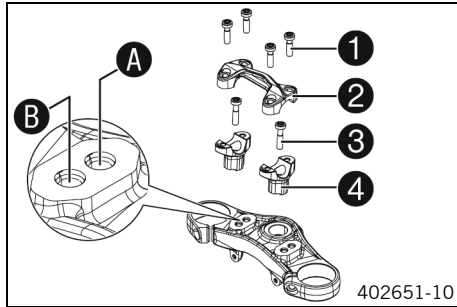

- Remove screws ①. Take off handlebar clamp ②. Take off handlebar and place it to the rear.



Info

Cover the components to protect them against damage. Do not kink the cables and lines.

- Remove screws ③. Take off handlebar supports ④.
- Position handlebar supports in the desired orientation above hole A or B.



Info

The handlebar supports are longer and higher on one side. Position the left and right handlebar supports evenly.

- Mount and tighten screws ③.

Guideline

Screw, handlebar support	M10	40 Nm (29.5 lbf ft) Loctite®243™
--------------------------	-----	--

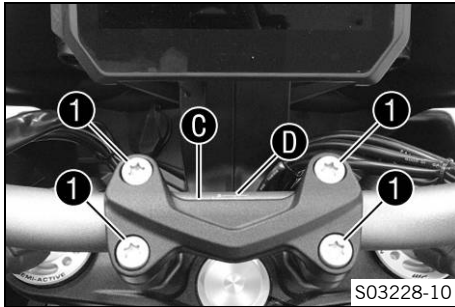

- Position handlebar.



Info

Make sure the cables and wiring are positioned correctly.

- Position handlebar clamp. Mount screws **1**, but do not tighten yet.
 - ✓ Marking **C** on the handlebar scale is aligned with the top edge of the handlebar clamp.
 - ✓ Center line **D** on the handlebar scale is aligned with the center of the handlebar clamp.
- First bolt handlebar clamp with screws **1** onto the longer, higher side of the handlebar supports so that both parts touch.
- Tighten screws **1** evenly.

Guideline

Screw, handlebar clamp	M8	20 Nm (14.8 lbf ft)
------------------------	----	---------------------

8 ERGONOMICS

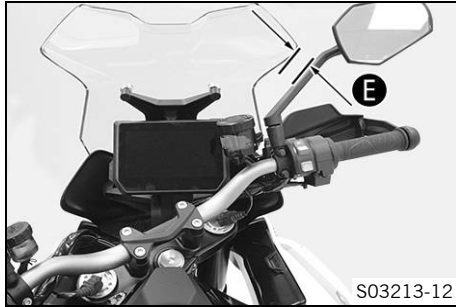

- Place on the vehicle and adjust both rear mirrors in a horizontal position.
- Check minimum spacing **E** between the mirror bar and windshield after the handlebar has been driven in fully.

Guideline

Minimum spacing E between the mirror bar and windshield	9 mm (0.35 in)
--	----------------

- » If the spacing **E** between the mirror bar and windshield is below the minimum:
 - Adjust the steering angle. 🏍️ (📖 p. 141)
- Make sure that there is sufficient space between the controls and fuel tank when the handlebar has been driven in fully after completing the work.

8.3 Adjusting the steering angle ↘

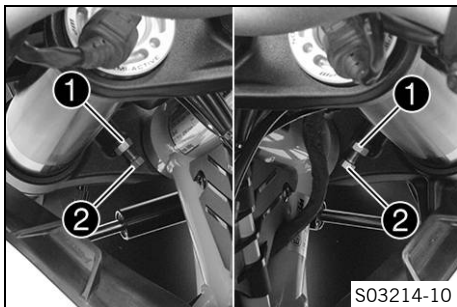

- Loosen nuts ①.
- Make sure that sufficient steering angle remains after finishing the work.

i Info
Do not unscrew screws fully.
The screw must be screwed in by at least five full turns.

- Adjust the steering angle by turning adjusting screws ② left and right.

Guideline

Minimum spacing between the mirror bar and wind-shield	9 mm (0.35 in)
Turn the adjusting screws ② so that the left and right steering angle settings are equal	

- Tighten nuts ①.

Guideline

Remaining nuts, chassis	M8	25 Nm (18.4 lbf ft)
-------------------------	----	---------------------

- Make sure that there is sufficient space between the controls and fuel tank when the handlebar has been driven in fully after completing the work.

8.4 Adjusting the windshield



Info

Do not make any adjustments while riding.

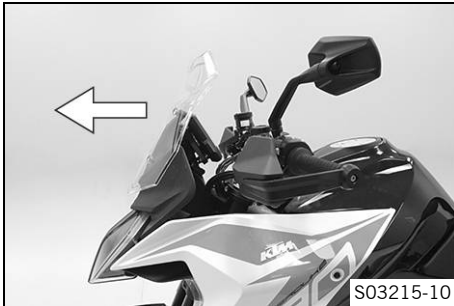

- Push windshield forwards.
 - ✓ The windshield is unlocked.

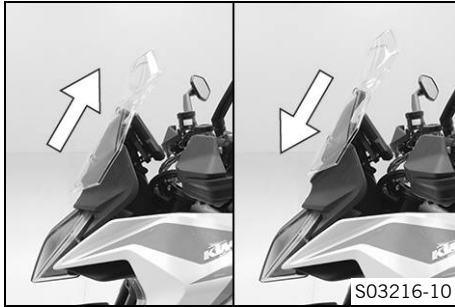

- To move the windshield to the desired position, push the windshield upward or downward.

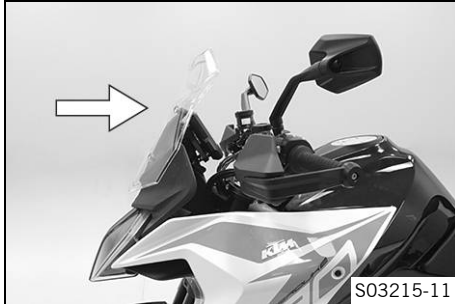

- Pull windshield back.
 - ✓ The windshield is locked.



8.5 Adjusting the tilt of the combination instrument

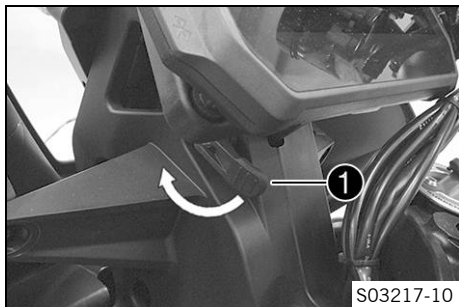

- Pull clamping lever ① on the left underside of the combination instrument in the direction of the arrow.
 - ✓ The combination instrument is unlocked.

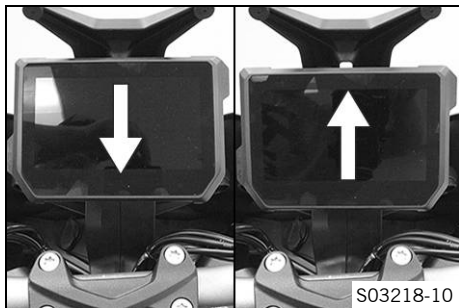

- To move the combination instrument to the desired position, press combination instrument upward or downward.

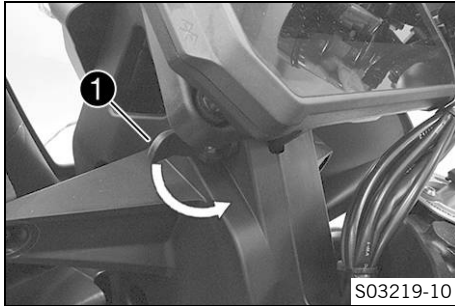

- Pull clamping lever ① in the direction of the arrow.
- ✓ The combination instrument is locked.

8.6 Adjusting the basic position of the clutch lever

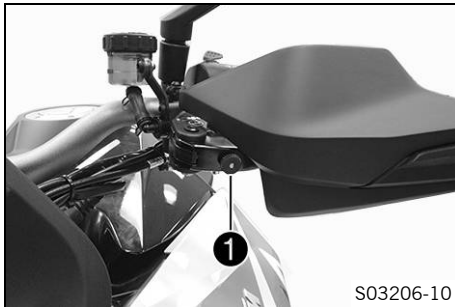

- Push clutch lever forward.
- Adjust basic position of the clutch lever to your hand size by turning adjusting screw ①.



Info

Turn the adjusting screw clockwise to increase the distance between the clutch lever and the handlebar. Turn the adjusting screw counterclockwise to decrease the distance between the clutch lever and the handlebar.

The range of adjustment is limited.

Only turn the adjusting screw by hand, and do not use force.

Do not make any adjustments while riding.

8.7 Adjusting the basic position of the hand brake lever

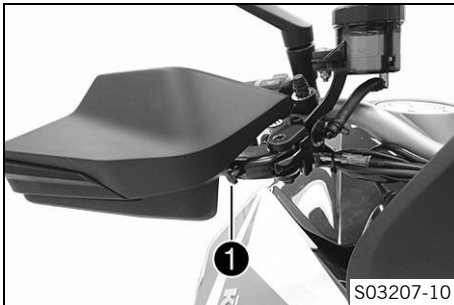

- Push hand brake lever forward.
- Adjust basic position of the hand brake lever to your hand size by turning adjusting screw ①.



Info

Turn the adjusting screw clockwise to increase the distance between the hand brake lever and the handlebar.

Turn the adjusting screw counterclockwise to decrease the distance between the hand brake lever and the handlebar.

The range of adjustment is limited.

Only turn the adjusting screw by hand, and do not use force.

Do not make any adjustments while riding.



8.8 Adjusting the basic position of the foot brake lever ↘

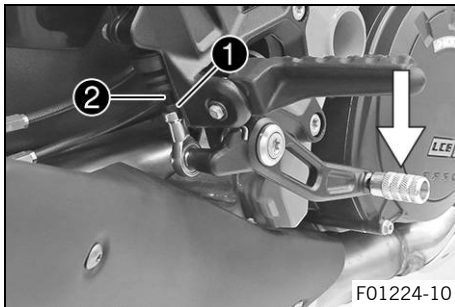

- Loosen nut ①.
- Press the foot brake lever down to be able to turn push rod ② more easily.
- Turn the push rod until the foot brake lever is in the desired position.



Info

The range of adjustment is limited.
The screw must be screwed into the ball joint by at least five turns.

- Lock nut ①.



8.9 Setting the step plate of the foot brake lever

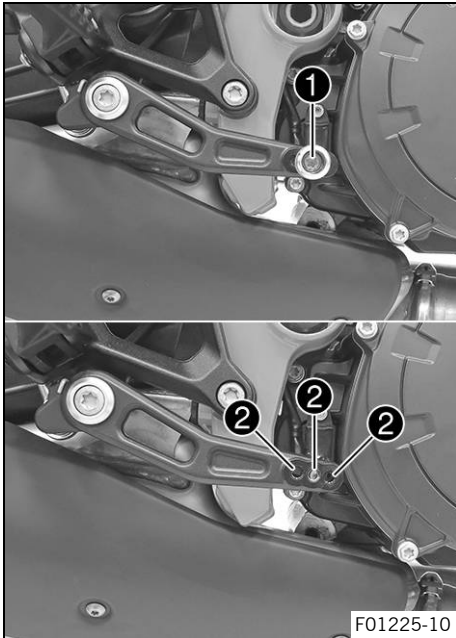

- Remove screw ❶ together with the step plate of the foot brake lever.
- To adjust the length of the foot brake lever, position the step plate of the foot brake lever using screw ❶ in a drill hole ❷.

Guideline

Standard	Middle hole
----------	-------------

- Tighten screw ❶.

Guideline

Screw, step plate for foot brake lever	M6	10 Nm (7.4 lbf ft) Loctite®243™
--	----	---

8.10 Checking the basic position of the shift lever

i Info

When driving, the shift lever must not touch the rider's boot when in the basic position.

If the shift lever is permanently touching the boot, the transmission will be subject to excessive load; this can cause a malfunction of the quickshifter.

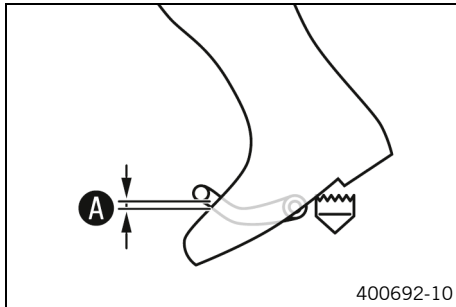

- Sit on the vehicle in the riding position and determine distance **A** between the upper edge of your boot and the shift lever.

Distance between shift lever and upper edge of boot	10 ... 20 mm (0.39 ... 0.79 in)
---	---------------------------------

- » If the distance does not meet specifications:
 - Set the basic position of the shift lever. 📖 (p. 151)

8.11 Adjusting the basic position of the shift lever

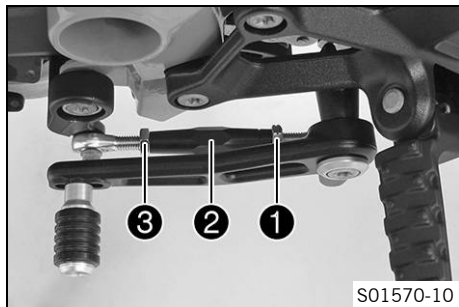

- Loosen nut ①, holding threaded rod ②.

i Info
Nut ① has a left-handed thread.

- Loosen nut ③, holding threaded rod ②.
- Turn threaded rod ② to adjust the shift lever.

i Info
The range of adjustment is limited.
The shift lever must not come into contact with any other vehicle components during the shift procedure.

- Tighten nut ③ while holding threaded rod ②.

Guideline

Nut, shift rod	M8	12 Nm (8.9 lbf ft)
----------------	----	--------------------

- Tighten nut ① while holding threaded rod ②.

Guideline

Nut, shift rod	M8LH	12 Nm (8.9 lbf ft)
----------------	------	--------------------



8.12 Setting the shift lever stub

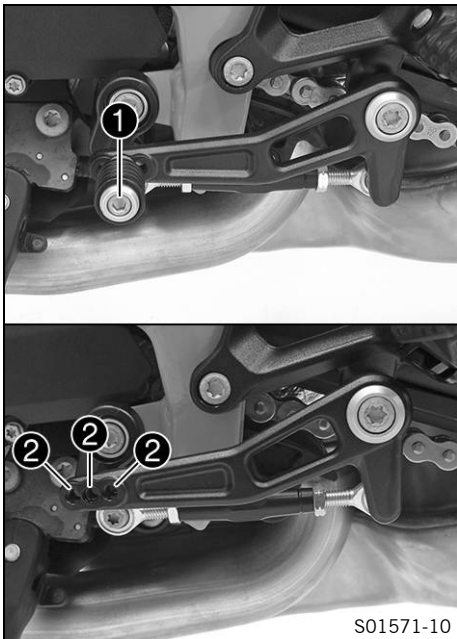

- Remove screw **1** along with the shift lever stub.
- Position the shift lever stub with the screw in one of the drilled holes **2** depending on the desired lever length.

Guideline

Standard	Middle hole
----------	-------------

- Tighten the screw.

Guideline

Screw, shift lever stub	M6	10 Nm (7.4 lbf ft) Loctite®243™
-------------------------	----	---

9.1 Advice on preparing for first use



Danger

Danger of accidents A rider who is not fit to ride poses a danger to him or herself and others.

- Do not operate the vehicle if you are not fit to ride due to alcohol, drugs or medication.
- Do not operate the vehicle if you are physically or mentally impaired.



Warning

Risk of injury Missing or poor protective clothing presents an increased safety risk.

- Wear appropriate protective clothing such as helmet, boots, gloves as well as trousers and a jacket with protectors on all rides.
- Always wear protective clothing that is in good condition and meets the legal regulations.



Warning

Danger of crashing Different tire tread patterns on the front and rear wheel impair the handling characteristic.

Different tire tread patterns can make the vehicle significantly more difficult to control.

- Make sure that only tires with a similar tire tread pattern are fitted to the front and rear wheel.



Warning

Danger of accidents Non-approved or non-recommended tires and wheels impact the handling characteristic.

- Only use tires/wheels approved by KTM with the corresponding speed index.



Warning

Danger of accidents New tires have reduced road grip.

The contact surface on new tires is not yet roughened.

- Run in new tires with moderate riding at alternating angles.
Running-in phase 200 km (124 mi)



Warning

Danger of accidents The brake system fails in the event of overheating.

If the foot brake lever is not released, the brake linings drag continuously.

- Take your foot off the foot brake lever when you are not braking.



Info

When using your vehicle, remember that others may feel disturbed by excessive noise.

- Make sure that the pre-sales inspection work has been carried out by an authorized KTM workshop.
✓ You receive a delivery certificate and the Service & Manufacturer Warranty Booklet at vehicle handover.
- Before riding for the first time, read the entire Owner's Manual carefully.
- Get to know the controls.
- Adjust the motorcycle to your requirements, as described in the "Ergonomics" chapter.
- Get used to the handling characteristic of the motorcycle in a suitable area before making a longer trip. Try also to ride as slowly as possible to get a better feel for the motorcycle.
- Hold handlebar firmly with both hands and keep your feet on the footrests when riding.

- Run engine in.



9.2 Running in the engine

- During the running-in phase, do not exceed the specified engine speed.

Guideline

Maximum engine speed	
During the first: 1,000 km (620 mi)	6,500 rpm
After the first: 1,000 km (620 mi)	10,500 rpm



Tip

During the running-in phase, set the shift warning light to the specified engine speed.

- Avoid fully opening the throttle!



9.3 Loading the vehicle



Warning

Danger of accidents Total weight and axle loads influence the handling characteristic.

The total weight consists of: motorcycle ready for operation and with a full tank, driver and passenger with protective clothing and helmet, and luggage.

- Do not exceed the maximum permissible overall weight or the axle loads.



Warning

Danger of accidents Improper mounting of cases or the tank rucksack impairs the handling characteristic.

- Mount and secure cases and tank rucksack according to the manufacturer's instructions.



Warning

Danger of accidents Unstable handling characteristics at high speed.

- Adapt your speed according to your payload. Ride more slowly if your motorcycle is loaded with cases or other baggage.

Maximum speed with luggage

130 km/h (80.8 mph)



Warning

Danger of accidents Destruction of luggage carrier system.

- If the motorcycle is fitted with luggage cases, note the manufacturer's specifications concerning the maximum payload.



Warning

Danger of accidents Luggage which has slipped impairs visibility.

If the tail light is covered, you are less visible to traffic behind you, especially when it is dark.

- Check that your luggage is fixed properly at regular intervals.



Warning

Danger of accidents A high payload alters the handling characteristic and increases the stopping distance.

- Adapt your speed to your payload.



Warning

Danger of accidents Pieces of luggage which have slipped impair the handling characteristic.

- Check that your luggage is fixed properly at regular intervals.



Warning

Fire hazard The hot exhaust system may burn luggage.

- Fasten your luggage in such a way that it cannot be burned or singed by the hot exhaust system.

- If you carry luggage, make sure you secure it firmly as close as possible to the center of the vehicle and ensure even weight distribution between the front and rear wheels.
- Do not exceed the maximum permissible weight and the maximum permissible axle loads.

Guideline

Maximum permissible overall weight	459 kg (1,012 lb.)
Maximum permissible front axle load	165 kg (364 lb.)
Maximum permissible rear axle load	294 kg (648 lb.)



10.1 Checks and maintenance measures when preparing for use

i Info

Before every trip, check the condition of the vehicle and ensure that it is roadworthy. The vehicle must be in perfect technical condition when it is being operated.

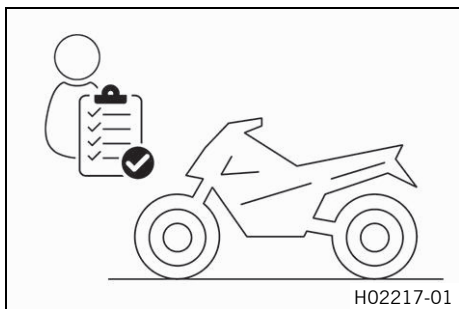

- Check the engine oil level. (📖 p. 287)
- Check front brake fluid level. (📖 p. 224)
- Check rear brake fluid level. (📖 p. 229)
- Check the front brake linings. (📖 p. 228)
- Check the brake linings of the rear brake. (📖 p. 233)
- Check that the brake system is functioning properly.
- Check coolant level in the compensating tank. (📖 p. 279)
- Check the chain for dirt. (📖 p. 200)
- Check the chain tension. (📖 p. 203)
- Check tire condition. (📖 p. 244)
- Check tire pressure. (📖 p. 246)
- Check the settings of all controls and ensure that they can be operated smoothly.
- Check that the electrical system is functioning properly.
- Check that luggage is properly secured.
- Check the setting of the rear mirror.
- Check the fuel level.

10.2 Starting the vehicle



Danger

Danger of poisoning Exhaust gases are toxic and inhaling them may result in unconsciousness and death.

- Always make sure there is sufficient ventilation when running the engine.
- Use effective exhaust extraction when starting or running the engine in an enclosed space.



Caution

Danger of accidents Electronic components and safety devices will be damaged if the 12-V battery is discharged or missing.

- Never operate the vehicle with a discharged 12-V battery or without a 12-V battery.

Note

Engine damage High revving speed with a cold engine negatively impacts the lifespan of the engine.

- Always run the engine warm at a low speed.
-

10 RIDING INSTRUCTIONS

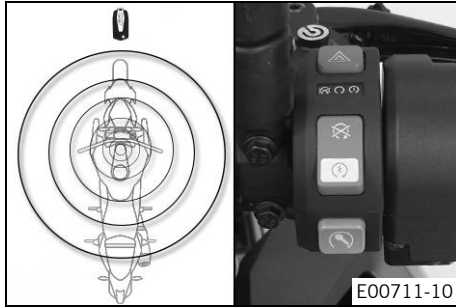

- Take the motorcycle off the side stand and sit on the motorcycle.
- Bring the RACE-ON key within the range of the steering lock.
- Ensure that the RACE-ON key stays in range while riding.

Guideline

Maximum range of the RACE-ON key around the steering lock	1.5 m (4.9 ft)
---	----------------



Info

The range may be reduced by decreases in battery voltage of the RACE-ON key and by interfering radio waves. If the battery voltage of the RACE-ON key is too low, one of the ignition keys must be placed in the area of the steering lock (📖 p. 44) and must be safely stored again after starting.

- Make sure that the emergency OFF switch/electric starter button is in the middle position ○.
- Switch on ignition; to do this, briefly press the RACE-ON button Ⓚ (maximum of 1 second).
 - ✓ The steering is unlocked.
 - ✓ The function check of the combination instrument is run.
 - ✓ The ABS warning lamp goes out when starting off.



Info

If the handlebar does not unlock, move the handlebar slightly.

- Shift the transmission into neutral **N**.
- ✓ The green idle indicator lamp **N** lights up.
- Turn emergency OFF switch/electric starter button to the lower position ③.

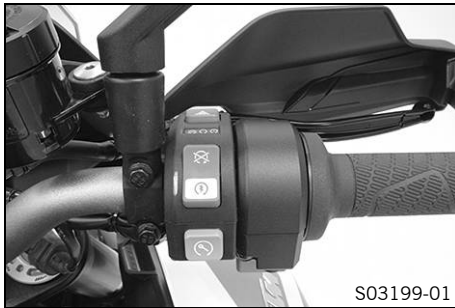

Info

Only press the emergency off switch/electric starter button into the lower position ③ when the combination instrument function check has been completed.

When starting, **DO NOT** open the throttle. If you open the throttle during the starting procedure, fuel is not injected by the engine management system and the engine cannot start.

Press the emergency OFF switch/electric starter button into the lower position ③ for a maximum of 5 seconds. Wait for at least 5 seconds before trying again.

This motorcycle is equipped with a safety starting system. You can only start the engine if the transmission is in neutral or if the clutch lever is pulled when a gear is engaged. If the side stand is folded out and you shift into gear, the engine stops.



10 RIDING INSTRUCTIONS

10.3 Launch Control (optional)

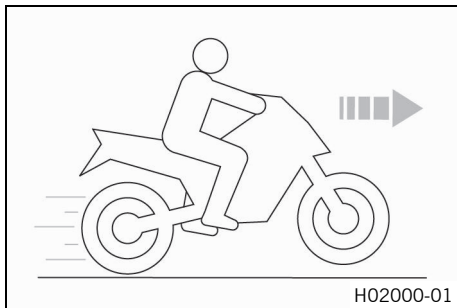

Launch Control is an optional vehicle electronics function.

Launch control adjusts the engine speed in order to achieve the best possible acceleration.

Launch control can be used for starting off for a maximum of three times in succession. Launch control is temporarily deactivated after the third starting off in order to protect the engine, transmission and cooling system from overloading.

Launch control is also deactivated if all conditions for activation are no longer met.

Launch control is enabled again in the following cases: the engine runs for at least three minutes, the engine is switched off for 20 minutes or a distance of 1.5 km (0.93 mi) has been covered.

10.4 Starting off

- Pull the clutch lever, shift into first gear, release the clutch lever slowly and at the same time open the throttle gently.

10.5 Starting off with launch control (optional)



Warning

Danger of accidents Launch control enables very powerful acceleration which may ask too much of a novice rider.

- Only use the launch control if you have the appropriate experience.
- Do not use launch control on public roads.

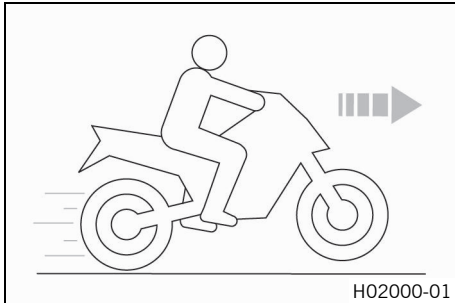

Condition

The drive mode **TRACK** (optional) is activated.

First gear is engaged.

The TC indicator lamp does not light up.

Coolant temperature: > 60 °C (> 140 °F)

Total riding distance covered: > 1,000 km (> 620 mi)

- Activate launch control in the combination instrument.
 - ✓ The number of available starts is indicated on the start screen.
- Apply full throttle with the clutch lever pulled.
 - ✓ The engine speed is adjusted.

6,500 rpm
 - ✓ The TC indicator lamp flashes quickly.
- Release clutch lever quickly but in a controlled manner.



10.6 Start off with HHC (Option: Hill-start assist)

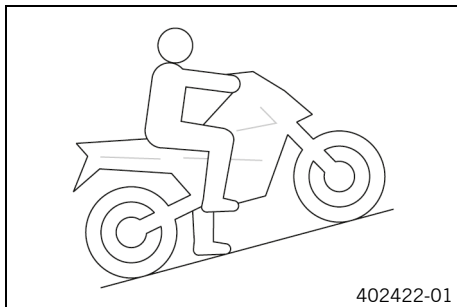

The **HHC** is an optional auxiliary function of the brake system. The **HHC** prevents accidental rolling back of the motorcycle on hills.

The **HHC** recognizes stopping on hills and operates the rear brake. After releasing the brake lever, the brake force is maintained for a maximum of 5 seconds as long as the motorcycle is not moving forward.

When driving off the **HHC** releases the rear brake automatically.

i Info

When the **HHC** is active, the TC indicator lamp  flashes. When the ignition is switched on, the **HHC** can still be active, even if the engine is stopped.

To roll back with active **HHC**, wait 5 seconds, shift to neutral, or switch off the ignition.

If the **HHC** does not detect a start off after 5 seconds, the braking force is automatically reduced gently.

When a brake lever is actuated, the **HHC** is re-activated.

10.7 Anti wheelie mode (optional)

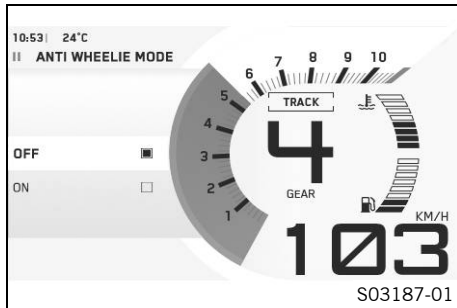

The **Anti Wheelie Mode** is an optional vehicle electronics function. Anti wheelie mode is intended to prevent the front wheel rising when accelerating.

10.8 Quickshifter + (optional)

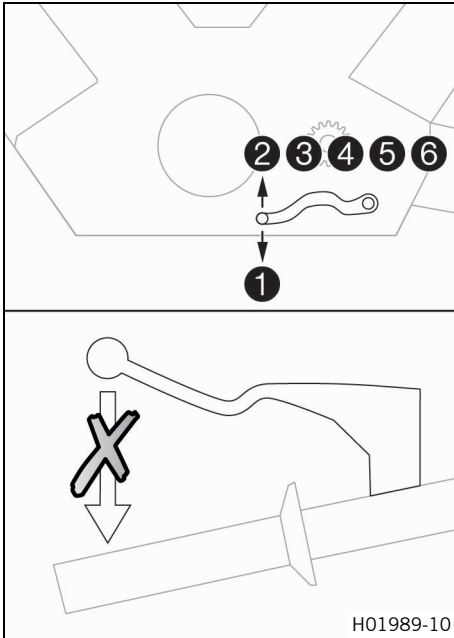

If the quickshifter + (optional) is activated, you can shift up and down without actuating the clutch.

Because there is no need to close the throttle grip, uninterrupted gear shifts are possible.

The quickshifter + uses the shifter shaft position to check whether or not a shift should be initiated, and sends a corresponding signal to the engine control.

If the quickshifter + is disabled in the combination instrument, the clutch needs to be actuated in the normal way for each shift.

10.9 Shifting, riding.



Warning

Danger of accidents Abrupt load alterations can cause the vehicle to get out of control.

- Avoid abrupt load alterations and sudden braking actions.
- Adapt your speed to the road conditions.



Warning

Danger of accidents If you change down at high engine speed, the rear wheel blocks and the engine races.

- Do not change into a low gear at high engine speed.



Warning

Danger of accidents Adjustments to the vehicle distract attention from traffic activity.

- Make all adjustments when the vehicle is at a standstill.



Warning

Risk of injury The passenger may fall from the motorcycle if they conduct themselves incorrectly.

- Ensure that the passenger sits correctly on the passenger seat, places his or her feet on the passenger foot pegs and holds on to the rider or the grab handles.
- Note the regulations governing the minimum age of passengers in your country.



Warning

Danger of accidents A risky riding style constitutes a major risk.

- Comply with traffic regulations and ride defensively and with foresight to detect sources of danger as early as possible.



Warning

Danger of accidents Cold tires have reduced road grip.

- Ride the first miles carefully on every journey at moderate speed until the tires reach operating temperature.



Warning

Danger of accidents New tires have reduced road grip.

The contact surface on new tires is not yet roughened.

- Run in new tires with moderate riding at alternating angles.
Running-in phase 200 km (124 mi)



Warning

Danger of accidents Total weight and axle loads influence the handling characteristic.

The total weight consists of: motorcycle ready for operation and with a full tank, driver and passenger with protective clothing and helmet, and luggage.

- Do not exceed the maximum permissible overall weight or the axle loads.

**Warning**

Danger of accidents Pieces of luggage which have slipped impair the handling characteristic.

- Check that your luggage is fixed properly at regular intervals.

**Warning**

Danger of accidents A fall can damage the vehicle more seriously than it may first appear.

- Check the vehicle after a fall as you do when preparing for use.

Note

Engine damage Unfiltered intake air has a negative effect on the service life of the engine.

Dust and dirt will enter the engine without an air filter.

- Never start to use the vehicle without an air filter.

Note

Engine failure Overheating damages the engine.

- If the coolant temperature warning is displayed, stop immediately and take care not to endanger yourself or other traffic participants in the process.
- Allow the engine and cooling system to cool down.
- Check and, if necessary, correct the coolant level on the cooling system while it is in a cooled state.

Note

Transmission damage Incorrect use of the quickshifter+ will damage the transmission.

The quickshifter+ can only be used if the function is enabled in the combination instrument.

The quickshifter+ is not active if you pull the clutch lever.

- Only use the quickshifter+ in the permitted speed range shown.

i Info

If you hear unusual noises while riding, stop immediately, switch off the engine, and contact an authorized KTM workshop.

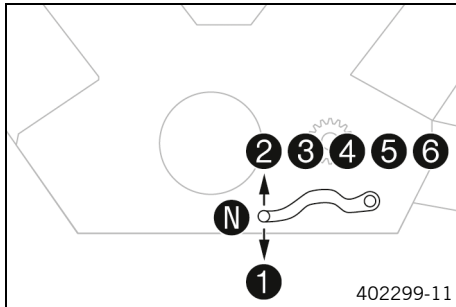



- Shift into a higher gear when conditions allow (incline, road situation, etc.).
- Release throttle while simultaneously pulling the clutch lever, shift into the next gear, release the clutch lever, and open the throttle.

i Info

The gear positions can be seen in the figure. The idle position is between the first and second gears. First gear is used for starting off or for steep inclines.

- After reaching maximum speed by fully opening the throttle grip, turn the throttle back so it is $\frac{3}{4}$ open. This will barely reduce the speed, but fuel consumption will be considerably lower.

- Accelerate only up to a speed suitable for the road surface and weather conditions. Particularly in bends, do not shift, and accelerate very carefully.
- Brake if necessary and close the throttle at the same time in order to shift down.
- Pull clutch lever and shift into a lower gear, release the clutch lever slowly, and open the throttle or shift again.
- If the engine stalls (e.g. at a crossroads), just pull clutch lever and press emergency OFF switch/electric starter button into the lower position (Ⓢ). The transmission must not be shifted into neutral.
- Switch off the engine if you are likely to be running at idle speed or stationary for a long time.
- If the oil pressure warning lamp  lights up during a trip, stop as soon as it is safe to do so and switch off the engine. Contact an authorized KTM workshop.
- If the malfunction indicator lamp  lights up during a trip, please contact an authorized KTM workshop as soon as possible.
- If the general warning lamp  lights up during a trip, the display shows a message for 10 seconds.

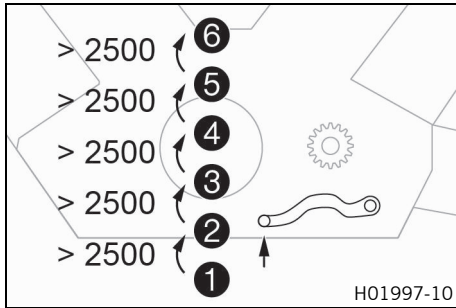

i Info

Very important messages are stored in the **Warning** menu.

- If the ice warning appears in the combination instrument, the roads may be icy. Adjust your speed to the road conditions.

Condition

The quickshifter + (optional) is enabled.

- If the quickshifter + is enabled in the combination instrument, one can shift up in the engine speed range shown without pulling the clutch lever.

i Info

The minimum engine speed before shifting up in revolutions per minute is shown in the figure. Pull the shift lever to the stop quickly without changing the throttle twist grip position.

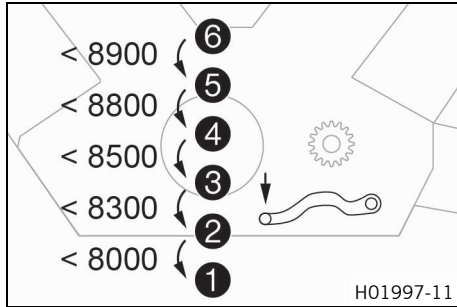

- If the quickshifter + is enabled in the combination instrument, one can shift down in the engine speed range shown without pulling the clutch lever.

i Info

The maximum engine speed before shifting down in revolutions per minute is shown in the figure. Depress the shift lever to the stop quickly without changing the throttle twist grip position.



10.10 MSR (optional)

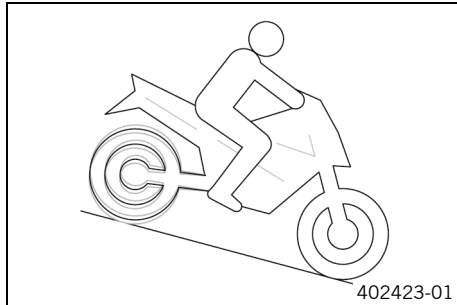

The **MSR** is an optional auxiliary function of the engine control. If the engine braking effect is too great, the **MSR** prevents the rear wheel from locking or sliding away on a sloping position. To avoid slip of the rear wheel, the **MSR** only opens the throttle valve as far as absolutely necessary. The **MSR** is applied on surfaces, where the friction is too low to open the slipper clutch. To further increase ride safety, the **MSR** is slope dependent.

i Info

When the MTC is switched off or ABS mode **Supermoto** is active, the **MSR** is not active.

10.11 Applying the brakes



Warning

Danger of accidents Moisture and dirt impair the brake system.

- Brake carefully several times to dry out and remove dirt from the brake linings and the brake discs.



Warning

Danger of accidents A spongy pressure point on the front or rear brake reduces braking efficiency.

- Check the brake system and do not continue riding until the problem is eliminated. (Your authorized KTM workshop will be glad to help.)



Warning

Danger of accidents The brake system fails in the event of overheating.

If the foot brake lever is not released, the brake linings drag continuously.

- Take your foot off the foot brake lever when you are not braking.



Warning

Danger of accidents Higher total weight increases the stopping distance.

- Take the longer stopping distance into account when carrying a passenger or luggage with you.



Warning

Danger of accidents Salt on the roads impairs the brake system.

- Brake carefully several times to remove salt from the brake linings and the brake discs.

**Warning**

Danger of accidents ABS may increase the stopping distance in certain situations.

- Adjust application of the brakes to the respective riding situation and riding surface conditions.

**Warning**

Danger of accidents Excessively forceful application of the brakes blocks the wheels.

The ABS effectiveness is only ensured if it is switched on.

- Leave the ABS switched on in order to benefit from the protective effect.

**Warning**

Danger of accidents Driving aids can only prevent a rollover within the physical limitations.

It is not always possible to compensate for extreme riding situations, for example with luggage loaded with a high center of gravity, varying road surfaces, steep descents or full braking without disengaging the gear.

- Adapt your riding style to the road conditions and your driving ability.

-
- When braking, release the throttle and apply the front and rear brakes at the same time.

**Info**

When the ABS is enabled, you can achieve maximum braking power even on low grip surfaces such as sandy, wet, or slippery terrain without locking of the wheels.



Warning

Danger of accidents The rear wheel can lock due to the engine braking effect.

- Pull in the clutch, if you perform emergency or full braking, or if you brake on a slippery ground.



Warning

Danger of accidents Banked or laterally sloping ground reduces the maximum possible delay.

- If possible finish braking before going into a bend.

- Always finish braking before you go into a bend. Change down to a lower gear appropriate to your road speed.
- Use the braking effect of the engine on long downhill stretches. Change down one or two gears, but do not over-rev the engine. In this way, you have to brake far less and the brakes do not overheat.

10.12 Stopping, parking



Warning

Risk of injury People who act without authorization endanger themselves and others.

If a valid transponder is in range, the vehicle can be started.

- Do not leave the vehicle unattended if the engine is running.
- Never leave the vehicle unattended if the RACE-ON key or the black ignition key are close to the vehicle.
- Protect the vehicle against access by unauthorized persons.
- Lock the steering if you leave the vehicle unattended.

**Warning**

Danger of burns Some vehicle components become very hot when the vehicle is operated.

- Do not touch any parts such as the exhaust system, radiator, engine, shock absorber, or brake system before the vehicle parts have cooled down.
- Let the vehicle parts cool down before you perform any work on the vehicle.

Note

Material damage The vehicle may be damaged by incorrect procedure when parking.

Significant damage may be caused if the vehicle rolls away or falls over.

The components for parking the vehicle are designed only for the weight of the vehicle.

- Park the vehicle on a firm and level surface.
- Ensure that nobody sits on the vehicle when the vehicle is parked on a stand.

Note

Fire hazard Hot vehicle components pose a fire hazard and explosion risk.

- Do not park the vehicle near to materials which are highly flammable or explosive.
- Allow the vehicle to cool down before covering it.

-
- Apply the brakes on the motorcycle.
 - Shift the transmission into neutral **N**.
 - Switch off ignition – to do this, briefly press the RACE-ON button  (maximum of 1 second) with the ignition switched on.



Info

If the engine is switched off with the emergency OFF switch and the ignition remains switched on using the RACE-ON button, the power supply to most power consumers remains unbroken. This discharges the 12-V battery. You should therefore always switch off the engine with the RACE-ON button – the emergency OFF switch is intended for emergencies only.

- Park the motorcycle on a firm surface.
- Swing side stand forward with your foot as far as it will go and lean the vehicle on it.
- Move handlebar fully to the left and press and hold the RACE-ON button  (for at least 2 seconds).
- ✓ The steering is locked.



Info

If the steering lock does not engage, move the handlebar slightly.

10.13 Transporting

Note

Danger of damage The parked vehicle can roll away or fall over.

- Park the vehicle on a firm and level surface.

Note

Fire hazard Hot vehicle components pose a fire hazard and explosion risk.

- Do not park the vehicle near to materials which are highly flammable or explosive.
 - Allow the vehicle to cool down before covering it.
-

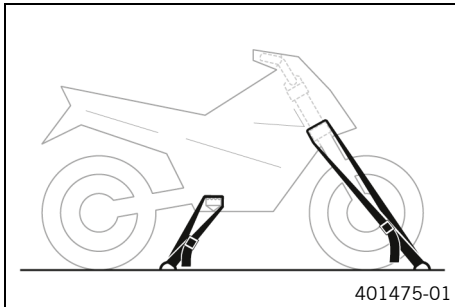

- Switch off the engine.
- Use tension belts or other suitable devices to secure the motorcycle against falling over or rolling away.

10.14 Refueling



Danger

Fire hazard Fuel is highly flammable.

The fuel in the fuel tank expands when warm and can escape if overfilled.

- Do not refuel the vehicle in the vicinity of open flames or lit cigarettes.
- Switch off the engine for refueling.
- Make sure that no fuel is spilled; particularly not on hot parts of the vehicle.
- If any fuel is spilled, wipe it off immediately.
- Observe the specifications for refueling.



Warning

Danger of poisoning Fuel is poisonous and a health hazard.

- Avoid skin, eye and clothing contact with fuel.
- Immediately consult a doctor if you swallow fuel.
- Do not inhale fuel vapors.
- In case of skin contact, rinse the affected area with plenty of water.
- Rinse the eyes thoroughly with water, and consult a doctor in case of fuel contact with the eyes.
- Change your clothing in case of fuel spills on them.

Note

Material damage Inadequate fuel quality causes the fuel filter to quickly become clogged.

In some countries and regions, the available fuel quality and cleanliness may not be sufficient. This will result in problems with the fuel system.

- Refuel only with clean fuel that meets the specified standards. (Your authorized KTM workshop will be glad to help.)



Note

Environmental hazard Improper handling of fuel is a danger to the environment.

- Do not allow fuel to enter the groundwater, the soil, or the sewage system.
-

10 RIDING INSTRUCTIONS

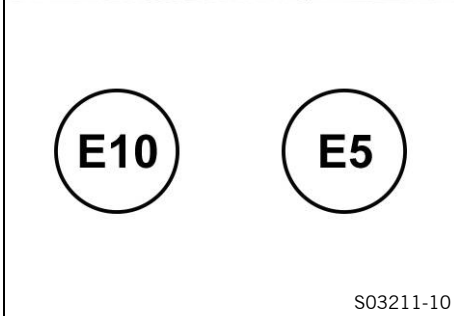
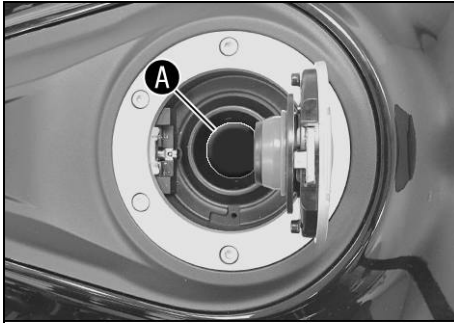

S03211-10

- Switch off the engine.
- Open fuel tank filler cap. (📖 p. 52)
- Fill the fuel tank with fuel up to the lower edge **A** of the filler neck.

Total fuel tank capacity, approx.	23 l (6.1 US gal)	Super unleaded (ROZ 95/RON 95/PON 91) (📖 p. 335)
-----------------------------------	----------------------	---

- Close fuel tank filler cap. (📖 p. 54)

11.1 Additional information

Any further work that results from the compulsory work or from the recommended work must be ordered separately and invoiced separately.

Different service intervals may apply in your country, depending on the local operating conditions.

Individual service intervals and scopes may change in the course of technical developments. The most up-to-date service schedule can always be found on KTM Dealer.net. Your authorized KTM dealer will be happy to advise you.

11.2 Required work

	every 24 months				
	every 12 months				
	every 30,000 km (18,600 mi)				
	every 15,000 km (9,300 mi)				
	after 1,000 km (620 mi)				
Read out the fault memory using the KTM diagnostics tool. 🛠️	○	●	●	●	●
Check the exhaust valve control unit with the KTM diagnostics tool. 🛠️		●	●	●	●
Check that the electrical equipment is functioning properly.	○	●	●	●	●
Change the engine oil and the oil filter, clean the oil screens. 🛠️ (📖 p. 288)	○	●	●	●	●
Check the front brake linings. (📖 p. 228)	○	●	●	●	●
Check the brake linings of the rear brake. (📖 p. 233)	○	●	●	●	●
Check the brake discs. (📖 p. 223)	○	●	●	●	●
Check the brake lines for damage and leakage.	○	●	●	●	●

11 SERVICE SCHEDULE

		every 24 months			
		every 12 months			
		every 30,000 km (18,600 mi)			
		every 15,000 km (9,300 mi)			
		after 1,000 km (620 mi)			
Change the front brake fluid. 🛠️					•
Change the rear brake fluid. 🛠️					•
Change the hydraulic clutch fluid. 🛠️					•
Check front brake fluid level. (📖 p. 224)	○	•	•	•	
Check rear brake fluid level. (📖 p. 229)	○	•	•	•	
Check/correct the fluid level of hydraulic clutch. 🛠️		•	•	•	
Check the shock absorber and fork for leaks. Perform service as needed and depending on how the vehicle is used. 🛠️	○	•	•	•	•
Clean dust boots of the fork legs. 🛠️ (📖 p. 217)		•	•		
Check the steering head bearing play. 🛠️	○	•	•	•	•
Check tire condition. (📖 p. 244)	○	•	•	•	•
Check tire pressure. (📖 p. 246)	○	•	•	•	•
Check chain, rear sprocket, engine sprocket, and chain guide. (📖 p. 206)		•	•	•	•
Check the chain tension. (📖 p. 203)	○	•	•	•	•
Measure the wheel bearing play and grease the rear hub. 🛠️			•		
Check that the rear wheel nut (right side) is tightened to the specified torque. 🛠️	○	•	•	•	•
Change the spark plugs (Air filter removed). 🛠️			•		

		every 24 months			
		every 12 months			
		every 30,000 km (18,600 mi)			
		every 15,000 km (9,300 mi)			
		after 1,000 km (620 mi)			
Check the valve clearance (air filter and spark plugs removed). 🛠️			•		
Change the SAS membrane. 🛠️			•		
Check the cables for damage and routing without sharp bends (fuel tank removed). 🛠️			•	•	•
Check coolant level in the compensating tank. (📖 p. 279)	○	•	•	•	•
Change the air filter, clean the air filter box. 🛠️			•	•	
Check the fuel pressure. 🛠️			•	•	•
Check setting of the lighting system. (📖 p. 268)	○	•	•		
Check that the radiator fan is functioning properly. 🛠️	○	•	•	•	•
Final check: Check the vehicle for road worthiness and take a test ride. 🛠️	○	•	•	•	•
Read out the error memory after the test ride using the KTM diagnostics tool. 🛠️	○	•	•	•	•
Reset the service display using the KTM diagnostic tool. 🛠️	○	•	•	•	•
Make the service entry in KTM Dealer.net and in the Service & Manufacturer Warranty Booklet. 🛠️	○	•	•	•	•

- One-time interval
- Periodic interval

11 SERVICE SCHEDULE

11.3 Recommended work

		every 48 months			
		every 12 months			
		every 30,000 km (18,600 mi)			
		every 15,000 km (9,300 mi)			
		after 1,000 km (620 mi)			
Check the frame. 🛠️			•		
Check the link fork. 🛠️			•		
Check/clean the oil nozzle for clutch lubrication. 🛠️	○	•	•		
Check the fork bearing. 🛠️		•	•		
Check the wheel bearings. 🛠️		•	•		
Clean the drain hole of the shock absorber support. 🛠️		•	•	•	•
Grease all moving parts (e.g., side stand, hand lever, chain, ...) and check for smooth operation. 🛠️	○	•	•	•	•
Empty the drainage hoses. 🛠️	○	•	•	•	•
Check all hoses (e.g. fuel, cooling, bleeder, drainage, etc.) and sleeves for cracking, leaks, and incorrect routing. 🛠️		•	•	•	•
Check the screws and nuts for tightness. 🛠️	○	•	•	•	•
Check the antifreeze. 🛠️	○	•	•	•	
Change the coolant. 🛠️					•

○ One-time interval

• Periodic interval

12.1 Fork/shock absorber

Semi-active suspension **WP Semi-active Suspension** can be used to tune the suspension individually without the use of tools.

Electronic suspension setting **WP Semi-active Suspension** constantly regulates the damping behavior of the suspension taking into account various sensor data.

As a result, the electronic damping valves are matched to the current driving situation and terrain characteristics as well as the settings made by the rider in the **"Load"** and **"Damping"** menu.

Always adapt the suspension to your riding style and the payload.

In the **"Load"** menu, the suspension can be set to the payload.

In the **"Damping"** menu, the damping behavior of the suspension can be set.

12.2 "Load"

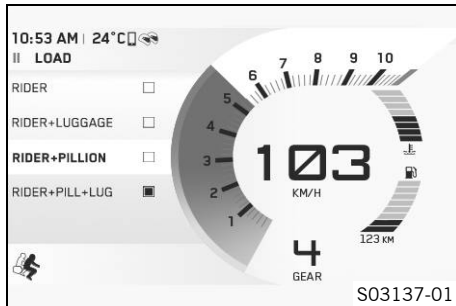

Tunings for different payloads can be selected in the **"Load"** menu. A selection can be made between one-person operation, one-person operation with luggage, two-person operation, and two-person operation with luggage.

The payload selected last is displayed on the right in the segment display.



Info

For the setting to be accepted by the motorcycle, the motorcycle must be stationary and unloaded, and the engine must be running.

The symbol of the last payload flashes until the new setting is adopted.

12.3 "Damping"

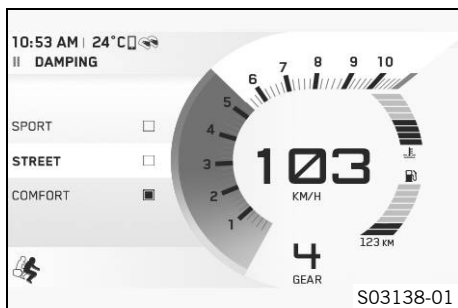

Possible states

- SPORT – Tight tuning of the suspension components with very direct feedback from the chassis
- STREET – Normal tuning of the suspension components with direct feedback from the chassis
- COMFORT – Soft tuning of the suspension components with good feedback from the chassis

Various tunings for the damping of the suspension components can be selected in the **"Damping"** menu. You can choose from **"SPORT"**, **"STREET"** and **"COMFORT"**.



Info

If the setting for **"Drive Mod"** is changed, the relevant setting for **"Damping"** will change at the same time.

13.1 Raising the motorcycle with the rear lifting gear

Note

Danger of damage The parked vehicle can roll away or fall over.

- Park the vehicle on a firm and level surface.

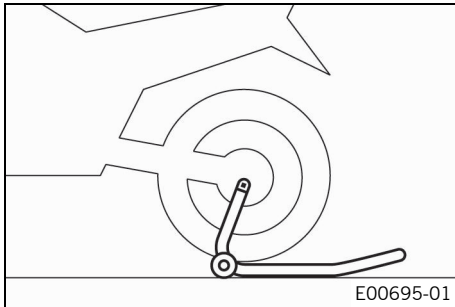

- Insert the adapter in the rear lifting gear.

Rear wheel work stand for single-sided swing arm
(61329955000)

- Position the motorcycle upright, place the lifting gear in the axle, and raise the motorcycle.



13.2 Removing the rear of motorcycle from the lifting gear

Note

Danger of damage The parked vehicle can roll away or fall over.

- Park the vehicle on a firm and level surface.

13 SERVICE WORK ON THE CHASSIS

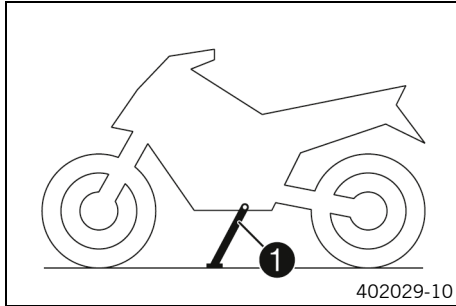

- Secure the motorcycle against falling over.
- Remove the rear wheel stand and lean the vehicle on side stand ①.

13.3 Lifting the motorcycle with the front lifting gear

Note

Danger of damage The parked vehicle can roll away or fall over.

- Park the vehicle on a firm and level surface.

Preparatory work

- Raise the motorcycle with the rear lifting gear. (📖 p. 189)

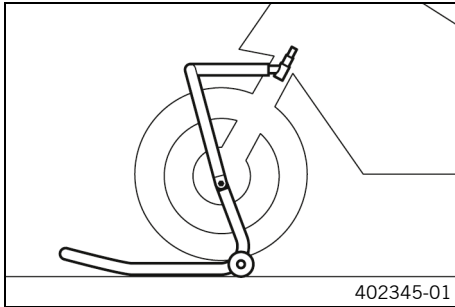

Main work

- Move the handlebar to the straight-ahead position.
- Position front lifting gear with adapter.

Mounting pin (69329965040)

Front wheel work stand, large (69329965100)

- Align the front lifting gear with the fork legs.



Info

Always raise the motorcycle at the rear first.

- Lift the motorcycle at the front.



13.4 Taking the motorcycle off the front lifting gear

Note

Danger of damage The parked vehicle can roll away or fall over.

- Park the vehicle on a firm and level surface.

13 SERVICE WORK ON THE CHASSIS

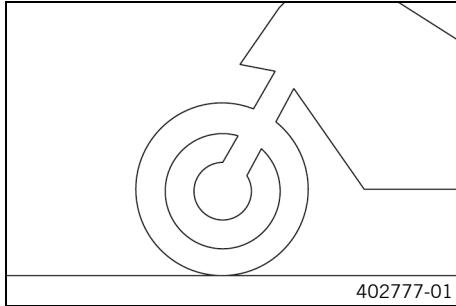

- Secure the motorcycle against falling over.
- Remove the front lifting gear.

13.5 Removing the passenger seat

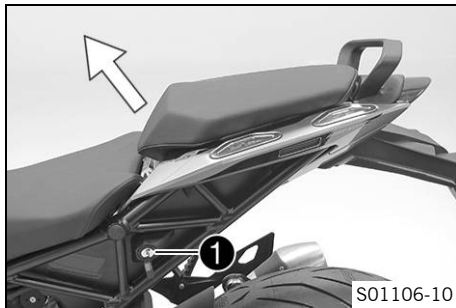

- Insert the RACE-ON key or the black ignition key into seat lock ① and turn clockwise.
- Raise the front of the passenger seat, pull it toward the fuel tank, and take off from above.
- Remove the ignition key.

13.6 Mounting the passenger seat

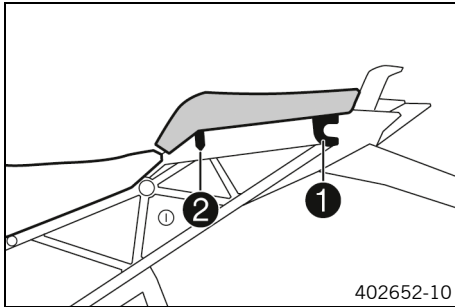

- Attach hooks on the passenger seat to seat mounts ①.
- Lower the front of the passenger seat and push back.
- Position locking pin ② in the lock housing and press passenger seat down at the front.
- ✓ The locking pin engages with an audible click.
- Check that the passenger seat is mounted correctly.



13.7 Removing the front rider's seat

Preparatory work

- Remove the passenger seat. (📖 p. 192)

13 SERVICE WORK ON THE CHASSIS

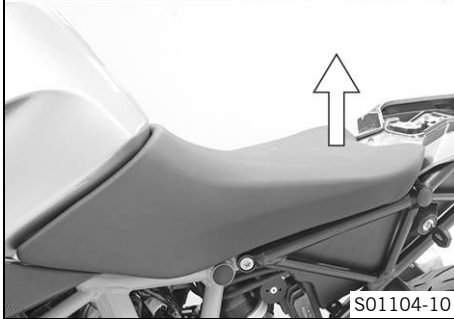
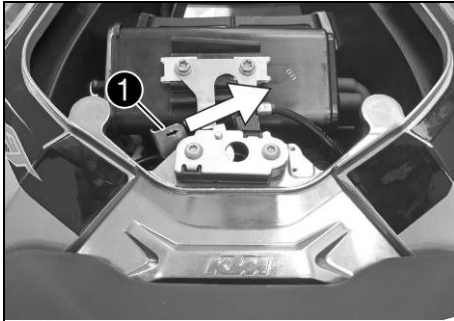

Main work

- Press seat release ① in the direction of the arrow and lift the front rider's seat at the rear at the same time.
- Detach the front of the front rider's seat and take it off.

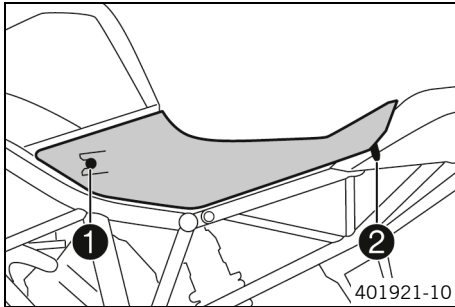
13.8 Mounting the front rider's seat**Main work**

- Attach recesses ① on the front rider's seat to the fuel tank, push the front rider's seat forward.
- Position locking pin ② in the lock housing and push down the front rider's seat at the rear.
 - ✓ The locking pin engages with an audible click.
- Check that the front rider's seat is mounted correctly.

Finishing work

- Mount passenger seat. (📖 p. 193)



13 SERVICE WORK ON THE CHASSIS

13.9 Removing the windshield

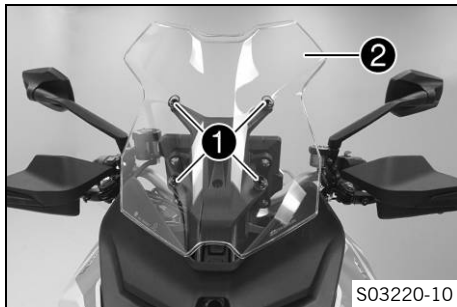

- Remove screws ① with rubber bushing and windshield ②.

13.10 Installing the windshield

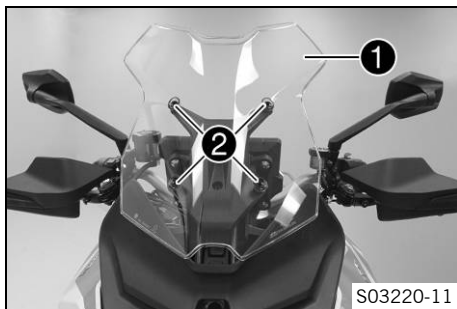

- Position windshield ①.
- Mount and tighten screws ② with rubber bushings.

Guideline

Screw, windshield	M5	3.5 Nm (2.58 lbf ft)
-------------------	----	-------------------------

13.11 Removing the main silencer ↩



Warning

Danger of burns The exhaust system gets very hot when the vehicle is driven.

- Allow the exhaust system to cool down before performing any work on the vehicle.

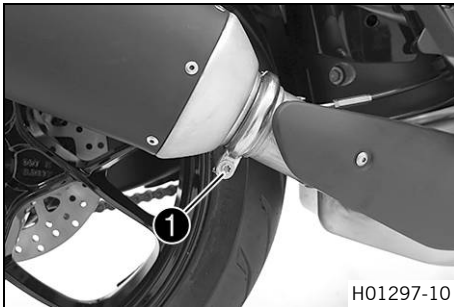

H01297-10

- Remove screw ①.
- Take off exhaust clamp.

13 SERVICE WORK ON THE CHASSIS

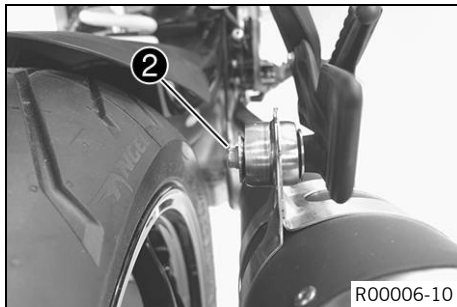

- Remove screw ②.



Warning

Risk of injury Moving parts of the exhaust valve constitute a risk of injury.

- Do not touch the exhaust valve if the main silencer has been removed.
- Make sure that nobody gets caught when the exhaust valve is actuated.

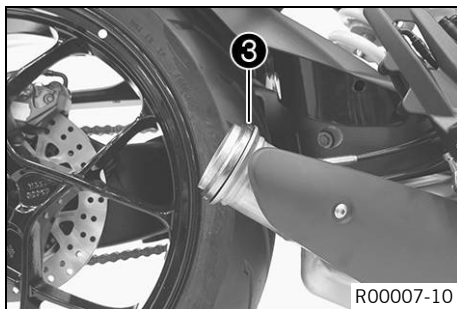

- Take off main silencer.
- Remove seal ring ③.

13.12 Installing the main silencer

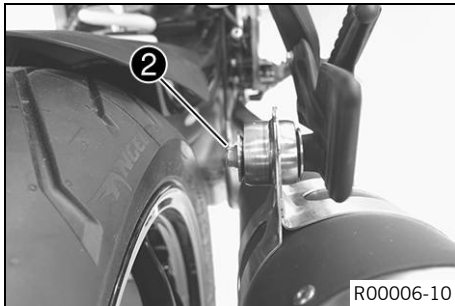
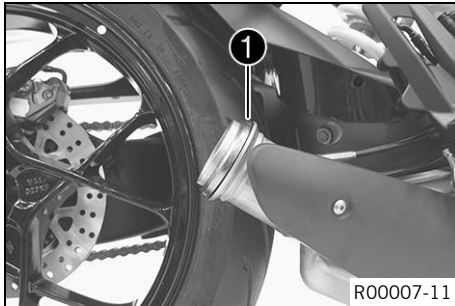

Warning

Risk of injury Moving parts of the exhaust valve constitute a risk of injury.

- Do not touch the exhaust valve if the main silencer has been removed.
- Make sure that nobody gets caught when the exhaust valve is actuated.

- Mount seal ring ①.
- Position main silencer.
- Mount screw ②, but do not tighten yet.

Guideline

Remaining screws, chassis	M8	25 Nm (18.4 lbf ft)
---------------------------	----	---------------------

13 SERVICE WORK ON THE CHASSIS

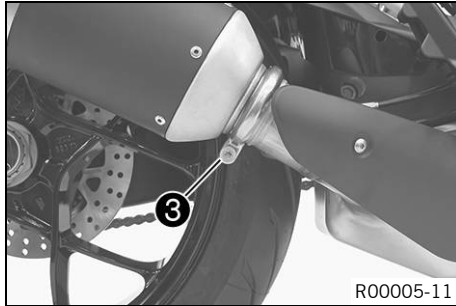

- Position exhaust clamp.
- Mount and tighten screw ③.

Guideline

Screw, exhaust clamp on main silencer	M6	8 Nm (5.9 lbf ft)
---------------------------------------	----	-------------------

- Tighten screw ②.

Guideline

Remaining screws, chassis	M8	25 Nm (18.4 lbf ft)
---------------------------	----	---------------------

13.13 Checking the chain for dirt

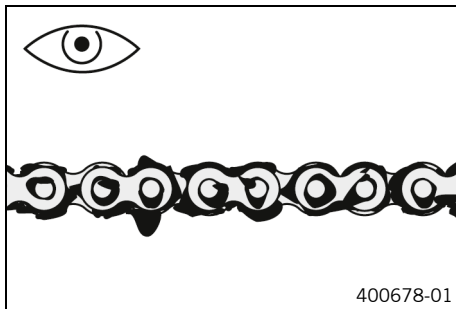

- Check the chain for coarse dirt accumulation.
 - » If the chain is very dirty:
 - Clean the chain. (📖 p. 201)

13.14 Cleaning the chain



Warning

Danger of accidents Lubricants on the tires reduces the road grip.

- Remove lubricants from the tires using a suitable cleaning agent.



Warning

Danger of accidents Oil or grease on the brake discs reduces the braking effect.

- Always keep the brake discs free of oil and grease.
- Clean the brake discs with brake cleaner when necessary.



Note

Environmental hazard Hazardous substances cause environmental damage.

- Dispose of oils, grease, filters, fuel, cleaning agents, brake fluid, etc., correctly and in compliance with the applicable regulations.



Info

The service life of the chain depends largely on its maintenance.
Regular cleaning increases the service life of the chain.

Preparatory work

- Raise the motorcycle with the rear lifting gear. (📖 p. 189)

13 SERVICE WORK ON THE CHASSIS

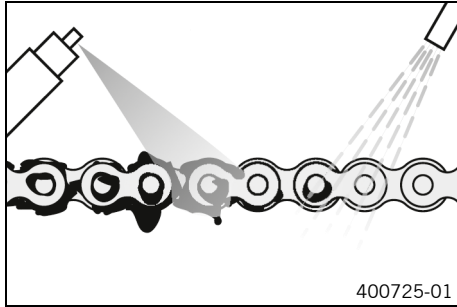

Main work

- Rinse off loose dirt with a soft jet of water.
- Remove old grease residue with chain cleaner.

Chain cleaner (📖 p. 337)

- After drying, apply chain spray.

Street chain spray (📖 p. 338)

Finishing work

- Remove the rear of the motorcycle from the lifting gear.
(📖 p. 189)

13.15 Checking the chain tension



Warning

Danger of accidents Incorrect chain tension damages components and results in accidents.

If the chain is tensioned too much, the chain, engine sprocket, rear sprocket, transmission and rear wheel bearings wear more quickly. Some components may break if overloaded.

If the chain is too loose, the chain may fall off the engine sprocket or the rear sprocket. As a result, the rear wheel locks or the engine will be damaged.

- Check the chain tension regularly.
- Set the chain tension in accordance with the specification.

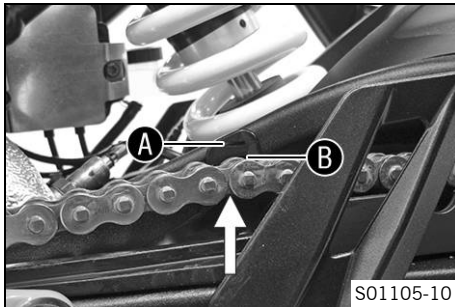

Preparatory work

- Raise the motorcycle with the rear lifting gear. (📖 p. 189)

Main work

- Shift the transmission into neutral **N**.
- At the chain sliding guard in the area of markings **A** and **B**, push the chain upward and determine the chain tension.



Info

The lower chain section must be taut.

Chain wear is not always even, so you should repeat this measurement at different chain positions.

13 SERVICE WORK ON THE CHASSIS

The upper edge of the chain is located between markings **A** and **B**.

- » If the chain tension does not meet the specification:
 - Adjust the chain tension. (📖 p. 205)
- Check protection caps **1** for damage and tightness.
 - » If the protection caps are damaged or loose:
 - Replace the protection caps.

Link fork protection cap (61304041100)

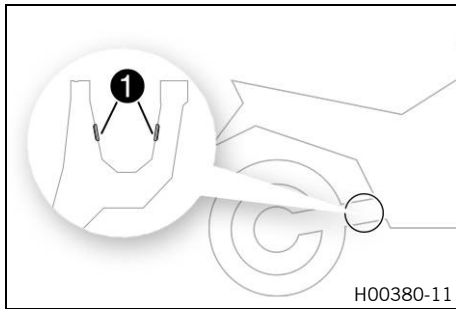

Finishing work

- Remove the rear of the motorcycle from the lifting gear. (📖 p. 189)

13.16 Adjusting the chain tension



Warning

Danger of accidents Incorrect chain tension damages components and results in accidents.

If the chain is tensioned too much, the chain, engine sprocket, rear sprocket, transmission and rear wheel bearings wear more quickly. Some components may break if overloaded.

If the chain is too loose, the chain may fall off the engine sprocket or the rear sprocket. As a result, the rear wheel locks or the engine will be damaged.

- Check the chain tension regularly.
- Set the chain tension in accordance with the specification.

Preparatory work

- Raise the motorcycle with the rear lifting gear. (🔧 p. 189)
- Check the chain tension. (🔧 p. 203)

Main work

- Loosen screw ❶.
- Set the chain tension by turning the hub housing.

Holding wrench (61329085000)
Handle for holding wrench (60012060000)

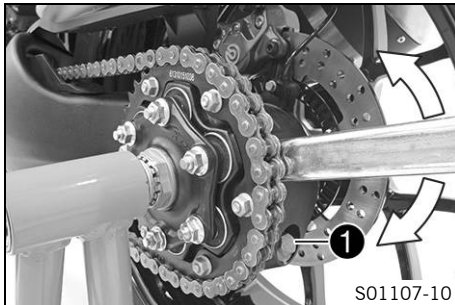

13 SERVICE WORK ON THE CHASSIS



Info

Turn clockwise to increase the chain tension; turn counterclockwise to reduce the chain tension.

- Check the chain tension. (📖 p. 203)
- ✓ The chain tension matches the specified value.



Info

Chain wear is not always even, so you should repeat this measurement at different chain positions.

- Tighten screw ❶.

Guideline

Screw, eccentric	M16	70 Nm (51.6 lbf ft)
------------------	-----	---------------------

- Remove the rear of the motorcycle from the lifting gear. (📖 p. 189)



13.17 Checking the chain, rear sprocket, engine sprocket, and chain guide

Preparatory work

- Raise the motorcycle with the rear lifting gear. (📖 p. 189)

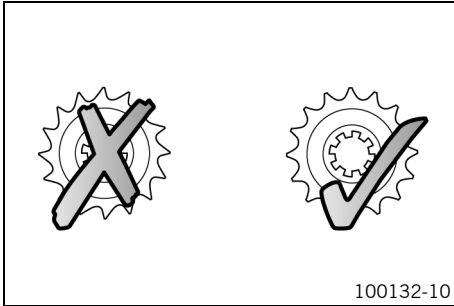

Main work

- Check rear sprocket and engine sprocket for wear.
 - » If the rear sprocket or engine sprocket is worn:
 - Change the drivetrain kit. 🛠️



Info

The engine sprocket, rear sprocket, and chain should always be replaced together.

13 SERVICE WORK ON THE CHASSIS

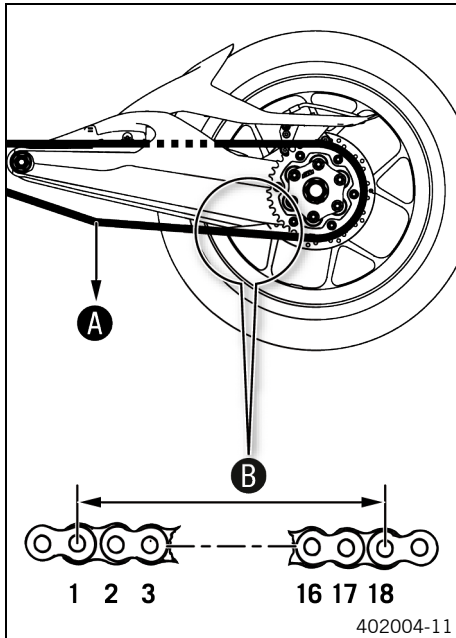

- Shift the transmission into neutral **N**.
- Pull on the lower chain section with the specified weight **A**.

Guideline

Weight, chain wear measurement	15 kg (33 lb.)
--------------------------------	----------------

- Measure distance **B** of 18 chain rollers in the lower chain section.



Info

Chain wear is not always even, so you should repeat this measurement at different chain positions.

Maximum distance B from 18 chain rollers at the longest chain section	272 mm (10.71 in)
--	-------------------

- » If distance **B** is greater than the specified measurement:
 - Change the drivetrain kit. 🛠️



Info

When a new chain is mounted, the rear sprocket and engine sprocket should also be changed. New chains wear out faster on an old, worn rear sprocket or engine sprocket. For safety reasons, the chain has no chain joint.

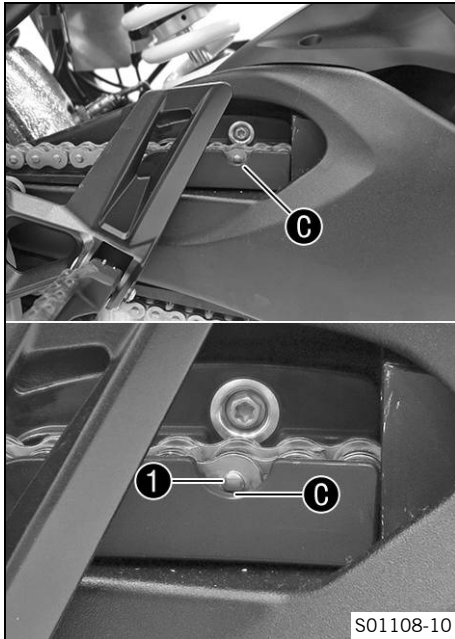

- Check chain sliding guard for wear at the recess.
 - » If chain rivet **1** is no longer visible at bottom edge **C** of the recess of the chain sliding guard:
 - Change the chain sliding guard. 🔧
- Check that the chain sliding guard is firmly seated.
 - » If the chain sliding guard is loose:
 - Tighten screws on the chain sliding guard.

Guideline

Screw, chain sliding guard	M5	5 Nm (3.7 lbf ft)
----------------------------	----	-------------------

13 SERVICE WORK ON THE CHASSIS

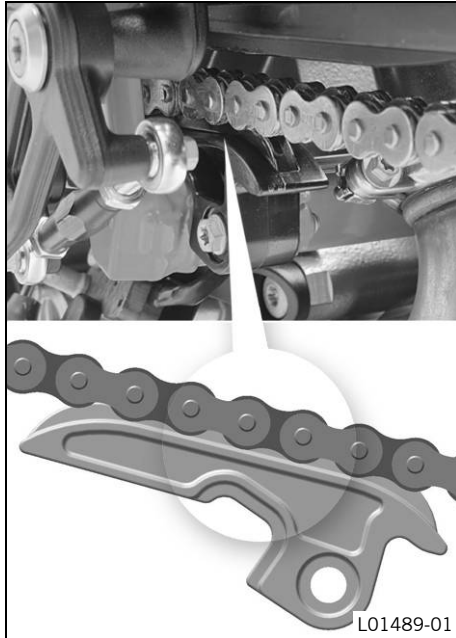

- Check chain sliding piece for wear.
 - » If the lower edge of the chain is in line with or below the chain sliding piece:
 - Change the chain sliding piece. 🛠️
- Check that the chain sliding piece is firmly seated.
 - » If the chain sliding piece is loose:
 - Tighten screw on the chain sliding piece.

Guideline

Remaining screws, chassis	M8	25 Nm (18.4 lbf ft)
---------------------------	----	------------------------

Finishing work

- Remove the rear of the motorcycle from the lifting gear.
(📖 p. 189)

13.18 Checking/correcting the fluid level of the hydraulic clutch



Warning

Skin irritation Brake fluid causes skin irritation.

- Keep brake fluid out of the reach of children.
- Wear suitable protective clothing and safety glasses.
- Do not allow brake fluid to come into contact with the skin, the eyes or clothing.
- Consult a doctor immediately if brake fluid has been swallowed.
- Rinse the affected area with plenty of water in the event of contact with the skin.
- Rinse eyes thoroughly with water immediately and consult a doctor if brake fluid comes into contact with the eyes.
- If brake fluid spills on to your clothing, change the clothing.



Note

Environmental hazard Hazardous substances cause environmental damage.

- Dispose of oils, grease, filters, fuel, cleaning agents, brake fluid, etc., correctly and in compliance with the applicable regulations.

13 SERVICE WORK ON THE CHASSIS



Info

The fluid level rises with increasing wear of the clutch facing discs.

Never use DOT 5 brake fluid. It is silicone-based and purple in color. Oil seals and clutch lines are not designed for DOT 5 brake fluid.

Avoid contact between brake fluid and painted parts. Brake fluid attacks paint.

Only use clean brake fluid from a sealed container.

- Move the clutch fluid reservoir mounted on the handlebar to a horizontal position.



- Check the fluid level.

The fluid level must be between **MIN** and **MAX** markings.

- » If the fluid level does not meet specifications:
 - Remove screw cap ❶ with membrane ❷.
 - Correct the fluid level of the hydraulic clutch.

Brake fluid DOT 4 / DOT 5.1 (📖 p. 333)

- Mount and tighten screw cap ❶ with membrane ❷.

i Info

Clean up overflowed or spilled brake fluid immediately with water.

13 SERVICE WORK ON THE CHASSIS

13.19 Removing the fuel tank spoiler



- Remove screws ① and ②.

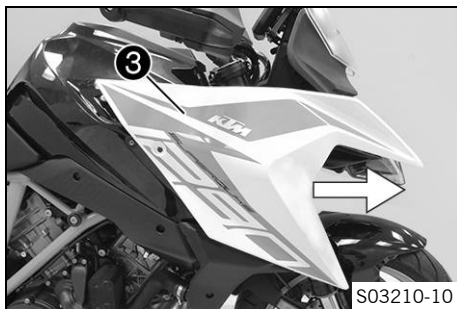

- Carefully pull fuel tank spoiler ③ forward.
- Take off fuel tank spoiler.
- Repeat these steps on the opposite side.

13.20 Installing the fuel tank spoiler

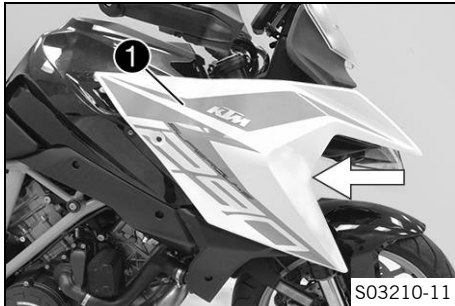

- Position fuel tank spoiler ①.
- Push fuel tank spoiler ① to the rear.



Info

Check the fuel tank spoiler is seated properly and attach in the hold points provided.



- Mount and tighten screws ② and ③.

Guideline

Screw, trim	M5x12	3.5 Nm (2.58 lbf ft)
-------------	-------	-------------------------

- Repeat these steps on the opposite side.

13 SERVICE WORK ON THE CHASSIS

13.21 Removing front fender

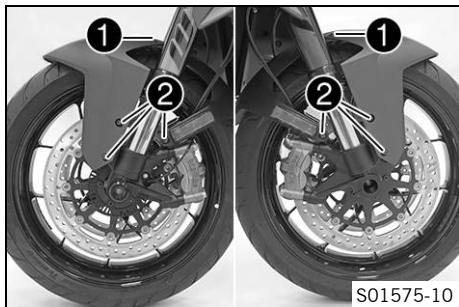

- Remove screws ①.
- Remove screws ②.
- Take off the fender.



Info

Pay attention to the brake lines.

13.22 Installing front fender

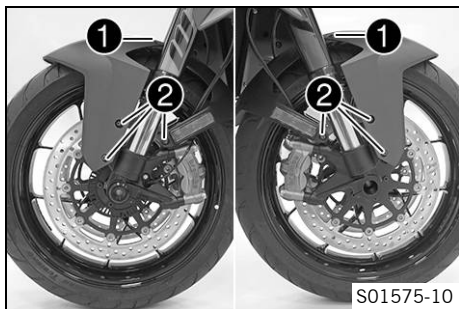

- Position the fender.



Info

Pay attention to where the brake lines are placed.

- Mount and tighten screws ①.

Guideline

Screw, trim	M5x12	3.5 Nm (2.58 lbf ft)
-------------	-------	-------------------------

- Mount and tighten screws ②.

Guideline

Remaining screws, chassis	M5	5 Nm (3.7 lbf ft)
------------------------------	----	-------------------



13.23 Cleaning the dust boots of the fork legs ↴

Preparatory work

- Raise the motorcycle with the rear lifting gear. (🛠 p. 189)
- Lift the motorcycle with the front lifting gear. (🛠 p. 190)

Main work

- Push dust boots ❶ of both fork legs downward.

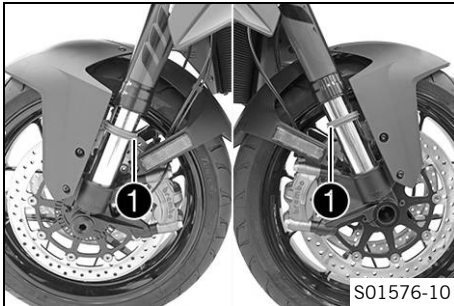

S01576-10



Info

The dust boots remove dust and coarse dirt particles from the inside fork tubes. Over time, dirt can accumulate behind the dust boots. If this dirt is not removed, the oil seals behind can start to leak.



Warning

Danger of accidents Oil or grease on the brake discs reduces the braking effect.

- Always keep the brake discs free of oil and grease.
- Clean the brake discs with brake cleaner when necessary.

- Clean and oil the dust boots and inner fork tubes of both fork legs.

Universal oil spray (📖 p. 338)

- Press dust boots back into the installation position.
- Remove excess oil.

Finishing work

- Take the motorcycle off the front lifting gear. (📖 p. 191)
- Remove the rear of the motorcycle from the lifting gear. (📖 p. 189)



14.1 Anti-lock braking system (ABS)

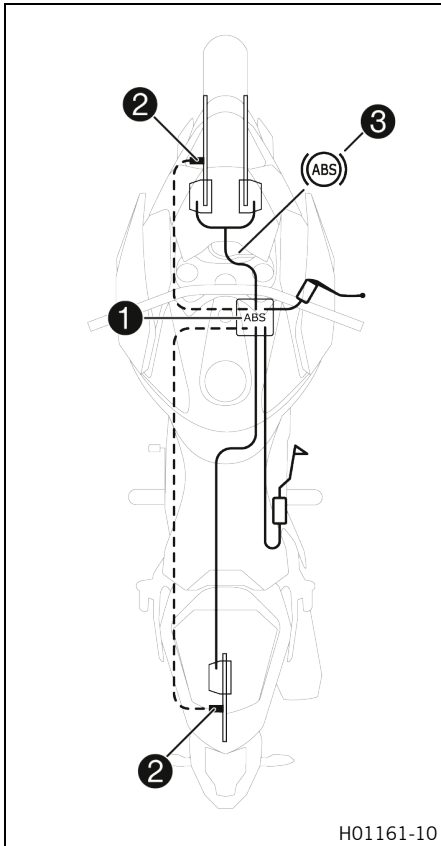

The ABS unit **1**, which consists of a hydraulic unit, ABS control unit, and return pump, is installed on the right vehicle side below the fuel tank. One wheel speed sensor **2** is located in each case on the front and the rear wheel.



Warning

Danger of accidents Changes to the vehicle impair the function of the ABS.

- Only allow the rear wheel to spin with the front brake applied away from public road traffic if the ABS is switched off.
- Do not make any changes to the suspension travel.
- Only use spare parts on the brake system which have been approved and recommended by KTM.
- Only use tires/wheels approved by KTM with the corresponding speed index.
- Maintain specified tire pressure.
- Ensure that service work and repairs are performed professionally. (Your authorized KTM workshop will be glad to help.)

ABS is a safety system that prevents locking of the wheels when driving straight ahead without the influence of lateral forces.



Warning

Danger of accidents Driving aids can only prevent a rollover within the physical limitations.

It is not always possible to compensate for extreme riding situations, for example with luggage loaded with a high center of gravity, varying road surfaces, steep descents or full braking without disengaging the gear.

- Adapt your riding style to the road conditions and your driving ability.

ABS has two operating modes: the **"Road"** and **"Supermoto"** ABS modes.

In the **"Road"** ABS mode, the ABS controls both wheels.

In the **"Supermoto"** ABS mode, the ABS only controls the front wheel. There is no ABS intervention on the rear wheel. ABS warning lamp  flashes slowly to remind you that the **"Supermoto"** ABS mode is active.



Info

In the **"Supermoto"** ABS mode, the rear wheel may lock, and there is a risk of falling.

The ABS operates with two independent brake circuits (front and rear brakes). When the ABS control unit detects a locking tendency in a wheel, ABS begins regulating the brake pressure. The

control function causes a slight pulsing of the hand and foot brake levers.

The ABS warning lamp  must light up after the ignition is switched on and go out after starting off. If it does not go out after starting off or if it is lit while riding, this indicates a fault in the ABS system. In this case, the ABS is no longer enabled and the wheels may lock during braking. The brake system itself stays functional; only ABS control is not available.

The ABS warning lamp may also light up if the rotating speeds of the front and rear wheels differ greatly under extreme riding conditions, for example when making "wheelies" or if the rear wheel spins. This causes the ABS to switch off.

To reactivate the ABS, the vehicle must be stopped and the ignition switched off. The ABS is reactivated when the vehicle is switched on again. The ABS warning lamp goes out after starting off.

MSC

The **MSC** is a supplementary function for the ABS that can prevent blocking and slipping of the wheels during braking when the vehicle is inclined (riding in curves) within the physical limitations. By means of the 5-D sensor, the ABS control is now dependent on the inclination and pitch angle.

ABS control that is dependent on the inclination and pitch angle improves the riding stability and braking effect in all riding situations. The **MSC** also reduces the righting moment during hard braking in curves. This prevents the motorcycle from righting itself from an inclined angle and moving along a larger curve radius.

Due to the additional electronic control of the brake force distribution between the two wheels, the braking force is optimally distributed and the motorcycle is additionally stabilized.



Info

The **MSC** is only active in ABS mode "**Road**".
There is no cornering ABS in "**Supermoto**" ABS mode.

14.2 Rear brake temperature monitoring (BTM)

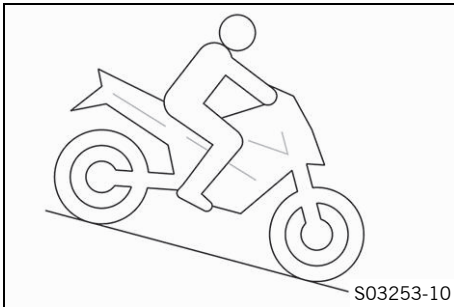

Warning

Danger of accidents The brake temperature monitoring does not protect from overheating.

The brake temperature is calculated, not measured.

- See instructions in the "Braking" chapter.
- Stop immediately, even if no temperature warning is displayed, if the brake lever pressure point becomes spongy.

When the rear brake is used frequently and for excessively long periods, for example on long downhill stretches, the temperature of the brake system may increase.

An overheating brake system results in reduced brake power through to failure of the brake system.

A brake temperature monitoring warning (📖 p. 66) is displayed in the combination instrument.

In order to avoid overloading the rear brake system, use the front and rear brakes, as well as the engine braking effect in combination.

14.3 Checking the brake discs



Warning

Danger of accidents Worn-out brake discs reduce the braking effect.

- Make sure that worn-out brake discs are replaced immediately. (Your authorized KTM workshop will be glad to help.)

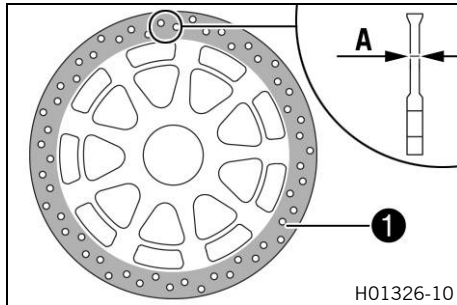

- Check the front and rear brake disc thickness at multiple points for the dimension **A**.



Info

Wear will reduce the thickness of the brake disc at contact surface **1** of the brake linings.

Brake discs - wear limit	
front	4.5 mm (0.177 in)
rear	4.5 mm (0.177 in)

- » If the brake disc thickness is less than the specified value.

- Change the front brake discs. 🛠️
- Change the rear brake disc. 🛠️
- Check the front and rear brake discs for damage, cracking, and deformation.
 - » If the brake disc exhibits damage, cracking, or deformation:
 - Change the front brake discs. 🛠️
 - Change the rear brake disc. 🛠️

14.4 Checking the front brake fluid level



Warning

Danger of accidents An insufficient brake fluid level will cause the brake system to fail.

If the brake fluid level drops below the **MIN** marking, the brake system is leaking or the brake linings are worn down.

- Check the brake system and do not continue riding until the problem is eliminated. (Your authorized KTM workshop will be glad to help.)



Warning

Danger of accidents Old brake fluid reduces the braking effect.

- Make sure that brake fluid for the front and rear brake is changed in accordance with the service schedule. (Your authorized KTM workshop will be glad to help.)

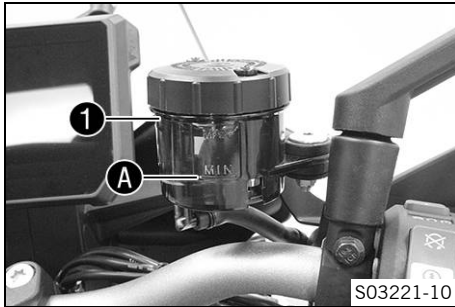

- Move brake reservoir mounted on the handlebar to a horizontal position.
- Check brake fluid level in brake fluid reservoir ①.
 - » If the brake fluid level has dropped below **MIN** marking ②:
 - Add front brake fluid. 🗨️ (📖 p. 225)



14.5 Adding front brake fluid 🗨️



Warning

Danger of accidents An insufficient brake fluid level will cause the brake system to fail.

If the brake fluid level drops below the **MIN** marking, the brake system is leaking or the brake linings are worn down.

- Check the brake system and do not continue riding until the problem is eliminated. (Your authorized KTM workshop will be glad to help.)



Warning

Skin irritation Brake fluid causes skin irritation.

- Keep brake fluid out of the reach of children.
- Wear suitable protective clothing and safety glasses.
- Do not allow brake fluid to come into contact with the skin, the eyes or clothing.
- Consult a doctor immediately if brake fluid has been swallowed.
- Rinse the affected area with plenty of water in the event of contact with the skin.
- Rinse eyes thoroughly with water immediately and consult a doctor if brake fluid comes into contact with the eyes.
- If brake fluid spills on to your clothing, change the clothing.



Warning

Danger of accidents Old brake fluid reduces the braking effect.

- Make sure that brake fluid for the front and rear brake is changed in accordance with the service schedule. (Your authorized KTM workshop will be glad to help.)



Note

Environmental hazard Hazardous substances cause environmental damage.

- Dispose of oils, grease, filters, fuel, cleaning agents, brake fluid, etc., correctly and in compliance with the applicable regulations.



Info

Never use DOT 5 brake fluid. It is silicone-based and purple in color. Oil seals and brake lines are not designed for DOT 5 brake fluid.

Avoid contact between brake fluid and painted parts. Brake fluid attacks paint.

Only use clean brake fluid from a sealed container.

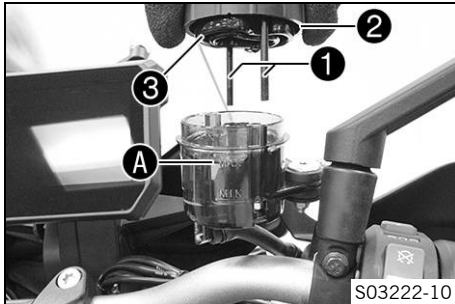

Preparatory work

- Check the front brake linings. (📖 p. 228)

Main work

- Move brake reservoir mounted on the handlebar to a horizontal position.
- Remove screws ❶.
- Take off cover ❷ with membrane ❸.
- Add brake fluid up to **MAX** marking ❸.

Brake fluid DOT 4 / DOT 5.1 (📖 p. 333)

- Position cover ❷ with membrane ❸.
- Mount and tighten screws ❶.



Info

Clean up overflowed or spilled brake fluid immediately with water.



14.6 Checking the front brake linings



Warning

Danger of accidents Worn-out brake linings reduce the braking effect.

- Ensure that worn-out brake linings are replaced immediately. (Your authorized KTM workshop will be glad to help.)



Warning

Danger of accidents Damaged brake discs reduce the braking effect.

If the brake linings are not changed in time, the brake lining carriers grind against the brake disc. As a consequence, the braking effect is greatly reduced and the brake discs are destroyed.

- Check the brake linings regularly.

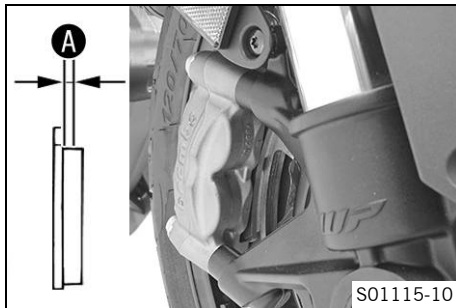

- Check all brake linings on both brake calipers to ensure they have the minimum thickness **A**.

Minimum thickness A	$\geq 1 \text{ mm } (\geq 0.04 \text{ in})$
----------------------------	---

- » If the minimum thickness is less than specified:
 - Change the front brake linings. 🛠️
- Check all brake linings on both brake calipers for damage and cracking.
 - » If there is damage or cracking:
 - Change the front brake linings. 🛠️

14.7 Checking the rear brake fluid level



Warning

Danger of accidents An insufficient brake fluid level will cause the brake system to fail.

If the brake fluid level drops below the **MIN** marking, the brake system is leaking or the brake linings are worn down.

- Check the brake system and do not continue riding until the problem is eliminated. (Your authorized KTM workshop will be glad to help.)



Warning

Danger of accidents Old brake fluid reduces the braking effect.

- Make sure that brake fluid for the front and rear brake is changed in accordance with the service schedule. (Your authorized KTM workshop will be glad to help.)

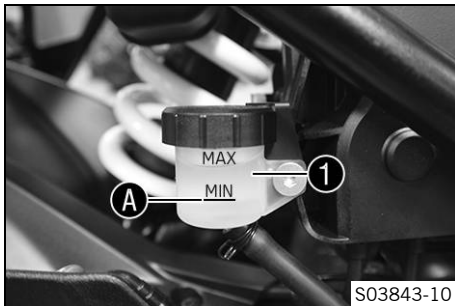

- Stand vehicle upright.
- Check brake fluid level in brake fluid reservoir ①.
 - » If the fluid level reaches the **MIN** marking ②:
 - Add rear brake fluid. 🛠️ (📖 p. 230)

14.8 Adding rear brake fluid



Warning

Danger of accidents An insufficient brake fluid level will cause the brake system to fail.

If the brake fluid level drops below the **MIN** marking, the brake system is leaking or the brake linings are worn down.

- Check the brake system and do not continue riding until the problem is eliminated. (Your authorized KTM workshop will be glad to help.)



Warning

Skin irritation Brake fluid causes skin irritation.

- Keep brake fluid out of the reach of children.
- Wear suitable protective clothing and safety glasses.
- Do not allow brake fluid to come into contact with the skin, the eyes or clothing.
- Consult a doctor immediately if brake fluid has been swallowed.
- Rinse the affected area with plenty of water in the event of contact with the skin.
- Rinse eyes thoroughly with water immediately and consult a doctor if brake fluid comes into contact with the eyes.
- If brake fluid spills on to your clothing, change the clothing.

**Warning**

Danger of accidents Old brake fluid reduces the braking effect.

- Make sure that brake fluid for the front and rear brake is changed in accordance with the service schedule. (Your authorized KTM workshop will be glad to help.)

**Note**

Environmental hazard Hazardous substances cause environmental damage.

- Dispose of oils, grease, filters, fuel, cleaning agents, brake fluid, etc., correctly and in compliance with the applicable regulations.

**Info**

Never use DOT 5 brake fluid. It is silicone-based and purple in color. Oil seals and brake lines are not designed for DOT 5 brake fluid.

Avoid contact between brake fluid and painted parts. Brake fluid attacks paint.

Only use clean brake fluid from a sealed container.

Preparatory work

- Check the brake linings of the rear brake. (📖 p. 233)

14 BRAKE SYSTEM

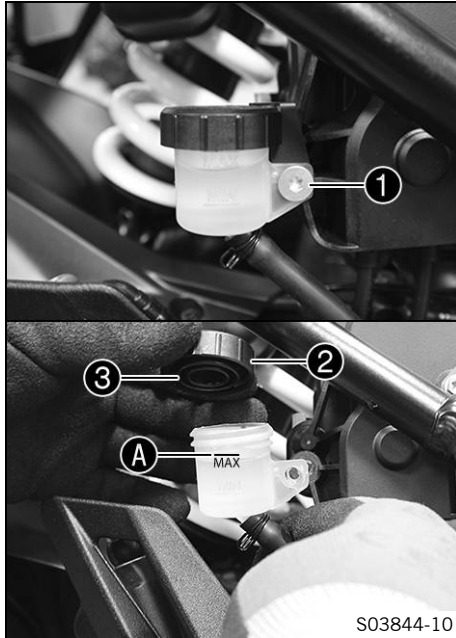

Main work

- Position the vehicle vertically.
- Remove screw **1** with the screw cap lock.



Info

Make sure that the reservoir stays vertical and no brake fluid runs out.

- Remove screw cap **2** with the washer and membrane **3**.
- Add brake fluid up to the **MAX** marking **A**.

Brake fluid DOT 4 / DOT 5.1 (📖 p. 333)

- Mount and tighten screw cap **2** with the shim and membrane **3**.
- Position the screw cap lock and mount and tighten screw **1**.

Guideline

Screw, brake fluid reservoir, rear brake	M5	3.5 Nm (2.58 lbf ft) Loctite®243™
--	----	---



Info

Immediately clean up any brake fluid that has overflowed or spilled with water.

14.9 Checking the brake linings of the rear brake



Warning

Danger of accidents Worn-out brake linings reduce the braking effect.

- Ensure that worn-out brake linings are replaced immediately. (Your authorized KTM workshop will be glad to help.)



Warning

Danger of accidents Damaged brake discs reduce the braking effect.

If the brake linings are not changed in time, the brake lining carriers grind against the brake disc. As a consequence, the braking effect is greatly reduced and the brake discs are destroyed.

- Check the brake linings regularly.

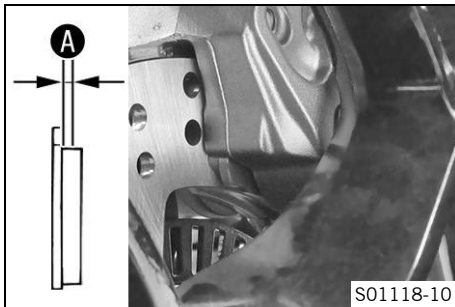

- Check the brake linings for minimum thickness **A**.

Minimum thickness A	$\geq 1 \text{ mm } (\geq 0.04 \text{ in})$
----------------------------	---

- » If the minimum thickness is less than specified:
 - Change the rear brake linings. 🛠️
- Check the brake linings for damage and cracking.
 - » If there is damage or cracking:
 - Change the rear brake linings. 🛠️

15.1 Removing the front wheel ↩

Preparatory work

- Raise the motorcycle with the rear lifting gear. (📖 p. 189)
- Lift the motorcycle with the front lifting gear. (📖 p. 190)

Main work

- Remove screw **1** and pull wheel speed sensor **2** out of the hole.

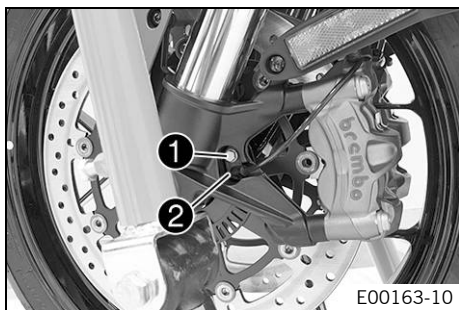

- Remove screws **3** from both brake calipers.
- Press back brake linings by slightly tilting the brake calipers laterally on the brake disc. Pull brake calipers carefully back from the brake discs and hang to the side.

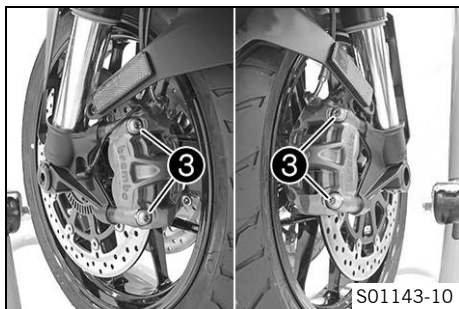

Do not operate the hand brake lever if the brake calipers have been removed.

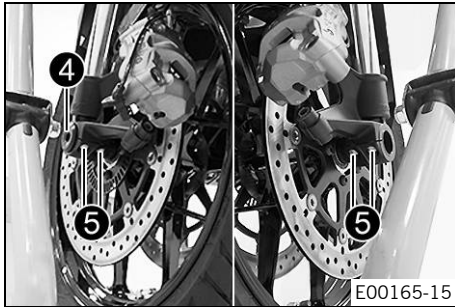

- Loosen screw ④ and screws ⑤.
- Unscrew screw ④ about six turns and press your hand on the screw to push the wheel spindle out of the axle clamp.
- Remove screw ④.



Warning

Danger of accidents Damaged brake discs reduce the braking effect.

- Always lay the wheel down in such a way that the brake discs are not damaged.

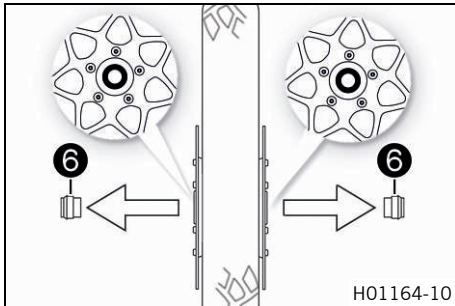

- Hold front wheel and remove wheel spindle. Take front wheel out of the fork.
- Remove spacers ⑥.

15.2 Installing the front wheel ↩

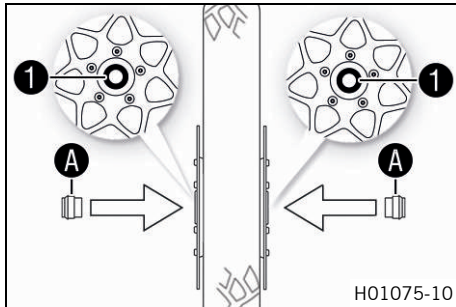

- Check the wheel bearing for damage and wear.
 - » If the wheel bearing is damaged or worn:
 - Change front wheel bearing. ↩
- Clean and grease shaft seal rings **1** and contact surfaces **A** of the spacers.

Long-life grease (🔧 p. 337)

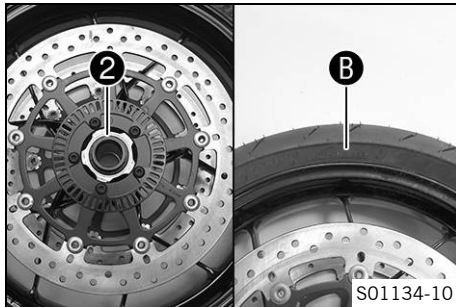

- Insert wide spacer **2** on the left in the direction of travel.



Info

Arrow **B** indicates the direction of travel of the front wheel.

The wheel speed sensor wheel is on the left viewed in the direction of travel.

- Insert the narrow spacer on the right in the direction of travel.

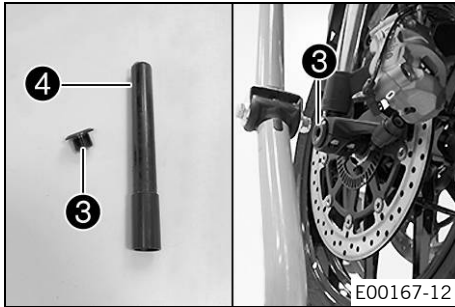

Warning

Danger of accidents Oil or grease on the brake discs reduces the braking effect.

- Always keep the brake discs free of oil and grease.
- Clean the brake discs with brake cleaner when necessary.

- Clean screw ③ and wheel spindle ④.
- Grease wheel spindle lightly.

Long-life grease (📖 p. 337)

- Jack up the front wheel into the fork, position it, and insert the wheel spindle.
- Mount and tighten screw ③.

Guideline

Screw, front wheel spindle	M25x1.5	45 Nm (33.2 lbf ft) Thread greased
----------------------------	---------	---------------------------------------

15 WHEELS, TIRES

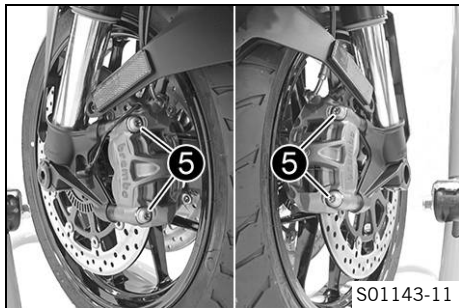

- Position brake calipers and check that the brake linings are seated correctly.
- Mount screws **5** on both brake calipers, but do not tighten yet.

Guideline

Screw, front brake caliper	M10	45 Nm (33.2 lbf ft) Loctite®243™
----------------------------	-----	--

- Operate the hand brake lever repeatedly until the brake linings are in contact with the brake disc and there is a pressure point. Secure the hand brake lever in the activated position.
 - ✓ The brake calipers straighten.
- Tighten screws **5** on both brake calipers.

Guideline

Screw, front brake caliper	M10	45 Nm (33.2 lbf ft) Loctite®243™
----------------------------	-----	--

- Remove the locking piece of the hand brake lever.

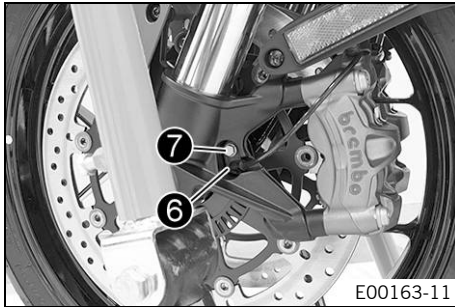

- Position wheel speed sensor **6** in the hole.
- Mount and tighten screw **7**.

Guideline

Screw, front wheel speed sensor	M6	4 Nm (3 lbf ft)
---------------------------------	----	-----------------

- Take the motorcycle off the front lifting gear. (📖 p. 191)
- Remove the rear of the motorcycle from the lifting gear. (📖 p. 189)

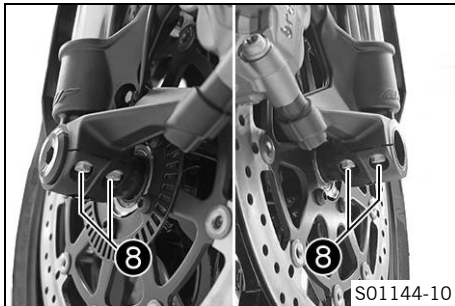

- Operate the front brake and compress the fork a few times firmly.
- ✓ The fork legs straighten.
- Tighten screws **8**.

Guideline

Screw, axle clamp	M8	15 Nm (11.1 lbf ft)
-------------------	----	---------------------

15.3 Removing the rear wheel 🛠️

Preparatory work

- Raise the motorcycle with the rear lifting gear. (📖 p. 189)
- Remove main silencer. 🛠️ (📖 p. 197)

15 WHEELS, TIRES

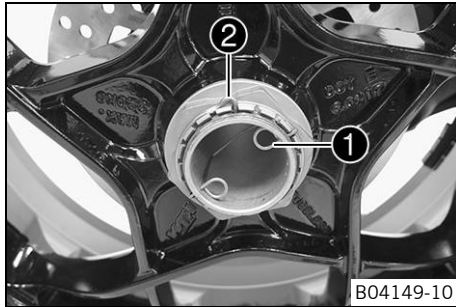

Main work

- Remove the inside locking wire ①.
- Remove the outside locking wire ②.

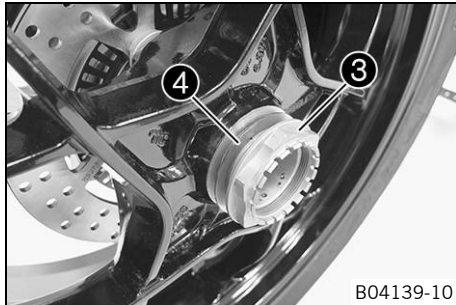

- Have an assistant operate the rear brake.
- Loosen nut ③ and remove it with washer ④.



- Take off the rear wheel.



15.4 Installing the rear wheel 🛠️



Warning

Danger of accidents Oil or grease on the brake discs reduces the braking effect.

- Always keep the brake discs free of oil and grease.
- Clean the brake discs with brake cleaner when necessary.

15 WHEELS, TIRES



Main work

- Check the rear wheel bearing for damage and wear.
 - » If the rear wheel bearing is damaged or worn:
 - Change the rear wheel bearing. 🛠️
- Clean and grease the threads of the wheel axle and axle nut.

Long-life grease (🛠️ p. 337)

- Slide the rear wheel onto the axle.
 - ✓ Driving pins **1** engage in drilled holes **A** of the rim.

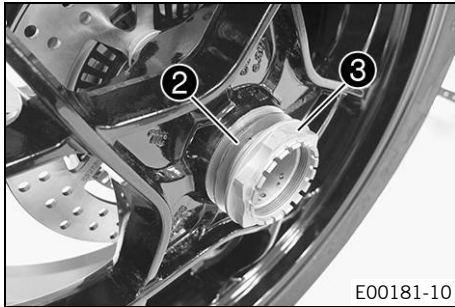

- Mount washer ② and nut ③.
- Have an assistant operate the rear brake.
- Tighten nut ③.

Guideline

Nut, rear axle	M50x1.5	250 Nm (184.4 lbf ft) Thread greased/lock locking wire with locking varnish
----------------	---------	--

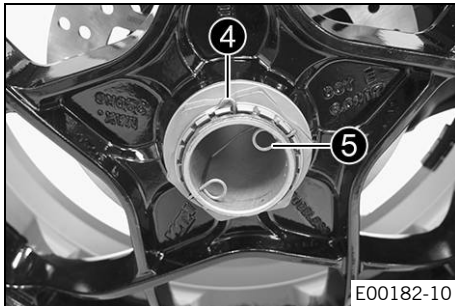

- Mount outside locking wire ④.
- Mount inside locking wire ⑤.
- ✓ The pins of the locking wires engage in the drilled holes of the wheel axle.

Finishing work

- Remove the rear of the motorcycle from the lifting gear. (📖 p. 189)
- Install main silencer. 🛠️ (📖 p. 199)

15.5 Checking the tire condition



Warning

Danger of accidents If a tire bursts while riding, the vehicle becomes uncontrollable.

- Ensure that damaged or worn tires are replaced immediately. (Your authorized KTM workshop will be glad to help.)



Warning

Danger of crashing Different tire tread patterns on the front and rear wheel impair the handling characteristic.

Different tire tread patterns can make the vehicle significantly more difficult to control.

- Make sure that only tires with a similar tire tread pattern are fitted to the front and rear wheel.



Warning

Danger of accidents Non-approved or non-recommended tires and wheels impact the handling characteristic.

- Only use tires/wheels approved by KTM with the corresponding speed index.



Warning

Danger of accidents New tires have reduced road grip.

The contact surface on new tires is not yet roughened.

- Run in new tires with moderate riding at alternating angles.
Running-in phase 200 km (124 mi)

i Info

Tire type, tire condition, and tire pressure influence the braking and handling characteristics of the vehicle.

Worn tires are particularly unfavorable on wet surfaces.

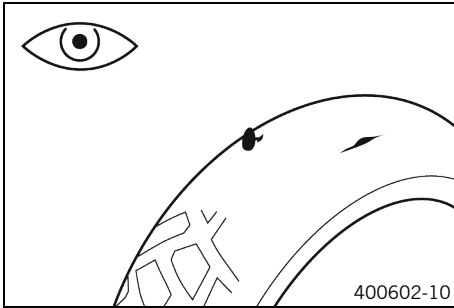

- Check front and rear tires for cuts, run-in objects, and other damage.
 - » If the tires have cuts, run-in objects, or other damage:
 - Change the tires. 🛠️
- Check tread depth.

i Info

Observe the minimum profile depth required by national law.

Minimum tread depth	$\geq 2 \text{ mm } (\geq 0.08 \text{ in})$
---------------------	---

- » If the tread depth is less than the minimum tread depth:
 - Change the tires. 🛠️

15 WHEELS, TIRES

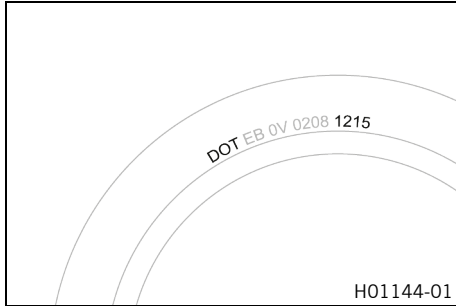

- Check tire age.



Info

The tire date of manufacture is usually contained in the tire label and is indicated by the last four digits of the **DOT** number. The first two digits indicate the week of manufacture and the last two digits the year of manufacture.

KTM recommends that the tires be changed after 5 years at the latest, regardless of the actual state of wear.

- » If the tires are more than 5 years old:
 - Change the tires. 🛠️

15.6 Checking tire pressure



Info

Low tire pressure leads to abnormal wear and overheating of the tire.

Correct tire pressure ensures optimal riding comfort and maximum tire service life.

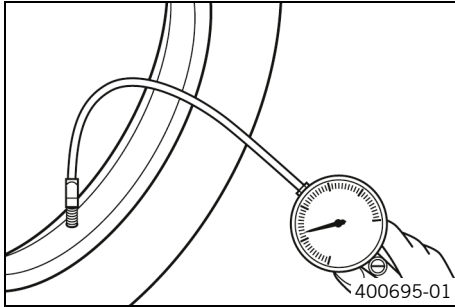

- Remove protection cap.
- Check tire pressure when the tires are cold.

Tire pressure, solo / with passenger / full payload	
front: with cold tires	2.5 bar (36 psi)
rear: with cold tires	2.9 bar (42 psi)

- » If the tire pressure does not meet specifications:
 - Correct tire pressure.
- Mount protection cap.



15.7 Using tire repair spray

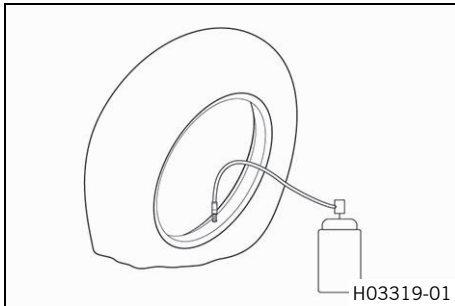

Warning

Danger of accidents Incorrect use of tire repair spray will result in the repaired tire losing pressure.

Tire repair spray cannot be used for all types of damage.

- Observe the instructions and specifications of the manufacturer of the tire repair spray.
- After repairing a tire with tire repair spray, ride slowly and carefully.
- Ride no further than to the nearest workshop and have the tire changed.

Tire repair spray should only be used in an emergency.

We recommend transporting the broken down vehicle to the nearest workshop instead of using tire repair spray.

(Super Duke GT EU)

Note

Material damage Tire repair spray damages the tire pressure sensor.

- Note that after using tire repair spray, the tire pressure sensor may need to be replaced.
-

16.1 Daytime running light (DRL)



Warning

Danger of accidents When visibility is poor, the daytime running light is not a substitute for the low beam.

Automatic switching between the daytime running light and low beam may only be partially available when visibility is significantly impaired due to fog, snow or rain.

- Ensure that the appropriate type of lighting is always selected.
- If necessary switch off the daytime running lights using the menu before going on a ride or when stopped so that the low beam is switched on permanently.
- Note the legal regulations regarding the daytime running light.

The daytime running light/parking light is integrated in the main headlight.

The daytime running light can be switched on when visibility conditions are good. Activate the daytime running light in the combination instrument. This is controlled by the ambient light sensor in the combination instrument. When visibility conditions are good, the low beam is switched off and the daytime running light is switched on. It is four times brighter than the position light.

When the daytime running light is switched off, it serves as a position light.

16.2 Cornering light



The cornering light is located on the left and the right in the fuel tank spoiler.

i Info

To activate the cornering light, the low beam must be switched on and the daytime running light switched off.

The cornering lights are activated:

Lean angle for the lower LED	$\geq 12^\circ$
Lean angle for the middle LED	$\geq 20^\circ$
Lean angle for the upper LED	$\geq 28^\circ$
Speed	$\geq 6 \text{ km/h}$ ($\geq 3.7 \text{ mph}$)

16.3 Socket for electrical accessories

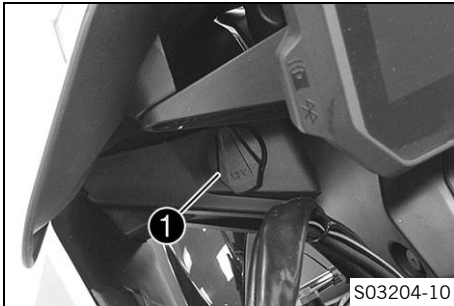

Socket ① for electrical accessories is mounted on the left side of the instrument support.
It is connected to the permanent positive and is fuse-protected.

Socket for electrical accessories	
Voltage	12 V
Maximum current consumption	10 A

16.4 Removing 12-V battery ↻



Warning

Risk of injury Battery acid and battery gases cause serious chemical burns.

- Keep 12 V batteries out of the reach of children.
- Wear suitable protective clothing and safety glasses.
- Avoid contact with battery acid and battery gases.
- Keep sparks or open flames away from the 12 V battery.
- Only charge 12 V batteries in well-ventilated rooms.
- Rinse the affected area immediately with plenty of water in the event of contact with the skin.
- Rinse eyes with water for at least 15 minutes and consult a doctor immediately if battery acid and battery gases get into the eyes.





Caution

Danger of accidents Electronic components and safety devices will be damaged if the 12-V battery is discharged or missing.

- Never operate the vehicle with a discharged 12-V battery or without a 12-V battery.

Preparatory work

- Switch off ignition – to do this, briefly press the RACE-ON button  (maximum of 1 second) with the ignition switched on.
- Remove the passenger seat. ( p. 192)
- Remove the front rider's seat. ( p. 193)

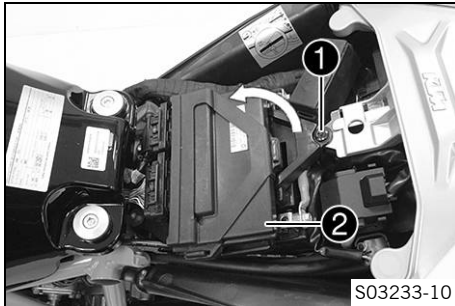

Main work

- Remove screw ①.
- Lift cover ② at the rear and pull toward the rear.
- Fold up cover.

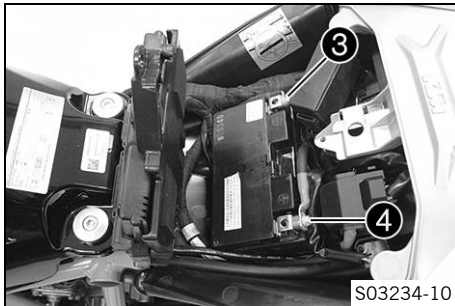

- Disconnect negative cable ③ from the 12-V battery.

i Info

To prevent damage to the onboard electronics, first disconnect the negative cable from the 12-V battery.

- Disconnect positive cable ④ from the 12-V battery.
- Take 12-V battery out of the battery compartment.

16.5 Installing the 12-V battery ↴



Warning

Risk of injury Battery acid and battery gases cause serious chemical burns.

- Keep 12 V batteries out of the reach of children.
- Wear suitable protective clothing and safety glasses.
- Avoid contact with battery acid and battery gases.
- Keep sparks or open flames away from the 12 V battery.
- Only charge 12 V batteries in well-ventilated rooms.
- Rinse the affected area immediately with plenty of water in the event of contact with the skin.
- Rinse eyes with water for at least 15 minutes and consult a doctor immediately if battery acid and battery gases get into the eyes.



Caution

Danger of accidents Electronic components and safety devices will be damaged if the 12-V battery is discharged or missing.

- Never operate the vehicle with a discharged 12-V battery or without a 12-V battery.

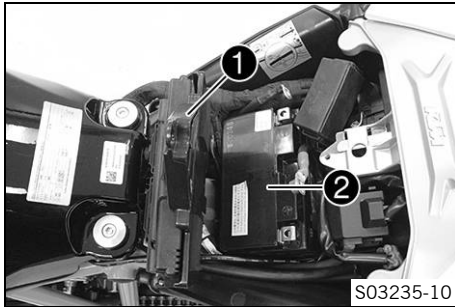

Main work

- Fold up cover ①.
- Insert 12-V battery ② into the battery compartment.

12-V battery (YTZ14S) (📖 p. 320)

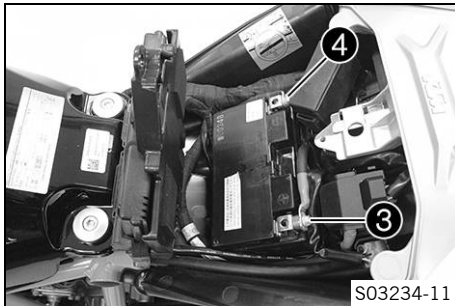

- Position positive cable ③, mount and tighten screw.

Guideline

Screw, battery terminal	M6	4.5 Nm (3.32 lbf ft)
-------------------------	----	-------------------------

i Info

To prevent damage to the onboard electronics, first connect the positive cable to the 12-V battery.

- Position negative cable ④, mount and tighten screw.

Guideline

Screw, battery terminal	M6	4.5 Nm (3.32 lbf ft)
-------------------------	----	-------------------------

16 ELECTRICAL SYSTEM

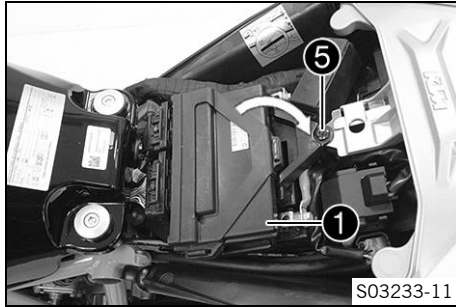

- Fold down cover ①.
- Mount and tighten screw ⑤.

Guideline

Remaining screws, chassis	M5	5 Nm (3.7 lbf ft)
------------------------------	----	-------------------

Finishing work

- Mount the front rider's seat. (📖 p. 195)
- Mount passenger seat. (📖 p. 193)
- Set time and date.



16.6 Charging the 12-V battery ↴



Warning

Risk of injury Battery acid and battery gases cause serious chemical burns.

- Keep 12 V batteries out of the reach of children.
- Wear suitable protective clothing and safety glasses.
- Avoid contact with battery acid and battery gases.
- Keep sparks or open flames away from the 12 V battery.
- Only charge 12 V batteries in well-ventilated rooms.
- Rinse the affected area immediately with plenty of water in the event of contact with the skin.
- Rinse eyes with water for at least 15 minutes and consult a doctor immediately if battery acid and battery gases get into the eyes.



Note

Environmental hazard 12 V batteries contain environmentally hazardous materials.

- Do not dispose of 12 V batteries as household waste.
- Dispose of 12 V batteries at a collection point for used batteries.



Note

Environmental hazard Hazardous substances cause environmental damage.

- Dispose of oils, grease, filters, fuel, cleaning agents, brake fluid, etc., correctly and in compliance with the applicable regulations.

i Info

Even if there is no load on the 12-V battery, it discharges steadily each day.

The charging level and the method of charging are very important for the service life of the 12-V battery. Rapid recharging with a high charging current shortens the service life of the battery.

If the charging current, charging voltage, or charging time is exceeded, electrolyte escapes through the safety valves. This reduces the capacity of the 12-V battery.



If the 12-V battery is depleted by repeated starting, the 12-V battery must be charged immediately.

If the 12-V battery is left in a discharged state for an extended period, it will become deeply discharged and sulfating occurs, destroying the battery.

The 12-V battery is maintenance-free. The acid level does not have to be checked.

If the 12-V battery is not charged by the KTM battery charger, the 12-V battery must be removed for charging. Otherwise, overvoltage may damage electronic components. Charge the 12-V battery according to the instructions on the battery housing.

Preparatory work

- Switch off ignition – to do this, briefly press the RACE-ON button  (maximum of 1 second) with the ignition switched on.
- Remove the passenger seat. ( p. 192)
- Remove the front rider's seat. ( p. 193)

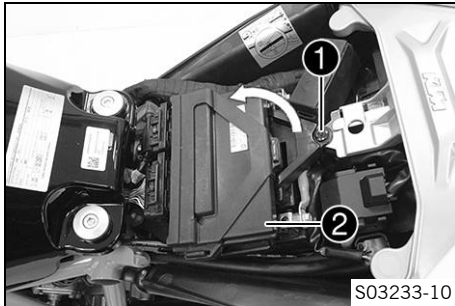

Main work

- Remove screw ①.
- Lift cover ② at the rear and pull toward the rear.
- Fold up cover.

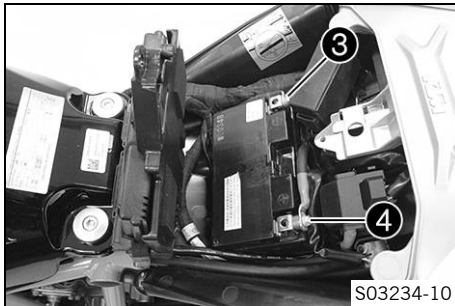

- Disconnect negative cable ③ from the 12-V battery.



Info

If the negative cable remains connected to the 12-V battery, damage to the onboard electronics is possible.

- Disconnect positive cable ④ from the 12-V battery.



- Connect battery charger to the 12-V battery.

Battery charger (58429074000)

You can also use the battery charger to test the open-circuit voltage and starting ability of the 12-V battery, and to test the alternator. In addition, you cannot overcharge the 12-V battery with this device.



Info

Charge the 12-V battery to a maximum of 10 % of the capacity specified on the battery housing.

- Switch on battery charger.

Guideline

The charging current, charging voltage, and charging time must not be exceeded.

Recharge the 12-V battery regularly when the motorcycle is not being used

3 months

- Switch off battery charger after charging and disconnect from the 12-V battery.

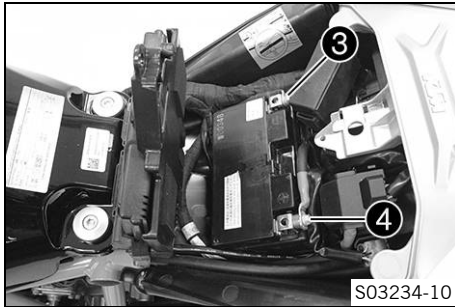

- Mount and tighten positive cable ④.
- Position negative cable ③; mount and tighten the screw.

Guideline

Screw, battery terminal	M6	4.5 Nm (3.32 lbf ft)
-------------------------	----	-------------------------

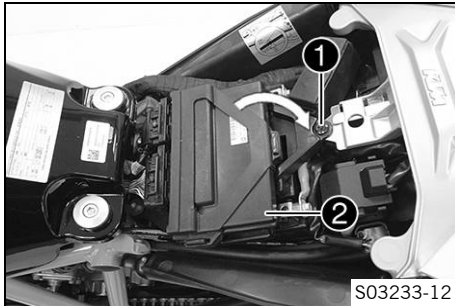

- Fold down cover ②.
- Mount and tighten screw ①.

Guideline

Remaining screws, chassis	M5	5 Nm (3.7 lbf ft)
---------------------------	----	-------------------

Finishing work

- Mount the front rider's seat. (📖 p. 195)
- Mount passenger seat. (📖 p. 193)
- Set time and date.



16.7 Changing the RACE-ON key battery

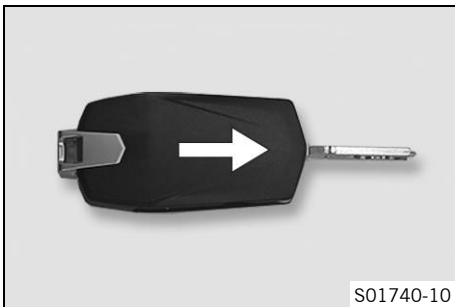

- Fold out the key bit of the RACE-ON key.
- Push lower half of the RACE-ON key in the direction of the arrow and take off.

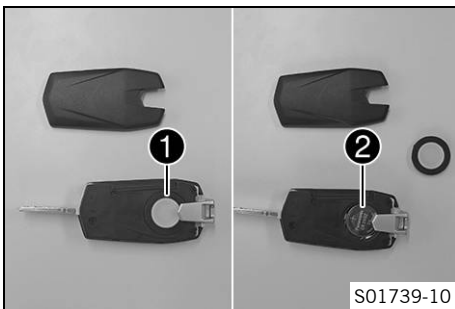

- Remove battery cover ❶.
- Remove RACE-ON key battery ❷.
- Insert new the RACE-ON key battery with label facing upward.

RACE-ON key battery (CR 2032) (📖 p. 320)

- Mount battery cover ❶.

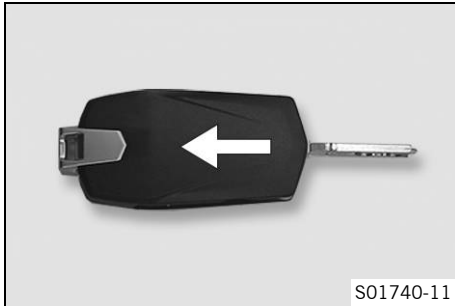

- Fit lower half of the RACE-ON key and snap into place in the direction of the arrow.



16.8 Changing the main fuse





Warning

Fire hazard Incorrect fuses overload the electrical system.

- Only use fuses with the required ampere value.
- Do not bypass or repair fuses.

Preparatory work

- Switch off ignition – to do this, briefly press the RACE-ON button  (maximum of 1 second) with the ignition switched on.
- Remove the passenger seat. ( p. 192)
- Remove the front rider's seat. ( p. 193)

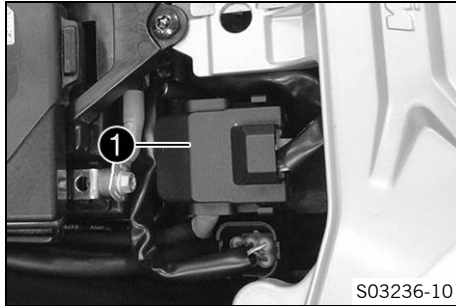

Main work

- Remove protection cap **1**.

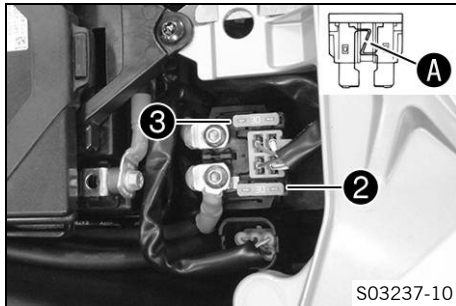

- Remove faulty main fuse **2**.

i Info

A faulty fuse has a burned-out fuse wire **A**.

A spare fuse **3** is located in the starter relay.
The main fuse protects all power consumers of the vehicle.

- Insert new main fuse.

Fuse (58011109130) (📖 p. 321)

- Check that the electrical system is functioning properly.
- Mount protection cap.

**Tip**

Insert a new spare fuse into the starter relay to have it available when needed.

Finishing work

- Mount the front rider's seat. (📖 p. 195)
- Mount passenger seat. (📖 p. 193)
- Set time and date.



16.9 Changing the fuses in the fuse box

**Warning**

Fire hazard Incorrect fuses overload the electrical system.

- Only use fuses with the required ampere value.
- Do not bypass or repair fuses.

**Info**

The fuse box containing the fuses of individual power consumers is located under the seat.

Preparatory work

- Switch off ignition – to do this, briefly press the RACE-ON button  (maximum of 1 second) with the ignition switched on.
- Remove the passenger seat. (📖 p. 192)

16 ELECTRICAL SYSTEM

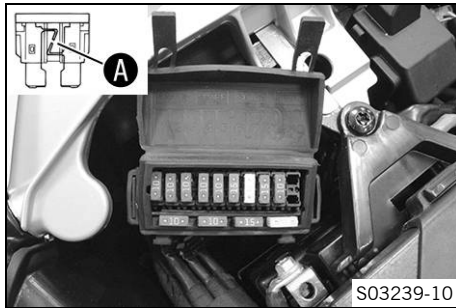
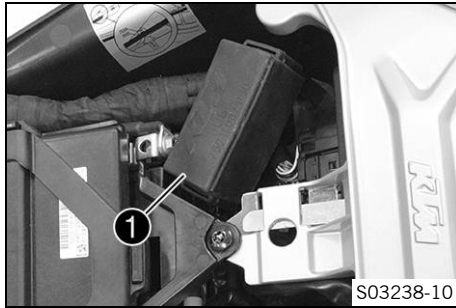

- Remove the front rider's seat. (📖 p. 193)

Main work

- Open fuse box cover ❶.

- Check the fuses.



Info

A faulty fuse has a burned-out fuse wire **A**.

- Remove the faulty fuse.

Guideline

Fuse 1 - 10 A - KTM RACE ON, combination instrument, alarm system (optional)
Fuse 2 - 10 A - ACC 1
Fuse 3 - 10 A - tail light, license plate lamp, lighting for combination switch
Fuse 4 - 10 A - headlight control unit
Fuse 5 - 10 A - engine control unit, evaporate emission control system, lambda sensors, SAS, ignition coils, injection valves
Fuse 6 - 15 A - semi-active chassis, cornering light
Fuse 7 - 25 A - ABS return pump
Fuse 8 - 15 A - ABS hydraulic unit
Fuse 9 - 10 A - ACC 2
Fuses Spare - 10 A - Reserve
Fuse Spare - 15 A - Reserve
Fuse Spare - 25 A - Reserve

- Insert the spare fuse with the correct rating.

Fuse (58011109110) (🔍 p. 321)
Fuse (58011109115) (🔍 p. 321)
Fuse (58011109125) (🔍 p. 321)



Tip

Insert a spare fuse so that it is available if needed.

- Check that the power consumer is functioning properly.
- Close the fuse box cover.

Finishing work

- Mount the front rider's seat. (📖 p. 195)
- Mount passenger seat. (📖 p. 193)

16.10 Checking the setting of the lighting system

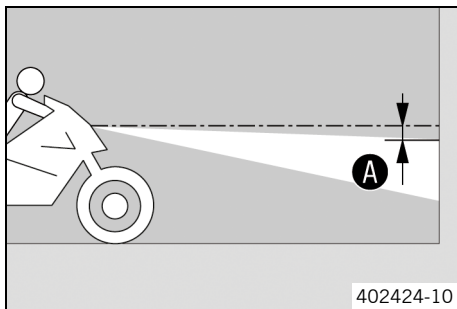

- Park vehicle on a horizontal surface in front of a light-colored wall and make a mark at the height of the center of the low beam headlight.
- Make a second mark at a distance **A** under the first mark.

Guideline

Distance **A**

5 cm (2 in)

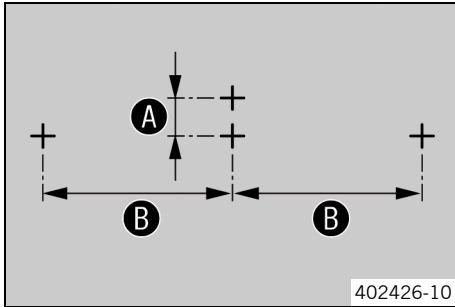

- Make two further marks spaced apart **B** to the left and the right of the second marking.

Guideline

Distance B	37 cm (14.6 in)
-------------------	-----------------

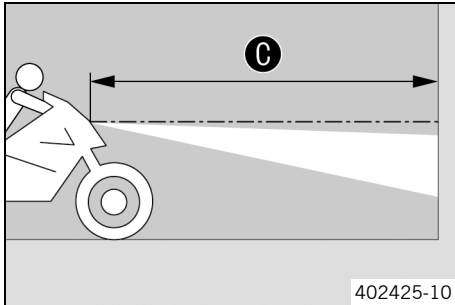

- Position the vehicle perpendicular to the wall at a distance **C** from the wall and switch on the low beam.

Guideline

Distance C	5 m (16 ft)
-------------------	-------------

- The rider now mounts the motorcycle with luggage and passenger if applicable.
- Check the headlight setting.

The light-dark boundary of the low beam must lie exactly on the lower mark when the motorcycle is ready for operation with the rider mounted along with any luggage and a passenger if applicable.

- » If the boundary between light and dark does not meet specifications:
 - Adjust headlight range. (📖 p. 272)
- Press **SET** button when the menu is closed.

- Press **UP** or **DOWN** button until **Settings** is marked.
Press **SET** button to open the menu.
- Press **UP** or **DOWN** button until **Corner. Light Test** is marked.
Press **SET** button to open the menu.
- Activate menu item using the **UP** or **DOWN** button.

 **Info**

The test is performed on the left cornering light in the menu item **Left**.
The test is performed on the right cornering light in the menu item **Right**.
The test is ended in the menu item **Off**.

-
- Press **SET** button, in order to perform the required test.

 **Info**

The respective cornering light segments light up in succession, starting with the lower segment.
When the test of the respective cornering light is complete, the upper segment lights up continuously.

-
- Select left cornering light test and wait for a few seconds until the upper segment of the left cornering light lights up continuously.

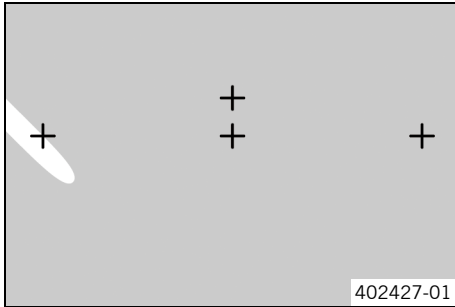

- Check left cornering light setting.

The light-dark boundary of the upper left segment must run exactly through the left marking.

- » If the boundary between light and dark does not meet specifications:
 - Adjust cornering light range. (📖 p. 273)
- Press the **UP** or **DOWN** button to select the **Off** menu item and press the **SET** button to confirm the test.
- Select right cornering light test and wait for a few seconds until the upper segment of the right cornering light lights up continuously.

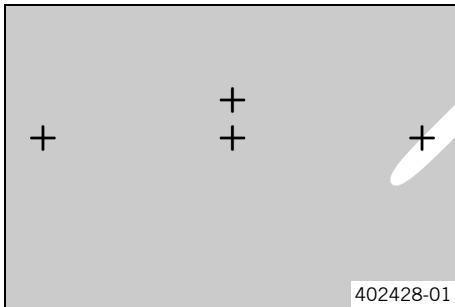

- Check right cornering light setting.

The light-dark boundary of the upper right segment must run exactly through the right marking.

- » If the boundary between light and dark does not meet specifications:
 - Adjust cornering light range. (📖 p. 273)
- Press the **UP** or **DOWN** button to select the **Off** menu item and press the **SET** button to confirm the test.



16.11 Adjusting the headlight range

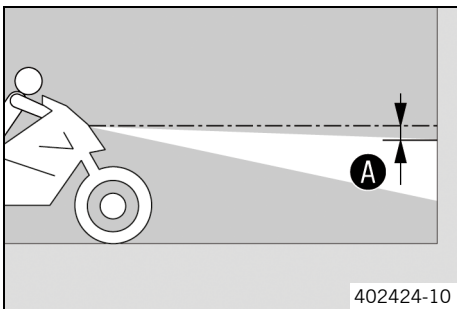
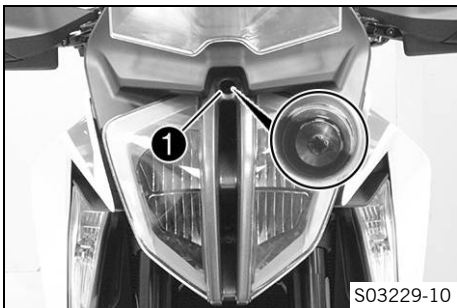

Preparatory work

- Check setting of the lighting system. (📖 p. 268)

Main work

- Turn adjusting screw ① to adjust the headlight range.

Info

Turn clockwise to increase the headlight range; turn counterclockwise to reduce the headlight range. If you have a payload, you may have to correct the headlight range.

- Set headlight to marking ①.

Guideline

The light-dark boundary must lie exactly on lower marking ① when the motorcycle is ready to operate with the rider mounted along with any luggage and a passenger if applicable.

16.12 Adjusting the cornering light range

Preparatory work

- Check setting of the lighting system. (📖 p. 268)

Main work

- Press **SET** button when the menu is closed.
- Press **UP** or **DOWN** button until **Settings** is marked.
Press **SET** button to open the menu.
- Press **UP** or **DOWN** button until **Corner. Light Test** is marked.
Press **SET** button to open the menu.
- Activate menu item using the **UP** or **DOWN** button.



Info

The test is performed on the left cornering light in the menu item **Left**.

The test is performed on the right cornering light in the menu item **Right**.

The test is ended in the menu item **Off**.

-
- Press **SET** button, in order to perform the required test.

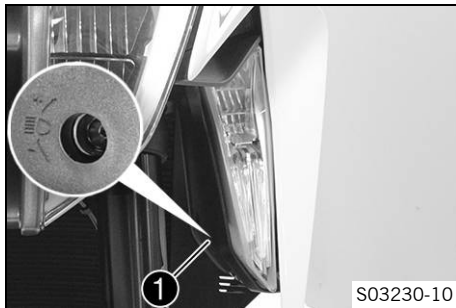

Info

The respective cornering light segments light up in succession, starting with the lower segment.

When the test of the respective cornering light is complete, the upper segment lights up continuously.

- Select left cornering light test and wait for a few seconds until the upper segment of the cornering light lights up continuously.
- Turn adjusting screw **1** to adjust the left cornering light range.

Guideline

Carefully turn the adjusting screw; do not use force to avoid damaging the adjuster mechanism.

Adjusting screw torque	$\leq 0.25 \text{ Nm}$ ($\leq 0.184 \text{ lbf ft}$)
------------------------	--



Info

Turn clockwise to increase the headlight range; turn counterclockwise to reduce the headlight range.

If you have a payload, you may have to correct the headlight range.

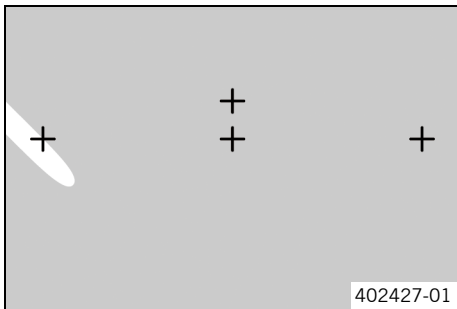

- Set upper segment on the left marking.

Guideline

The light-dark boundary of the upper segment must run exactly through the left marking.

- Press **UP** or **DOWN** button to select the menu item **Off** and press **SET** button to confirm the test.
- Select right cornering light test and wait for a few seconds until the upper segment of the cornering light lights up continuously.

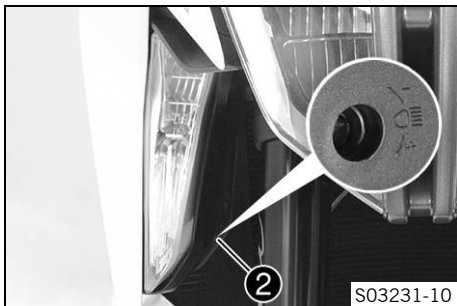

- Turn adjusting screw ② to adjust the right cornering light range.

Guideline

Carefully turn the adjusting screw; do not use force to avoid damaging the adjuster mechanism.

Adjusting screw torque	$\leq 0.25 \text{ Nm } (\leq 0.184 \text{ lbf ft})$
------------------------	---

i Info

Turn clockwise to increase the headlight range; turn counterclockwise to reduce the headlight range. If you have a payload, you may have to correct the headlight range.

16 ELECTRICAL SYSTEM

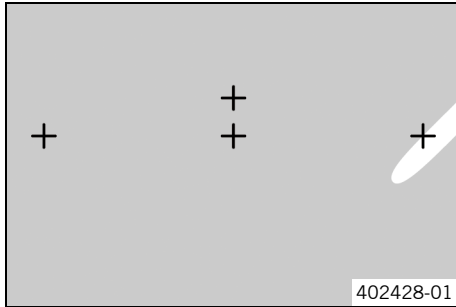

- Set upper segment on the left marking.

Guideline

The light-dark boundary of the upper segment must run exactly through the right marking.

- Press **UP** or **DOWN** button to select the menu item **Off** and press **SET** button to confirm the test.

16.13 Diagnostics connector

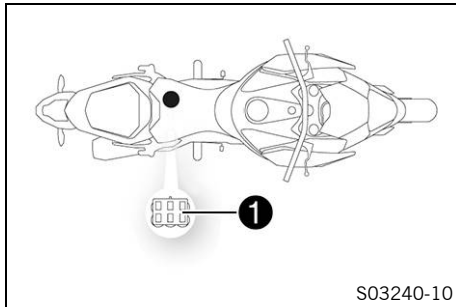

Diagnostics connector ① is located under the front rider's seat.

16.14 Front ACC1 and ACC2

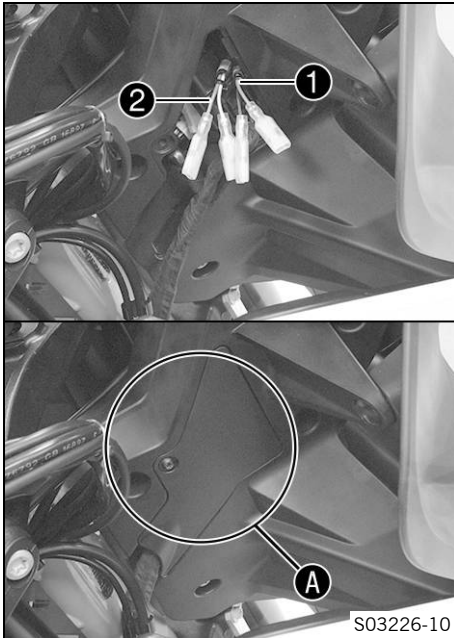

The front power supplies ACC1 ① and ACC2 ② are located on the right side of the instrument support behind a cover A.

16 ELECTRICAL SYSTEM

16.15 ACC1 and ACC2 rear

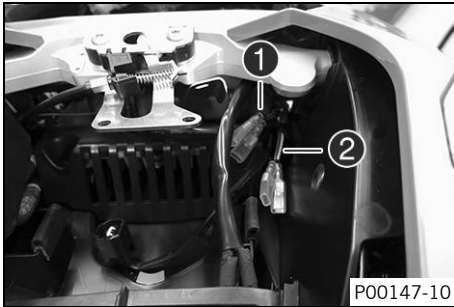

The rear power supplies ACC1 ① and ACC2 ② are located on the right next to the passenger seat lock.

17.1 Checking the coolant level in the compensating tank



Warning

Danger of scalding During motorcycle operation, the coolant gets very hot and is under pressure.

- Do not open the radiator, the radiator hoses or other cooling system components if the engine or the cooling system are at operating temperature.
- Allow the cooling system and the engine to cool down before you open the radiator, the radiator hoses or other components of the cooling system.
- In the event of scalding, rinse the area affected immediately with lukewarm water.



Warning

Danger of poisoning Coolant is toxic and a health hazard.

- Keep coolant out of the reach of children.
- Do not allow coolant to come into contact with the skin, the eyes and clothing.
- Consult a doctor immediately if coolant is swallowed.
- Rinse the affected area immediately with plenty of water in the event of contact with the skin.
- Rinse eyes thoroughly with water and consult a doctor immediately if coolant gets into the eyes.
- Change clothing if coolant spills onto your clothing.

Condition

The engine is cold.

The radiator is completely full.

17 COOLING SYSTEM

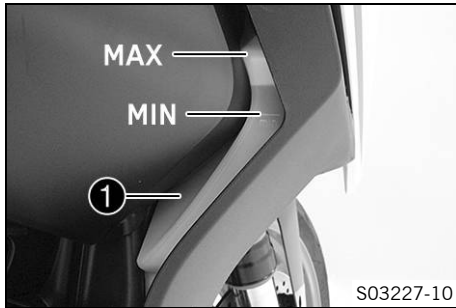

- Stand motorcycle upright on a horizontal surface.
- Check coolant level in compensating tank ❶ on the right-hand side.

The coolant level must be between **MIN** and **MAX**.

- » If there is no coolant in the compensating tank:
 - Check the cooling system for leaks. 🛠️



Info

Do not start up the motorcycle!

- Add the coolant/bleed the cooling system. 🛠️
- » If the coolant level in the compensating tank is not at the required level, but the tank is not empty:
 - Correct the coolant level in the compensating tank. (📖 p. 281)

17.2 Correcting the coolant level in the compensating tank



Warning

Danger of scalding During motorcycle operation, the coolant gets very hot and is under pressure.

- Do not open the radiator, the radiator hoses or other cooling system components if the engine or the cooling system are at operating temperature.
- Allow the cooling system and the engine to cool down before you open the radiator, the radiator hoses or other components of the cooling system.
- In the event of scalding, rinse the area affected immediately with lukewarm water.



Warning

Danger of poisoning Coolant is toxic and a health hazard.

- Keep coolant out of the reach of children.
- Do not allow coolant to come into contact with the skin, the eyes and clothing.
- Consult a doctor immediately if coolant is swallowed.
- Rinse the affected area immediately with plenty of water in the event of contact with the skin.
- Rinse eyes thoroughly with water and consult a doctor immediately if coolant gets into the eyes.
- Change clothing if coolant spills onto your clothing.

Condition

The engine is cold.

The radiator is completely full.

Preparatory work

- Check coolant level in the compensating tank. (📖 p. 279)

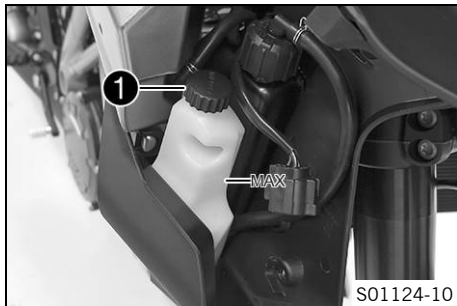

Main work

- Remove fuel tank spoiler. (📖 p. 214)



Info

Only disassemble the right-hand side.

- Remove cover **1** of the compensating tank.
- Add coolant to the **MAX** marking.

Coolant (📖 p. 333)

- Mount cover **1** of the compensating tank.

Finishing work

- Install fuel tank spoiler. (📖 p. 215)

18.1 Ride Mode

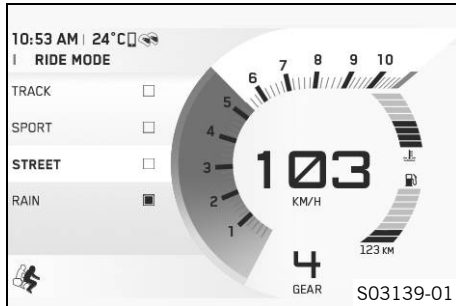

Possible states

- **TRACK** – Optional setting available with homologated performance and extremely direct response. The motorcycle traction control and the characteristic map of the throttle response can be individually set.
- **SPORT** – Homologated performance with very direct response; the motorcycle traction control allows greater slip on the rear wheel.
- **STREET** – Homologated performance with balanced response; the motorcycle traction control allows normal slip on the rear wheel.
- **RAIN** – Homologated performance with soft response for improved rideability; the motorcycle traction control allows normal slip on the rear wheel

Various vehicle tunings can be selected in the **Ride Mode** menu. There is **TRACK** (optional), **SPORT**, **STREET** and **RAIN**. The drive mode selected last appears in the display. The drive mode can also be changed while riding with a closed throttle grip and deactivated speed sensor.

Info

The drive mode selection does not influence the ABS.

18.2 Motorcycle traction control (MTC)

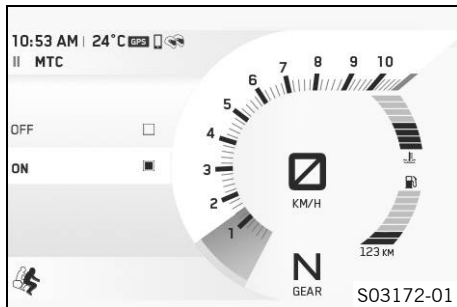

The motorcycle traction control (MTC) lowers the engine torque in case of loss of traction in the rear wheel.

i Info

When motorcycle traction control is switched off, the rear wheel may spin during strong acceleration and on surfaces with low grip, resulting in a risk of crashing. After the ignition is switched on, motorcycle traction control is enabled again.

The motorcycle traction control is controlled via the "**Motorcycle**" (🔧 p. 79) menu in the combination instrument. Motorcycle traction control can be switched off in the "**MTC**" menu.

i Info

When the motorcycle traction control is active, the TC indicator lamp 🚦 flashes. When motorcycle traction control is switched off, the TC indicator lamp 🚦 lights up.

18.3 Slip adjustment (optional)

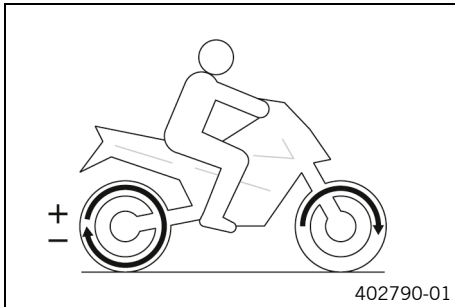

The slip adjustment is an optional motorcycle traction control function.

The slip adjustment allows the motorcycle traction control to be tuned through nine levels to the desired characteristic map.

Level 1 allows the maximum slip on the rear wheel, and level 9 the minimum.

The slip adjustment can be set while riding with a closed menu using the **UP** or **DOWN** button.

i **Info**

The slip adjustment is only available if drive mode **TRACK** (📖 p. 283) (optional) is active.

18.4 Throttle Response (optional)

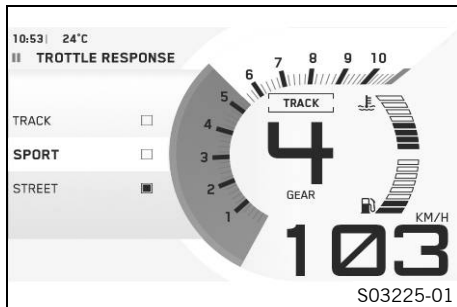

Possible states

- TRACK – Extremely direct response
- SPORT – Very direct response
- STREET – Balanced response

The characteristic map of the throttle response can be adjusted in the **TRACK** menu under **Throttle Response**.

The **Throttle Response** can also be set while riding with a closed throttle grip and deactivated speed sensor.



Info

Throttle Response is only available if drive mode **TRACK** (📖 p. 283) (optional) is active.

19.1 Checking the engine oil level



Info

Oil consumption depends on the riding style and the operating conditions.

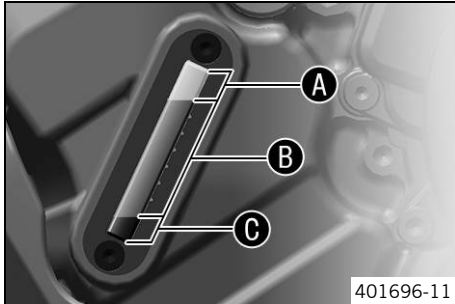

Condition

The engine is at operating temperature.

Preparatory work

- Stand the motorcycle upright on a horizontal surface.

Main work

- Check the engine oil level in the engine oil level viewer.



Info

After switching off the engine, wait one minute before checking the level.

The engine oil level should be in the upper area **B** of the engine oil level viewer.

- » When the engine oil level is in area **A** of the engine oil level viewer:
 - Do not add engine oil.
- » When the engine oil level is in area **B** of the engine oil level viewer:
 - Engine oil can be added.

- » When the engine oil level is in area **C** of the engine oil level viewer:
 - Add engine oil. (🔧 p. 296)

19.2 Changing the engine oil and oil filter, cleaning the oil screens 🛠️



Warning

Danger of scalding Engine and gear oil get very hot when the motorcycle is ridden.

- Wear suitable protective clothing and safety gloves.
- In the event of scalding, rinse the area affected immediately with lukewarm water.



Note

Environmental hazard Hazardous substances cause environmental damage.

- Dispose of oils, grease, filters, fuel, cleaning agents, brake fluid, etc., correctly and in compliance with the applicable regulations.

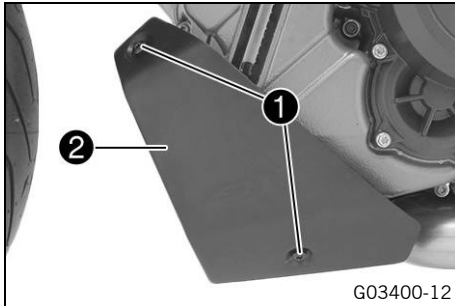

Main work

- Place the motorcycle on a horizontal surface using the side stand.
- Remove screws ①.
- Take off plate ②.

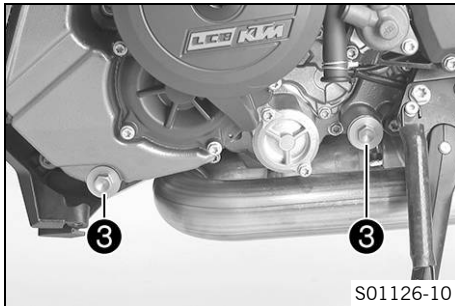

- Position an appropriate container under the engine.
- Remove oil drain plugs ③ with the magnets, the O-rings, and the oil screens.

19 SERVICE WORK ON THE ENGINE

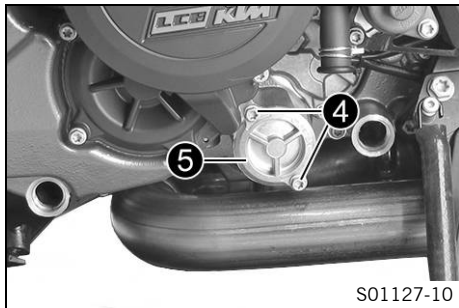

- Remove screws ④. Take off oil filter cover ⑤ with the O-ring.

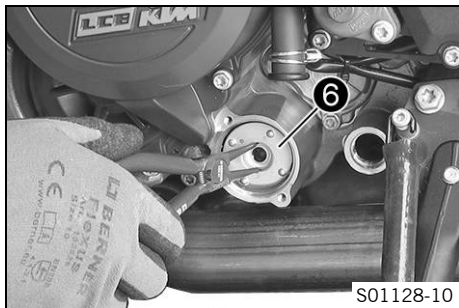

- Pull oil filter ⑥ out of the oil filter housing.

Lock ring plier (51012011000)

- Allow the engine oil to drain completely.
- Thoroughly clean the parts and the sealing surfaces.

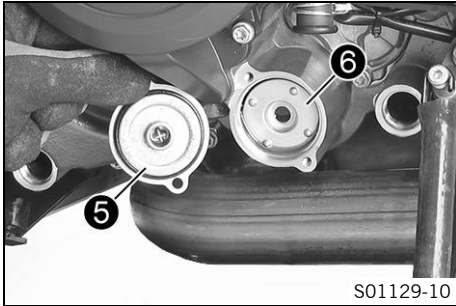

- Insert new oil filter **6**.

i Info
Only insert the oil filter by hand.

- Oil the O-ring of the oil filter cover. Mount oil filter cover **5**.

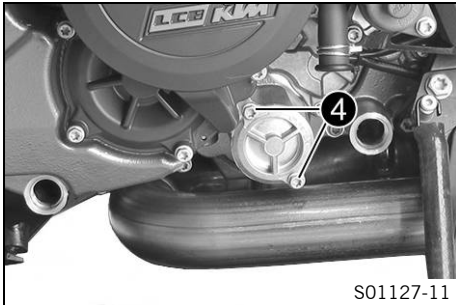

- Mount and tighten screws **4**.

Guideline

Remaining engine screws	M5	6 Nm (4.4 lbf ft)
-------------------------	----	-------------------

19 SERVICE WORK ON THE ENGINE

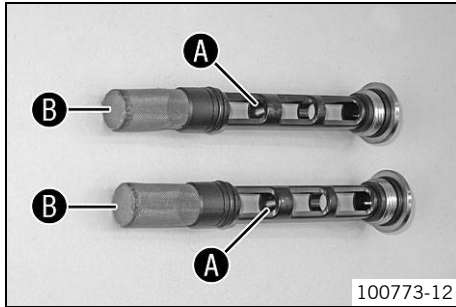

- Thoroughly clean magnets **A** and oil screens **B** of the oil drain plugs.

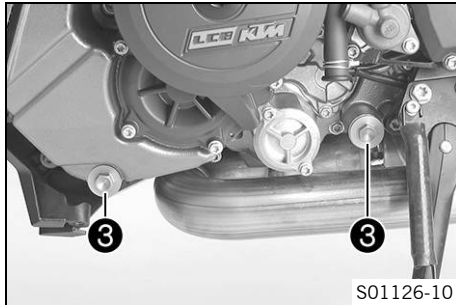

- Mount and tighten oil drain plugs **3** with magnets, O-rings, and oil screens.

Guideline

Oil drain plug	M20x1.5	20 Nm (14.8 lbf ft)
----------------	---------	---------------------

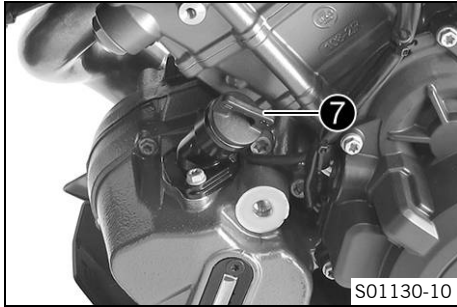

- Have the entire filling quantity available.

Engine oil Ambient temperature: $\geq 0\text{ }^{\circ}\text{C}$ ($\geq 32\text{ }^{\circ}\text{F}$)	3.50 l (3.7 qt.)	Engine oil (SAE 10W/50) (📖 p. 334)
Engine oil Ambient temperature: $< 0\text{ }^{\circ}\text{C}$ ($< 32\text{ }^{\circ}\text{F}$)		Engine oil (SAE 5W/40) (📖 p. 335)

- Add the oil quantity in two steps.
- Remove filler plug **7** with the O-ring, and fill up with the first partial quantity.

Engine oil (1st partial quantity) approx. Ambient temperature: $\geq 0\text{ }^{\circ}\text{C}$ ($\geq 32\text{ }^{\circ}\text{F}$)	3.0 l (3.2 qt.)	Engine oil (SAE 10W/50) (📖 p. 334)
Engine oil (1st partial quantity) approx. Ambient temperature: $< 0\text{ }^{\circ}\text{C}$ ($< 32\text{ }^{\circ}\text{F}$)		Engine oil (SAE 5W/40) (📖 p. 335)

- Mount filler plug **7** with the O-ring.



Danger

Danger of poisoning Exhaust gases are toxic and inhaling them may result in unconsciousness and death.

- Always make sure there is sufficient ventilation when running the engine.
- Use effective exhaust extraction when starting or running the engine in an enclosed space.

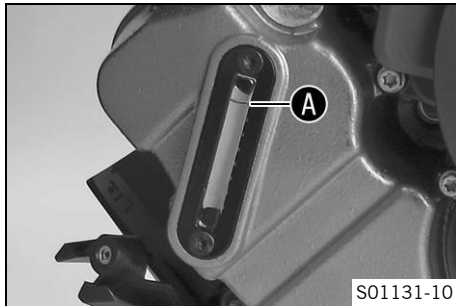

- Start the engine and check for tightness.
- Switch off the engine.
- Remove the filler plug with the O-ring and add the second partial quantity up to the upper marking **A** on the engine oil level viewer.

Engine oil (2nd partial quantity) approx. Ambient temperature: $\geq 0\text{ }^{\circ}\text{C}$ ($\geq 32\text{ }^{\circ}\text{F}$)	0.50 l (0.53 qt.)	Engine oil (SAE 10W/50) (📖 p. 334)
Engine oil (2nd partial quantity) approx. Ambient temperature: $< 0\text{ }^{\circ}\text{C}$ ($< 32\text{ }^{\circ}\text{F}$)		Engine oil (SAE 5W/40) (📖 p. 335)

- Mount the filler plug with the O-ring.



Danger

Danger of poisoning Exhaust gases are toxic and inhaling them may result in unconsciousness and death.

- Always make sure there is sufficient ventilation when running the engine.
- Use effective exhaust extraction when starting or running the engine in an enclosed space.

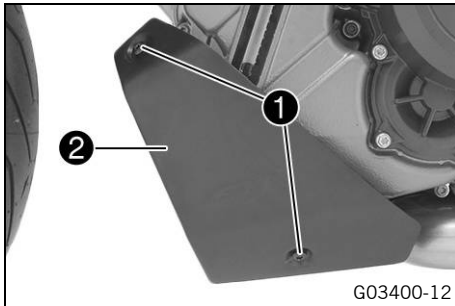

- Start the engine and check for tightness.
- Switch off the engine.
- Position plate ②.
- Mount and tighten screws ①.

Guideline

Remaining screws, chassis	M5	5 Nm (3.7 lbf ft)
---------------------------	----	-------------------

Finishing work

- Check the engine oil level. (📖 p. 287)



19.3 Adding engine oil



Info

Too little engine oil or poor-quality engine oil results in premature wear to the engine. The engine may be damaged if the engine oil level is too high.

Condition

The engine is at operating temperature.

Preparatory work

- Stand the motorcycle upright on a horizontal surface.
- Check the engine oil level. (📖 p. 287)

Main work

- Remove filler plug **1** with the O-ring.

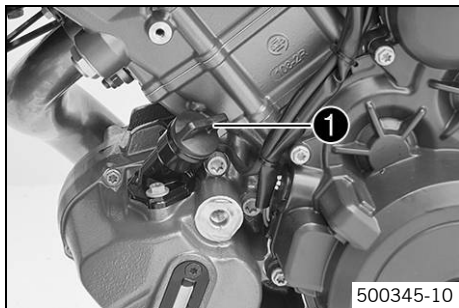

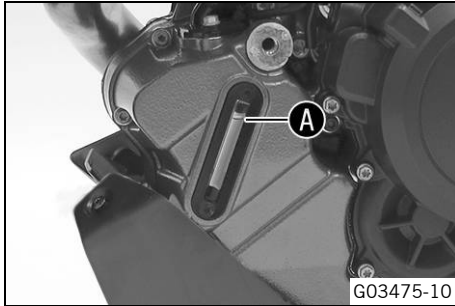

- Add the engine oil to upper marking **A** on the engine oil level viewer.

Condition

Ambient temperature: $\geq 0\text{ }^{\circ}\text{C}$ ($\geq 32\text{ }^{\circ}\text{F}$)

Engine oil (SAE 10W/50) (📖 p. 334)

Condition

Ambient temperature: $< 0\text{ }^{\circ}\text{C}$ ($< 32\text{ }^{\circ}\text{F}$)

Engine oil (SAE 5W/40) (📖 p. 335)



Info

In order to achieve optimal engine oil performance, it is not advisable to mix different engine oils. KTM recommends changing the engine oil.

- Mount the filler plug with the O-ring.



Danger

Danger of poisoning Exhaust gases are toxic and inhaling them may result in unconsciousness and death.

- Always make sure there is sufficient ventilation when running the engine.
- Use effective exhaust extraction when starting or running the engine in an enclosed space.

- Start the engine and check for tightness.

19 SERVICE WORK ON THE ENGINE

Finishing work

- Check the engine oil level. (📖 p. 287)



20.1 Cleaning the motorcycle

Note

Material damage Components become damaged or destroyed if a pressure cleaner is used incorrectly.

The high pressure forces water into the electrical components, connectors, throttle cables, and bearings, etc. Pressure which is too high causes malfunctions and destroys components.

- Do not direct the water jet directly on to electrical components, connectors, throttle cables or bearings.
- Maintain a minimum distance between the nozzle of the pressure cleaner and the component.

Minimum clearance 60 cm (23.6 in)



Note

Environmental hazard Hazardous substances cause environmental damage.

- Dispose of oils, grease, filters, fuel, cleaning agents, brake fluid, etc., correctly and in compliance with the applicable regulations.
-



Info

Clean the motorcycle regularly to maintain its value and appearance over a long period.
Avoid direct sunshine when cleaning the motorcycle.

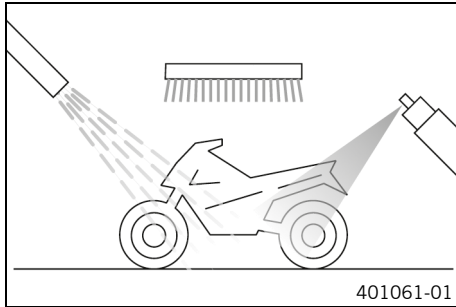

- Close off exhaust system to keep water from entering.
- Remove coarse dirt particles with a gentle water jet.
- Spray heavily soiled parts with a normal commercial motorcycle cleaner and then brush off with a soft brush.

Motorcycle cleaner (📖 p. 337)



Info

Use warm water containing normal motorcycle cleaner and a soft sponge.
Never apply motorcycle cleaner to a dry vehicle; always rinse the vehicle with water first.
If the vehicle has been used on salted roads, use cold water for cleaning after riding. Warm water enhances the corrosive effects of salt.

- After rinsing the motorcycle with a gentle spray of water, allow it to dry thoroughly.
- Remove the closure of the exhaust system.



Warning

Danger of accidents Moisture and dirt impair the brake system.

- Brake carefully several times to dry out and remove dirt from the brake linings and the brake discs.

- After cleaning, ride the vehicle a short distance until the engine warms up.



Info

The heat produced causes water at inaccessible locations in the engine and on the brake system to evaporate.

-
- Push back the protection caps of the handlebar controls to allow any water that has penetrated to evaporate.
 - After the motorcycle has cooled down, lubricate all moving parts and pivot points.
 - Clean the chain. (📖 p. 201)
 - Treat bare metal (except for brake discs and the exhaust system) with a corrosion inhibitor.

Preserving materials for paints, metal and rubber
(📖 p. 338)

- Treat the painted parts with a mild paint polish.

Perfect finish and high gloss polish for paints (📖 p. 337)



Info

Do not polish parts that were matte when delivered as this would strongly impair the material quality.

- Treat the plastic parts and powder-coated parts with a mild cleaning and care product.

Special cleaner for glossy and matte paint finishes, metal and plastic surfaces (📖 p. 338)

- Oil steering lock and seat lock.

Universal oil spray (📖 p. 338)

20.2 Checks and maintenance steps for winter operation

i Info

If you use the motorcycle in winter, you must expect salt on the roads. You should therefore take precautions against aggressive road salt.

If the vehicle has been used on salted roads, use cold water for cleaning after riding. Warm water enhances the corrosive effects of salt.

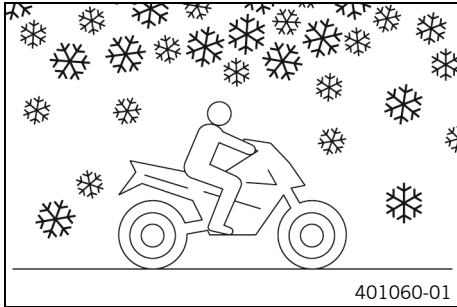

- Clean motorcycle. (📖 p. 299)
- Clean the brakes.



Info

After **EVERY** trip on salted roads, thoroughly clean the brake calipers and brake linings, after they have cooled down and without removing them, with cold water and dry them carefully.

After riding on salted roads, thoroughly clean the motorcycle with cold water and dry it well.

- Treat the engine, the link fork, and all other bare or zinc-plated parts (except the brake discs) with a wax-based corrosion inhibitor.



Info

Corrosion inhibitor must not come into contact with the brake discs. This would severely lower the braking effect.

- Clean the chain. (📖 p. 201)



21.1 Storage

i Info

If you plan to garage the motorcycle for a longer period, perform the following steps or have them performed.

Before storing the motorcycle, check all parts for function and wear. If service, repairs, or replacements are necessary, you should do this during the storage period (less workshop overload). In this way, you can avoid long workshop waiting times at the start of the new season.

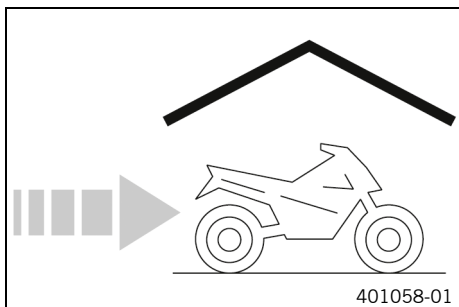

- When refueling for the last time before taking the motorcycle out of service, add fuel additive.

Fuel additive (📖 p. 337)

- Refuel. (📖 p. 180)
- Clean motorcycle. (📖 p. 299)
- Change the engine oil and the oil filter, clean the oil screens. 🛠️ (📖 p. 288)
- Check the coolant fill level and antifreeze. 🛠️
- Check tire pressure. (📖 p. 246)
- Remove 12-V battery. 🛠️ (📖 p. 252)

Guideline

Storage temperature of the 12-V battery without direct sunlight	0 ... 35 °C (32 ... 95 °F)
---	----------------------------

- Charge 12-V battery. 🛠️ (📖 p. 257)

- Store the vehicle in a dry location that is not subject to large fluctuations in temperature.

**Info**

KTM recommends jacking up the motorcycle.

-
- Raise the motorcycle with the rear lifting gear. (📖 p. 189)
 - Lift the motorcycle with the front lifting gear. (📖 p. 190)
 - Cover the vehicle with a tarp or similar cover that is permeable to air.

**Info**

Do not use non-porous materials since they prevent humidity from escaping, thus causing corrosion. Avoid running the engine for a short time only. Since the engine cannot warm up properly, the water vapor produced during combustion condenses and causes valves and the exhaust system to rust.



21.2 Preparing for use after storage

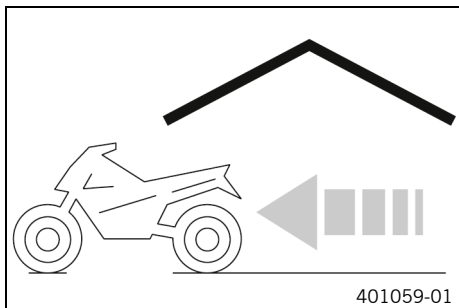

- Take the motorcycle off the front lifting gear. (📖 p. 191)
- Remove the rear of the motorcycle from the lifting gear. (📖 p. 189)
- Install 12-V battery. 🔌 (📖 p. 254)

i Info

If the 12-V battery was removed, the time and date must be set.

- Perform checks and maintenance measures when preparing for use. (📖 p. 158)
- Take a test ride.



The RACE-ON indicator lamp ❶ can indicate errors by flashing. These are indicated up to five seconds after the RACE-ON tip switch is actuated.

i Info
Blink codes referring to **KTM RACE ON** are only displayed once and not repeated.

Faults	Possible cause	Action
No response if the RACE-ON button is pressed	RACE-ON button faulty	<ul style="list-style-type: none"> – Check the RACE-ON button for damage. – Check the cable and the plug of the RACE-ON button for damage.

22 TROUBLESHOOTING

Faults	Possible cause	Action
RACE-ON indicator lamp flashes twice	No response signal from the RACE-ON key	<ul style="list-style-type: none"> – Ensure that the RACE-ON key is in range. – Remove other electronic devices from the vicinity of the RACE-ON antenna. – Check the battery compartment in the RACE-ON key for correct locking. – Check the battery compartment of the RACE-ON key for corrosion. – Change the RACE-ON key battery. (📖 p. 262) – Use black ignition key.
RACE-ON indicator lamp flashes three times	12-V battery discharged	<ul style="list-style-type: none"> – Charge 12-V battery. 🛡️ (📖 p. 257) – Check open-circuit current. 🛡️
RACE-ON indicator lamp flashes four times	Steering lock bolt locked or tense	<ul style="list-style-type: none"> – Move handlebar slightly.
RACE-ON indicator lamp flashes five times	RACE-ON antenna faulty	<ul style="list-style-type: none"> – Check the RACE-ON antenna for damage.
The combination instrument shows nothing in the display	Fuse 1 is blown	<ul style="list-style-type: none"> – Change the fuses in the fuse box. (📖 p. 265)
	The main fuse is blown	<ul style="list-style-type: none"> – Change main fuse. (📖 p. 263)
	12-V battery discharged	<ul style="list-style-type: none"> – Charge 12-V battery. 🛡️ (📖 p. 257) – Check open-circuit current. 🛡️

Faults	Possible cause	Action
The engine does not turn if the emergency OFF switch/electric starter button is pressed into the lower position	Operating error	– Carry out start procedure. (📖 p. 159)
	12-V battery discharged	– Charge 12-V battery. 🛠️ (📖 p. 257) – Check open-circuit current. 🛠️
	Faulty safety starting system	– Read out the fault memory using the KTM diagnostics tool. 🛠️
	Electronic fault	– Read out the fault memory using the KTM diagnostics tool. 🛠️
The engine only turns if the clutch lever is drawn	The vehicle is in gear	– Shift the transmission into neutral 🚦.
	Faulty safety starting system	– Read out the fault memory using the KTM diagnostics tool. 🛠️
The engine turns although a gear is engaged	Faulty safety starting system	– Read out the fault memory using the KTM diagnostics tool. 🛠️
The engine turns but does not start	The coupling of the quick release coupling is not joined	– Reconnect the coupling of the quick release coupling.
	Error in the electronic fuel injection	– Read out the fault memory using the KTM diagnostics tool. 🛠️
	The fuel quality is insufficient	– Add suitable fuel.
The engine dies during the trip	Lack of fuel	– Refuel. (📖 p. 180)
	Error in the electronic fuel injection	– Read out the fault memory using the KTM diagnostics tool. 🛠️
Malfunction indicator lamp lights up or flashes	Error in the electronic fuel injection	– Read out the fault memory using the KTM diagnostics tool. 🛠️

22 TROUBLESHOOTING

Faults	Possible cause	Action
The ABS warning lamp lights up	The ABS fuse is blown	– Change the fuses in the fuse box. (📖 p. 265)
	Large difference in wheel speeds of the front and rear wheels	– Stop the vehicle, switch off the ignition, and start it again.
	Malfunction in ABS	– Read out the fault memory using the KTM diagnostics tool. 🛠️
High oil consumption	The engine oil level is too high	– Check the engine oil level. (📖 p. 287)
	The engine oil is too thin (low viscosity)	– Change the engine oil and the oil filter, clean the oil screens. 🛠️ (📖 p. 288)
12-V battery discharged	The hazard warning flasher is switched on	– Switch off the hazard warning flasher. – Charge 12-V battery. 🛠️ (📖 p. 257)
	The 12-V battery is not being charged by the alternator	– Check charging voltage. 🛠️
	The ignition was not switched off while the vehicle was parked	– Charge 12-V battery. 🛠️ (📖 p. 257)

23.1 Engine

Design	2-cylinder 4-stroke Otto engine, 75° V arrangement, water-cooled
Displacement	1,301 cm ³ (79.39 cu in)
Stroke	71 mm (2.8 in)
Bore	108 mm (4.25 in)
Compression ratio	13.6:1
Idle speed	1,350 ... 1,550 rpm
Control	DOHC, 4 valves per cylinder, chain-driven
Valve - valve plate diameter	
Intake	42 mm (1.65 in)
Exhaust	34 mm (1.34 in)
Valve clearance	
Exhaust at: 20 °C (68 °F)	0.25 ... 0.30 mm (0.0098 ... 0.0118 in)
Intake at: 20 °C (68 °F)	0.10 ... 0.15 mm (0.0039 ... 0.0059 in)
Crankshaft bearing	Sleeve bearing
Conrod bearing	Sleeve bearing
Piston	Forged light alloy
Piston ring	1 upper compression (rectangular) ring, 1 lower compression ring, 1 oil scraper ring
Engine lubrication	Dry sump lubrication system with three rotor pumps

23 TECHNICAL DATA

Primary transmission	40:76
Clutch	Antihopping clutch in oil bath/hydraulically operated
Transmission	6-gear transmission, claw shifted
Transmission ratio	
1st gear	12:35
2nd gear	15:32
3rd gear	18:30
4th gear	20:27
5th gear	24:27
6th gear	27:26
Mixture preparation	Electronic fuel injection
Ignition system	Contactless controlled fully electronic ignition with digital ignition adjustment
Alternator	12 V, 450 W
Spark plug	
Inside spark plug	NGK LKAR9BI-10
Outside spark plug	NGK LMAR7DI-10
Electrode gap, spark plug	1 mm (0.04 in)
Cooling	Water cooling, permanent circulation of coolant by water pump
Cold start device	Starter motor

23.2 Engine tightening torques

Screw, damping plate	EJOT ALtracs® M6x14	10 Nm (7.4 lbf ft) Loctite®243™
Screw, retaining bracket, valve cover, rear	EJOT ALtracs® M6x10	10 Nm (7.4 lbf ft)
Hose clip, intake flange	M4	1.5 Nm (1.11 lbf ft)
Oil nozzle	M5	2 Nm (1.5 lbf ft) Loctite®243™
Remaining engine screws	M5	6 Nm (4.4 lbf ft)
Screw, bearing retainer	M5	6 Nm (4.4 lbf ft) Loctite®243™
Screw, bearing shells retaining bracket	M5	6 Nm (4.4 lbf ft) Loctite®243™
Screw, crankshaft speed sensor	M5	6 Nm (4.4 lbf ft) Loctite®243™
Screw, engine oil level viewer	M5	4 Nm (3 lbf ft)
Screw, gear sensor	M5	6 Nm (4.4 lbf ft) Loctite®243™
Swing angle sensor screw	M5	5 Nm (3.7 lbf ft) Loctite®243™
Bleeder screw, water pump cover	M6	10 Nm (7.4 lbf ft)
Coolant connection screw on the cylinder head	M6	8 Nm (5.9 lbf ft) Loctite®243™

23 TECHNICAL DATA

Freewheel ring bolt	M6 – 10.9	15 Nm (11.1 lbf ft) Loctite® 648™
Nut, cylinder head	M6	9 Nm (6.6 lbf ft)
Plug, vacuum connection	M6	5 Nm (3.7 lbf ft) Loctite®243™
Remaining engine screws	M6	10 Nm (7.4 lbf ft)
Screw, camshaft bearing support	M6 – 10.9	10 Nm (7.4 lbf ft)
Screw, clutch cover	M6	10 Nm (7.4 lbf ft)
Screw, clutch spring	M6	12 Nm (8.9 lbf ft)
Screw, engine case	M6x60	10 Nm (7.4 lbf ft)
Screw, engine case	M6x80	10 Nm (7.4 lbf ft)
Screw, engine case	M6x90	10 Nm (7.4 lbf ft)
Screw, locking lever	M6	10 Nm (7.4 lbf ft) Loctite®243™
Screw, oil pump cover	M6	10 Nm (7.4 lbf ft) Loctite®243™
Screw, shift drum locating	M6 – 12.9	18 Nm (13.3 lbf ft) Loctite®243™
Screw, shift lever	M6	15 Nm (11.1 lbf ft) Loctite®243™
Screw, starter motor	M6	10 Nm (7.4 lbf ft)
Screw, starter wheel guide	M6	10 Nm (7.4 lbf ft) Loctite®243™

Screw, stator	M6	10 Nm (7.4 lbf ft) Loctite®243™
Screw, valve cover	M6	10 Nm (7.4 lbf ft)
Screw, water pump cover	M6	10 Nm (7.4 lbf ft)
Screw, water pump wheel	M6	10 Nm (7.4 lbf ft) Loctite®243™
Stud, timing chain shaft	M6	8 Nm (5.9 lbf ft)
Nozzle 100	M6x0.75	4 Nm (3 lbf ft) Loctite®243™
Crankshaft locking bolt	M8	15 Nm (11.1 lbf ft)
Screw, camshaft bearing support	M8 – 10.9	Step 1 10 Nm (7.4 lbf ft) Step 2 18 Nm (13.3 lbf ft)
Screw, camshaft bearing support	M8 – 10.9	Step 1 8.5 Nm (6.27 lbf ft) Step 2 14.5 Nm (10.7 lbf ft) Only applies when using: Hexagon socket bit (61229025000)
Screw, engine case	M8	18 Nm (13.3 lbf ft)
Screw, guide rail	M8	15 Nm (11.1 lbf ft) Loctite®243™

23 TECHNICAL DATA

Screw, tensioning rail	M8	15 Nm (11.1 lbf ft) Loctite®243™
Stud, exhaust flange	M8	10 Nm (7.4 lbf ft)
Screw, engine bearer	M10	45 Nm (33.2 lbf ft)
Oil pressure sensor	M10x1	10 Nm (7.4 lbf ft)
Plug, cam lever axis	M10x1	15 Nm (11.1 lbf ft)
Plug, clutch lubrication	M10x1	10 Nm (7.4 lbf ft)
Screw plug, spreading transmission lock	M10x1	12 Nm (8.9 lbf ft)
Screw, conrod bearing	M10x1	Step 1 25 Nm (18.4 lbf ft) Step 2 30 Nm (22.1 lbf ft) Step 3 90°
Screw, timing chain tensioner release	M10x1	10 Nm (7.4 lbf ft)
Spark plug	M10x1	11 Nm (8.1 lbf ft)

Cylinder head screw	M11x1.5	<p>Tightening sequence: Using a crisscross pattern</p> <p>Step 1 15 Nm (11.1 lbf ft)</p> <p>Step 2 30 Nm (22.1 lbf ft)</p> <p>Step 3 90°</p> <p>Step 4 90°</p> <p style="text-align: right;">Lubricated with engine oil</p>
Coolant temperature sensor	M12x1.5	12 Nm (8.9 lbf ft)
Rotor screw	M12x1.5	115 Nm (84.8 lbf ft)
Spark plug	M12x1.5	18 Nm (13.3 lbf ft)
Nut of engine sprocket	M20x1.5	100 Nm (73.8 lbf ft) Loctite®243™
Oil drain plug	M20x1.5	20 Nm (14.8 lbf ft)
Nut, inner clutch hub	M22x1.5	120 Nm (88.5 lbf ft) Loctite®243™
Plug, timing-chain tensioner	M24x1.5	25 Nm (18.4 lbf ft)
Screw plug, alternator cover	M24x1.5	8 Nm (5.9 lbf ft)
Nut, primary gear wheel	M33LHx1.5	130 Nm (95.9 lbf ft) Loctite®243™

23.3 Capacities

23.3.1 Engine oil

Engine oil Ambient temperature: $\geq 0\text{ }^{\circ}\text{C}$ ($\geq 32\text{ }^{\circ}\text{F}$)	3.50 l (3.7 qt.)	Engine oil (SAE 10W/50) (📖 p. 334)
Engine oil Ambient temperature: $< 0\text{ }^{\circ}\text{C}$ ($< 32\text{ }^{\circ}\text{F}$)		Engine oil (SAE 5W/40) (📖 p. 335)

23.3.2 Coolant

Coolant	3.20 l (3.38 qt.)	Coolant (📖 p. 333)
---------	-------------------	--------------------

23.3.3 Fuel

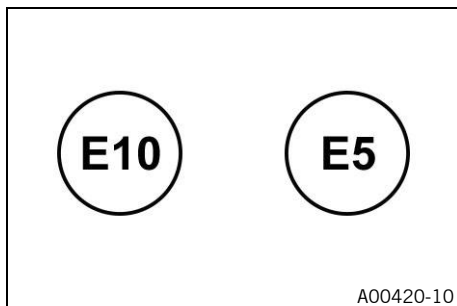

Please observe the labels on EU fuel pumps.

A00420-10

Total fuel tank capacity, approx.	23 l (6.1 US gal)	Super unleaded (ROZ 95/RON 95/PON 91) (📖 p. 335)
-----------------------------------	-------------------	--

Fuel reserve, approx.	3.5 l (3.7 qt.)
-----------------------	-----------------

23.4 Chassis

Frame	Lattice frame made of chrome molybdenum steel tubing, powder-coated	
Fork	WP SuspensionSemi-active Suspension	
Shock absorber	WP SuspensionSemi-active Suspension	
Suspension travel		
front	125 mm (4.92 in)	
rear	156 mm (6.14 in)	
Brake system		
front	Double disc brake with radially mounted four-piston brake calipers, floating brake discs	
rear	Single disc brake with dual-piston brake caliper, fixed brake disc	
Brake discs - diameter		
front	320 mm (12.6 in)	
rear	240 mm (9.45 in)	
Brake discs - wear limit		

23 TECHNICAL DATA

front	4.5 mm (0.177 in)
rear	4.5 mm (0.177 in)
Tire pressure, solo / with passenger / full payload	
front: with cold tires	2.5 bar (36 psi)
rear: with cold tires	2.9 bar (42 psi)
Secondary drive ratio	17:38
Chain	5/8 x 5/16" (525) X-ring
Steering head angle	65.1°
Wheelbase	1,482 ± 15 mm (58.35 ± 0.59 in)
Seat height unloaded	835 mm (32.87 in)
Ground clearance unloaded	141 mm (5.55 in)
Weight without fuel approx.	216 kg (476 lb.)
Maximum permissible front axle load	165 kg (364 lb.)
Maximum permissible rear axle load	294 kg (648 lb.)
Maximum permissible overall weight	459 kg (1,012 lb.)

23.5 Electrical system

12-V battery	YTZ14S	Battery voltage: 12 V Nominal capacity: 11.2 Ah Maintenance-free
RACE-ON key battery	CR 2032	3 V

Fuse	58011109110	10 A
Fuse	58011109115	15 A
Fuse	58011109125	25 A
Fuse	58011109130	30 A

Low beam/high beam	LED
Position light	LED
Cornering light	LED
Combination instrument lighting and indicator lamps	LED
Turn signal	LED
Tail light	LED
Brake light	LED
License plate lamp	LED

23.6 Tires

Front tire	Rear tire
120/70 ZR 17 M/C (58W) TL Pirelli Angel GT	190/55 ZR 17 M/C (75W) TL (D) Pirelli Angel GT
The tires specified represent one of the possible series production tires. Additional information is available in the Service section under: http://www.ktm.com	

23.7 Fork

Fork article number	14.18.1Q.23	
Fork	WP SuspensionSemi-active Suspension	
Spring length with preload spacer(s)	335 mm (13.19 in)	
Spring rate		
Medium (standard)	20 N/mm (114 lb/in)	
Fork length	776 mm (30.55 in)	
Fork oil, fork leg, left	670 ml (22.65 fl. oz.)	Fork oil (SAE 4) (48601166S1) (📖 p. 335)
Fork oil, fork leg, right	410 ml (13.86 fl. oz.)	Fork oil (SAE 4) (48601166S1) (📖 p. 335)

23.8 Shock absorber

Shock absorber article number	01.18.1Q.23	
Shock absorber	WP SuspensionSemi-active Suspension	
Spring rate		
Medium (standard)	185 N/mm (1,056 lb/in)	
Spring length	185 mm (7.28 in)	
Static sag	24 mm (0.94 in)	

23.9 Chassis tightening torques

Remaining screws, chassis	EJOT PT® K50x12	1 Nm (0.7 lbf ft)
Remaining screws, chassis	EJOT PT® K50x14	1 Nm (0.7 lbf ft)
Remaining screws, chassis	EJOT PT® K50x16	2 Nm (1.5 lbf ft)
Remaining screws, chassis	EJOT PT® K50x18	2 Nm (1.5 lbf ft)
Remaining screws, chassis	EJOT PT® K45x12	1 Nm (0.7 lbf ft)
Screw, air filter box cover	EJOT PT® K60x30	2 Nm (1.5 lbf ft)
Screw, exhaust valve cover fastening	EJOT SF® M4x6-K	4 Nm (3 lbf ft)
Screw, tail light	EJOT PT® K50x14	2.5 Nm (1.84 lbf ft)
Screw, combination switch, left	M4	5 Nm (3.7 lbf ft)
Screw, fixed grip, left	M4	2 Nm (1.5 lbf ft)
Screw, side stand switch	M4	2 Nm (1.5 lbf ft)
Remaining nuts, chassis	M5	5 Nm (3.7 lbf ft)
Remaining screws, chassis	M5	5 Nm (3.7 lbf ft)
Screw for throttle grip	M5	3.5 Nm (2.58 lbf ft)
Screw, cable channel	M5	5 Nm (3.7 lbf ft)
Screw, chain sliding guard	M5	5 Nm (3.7 lbf ft)
Screw, combination switch, right	M5	5 Nm (3.7 lbf ft)
Screw, cornering light	M5	2 Nm (1.5 lbf ft)
Screw, fuel level sensor	M5	3 Nm (2.2 lbf ft)

23 TECHNICAL DATA

Screw, fuel tank filler cap	M5	3 Nm (2.2 lbf ft)
Screw, trim	M5x12	3.5 Nm (2.58 lbf ft)
Swing angle sensor screw	M5x16	5 Nm (3.7 lbf ft) Loctite®243™
Cable disk nut, exhaust valve control unit	M6	14 Nm (10.3 lbf ft)
Ground fitting on frame	M6	10 Nm (7.4 lbf ft)
Nut, ABS module fastening	M6	8 Nm (5.9 lbf ft)
Nut, cable on starter motor	M6	4 Nm (3 lbf ft)
Nut, exhaust valve control unit throttle cable	M6	5 Nm (3.7 lbf ft)
Remaining nuts, chassis	M6	10 Nm (7.4 lbf ft)
Remaining screws, chassis	M6	10 Nm (7.4 lbf ft)
Screw, ABS module fastening	M6	5 Nm (3.7 lbf ft)
Screw, angle sensor cover	M6	6 Nm (4.4 lbf ft) Loctite®243™
Screw, ball joint of push rod on foot brake cylinder	M6	5 Nm (3.7 lbf ft) Loctite®243™
Screw, battery terminal	M6	4.5 Nm (3.32 lbf ft)
Screw, clutch assembly	M6	5 Nm (3.7 lbf ft) Loctite®243™
Screw, connecting piece, rear brake line	M6	10 Nm (7.4 lbf ft) Loctite®243™

Screw, cooler retaining bracket	M6	7 Nm (5.2 lbf ft)
Screw, exhaust clamp on main silencer	M6	8 Nm (5.9 lbf ft)
Screw, exhaust clamp on manifold	M6	8 Nm (5.9 lbf ft)
Screw, foot brake cylinder	M6	10 Nm (7.4 lbf ft) Loctite®243™
Screw, front wheel speed sensor	M6	4 Nm (3 lbf ft)
Screw, fuel pump	M6	6 Nm (4.4 lbf ft)
Screw, license plate holder on lower rear panel	M6	12 Nm (8.9 lbf ft)
Screw, radiator hose clip	M6	3 Nm (2.2 lbf ft)
Screw, rear wheel speed sensor	M6	4 Nm (3 lbf ft)
Screw, shift lever stub	M6	10 Nm (7.4 lbf ft) Loctite®243™
Screw, shift rod	M6	5 Nm (3.7 lbf ft) Loctite®243™
Screw, shift shaft deflector on shift shaft	M6	18 Nm (13.3 lbf ft) Loctite®243™
Screw, side stand stub	M6	6 Nm (4.4 lbf ft) Loctite®243™
Screw, side stand stub extension	M6	6 Nm (4.4 lbf ft) Loctite®243™

23 TECHNICAL DATA

Screw, steering damper bracket on frame	M6	8 Nm (5.9 lbf ft) Loctite®243™
Screw, step plate for foot brake lever	M6	10 Nm (7.4 lbf ft) Loctite®243™
Screw, suitcase molds	M6	6 Nm (4.4 lbf ft)
Screw, tire pressure sensor (Super Duke GT EU)	M6	7 Nm (5.2 lbf ft)
Cable disk nut, exhaust valve	M8	7 Nm (5.2 lbf ft)
Nut, manifold on cylinder head	M8	Tightening sequence: Tighten the nuts evenly. Do not warp the metal plate. 25 Nm (18.4 lbf ft)
Nut, rear sprocket	M8	36 Nm (26.6 lbf ft)
Nut, shift rod	M8	12 Nm (8.9 lbf ft)
Nut, shift rod	M8LH	12 Nm (8.9 lbf ft)
Nut, valve, angled (Super Duke GT JP)	M8	4 Nm (3 lbf ft)
Nut, valve, angled (Super Duke GT EU)	M8	6 Nm (4.4 lbf ft)
Remaining nuts, chassis	M8	25 Nm (18.4 lbf ft)
Remaining screws, chassis	M8	25 Nm (18.4 lbf ft)
Screw, axle clamp	M8	15 Nm (11.1 lbf ft)
Screw, bottom triple clamp	M8	15 Nm (11.1 lbf ft)

Screw, foot brake lever	M8	20 Nm (14.8 lbf ft) Loctite®243™
Screw, front brake disc	M8	28 Nm (20.7 lbf ft) Loctite®2701™
Screw, front rider footrest bracket	M8	25 Nm (18.4 lbf ft) Loctite®243™
Screw, handlebar clamp	M8	20 Nm (14.8 lbf ft)
Screw, ignition lock (tamper-proof screw)	M8	25 Nm (18.4 lbf ft)
Screw, rear brake caliper	M8	25 Nm (18.4 lbf ft) Loctite®2701™
Screw, rear brake disc	M8	28 Nm (20.7 lbf ft) Loctite®243™
Screw, shift lever on footrest bracket	M8	20 Nm (14.8 lbf ft) Loctite®243™
Screw, shift shaft deflector on frame	M8	10 Nm (7.4 lbf ft) Loctite®243™
Screw, side stand bracket	M8	25 Nm (18.4 lbf ft) Loctite®243™
Screw, side stand spring	M8	15 Nm (11.1 lbf ft) Loctite®2701™
Screw, steering damper on holder	M8	8 Nm (5.9 lbf ft) Loctite®243™

23 TECHNICAL DATA

Screw, steering damper on triple clamp	M8	8 Nm (5.9 lbf ft)	Loctite®243™
Screw, steering stem clamp	M8	20 Nm (14.8 lbf ft)	Loctite®243™
Screw, top triple clamp	M8	18 Nm (13.3 lbf ft)	
Remaining nuts, chassis	M10	45 Nm (33.2 lbf ft)	
Remaining screws, chassis	M10	45 Nm (33.2 lbf ft)	
Screw, engine bearer	M10	45 Nm (33.2 lbf ft)	Loctite®243™
Screw, front brake caliper	M10	45 Nm (33.2 lbf ft)	Loctite®243™
Screw, handlebar support	M10	40 Nm (29.5 lbf ft)	Loctite®243™
Screw, side stand	M10	35 Nm (25.8 lbf ft)	Loctite®243™
Screw, side stand bracket	M10	45 Nm (33.2 lbf ft)	Loctite®243™
Screw, side stand holder	M10	45 Nm (33.2 lbf ft)	Loctite®243™
Banjo bolt, brake line	M10x1	25 Nm (18.4 lbf ft)	
Banjo bolt, brake line, connecting piece, rear	M10x1	15 Nm (11.1 lbf ft)	
Nut, rear hub shock absorber carrier	M10x1.25	45 Nm (33.2 lbf ft)	Loctite®243™

Lambda sensor	M12x1.25	25 Nm (18.4 lbf ft)
Screw, bottom shock absorber	M14x1.5	80 Nm (59 lbf ft) Thread greased
Screw, top shock absorber	M14x1.5	80 Nm (59 lbf ft) Thread greased
Screw, eccentric	M16	70 Nm (51.6 lbf ft)
Nut, fork pivot	M19x1.5	130 Nm (95.9 lbf ft) Thread greased
Nut, seat lock	M22x1.5	4 Nm (3 lbf ft)
Screw, front wheel spindle	M25x1.5	45 Nm (33.2 lbf ft) Thread greased
Screw, steering head, top	M25x1.5	18 Nm (13.3 lbf ft)
Nut, rear axle, shock absorber side	M35x1.5	200 Nm (147.5 lbf ft) Loctite® 262™ /lock the locking wire with locking varnish
Nut, rear axle	M50x1.5	250 Nm (184.4 lbf ft) Thread greased/lock locking wire with locking varnish

24.1 Declarations of conformity



Info

The functional and equipment scope is model-dependent and may not include all wireless systems and application areas referred to.

KTM AG hereby declares that the **KTM RACE ON system** wireless system conforms with the relevant guidelines. The full text of the Declaration of Conformity is available at the following Internet address.

Certification website: <http://www.ktm.com/ktm-race-on-system>

KTM AG hereby declares that the **LC8 DASHBOARD** wireless system conforms with the relevant guidelines. The full text of the Declaration of Conformity is available at the following Internet address.

Certification website: <http://www.ktm.com/lc8-dashboard>

Schrader Electronics Ltd hereby declares that the **Tyre Pressure Monitoring System** wireless system conforms with the relevant guidelines. The full text of the Declaration of Conformity is available at the following Internet address.

Certification website: <http://www.ktm.com/tpms>

24.2 Country-specific declarations of conformity

KTM RACE ON system

Advertencias de IFETEL

La operación de este equipo está sujeta a las siguientes dos condiciones:
 (1) es posible que este equipo o dispositivo no cause interferencia perjudicial y
 (2) este equipo o dispositivo debe aceptar cualquier interferencia, incluyendo la que pueda causar su operación no deseada.

Modelo XCB0307 (unidad central) K0349-0 (llave activa)

Certificado Homologacion Numero: **RLVZAXC17-1560**

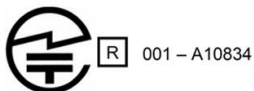

CNC COMISIÓN NACIONAL DE COMUNICACIONES
H-20232



Model: K0349-0



Este equipamento opera em caráter secundário, isto é, não tem direito a proteção contra interferência prejudicial, mesmo de estações do mesmo tipo, e não pode causar interferência a sistemas operando em caráter primário.

Model: XCB0307



Este equipamento opera em caráter secundário, isto é, não tem direito a proteção contra interferência prejudicial, mesmo de estações do mesmo tipo, e não pode causar interferência a sistemas operando em caráter primário.



AGREE PAR L'ANRT MAROC
 Numéro d'agrément : MR 14688 ANRT 2017
 Date d'agrément : 31/08/2017

AGREE PAR L'ANRT MAROC
 Numéro d'agrément : MR 14690 ANRT 2017
 Date d'agrément : 31/08/2017

מוציא זה שטור מרישיון הפעלה אלהותי.
 המוציא אסור לשימוש למתן שירות לצד ג'.
 אסור להחליף אנטנת המכשיר המקורית.
 אסור לעשות במכשיר כל שינוי טכני.

This product does not need an Israeli wireless operation license.
 It is forbidden to use this product for service to third party.
 It is forbidden to replace the original antenna.
 It is forbidden to make any technical change in this product.

NOTICE
 This equipment has been registered with the Telecommunications Regulatory Authority for use in the UAE.
TRA REGISTERED No: ER63530/18
DEALER No: DA75721/18

NOTICE
 This equipment has been registered with the Telecommunications Regulatory Authority for use in the UAE.
TRA REGISTERED No: ER63531/18
DEALER No: DA75721/18



UA.TR.109.0200-17



UA.TR.109.0198-17

KC
 R-RRM-ZAD-XCB0305
 Company name: ZADI S.p.A.
 Equipment Name: Keyless System
 Basic Model Name: XCB0305
 Series Model Name: XCB0307
 Manufactured Date: Week / Year
 Manufacturer / Country: ZADI S.p.A / ITALY

KC
 R-CRM-ZAD-K0349-0
 Company name: ZADI S.p.A.
 Equipment Name: RRS Remote control key
 Model Name: K0349-0
 Manufactured Date: Week / Year
 Manufacturer / Country: ZADI S.p.A / ITALY

Complies with
IMDA Standards
DA107682



S03192-01

Brake fluid DOT 4 / DOT 5.1

Standard/classification

- DOT

Guideline

- Use only brake fluid that complies with the specified standard (see specifications on the container) and that exhibits the corresponding properties.

Recommended supplier

Castrol

- **REACT PERFORMANCE DOT 4**

MOTOREX®

- **Brake Fluid DOT 5.1**

Coolant

Guideline

- Only use high-grade, silicate-free coolant with corrosion inhibitor additive for aluminum motors. Low grade and unsuitable antifreeze causes corrosion, deposits and frothing.
- Do not use pure water as only coolant is able to meet the requirements needed in terms of corrosion protection and lubrication properties.
- Only use coolant that complies with the requirements stated (see specifications on the container) and that has the relevant properties.

Antifreeze protection to at least	-25 °C (-13 °F)
-----------------------------------	-----------------

The mixture ratio must be adjusted to the necessary antifreeze protection. Use distilled water if the coolant needs to be diluted.

The use of premixed coolant is recommended.

Observe the coolant manufacturer specifications for antifreeze protection, dilution and miscibility (compatibility) with other coolants.

Recommended supplier

MOTOREX®

- **COOLANT M3.0**

Engine oil (SAE 10W/50)

Standard/classification

- JASO T903 MA2 (📖 p. 339)
- SAE (📖 p. 339) (SAE 10W/50)

Guideline

- Use only engine oils that comply with the specified standards (see specifications on the container) and that possess the corresponding properties.

Fully synthetic engine oil

Recommended supplier

MOTOREX®

- **Power Synt 4T**

Engine oil (SAE 5W/40)

Standard/classification

- JASO T903 MA2 (📖 p. 339)
- SAE (📖 p. 339) (SAE 5W/40)

Guideline

- Use only engine oils that comply with the specified standards (see specifications on the container) and that possess the corresponding properties.

Fully synthetic engine oil

Recommended supplier

MOTOREX®

- Power Synt 4T

Fork oil (SAE 4) (48601166S1)

Standard/classification

- SAE (📖 p. 339) (SAE 4)

Guideline

- Use only oils that comply with the specified standards (see specifications on the container) and that exhibit the corresponding properties.

Super unleaded (ROZ 95/RON 95/PON 91)

Standard/classification

- DIN EN 228 (ROZ 95/RON 95/PON 91)

Guideline

- Only use unleaded super fuel that matches or is equivalent to the specified fuel grade.

- Fuel with an ethanol content of up to 10 % (E10 fuel) is safe to use.
-



Info

Do **not** use fuel containing methanol (e. g. M15, M85, M100) or more than 10 % ethanol (e. g. E15, E25, E85, E100).

Chain cleaner

Recommended supplier

MOTOREX®

- Chain Clean

Fuel additive

Recommended supplier

MOTOREX®

- Fuel Stabilizer

Long-life grease

Recommended supplier

MOTOREX®

- Bike Grease 2000

Motorcycle cleaner

Recommended supplier

MOTOREX®

- Moto Clean

Perfect finish and high gloss polish for paints

Recommended supplier

MOTOREX®

- Moto Shine

Preserving materials for paints, metal and rubber

Recommended supplier

MOTOREX®

- Moto Protect

Special cleaner for glossy and matte paint finishes, metal and plastic surfaces

Recommended supplier

MOTOREX®

- Quick Cleaner

Street chain spray

Guideline

Recommended supplier

MOTOREX®

- Chainlube Road Strong

Universal oil spray

Recommended supplier

MOTOREX®

- Joker 440 Synthetic

JASO T903 MA2

Different technical development directions required a separate specification for motorcycles – the **JASO T903 MA2** standard.

Earlier, engine oils from the automobile industry were used for motorcycles because there was no separate motorcycle specification.

Whereas long service intervals are demanded for automobile engines, the focus for motorcycle engines is on high performance at high engine speeds.

In most motorcycle engines, the transmission and clutch are lubricated with the same oil.

The **JASO T903 MA2** standard meets these special requirements.

SAE

The SAE viscosity classes were defined by the Society of Automotive Engineers and are used for classifying oils according to their viscosity. The viscosity describes only one property of oil and says nothing about quality.

ABS	Anti-lock braking system	Safety system that prevents locking of the wheels when driving straight ahead without the influence of lateral forces
ATIR	Automatic Turn Indicator Reset	Software, which automatically switches the indicator off according to a time or travel distance counter
BTM	Brake Temperature Monitoring	System which calculates the temperature of the brake system and informs the rider of overheating
ETTC	Engine traction torque control	Auxiliary function of the engine control, which prevents rear wheel locking with excessive engine braking effect, by lightly opening the throttle valve
HHC	Hill Hold Control	Assist, which prevents the vehicle from rolling backwards on an incline
-	KTM RACE ON	System that releases the ignition, steering lock, and fuel tank filler cap via a remote key with a transponder
-	Launch control	Vehicles electronics functions for achieving the best possible acceleration from a standing position
MSC	Motorcycle Stability Control	The is an auxiliary function for the ABS, which can prevent blocking and slipping of the wheels during braking on an inclined position, within the physical limitations
MTC	Motorcycle Traction Control	Auxiliary function of the motor control that reduces engine torque with spinning rear wheel
OBD	On-board diagnosis	Vehicle system, which monitors the specified parameters of the vehicle electronics

-	Quickshifter +	Engine electronics function for shifting up and down without clutch actuation
TPMS	Tire pressure monitoring system	A safety system that monitors the tire pressure with the assistance of sensors in the tires and displays it to the rider

29 LIST OF ABBREVIATIONS

Art. no.	Article number
ca.	circa
cf.	compare
e.g.	for example
etc.	et cetera
i.a.	inter alia
no.	number
poss.	possibly





30.1 Red symbols

Red symbols indicate an error condition that requires immediate intervention.

	The oil pressure warning lamp lights up red – The oil pressure is too low. Stop immediately, taking care not to endanger yourself or other road users in the process, and switch off the engine.
---	--

30.2 Yellow and orange symbols





Yellow and orange symbols indicate an error condition that requires prompt intervention. Active driving aids are also represented by yellow or orange symbols.

	RACE-ON indicator lamp lights up/flashes yellow/orange/red – Status or error messages relating to Race-on system/alarm system.
	The general warning lamp lights up yellow – A note/warning note on operating safety has been detected. This is also shown in the display.
	The ABS warning lamp lights up yellow – Status or error messages relating to ABS. The ABS warning lamp flashes if the ABS mode Supermoto is enabled.
	TC indicator lamp lights up/flashes yellow – The MTC (📖 p. 284) is not enabled or is currently intervening. The TC indicator lamp also lights up if an error is detected. Contact an authorized KTM workshop. The TC indicator lamp flashes if the motorcycle traction control actively engages or if the HHC (📖 p. 164) (optional) is activated.
	The cruise control system indicator lamp lights up yellow – The cruise control system function is switched on, but cruise control is not activated.

	Malfunction indicator lamp lights up yellow – The OBD has detected an error in the vehicle electronics.
---	---

30.3 Green and blue symbols

Green and blue symbols reflect information.

	The left turn signal indicator lamp flashes green with a steady rhythmic flash – The left turn signal is switched on.
	The high beam indicator lamp lights up blue – The high beam is switched on.
	The idle indicator lamp lights up green – The transmission is in neutral.
	The cruise control system indicator lamp lights up green – The cruise control system function is switched on and cruise control is activated.
	The right turn signal indicator lamp flashes green with a steady rhythmic flash – The right turn signal is switched on.

1

12-V battery

charging	257
installing	254
removing	252

A

ABS	219
------------	-----

ACC1

front	277
rear	278

ACC2

front	277
rear	278

Accessories	18
--------------------	----

Anti wheelie mode	165
--------------------------	-----

Anti-lock braking system	219
---------------------------------	-----

Applying the brakes	174
----------------------------	-----

Auxiliary substances	18
-----------------------------	----

B

Brake discs

checking	223
----------	-----

Brake fluid

front brake, adding	225
of rear brake, adding	230

Brake fluid level

front brake, checking	224
rear brake, checking	229

Brake linings

front brake, checking	228
rear brake, checking	233

Brake system 219-233

temperature monitoring, rear	222
------------------------------	-----

Brakes	174
---------------	-----

C

Capacity

Coolant	318
engine oil	293, 318
fuel	182, 319

Case holders	56
---------------------	----

Chain

checking	206
cleaning	201
dirt, checking for	200

Chain guide	
checking	206
Chain tension	
adjusting	205
checking	203
Clutch	
fluid level, checking/correcting	211
Clutch lever	30
basic position, adjusting	145
Combination instrument	61-136
ABS	116
ABS display	79
activation and test	62
adjusting tilt	144
ambient air temperature indicator	84
Anti Wheelie Mode	132
Audio	89
Bluetooth	96
brake system, temperature warning	66
Consumption	124
coolant temperature indicator	83
Corner. Light Test	136
cruise control indicator	77
Damp display	80
Damping	112, 188
day-night mode	64
Daytime Runn. Light	128
display	72
Distance	122
engine speed	75
Extra Functions	108
Favourites	118
Favourites display	85
fuel level display	83
gear display	81
General Info	105
heated grip (optional)	81
Heated Grips (optional)	109, 133
Heated Seat (optional)	110
Heated Seat Pas (optional)	135
Heated Seat Rider (optional)	134
HHC (optional)	117
ice warning	66
indicator lamps	68
Info	102
KTM MY RIDE	88
Language	125
Launch Control	131
Layout (optional)	130

Load	111, 187	shift warning light	76
Load display	82	slip adjustment	285
menu	88	speed	78
Motorcycle	109	telephony	101
MTC	114	Temperature	123
MTC display	79	Throttle Response	286
MTC+MSR (optional)	115	time	85
navigation	91	TPMS	105
navigation information	94	Track	130
navigation setup	92	track layout (optional)	74
Navigation display	87	Trip 1	103
overview	61	Trip 2	104
Pairing	98	Units	122
performance layout (optional)	75	volume	95
Pressure	123	warnings	65, 107
Quick Selector 1	119	Combination switch	
Quick Selector 1 display	86	overview left side	32
Quick Selector 2	120	Coolant level	
Quick Selector 2 display	86	checking in the compensating tank	279
Quickshift + (optional)	129	correcting in the compensating tank	281
Ride display	80	Cornering light	250
Ride Mode	113, 283	range, adjusting	273
seat heater (optional)	82	setting, checking	268
Service	107		
Settings	117		

Cruise control system		
operation	35	
Customer service	19	
D		
Date		
adjusting	125	
Declarations of conformity	330-332	
country-specific	332	
Diagnostics connector	276	
E		
Emergency OFF switch	40	
Engine		
running in	155	
Engine number	27	
Engine oil		
adding	296	
changing	288	
Engine oil level		
checking	287	
Engine sprocket		
checking	206	
Engine traction torque control	173	
Environment	17	
F		
Figures	19	
Foot brake lever	59	
basic position, adjusting	147	
Setting the step plate	149	
Fork	187	
Fork legs		
dust boots, cleaning	217	
Fork part number	28	
Front fender		
installing	216	
removing	216	
Front rider's seat		
mounting	195	
removing	193	
Front wheel		
installing	236	
removing	234	
Fuel tank filler cap		
closing	54	
opening	52	

Fuel tank spoiler		Immobilizer	45
installing	215	Implied warranty	18
removing	214	Indicator lamps	68
Fuel, oils, etc.	18	Intended use	12
Fuses		K	
in fuse box, changing	265	Key number	27
G		L	
Grab handle	56	Launch control	162
H		Light switch	32
Hand brake lever	30	Luggage	155
basic position, adjusting	146	M	
Handlebar position	137	Main fuse	
adjusting	137	changing	263
Hazard warning flasher	41	Main silencer	
Hazard warning flasher switch	41	installing	199
Headlight		removing	197
daytime running light	249	Manufacturer warranty	18
range, adjusting	272	Misuse	12
setting, checking	268	Motorcycle	
Horn button	35	cleaning	299
I		lifting with front lifting gear	190
Ice warning	66	raising with the rear lifting gear	189
		removing the rear from the lifting gear	189

taking off front lifting gear	191		
Motorcycle traction control	284	Q	
MSR	173	Quickshifter +	166
MTC	284		
		R	
O		RACE-ON button	42
Oil filter		RACE-ON key	43
changing	288	RACE-ON key battery, changing	262
Oil screens		Rear sprocket	
cleaning	288	checking	206
Owner's Manual	17	Rear wheel	
		installing	241
P		removing	239
Parking	176	Refueling	
Passenger foot pegs	57	fuel	180
Passenger seat		Riding	167
mounting	193	starting off	162
removing	192	starting off with HHC	164
Preparing for use		starting off with launch control	163
advice on preparing for first use	153		
after storage	306	S	
checks and maintenance measures when		Safe operation	14
preparing for use	158	Seat lock	55
Protective clothing	16	Service	19
		Service schedule	183-186

Transporting	178
Troubleshooting	307-310
Turn signal switch	34
Type label	26

U

USB cable

disconnecting	47
USB cable, connecting	46

USB socket	46
-------------------------	----

Use definition	12
-----------------------------	----

V

Vehicle

loading	155
---------------	-----

Vehicle identification number	26
--	----

View of vehicle

front left	22
rear right	24

W

Windshield

adjusting	142
installing	196
removing	196

Winter operation

checks and maintenance steps	302
------------------------------------	-----

Work rules	16
-------------------------	----

READY TO RACE
» www.ktm.com



3214112en

10/2019

KTM Sportmotorcycle GmbH
3230 Mattighofen/Austria
<http://www.ktm.com>



REG. NO. 12 100 6061

Photo:
Mitterbauer/KISKA/KTM