

RC 125

Art. no. 3214114en



**KTM**



Congratulations on your decision to purchase a KTM motorcycle. You are now the owner of a state-of-the-art sports vehicle that will continue giving you pleasure for a long time if you maintain it properly.

We wish you good and safe riding at all times!

Enter the serial numbers of your vehicle below.

Vehicle identification number (📖 p. 24)	Dealer's stamp
Engine number (📖 p. 25)	
Key number (📖 p. 25)	

The Owner's Manual contained the latest information for this model series at the time of going to print. However, minor differences due to further developments in design cannot be ruled out completely.

All specifications contained herein are non-binding. KTM Sportmotorcycle GmbH specifically reserves the right to modify or delete technical specifications, prices, colors, forms, materials, services, designs, equipment, etc., without prior notice and without specifying reasons, to adapt these to local conditions, as well as to stop production of a particular model without prior notice. KTM accepts no liability for delivery options, deviations from figures and descriptions, misprints, and other errors. The models portrayed partly contain special equipment that does not belong to the regular scope of supply.

© 2019 KTM Sportmotorcycle GmbH, Mattighofen Austria  
All rights reserved



3214114en

11/2019

# DEAR KTM CUSTOMER

Reproduction, even in part, as well as copying of all kinds, is permitted only with the express written permission of the copyright owner.



REG.NO. 12 100 6061

KTM Sportmotorcycle GmbH  
Stallhofnerstraße 3  
5230 Mattighofen, Austria

ISO 9001(12 100 6061)

KTM applies quality assurance processes that lead to the highest possible product quality as defined in the ISO 9001 international quality management standard.

Issued by: TÜV Management Service







This document is valid for the following models:

RC 125 EU (F5003T1, F5003T2)

1	MEANS OF REPRESENTATION .....	8	4	VIEW OF VEHICLE .....	20
	1.1 Symbols used .....	8	4.1	View of vehicle, front left (example) ...	20
	1.2 Formats used.....	9	4.2	View of vehicle, rear right (example).....	22
2	SAFETY ADVICE.....	10	5	SERIAL NUMBERS .....	24
	2.1 Use definition – intended use.....	10	5.1	Vehicle identification number.....	24
	2.2 Misuse.....	10	5.2	Type label .....	24
	2.3 Safety advice.....	10	5.3	Engine number .....	25
	2.4 Degrees of risk and symbols .....	11	5.4	Key number.....	25
	2.5 Tampering warning.....	12	6	CONTROLS.....	26
	2.6 Safe operation .....	12	6.1	Clutch lever.....	26
	2.7 Protective clothing .....	13	6.2	Hand brake lever.....	26
	2.8 Work rules.....	14	6.3	Throttle grip .....	27
	2.9 Environment.....	14	6.4	Horn button.....	27
	2.10 Owner's Manual .....	15	6.5	Light switch .....	28
3	IMPORTANT NOTES.....	16	6.6	High beam flasher button .....	28
	3.1 Manufacturer and implied warranty....	16	6.7	Turn signal switch.....	29
	3.2 Fuel, auxiliary substances .....	16	6.8	Emergency OFF switch .....	30
	3.3 Spare parts, accessories .....	16	6.9	Start button.....	30
	3.4 Service .....	17	6.10	Ignition and steering lock.....	31
	3.5 Figures .....	17	6.11	Locking the steering.....	31
	3.6 Customer service.....	17	6.12	Unlocking the steering.....	32
			6.13	Opening fuel tank filler cap.....	33

# TABLE OF CONTENTS



6.14	Closing the fuel tank filler cap.....	35	7.13	TRIP 1 display.....	61
6.15	Seat lock.....	36	7.13.1	Time Trip 1 .....	61
6.16	Tool set.....	36	7.13.2	Average Speed Trip1 .....	62
6.17	Grab handles .....	37	7.13.3	Avg F.C. Trip 1 .....	63
6.18	Passenger foot pegs .....	37	7.14	TRIP 2 display.....	64
6.19	Shift lever .....	38	7.14.1	Time Trip 2.....	64
6.20	Foot brake lever .....	39	7.14.2	Average Speed Trip2.....	65
6.21	Side stand.....	39	7.14.3	Avg F.C. Trip 2 .....	66
7	COMBINATION INSTRUMENT .....	41	7.15	Setting the units .....	66
7.1	Combination instrument .....	41	7.16	Setting the clock.....	68
7.2	Activation and test .....	42	7.17	Adjusting the shift speed RPM1 .....	69
7.3	Warnings.....	43	7.18	Adjusting the shift speed RPM2 .....	70
7.4	Indicator lamps.....	48	8	PREPARING FOR USE.....	72
7.5	Shift warning light .....	50	8.1	Advice on preparing for first use .....	72
7.6	Display .....	52	8.2	Running in the engine .....	74
7.7	Fuel level display .....	53	8.3	Loading the vehicle.....	74
7.8	Coolant temperature indicator .....	54	9	RIDING INSTRUCTIONS.....	77
7.9	Function buttons.....	55	9.1	Checks and maintenance measures when preparing for use .....	77
7.10	TRIP F display .....	56	9.2	Starting.....	78
7.11	Info display .....	57	9.3	Starting off.....	80
7.12	ODO display .....	58	9.4	Shifting, riding. ....	81
7.12.1	Fuel Range.....	58	9.5	Applying the brakes.....	85
7.12.2	Service .....	59	9.6	Stopping, parking.....	87
7.12.3	Actual F.C.....	60			

9.7	Transport .....	89	12.8	Removing the passenger seat .....	107
9.8	Refueling .....	90	12.9	Mounting the passenger seat.....	108
10	SERVICE SCHEDULE .....	93	12.10	Checking for chain dirt accumulation.....	110
10.1	Additional information.....	93	12.11	Cleaning the chain .....	110
10.2	Required work .....	93	12.12	Checking the chain tension.....	112
10.3	Recommended work .....	95	12.13	Adjusting the chain tension.....	114
11	TUNING THE CHASSIS .....	97	12.14	Checking the chain, rear sprocket, and engine sprocket .....	116
11.1	Adjusting the spring preload of the shock absorber  .....	97	12.15	Removing the battery cover .....	118
11.2	Adjusting the shift lever.....	98	12.16	Mounting the battery cover.....	120
12	SERVICE WORK ON THE CHASSIS.....	100	12.17	Removing the front spoiler .....	121
12.1	Raising the motorcycle with rear lifting gear .....	100	12.18	Fitting front spoiler .....	122
12.2	Removing the rear of the motorcycle from the lifting gear.....	100	12.19	Removing the left side cover  .....	124
12.3	Lifting the motorcycle with the front lifting gear.....	101	12.20	Installing the left side cover  .....	125
12.4	Taking the motorcycle off the front lifting gear .....	103	12.21	Removing the right side cover  .....	127
12.5	Cleaning the dust boots of the fork legs .....	104	12.22	Installing the right side cover  .....	128
12.6	Removing the front rider's seat .....	106	13	BRAKE SYSTEM .....	129
12.7	Mounting the front rider's seat.....	107	13.1	Anti-lock braking system (ABS) .....	129
			13.2	Checking the brake discs .....	131
			13.3	Checking the front brake fluid level .....	132
			13.4	Adding the front brake fluid  .....	133
			13.5	Checking the front brake linings.....	136

# TABLE OF CONTENTS

13.6	Checking the rear brake fluid level .....	137	15.6	Changing the low beam bulb .....	173
13.7	Adding rear brake fluid 🛠 .....	138	15.7	Changing the high beam bulb.....	175
13.8	Checking the rear brake linings .....	142	15.8	Checking the low beam headlight adjustment.....	177
13.9	Checking the free travel of foot brake lever .....	143	15.9	Checking the high beam headlight adjustment.....	179
13.10	Adjusting the free travel of the foot brake lever 🛠.....	145	15.10	Adjusting the headlight range of the low beam.....	180
14	WHEELS, TIRES .....	147	15.11	Adjusting the headlight range of the high beam .....	181
14.1	Removing the front wheel 🛠.....	147	15.12	Diagnostics connector .....	182
14.2	Installing the front wheel 🛠 .....	148	15.13	Front ACC1 and ACC2 .....	182
14.3	Removing the rear wheel 🛠.....	150	16	COOLING SYSTEM .....	183
14.4	Installing the rear wheel 🛠.....	152	16.1	Cooling system .....	183
14.5	Checking the rear hub damping rubber pieces 🛠.....	155	16.2	Checking the coolant level in the compensating tank.....	185
14.6	Checking the tire condition .....	157	16.3	Checking the antifreeze and coolant level .....	187
14.7	Checking tire pressure .....	159	16.4	Correcting the coolant level in the compensating tank.....	190
15	ELECTRICAL SYSTEM .....	161	16.5	Draining the coolant 🛠 .....	191
15.1	Removing the 12-V battery 🛠.....	161	16.6	Filling/bleeding the cooling system 🛠 .....	193
15.2	Installing the 12-V battery 🛠.....	163	16.7	Changing the coolant 🛠.....	196
15.3	Charging the 12-V battery 🛠 .....	164			
15.4	Changing the ABS fuses .....	167			
15.5	Changing the fuses of individual power consumers .....	170			



17	TUNING THE ENGINE.....	200	22.2	Engine tightening torques .....	223
17.1	Checking throttle cable play.....	200	22.3	Capacities .....	227
17.2	Adjusting throttle cable play  .....	201	22.3.1	Engine oil .....	227
17.3	Checking the clutch lever play.....	201	22.3.2	Coolant .....	227
17.4	Adjusting play in the clutch lever  .....	203	22.3.3	Fuel .....	227
18	SERVICE WORK ON THE ENGINE .....	204	22.4	Chassis .....	228
18.1	Checking the engine oil level.....	204	22.5	Electrical system.....	229
18.2	Changing the engine oil and oil filter, cleaning the oil screen  .....	205	22.6	Tires .....	230
18.3	Adding engine oil .....	208	22.7	Fork.....	231
19	CLEANING, CARE .....	211	22.8	Shock absorber .....	231
19.1	Cleaning the motorcycle .....	211	22.9	Chassis tightening torques .....	231
19.2	Checks and maintenance steps for winter operation.....	214	23	SUBSTANCES .....	238
20	STORAGE.....	216	24	AUXILIARY SUBSTANCES .....	242
20.1	Storage .....	216	25	STANDARDS .....	244
20.2	Preparing for use after storage.....	218	26	INDEX OF SPECIAL TERMS .....	245
21	TROUBLESHOOTING .....	219	27	LIST OF ABBREVIATIONS.....	246
22	TECHNICAL DATA.....	222	28	LIST OF SYMBOLS.....	247
22.1	Engine .....	222	28.1	Yellow and orange symbols.....	247
			28.2	Green and blue symbols.....	247
			INDEX.....		248

# 1 MEANS OF REPRESENTATION

## 1.1 Symbols used

The meaning of specific symbols is described below.

---



Indicates an expected reaction (e.g. of a work step or a function).



Indicates an unexpected reaction (e.g. of a work step or a function).



All work marked with this symbol requires specialist knowledge and technical understanding. In the interest of your own safety, have these jobs performed by an authorized KTM workshop! Your motorcycle will be optimally cared for there by specially trained experts using the auxiliary tools required.



Indicates a page reference (more information is provided on the specified page).



Indicates information with more details or tips.



Indicates the result of a testing step.

---

<b>V</b>	Indicates a voltage measurement.
<b>A</b>	Indicates a current measurement.
	Indicates the end of an activity, including potential rework.

---

## 1.2 Formats used

The typographical formats used in this document are explained below.

---

<b>Proprietary name</b>	Indicates a proprietary name.
<b>Name®</b>	Indicates a protected name.
<b>Brand™</b>	Indicates a brand available on the open market.
<b><u>Underlined terms</u></b>	Refer to technical details of the vehicle or indicate technical terms, which are explained in the glossary.

---

## 2 SAFETY ADVICE

### 2.1 Use definition – intended use

This vehicle has been designed and built to withstand the normal stresses and strains of road use. This vehicle is not suitable for use on race tracks or offroad.



#### Info

This vehicle is only authorized for operation on public roads in its homologated version.

---

### 2.2 Misuse

The vehicle must only be used as intended.

Dangers can arise for people, property and the environment through use not as intended.

Any use of the vehicle beyond the intended and defined use constitutes misuse.

Misuse also includes the use of operating and auxiliary fluids which do not meet the required specification for the respective use.

### 2.3 Safety advice

A number of safety instructions need to be followed to operate the product described safely. Therefore read this instruction and all further instructions included carefully. The safety instructions are highlighted in the text and are referred to at the relevant passages.

**Info**

Various information and warning labels are attached in prominent locations on the product described. Do not remove any information or warning labels. If they are missing, you or others may not recognize dangers and may therefore be injured.

---

## 2.4 Degrees of risk and symbols

---

**Danger**

Identifies a danger that will immediately and invariably lead to fatal or serious permanent injury if the appropriate measures are not taken.

**Warning**

Identifies a danger that is likely to lead to fatal or serious injury if the appropriate measures are not taken.

**Caution**

Identifies a danger that may lead to minor injuries if the appropriate measures are not taken.

**Note**

Identifies a danger that will lead to considerable machine and material damage if the appropriate measures are not taken.

**Note**

Indicates a danger that will lead to environmental damage if the appropriate measures are not taken.

---

### 2.5 Tampering warning

Tampering with the noise control system is prohibited. Federal law prohibits the following acts or the causing thereof:

- 1 The removal or rendering inoperative by any person other than for purposes of servicing, repair, or replacement, of any device or element of design incorporated into any new vehicle for the purpose of noise control prior to its sale or delivery to the ultimate purchaser or while it is in use, or
- 2 the use of the vehicle after such device or element of design has been removed or rendered inoperative by any person.

Among those acts presumed to constitute tampering are the acts listed below:

- 1 Removal or puncturing of the main silencers, baffles, header pipes or any other components which conduct exhaust gases.
- 2 Removal or puncturing of parts of the intake system.
- 3 Lack of proper maintenance.
- 4 Replacing moving parts of the vehicle, or parts of the exhaust system or intake system, with parts other than those specified by the manufacturer.

### 2.6 Safe operation



#### **Danger**

**Danger of accidents** A rider who is not fit to ride poses a danger to him or herself and others.

- Do not operate the vehicle if you are not fit to ride due to alcohol, drugs or medication.
- Do not operate the vehicle if you are physically or mentally impaired.

**Danger**

**Danger of poisoning** Exhaust gases are toxic and inhaling them may result in unconsciousness and death.

- Always make sure there is sufficient ventilation when running the engine.
- Use effective exhaust extraction when starting or running the engine in an enclosed space.

**Warning**

**Danger of burns** Some vehicle components become very hot when the vehicle is operated.

- Do not touch any parts such as the exhaust system, radiator, engine, shock absorber, or brake system before the vehicle parts have cooled down.
- Let the vehicle parts cool down before you perform any work on the vehicle.

---

Only operate the vehicle when it is in perfect technical condition, in accordance with its intended use, and in a safe and environmentally compatible manner.

An appropriate driver's license is needed to ride the vehicle on public roads.

Have malfunctions that impair safety promptly eliminated by an authorized KTM workshop.

Adhere to the information and warning labels on the vehicle.

## 2.7 Protective clothing

**Warning**

**Risk of injury** Missing or poor protective clothing presents an increased safety risk.

- Wear appropriate protective clothing such as helmet, boots, gloves as well as trousers and a jacket with protectors on all rides.
- Always wear protective clothing that is in good condition and meets the legal regulations.

## 2 SAFETY ADVICE

In the interest of your own safety, KTM recommends that you only operate the vehicle while wearing protective clothing.

### 2.8 Work rules

Unless specified otherwise, the ignition must be turned off during all work (models with ignition lock, models with remote key) or the engine must be at a standstill (models without ignition lock or remote key).

Special tools are necessary for certain tasks. The tools are not a component of the vehicle, but can be ordered using the number in parentheses. Example: bearing puller (15112017000)

During assembly, use new parts to replace parts which cannot be reused (e.g. self-locking screws and nuts, seals, sealing rings, O-rings, pins, and lock washers).

In the case of certain screws, a screw adhesive (e.g. **Loctite**<sup>®</sup>) is required. Observe the manufacturer's instructions.

If thread locker (e.g., **Precote**<sup>®</sup>) has already been applied to a new part, do not apply any additional thread locker. After disassembly, clean the parts that are to be reused and check them for damage and wear. Change damaged or worn parts.

After completing a repair or service work, check the operating safety of the vehicle.

### 2.9 Environment

If you use your motorcycle responsibly, you can ensure that problems and conflicts do not occur. To protect the future of the motorcycle sport, make sure that you use your motorcycle legally, display environmental consciousness, and respect the rights of others.

When disposing of used oil, other operating and auxiliary fluids, and used components, comply with the laws and regulations of the respective country.



Because motorcycles are not subject to the EU regulations governing the disposal of used vehicles, there are no legal regulations that pertain to the disposal of an end-of-life motorcycle. Your authorized KTM dealer will be glad to advise you.

## **2.10 Owner's Manual**

It is important that you read this Owner's Manual carefully and completely before making your first trip. The Owner's Manual contains useful information and many tips on how to operate, handle, and service your motorcycle. Only then will you find out how to customize the vehicle ideally for your own use and how you can protect yourself from injury.

Keep the Owner's Manual in an accessible place to enable you to refer to it as needed.

If you would like to know more about the vehicle or have questions on the material you read, please contact an authorized KTM dealer.

The Owner's Manual is an important component of the vehicle and must be handed over to the new owner if the vehicle is sold.

The Owner's Manual is also available for download from your authorized KTM dealer and on the KTM website. International KTM Website: <http://www.ktm.com>

## 3 IMPORTANT NOTES

### 3.1 Manufacturer and implied warranty

The work specified in the service schedule may only be performed in an authorized KTM workshop and must be recorded in both the Service & Warranty Booklet and in the **KTM Dealer.net**, otherwise any warranty coverage will become void. Damage or secondary damage caused by tampering with and/or conversions on the vehicle is not covered by the manufacturer warranty.

Additional information on the manufacturer or manufacturer warranty and the procedures involved can be found in the Service & Warranty Booklet.

### 3.2 Fuel, auxiliary substances



#### Note

**Environmental hazard** Improper handling of fuel is a danger to the environment.

- Do not allow fuel to enter the groundwater, the soil, or the sewage system.

Use fuels and auxiliary substances in accordance with the Owner's Manual and specification.

### 3.3 Spare parts, accessories

For your own safety, only use spare parts and accessory products that are approved and/or recommended by KTM and have them installed by an authorized KTM workshop. KTM accepts no liability for other products and any resulting damage or loss.

Certain spare parts and accessory products are specified in parentheses in the descriptions. Your authorized KTM dealer will be glad to advise you.

The current **KTM PowerParts** for your vehicle can be found on the KTM website.  
International KTM Website: <http://www.ktm.com>

### **3.4 Service**

A prerequisite for perfect operation and prevention of premature wear is that the service, care, and tuning work on the engine and chassis is properly carried out as described in the Owner's Manual. An incorrect suspension setting can lead to damage and breakage of chassis components.

Use of the vehicle under difficult conditions, such as in heavy rain, intense heat or with a heavy payload, may result in significantly increased wear of components such as the drive train, brake system, or suspension components. For this reason, it may be necessary to inspect or replace parts before the next scheduled service.

It is imperative that you adhere to the stipulated run-in times and service intervals. If you observe these exactly, you will ensure a much longer service life for your motorcycle.

The relevant mileage or time interval is whichever occurs first.

### **3.5 Figures**

The figures contained in the manual may depict special equipment.

In the interest of clarity, some components may be shown disassembled or may not be shown at all. It is not always necessary to disassemble the component to perform the activity in question. Please follow the instructions in the text.

### **3.6 Customer service**

Your authorized KTM dealer will be happy to answer any questions you may have on your vehicle and KTM.

### 3 IMPORTANT NOTES

A list of authorized KTM dealers can be found on the KTM website.  
International KTM Website: <http://www.ktm.com>



# 4 VIEW OF VEHICLE

## 4.1 View of vehicle, front left (example)

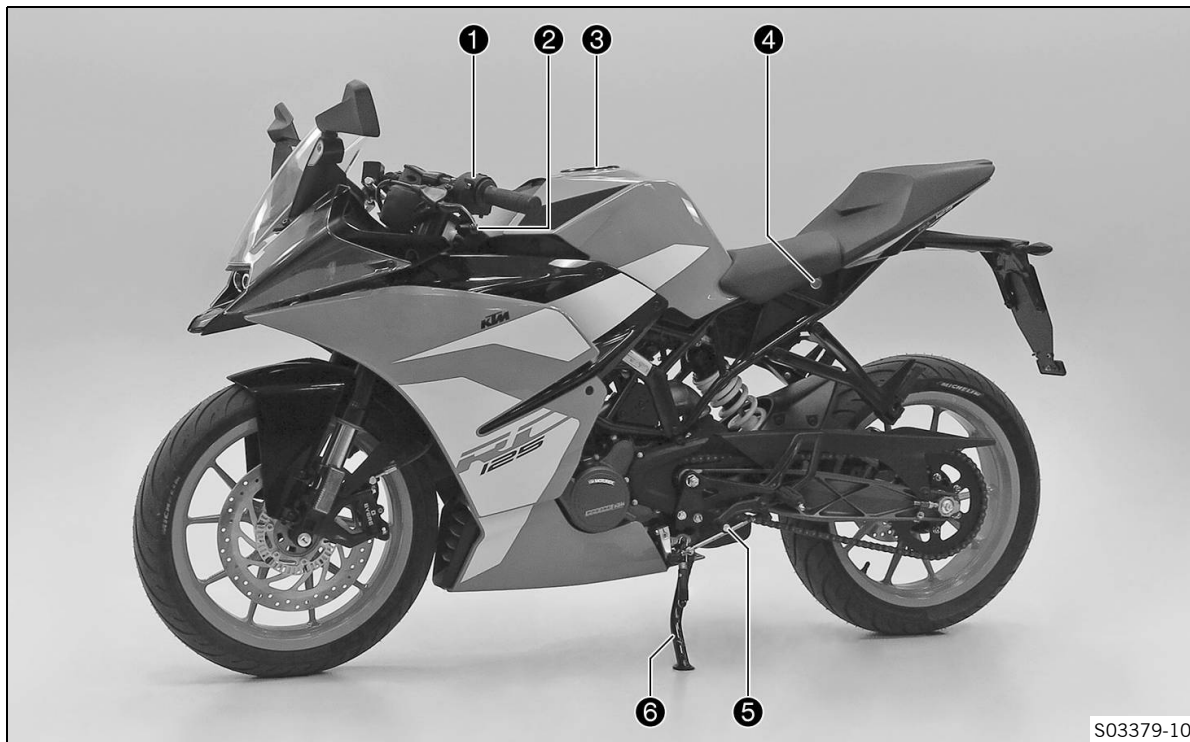

- ① Horn button (📖 p. 27)
- ① Light switch (📖 p. 28)
- ① High beam flasher button (📖 p. 28)
- ① Turn signal switch (📖 p. 29)
- ② Clutch lever (📖 p. 26)
- ③ Fuel tank filler cap
- ④ Seat lock (📖 p. 36)
- ⑤ Shift lever (📖 p. 38)
- ⑥ Side stand (📖 p. 39)

# 4 VIEW OF VEHICLE

## 4.2 View of vehicle, rear right (example)

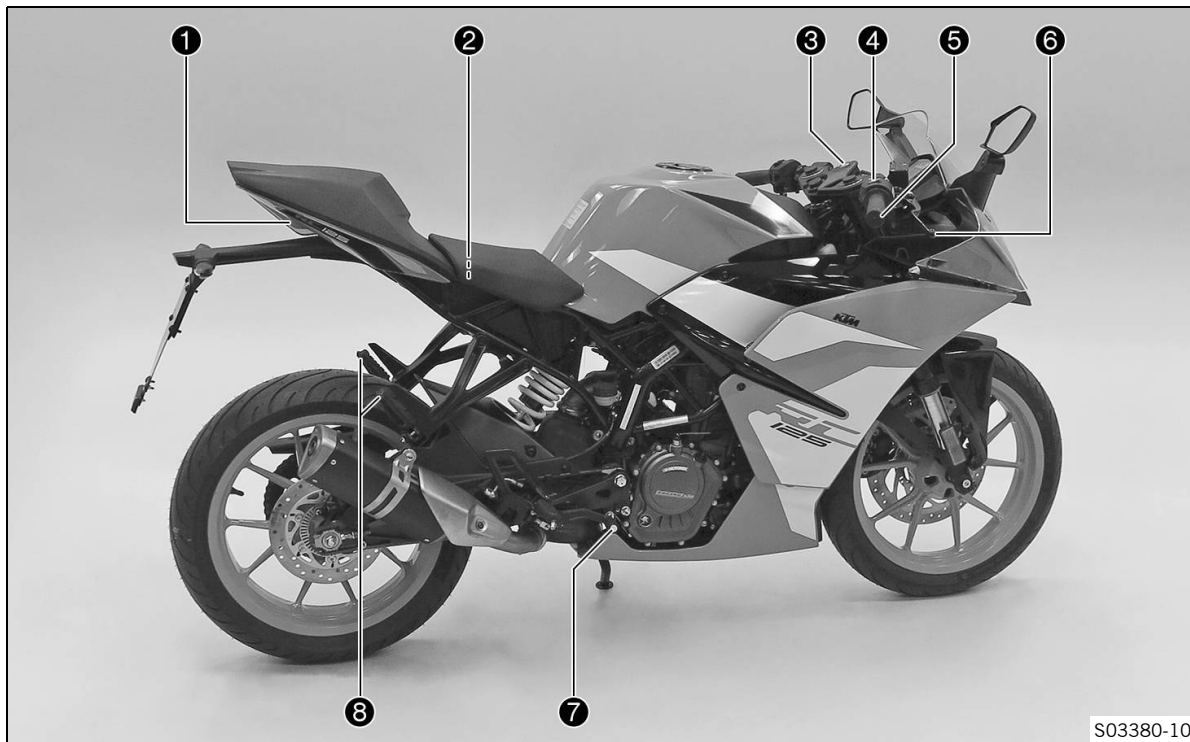



- ① Grab handles (📖 p. 37)
- ② Tool set (📖 p. 36)
- ③ Ignition and steering lock (📖 p. 31)
- ④ Emergency OFF switch (📖 p. 30)
- ④ Start button (📖 p. 30)
- ⑤ Throttle grip (📖 p. 27)
- ⑥ Hand brake lever (📖 p. 26)
- ⑦ Foot brake lever (📖 p. 39)
- ⑧ Passenger foot pegs (📖 p. 37)

# 5 SERIAL NUMBERS

## 5.1 Vehicle identification number

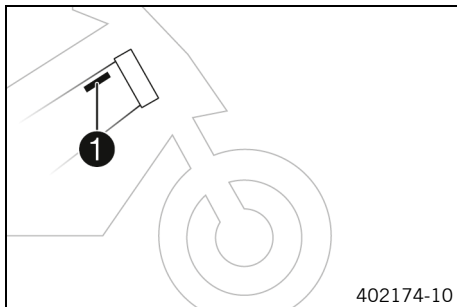

The vehicle identification number **1** is stamped on the right of the frame behind the steering head.

## 5.2 Type label

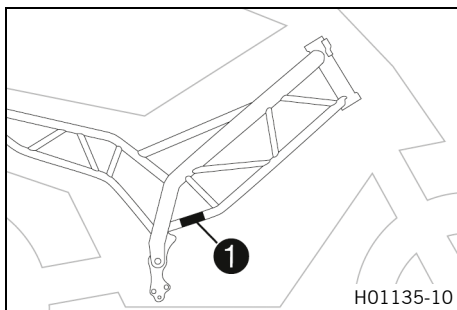

The type label **1** is located on the right side of the frame.

## 5.3 Engine number

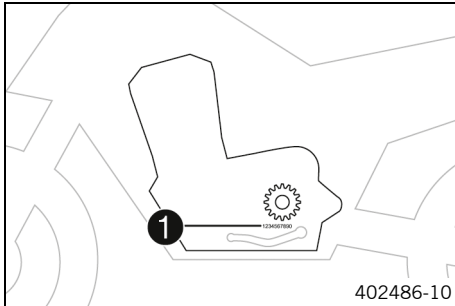

The engine number **1** is stamped on the left side of the engine under the engine sprocket.

## 5.4 Key number

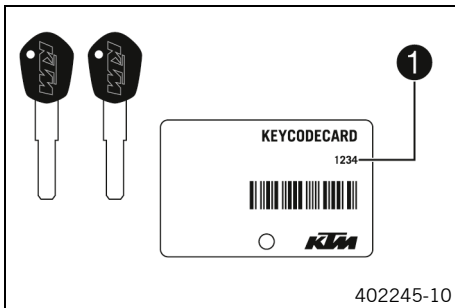

The key number **1** can be found on the **KEYCODECARD**.

### **i** Info

You need the key number to order a spare key. Keep the **KEYCODECARD** in a safe place. If at least one ignition key is still available, a spare key can be produced. If an ignition key is no longer present, the entire lock system must be replaced.

# 6 CONTROLS

## 6.1 Clutch lever



The clutch lever **1** is fitted on the left side of the handlebar.

## 6.2 Hand brake lever

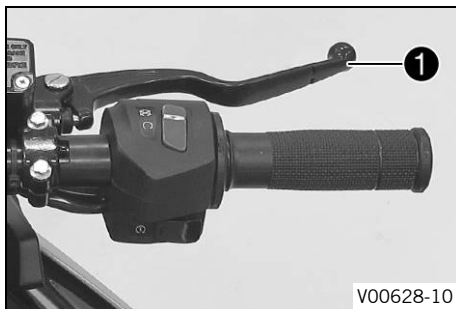

The hand brake lever **1** is fitted on the right side of the handlebar.  
The front brake is engaged using the hand brake lever.

## 6.3 Throttle grip

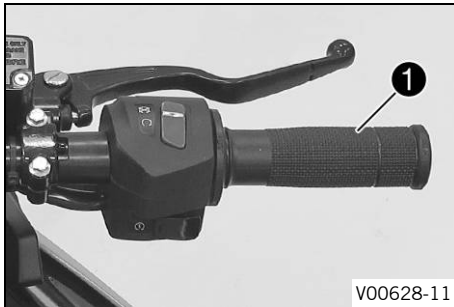

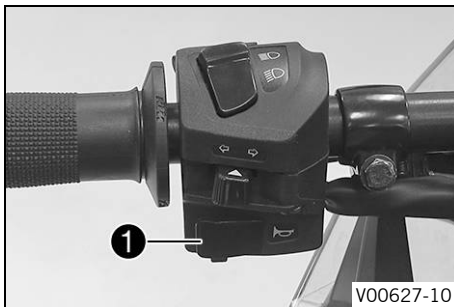

The throttle grip **1** is fitted on the right side of the handlebar.

## 6.4 Horn button



Horn button **1** is fitted on the left side of the handlebar.

### Possible states

- The horn button  is in the basic position
- The horn button  is pressed – The horn is operated in this position.



# 6 CONTROLS

## 6.5 Light switch



Light switch **1** is fitted on the left side of the handlebar.

### Possible states

	Low beam on – The light switch is turned downward. In this position, the low beam and tail light are switched on.
	High beam on – The light switch is turned upwards. In this position, the high beam and the tail light are switched on.

## 6.6 High beam flasher button



High beam flasher button **1** is fitted on the left side of the handlebar.

### Possible states

- High beam flasher button in the basic position
- High beam flasher button pressed – In this position, the headlight flasher (high beam) is actuated.

## 6.7 Turn signal switch



The turn signal switch ① is fitted on the left side of the handlebar.

### Possible states

	Turn signal off
←	Turn signal, left, on – Turn signal switch pressed to the left. The turn signal switch returns automatically to the central position after use.
→	Turn signal, right, on – Turn signal switch pressed to the right. The turn signal switch returns automatically to the central position after use.

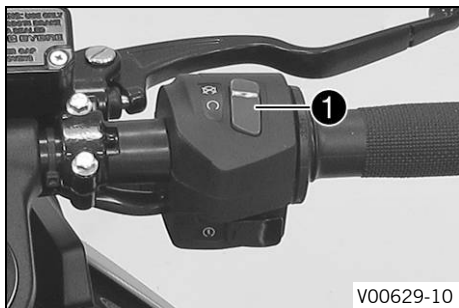

To switch off the turn signal, press the turn signal switch towards the switch case.

## 6.8 Emergency OFF switch



The emergency OFF switch **1** is fitted on the right side of the handlebar.

### Possible states

	Emergency OFF switch off – In this position, the ignition circuit is interrupted, a running engine stops, and a non-running engine cannot be started.
	Emergency OFF switch on – This position is required for operation; the ignition circuit is closed.

## 6.9 Start button

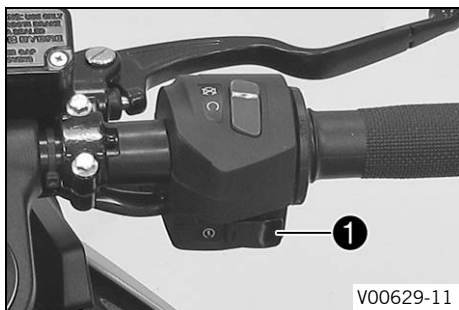

Start button **1** is fitted on the right side of the handlebar.

### Possible states

- The start button **1** is in the basic position
- The start button **1** is pressed – In this position, the starter motor is actuated.



## 6.10 Ignition and steering lock



The ignition and steering lock is located in front of the upper triple clamp.

### Possible states

	<p>Ignition off <b>OFF</b> – In this position, the ignition circuit is interrupted, a running engine stops, and a non-running engine will not start. The ignition key can be removed.</p>
	<p>Ignition on <b>ON</b> – In this position, the ignition circuit is closed and the engine can be started.</p>
	<p>Steering locked – In this position, the ignition circuit is interrupted and the steering locked. The ignition key can be removed.</p>

## 6.11 Locking the steering

### Note

**Danger of damage** The parked vehicle can roll away or fall over.

- Park the vehicle on a firm and level surface.

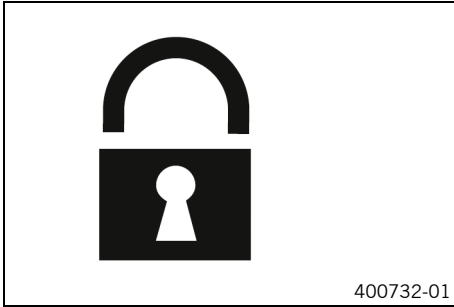

- Park the vehicle.
- Turn the handlebar all the way to the left.
- Insert the ignition key into the ignition and steering lock, press in, and turn to the left. Remove the ignition key.
- ✓ Steering is no longer possible.

### 6.12 Unlocking the steering

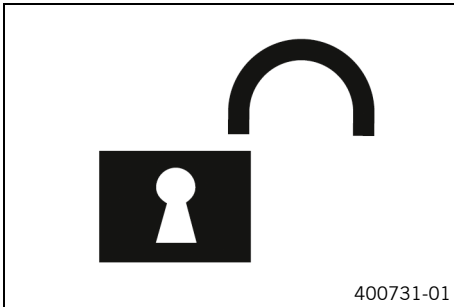

- Insert the ignition key into the ignition and steering lock, press in, and turn to the right. Remove the ignition key.
- ✓ The handlebar can now be moved again.

## 6.13 Opening fuel tank filler cap



### **Danger**

**Fire hazard** Fuel is highly flammable.

The fuel in the fuel tank expands when warm and can escape if overfilled.

- Do not refuel the vehicle in the vicinity of open flames or lit cigarettes.
- Switch off the engine for refueling.
- Make sure that no fuel is spilled; particularly not on hot parts of the vehicle.
- If any fuel is spilled, wipe it off immediately.
- Observe the specifications for refueling.



### **Warning**

**Danger of poisoning** Fuel is poisonous and a health hazard.

- Avoid skin, eye and clothing contact with fuel.
- Immediately consult a doctor if you swallow fuel.
- Do not inhale fuel vapors.
- In case of skin contact, rinse the affected area with plenty of water.
- Rinse the eyes thoroughly with water, and consult a doctor in case of fuel contact with the eyes.
- Change your clothing in case of fuel spills on them.
- Keep fuels correctly in a suitable canister, and out of the reach of children.



### Note

**Environmental hazard** Improper handling of fuel is a danger to the environment.

- Do not allow fuel to enter the groundwater, the soil, or the sewage system.

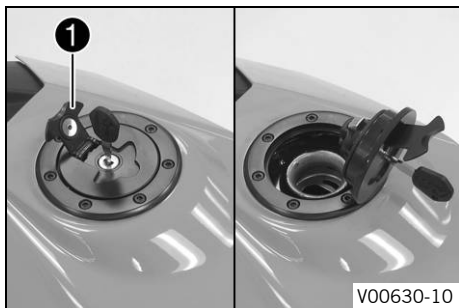

- Lift cover **1** of the fuel tank filler cap and insert the ignition key into the lock.

### Note

**Danger of damage** The ignition key may break if overloaded. Damaged ignition keys must be replaced.

- Push down on the fuel tank filler cap to take pressure off the ignition key.
- Turn the ignition key 90° clockwise.
- Lift the fuel tank filler cap.
- Remove the ignition key.

## 6.14 Closing the fuel tank filler cap

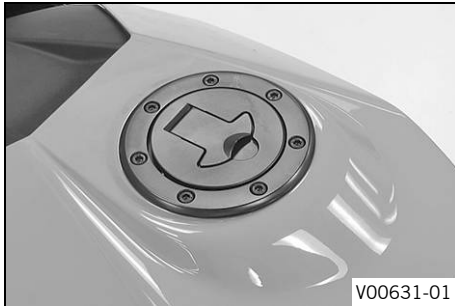

### Warning

**Fire hazard** Fuel is highly flammable, toxic and a health hazard.

- Check that the fuel tank filler cap is locked correctly after closing.
- Change your clothing if fuel spills on them.
- Rinse the affected area immediately with plenty of water in the event of contact with the skin.

- Close the fuel tank filler cap.
- Push down the fuel tank filler cap until the lock engages.



## 6 CONTROLS

### 6.15 Seat lock

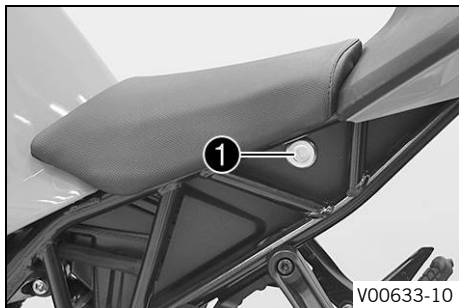

The seat lock **1** is located to the left of the seat.  
The seat lock can be unlocked using the ignition key.

### 6.16 Tool set

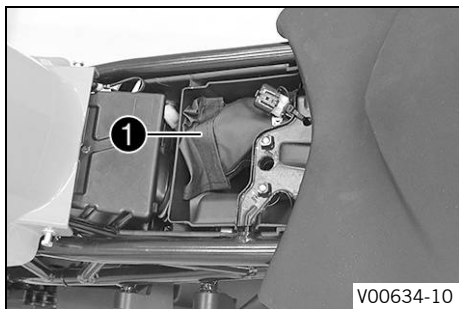

The tool set **1** is in the storage compartment under the seat.

## 6.17 Grab handles

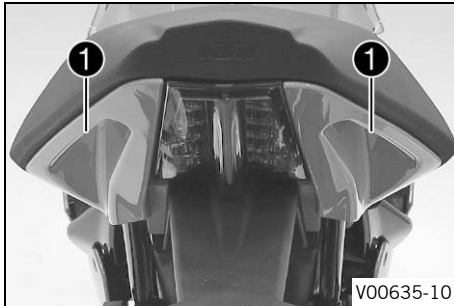

The grab handles ① are used for moving the motorcycle around. If you carry a passenger, the passenger can hold onto the grab handles during the trip.

## 6.18 Passenger foot pegs

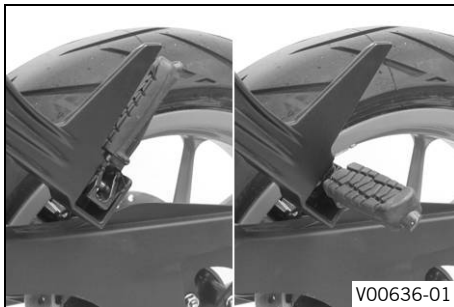

The passenger foot pegs can be folded up and down.

### Possible states

- Passenger foot pegs folded up – For operation without a passenger.
- Passenger foot pegs folded down – For operation with a passenger.

## 6.19 Shift lever

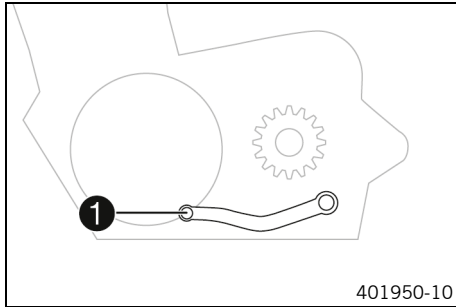

Shift lever ① is mounted on the left side of the engine.

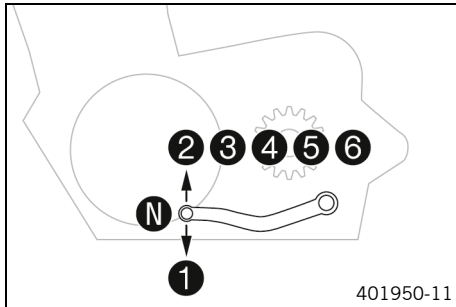

The gear positions can be seen in the photograph.  
The neutral or idle position is between the first and second gears.



## 6.20 Foot brake lever

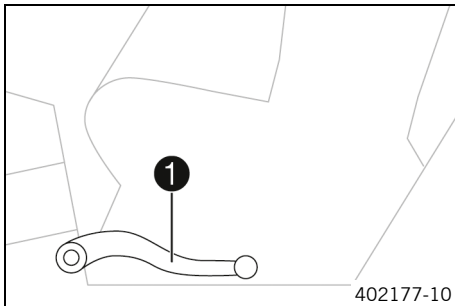

Foot brake lever **1** is located in front of the right footrest. The foot brake lever is used to activate the rear brake.

## 6.21 Side stand

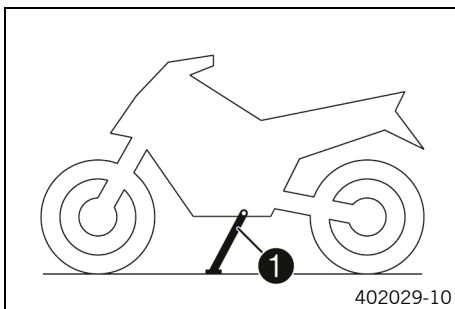

The side stand **1** is located on the left of the vehicle. The side stand is used for parking the motorcycle.

### **i** Info

The side stand must be folded up during motorcycle use. The side stand is coupled with the safety starting system; follow the riding instructions.

### Possible states

- Side stand folded out – The vehicle can be supported on the side stand. The safety starting system is active.

- Side stand folded in – This position is mandatory when riding the motorcycle. The safety starting system is inactive.

## 7.1 Combination instrument

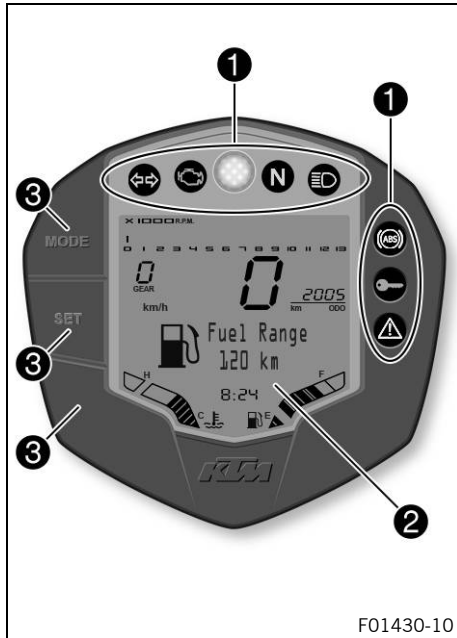

The combination instrument is attached in front of the handlebar.

- 1** Indicator lamps (📖 p. 48)
- 2** Display (📖 p. 52)
- 3** Function buttons (📖 p. 55)

# 7 COMBINATION INSTRUMENT

## 7.2 Activation and test



### Activation

The combination instrument is activated when the ignition is switched on.



### Info

The brightness of the displays is controlled by an ambient light sensor in the combination instrument.

### Test

When the ignition is switched on, all indicator lamps light up briefly except for the turn signal indicator lamp and immobilizer indicator lamp.

The segments of the tachometer and the gear display light up and switch off in sequence.

The speedometer counts from 0 to 199 and back.

The remaining display segments of the display light up briefly.

The **READY TO >> RACE** logo appears on the display.

The display then changes to the last selected mode.

**Info**

The malfunction indicator lamp always lights up as long as the engine is not running. If the engine is running and the malfunction indicator lamp lights up, stop (taking care not to endanger yourself or other road users in the process) and contact an authorized KTM workshop.

The ABS warning lamp lights up so long as a speed of approx. 6 km/h (approx. 4 mph) or more has been reached.

---

**7.3****Warnings****Info**

All existing warnings are displayed on the **Info** display until these are no longer active.

As soon as a malfunction occurs, the relevant indicator lamps light up to signal that an indication/warning note for the operating safety has been detected.

As soon as a warning for operating safety has been detected, the general warning lamp  also flashes.

---

# 7 COMBINATION INSTRUMENT



If a malfunction has occurred in the CAN bus, various warnings appear on the display:  
**CAN FAILURE**, **CAN ABS FAILURE** and **CAN EMS FAILURE** can appear.

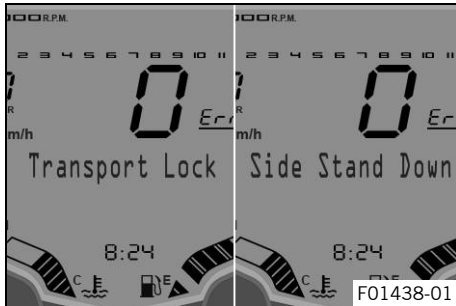

**Transport Lock** appears on the display if transport mode is activated.  
**Side Stand Down** appears on the display if the side stand is folded down.

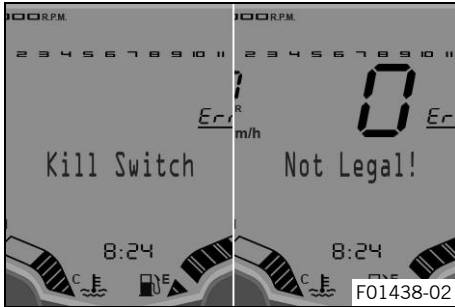

**Kill Switch** appears on the display if the emergency off switch is pressed.

**Not Legal!** appears on the display if the approval for road use is invalidated by modifications.

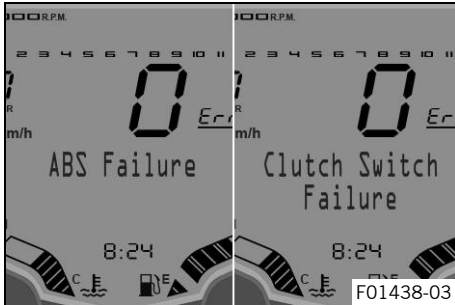

**ABS Failure** appears on the display if the ABS is no longer active.

**Clutch Switch Failure** appears on the display if the clutch switch is faulty.

# 7 COMBINATION INSTRUMENT

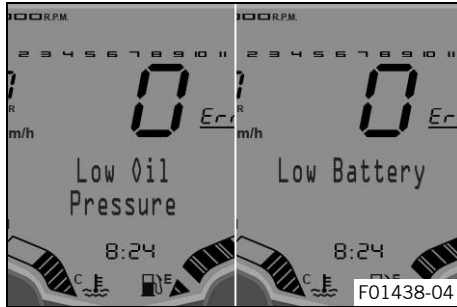

**Low Oil Pressure** appears on the display if the oil pressure is too low.

**Low Battery** appears on the display if the battery voltage falls below the specified value.

Battery voltage	$\leq 10.5 \text{ V}$
-----------------	-----------------------

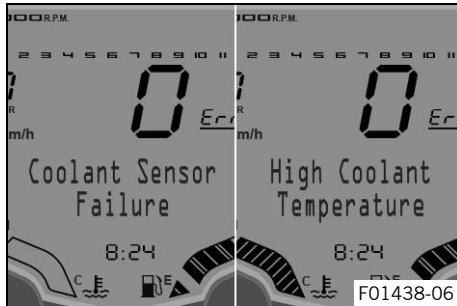

**Coolant Sensor Failure** appears on the display if the coolant temperature sensor is faulty.

**High Coolant Temperature** appears on the display if the coolant temperature rises above the specified value.

Coolant temperature	$> 110 \text{ }^{\circ}\text{C} (> 230 \text{ }^{\circ}\text{F})$
---------------------	---



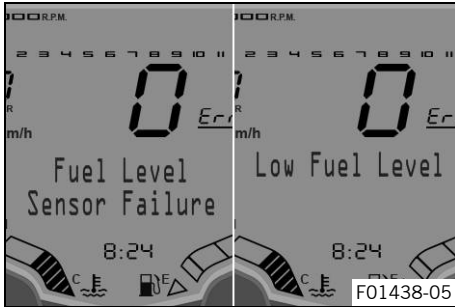

**Fuel Level Sensor Failure** appears on the display if the fuel level indicator is faulty.

**Low Fuel Level** appears on the display if the fuel level reaches the reserve mark.

## 7.4 Indicator lamps



The indicator lamps offer additional information about the operating state of the motorcycle.

When the ignition is switched on, all indicator lamps light up briefly except for the turn signal indicator lamp and immobilizer indicator lamp.

As soon as a warning for operating safety has been detected, the general warning lamp  also flashes.

### Info







The malfunction indicator lamp always lights up as long as the engine is not running. If the engine is running and the malfunction indicator lamp lights up, stop (taking care not to endanger yourself or other road users in the process) and contact an authorized KTM workshop.

The ABS warning lamp lights up so long as a speed of approx. 6 km/h (approx. 4 mph) or more has been reached.

### Possible states



The turn signal indicator lamp flashes green simultaneously with the turn signal – The turn signal is switched on.

	<p>Malfunction indicator lamp lights up yellow – The <u>OBD</u> has detected a malfunction in the vehicle electronics. Come safely to a halt, and contact an authorized KTM workshop.</p>
	<p>The shift warning lights up/flashes red – The shift warning light flashes red when the set shift speed <b>RPM1</b> is reached. The shift warning light lights up red when the set shift speed <b>RPM2</b> is reached.</p>
	<p>The idle indicator lamp lights up green – The transmission is in neutral.</p>
	<p>The high beam indicator lamp lights up blue – The high beam is switched on.</p>
	<p>ABS warning lamp lights up yellow – Status or error messages relating to <u>ABS</u>.</p>
	<p>The immobilizer indicator lamp lights up red – Status or error message for immobilizer.</p>
	<p>The general warning lamp flashes yellow – A note/warning note on operating safety has been detected. This is also shown in the display.</p>

# 7 COMBINATION INSTRUMENT

## 7.5 Shift warning light



The shift warning light ① is located in the center above the display.



### Info

The shift warning light can be configured in the **Trip 1** display and **Trip 2** display by keeping the **MODE** button pressed.

The shift warning light is always active during the running-in phase (up to 1,000 km / 621 mi). The shift warning light can only be deactivated, and the values for **RPM1** and **RPM2** can only be adjusted after this. The shift warning light flashes red at **RPM1** and the shift warning light lights up red at **RPM2**.



### Info

In sixth gear, the shift warning light is deactivated when the engine is warm after the first service.

Coolant temperature	≤ 35 °C (≤ 95 °F)
<b>ODO</b>	< 1,000 km (< 620 mi)
The shift warning light always lights up at	6,500 rpm

Coolant temperature	> 35 °C (> 95 °F)
<b>ODO</b>	> 1,000 km (> 620 mi)
<b>RPM1</b> shift warning light	flashes
<b>RPM2</b> shift warning light	lights up

# 7 COMBINATION INSTRUMENT

## 7.6 Display

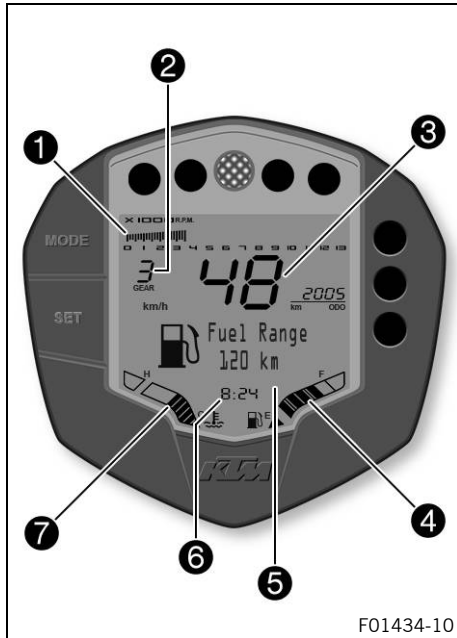

The tachometer **1** shows the engine speed in revolutions per minute.

The gear display **2** shows the engaged gear.

Speed **3** is shown in kilometers per hour **km/h** or in miles per hour **mph**.

The fuel level display is displayed in the **4** area.

The display **5** shows additional information.

The time appears in area **6**.

The coolant temperature display appears in area **7**.

### **i** Info

The time must be reset if the 12-V battery was disconnected from the vehicle or the fuse was removed. The brightness of the displays is controlled by an ambient light sensor in the combination instrument.

## 7.7 Fuel level display



F01435-10

The fuel tank contents are shown in area ❶ of the display. The fuel level indicator consists of bars. The more bars are lit, the more fuel is in the fuel tank.

### **i** Info

If the fuel level is getting low, the warning **Low Fuel Level** will also appear on the display.

The fuel level is displayed with a slight delay to prevent the indicator from constantly moving while riding.

The fuel level display is not updated while the side stand is folded out or the emergency off switch is switched off.

Once the side stand is folded up and the emergency OFF switch is switched on, the fuel level display is next updated after 2 minutes.

The fuel level display flashes if the combination instrument does not receive a signal from the fuel level sensor.

## 7.8 Coolant temperature indicator

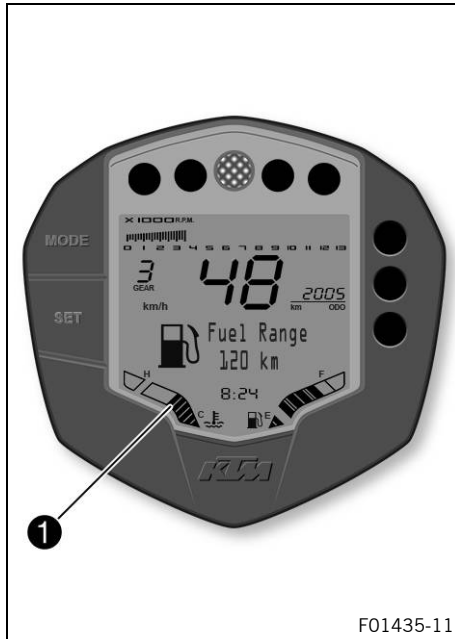

The coolant temperature display is shown in segment ❶ of the display.

The coolant temperature indicator consists of bars. The more bars that light up, the hotter the coolant.

### Note

**Engine failure** Overheating damages the engine.

- If the coolant temperature warning is displayed, stop immediately and take care not to endanger yourself or other traffic participants in the process.
- Allow the engine and cooling system to cool down.
- Check and, if necessary, correct the coolant level on the cooling system while it is in a cooled state.

### Info

When all the bars light up, the warning **High Coolant Temperature** appears on the display.

If the cooling system overheats, the maximum engine speed is limited.

### Possible states

- The engine is cold – Up to three bars light up.
- Engine warm – Four to ten bars light up.



- Engine hot – Eleven to thirteen bars light up.
- Engine very hot – All thirteen bars light up.

## 7.9 Function buttons

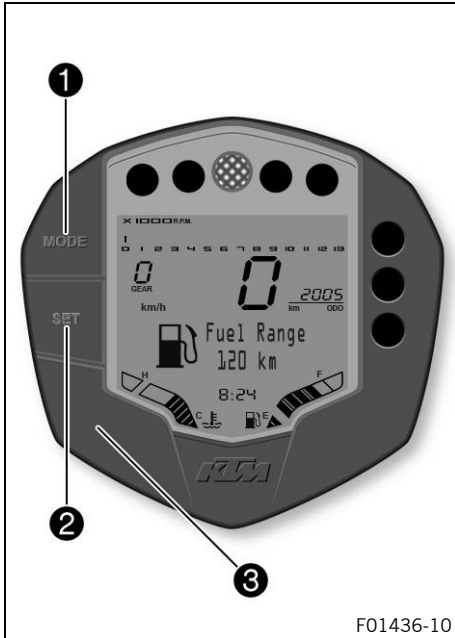

Press the **MODE** button **1** to change display modes. Possible display modes are **TRIP F** (after reaching the fuel reserve level), **Info**, total distance traveled (**ODO**), distance 1 (**TRIP 1**) and distance 2 (**TRIP 2**).

Press the **SET** button **2** to change menus within a display mode. Button **3** has no function.

## 7.10 TRIP F display

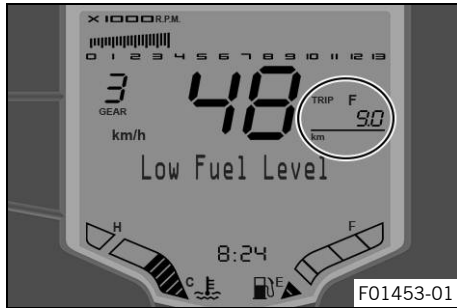

- Press the **MODE** button briefly and repeatedly until **TRIP F** appears on the display.

**TRIP F** shows the distance traveled since the fuel reserve level was reached.

### **i** Info

When the fuel level reaches the reserve mark, the warning **Low Fuel Level** appears on the display. Pressing the **MODE** button briefly changes the display mode to **TRIP F** and starts to count from **0.0**, regardless of the previously active display mode.

In the **TRIP F** display, the menus **Fuel Range** and **Actual F.C.** can also be displayed.

As soon as a warning for operating safety has been detected, the general warning lamp  also flashes.

Press the **SET** button briefly to change to the next menu in the display.

Press the **MODE** button briefly to change to the next display mode in the display.

## 7.11 Info display

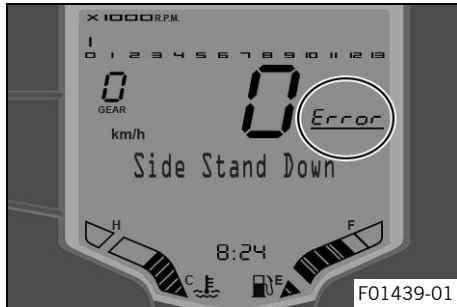

- Press the **MODE** button briefly and repeatedly until **Info** appears on the display.

**Info** shows messages or warnings that have occurred.

### **i** Info

The **Info** display is only shown if a message or warning is pending.

The warnings that have occurred are saved in the **Info** display until these are no longer active.

All warnings that have occurred are shown automatically in succession on the **Info** display.

Press the **SET** button briefly to change to the next warning in the display.

Press the **MODE** button briefly to change to the next display mode in the display.

# 7 COMBINATION INSTRUMENT

## 7.12 ODO display

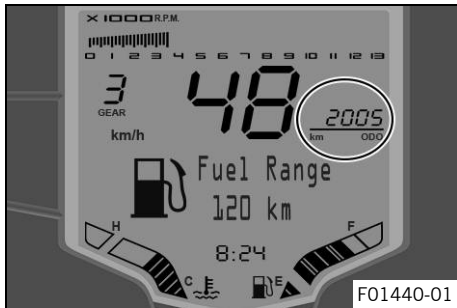

Press the **MODE** button briefly and repeatedly until **ODO** appears in the display.



### Info

**ODO** shows the total distance covered.

This value is retained, even if the 12-V battery is disconnected from the vehicle or the fuse blows.

Press the **SET** button briefly to change to the next menu in the display.

Press the **MODE** button briefly to change to the next display mode in the display.

### 7.12.1 Fuel Range

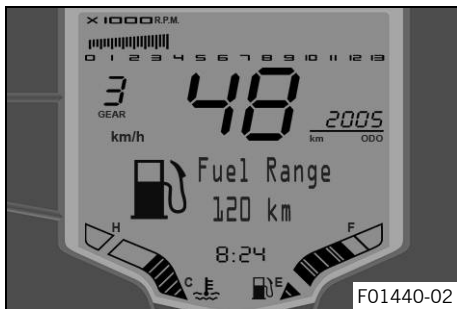

- Press the **MODE** button briefly and repeatedly until **ODO** appears on the display.
- Press the **SET** button briefly and repeatedly until the desired menu appears.

The **Fuel Range** menu is identical on the **TRIP F** display, the **ODO** display, the **TRIP 1** display and the **TRIP 2** display.

The range is shown in this menu.



### Info

The range depends on the average fuel consumption and the fuel quantity in the fuel tank.

The range is displayed after several 100 meters of travel after the ignition is switched on.

Press the <b>SET</b> button briefly.	Next menu on the display
Press the <b>MODE</b> button briefly.	Next display mode in the display

## 7.12.2 Service

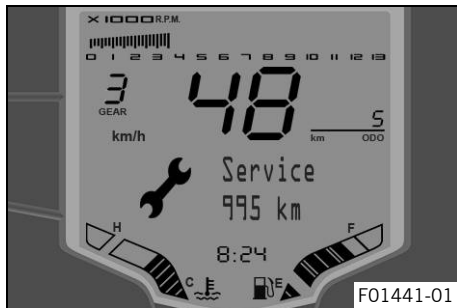

- Press the **MODE** button briefly and repeatedly until **ODO** appears on the display.
- Press the **SET** button briefly and repeatedly until the desired menu appears.

This menu shows the distance to the next service.

Press the <b>SET</b> button briefly.	Next menu on the display
--------------------------------------	--------------------------

# 7 COMBINATION INSTRUMENT

Press the <b>MODE</b> button briefly.	Next display mode in the display
---------------------------------------	----------------------------------

## 7.12.3 Actual F.C.

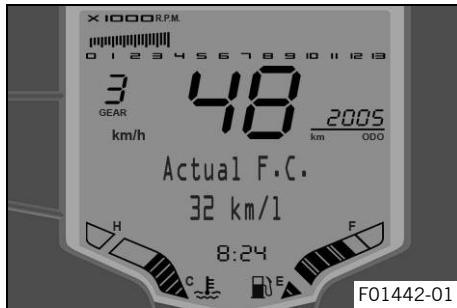

- Press the **MODE** button briefly and repeatedly until **ODO** appears on the display.
- Press the **SET** button briefly and repeatedly until the desired menu appears.

The **Actual F.C.** menu is identical on the display, the **TRIP F** display and the **ODO** display.

Current fuel consumption is shown in this menu.

---

**i Info** The current fuel consumption is displayed after several 100 meters of travel after the ignition is switched on.

---

Press the <b>SET</b> button briefly.	Next menu on the display
Press the <b>MODE</b> button briefly.	Next display mode in the display

## 7.13 TRIP 1 display

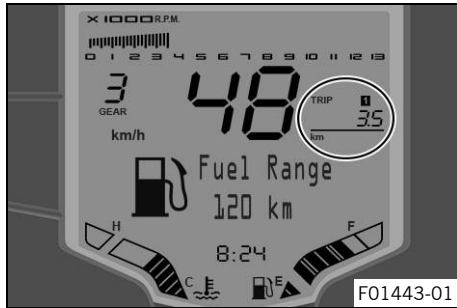

Press the **MODE** button briefly and repeatedly until **TRIP 1** appears in the display.

### **i** Info

**TRIP 1** shows the distance since the last reset, such as between two refueling stops. **TRIP 1** is always running and counts up to **9999.9**.

Press the **SET** button briefly to change to the next menu in the display.

Press the **MODE** button briefly to change to the next display mode in the display.

### 7.13.1 Time Trip 1



- Press the **MODE** button briefly and repeatedly until **TRIP 1** appears on the display.
- Press the **SET** button briefly and repeatedly until the desired menu appears.

Riding time 1 based on **TRIP 1** is shown in this menu.

Press the **SET** button briefly.

Next menu on the display

# 7 COMBINATION INSTRUMENT

Press the <b>SET</b> button for 3 seconds.	Display of <b>TRIP 1</b> is reset
Press the <b>MODE</b> button briefly.	Next display mode on the display

## 7.13.2 Average Speed Trip1

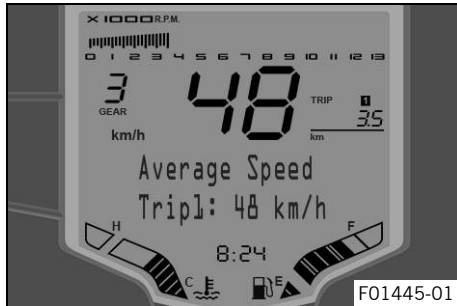

- Press the **MODE** button briefly and repeatedly until **TRIP 1** appears on the display.
- Press the **SET** button briefly and repeatedly until the desired menu appears.

Average speed 1 based on **TRIP 1** is shown in this menu.

Press the <b>SET</b> button briefly.	Next menu on the display
Press the <b>SET</b> button for 3 seconds.	Display of <b>TRIP 1</b> is reset
Press the <b>MODE</b> button briefly.	Next display mode on the display



## 7.13.3 Avg F.C. Trip 1

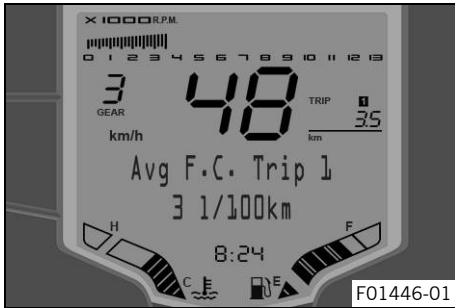

- Press the **MODE** button briefly and repeatedly until **TRIP 1** appears on the display.
- Press the **SET** button briefly and repeatedly until the desired menu appears.

Average fuel consumption 1 based on **TRIP 1** is shown in this menu.

Press the <b>SET</b> button briefly.	Next menu on the display
Press the <b>SET</b> button for 3 seconds.	Display of <b>TRIP 1</b> is reset
Press the <b>MODE</b> button briefly.	Next display mode on the display

# 7 COMBINATION INSTRUMENT

## 7.14 TRIP 2 display

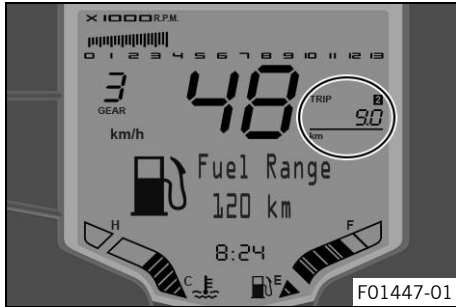

Press the **MODE** button briefly and repeatedly until **TRIP 2** appears in the display.



### Info

**TRIP 2** shows the distance since the last reset, such as between two refueling stops. **TRIP 2** is always running and counts up to **9999.9**.

Press the **SET** button briefly to change to the next menu. Press the **MODE** button briefly to change to the next display mode in the display.

### 7.14.1 Time Trip 2

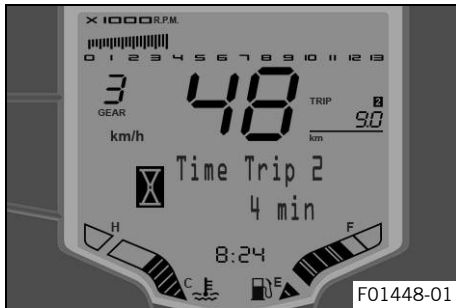

- Press the **MODE** button briefly and repeatedly until **TRIP 2** appears on the display.
- Press the **SET** button briefly and repeatedly until the desired menu appears.

Riding time 2 based on **TRIP 2** is shown in this menu.

Press the **SET** button briefly.

Next menu on the display

Press the <b>SET</b> button for 3 seconds.	Display of <b>TRIP 2</b> is reset
Press the <b>MODE</b> button briefly.	Next display mode on the display

## 7.14.2 Average Speed Trip2

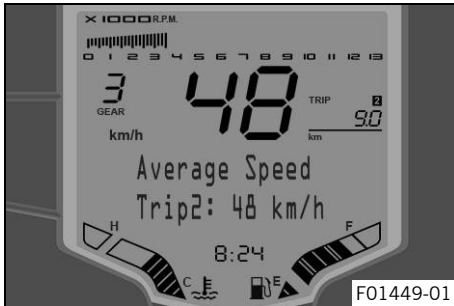

- Press the **MODE** button briefly and repeatedly until **TRIP 2** appears on the display.
- Press the **SET** button briefly and repeatedly until the desired menu appears.

Average speed 2 based on **TRIP 2** is shown in this menu.

Press the <b>SET</b> button briefly.	Next menu on the display
Press the <b>SET</b> button for 3 seconds.	Display of <b>TRIP 2</b> is reset
Press the <b>MODE</b> button briefly.	Next display mode on the display

# 7 COMBINATION INSTRUMENT

## 7.14.3 Avg F.C. Trip 2

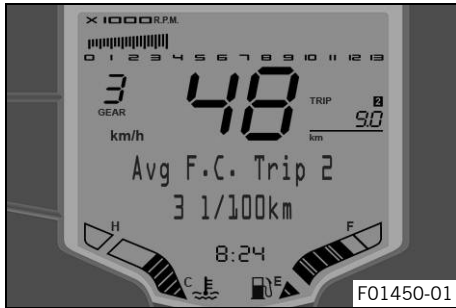

- Press the **MODE** button briefly and repeatedly until **TRIP 2** appears on the display.
- Press the **SET** button briefly and repeatedly until the desired menu appears.

Average fuel consumption 2 based on **TRIP 2** is shown in this menu.

Press the <b>SET</b> button briefly.	Next menu on the display
Press the <b>SET</b> button for 3 seconds.	Display of <b>TRIP 2</b> is reset
Press the <b>MODE</b> button briefly.	Next display mode on the display

## 7.15 Setting the units



### Info

Make the setting according to the country.

If you change the unit, the value **ODO** is retained and converted accordingly.

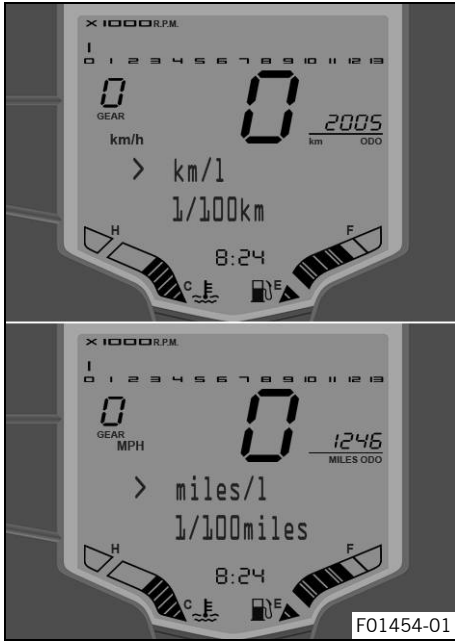

## Condition

The motorcycle is stationary.

- Press the **MODE** button briefly and repeatedly until **ODO** appears on the display.
- Press the **MODE** button for 5 seconds.
- ✓ The units display appears.



### Info

The units display is shown on the **ODO** display for each menu by keeping the **MODE** button pressed.

- Press the **SET** button briefly and repeatedly until the desired unit appears.
- Do not actuate **MODE** button and **SET** button for about 5 seconds.
- ✓ The units display disappears and the selected unit of the first line is adopted and saved.



### Info

**km** or **miles** can be set as a length unit.  
**l**, **USGa**, or **UKGa** can be set as a volume unit.

## 7.16 Setting the clock



### Info

The time is displayed in 24-hour format.

The time must be reset if the 12-V battery was disconnected from the vehicle or the fuse was removed.

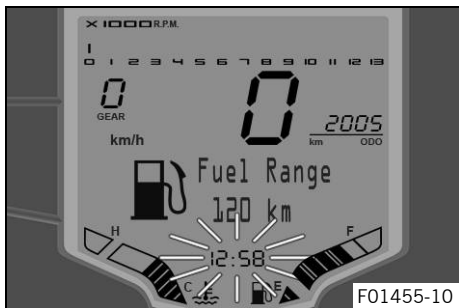

### Condition

The motorcycle is stationary.

- Press the **MODE** button briefly and repeatedly until **ODO** appears on the display.
  - Press the **MODE** button and **SET** button simultaneously for 5 seconds.
- ✓ The time display begins to flash.



### Info

The clock can be set in the **ODO** display for each menu by keeping the **MODE** button and **SET** button pressed simultaneously.

- Set the hours display using the **MODE** button.
  - Set the minutes display using the **SET** button.
  - Press the **MODE** button and **SET** button simultaneously.
- ✓ The set time is adopted and saved.

## 7.17 Adjusting the shift speed RPM1

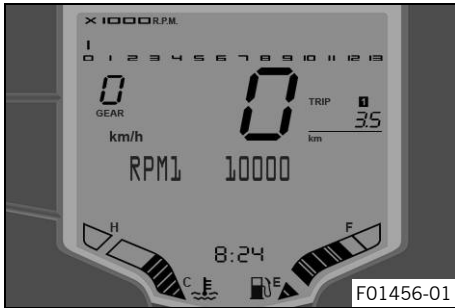

### Condition

The motorcycle is stationary.

**ODO** > 1000 km (621 mi).

- Press the **MODE** button briefly and repeatedly until **TRIP 1** appears on the display.
- Press the **MODE** button for 5 seconds.
- ✓ The **RPM1** display appears.



### Info

The **RPM1** display appears in the **TRIP 1** display for each menu by keeping the **MODE** button pressed. **RPM1** is the engine speed above which the shift warning light starts flashing. The engine speed can be set at intervals of 50. The shift speed **RPM1** can only be set up to maximum 50 revolutions per minute below the shift speed **RPM2**.

- Adjust the speed with the **MODE** button and **SET** button.



### Info

The **MODE** button increases the value.  
The **SET** button decreases the value.

- Press the **MODE** button and **SET** button simultaneously.

# 7 COMBINATION INSTRUMENT

- ✓ The **RPM1** display disappears and the set shift speed **RPM1** is adopted and saved.

## 7.18 Adjusting the shift speed RPM2

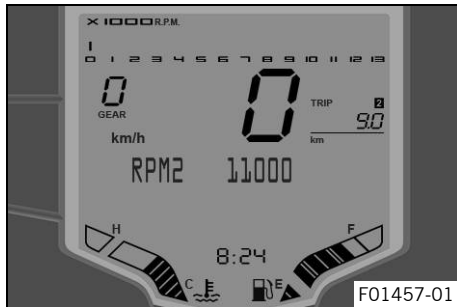

### Condition

The motorcycle is stationary.

**ODO** > 1000 km (621 mi).

- Press the **MODE** button briefly and repeatedly until **TRIP 2** appears on the display.
- Press the **MODE** button for 5 seconds.
- ✓ The **RPM2** display appears.

### Info

The **RPM2** display appears in the **TRIP 2** display for each menu by keeping the **MODE** button pressed. **RPM2** is the engine speed above which the shift warning light lights up. The engine speed can be set at intervals of 50. The shift speed **RPM2** can only be set from a minimum of 50 revolutions per minute above the shift speed **RPM1**.

- Adjust the speed with the **MODE** button and **SET** button.





## Info

The **MODE** button increases the value.  
The **SET** button decreases the value.

---

- Press the **MODE** button and **SET** button simultaneously.
  - ✓ The **RPM2** display disappears and the set shift speed **RPM2** is adopted and saved.



## 8.1 Advice on preparing for first use



### **Danger**

**Danger of accidents** A rider who is not fit to ride poses a danger to him or herself and others.

- Do not operate the vehicle if you are not fit to ride due to alcohol, drugs or medication.
- Do not operate the vehicle if you are physically or mentally impaired.



### **Warning**

**Risk of injury** Missing or poor protective clothing presents an increased safety risk.

- Wear appropriate protective clothing such as helmet, boots, gloves as well as trousers and a jacket with protectors on all rides.
- Always wear protective clothing that is in good condition and meets the legal regulations.



### **Warning**

**Danger of crashing** Different tire tread patterns on the front and rear wheel impair the handling characteristic.

Different tire tread patterns can make the vehicle significantly more difficult to control.

- Make sure that only tires with a similar tire tread pattern are fitted to the front and rear wheel.



### **Warning**

**Danger of accidents** Non-approved or non-recommended tires and wheels impact the handling characteristic.

- Only use tires/wheels approved by KTM with the corresponding speed index.



## Warning

**Danger of accidents** New tires have reduced road grip.

The contact surface on new tires is not yet roughened.

- Run in new tires with moderate riding at alternating angles.  
Running-in phase 200 km (124 mi)



## Info

When using the vehicle, remember that others may feel disturbed by excessive noise.

- Ensure that the pre-sales inspection work has been carried out by an authorized KTM workshop.
  - ✓ The delivery certificate and the Service and Manufacturer Warranty booklet must be transferred with the vehicle.
- Read the entire Owner's Manual before riding for the first time.
- Get to know the controls.
- Get used to the handling characteristic of the motorcycle on suitable terrain before undertaking a more challenging ride. Also, ride as slowly as possible to get a better feeling for the motorcycle.
- Hold the handlebar firmly with both hands and keep your feet on the footrests when riding.
- Run the engine in. (📖 p. 74)



# 8 PREPARING FOR USE

## 8.2 Running in the engine

- During the running-in phase, do not exceed the specified engine speed.

Guideline

Maximum engine speed	
During the first: 1,000 km (620 mi)	7,500 rpm



### Info

During the running-in phase, the shift warning light is set to a specified value and cannot be changed.

- Avoid fully opening the throttle!

## 8.3 Loading the vehicle



### Warning

**Danger of accidents** Total weight and axle loads influence the handling characteristic.

The total weight consists of: motorcycle ready for operation and with a full tank, driver and passenger with protective clothing and helmet, and luggage.

- Do not exceed the maximum permissible overall weight or the axle loads.



## Warning

**Danger of accidents** Improper mounting of cases or the tank rucksack impairs the handling characteristic.

- Mount and secure cases and tank rucksack according to the manufacturer's instructions.



## Warning

**Danger of accidents** The luggage system will be damaged if it is overloaded.

- Read the manufacturer information on maximum payload when mounting cases.



## Warning

**Danger of accidents** Luggage which has slipped impairs visibility.

If the tail light is covered, you are less visible to traffic behind you, especially when it is dark.

- Check that your luggage is fixed properly at regular intervals.



## Warning

**Danger of accidents** A high payload alters the handling characteristic and increases the stopping distance.

- Adapt your speed to your payload.



## Warning

**Danger of accidents** Pieces of luggage which have slipped impair the handling characteristic.

- Check that your luggage is fixed properly at regular intervals.

## 8 PREPARING FOR USE

- If luggage is carried, ensure it is fixed firmly as close as possible to the center of the vehicle and ensure even weight distribution between the front and rear wheels.
- Do not exceed maximum permissible weight and maximum permissible axle loads.

Guideline

Maximum permissible overall weight	335 kg (739 lb.)
Maximum permissible front axle load	125 kg (276 lb.)
Maximum permissible rear axle load	210 kg (463 lb.)

## 9.1 Checks and maintenance measures when preparing for use



### Info

Before every trip, check the condition of the vehicle and ensure that it is roadworthy. The vehicle must be in perfect technical condition when it is being operated.

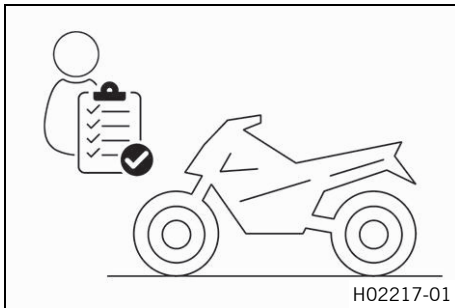

- Check the engine oil level. (📖 p. 204)
- Check the front brake fluid level. (📖 p. 132)
- Check the rear brake fluid level. (📖 p. 137)
- Check the front brake linings. (📖 p. 136)
- Check the rear brake linings. (📖 p. 142)
- Check that the brake system is functioning properly.
- Check the coolant level in the compensating tank. (📖 p. 185)
- Check for chain dirt accumulation. (📖 p. 110)
- Check the chain tension. (📖 p. 112)
- Check the tire condition. (📖 p. 157)
- Check tire pressure. (📖 p. 159)
- Check the settings of all controls and ensure that they can be operated smoothly.
- Check that the electrical system is functioning properly.
- Check that luggage is properly secured.
- Sit on the motorcycle and check the rear mirror setting.
- Check the fuel level.



## 9.2 Starting



### **Danger**

**Danger of poisoning** Exhaust gases are toxic and inhaling them may result in unconsciousness and death.

- Always make sure there is sufficient ventilation when running the engine.
- Use effective exhaust extraction when starting or running the engine in an enclosed space.



### **Caution**

**Danger of accidents** Electronic components and safety devices will be damaged if the 12-V battery is discharged or missing.

- Never operate the vehicle with a discharged 12-V battery or without a 12-V battery.

### **Note**

**Engine damage** Unfiltered intake air has a negative effect on the service life of the engine.

Dust and dirt will enter the engine without an air filter.

- Never start to use the vehicle without an air filter.

### **Note**

**Engine damage** High revving speed with a cold engine negatively impacts the lifespan of the engine.

- Always run the engine warm at a low speed.



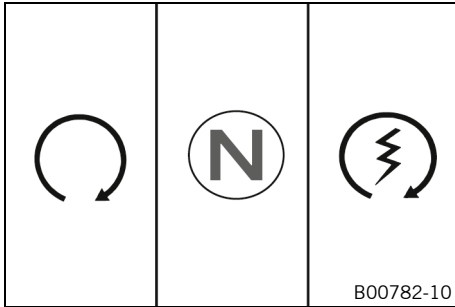

- Unlock the steering. (📖 p. 32)
- Sit on the vehicle, take the weight off of the side stand, and move it all the way up with your foot.
- Turn the emergency OFF switch to the position ○.
- Switch on the ignition by turning the ignition key to the position ○.
  - ✓ After you switch on the ignition, you can hear the fuel pump working for about two seconds. The function check of the combination instrument is run at the same time.
- Shift the transmission to neutral position.
  - ✓ The green idle indicator lamp **N** lights up.
  - ✓ The ABS indicator lamp lights up and goes back out after starting off.
- Press start button (🔌).



## Info

Do not press the start button until the combination instrument function check has finished.

When starting, **DO NOT** open the throttle. If you open the throttle during the starting procedure, fuel is not injected by the engine management system and the engine cannot start.

Press the starter for a maximum of 5 seconds. Wait for a least 5 seconds before trying again.

This motorcycle is equipped with a safety starting system. You can only start the engine if the transmission is in neutral or if the clutch lever is pulled when a gear is engaged. If the side stand is folded out and you shift into gear and release the clutch lever, the engine stops.

---

## 9.3 Starting off

- Pull the clutch lever, engage 1st gear, release the clutch lever slowly, and simultaneously open the throttle carefully.



## Tip

If the engine dies while starting off, only pull the clutch lever and press the electric starter button. You do not need to shift into neutral.

---

## 9.4 Shifting, riding.



### Warning

**Danger of accidents** Abrupt load alterations can cause the vehicle to get out of control.

- Avoid abrupt load alterations and sudden braking actions.
- Adapt your speed to the road conditions.



### Warning

**Danger of accidents** If you change down at high engine speed, the rear wheel blocks and the engine races.

- Do not change into a low gear at high engine speed.



### Warning

**Danger of accidents** An incorrect ignition key position causes malfunctions.

- Do not change the ignition key position while driving.



### Warning

**Danger of accidents** Adjustments to the vehicle distract attention from traffic activity.

- Make all adjustments when the vehicle is at a standstill.

# 9 RIDING INSTRUCTIONS



## Warning

**Risk of injury** The passenger may fall from the motorcycle if they conduct themselves incorrectly.

- Ensure that the passenger sits correctly on the passenger seat, places his or her feet on the passenger foot pegs and holds on to the rider or the grab handles.
- Note the regulations governing the minimum age of passengers in your country.



## Warning

**Danger of accidents** A risky riding style constitutes a major risk.

- Comply with traffic regulations and ride defensively and with foresight to detect sources of danger as early as possible.



## Warning

**Danger of accidents** Cold tires have reduced road grip.

- Ride the first miles carefully on every journey at moderate speed until the tires reach operating temperature.



## Warning

**Danger of accidents** New tires have reduced road grip.

The contact surface on new tires is not yet roughened.

- Run in new tires with moderate riding at alternating angles.  
Running-in phase 200 km (124 mi)

**Warning**

**Danger of accidents** Pieces of luggage which have slipped impair the handling characteristic.

- Check that your luggage is fixed properly at regular intervals.

**Warning**

**Danger of accidents** A fall can damage the vehicle more seriously than it may first appear.

- Check the vehicle after a fall as you do when preparing for use.

**Note**

**Engine failure** Overheating damages the engine.

- If the coolant temperature warning is displayed, stop immediately and take care not to endanger yourself or other traffic participants in the process.
  - Allow the engine and cooling system to cool down.
  - Check and, if necessary, correct the coolant level on the cooling system while it is in a cooled state.
- 
- 

**Info**

If unusual noises occur while riding, stop immediately (taking care not to endanger yourself or other road users in the process), switch off the engine and contact an authorized KTM workshop.

---

## 9 RIDING INSTRUCTIONS

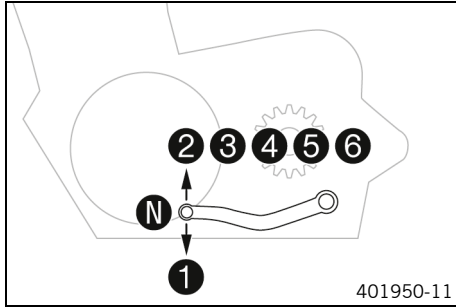

- Shift into a higher gear when conditions allow (incline, road situation, etc.).
- Release throttle while simultaneously pulling the clutch lever, shift into the next gear, release the clutch lever, and open the throttle.

---

### **i** Info

The gear positions can be seen in the figure. The neutral or idle position is between the first and second gears. First gear is used for starting off and for steep inclines.

The operating temperature is reached when 4 bars of the temperature indicator light up.

- 
- Only open the throttle as much as the engine can handle – abrupt throttle grip opening increases fuel consumption. Accelerate only up to a speed suitable for the road surface and weather conditions. Particularly in bends, do not shift, and accelerate very carefully.
  - Brake if necessary and close the throttle at the same time in order to shift down.
  - Pull clutch lever and shift into a lower gear, release the clutch lever slowly, and open the throttle or shift again.
  - Switch off the engine if you are likely to be running at idle speed or stationary for a long time.

- If the malfunction indicator lamp  lights up during a trip, stop immediately (taking care not to endanger yourself or other road users in the process), switch off the engine, and contact an authorized KTM workshop.



## 9.5 Applying the brakes



### Warning

**Danger of accidents** Moisture and dirt impair the brake system.

- Brake carefully several times to dry out and remove dirt from the brake linings and the brake discs.



### Warning

**Danger of accidents** A spongy pressure point on the front or rear brake reduces braking efficiency.

- Check the brake system and do not continue riding until the problem is eliminated. (Your authorized KTM workshop will be glad to help.)



### Warning

**Danger of accidents** The brake system fails in the event of overheating.

If the foot brake lever is not released, the brake linings drag continuously.

- Take your foot off the foot brake lever when you are not braking.

# 9 RIDING INSTRUCTIONS



## Warning

**Danger of accidents** Higher total weight increases the stopping distance.

- Take the longer stopping distance into account when carrying a passenger or luggage with you.



## Warning

**Danger of accidents** Salt on the roads impairs the brake system.

- Brake carefully several times to remove salt from the brake linings and the brake discs.



## Warning

**Danger of accidents** ABS may increase the stopping distance in certain situations.

- Adjust application of the brakes to the respective riding situation and riding surface conditions.



## Warning

**Danger of accidents** Excessively forceful application of the brakes blocks the wheels.

The ABS effectiveness is only ensured if it is switched on.

- Leave the ABS switched on in order to benefit from the protective effect.

- When braking, release the throttle and apply the front and rear brakes at the same time.



## Info

When the ABS is enabled, you can achieve maximum braking power even on low grip surfaces such as sandy, wet, or slippery terrain without locking of the wheels.



**Warning**

**Danger of accidents** The rear wheel can lock due to the engine braking effect.

- Pull in the clutch, if you perform emergency or full braking, or if you brake on a slippery ground.

**Warning**

**Danger of accidents** Banked or laterally sloping ground reduces the maximum possible delay.

- If possible finish braking before going into a bend.

- Always finish braking before you go into a bend. Shift down to a lower gear appropriate to your speed.
- Use the braking effect of the engine on long downhill stretches. Shift back one or two gears, but do not over-rev the engine when doing so. This means that significantly less braking is required and the brake system does not overheat.



## 9.6 Stopping, parking

**Warning**

**Risk of injury** People who act without authorization endanger themselves and others.

- Do not leave the vehicle unattended if the engine is running.
- Protect the vehicle against access by unauthorized persons.
- Lock the steering and remove the ignition key if you leave the vehicle unattended.



## Warning

**Danger of burns** Some vehicle components become very hot when the vehicle is operated.

- Do not touch any parts such as the exhaust system, radiator, engine, shock absorber, or brake system before the vehicle parts have cooled down.
- Let the vehicle parts cool down before you perform any work on the vehicle.

## Note

**Material damage** The vehicle may be damaged by incorrect procedure when parking.

Significant damage may be caused if the vehicle rolls away or falls over.

The components for parking the vehicle are designed only for the weight of the vehicle.

- Park the vehicle on a firm and level surface.
- Ensure that nobody sits on the vehicle when the vehicle is parked on a stand.

## Note

**Fire hazard** Hot vehicle components pose a fire hazard and explosion risk.

- Do not park the vehicle near to materials which are highly flammable or explosive.
- Allow the vehicle to cool down before covering it.

- 
- Apply the brakes on the motorcycle.
  - Shift the transmission to neutral position.
  - Switch off the ignition by turning the ignition key to the position ☒.

**Info**

If the engine is switched off with the emergency OFF switch and the ignition remains switched on at the ignition lock, power continues to flow to most power consumers and the 12-V battery will discharge. You should therefore always switch off the engine with the ignition lock – the emergency OFF switch is intended for emergencies only.

- 
- Park the motorcycle on a firm surface.
  - Swing the side stand forward with your foot as far as it will go and lean the vehicle on it.
  - Lock the steering. (📖 p. 31)



## 9.7 Transport

---

**Note**

**Danger of damage** The parked vehicle can roll away or fall over.

- Park the vehicle on a firm and level surface.

**Note**

**Fire hazard** Hot vehicle components pose a fire hazard and explosion risk.

- Do not park the vehicle near to materials which are highly flammable or explosive.
  - Allow the vehicle to cool down before covering it.
-

## 9 RIDING INSTRUCTIONS

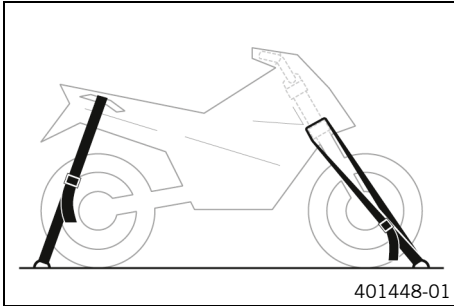

- Switch off the engine and remove the ignition key.
- Use tension belts or other suitable devices to secure the motorcycle against accidents or falling over.

### 9.8 Refueling



#### **Danger**

**Fire hazard** Fuel is highly flammable.

The fuel in the fuel tank expands when warm and can escape if overfilled.

- Do not refuel the vehicle in the vicinity of open flames or lit cigarettes.
- Switch off the engine for refueling.
- Make sure that no fuel is spilled; particularly not on hot parts of the vehicle.
- If any fuel is spilled, wipe it off immediately.
- Observe the specifications for refueling.

**Warning**

**Danger of poisoning** Fuel is poisonous and a health hazard.

- Avoid skin, eye and clothing contact with fuel.
- Immediately consult a doctor if you swallow fuel.
- Do not inhale fuel vapors.
- In case of skin contact, rinse the affected area with plenty of water.
- Rinse the eyes thoroughly with water, and consult a doctor in case of fuel contact with the eyes.
- Change your clothing in case of fuel spills on them.

**Note**

**Material damage** Inadequate fuel quality causes the fuel filter to quickly become clogged.

In some countries and regions, the available fuel quality and cleanliness may not be sufficient. This will result in problems with the fuel system.

- Refuel only with clean fuel that meets the specified standards. (Your authorized KTM workshop will be glad to help.)

**Note**

**Environmental hazard** Improper handling of fuel is a danger to the environment.

- Do not allow fuel to enter the groundwater, the soil, or the sewage system.
-

# 9 RIDING INSTRUCTIONS

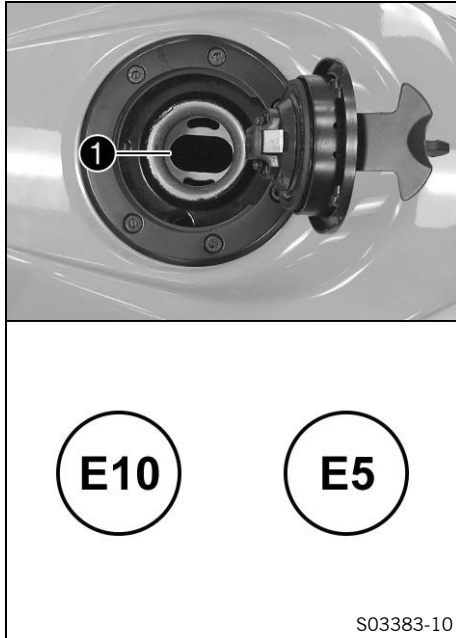

- Switch off the engine.
- Open the fuel tank filler cap. (📖 p. 33)
- Fill the fuel tank with fuel up to the lower edge **1** of the fuel filler.

Total fuel tank capacity, approx.	10 l (2.6 US gal)	Super unleaded (ROZ 95/RON 95/PON 91) (📖 p. 240)
-----------------------------------	----------------------	---

- Close the fuel tank filler cap. (📖 p. 35)

## 10.1 Additional information

Any further work that results from the compulsory work or from the recommended work must be ordered separately and invoiced separately.

Different service intervals may apply in your country, depending on the local operating conditions.

Individual service intervals and scopes may change in the course of technical developments. The most up-to-date service schedule can always be found on KTM Dealer.net. Your authorized KTM dealer will be happy to advise you.

## 10.2 Required work

	every 24 months				
		every 12 months			
		every 15,000 km (9,300 mi)			
		every 7,500 km (4,650 mi)			
		after 1,000 km (620 mi)			
Read out the fault memory using the KTM diagnostics tool. 🛠️	○	●	●	●	●
Check that the electrical system is functioning properly.	○	●	●	●	●
Change the engine oil and oil filter, clean the oil screen. 🛠️ (📖 p. 205)	○	●	●	●	●
Check the brake discs. (📖 p. 131)	○	●	●	●	●
Check the front brake linings. (📖 p. 136)	○	●	●	●	●
Check the rear brake linings. (📖 p. 142)	○	●	●	●	●
Check the tire condition. (📖 p. 157)	○	●	●	●	●
Check tire pressure. (📖 p. 159)	○	●	●	●	●

# 10 SERVICE SCHEDULE

	every 24 months				
	every 12 months				
	every 15,000 km (9,300 mi)				
	every 7,500 km (4,650 mi)				
	after 1,000 km (620 mi)				
Check the brake lines for damage and leakage.	○	●	●	●	●
Check the front brake fluid level. (📖 p. 132)	○	●	●	●	
Check the rear brake fluid level. (📖 p. 137)	○	●	●	●	
Check the shock absorber and fork for leaks. 🛠️	○	●	●	●	●
Clean the dust boots of the fork legs. (📖 p. 104)		●	●		
Check the chain, rear sprocket, and engine sprocket. (📖 p. 116)		●	●	●	●
Check the chain tension. (📖 p. 112)	○	●	●	●	●
Check the coolant level in the compensating tank. (📖 p. 185)	○	●	●	●	●
Check that the radiator fan is functioning properly. 🛠️	○	●	●	●	●
Change the air filter, clean the air filter box. 🛠️		●	●		
Check that the throttle cables are undamaged, routed without sharp bends, and set correctly. 🛠️	○	●	●	●	●
Check the cables for damage and routing without sharp bends. 🛠️	○	●	●	●	●
Check the valve clearance, change the spark plug. 🛠️			●		
Change the front brake fluid. 🛠️					●
Change the rear brake fluid. 🛠️					●
Check the steering head bearing play. 🛠️	○	●	●	●	●



	every 24 months				
	every 12 months				
	every 15,000 km (9,300 mi)				
	every 7,500 km (4,650 mi)				
	after 1,000 km (620 mi)				
Check the low beam headlight setting. (📖 p. 177)	○	●	●		
Check the high beam headlight setting. (📖 p. 179)	○	●	●		
Final check: Check the vehicle is roadworthy and take a test ride. 🛠️	○	●	●	●	●
Read out the error memory after the test ride using the KTM diagnostics tool. 🛠️	○	●	●	●	●
Reset the service interval display. 🛠️	○	●	●	●	●
Make a service entry in <b>KTM Dealer.net</b> . 🛠️	○	●	●	●	●

- One-time interval
- Periodic interval

## 10.3 Recommended work

	every 48 months				
	every 12 months				
	every 30,000 km (18,600 mi)				
	every 7,500 km (4,650 mi)				
	after 1,000 km (620 mi)				
Check the frame. 🛠️				●	

# 10 SERVICE SCHEDULE

		every 48 months				
		every 12 months				
		every 30,000 km (18,600 mi)				
		every 7,500 km (4,650 mi)				
		after 1,000 km (620 mi)				
Check the link fork. 🛠️			●			
Check the fork bearing for play. 🛠️		●	●			
Check the wheel bearing for play. 🛠️		●	●			
Grease all moving parts (e.g. side stand, hand lever, chain, ...) and check for smooth operation. 🛠️	○	●	●	●	●	
Empty the drainage hoses. 🛠️	○	●	●	●	●	
Check all hoses (e.g. fuel, cooling, bleeder, drainage, etc.) and sleeves for cracking, leaks, and correct routing. 🛠️	○	●	●	●	●	
Check the antifreeze. 🛠️	○	●	●	●		
Change the coolant. 🛠️ (📖 p. 196)						●
Check the tightness of the safety-relevant screws and nuts which are easily accessible. 🛠️	○	●	●	●	●	

- One-time interval
- Periodic interval

## 11.1 Adjusting the spring preload of the shock absorber ↗



### Warning

**Danger of accidents** Modifications to the suspension setting may seriously alter the handling characteristic.

- Ride slowly to start with after making adjustments to get the feel of the new handling characteristic.



### Info

The spring preload defines the initial status of the spring operation on the shock absorber. The best spring preload setting is achieved when it is set for the weight of the rider and that of any luggage and a passenger, thus ensuring an ideal compromise between handling and stability.

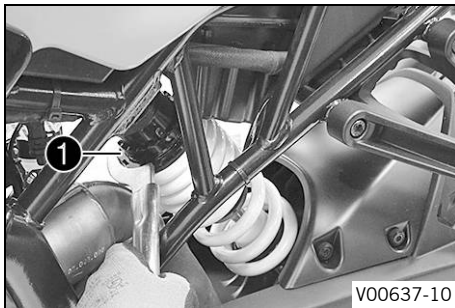

- Adjust the spring preload by turning the adjusting ring **1** using the hook wrench from the tool set.

#### Guideline

Spring preload	
Standard	5 clicks
Hook wrench, shock absorber (90529077000)	
Extension for hook wrench (90129099025)	



### Info

The spring preload can be set to 10 different positions.



## 11.2 Adjusting the shift lever



### Info

The adjustment range of the shift lever is limited.

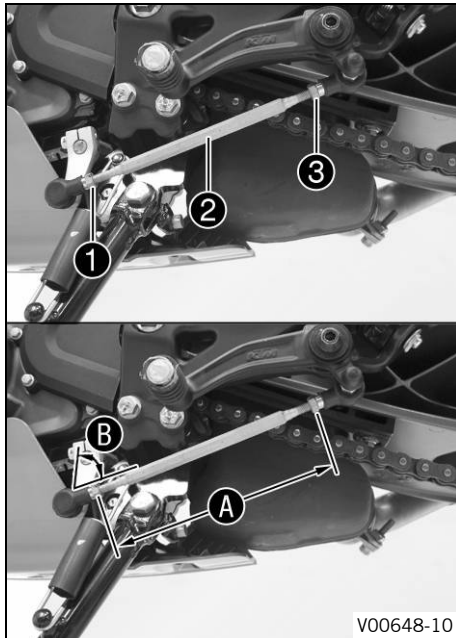

- Loosen nut **1**, holding threaded rod **2**.



### Info

Nut **1** has a left-handed thread.

- Loosen nut **3**, holding threaded rod **2**.
- Adjust the shift lever by turning shift rod **2**.

### Guideline

Shift rod adjustment range <b>A</b>	150 ... 162 mm (5.91 ... 6.38 in)
-------------------------------------	-----------------------------------



### Info

Make equal adjustments on both sides.  
At least five screw threads must be screwed into the seating.

- Check adjusting angle **B**.

Guideline

Adjusting angle <b>B</b> shift rod - bell crank - shift lever	75°
--	-----

- Tighten nut **3** while holding threaded rod **2**.

Guideline

Nut, shift rod	M6	10 Nm (7.4 lbf ft)
----------------	----	--------------------

- Tighten nut **1** while holding threaded rod **2**.

Guideline

Nut, shift rod	M6LH	10 Nm (7.4 lbf ft)
----------------	------	--------------------

- Check the shift lever to ensure it is functioning properly and can move freely.



# 12 SERVICE WORK ON THE CHASSIS

## 12.1 Raising the motorcycle with rear lifting gear

### Note

**Danger of damage** The parked vehicle can roll away or fall over.

- Park the vehicle on a firm and level surface.

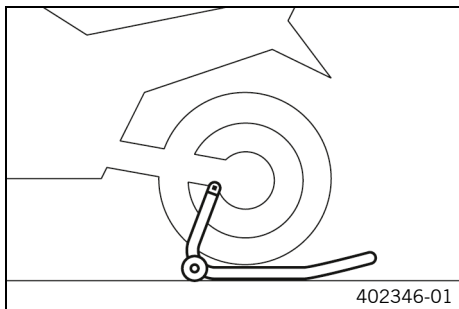

- Mount the supports of the lifting gear.
- Insert the adapter in the rear lifting gear.

Retaining adapter (61029955244)
---------------------------------

Rear wheel work stand (69329955000)
-------------------------------------

- Stand the motorcycle upright, align the lifting gear to the link fork and the adapters, and raise the motorcycle.

## 12.2 Removing the rear of the motorcycle from the lifting gear

### Note

**Danger of damage** The parked vehicle can roll away or fall over.

- Park the vehicle on a firm and level surface.

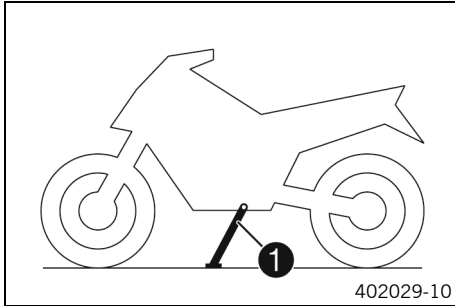

- Secure the motorcycle against falling over.
- Remove the rear lifting gear and lean the vehicle on side stand **1**.
- Remove bushings kit.

## 12.3 Lifting the motorcycle with the front lifting gear

### Note

**Danger of damage** The parked vehicle can roll away or fall over.

- Park the vehicle on a firm and level surface.

### Preparatory work

- Raise the motorcycle with the rear lifting gear. (🔧 p. 100)

# 12 SERVICE WORK ON THE CHASSIS

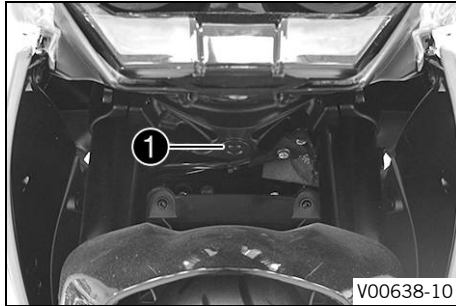

## Condition

- Remove protection cap ❶.

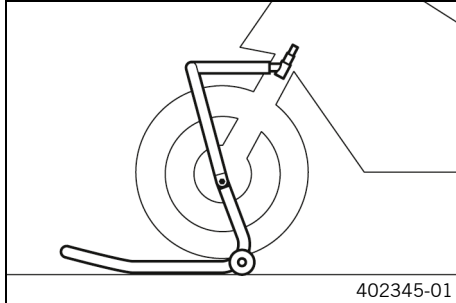

- Move the handlebar to the straight-ahead position. Position the lifting gear.

Mounting pin (69329965030)
----------------------------

Front wheel work stand, large (69329965100)
---

## Info

Always raise the motorcycle at the rear first.

- Lift the motorcycle at the front.



## 12.4 Taking the motorcycle off the front lifting gear

### Note

**Danger of damage** The parked vehicle can roll away or fall over.

- Park the vehicle on a firm and level surface.

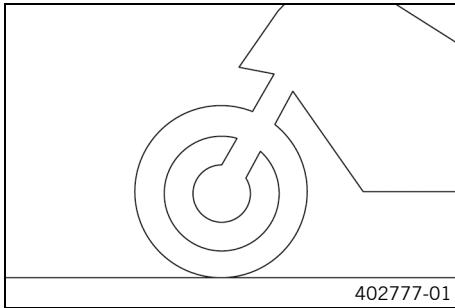

### Main work

- Secure the motorcycle against falling over.
- Remove the front lifting gear.

## 12 SERVICE WORK ON THE CHASSIS

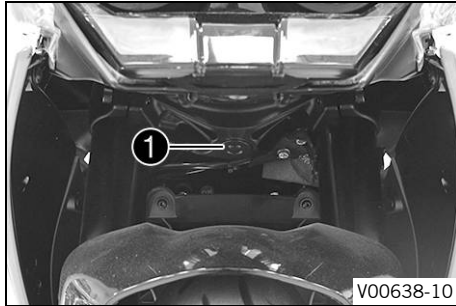

- Mount protection cap ❶.

### Finishing work

- Remove the rear of the motorcycle from the lifting gear. (📖 p. 100)

## 12.5 Cleaning the dust boots of the fork legs

### Preparatory work

- Raise the motorcycle with the rear lifting gear. (📖 p. 100)
- Lift the motorcycle with the front lifting gear. (📖 p. 101)

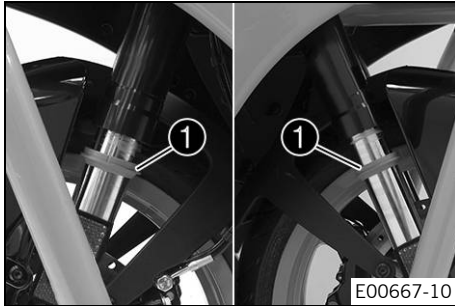

## Main work

- Push dust boots ❶ of both fork legs downward.



### Info

The dust boots remove dust and coarse dirt particles from the inside fork tubes. Over time, dirt can accumulate behind the dust boots. If this dirt is not removed, the oil seals behind can start to leak.



### Warning

**Danger of accidents** Oil or grease on the brake discs reduces the braking effect.

- Always keep the brake discs free of oil and grease.
- Clean the brake discs with brake cleaner when necessary.

- Clean and oil the dust boots and inner fork tubes of both fork legs.

Universal oil spray (📖 p. 243)

- Press the dust boots back into the installation position.
- Remove the excess oil.

## Finishing work

- Take the motorcycle off the front lifting gear. (📖 p. 103)

## 12 SERVICE WORK ON THE CHASSIS

- Remove the rear of the motorcycle from the lifting gear.  
(📖 p. 100)

### 12.6 Removing the front rider's seat

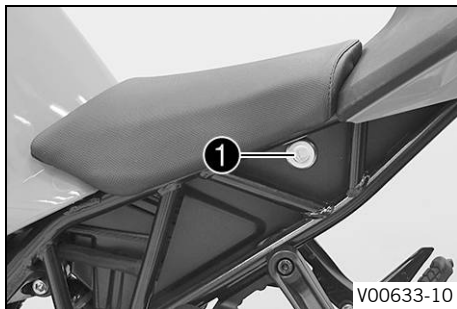

- Insert the ignition key in seat lock ❶ and turn it clockwise.
- Raise the rear of the front rider's seat, pull it toward the rear, and remove it upward.
- Remove the ignition key from the seat lock.

## 12.7 Mounting the front rider's seat

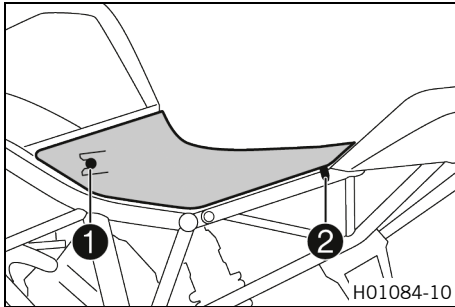

- Attach recesses ① on the front rider's seat to the fuel tank, push the front rider's seat forward, and lower at the rear.
- ✓ The pin ② locks audibly in place.
- Check that the front rider's seat is mounted correctly.



## 12.8 Removing the passenger seat

### Preparatory work

- Remove the front rider's seat. (📖 p. 106)

## 12 SERVICE WORK ON THE CHASSIS

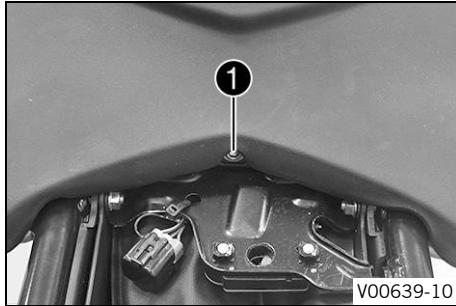

### Main work

- Remove screw **1** with washer.
- Lift and take off the passenger seat.

### 12.9 Mounting the passenger seat

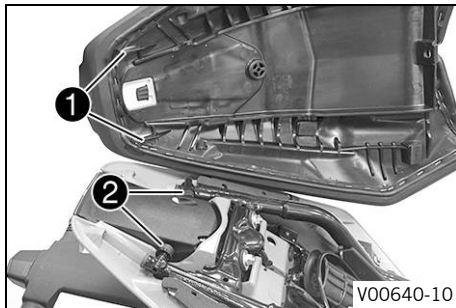

### Main work

- Position passenger seat.
  - ✓ Both hooks **1** engage in the holders **2**.
- Lower the front of the passenger seat and push back.

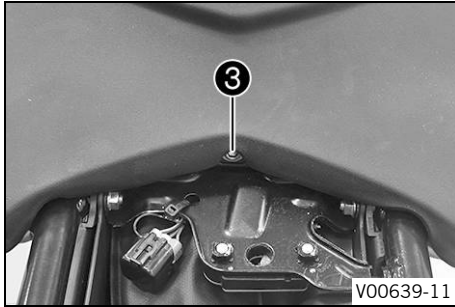

- Mount and tighten screw ③ with the washer.

Guideline

Screw, passenger seat	M6	7 Nm (5.2 lbf ft)
-----------------------	----	-------------------



### Warning

**Danger of accidents** The seat can come loose from the anchoring if it is not mounted correctly.

- After assembly, check whether the seat is correctly locked and cannot be pulled up.

- Check that the passenger seat is mounted correctly.

### Finishing work

- Mount the front rider's seat. (🔧 p. 107)



# 12 SERVICE WORK ON THE CHASSIS

## 12.10 Checking for chain dirt accumulation

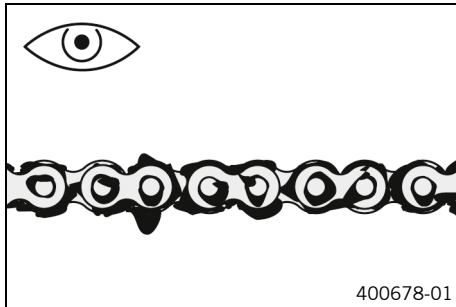

- Check the chain for coarse dirt accumulation.
  - » If the chain is very dirty:
    - Clean the chain. (📖 p. 110)

## 12.11 Cleaning the chain



### Warning

**Danger of accidents** Lubricants on the tires reduces the road grip.

- Remove lubricants from the tires using a suitable cleaning agent.



### Warning

**Danger of accidents** Oil or grease on the brake discs reduces the braking effect.

- Always keep the brake discs free of oil and grease.
- Clean the brake discs with brake cleaner when necessary.





## Note

**Environmental hazard** Hazardous substances cause environmental damage.

- Dispose of oils, grease, filters, fuel, cleaning agents, brake fluid, etc., correctly and in compliance with the applicable regulations.



## Info

The service life of the chain depends largely on its maintenance.

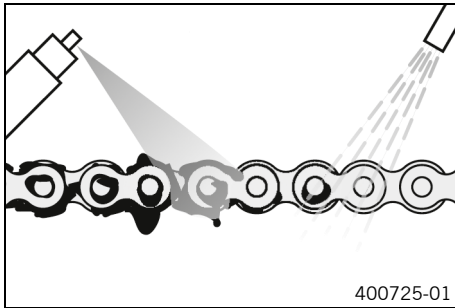

### Preparatory work

- Raise the motorcycle with the rear lifting gear. (📖 p. 100)

### Main work

- Clean the chain regularly.
- Rinse off loose dirt with a soft jet of water.
- Remove old grease remains with chain cleaner.

Chain cleaner (📖 p. 242)

- After drying, apply chain spray.

Street chain spray (📖 p. 243)

### Finishing work

- Remove the rear of the motorcycle from the lifting gear. (📖 p. 100)



## 12.12 Checking the chain tension



### Warning

**Danger of accidents** Incorrect chain tension damages components and results in accidents.

If the chain is tensioned too much, the chain, engine sprocket, rear sprocket, transmission and rear wheel bearings wear more quickly. Some components may break if overloaded.

If the chain is too loose, the chain may fall off the engine sprocket or the rear sprocket. As a result, the rear wheel locks or the engine will be damaged.

- Check the chain tension regularly.
- Set the chain tension in accordance with the specification.

### Preparatory work

- Raise the motorcycle with the rear lifting gear. (📖 p. 100)

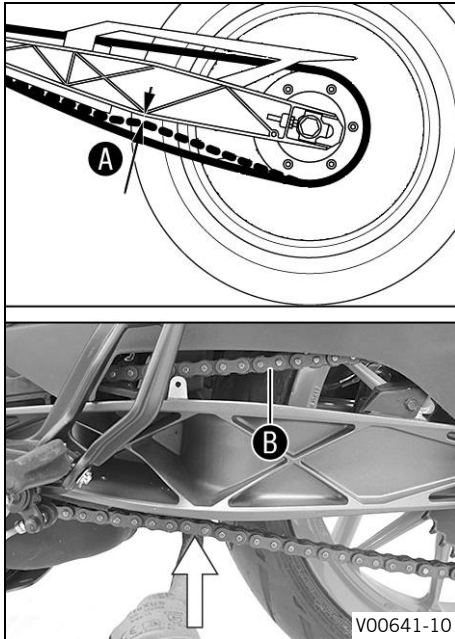

## Main work

- Shift the transmission to neutral position.
- In the area after the chain sliding guard, press the chain upward toward the link fork and measure chain tension **A**.



## Info

Top chain section **B** must be taut.  
Chain wear is not always even, so you should repeat this measurement at different chain positions.

Chain tension	5 ... 7 mm (0.2 ... 0.28 in)
---------------	------------------------------

- » If the chain tension does not meet the specification:
  - Adjust the chain tension. (🔧 p. 114)
- Remove the rear of the motorcycle from the lifting gear. (🔧 p. 100)



## 12.13 Adjusting the chain tension



### Warning

**Danger of accidents** Incorrect chain tension damages components and results in accidents.

If the chain is tensioned too much, the chain, engine sprocket, rear sprocket, transmission and rear wheel bearings wear more quickly. Some components may break if overloaded.

If the chain is too loose, the chain may fall off the engine sprocket or the rear sprocket. As a result, the rear wheel locks or the engine will be damaged.

- Check the chain tension regularly.
- Set the chain tension in accordance with the specification.

### Preparatory work

- Raise the motorcycle with the rear lifting gear. (📖 p. 100)
- Check the chain tension. (📖 p. 112)

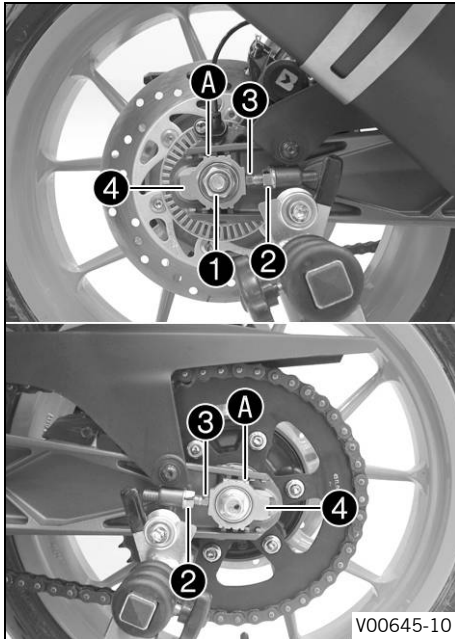

## Main work

- Loosen nut ①.
- Loosen nuts ②.
- Adjust the chain tension by turning adjusting screws ③ left and right.

## Guideline

Chain tension	5 ... 7 mm (0.2 ... 0.28 in)
Turn the adjusting screws ③ on the left and right so that the markings on the left and right chain adjusters ④ are in the same position relative to the reference marks A. The rear wheel is then correctly aligned.	



## Info

The top chain section must be taut.  
Chain wear is not always even, so you should check the setting at different chain positions.

- Tighten nuts ②.
- Make sure that chain adjusters ④ are fitted correctly on adjusting screws ③.
- Tighten nut ①.

## Guideline

Nut, rear wheel spindle	M14x1.5	90 Nm (66.4 lbf ft)
-------------------------	---------	---------------------

# 12 SERVICE WORK ON THE CHASSIS

## Finishing work

- Remove the rear of the motorcycle from the lifting gear. (📖 p. 100)

## 12.14 Checking the chain, rear sprocket, and engine sprocket

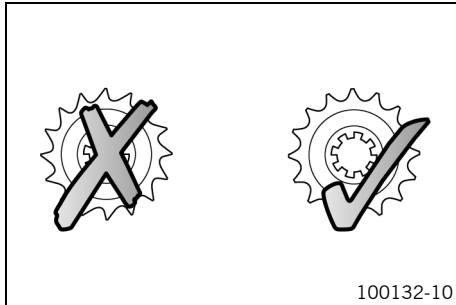

## Preparatory work

- Raise the motorcycle with the rear lifting gear. (📖 p. 100)

## Main work

- Shift the transmission to neutral position.
- Check the rear sprocket and engine sprocket for wear.
  - » If the rear sprocket and engine sprocket are worn:
    - Change the drivetrain kit. 🔧



### Info

The engine sprocket, rear sprocket, and chain should always be replaced together.

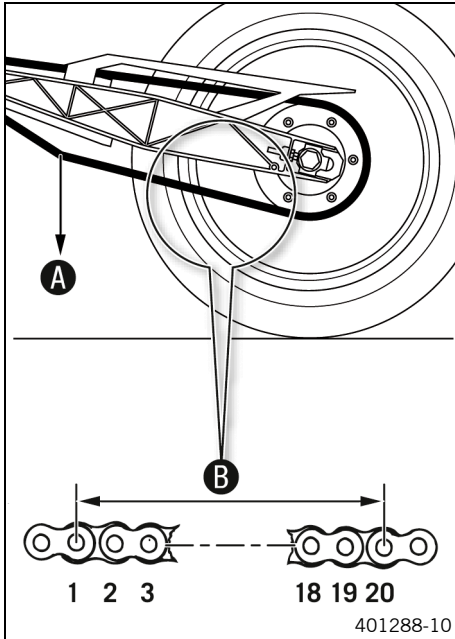

- Pull on the lower chain section with the specified weight **A**.

Guideline

Weight, chain wear measurement	15 kg (33 lb.)
--------------------------------	----------------

- Measure distance **B** of 20 chain rollers in the lower chain section.



### Info

Chain wear is not always even, so you should repeat this measurement at different chain positions.

Maximum distance <b>B</b> from 20 chain rollers at the longest chain section	301.6 mm (11.874 in)
--	----------------------

- » If distance **B** is greater than the specified measurement:
  - Change the drivetrain kit. 🛠️



### Info

When a new chain is mounted, the rear sprocket and engine sprocket should also be changed. New chains wear out faster on old, worn sprockets.

# 12 SERVICE WORK ON THE CHASSIS

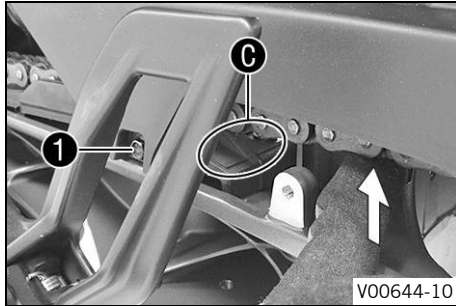

- Push the chain up in the area behind the chain guide.
- Check the chain sliding guard for wear.
  - » If the chain sliding guard has lost material due to wear to the extent that, in area **C**, the drilled hole of screw **1** is visible from above:
    - Change the chain sliding guard. 🛠️
- Check that the chain sliding guard is firmly seated.
  - » If the chain sliding guard is loose:
    - Tighten screws on the chain sliding guard.

## Finishing work

- Remove the rear of the motorcycle from the lifting gear.  
(📖 p. 100)

## 12.15 Removing the battery cover

### Preparatory work

- Remove the front rider's seat. (📖 p. 106)



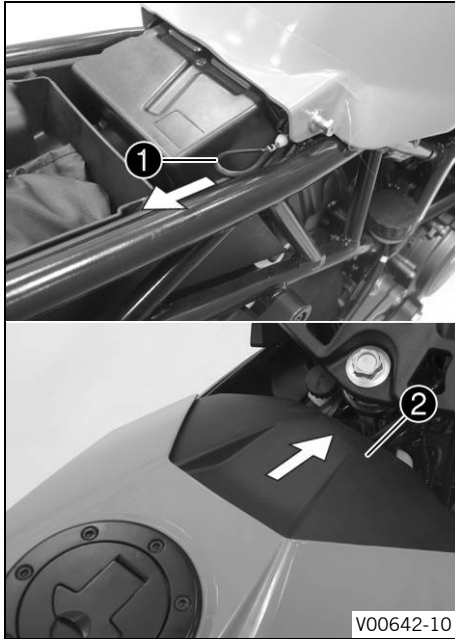

## Main work

- Pull loop ① toward the rear.
- Pull battery cover ② forward and take off toward the top.



# 12 SERVICE WORK ON THE CHASSIS

## 12.16 Mounting the battery cover

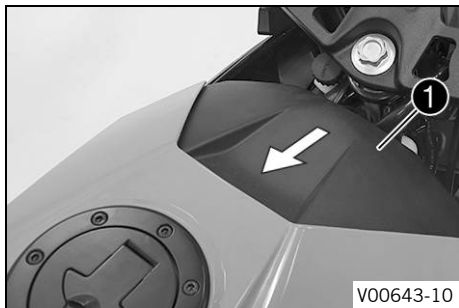

### Main work

- Position battery cover ❶ and pull toward the rear.
  - ✓ The battery cover engages with an audible click.
- Check the battery cover is seated correctly.

### Finishing work

- Mount the front rider's seat. (📖 p. 107)

## 12.17 Removing the front spoiler

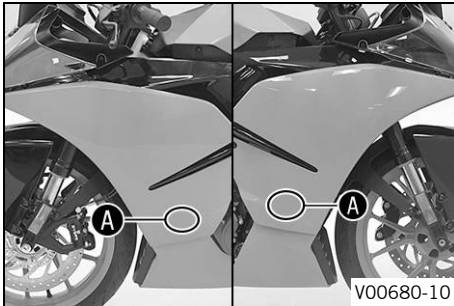

- Pull off holding lug in area **A**.

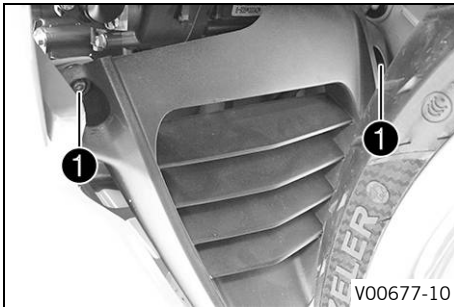

- Remove screws **1**.

# 12 SERVICE WORK ON THE CHASSIS

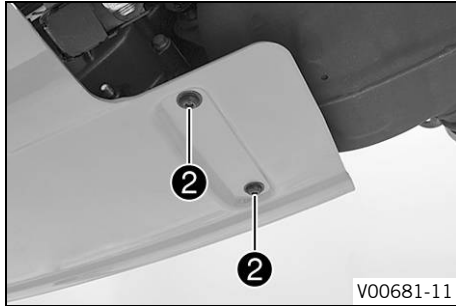

- Remove screws ②.
- Take off the front spoiler.

## 12.18 Fitting front spoiler

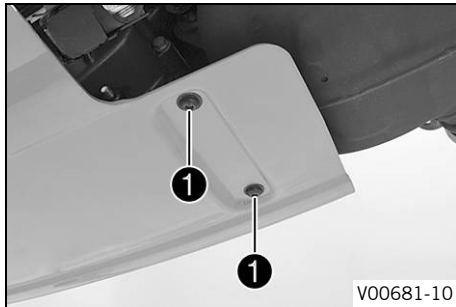

- Position the front spoiler.
- Mount and tighten screws ①.

Guideline

Screw, front spoiler rear	M6	6 Nm (4.4 lbf ft)
------------------------------	----	-------------------

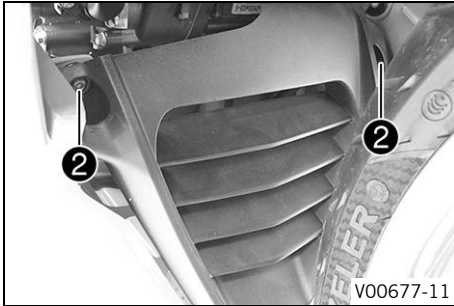

- Mount and tighten screws ②.

Guideline

Screw, front spoiler	M6	7 Nm (5.2 lbf ft)
----------------------	----	-------------------

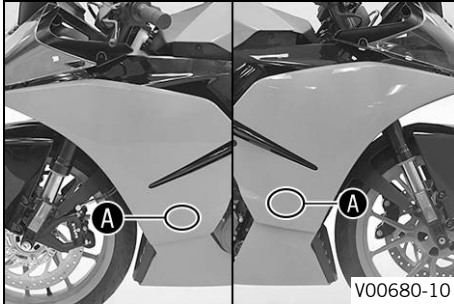

- Press lightly on the side cover in the ① area in order to snap the side cover on.
- ✓ The holding lugs engage in the holes on the front spoiler.



# 12 SERVICE WORK ON THE CHASSIS

## 12.19 Removing the left side cover ↗

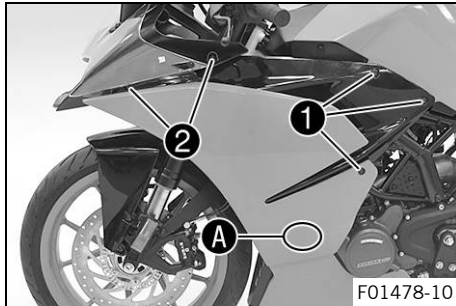

- Remove screws ①.
- Remove screws ②.
- Pull off holding lug in area ①.

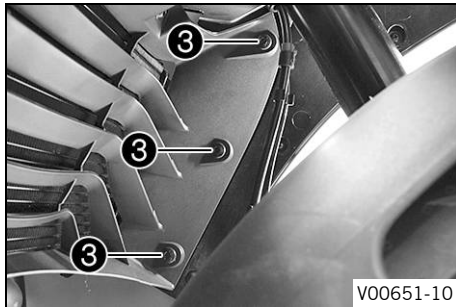

- Remove expanding rivet ③.

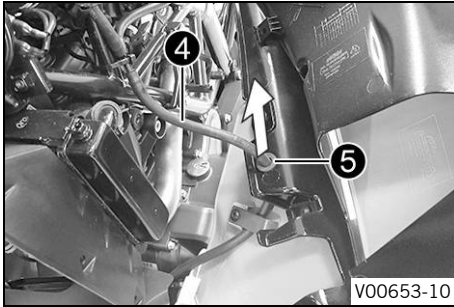

- Swing the side cover outward.
- Pull hose ④ out of hose guide ⑤.
- Take off the side cover.



## 12.20 Installing the left side cover ↗

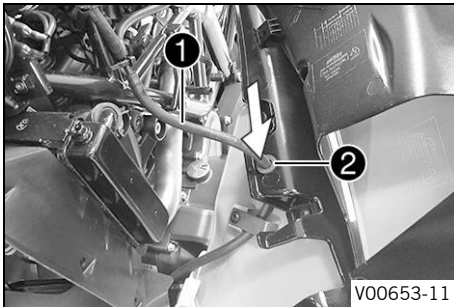

- Position hose ① in hose guide ②.

# 12 SERVICE WORK ON THE CHASSIS

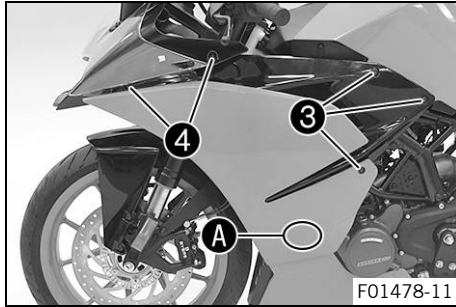

- Position the side cover.
- Mount and tighten screws ③.

Guideline

Screw, side cover	M6	6 Nm (4.4 lbf ft)
-------------------	----	-------------------

- Push on the side cover in area A.
- ✓ The holding lug engages in the drilled hole on the front spoiler.
- Mount and tighten screws ④.

Guideline

Screw, side cover on front mask	M6	6 Nm (4.4 lbf ft)
---------------------------------	----	-------------------

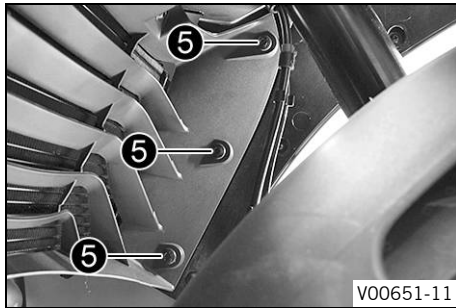

- Mount expanding rivet ⑤.



## 12.21 Removing the right side cover ↗

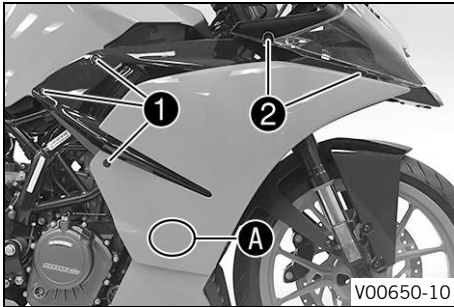

- Remove screws ①.
- Remove screws ②.
- Pull off holding lug in area A.

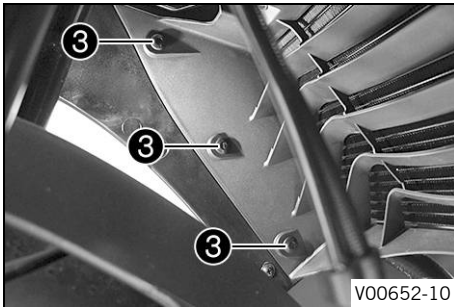

- Remove expanding rivet ③.
- Take off the side cover.



# 12 SERVICE WORK ON THE CHASSIS

## 12.22 Installing the right side cover ↗

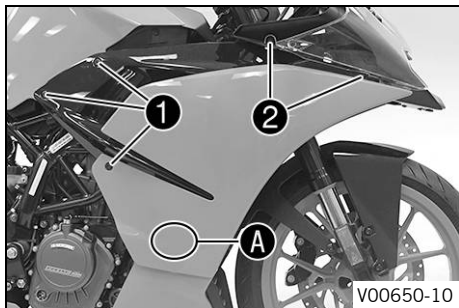

- Position the side cover.
- Mount and tighten screws ①.

Guideline

Screw, side cover	M6	6 Nm (4.4 lbf ft)
-------------------	----	-------------------

- Push on the side cover in area A.
- ✓ The holding lug engages in the drilled hole on the front spoiler.
- Mount and tighten screws ②.

Guideline

Screw, side cover on front mask	M6	6 Nm (4.4 lbf ft)
---------------------------------	----	-------------------

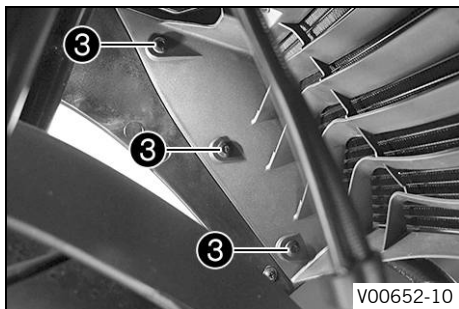

- Mount expanding rivet ③.

### 13.1 Anti-lock braking system (ABS)

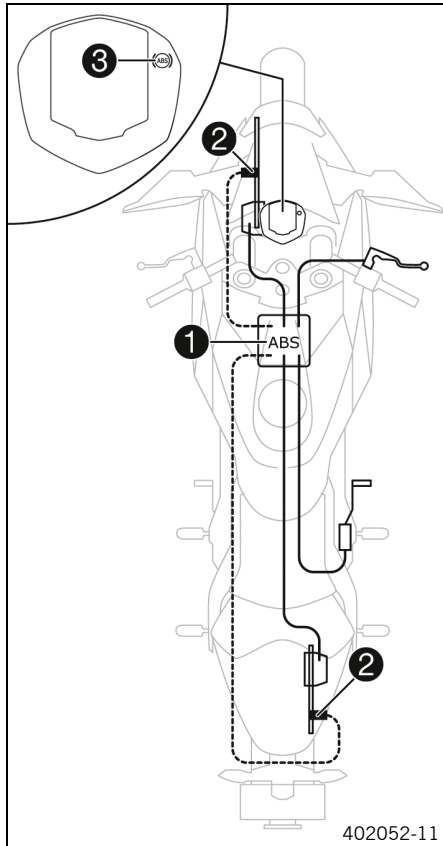

The ABS module **1**, which consists of a hydraulic unit, ABS control unit, and return pump, is installed under the fuel tank. One wheel speed sensor **2** is located in each case on the front and the rear wheel.



#### Warning

**Danger of accidents** Changes to the vehicle impair the function of the ABS.

- Only allow the rear wheel to spin with the front brake applied away from public road traffic if the ABS is switched off.
- Do not make any changes to the suspension travel.
- Only use spare parts on the brake system which have been approved and recommended by KTM.
- Only use tires/wheels approved by KTM with the corresponding speed index.
- Maintain specified tire pressure.
- Ensure that service work and repairs are performed professionally. (Your authorized KTM workshop will be glad to help.)

The ABS is a safety system that prevents locking of the wheels when driving straight ahead without the influence of lateral forces.



## Warning

**Danger of accidents** Driving aids can only prevent a rollover within the physical limitations.

It is not always possible to compensate for extreme riding situations, for example with luggage loaded with a high center of gravity, varying road surfaces, steep descents or full braking without disengaging the gear.

- Adapt your riding style to the road conditions and your driving ability.

The ABS operates with two independent brake circuits (front and rear brakes). During normal operation, the brake system operates like a conventional brake system without ABS. When the ABS control unit detects a locking tendency in a wheel, ABS begins regulating the brake pressure. The control function causes a slight pulsing of the hand and foot brake levers.

The ABS warning lamp **3** must light up after the ignition is switched on and go out after starting off. If it does not go out after starting off or if it lights up while riding, this indicates a malfunction in the ABS. In this case, the ABS is no longer enabled and the wheels may lock during braking. The brake system itself stays functional; only ABS control is not available.

The ABS warning lamp may also light up if the rotating speeds of the front and rear wheels differ greatly under extreme riding con-

ditions, for example when making "wheelies" or if the rear wheel spins. This causes the ABS to switch off. To reactivate the ABS, stop the vehicle and switch off the ignition. The ABS is reactivated when the vehicle is switched on again. The ABS warning lamp goes out when you start off.

## 13.2 Checking the brake discs



### Warning

**Danger of accidents** Worn-out brake discs reduce the braking effect.

- Make sure that worn-out brake discs are replaced immediately. (Your authorized KTM workshop will be glad to help.)

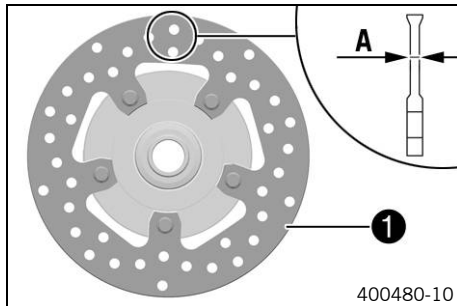

- Check the front and rear brake disc thickness at multiple points for the dimension **A**.



### Info

Wear will reduce the thickness of the brake disc at contact surface **1** of the brake linings.

Brake discs - wear limit	
front	4.5 mm (0.177 in)
rear	3.6 mm (0.142 in)

- » If the brake disc thickness is less than the specified value.

- Change the front brake disc. 🛠️
- Change the rear brake disc. 🛠️
- Check the front and rear brake discs for damage, cracking, and deformation.
  - » If the brake disc exhibits damage, cracking, or deformation:
    - Change the front brake disc. 🛠️
    - Change the rear brake disc. 🛠️

## 13.3 Checking the front brake fluid level



### Warning

**Danger of accidents** An insufficient brake fluid level will cause the brake system to fail.

If the brake fluid level drops below the **MIN** marking, the brake system is leaking or the brake linings are worn down.

- Check the brake system and do not continue riding until the problem is eliminated. (Your authorized KTM workshop will be glad to help.)



### Warning

**Danger of accidents** Old brake fluid reduces the braking effect.

- Make sure that brake fluid for the front and rear brake is changed in accordance with the service schedule. (Your authorized KTM workshop will be glad to help.)

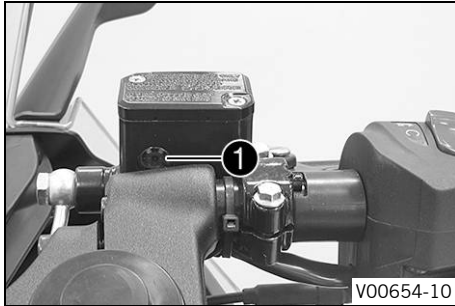

- Move the brake reservoir mounted on the handlebar into a horizontal position.
- Check the brake fluid level in the level viewer ①.
  - » If the brake fluid level is below the **MIN** marking:
    - Add the front brake fluid. 🛠️ (📖 p. 133)



## 13.4 Adding the front brake fluid 🛠️



### Warning

**Danger of accidents** An insufficient brake fluid level will cause the brake system to fail.

If the brake fluid level drops below the **MIN** marking, the brake system is leaking or the brake linings are worn down.

- Check the brake system and do not continue riding until the problem is eliminated. (Your authorized KTM workshop will be glad to help.)



## Warning

**Skin irritation** Brake fluid causes skin irritation.

- Keep brake fluid out of the reach of children.
- Wear suitable protective clothing and safety glasses.
- Do not allow brake fluid to come into contact with the skin, the eyes or clothing.
- Consult a doctor immediately if brake fluid has been swallowed.
- Rinse the affected area with plenty of water in the event of contact with the skin.
- Rinse eyes thoroughly with water immediately and consult a doctor if brake fluid comes into contact with the eyes.
- If brake fluid spills on to your clothing, change the clothing.



## Warning

**Danger of accidents** Old brake fluid reduces the braking effect.

- Make sure that brake fluid for the front and rear brake is changed in accordance with the service schedule. (Your authorized KTM workshop will be glad to help.)



## Note

**Environmental hazard** Hazardous substances cause environmental damage.

- Dispose of oils, grease, filters, fuel, cleaning agents, brake fluid, etc., correctly and in compliance with the applicable regulations.
-





## Info

Never use DOT 5 brake fluid. It is silicone-based and purple in color. Oil seals and brake lines are not designed for DOT 5 brake fluid.

Avoid contact between brake fluid and painted parts. Brake fluid attacks paint.

Only use clean brake fluid from a sealed container.

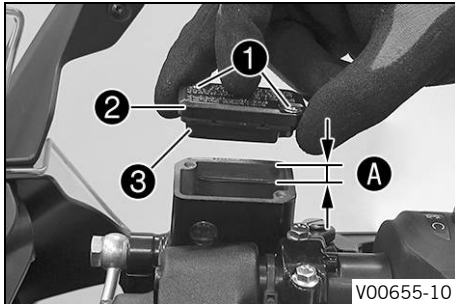

## Preparatory work

- Check the front brake linings. (📖 p. 136)

## Main work

- Move the brake fluid reservoir mounted on the handlebar to a horizontal position.
- Remove screws ①.
- Take off cover ② with membrane ③.
- Add brake fluid to level A.

### Guideline

Dimension A	5 mm (0.2 in)
-------------	---------------

Brake fluid DOT 4 / DOT 5.1 (📖 p. 238)
--

- Position the cover with the membrane. Mount and tighten the screws.



## Info

Immediately clean up any brake fluid that has overflowed or spilled with water.

## 13.5 Checking the front brake linings



### Warning

**Danger of accidents** Worn-out brake linings reduce the braking effect.

- Ensure that worn-out brake linings are replaced immediately. (Your authorized KTM workshop will be glad to help.)



### Warning

**Danger of accidents** Damaged brake discs reduce the braking effect.

If the brake linings are not changed in time, the brake lining carriers grind against the brake disc. As a consequence, the braking effect is greatly reduced and the brake discs are destroyed.

- Check the brake linings regularly.

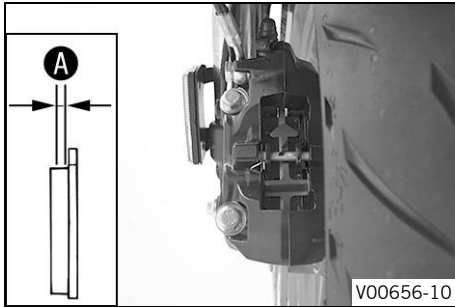

- Check the brake linings for minimum thickness **A**.

Minimum thickness <b>A</b>	$\geq 1 \text{ mm } (\geq 0.04 \text{ in})$
----------------------------	---

- » If the minimum thickness is less than specified:
  - Change the brake linings of the front brake. 🛠️
- Check the brake linings for damage and cracking.
  - » If there is wear or tearing:
    - Change the brake linings of the front brake. 🛠️

## 13.6 Checking the rear brake fluid level



### Warning

**Danger of accidents** An insufficient brake fluid level will cause the brake system to fail.

If the brake fluid level drops below the **MIN** marking, the brake system is leaking or the brake linings are worn down.

- Check the brake system and do not continue riding until the problem is eliminated. (Your authorized KTM workshop will be glad to help.)



### Warning

**Danger of accidents** Old brake fluid reduces the braking effect.

- Make sure that brake fluid for the front and rear brake is changed in accordance with the service schedule. (Your authorized KTM workshop will be glad to help.)

# 13 BRAKE SYSTEM

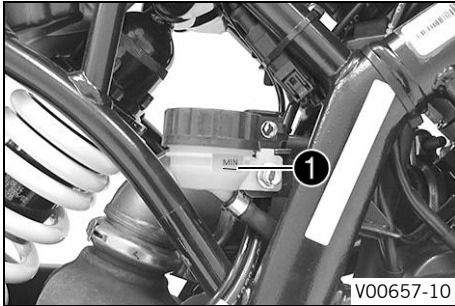

- Position the vehicle upright.
- Check the brake fluid level in the brake fluid reservoir.
  - » If the fluid level reaches the **MIN** marking ①:
    - Add rear brake fluid. 🛠️ 📖 p. 138)

## 13.7 Adding rear brake fluid 🛠️



### Warning

**Danger of accidents** An insufficient brake fluid level will cause the brake system to fail.

If the brake fluid level drops below the **MIN** marking, the brake system is leaking or the brake linings are worn down.

- Check the brake system and do not continue riding until the problem is eliminated. (Your authorized KTM workshop will be glad to help.)

**Warning**

**Skin irritation** Brake fluid causes skin irritation.

- Keep brake fluid out of the reach of children.
- Wear suitable protective clothing and safety glasses.
- Do not allow brake fluid to come into contact with the skin, the eyes or clothing.
- Consult a doctor immediately if brake fluid has been swallowed.
- Rinse the affected area with plenty of water in the event of contact with the skin.
- Rinse eyes thoroughly with water immediately and consult a doctor if brake fluid comes into contact with the eyes.
- If brake fluid spills on to your clothing, change the clothing.

**Warning**

**Danger of accidents** Old brake fluid reduces the braking effect.

- Make sure that brake fluid for the front and rear brake is changed in accordance with the service schedule. (Your authorized KTM workshop will be glad to help.)

**Note**

**Environmental hazard** Hazardous substances cause environmental damage.

- Dispose of oils, grease, filters, fuel, cleaning agents, brake fluid, etc., correctly and in compliance with the applicable regulations.
-

## **i** Info

Never use DOT 5 brake fluid. It is silicone-based and purple in color. Oil seals and brake lines are not designed for DOT 5 brake fluid.

Avoid contact between brake fluid and painted parts. Brake fluid attacks paint.

Only use clean brake fluid from a sealed container.

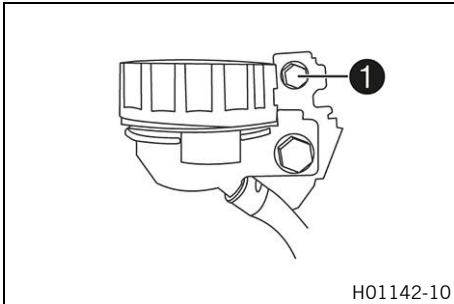

H01142-10

## **Preparatory work**

- Check the rear brake linings. (📖 p. 142)

## **Main work**

### **Condition**

The screw cap is locked.

- Remove screw **1** and take off the screw cap lock.

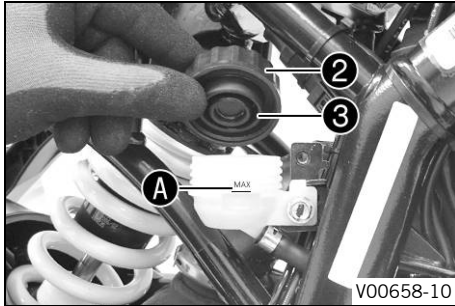

- Position the vehicle upright.
- Remove screw cap ② with membrane ③.
- Add brake fluid up to the marking A.

Brake fluid DOT 4 / DOT 5.1 (📖 p. 238)

- Mount the screw cap with the membrane.



### Info

Immediately clean up any brake fluid that has overflowed or spilled with water.

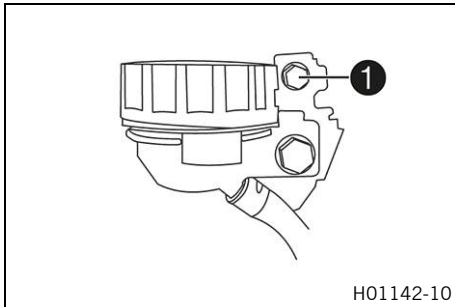

### Condition

The screw cap is locked.

- Position the screw cap lock and mount and tighten screw ①.

### Guideline

Screw, compensating tank cap lock, rear brake	M5	7 Nm (5.2 lbf ft)
---	----	-------------------

## 13.8 Checking the rear brake linings



### Warning

**Danger of accidents** Worn-out brake linings reduce the braking effect.

- Ensure that worn-out brake linings are replaced immediately. (Your authorized KTM workshop will be glad to help.)



### Warning

**Danger of accidents** Damaged brake discs reduce the braking effect.

If the brake linings are not changed in time, the brake lining carriers grind against the brake disc. As a consequence, the braking effect is greatly reduced and the brake discs are destroyed.

- Check the brake linings regularly.

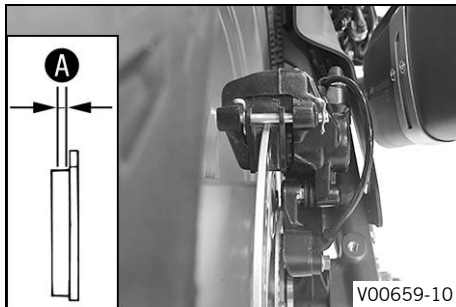

- Check the brake linings for minimum thickness **A**.

Minimum thickness <b>A</b>	$\geq 1 \text{ mm } (\geq 0.04 \text{ in})$
----------------------------	---

- » If the minimum thickness is less than specified:
  - Change the brake linings of the rear brake. 🛠️
- Check the brake linings for damage and cracking.
  - » If there is wear or tearing:
    - Change the brake linings of the rear brake. 🛠️



## 13.9 Checking the free travel of foot brake lever



### Warning

**Danger of accidents** The brake system fails in the event of overheating.

If there is no free travel on the foot brake lever, pressure builds up in the brake system on the rear brake.

- Set the free travel on the foot brake lever in accordance with the specification.

# 13 BRAKE SYSTEM

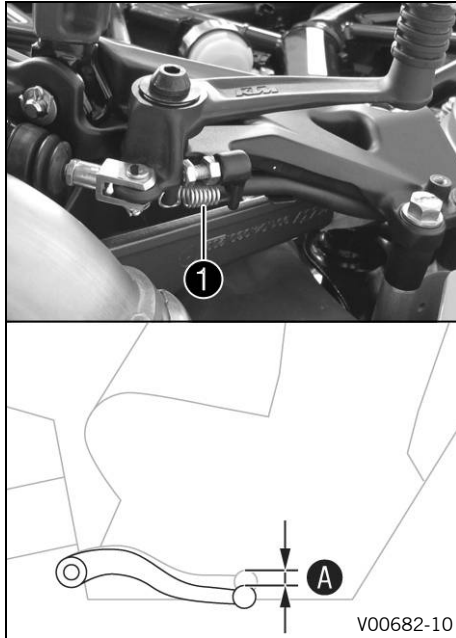

- Disconnect spring ①.
- Move the foot brake lever back and forth between the end stop and the contact to the foot brake cylinder piston and check free travel A.

Guideline

Free travel at foot brake lever	3 ... 5 mm (0.12 ... 0.2 in)
---------------------------------	------------------------------

- » If the free travel does not meet specifications:
  - Adjust the free travel of the foot brake lever. 🛠️  
(📖 p. 145)
- Reconnect spring ①.

## 13.10 Adjusting the free travel of the foot brake lever ↩



### Warning

**Danger of accidents** The brake system fails in the event of overheating.

If there is no free travel on the foot brake lever, pressure builds up in the brake system on the rear brake.

- Set the free travel on the foot brake lever in accordance with the specification.

# 13 BRAKE SYSTEM

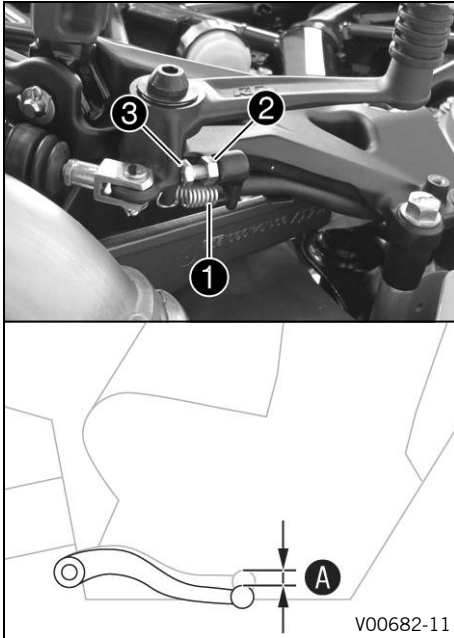

- Detach spring ①.
- Release nut ② and use screw ③ to adjust the specified free travel A.

Guideline

Free travel at foot brake lever	3 ... 5 mm (0.12 ... 0.2 in)
---------------------------------	------------------------------



### Info

The range of adjustment is limited.

- Hold screw ③ and tighten nut ②.
- Attach spring ①.

## 14.1 Removing the front wheel ↘

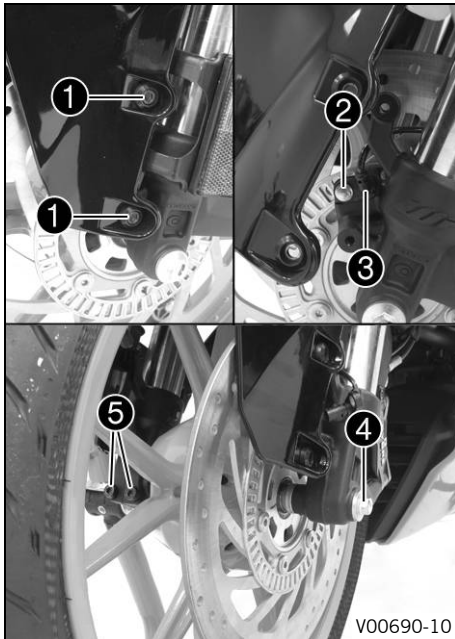

### Preparatory work

- Raise the motorcycle with the rear lifting gear. (📖 p. 100)
- Lift the motorcycle with the front lifting gear. (📖 p. 101)

### Main work

- Remove screws ❶, take off reflector and push the fender to the side.
- Remove screw ❷ and pull wheel speed sensor ❸ out of the hole.
- Loosen screw ❹ by several rotations.
- Loosen screws ❺.
- Press on screw ❹ to push the wheel spindle out of the axle clamp.
- Remove screw ❹.



### Warning

**Danger of accidents** Damaged brake discs reduce the braking effect.

- Always lay the wheel down in such a way that the brake disc is not damaged.

- Hold the front wheel and remove the wheel spindle. Take the front wheel out of the fork.



## Info

Do not actuate the hand brake lever when the front wheel is removed.

## 14.2 Installing the front wheel ↩



### Warning

**Danger of accidents** Oil or grease on the brake discs reduces the braking effect.

- Always keep the brake discs free of oil and grease.
- Clean the brake discs with brake cleaner when necessary.

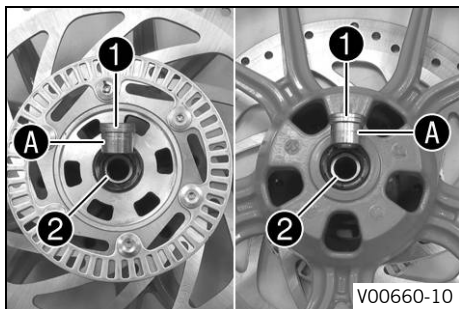

- Remove spacers ①.
- Check the wheel bearing for damage and wear.
  - » If the wheel bearing is damaged or worn:
    - Change front wheel bearing. ↩
- Clean and grease shaft seal rings ② and contact surfaces A

Long-life grease (📖 p. 242)

- Insert the spacers.

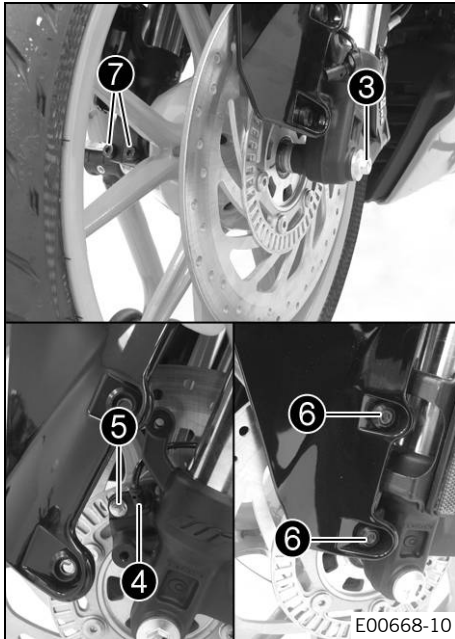

- Clean the thread of the wheel spindle and screw **3**.
- Grease wheel spindle.

Long-life grease (📖 p. 242)

- Position the front wheel and insert the wheel spindle.  
✓ The brake linings are correctly positioned.
- Mount and tighten screw **3**.

Guideline

Screw, front wheel spindle	M8	26 Nm (19.2 lbf ft)
----------------------------	----	---------------------

- Position wheel speed sensor **4** in the hole.
- Position reflector.
- Mount and tighten screw **5**.

Guideline

Screw, wheel speed sensor holder	M6	8 Nm (5.9 lbf ft)
----------------------------------	----	-------------------

- Mount and tighten screws **6**.
- Operate the hand brake lever repeatedly until the brake linings are in contact with the brake disc and there is a pressure point.
- Take the motorcycle off the front lifting gear. (📖 p. 103)
- Remove the rear of the motorcycle from the lifting gear. (📖 p. 100)

# 14 WHEELS, TIRES

- Operate the front brake and compress the fork a few times firmly.
  - ✓ The fork legs straighten.
- Tighten screws ⑦.

Guideline

Screw, fork stub	M8	15 Nm (11.1 lbf ft)
------------------	----	---------------------

## 14.3 Removing the rear wheel ↘

### Preparatory work

- Raise the motorcycle with the rear lifting gear. (📖 p. 100)

### Main work

- Remove screw ①.
- Remove screw ② with the bushing.

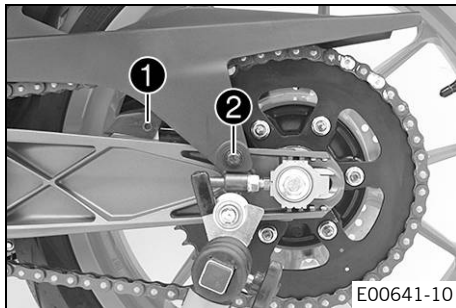



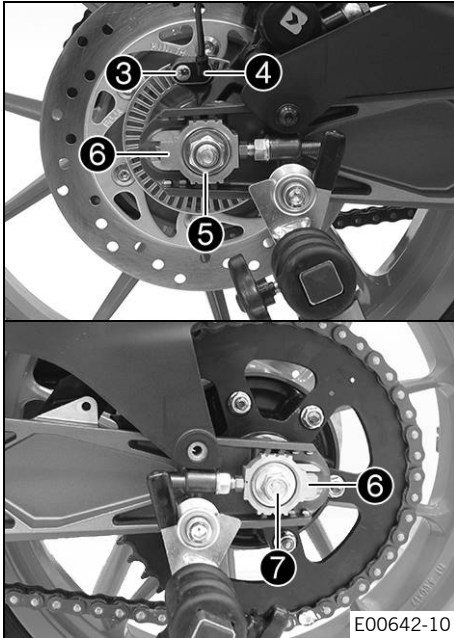

- Remove screw ③ and pull wheel speed sensor ④ out of the hole.
- Remove nut ⑤ and washer.
- Take off chain adjuster ⑥.
- Holding the rear wheel, withdraw wheel spindle ⑦ with the washer and chain adjuster ⑥.
- Push the rear wheel forward as far as possible and take the chain off the rear sprocket.
- Press the chain guard upward and to one side.



### Warning

**Danger of accidents** Damaged brake discs reduce the braking effect.

- Always lay the wheel down in such a way that the brake disc is not damaged.

- Pull the rear wheel back and take it out of the link fork.



### Info

Do not operate the foot brake lever when the rear wheel is removed.



## 14.4 Installing the rear wheel 🛠️



### Warning

**Danger of accidents** Oil or grease on the brake discs reduces the braking effect.

- Always keep the brake discs free of oil and grease.
- Clean the brake discs with brake cleaner when necessary.



### Warning

**Danger of accidents** There is no braking effect to start with at the rear brake after installing the rear wheel.

- Actuate the foot brake several times before going on a ride until you can feel a firm pressure point.

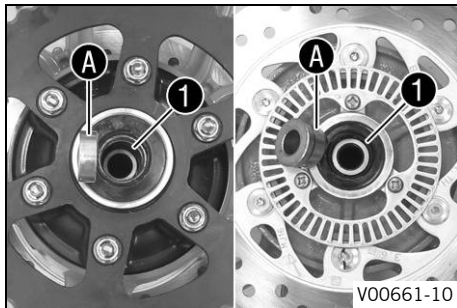

### Main work

- Check the rear hub damping rubber pieces. 🛠️ (📖 p. 155)
- Remove the spacers.
- Check the wheel bearing for damage and wear.
  - » If the wheel bearing is damaged or worn:
    - Change the rear wheel bearing. 🛠️
- Clean and grease shaft seal rings ① and contact surfaces ② of the spacers.

Long-life grease (📖 p. 242)
- Insert the spacers.
- Clean the thread of the wheel spindle and nut ②.

- Clean and grease wheel spindle.

Long-life grease (📖 p. 242)

- Clean the contact areas on the brake caliper bracket and link fork.
- Position the rear wheel.
  - ✓ The brake linings are correctly positioned.
- Push chain guard to the side.
- Push the rear wheel forward as far as possible and lay the chain on the rear sprocket.

# 14 WHEELS, TIRES

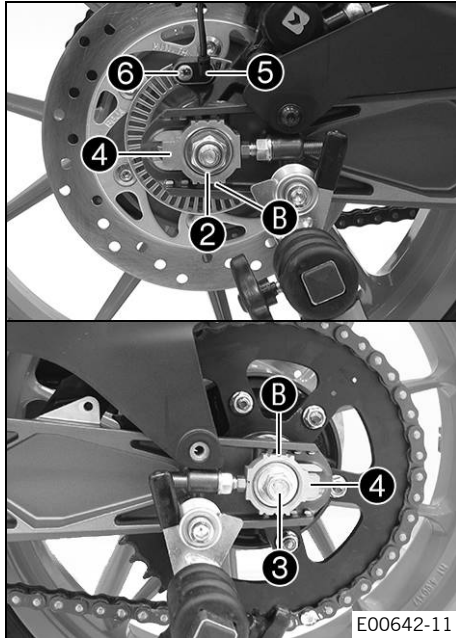

E00642-11

- Pull the rear wheel back and mount wheel spindle **3** with the washers and chain adjusters **4**.



### Info

Mount left and right chain adjusters **4** in the same position.

- Mount nut **2**, but do not tighten yet.
- Ensure that the chain adjusters lie flat on the screws and tighten nut **2**.

### Guideline

In order for the rear wheel to be correctly aligned, the markings on the left and right chain adjusters must be in the same position relative to reference markings **B**.

Nut, rear wheel spindle	M14x1.5	90 Nm (66.4 lbf ft)
-------------------------	---------	---------------------

- Position wheel speed sensor **5** in the hole. Mount and tighten screw **6**.

### Guideline

Screw, wheel speed sensor holder	M6	8 Nm (5.9 lbf ft)
----------------------------------	----	-------------------

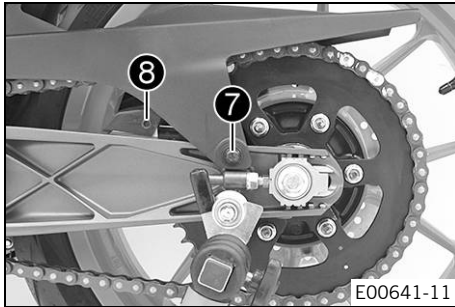

- Position the chain guard.
- Mount and tighten screw ⑦.

Guideline

Screw, chain guard	M6	6 Nm (4.4 lbf ft)
--------------------	----	-------------------

- Mount and tighten screw ⑧.

Guideline

Screw, chain guard	<b>EJOT PT®</b> K60x30	4 Nm (3 lbf ft)
--------------------	---------------------------	-----------------

**Finishing work**

- Check the chain tension. (📖 p. 112)
- Remove the rear of the motorcycle from the lifting gear. (🛠️ p. 100)



## 14.5 Checking the rear hub damping rubber pieces 🛠️



**Info**

The engine power is transmitted from the rear sprocket to the rear wheel via the 6 damping rubber pieces. They eventually wear out during operation. If the damping rubber pieces are not changed in time, the rear sprocket carrier and the rear hub will be damaged.

**Preparatory work**

- Raise the motorcycle with the rear lifting gear. (🛠️ p. 100)
- Remove the rear wheel. 🛠️ (📖 p. 150)

# 14 WHEELS, TIRES

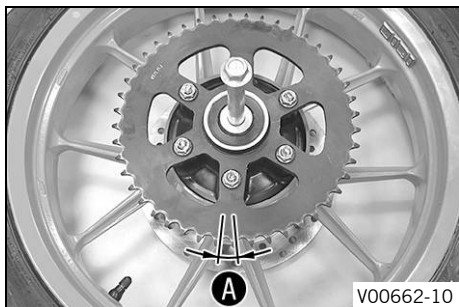
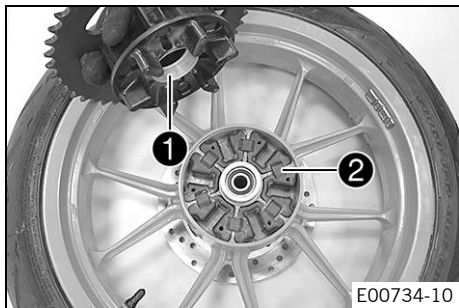

## Main work

- Check bearing ①.
  - » If the bearing is damaged or worn:
    - Change the rear wheel bearing. 🛠️
- Check damping rubber pieces ② of the rear hub for damage and wear.
  - » If the damping rubber pieces of the rear hub are damaged or worn:
    - Change all the damping rubber pieces of the rear hub.



## Warning

**Danger of accidents** Damaged brake discs reduce the braking effect.

- Always lay the wheel down in such a way that the brake disc is not damaged.

- Lay the rear wheel on a workbench with the rear sprocket facing upward and insert the wheel spindle in the hub.
- To check the play ①, hold the rear wheel tight and try to rotate the rear sprocket.



## Info

Measure the play on the outside of the rear sprocket.

Play of damping rubber pieces on rear wheel	≤ 5 mm (≤ 0.2 in)
---	-------------------

- » If clearance **A** is larger than the specified value:
  - Change all the damping rubber pieces of the rear hub.

### Finishing work

- Install the rear wheel.  (📖 p. 152)
- Check the chain tension. (📖 p. 112)
- Remove the rear of the motorcycle from the lifting gear. (📖 p. 100)



## 14.6 Checking the tire condition



### Warning

**Danger of accidents** If a tire bursts while riding, the vehicle becomes uncontrollable.

- Ensure that damaged or worn tires are replaced immediately. (Your authorized KTM workshop will be glad to help.)



### Warning

**Danger of crashing** Different tire tread patterns on the front and rear wheel impair the handling characteristic.

Different tire tread patterns can make the vehicle significantly more difficult to control.

- Make sure that only tires with a similar tire tread pattern are fitted to the front and rear wheel.



## Warning

**Danger of accidents** Non-approved or non-recommended tires and wheels impact the handling characteristic.

- Only use tires/wheels approved by KTM with the corresponding speed index.



## Info

The type, condition, and pressure of the tires all have a major impact on the handling characteristic of the motorcycle.

Worn tires have a negative effect on handling characteristics, especially on wet surfaces.

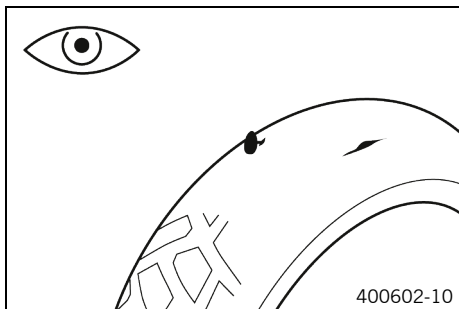

- Check the front and rear tires for cuts, run-in objects, and other damage.
  - » If the tires have cuts, run-in objects, or other damage:
    - Change the tires. 🛠️
- Check the tread depth.



## Info

Observe the minimum tread depth required by national law.

Minimum tread depth	≥ 2 mm (≥ 0.08 in)
---------------------	--------------------

- » If the tread depth is less than the minimum tread depth:
  - Change the tires. 🛠️



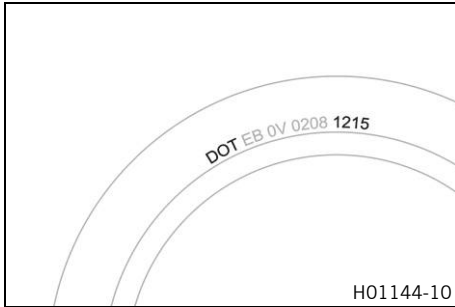

- Check the tire age.



### Info

The tire date of manufacture is usually contained in the tire label and is indicated by the last four digits of the **DOT** number. The first two digits indicate the week of manufacture and the last two digits the year of manufacture.

KTM recommends that the tires be changed after 5 years at the latest, regardless of the actual state of wear.

- » If the tires are more than 5 years old:
  - Change the tires. 🛠️



## 14.7 Checking tire pressure



### Info

Low tire pressure leads to abnormal wear and overheating of the tire.

Correct tire pressure ensures optimal riding comfort and maximum tire service life.

# 14 WHEELS, TIRES

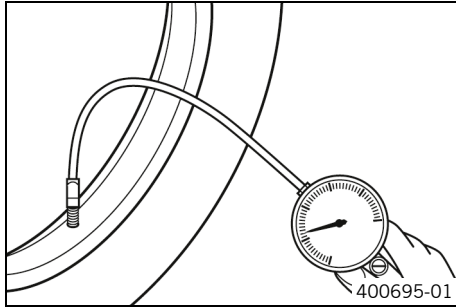

- Remove the protection cap.
- Check the tire pressure when the tires are cold.

Tire pressure when solo	
front	2.0 bar (29 psi)
rear	2.0 bar (29 psi)

Tire pressure with passenger / full payload	
front	2.0 bar (29 psi)
rear	2.2 bar (32 psi)

- » If the tire pressure does not meet specifications:
  - Correct the tire pressure.
- Mount the protection cap.



## 15.1 Removing the 12-V battery ↴



### Warning

**Risk of injury** Battery acid and battery gases cause serious chemical burns.

- Keep 12 V batteries out of the reach of children.
- Wear suitable protective clothing and safety glasses.
- Avoid contact with battery acid and battery gases.
- Keep sparks or open flames away from the 12 V battery.
- Only charge 12 V batteries in well-ventilated rooms.
- Rinse the affected area immediately with plenty of water in the event of contact with the skin.
- Rinse eyes with water for at least 15 minutes and consult a doctor immediately if battery acid and battery gases get into the eyes.

### Preparatory work

- Switch off the ignition by turning the ignition key to the position ☒.
- Remove the front rider's seat. (📖 p. 106)
- Remove the battery cover. (📖 p. 118)

# 15 ELECTRICAL SYSTEM

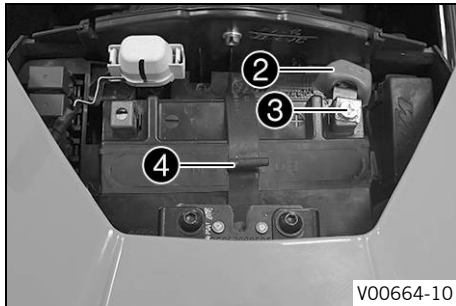
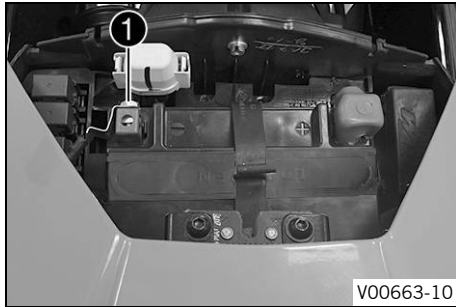

## Main work

- Disconnect negative cable ❶ from the 12-V battery.

- Pull back positive terminal cover ❷.
- Disconnect positive cable ❸ from the 12-V battery.
- Detach rubber strap ❹.
- Pull the 12-V battery upwards and out of the battery compartment.



## Info

Never operate the motorcycle with a discharged 12-V battery or without a 12-V battery. In both cases, electrical components and safety devices can be damaged. In this case the vehicle is no longer roadworthy.

## 15.2 Installing the 12-V battery ↗

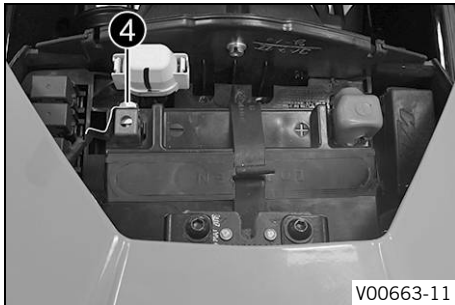
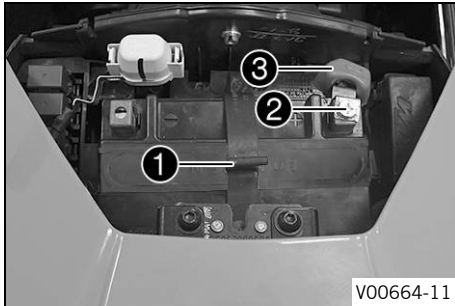

### Main work

- Mount rubber strap ① on the battery compartment.
- Position the 12-V battery in the battery compartment.

### Guideline

The terminals of the battery must face upwards.

12-V battery (ETZ-9-BS) (📖 p. 229)

- Attach rubber strap ①.
- Position positive cable ② and mount and tighten the screw.
- Position positive terminal cover ③.
- Position negative cable ④; mount and tighten the screw.

### Finishing work

- Mount the battery cover. (📖 p. 120)
- Mount the front rider's seat. (📖 p. 107)

- Set the clock. (📖 p. 68)

## 15.3 Charging the 12-V battery ↴



### Warning

**Risk of injury** Battery acid and battery gases cause serious chemical burns.

- Keep 12 V batteries out of the reach of children.
- Wear suitable protective clothing and safety glasses.
- Avoid contact with battery acid and battery gases.
- Keep sparks or open flames away from the 12 V battery.
- Only charge 12 V batteries in well-ventilated rooms.
- Rinse the affected area immediately with plenty of water in the event of contact with the skin.
- Rinse eyes with water for at least 15 minutes and consult a doctor immediately if battery acid and battery gases get into the eyes.



### Note

**Environmental hazard** 12 V batteries contain environmentally hazardous materials.

- Do not dispose of 12 V batteries as household waste.
- Dispose of 12 V batteries at a collection point for used batteries.

**Info**

Even if there is no load on the 12-V battery, it discharges steadily.

The charging level and the method of charging are very important for the service life of the 12-V battery.

Rapid recharging with a high charging current shortens the service life of the battery.

If the charging current, charging voltage, or charging time is exceeded, electrolyte escapes through the safety valves. This reduces the capacity of the 12-V battery.

If the 12-V battery is depleted by repeated starting, the 12-V battery must be charged immediately.

If the 12-V battery is left in a discharged state for an extended period, it will become deeply discharged and sulfating occurs, destroying the battery.

The 12-V battery is maintenance-free. The acid level does not have to be checked.

---

**Preparatory work**

- Switch off the ignition by turning the ignition key to the position
- Remove the front rider's seat. ( p. 106)
- Remove the battery cover. ( p. 118)
- Disconnect negative cable of the 12-V battery to avoid damage to the onboard electronics.



## Main work

- Connect the battery charger to the 12-V battery. Switch on the battery charger.

Battery charger (58429074000)

In addition, this battery charger can be used to test the open-circuit voltage, the starting ability of the 12-V battery, and the alternator. It is impossible to overcharge the 12-V battery using this device.



## Info

Never remove cover ①.

- Switch off the battery charger after charging and disconnect it from the 12-V battery.

## Guideline

The charging current, charging voltage, and charging time must not be exceeded.

Recharge the 12-V battery regularly when the motorcycle is not being used

3 months

- Position the negative cable and mount and tighten the screw.

## Finishing work

- Mount the battery cover. (🔧 p. 120)
- Mount the front rider's seat. (🔧 p. 107)



- Set the clock. (📖 p. 68)



## 15.4 Changing the ABS fuses



### Warning

**Fire hazard** Incorrect fuses overload the electrical system.

- Only use fuses with the required ampere value.
- Do not bypass or repair fuses.



### Info

Two fuses for the ABS are located under the protection cap next to the negative terminal of the 12-V battery. These fuses protect the return pump and the hydraulic unit of the ABS. The third fuse, which protects the ABS control unit, is located in the fuse box.

### Preparatory work

- Switch off the ignition by turning the ignition key to the position .
- Remove the front rider's seat. (📖 p. 106)
- Remove the battery cover. (📖 p. 118)

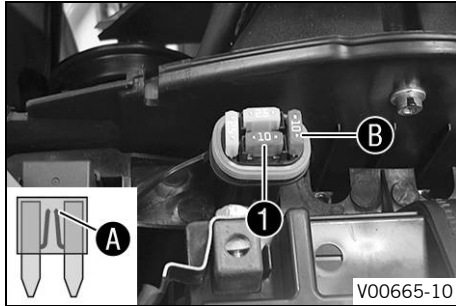

## To change the fuse of the ABS hydraulic unit:

- Take off the protection cap and remove fuse ①.



### Info

A faulty fuse has a burned-out fuse wire ①.



### Warning

**Fire hazard** Incorrect fuses overload the electrical system.

- Only use fuses with the required ampere value.
- Do not bypass or repair fuses.

- Insert the spare fuse with the correct rating.

Fuse (75011088010) (📖 p. 229)



### Tip

Insert spare fuse ② in the fuse box so that it is available if needed.

- Mount the protection cap.

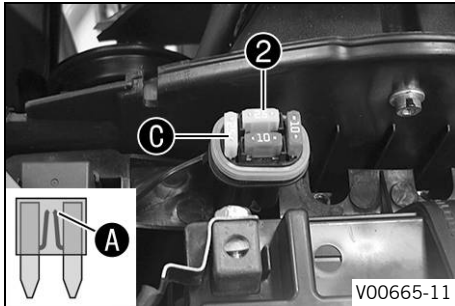

### To change the fuse of the ABS return pump:

- Take off the protection cap and remove fuse ②.



#### Info

A faulty fuse has a burned-out fuse wire ①.



#### Warning

**Fire hazard** Incorrect fuses overload the electrical system.

- Only use fuses with the required ampere value.
- Do not bypass or repair fuses.

- Insert the spare fuse with the correct rating.

Fuse (90111088025) (📖 p. 230)



#### Tip

Insert spare fuse ③ in the fuse box so that it is available if needed.

- Mount the protection cap.

### Finishing work

- Mount the battery cover. (📖 p. 120)
- Mount the front rider's seat. (📖 p. 107)



## 15.5 Changing the fuses of individual power consumers



### Info

The fuse box with the main fuse and fuses of the individual power consumers is located next to the positive terminal of the 12-V battery.

### Preparatory work

- Switch off the ignition by turning the ignition key to the position  $\otimes$ .
- Remove the front rider's seat. (📖 p. 106)
- Remove the battery cover. (📖 p. 118)

### Main work

- Open fuse box cover.
- Remove the faulty fuse.

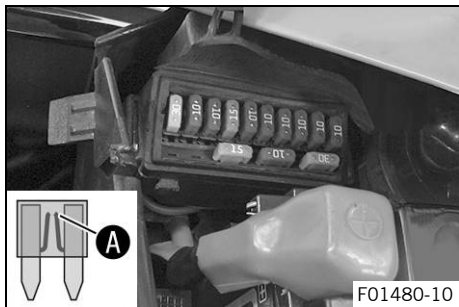

## Guideline

Fuse <b>1</b> - 30 A - main fuse
Fuse <b>2</b> - 10 A - combination instrument, alarm system (optional)
Fuse <b>3</b> - 10 A - engine electronics control unit, power relay
Fuse <b>4</b> - 15 A - ignition coil, starter relay, fuel pump, horn
Fuse <b>5</b> - 15 A - radiator fan
Fuse <b>6</b> - 10 A - brake light, turn signal, high beam, low beam, position light, tail light, license plate lamp
Fuse <b>7</b> - 10 A - combination instrument, diagnostics connector, ABS control unit
Fuse <b>8</b> - 10 A - alarm system (optional)
Fuse <b>9</b> - 10 A - permanent positive for auxiliary equipment (ACC1 front)
Fuse <b>10</b> - 10 A - ignition positive for auxiliary equipment (ACC2 front)
Fuse <b>SPARE</b> - 10 A/15 A/30 A - spare fuses

**Info**

A faulty fuse has a burned-out fuse wire .



## Warning

**Fire hazard** Incorrect fuses overload the electrical system.

- Only use fuses with the required ampere value.
- Do not bypass or repair fuses.

- Insert a spare fuse with the correct rating.

Fuse (75011088010) (📖 p. 229)
-------------------------------

Fuse (75011088015) (📖 p. 230)
-------------------------------

Fuse (75011088030) (📖 p. 230)
-------------------------------



## Tip

Replace the spare fuse in the fuse box so that it is available if needed.

- Check that the power consumer is functioning properly.
- Close the fuse box cover.

## Finishing work

- Mount the battery cover. (📖 p. 120)
- Mount the front rider's seat. (📖 p. 107)

## 15.6 Changing the low beam bulb

---

### Note

**Damage to reflector** Grease on the reflector reduces the light intensity.

Grease on the bulb will evaporate due to the heat and be deposited on the reflector.

- Clean and degrease the bulbs before mounting.
  - Do not touch the bulbs with your bare hands.
- 

### Preparatory work

- Switch off the ignition by turning the ignition key to the position  $\otimes$ .

# 15 ELECTRICAL SYSTEM

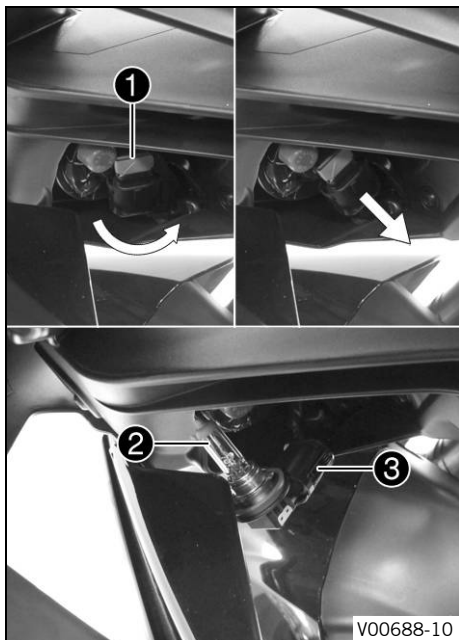

## Main work

- Turn socket ① counterclockwise.
- Pull the socket with low beam bulb ② out of the headlight housing.
- Disconnect the socket with the low beam bulb from connector ③ and remove.
- Connect the new socket with the low beam bulb to the connector.

Low beam (H11/socket PGJ19-2) (📖 p. 230)



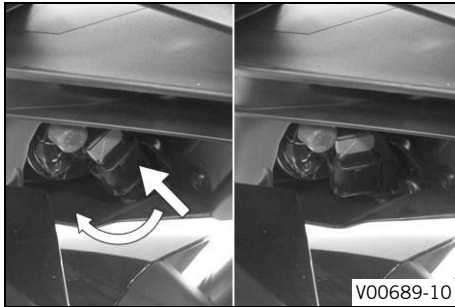

- Position the socket with the low beam bulb in the headlight housing.
- Turn the socket clockwise.
- Check that the lighting is functioning properly.

#### Finishing work

- Check the low beam headlight setting. (📖 p. 177)



## 15.7 Changing the high beam bulb

### Note

**Damage to reflector** Grease on the reflector reduces the light intensity.

Grease on the bulb will evaporate due to the heat and be deposited on the reflector.

- Clean and degrease the bulbs before mounting.
- Do not touch the bulbs with your bare hands.

### Preparatory work

- Switch off the ignition by turning the ignition key to the position ☒.

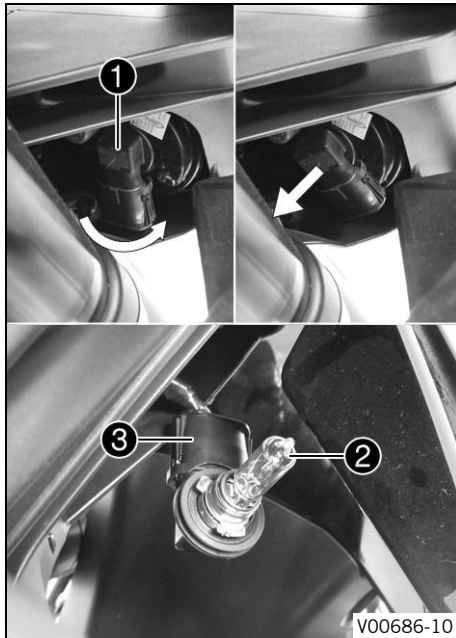

## Main work

- Turn socket ❶ counterclockwise.
- Pull the socket with high beam bulb ❷ out of the headlight housing.
- Disconnect the socket with the high beam bulb from connector ❸ and remove.
- Connect the new socket with the high beam bulb to the connector.

High beam (H9/socket PGJ19-5) (📖 p. 230)

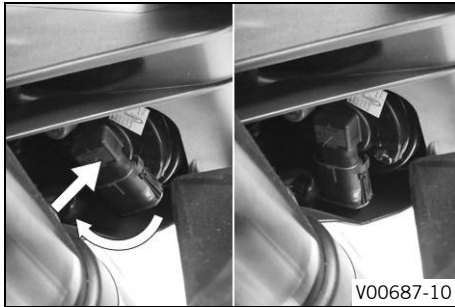

- Position the socket with the high beam bulb in the headlight housing.
- Turn the socket clockwise.
- Check that the lighting is functioning properly.

### Finishing work

- Check the high beam headlight setting. (📖 p. 179)



## 15.8 Checking the low beam headlight adjustment

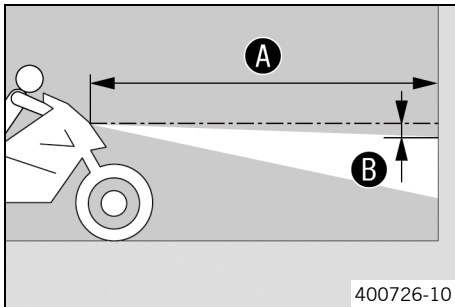

- Park the vehicle on a horizontal surface in front of a light-colored wall and make a mark at the height of the center of the low beam headlight.
  - Make another mark at a distance **B** under the first marking.
- Guideline

Distance <b>B</b>	5 cm (2 in)
-------------------	-------------

- Position the vehicle upright at distance **A** from the wall and switch on the low beam.

## Guideline

Distance <b>A</b>	5 m (16 ft)
-------------------	-------------

- The rider now mounts the motorcycle with luggage and passenger if applicable.
- Check the low beam headlight setting.

The light-dark boundary must be exactly on the lower marking when the motorcycle is ready to be operated with the rider mounted along with any luggage and a passenger if applicable.

- » If the boundary between light and dark does not meet specifications:
  - Adjust the headlight range of the low beam.  
(📖 p. 180)



## 15.9 Checking the high beam headlight adjustment

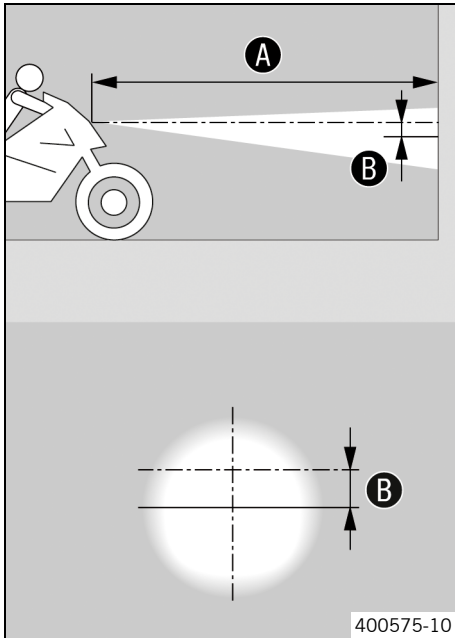

- Position the vehicle upright on a horizontal surface in front of a light wall and make a marking at the height of the center of the low beam headlight.
- Make another mark at a distance **B** under the first marking.

Guideline

Distance <b>B</b>	5 cm (2 in)
-------------------	-------------

- Position the vehicle perpendicular to the wall at a distance **A** from the wall and switch on the high beam.

Guideline

Distance <b>A</b>	5 m (16 ft)
-------------------	-------------

- The rider now mounts the motorcycle with luggage and passenger if applicable.
- Check the high beam headlight setting.

The center of the light cone must lie exactly on the lower marking when the motorcycle is ready to operate with the rider mounted along with any luggage and a passenger if applicable.
---

- » If the center of the light cone is not located where specified:
  - Adjust the headlight range of the high beam. (📖 p. 181)



## 15.10 Adjusting the headlight range of the low beam



### Main work

- Adjust the low beam headlight range by turning screw ❶.

### Guideline

For a motorcycle with a rider, and any luggage and/or passenger, the light/dark boundary must be exactly on the lower marking (applied in: Checking the low beam headlight setting).



### Info

Turn clockwise to increase the headlight range; turn counterclockwise to reduce the headlight range.

### Finishing work

- Check the low beam headlight setting. (📖 p. 177)

## 15.11 Adjusting the headlight range of the high beam

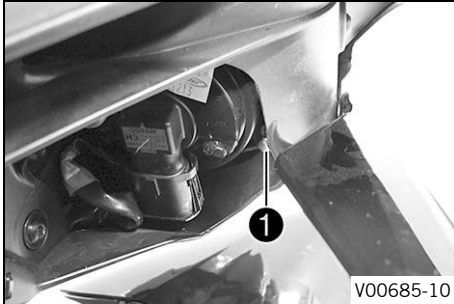

### Main work

- Adjust the high beam headlight range by turning screw ❶.

### Guideline

For a motorcycle with rider, and with luggage and a passenger if applicable, the light/dark boundary must be exactly on the lower marking (applied in: Checking the high beam headlight setting).



### Info

Turn clockwise to increase the headlight range; turn counterclockwise to reduce the headlight range.

### Finishing work

- Check the high beam headlight setting. (📖 p. 179)



## 15.12 Diagnostics connector

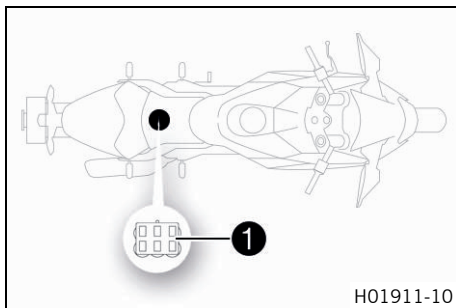

Diagnostics connector **1** is located under the front rider's seat.

## 15.13 Front ACC1 and ACC2

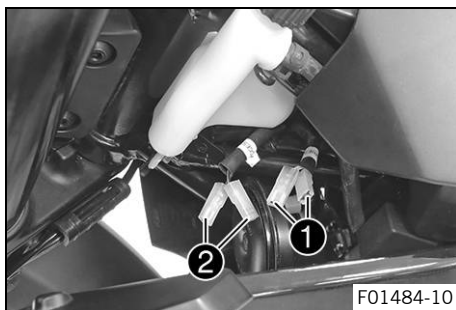

### Installation location

- Power supplies ACC1 **1** and ACC2 **2** front are located under the compensating tank.

### **i** Info

The power supplies are protected by a fuse, however this fuse also protects other power consumers. The maximum continuous load is therefore significantly lower than the value of the fuse. Do not use a stronger fuse.



## 16.1 Cooling system

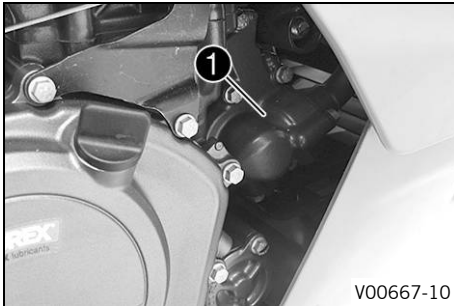

Water pump ① in the engine ensures forced circulation of the coolant.

The pressure resulting from the warming of the cooling system is regulated by a valve in radiator cap ②. Heat expansion causes excess coolant to flow into compensating tank ③. When the temperature falls, this surplus coolant is sucked back into the cooling system. This ensures that operating the vehicle at the specified coolant temperature will not result in a risk of malfunctions.

110 °C (230 °F)

# 16 COOLING SYSTEM

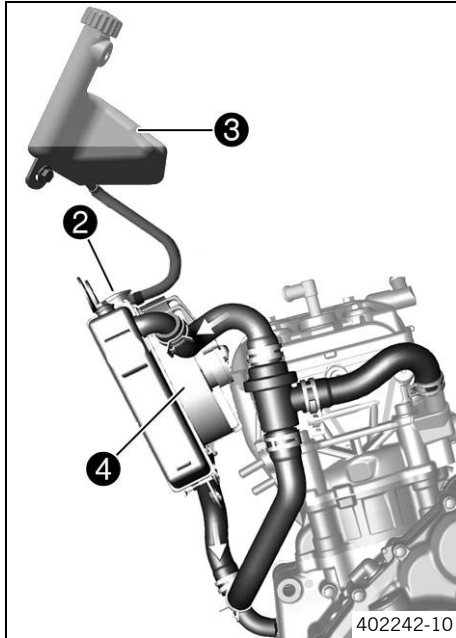

The coolant is cooled by the air stream and a radiator fan **4**, which is activated at high temperature. The lower the speed, the less the cooling effect. Dirty cooling fins also reduce the cooling effect.



## Info

If the cooling system overheats, the maximum engine speed is limited.

## 16.2 Checking the coolant level in the compensating tank



### Warning

**Danger of scalding** During motorcycle operation, the coolant gets very hot and is under pressure.

- Do not open the radiator, the radiator hoses or other cooling system components if the engine or the cooling system are at operating temperature.
- Allow the cooling system and the engine to cool down before you open the radiator, the radiator hoses or other components of the cooling system.
- In the event of scalding, rinse the area affected immediately with lukewarm water.



### Warning

**Danger of poisoning** Coolant is toxic and a health hazard.

- Keep coolant out of the reach of children.
- Do not allow coolant to come into contact with the skin, the eyes and clothing.
- Consult a doctor immediately if coolant is swallowed.
- Rinse the affected area immediately with plenty of water in the event of contact with the skin.
- Rinse eyes thoroughly with water and consult a doctor immediately if coolant gets into the eyes.
- Change clothing if coolant spills onto your clothing.

### Condition

The engine is cold.

The radiator is completely full.

# 16 COOLING SYSTEM

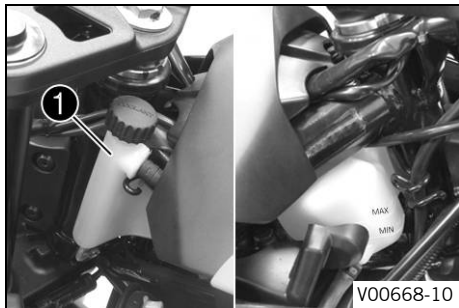

- Stand the motorcycle upright on a horizontal surface.
- Check the coolant level in the compensating tank ①.

The coolant level must be between **MIN** and **MAX**.

- » If there is no coolant in the compensating tank:
  - Check the cooling system for leaks. 🛠️



### Info

Do not start up the motorcycle!

- Fill/bleed the cooling system. 🛠️ (📖 p. 193)
- » If the coolant in the compensating tank is not at the required level, but the tank is not empty:
  - Correct the coolant level in the compensating tank. (📖 p. 190)

### 16.3 Checking the antifreeze and coolant level



#### Warning

**Danger of scalding** During motorcycle operation, the coolant gets very hot and is under pressure.

- Do not open the radiator, the radiator hoses or other cooling system components if the engine or the cooling system are at operating temperature.
- Allow the cooling system and the engine to cool down before you open the radiator, the radiator hoses or other components of the cooling system.
- In the event of scalding, rinse the area affected immediately with lukewarm water.



#### Warning

**Danger of poisoning** Coolant is toxic and a health hazard.

- Keep coolant out of the reach of children.
- Do not allow coolant to come into contact with the skin, the eyes and clothing.
- Consult a doctor immediately if coolant is swallowed.
- Rinse the affected area immediately with plenty of water in the event of contact with the skin.
- Rinse eyes thoroughly with water and consult a doctor immediately if coolant gets into the eyes.
- Change clothing if coolant spills onto your clothing.

#### Condition

The engine is cold.

#### Preparatory work

- Remove the right side cover. 🛠️ (📖 p. 127)

# 16 COOLING SYSTEM

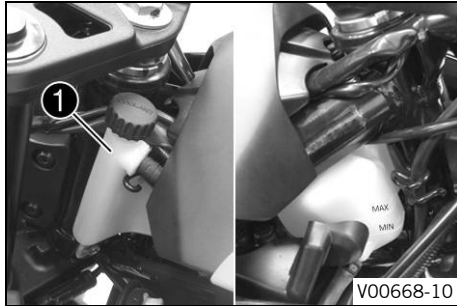

## Main work

- Stand the motorcycle upright on a horizontal surface.
- Take off the cap of compensating tank ①.
- Check the antifreeze in the coolant.

-25 ... -45 °C (-13 ... -49 °F)

- » If the antifreeze in the coolant does not match the specified value:
  - Correct the antifreeze in the coolant.

- Check the coolant level in the compensating tank.

The coolant level must be between **MIN** and **MAX**.

- » If the coolant level does not match the specified value:
  - Correct the coolant level.

Coolant (📖 p. 238)

- Mount the cap of the compensating tank.

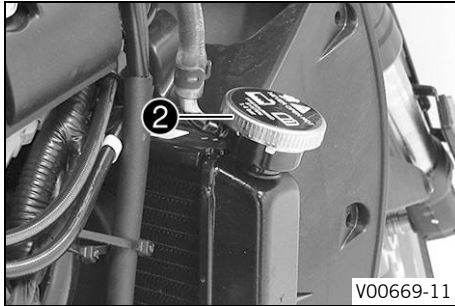

- Take off radiator cap ②.
- Check the antifreeze in the coolant.

-25 ... -45 °C (-13 ... -49 °F)

- » If the antifreeze in the coolant does not match the specified value:
  - Correct the antifreeze in the coolant.

- Check the coolant level in the radiator.

The radiator must be filled completely.

- » If the coolant level does not match the specified value:
  - Check the coolant level and the reason for the loss.

Coolant (📖 p. 238)

- » If you had to add more coolant than the specified amount:
  - > 0.20 l (> 0.21 qt.)
    - Fill/bleed the cooling system. 🛠️ (📖 p. 193)

- Mount the radiator cap.

### Finishing work

- Install the right side cover. 🛠️ (📖 p. 128)



## 16.4 Correcting the coolant level in the compensating tank



### Warning

**Danger of scalding** During motorcycle operation, the coolant gets very hot and is under pressure.

- Do not open the radiator, the radiator hoses or other cooling system components if the engine or the cooling system are at operating temperature.
- Allow the cooling system and the engine to cool down before you open the radiator, the radiator hoses or other components of the cooling system.
- In the event of scalding, rinse the area affected immediately with lukewarm water.



### Warning

**Danger of poisoning** Coolant is toxic and a health hazard.

- Keep coolant out of the reach of children.
- Do not allow coolant to come into contact with the skin, the eyes and clothing.
- Consult a doctor immediately if coolant is swallowed.
- Rinse the affected area immediately with plenty of water in the event of contact with the skin.
- Rinse eyes thoroughly with water and consult a doctor immediately if coolant gets into the eyes.
- Change clothing if coolant spills onto your clothing.

### Condition

The engine is cold.

The radiator is completely full.

### Preparatory work

- Check the coolant level in the compensating tank. (📖 p. 185)

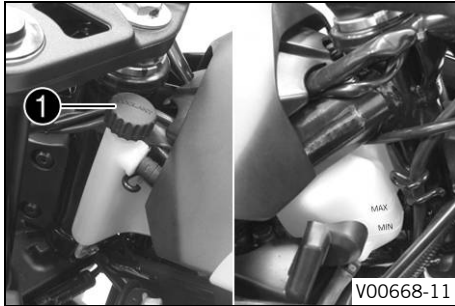

**Main work**

- Remove cap ❶ of the compensating tank.
- Add coolant up to the **MAX** marking.

Coolant (📖 p. 238)

- Mount the cap of the compensating tank.



## 16.5 Draining the coolant 🛠️

**Warning**

**Danger of scalding** During motorcycle operation, the coolant gets very hot and is under pressure.

- Do not open the radiator, the radiator hoses or other cooling system components if the engine or the cooling system are at operating temperature.
- Allow the cooling system and the engine to cool down before you open the radiator, the radiator hoses or other components of the cooling system.
- In the event of scalding, rinse the area affected immediately with lukewarm water.



## Warning

**Danger of poisoning** Coolant is toxic and a health hazard.

- Keep coolant out of the reach of children.
- Do not allow coolant to come into contact with the skin, the eyes and clothing.
- Consult a doctor immediately if coolant is swallowed.
- Rinse the affected area immediately with plenty of water in the event of contact with the skin.
- Rinse eyes thoroughly with water and consult a doctor immediately if coolant gets into the eyes.
- Change clothing if coolant spills onto your clothing.

---

## Condition

The engine is cold.

## Preparatory work

- Remove the front spoiler. (📖 p. 121)
- Remove the left side cover. 🛠️ (📖 p. 124)
- Remove the right side cover. 🛠️ (📖 p. 127)

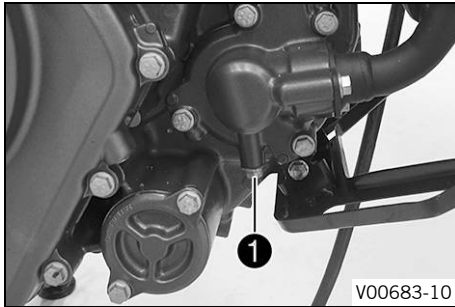

### Main work

- Position the motorcycle upright.
- Place an appropriate container under the engine.
- Remove screw ❶.
- Take off the radiator cap.
- Completely drain the coolant.
- Mount and tighten screw ❶ with a new seal ring.

### Guideline

Screw plug, water pump drain hole	M6	10 Nm (7.4 lbf ft)
-----------------------------------	----	--------------------



## 16.6 Filling/bleeding the cooling system ↩



### Warning

**Danger of poisoning** Coolant is toxic and a health hazard.

- Keep coolant out of the reach of children.
- Do not allow coolant to come into contact with the skin, the eyes and clothing.
- Consult a doctor immediately if coolant is swallowed.
- Rinse the affected area immediately with plenty of water in the event of contact with the skin.
- Rinse eyes thoroughly with water and consult a doctor immediately if coolant gets into the eyes.
- Change clothing if coolant spills onto your clothing.

# 16 COOLING SYSTEM

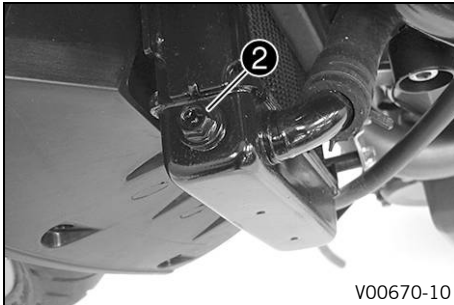
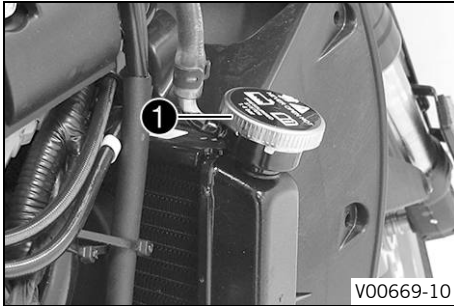

## Main work

- Remove radiator cap ❶.

- Loosen bleeder screw ❷.

### Guideline

3 turns

- Tilt the vehicle slightly to the right.
- Pour in coolant until it emerges without bubbles at the bleeder screw, and then mount and tighten the bleeder screw immediately.

Coolant (📖 p. 238)

- Completely fill the radiator with coolant. Mount the radiator cap.
- Rest the vehicle on the side stand.



## Danger

**Danger of poisoning** Exhaust gases are toxic and inhaling them may result in unconsciousness and death.

- Always make sure there is sufficient ventilation when running the engine.
- Use effective exhaust extraction when starting or running the engine in an enclosed space.

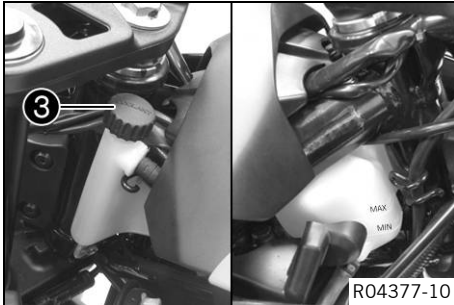

- Start the engine and let it warm up.
- Stop the engine and allow it to cool down.
- When the engine is cool, check the coolant level in the radiator and, if necessary, add coolant.
- Remove cap ③ of the compensating tank and top up the coolant level up to the **MAX** marking.
- Mount the cap of the compensating tank.

## Finishing work

- Fit the front spoiler. (📖 p. 122)
- Install the left side cover. 🛠️ (📖 p. 125)
- Install the right side cover. 🛠️ (📖 p. 128)



## 16.7 Changing the coolant



### Warning

**Danger of scalding** During motorcycle operation, the coolant gets very hot and is under pressure.

- Do not open the radiator, the radiator hoses or other cooling system components if the engine or the cooling system are at operating temperature.
- Allow the cooling system and the engine to cool down before you open the radiator, the radiator hoses or other components of the cooling system.
- In the event of scalding, rinse the area affected immediately with lukewarm water.



### Warning

**Danger of poisoning** Coolant is toxic and a health hazard.

- Keep coolant out of the reach of children.
- Do not allow coolant to come into contact with the skin, the eyes and clothing.
- Consult a doctor immediately if coolant is swallowed.
- Rinse the affected area immediately with plenty of water in the event of contact with the skin.
- Rinse eyes thoroughly with water and consult a doctor immediately if coolant gets into the eyes.
- Change clothing if coolant spills onto your clothing.

### Condition

The engine is cold.

### Preparatory work

- Remove the right side cover.   p. 127)

- Remove the left side cover. (🔧 p. 124)
- Remove the front spoiler. (🔧 p. 121)

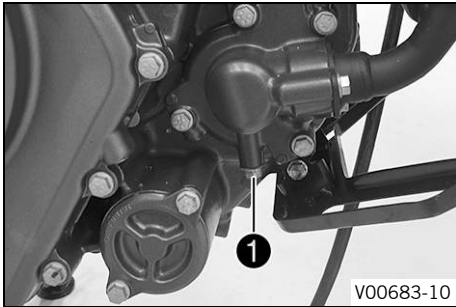

### Main work

- Position the motorcycle upright.
- Position an appropriate container under the engine.
- Remove screw **1**.

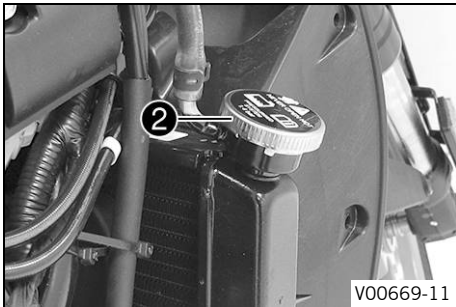

- Remove radiator cap **2**.
- Completely drain the coolant.
- Mount and tighten screw **1** with a new seal ring.

### Guideline

Screw plug, water pump drain hole	M6	10 Nm (7.4 lbf ft)
-----------------------------------	----	--------------------

# 16 COOLING SYSTEM

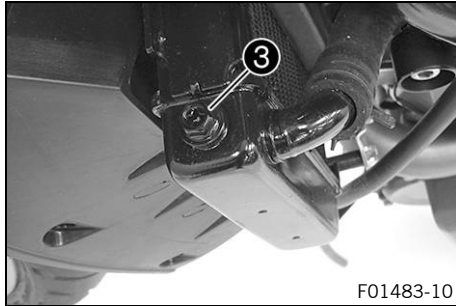

- Loosen bleeder screw ③.

Guideline

3 turns

- Tilt the vehicle slightly to the right.
- Pour in the coolant until it emerges without bubbles at the bleeder screw, and then mount and tighten the bleeder screw immediately.

Coolant (📖 p. 238)

- Completely fill the radiator with coolant. Mount the radiator cap.
- Rest the vehicle on the side stand.



## Danger

**Danger of poisoning** Exhaust gases are toxic and inhaling them may result in unconsciousness and death.

- Always make sure there is sufficient ventilation when running the engine.
  - Use effective exhaust extraction when starting or running the engine in an enclosed space.
- 
- Start the engine and allow it to warm up.



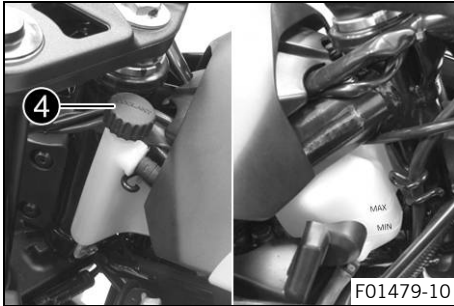

- Stop the engine and allow it to cool down.
- When the engine is cool, check the coolant level in the radiator and, if necessary, add coolant.
- Remove cap ④ of the compensating tank and top up the coolant level up to the **MAX** marking.
- Mount the cap of the compensating tank.

### Finishing work

- Fit the front spoiler. (📖 p. 122)
- Install the left side cover. 🛠️ (📖 p. 125)
- Install the right side cover. 🛠️ (📖 p. 128)



## 17.1 Checking throttle cable play

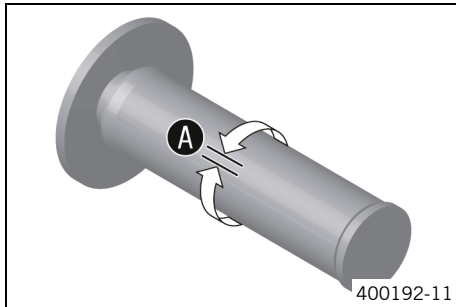

- Check the throttle grip for smooth operation.
- Move the handlebar to the straight-ahead position. Turn the throttle grip back and forth slightly and determine the play in throttle cable **A**.

Throttle cable play <b>A</b>	3 ... 5 mm (0.12 ... 0.2 in)
------------------------------	------------------------------

- » If the throttle cable play does not meet specifications:
  - Adjust the throttle cable play. 🛠️ (p. 201)



### Danger

**Danger of poisoning** Exhaust gases are toxic and inhaling them may result in unconsciousness and death.

- Always make sure there is sufficient ventilation when running the engine.
- Use effective exhaust extraction when starting or running the engine in an enclosed space.

- Start the engine and let it run at idle speed. Move the handlebar to and fro over the entire steering range.

The idle speed must not change.
---------------------------------

- » If the idle speed changes:
  - Check the throttle cable routing.

## 17.2 Adjusting throttle cable play ↗

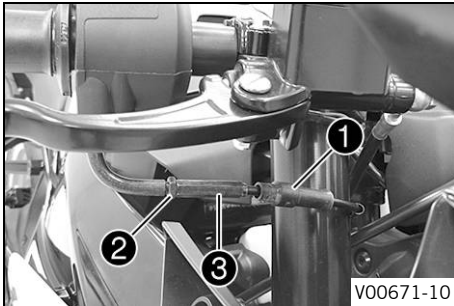

- Move the handlebar to the straight-ahead position.
- Push back sleeve ❶.
- Loosen lock nut ❷.
- Adjust the throttle cable play with barrel adjuster ❸.

Guideline

Throttle cable play	3 ... 5 mm (0.12 ... 0.2 in)
---------------------	------------------------------

- Tighten lock nut ❷.
- Slide on sleeve ❶.



## 17.3 Checking the clutch lever play

### Note

**Clutch damage** If there is no free travel by the clutch lever, the clutch will begin to slip.

- Check the free travel of the clutch lever each time before using the motorcycle.
- Adjust the free travel of the clutch lever when necessary in accordance with the specification.

# 17 TUNING THE ENGINE

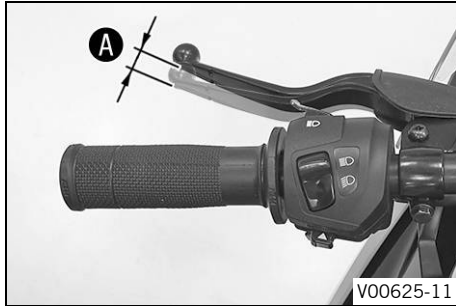

- Check the clutch lever for smooth operation.
- Move the handlebar to the straight-ahead position.
- Pull the clutch lever until resistance is perceptible, and determine the play in the clutch lever **A**.

Clutch lever play <b>A</b>	1 ... 3 mm (0.04 ... 0.12 in)
----------------------------	-------------------------------

- » If the clutch lever play does not meet the specified value:
  - Adjust play in the clutch lever. 🛠️ (📖 p. 203)
- Move the handlebar to and fro over the entire steering range.

The clutch lever play must not change.

- » If the clutch lever play changes:
  - Check the routing of the clutch cable.

## 17.4 Adjusting play in the clutch lever ↩

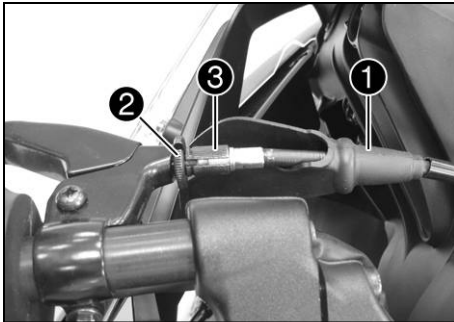

- Move the handlebar to the straight-ahead position.
- Push back sleeve ①.
- Loosen lock nut ②.
- Adjust the play in the clutch level A by turning adjusting screw ③.

### Guideline

Clutch lever play A	1 ... 3 mm (0.04 ... 0.12 in)
---------------------	-------------------------------

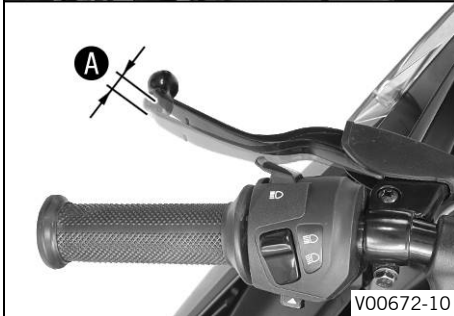

- Tighten lock nut ②.
- Position bellows ①.



V00672-10

## 18.1 Checking the engine oil level

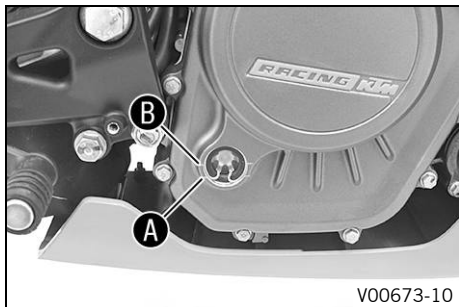

### Condition

The engine is at operating temperature.

### Preparatory work

- Stand the motorcycle upright on a horizontal surface.

### Main work

- Check the engine oil level.

### Info

After switching off the engine, wait one minute before checking the level.

The engine oil must be between the **A** and **B** markings .

- » When the engine oil level is below the **A** marking:
  - Add engine oil. (📖 p. 208)
- » When the engine oil level is above the **B** marking:
  - Correct the engine oil level.

## 18.2 Changing the engine oil and oil filter, cleaning the oil screen ↩



### Warning

**Danger of scalding** Engine and gear oil get very hot when the motorcycle is ridden.

- Wear suitable protective clothing and safety gloves.
- In the event of scalding, rinse the area affected immediately with lukewarm water.



### Note

**Environmental hazard** Hazardous substances cause environmental damage.

- Dispose of oils, grease, filters, fuel, cleaning agents, brake fluid, etc., correctly and in compliance with the applicable regulations.



### Info

Drain the engine oil while the engine is at operating temperature.

### Preparatory work

- Remove the front spoiler. (📖 p. 121)
- Place the motorcycle on a horizontal surface using the side stand.

# 18 SERVICE WORK ON THE ENGINE

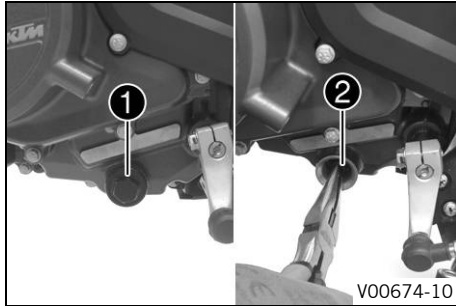

## Main work

- Position an appropriate container under the engine.
- Remove oil drain plug **1** with the O-ring.
- Remove oil screen **2** with the O-ring.
- Allow the engine oil to drain completely.
- Clean the oil drain plug and the oil screen thoroughly.
- Position oil screen **2** and mount and tighten oil drain plug **1** with the O-ring.

## Guideline

Oil drain plug	M24x1.5	15 Nm (11.1 lbf ft)
----------------	---------	---------------------

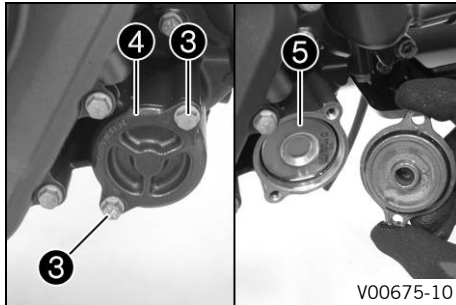

- Remove screws **3**. Take off oil filter cover **4** with the O-ring.
- Pull oil filter **5** out of the oil filter housing.
- Allow the engine oil to drain completely.
- Thoroughly clean the parts and the sealing surface.



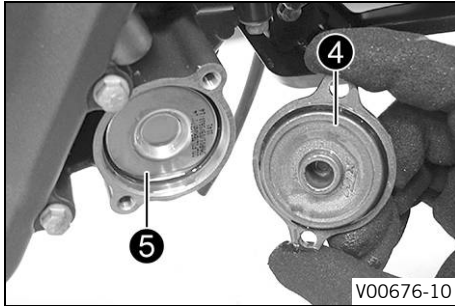

- Insert new oil filter **5**.
- Oil the O-ring of the oil filter cover. Mount oil filter cover **4**.
- Mount and tighten screws **3**.

#### Guideline

Screw, oil filter cover	M6	10 Nm (7.4 lbf ft)
-------------------------	----	--------------------



#### Info

Too little engine oil or poor-quality engine oil will result in premature wear of the engine.

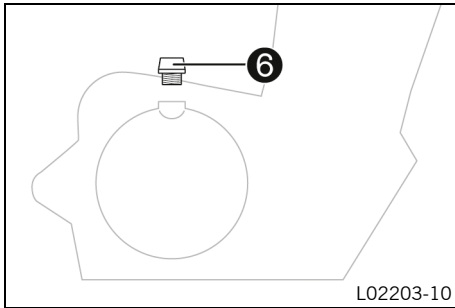

- Remove filler plug **6** from the clutch cover together with the O-ring, and fill up with engine oil.

Engine oil Ambient temperature: 0 ... 50 °C (32 ... 122 °F)	1.5 l (1.6 qt.)	Engine oil (SAE 15W/50) (🔧 p. 239)
Engine oil Ambient temperature: -10 ... 40 °C (14 ... 104 °F)		Engine oil (SAE 10W/40) (🔧 p. 240)

- Mount and tighten the filler plug together with the O-ring.



## **Danger**

**Danger of poisoning** Exhaust gases are toxic and inhaling them may result in unconsciousness and death.

- Always make sure there is sufficient ventilation when running the engine.
- Use effective exhaust extraction when starting or running the engine in an enclosed space.

- Start the engine and check for tightness.

## **Finishing work**

- Fit the front spoiler. (📖 p. 122)
- Check the engine oil level. (📖 p. 204)

## **18.3 Adding engine oil**



### **Info**

Too little engine oil or poor-quality engine oil will result in premature wear of the engine.

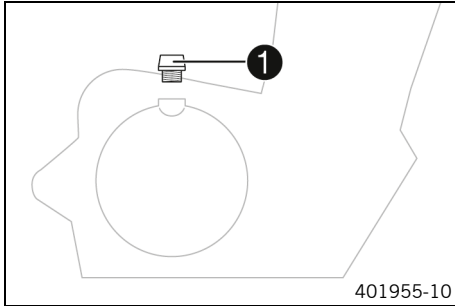

## Main work

- Remove filler plug ❶ with the O-ring, and fill up with engine oil.

Engine oil (SAE 15W/50) (📖 p. 239)
------------------------------------

Engine oil (SAE 10W/40) (📖 p. 240)
------------------------------------



## Info

For optimal performance of the engine oil, do not mix different types of engine oil.  
We recommend changing the engine oil when necessary.

- Mount and tighten the filler plug together with the O-ring.



## Danger

**Danger of poisoning** Exhaust gases are toxic and inhaling them may result in unconsciousness and death.

- Always make sure there is sufficient ventilation when running the engine.
- Use effective exhaust extraction when starting or running the engine in an enclosed space.

- Start the engine and check that it is oil-tight.

# 18 SERVICE WORK ON THE ENGINE

## Finishing work

- Check the engine oil level. (📖 p. 204)



## 19.1 Cleaning the motorcycle

---

### Note

**Material damage** Components become damaged or destroyed if a pressure cleaner is used incorrectly.

The high pressure forces water into the electrical components, connectors, throttle cables, and bearings, etc. Pressure which is too high causes malfunctions and destroys components.

- Do not direct the water jet directly on to electrical components, connectors, throttle cables or bearings.
- Maintain a minimum distance between the nozzle of the pressure cleaner and the component.

Minimum clearance 60 cm (23.6 in)



### Note

**Environmental hazard** Hazardous substances cause environmental damage.

- Dispose of oils, grease, filters, fuel, cleaning agents, brake fluid, etc., correctly and in compliance with the applicable regulations.
- 



### Info

Clean the motorcycle regularly to maintain its value and appearance over a long period.  
Avoid direct sunshine when cleaning the motorcycle.

---

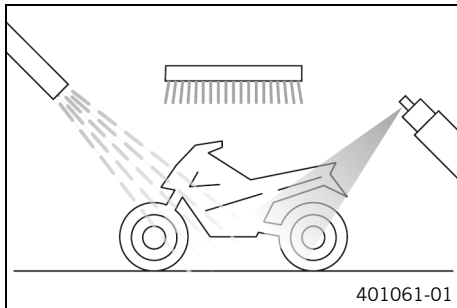

- Close off the exhaust system to keep water from entering.
- Remove loose dirt first with a soft jet of water.
- Spray heavily soiled parts with a normal commercial motorcycle cleaner and then brush off with a soft brush.

Motorcycle cleaner (📖 p. 242)



### Info

Use warm water containing normal motorcycle cleaner and a soft sponge.

Never apply motorcycle cleaner to a dry motorcycle; always rinse the vehicle with water first.

Clean the motorcycle with cold water if it has been used on salted roads. Warm water enhances the corrosive effects of salt.

- After rinsing the motorcycle with a gentle spray of water, allow it to dry thoroughly.
- Remove the closure of the exhaust system.



### Warning

**Danger of accidents** Moisture and dirt impair the brake system.

- Brake carefully several times to dry out and remove dirt from the brake linings and the brake discs.

- After cleaning, ride the vehicle a short distance until the engine warms up.



### Info

The heat produced causes water at inaccessible locations in the engine and on the brake system to evaporate.

- 
- Push back the sleeves of the handlebar controls to allow any water that has penetrated to evaporate.
  - After the motorcycle has cooled down, lubricate all moving parts and pivot points.
  - Clean the chain. (📖 p. 110)
  - Treat bare metal (except for brake discs and the exhaust system) with a corrosion inhibitor.

Preserving materials for paints, metal and rubber  
(📖 p. 243)

- Treat all painted parts with a mild paint care product.

Perfect finish and high gloss polish for paints (📖 p. 242)



### Info

Do not polish parts that were matte when delivered as this would strongly impair the material quality.

---

- Treat all plastic parts and powder-coated parts with a mild cleaning and care product.

Special cleaner for glossy and matte paint finishes, metal and plastic surfaces (📖 p. 243)

- Lubricate the ignition and steering lock.

Universal oil spray (📖 p. 243)

## 19.2 Checks and maintenance steps for winter operation

### **i** Info

If you use the motorcycle in winter, you must expect salt on the roads. You should therefore take precautions against aggressive road salt. Clean the motorcycle with cold water if it has been used on salted roads. Warm water enhances the corrosive effects of salt.



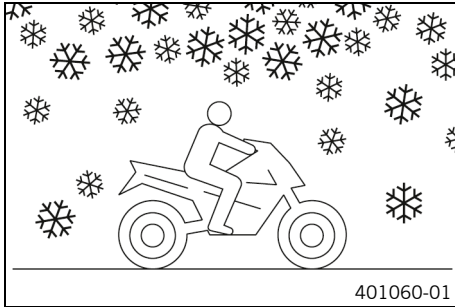

- Clean the motorcycle. (📖 p. 211)
- Clean the brakes.



### Info

After **EVERY** trip on salted roads, thoroughly clean the motorcycle and, in particular, the brake calipers and brake linings, after they have cooled down and without removing them, with cold water and dry carefully.

- Treat the engine, the link fork, and all other bare or zinc-plated parts (except the brake discs) with a wax-based corrosion inhibitor.



### Info

Corrosion inhibitor must not come in contact with the brake discs as this would greatly reduce the braking force.

- Clean the chain. (📖 p. 110)



## 20.1 Storage

### **i** Info

If you plan to garage the motorcycle for a longer period, perform the following steps or have them performed.

Before storing the motorcycle, check all parts for function and wear. If service, repairs, or replacements are necessary, you should do this during the storage period (less workshop overload). In this way, you can avoid long workshop waiting times at the start of the new season.

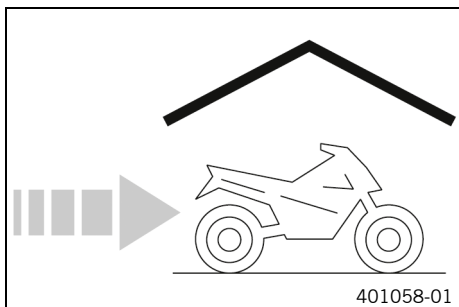

- When refueling for the last time before taking the motorcycle out of service, add fuel additive.

Fuel additive (📖 p. 242)

- Refuel. (📖 p. 90)
- Clean the motorcycle. (📖 p. 211)
- Change the engine oil and oil filter, clean the oil screen. 🛠️ (📖 p. 205)
- Check the antifreeze and coolant level. (📖 p. 187)
- Check tire pressure. (📖 p. 159)
- Remove the 12-V battery. 🛠️ (📖 p. 161)
- Charge the 12-V battery. 🛠️ (📖 p. 164)

## Guideline

Storage temperature of the 12-V battery without direct sunlight	0 ... 35 °C (32 ... 95 °F)
---	----------------------------

- Store vehicle in a dry location that is not subject to large fluctuations in temperature.

**Info**

KTM recommends jacking up the motorcycle.

- Raise the motorcycle with the rear lifting gear. (📖 p. 100)
- Lift the motorcycle with the front lifting gear. (📖 p. 101)
- Cover the motorcycle with a tarp or cover that is permeable to air.

**Info**

Do not use non-porous materials since they prevent humidity from escaping, thus causing corrosion. Avoid running the engine for a short time only. Since the engine cannot warm up properly, the water vapor produced during combustion condenses and causes valves and the exhaust system to rust.



## 20.2 Preparing for use after storage

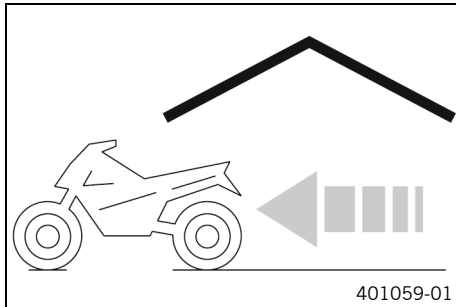

- Take the motorcycle off the front lifting gear. (📖 p. 103)
- Remove the rear of the motorcycle from the lifting gear. (📖 p. 100)
- Install the 12-V battery. 🔧 (📖 p. 163)
- Set the clock. (📖 p. 68)
- Perform checks and maintenance measures when preparing for use. (📖 p. 77)
- Take a test ride.

Faults	Possible cause	Action
The engine does not turn when the start button is pressed	Operating error	– Carry out start procedure. (📖 p. 78)
	12-V battery discharged	– Charge the 12-V battery. 🛠️ (📖 p. 164)
	Fuse <b>1</b> , <b>3</b> , <b>4</b> , or <b>7</b> is blown	– Change the fuses of individual power consumers. (📖 p. 170)
	No ground connection present	– Check the ground connection.
Engine turns only if the clutch lever is drawn	The vehicle is in gear	– Shift the transmission to neutral position.
	The vehicle is in gear and the side stand is folded out	– Shift the transmission to neutral position.
Engine turns but does not start	Operating error	– Carry out start procedure. (📖 p. 78)
	Malfunction in the electronic fuel injection	– Read out the fault memory using the KTM diagnostics tool. 🛠️
Engine has too little power	Air filter is very dirty	– Change the air filter.
	Fuel filter is very dirty	– Check the fuel pressure. 🛠️
	Malfunction in the electronic fuel injection	– Read out the fault memory using the KTM diagnostics tool. 🛠️
Engine overheats	Too little coolant in cooling system	– Check the cooling system for leakage. – Check the coolant level in the compensating tank. (📖 p. 185)
	Radiator fins very dirty	– Clean the radiator fins.

Faults	Possible cause	Action
Engine overheats	Foam formation in cooling system	<ul style="list-style-type: none"> <li>– Drain the coolant. 🛠️ (📖 p. 191)</li> <li>– Fill/bleed the cooling system. 🛠️ (📖 p. 193)</li> </ul>
	Thermostat defective	<ul style="list-style-type: none"> <li>– Check the thermostat. 🛠️</li> </ul>
	Fuse <b>5</b> blown	<ul style="list-style-type: none"> <li>– Change the fuses of individual power consumers. (📖 p. 170)</li> </ul>
	Defect in radiator fan system	<ul style="list-style-type: none"> <li>– Check the radiator fan system. 🛠️</li> </ul>
Malfunction indicator lamp lights up yellow	Malfunction in the electronic fuel injection	<ul style="list-style-type: none"> <li>– Read out the fault memory using the KTM diagnostics tool. 🛠️</li> </ul>
Engine dies during the trip	Lack of fuel	<ul style="list-style-type: none"> <li>– Refuel. (📖 p. 90)</li> </ul>
	Fuse <b>1, 3, 4,</b> or <b>7</b> is blown	<ul style="list-style-type: none"> <li>– Change the fuses of individual power consumers. (📖 p. 170)</li> </ul>
The ABS warning lamp lights up	ABS fuse blown	<ul style="list-style-type: none"> <li>– Change the ABS fuses. (📖 p. 167)</li> </ul>
	Large difference in wheel speeds of the front and rear wheels	<ul style="list-style-type: none"> <li>– Stop the vehicle, switch off the ignition, and start it again.</li> </ul>
	Malfunction in ABS	<ul style="list-style-type: none"> <li>– Read out the fault memory using the KTM diagnostics tool. 🛠️</li> </ul>
High oil consumption	Engine vent hose bent	<ul style="list-style-type: none"> <li>– Route the vent hose without bends or change it if necessary.</li> </ul>
	Engine oil level too high	<ul style="list-style-type: none"> <li>– Check the engine oil level. (📖 p. 204)</li> </ul>

Faults	Possible cause	Action
High oil consumption	Engine oil too thin (low viscosity)	– Change the engine oil and oil filter, clean the oil screen. 🛠️ (📖 p. 205)
Headlight and position light are not functioning	Fuse <b>6</b> blown	– Change the fuses of individual power consumers. (📖 p. 170)
Turn signal, brake light, and horn are not functional	Fuse <b>6</b> blown	– Change the fuses of individual power consumers. (📖 p. 170)
Time is not (correctly) displayed	Fuse <b>7</b> is blown	– Change the fuses of individual power consumers. (📖 p. 170) – Set the clock. (📖 p. 68)
12 V battery discharged	Ignition was not switched off when vehicle was parked	– Charge the 12-V battery. 🛠️ (📖 p. 164)
	The 12-V battery is not being charged by the alternator	– Check the charging voltage. 🛠️ – Check the open-circuit current. 🛠️
The combination instrument shows nothing on the display	Fuse <b>7</b> is blown	– Change the fuses of individual power consumers. (📖 p. 170) – Set the clock. (📖 p. 68)
Speedometer in combination instrument not functioning	Speedometer wiring harness is damaged or plug-in connector is oxidized	– Check the wiring harness and plug-in connector.

## 22.1 Engine

Design	1-cylinder 4-stroke engine, water-cooled
Displacement	125 cm <sup>3</sup> (7.63 cu in)
Stroke	47.2 mm (1.858 in)
Bore	58 mm (2.28 in)
Compression ratio	12.8:1
Control	DOHC, 4 valves controlled via cam lever, chain drive
Valve diameter, intake	22.5 mm (0.886 in)
Valve diameter, exhaust	19 mm (0.75 in)
Valve clearance, intake, cold	0.08 ... 0.12 mm (0.0031 ... 0.0047 in)
Valve clearance, exhaust, cold	0.13 ... 0.17 mm (0.0051 ... 0.0067 in)
Crankshaft bearing	Two ball bearings
Conrod bearing	Sleeve bearing
Pistons	Cast light alloy
Piston rings	1 compression ring, 1 tapered compression piston ring, 1 oil scraper ring
Engine lubrication	Pressure circulation lubrication with 1 trochoidal pump
Primary transmission	22:72
Clutch	Clutch in oil bath/mechanically activated
Transmission	6-gear transmission, claw shifted



Transmission ratio	
1st gear	12:34
2nd gear	15:31
3rd gear	18:28
4th gear	21:26
5th gear	22:23
6th gear	24:22
Mixture preparation	Electronic fuel injection
Ignition	Contactless controlled fully electronic ignition with digital ignition adjustment
Alternator	12 V, 296 W
Spark plug	<b>BOSCHVR5NEU</b>
Spark plug electrode gap	1 mm (0.04 in)
Cooling	Water cooling, permanent circulation of coolant by water pump
Idle speed	1,450 ... 1,550 rpm
Starting aid	Starter motor

## 22.2 Engine tightening torques

Oil nozzle	M5	6 Nm (4.4 lbf ft)	<b>Loctite®243™</b>
------------	----	-------------------	---------------------

## 22 TECHNICAL DATA

Screw, engine vent plate	M5	7 Nm (5.2 lbf ft)	<b>Loctite®243™</b>
Screw, retaining bracket	M5	6 Nm (4.4 lbf ft)	<b>Loctite®243™</b>
Screw, retaining bracket, stator cable	M5	8 Nm (5.9 lbf ft)	<b>Loctite®243™</b>
Screw, stator	M5	8 Nm (5.9 lbf ft)	<b>Loctite®243™</b>
Cylinder head screw	M6	12 Nm (8.9 lbf ft)	
Nut, water pump impeller	M6	10 Nm (7.4 lbf ft)	<b>Loctite®243™</b>
Screw plug, water pump drain hole	M6	10 Nm (7.4 lbf ft)	
Screw, alternator cover	M6	12 Nm (8.9 lbf ft)	
Screw, bearing retainer	M6	12 Nm (8.9 lbf ft)	<b>Loctite®243™</b>
Screw, camshaft bearing bridge	M6	10 Nm (7.4 lbf ft)	
Screw, chain securing guide	M6	10 Nm (7.4 lbf ft)	<b>Loctite®243™</b>
Screw, clutch cover	M6	12 Nm (8.9 lbf ft)	
Screw, engine case	M6x40	12 Nm (8.9 lbf ft)	
Screw, engine case	M6x60	12 Nm (8.9 lbf ft)	<b>Loctite®243™</b>

Screw, freewheel gear retaining bracket	M6	12 Nm (8.9 lbf ft)	<b>Loctite®243™</b>
Screw, locking lever	M6	12 Nm (8.9 lbf ft)	<b>Loctite®243™</b>
Screw, oil filter cover	M6	10 Nm (7.4 lbf ft)	
Screw, oil pump	M6	12 Nm (8.9 lbf ft)	<b>Loctite®243™</b>
Screw, retaining bracket	M6	12 Nm (8.9 lbf ft)	<b>Loctite®243™</b>
Screw, retaining bracket, radial shaft seal ring, clutch cover	M6	12 Nm (8.9 lbf ft)	<b>Loctite®243™</b>
Screw, shift drum locating	M6	12 Nm (8.9 lbf ft)	<b>Loctite®243™</b>
Screw, starter motor	M6	12 Nm (8.9 lbf ft)	
Screw, timing chain tensioner	M6	12 Nm (8.9 lbf ft)	
Screw, timing chain tensioning rail	M6	12 Nm (8.9 lbf ft)	<b>Loctite®243™</b>
Screw, valve cover	M6	12 Nm (8.9 lbf ft)	
Screw, water pump cover	M6	12 Nm (8.9 lbf ft)	
Nut, conrod bearing	M7	24 Nm (17.7 lbf ft)	
Nut, exhaust flange	M8	8 Nm (5.9 lbf ft)	
Screw, balancer shaftgear wheel	M8	40 Nm (29.5 lbf ft)	<b>Loctite®243™</b>

## 22 TECHNICAL DATA

Screw, camshaft gear wheel	M8	32 Nm (23.6 lbf ft) <b>Loctite®243™</b>
Screw, return spring, quick shifter	M8	20 Nm (14.8 lbf ft) <b>Loctite®243™</b>
Stud, exhaust flange	M8	22 Nm (16.2 lbf ft)
Coolant temperature sensor	M10	14 Nm (10.3 lbf ft)
Cylinder head screw	M10	Step 1 25 Nm (18.4 lbf ft) Step 2 50 Nm (36.9 lbf ft) Thread is oiled, head flat is greased
Oil pressure sensor	M10	14 Nm (10.3 lbf ft)
Rotor screw	M10	70 Nm (51.6 lbf ft) <b>Loctite®243™</b>
Screw plug, cam lever axis	M10x1	10 Nm (7.4 lbf ft)
Spark plug	M12	15 Nm (11.1 lbf ft)
Nut, inner clutch hub	M14LH	60 Nm (44.3 lbf ft) <b>Loctite®243™</b>
Nut, primary gear wheel/timing chain sprocket	M14	55 Nm (40.6 lbf ft) <b>Loctite®243™</b>
Oil drain plug	M24x1.5	15 Nm (11.1 lbf ft)

## 22.3 Capacities

### 22.3.1 Engine oil

Engine oil Ambient temperature: 0 ... 50 °C (32 ... 122 °F)	1.5 l (1.6 qt.)	Engine oil (SAE 15W/50) (📖 p. 239)
Engine oil Ambient temperature: -10 ... 40 °C (14 ... 104 °F)		Engine oil (SAE 10W/40) (📖 p. 240)

### 22.3.2 Coolant

Coolant	1 l (1 qt.)	Coolant (📖 p. 238)
---------	-------------	--------------------

### 22.3.3 Fuel

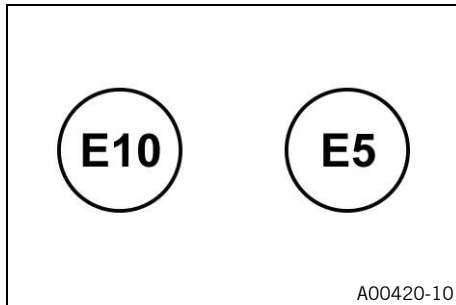

Please observe the labels on EU fuel pumps.

Total fuel tank capacity, approx.	10 l (2.6 US gal)	Super unleaded (ROZ 95/RON 95/PON 91) (📖 p. 240)
-----------------------------------	-------------------	--

Fuel reserve, approx.	1.5 l (1.6 qt.)
-----------------------	-----------------

## 22.4 Chassis

Frame	Lattice frame of steel tubes, powder-coated
Fork	<b>WP Suspension</b>
Shock absorber	<b>WP Suspension</b>
Brake system	
front	Disc brake with 4-piston brake caliper
rear	Disc brake with single-pot brake caliper, floating
Suspension travel	
front	125 mm (4.92 in)
rear	150 mm (5.91 in)
Brake discs - diameter	
front	300 mm (11.81 in)
rear	230 mm (9.06 in)
Brake discs - wear limit	
front	4.5 mm (0.177 in)
rear	3.6 mm (0.142 in)
Tire pressure when solo	

front	2.0 bar (29 psi)
rear	2.0 bar (29 psi)
Tire pressure with passenger / full payload	
front	2.0 bar (29 psi)
rear	2.2 bar (32 psi)
Secondary ratio	
Chain	5/8 x 1/4" (520) O-ring
Steering head angle	66.5°
Wheelbase	1,340 ± 15 mm (52.76 ± 0.59 in)
Seat height, unloaded	820 mm (32.28 in)
Ground clearance, unloaded	148 mm (5.83 in)
Dry weight	135 kg (298 lb.)
Maximum permissible front axle load	125 kg (276 lb.)
Maximum permissible rear axle load	210 kg (463 lb.)
Maximum permissible overall weight	335 kg (739 lb.)

## 22.5 Electrical system

12-V battery	ETZ-9-BS	Battery voltage: 12 V Nominal capacity: 8 Ah Maintenance-free
Fuse	75011088010	10 A

## 22 TECHNICAL DATA

Fuse	75011088015	15 A
Fuse	90111088025	25 A
Fuse	75011088030	30 A
Low beam	H11/socket PGJ19-2	12 V 55 W
High beam	H9/socket PGJ19-5	12 V 65 W
Position light	LED	
Combination instrument lighting and indicator lamps	LED	
Turn signal	LED	
Brake/tail light	LED	
License plate lamp	LED	

### 22.6 Tires

Front tire	Rear tire
<b>110/70 R 17 M/C 54H TL</b> Michelin Pilot Street Radial	<b>150/60 R 17 M/C 66H TL</b> Michelin Pilot Street Radial
The tires specified represent one of the possible series production tires. Additional information is available in the Service section under: <a href="http://www.ktm.com">http://www.ktm.com</a>	



## 22.7 Fork

Fork article number	93501001200	
Fork	<b>WP Suspension</b>	
Fork length	736 mm (28.98 in)	
Fork oil	460 ml (15.55 fl. oz.)	Fork oil (SAE 4) (48601166S1) (  p. 240)

## 22.8 Shock absorber

Shock absorber article number	90504010100	
Shock absorber	<b>WP Suspension</b>	
Spring preload		
Standard	5 clicks	
Static sag	15 mm (0.59 in)	
Riding sag	45 ... 50 mm (1.77 ... 1.97 in)	
Fitted length	300 mm (11.81 in)	

## 22.9 Chassis tightening torques

Screw, chain guard	<b>EJOT PT®</b> K60x30	4 Nm (3 lbf ft)
Remaining screws, chassis	M4	4 Nm (3 lbf ft)

## 22 TECHNICAL DATA

Screw, engine electronics control unit	M4	3 Nm (2.2 lbf ft)	
Nut, chain guard	M5	7 Nm (5.2 lbf ft)	
Nut, reflector on retaining plate	M5	5 Nm (3.7 lbf ft)	
Remaining nuts, chassis	M5	5 Nm (3.7 lbf ft)	
Remaining screws, chassis	M5	5 Nm (3.7 lbf ft)	
Screw, anti-rotation lock, handle-bar stub	M5	4 Nm (3 lbf ft)	
Screw, battery compartment	M5	4 Nm (3 lbf ft)	
Screw, cover in front of battery compartment	M5	4 Nm (3 lbf ft)	
Screw, fuel tank cover	M5	4 Nm (3 lbf ft)	
Screw, retaining plate on license plate holder	M5	4 Nm (3 lbf ft)	
Screw, side stand sensor	M5	5 Nm (3.7 lbf ft)	<b>Loctite®243™</b>
Screw, tail end lower part	M5	4 Nm (3 lbf ft)	
ABS fitting	M6	7 Nm (5.2 lbf ft)	<b>Loctite®243™</b>
Battery compartment cover lock	M6	6 Nm (4.4 lbf ft)	
Nut, license plate holder	M6	7 Nm (5.2 lbf ft)	
Nut, radiator	M6	5 Nm (3.7 lbf ft)	
Nut, tail light	M6	7 Nm (5.2 lbf ft)	

Remaining nuts, chassis	M6	15 Nm (11.1 lbf ft)
Remaining screws, chassis	M6	9 Nm (6.6 lbf ft)
Screw, air filter box cover	M6	6 Nm (4.4 lbf ft)
Screw, air filter box, on frame	M6	6 Nm (4.4 lbf ft)
Screw, battery compartment	M6	6 Nm (4.4 lbf ft)
Screw, brake fluid reservoir, rear brake	M6	8 Nm (5.9 lbf ft)
Screw, brake hose clamp	M6	6 Nm (4.4 lbf ft)
Screw, brake line guide on bottom triple clamp	M6	7 Nm (5.2 lbf ft) <b>Loctite®243™</b>
Screw, chain guard	M6	6 Nm (4.4 lbf ft)
Screw, chain sliding guard	M6	7 Nm (5.2 lbf ft)
Screw, compensating tank	M6	8 Nm (5.9 lbf ft)
Screw, damping rubber for radiator	M6	6 Nm (4.4 lbf ft)
Screw, engine electronics control unit retaining bracket	M6	6 Nm (4.4 lbf ft)
Screw, engine sprocket cover on frame	M6	8 Nm (5.9 lbf ft)
Screw, footrest bracket	M6	7 Nm (5.2 lbf ft)
Screw, front fairing structure on headlight bracket	M6	7 Nm (5.2 lbf ft)
Screw, front fender on axle clamp	M6	7 Nm (5.2 lbf ft)

## 22 TECHNICAL DATA

Screw, front mask	M6	7 Nm (5.2 lbf ft)	
Screw, front seat fixing	M6	6 Nm (4.4 lbf ft)	
Screw, front spoiler	M6	7 Nm (5.2 lbf ft)	
Screw, front spoiler bottom front	M6	6 Nm (4.4 lbf ft)	
Screw, front spoiler rear	M6	6 Nm (4.4 lbf ft)	
Screw, fuel tank trim	M6	6 Nm (4.4 lbf ft)	
Screw, ground cable, on frame	M6	7 Nm (5.2 lbf ft)	
Screw, handlebar stub	M6	8 Nm (5.9 lbf ft)	<b>Loctite®243™</b>
Screw, license plate holder on license plate bracket	M6	7 Nm (5.2 lbf ft)	
Screw, magnetic holder on side stand	M6	5 Nm (3.7 lbf ft)	<b>Loctite®243™</b>
Screw, passenger seat	M6	7 Nm (5.2 lbf ft)	
Screw, protective plate	M6	8 Nm (5.9 lbf ft)	
Screw, radiator shield	M6	6 Nm (4.4 lbf ft)	
Screw, rear fender	M6	7 Nm (5.2 lbf ft)	
Screw, rear wheel speed sensor wheel	M6	8 Nm (5.9 lbf ft)	<b>Loctite® 204™</b>
Screw, side cover	M6	6 Nm (4.4 lbf ft)	
Screw, side cover on front mask	M6	6 Nm (4.4 lbf ft)	
Screw, side cover retaining bracket	M6	7 Nm (5.2 lbf ft)	

Screw, tilt sensor	M6	7 Nm (5.2 lbf ft)	<b>Loctite®243™</b>
Screw, wheel speed sensor holder	M6	8 Nm (5.9 lbf ft)	
Screw, windshield	M6	7 Nm (5.2 lbf ft)	
Exhaust clamp	M8	20 Nm (14.8 lbf ft)	
Remaining nuts, chassis	M8	30 Nm (22.1 lbf ft)	
Remaining screws, chassis	M8	25 Nm (18.4 lbf ft)	
Screw, bottom triple clamp	M8	12 Nm (8.9 lbf ft)	
Screw, chain guard	M8	11 Nm (8.1 lbf ft)	
Screw, foot brake lever	M8	17 Nm (12.5 lbf ft)	<b>Loctite®243™</b>
Screw, front brake disc	M8	32 Nm (23.6 lbf ft)	<b>Loctite®243™</b>
Screw, front wheel spindle	M8	26 Nm (19.2 lbf ft)	
Screw, fuel tank attachment, rear, on frame	M8	17 Nm (12.5 lbf ft)	
Screw, horn	M8	9 Nm (6.6 lbf ft)	
Screw, main silencer	M8	18 Nm (13.3 lbf ft)	
Screw, passenger footrest unit	M8	20 Nm (14.8 lbf ft)	<b>Loctite®243™</b>
Screw, presilencer on frame	M8	24 Nm (17.7 lbf ft)	
Screw, rear brake disc	M8	21 Nm (15.5 lbf ft)	<b>Loctite®243™</b>

## 22 TECHNICAL DATA

Screw, retaining bracket on fuel tank	M8	13 Nm (9.6 lbf ft)
Screw, shift lever	M8	17 Nm (12.5 lbf ft) <b>Loctite®243™</b>
Screw, top triple clamp	M8	15 Nm (11.1 lbf ft)
Screw, front brake caliper	M8x1	30 Nm (22.1 lbf ft) <b>Loctite® 204™</b>
Nut, rear sprocket screw	M8x1.25	27 Nm (19.9 lbf ft) <b>Loctite®243™</b>
Fitting side stand	M10	35 Nm (25.8 lbf ft) <b>Loctite®243™</b>
Remaining nuts, chassis	M10	50 Nm (36.9 lbf ft)
Remaining screws, chassis	M10	45 Nm (33.2 lbf ft)
Screw, side stand pivot	M10	35 Nm (25.8 lbf ft)
Nut, side stand bracket	M10x1.25	35 Nm (25.8 lbf ft)
Screw, front footrest bracket / engine bearer	M10x1.25	49 Nm (36.1 lbf ft)
Nut, fork pivot	M14x1.5	100 Nm (73.8 lbf ft)
Nut, rear wheel spindle	M14x1.5	90 Nm (66.4 lbf ft)
Screw, top steering head	M16x1.5	52 Nm (38.4 lbf ft) <b>Loctite® 204™</b>
Lambda sensor	M18x1.5	19 Nm (14 lbf ft)

Adjusting ring, link fork bearing	M22x1	Tighten and ensure that there is no play
Nut, steering head	M30x1	<ol style="list-style-type: none"><li>1. 55 Nm (40.6 lbf ft)</li><li>2. Loosen (counterclockwise) 2 turns</li><li>3. 5 Nm (3.7 lbf ft)</li></ol>

## Brake fluid DOT 4 / DOT 5.1

### Standard/classification

- DOT

### Guideline

- Use only brake fluid that complies with the specified standard (see specifications on the container) and that exhibits the corresponding properties.

### Recommended supplier

#### Castrol

- **REACT PERFORMANCE DOT 4**

#### MOTOREX®

- **Brake Fluid DOT 5.1**

## Coolant

### Guideline

- Only use high-grade, silicate-free coolant with corrosion inhibitor additive for aluminum motors. Low grade and unsuitable antifreeze causes corrosion, deposits and frothing.
- Do not use pure water as only coolant is able to meet the requirements needed in terms of corrosion protection and lubrication properties.
- Only use coolant that complies with the requirements stated (see specifications on the container) and that has the relevant properties.

Antifreeze protection to at least	-25 °C (-13 °F)
-----------------------------------	-----------------



The mixture ratio must be adjusted to the necessary antifreeze protection. Use distilled water if the coolant needs to be diluted.

The use of premixed coolant is recommended.

Observe the coolant manufacturer specifications for antifreeze protection, dilution and miscibility (compatibility) with other coolants.

**Recommended supplier****MOTOREX®**

- **COOLANT M3.0**

**Engine oil (SAE 15W/50)****Standard/classification**

- JASO T903 MA2 (📖 p. 244)
- SAE (📖 p. 244) (SAE 15W/50)

**Guideline**

- Use only engine oils that comply with the specified standards (see specifications on the container) and that possess the corresponding properties.

Semi-synthetic engine oil
---------------------------

**Recommended supplier****MOTOREX®**

- **Formula 4T**

## Engine oil (SAE 10W/40)

### Standard/classification

- JASO T903 MA2 (📖 p. 244)
- SAE (📖 p. 244) (SAE 10W/40)

### Guideline

- Use only engine oils that comply with the specified standards (see specifications on the container) and that possess the corresponding properties.

Semi-synthetic engine oil

### Recommended supplier

#### MOTOREX®

- Formula 4T

## Fork oil (SAE 4) (48601166S1)

### Standard/classification

- SAE (📖 p. 244) (SAE 4)

### Guideline

- Use only oils that comply with the specified standards (see specifications on the container) and that exhibit the corresponding properties.

## Super unleaded (ROZ 95/RON 95/PON 91)

### Standard/classification

- DIN EN 228 (ROZ 95/RON 95/PON 91)

### Guideline

- Only use unleaded super fuel that matches or is equivalent to the specified fuel grade.

- Fuel with an ethanol content of up to 10 % (E10 fuel) is safe to use.
- 

**Info**

Do **not** use fuel containing methanol (e. g. M15, M85, M100) or more than 10 % ethanol (e. g. E15, E25, E85, E100).

---

### Chain cleaner

Recommended supplier

**MOTOREX®**

- Chain Clean

### Fuel additive

Recommended supplier

**MOTOREX®**

- Fuel Stabilizer

### Long-life grease

Recommended supplier

**MOTOREX®**

- Bike Grease 2000

### Motorcycle cleaner

Recommended supplier

**MOTOREX®**

- Moto Clean

### Perfect finish and high gloss polish for paints

Recommended supplier

**MOTOREX®**

- Moto Shine

**Preserving materials for paints, metal and rubber**

Recommended supplier

**MOTOREX®**

- Moto Protect

**Special cleaner for glossy and matte paint finishes, metal and plastic surfaces**

Recommended supplier

**MOTOREX®**

- Quick Cleaner

**Street chain spray**

Guideline

Recommended supplier

**MOTOREX®**

- Chainlube Road Strong

**Universal oil spray**

Recommended supplier

**MOTOREX®**

- Joker 440 Synthetic

## JASO T903 MA2

Different technical development directions required a separate specification for motorcycles – the **JASO T903 MA2** standard.

Earlier, engine oils from the automobile industry were used for motorcycles because there was no separate motorcycle specification.

Whereas long service intervals are demanded for automobile engines, the focus for motorcycle engines is on high performance at high engine speeds.

In most motorcycle engines, the transmission and clutch are lubricated with the same oil.

The **JASO T903 MA2** standard meets these special requirements.

## SAE

The SAE viscosity classes were defined by the Society of Automotive Engineers and are used for classifying oils according to their viscosity. The viscosity describes only one property of oil and says nothing about quality.

ABS	Anti-lock braking system	Safety system that prevents locking of the wheels when driving straight ahead without the influence of lateral forces
OBD	On-board diagnosis	Vehicle system, which monitors the specified parameters of the vehicle electronics



## 27 LIST OF ABBREVIATIONS

Art. no.	Article number
ca.	circa
cf.	compare
e.g.	for example
etc.	et cetera
i.a.	inter alia
no.	number
poss.	possibly





### 28.1 Yellow and orange symbols

Yellow and orange symbols indicate an error condition that requires prompt intervention. Active driving aids are also represented by yellow or orange symbols.

	Malfunction indicator lamp lights up yellow – The OBD has detected a malfunction in the vehicle electronics. Come safely to a halt, and contact an authorized KTM workshop.
	ABS warning lamp lights up yellow – Status or error messages relating to ABS.
	The general warning lamp flashes yellow – A note/warning note on operating safety has been detected. This is also shown in the display.

### 28.2 Green and blue symbols

Green and blue symbols reflect information.

	The turn signal indicator lamp flashes green simultaneously with the turn signal – The turn signal is switched on.
	The idle indicator lamp lights up green – The transmission is in neutral.
	The high beam indicator lamp lights up blue – The high beam is switched on.

## 1

### 12-V battery

- charging ..... 164
- installing ..... 163
- removing ..... 161

## A

**ABS** ..... 129

### ABS fuses

- changing ..... 167

### ACC1

- front ..... 182

### ACC2

- front ..... 182

**Accessories** ..... 16

### Antifreeze

- checking ..... 187

**Anti-lock braking system** ..... 129

**Applying the brakes** ..... 85

**Auxiliary substances** ..... 16

## B

### Battery cover

- mounting ..... 120
- removing ..... 118

### Brake discs

- checking ..... 131

### Brake fluid

- of front brake, adding ..... 133
- of rear brake, adding ..... 138

### Brake fluid level

- front brake, checking ..... 132
- of the rear brake, checking ..... 137

### Brake linings

- front brake, checking ..... 136
- rear brake, checking ..... 142

**Brakes** ..... 85

## C

### Capacity

- coolant ..... 227
- engine oil ..... 207, 227
- fuel ..... 92, 228

### Chain

- chain dirt accumulation, checking ..... 110

checking	116	<b>Service</b>	59
cleaning	110	shift warning light	50
<b>Chain tension</b>		<b>Time Trip 1</b>	61
adjusting	114	<b>Time Trip 2</b>	64
checking	112	<b>TRIP 1</b> display	61
<b>Clutch lever</b>	26	<b>TRIP 2</b> display	64
<b>Clutch lever play</b>		<b>TRIP F</b> display	56
checking	201	warnings	43
<b>Combination instrument</b>		<b>Coolant</b>	
activation and test	42	changing	196
<b>Actual F.C.</b>	60	draining	191
<b>Average Speed Trip1</b>	62	<b>Coolant level</b>	
<b>Average Speed Trip2</b>	65	checking	187
<b>Avg F.C. Trip 1</b>	63	compensating tank, checking	185
<b>Avg F.C. Trip 2</b>	66	correcting in the compensating tank	190
coolant temperature indicator	54	<b>Cooling system</b>	<b>183</b>
display	52	filling/bleeding	193
fuel level display	53	<b>Customer service</b>	17
<b>Fuel Range</b>	58	<b>D</b>	
function buttons	55	<b>Diagnostics connector</b>	182
indicator lamps	48	<b>E</b>	
<b>Info</b> display	57	<b>Emergency OFF switch</b>	30
<b>ODO</b> display	58		
overview	41		

<b>Engine</b>			
running in	74		
<b>Engine number</b>	25		
<b>Engine oil</b>			
adding	208		
changing	205		
<b>Engine oil level</b>			
checking	204		
<b>Engine sprocket</b>			
checking	116		
<b>Environment</b>	14		
<b>F</b>			
<b>Figures</b>	17		
<b>Filling up</b>			
fuel	90		
<b>Foot brake lever</b>	39		
free travel, adjusting	145		
free travel, checking	143		
<b>Fork legs</b>			
dust boots, cleaning	104		
<b>Front rider's seat</b>			
mounting	107		
removing	106		
<b>Front spoiler</b>			
installing	122		
removing	121		
<b>Front wheel</b>			
installing	148		
removing	147		
<b>Fuel tank filler cap</b>			
closing	35		
opening	33		
<b>Fuel, oils, etc.</b>	16		
<b>Fuse</b>			
individual power consumers, changing	170		
<b>G</b>			
<b>Grab handles</b>	37		
<b>H</b>			
<b>Hand brake lever</b>	26		
<b>Headlight range of low beam</b>			
adjusting	180		
<b>Headlight range of the high beam</b>			
adjusting	181		
<b>High beam bulb</b>			
changing	175		

<b>High beam flasher button</b> .....	28
<b>High beam headlight setting</b>	
checking .....	179
<b>Horn button</b> .....	27
<b>I</b>	
<b>Ignition lock</b> .....	31
<b>Implied warranty</b> .....	16
<b>Indicator lamps</b> .....	48
<b>Intended use</b> .....	10
<b>K</b>	
<b>Key number</b> .....	25
<b>L</b>	
<b>Light switch</b> .....	28
<b>Loading the vehicle</b> .....	74
<b>Low beam bulb</b>	
changing .....	173
<b>Low beam headlight setting</b>	
checking .....	177
<b>Luggage</b> .....	74
<b>M</b>	
<b>Manufacturer warranty</b> .....	16
<b>Misuse</b> .....	10

<b>Motorcycle</b>	
cleaning .....	211
lifting with front lifting gear .....	101
rear lifting gear, raising with .....	100
removing the rear from the lifting gear .....	100
taking off front lifting gear .....	103
<b>O</b>	
<b>Oil filter</b>	
changing .....	205
<b>Oil screen</b>	
cleaning .....	205
<b>Owner's Manual</b> .....	15
<b>P</b>	
<b>Parking</b> .....	87
<b>Passenger foot pegs</b> .....	37
<b>Passenger seat</b>	
mounting .....	108
removing .....	107
<b>Play in the clutch lever</b>	
adjusting .....	203
<b>Preparing for use</b>	
advice on preparing for first use .....	72
after storage .....	218

checks and maintenance measures when preparing for use . . . . .	77	<b>Shift speed RPM1</b> adjusting . . . . .	69
<b>Protective clothing</b> . . . . .	13	<b>Shift speed RPM2</b> adjusting . . . . .	70
<b>R</b>			
<b>Rear hub damping rubber pieces</b> checking . . . . .	155	<b>Shifting</b> . . . . .	81
<b>Rear sprocket</b> checking . . . . .	116	<b>Shock absorber</b> spring preload, adjusting . . . . .	97
<b>Rear wheel</b> installing . . . . . removing . . . . .	152 150	<b>Side cover, left</b> installing . . . . . removing . . . . .	125 124
<b>Riding</b> . . . . .	81	<b>Side stand</b> . . . . .	39
starting off . . . . .	80	<b>Spare parts</b> . . . . .	16
<b>Right side cover</b> installing . . . . . removing . . . . .	128 127	<b>Start button</b> . . . . .	30
<b>S</b>			
<b>Safe operation</b> . . . . .	12	<b>Starting</b> . . . . .	78
<b>Seat lock</b> . . . . .	36	<b>Steering</b> locking . . . . . unlocking . . . . .	31 32
<b>Service</b> . . . . .	17	<b>Steering lock</b> . . . . .	31
<b>Service schedule</b> . . . . .	93-96	<b>Stopping</b> . . . . .	87
<b>Shift lever</b> . . . . .	38	<b>Storage</b> . . . . .	216
adjusting . . . . .	98	<b>T</b>	
		<b>Technical data</b> capacities . . . . .	227

chassis . . . . .	228
chassis tightening torques . . . . .	231
electrical system . . . . .	229
engine . . . . .	222
engine tightening torques . . . . .	223
fork . . . . .	231
shock absorber . . . . .	231
tires . . . . .	230
<b>Throttle cable play</b>	
adjusting . . . . .	201
checking . . . . .	200
<b>Throttle grip</b> . . . . .	27
<b>Time</b>	
adjusting . . . . .	68
<b>Tire condition</b>	
checking . . . . .	157
<b>Tire pressure</b>	
checking . . . . .	159
<b>Tool set</b> . . . . .	36
<b>Transport</b> . . . . .	89
<b>Troubleshooting</b> . . . . .	219-221
<b>Turn signal switch</b> . . . . .	29
<b>Type label</b> . . . . .	24

## U

### Units

adjusting . . . . .	66
---------------------	----

<b>Use definition</b> . . . . .	10
---------------------------------	----

## V

<b>Vehicle identification number</b> . . . . .	24
--	----

### View of vehicle

front left . . . . .	20
----------------------	----

rear right . . . . .	22
----------------------	----

## W

### Winter operation

checks and maintenance steps . . . . .	214
--	-----

<b>Work rules</b> . . . . .	14
-----------------------------	----

**READY TO RACE**  
» [www.ktm.com](http://www.ktm.com)



3214114en

11/2019

**KTM Sportmotorcycle GmbH**  
3230 Mattighofen/Austria  
<http://www.ktm.com>



REG. NO. 12 100 6061

**Photo:**  
**Mitterbauer/KISKA/KTM**