

2009_85_SX_19_16.jpg 2011

ART.-NR.: 3CF 6001K9EN

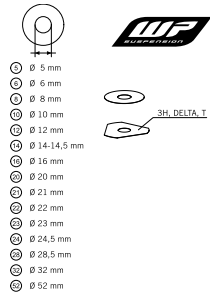

WP SHIMS FOR SETTING



3

FRONT FORK, TRIPLE CLAMP

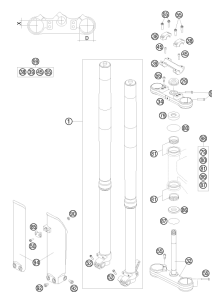

10

FRONT FORK DISASSEMBLED

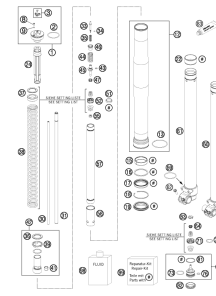

11

HANDLEBAR, CONTROLS

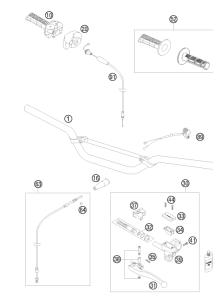

13

FRAME, SUBFRAME

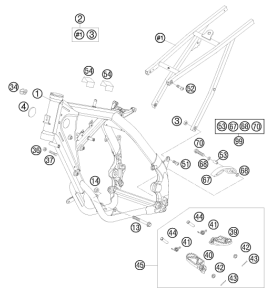

14

SWING ARM

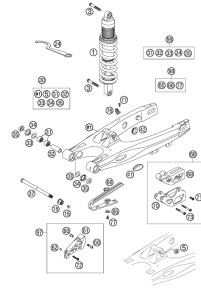

15

MONOSHOCK DISASSEMBLED

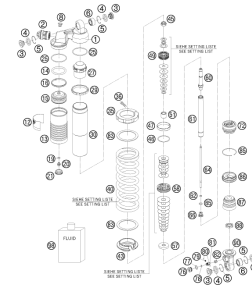

16

EXHAUST SYSTEM

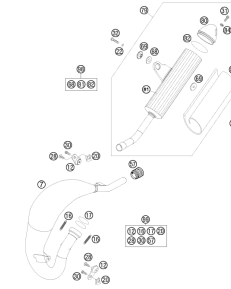

18

AIR FILTER

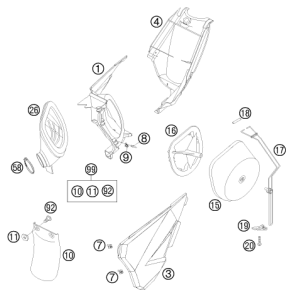

19

TANK, SEAT, COVERS

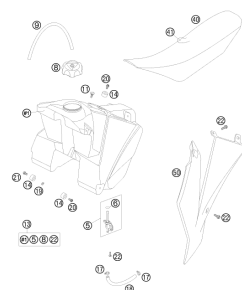

20

MASK, FENDERS

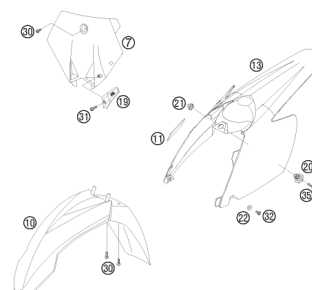

21

DECAL

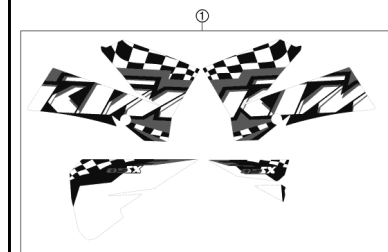

22

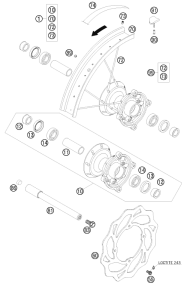
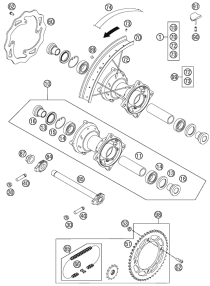
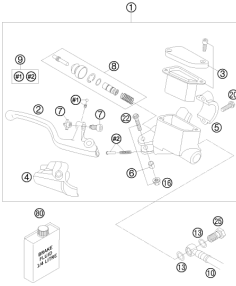
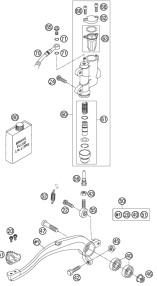
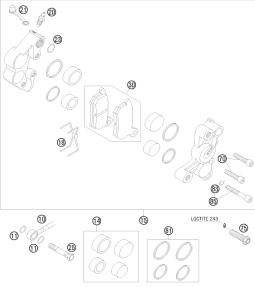
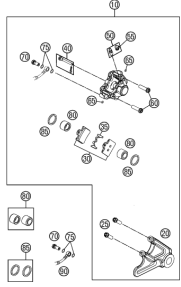
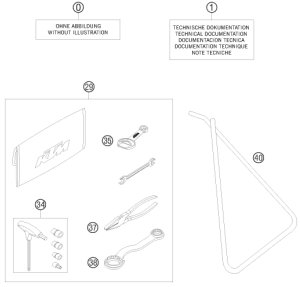
<p>FRONT WHEEL</p>  <p style="text-align: right;">23</p>	<p>REAR WHEEL</p>  <p style="text-align: right;">24</p>	<p>HAND BRAKE CYLINDER</p>  <p style="text-align: right;">25</p>	<p>REAR BREAK CONTROL</p>  <p style="text-align: right;">26</p>
<p>BRAKE CALIPER FRONT</p>  <p style="text-align: right;">27</p>	<p>BREAK CALIPER REAR</p>  <p style="text-align: right;">28</p>	<p>ACCESSORIES KIT</p>  <p style="text-align: right;">29</p>	
<div style="display: flex; align-items: center;"> <div style="background-color: #cccccc; width: 50px; height: 100px; display: flex; align-items: center; justify-content: center; margin-right: 20px;"> ! </div> <div> <p>All information contained is without obligation. KTM-Sportmotorcycle AG particularly reserves the right to modify any equipment, technical specifications, prices, colors, shapes, materials, services, service work, constructions, equipment and the like so as to adapt them to local conditions or to cancel any of the above items, all without previous announcement and without giving reasons. KTM may stop manufacturing certain models without previous notice. KTM shall not be held liable for any deviations of availability and/or ability to deliver, illustrations, descriptions, printing and/or other errors. The illustrated models partly contain extra equipment, which is not applied to standard models.</p> <p>© by KTM-SPORTMOTORCYCLE AG, Mattighofen AUSTRIA; All rights reserved; Reprint, also in extracts, with written allowance of KTMSPORTMOTORCYCLE AG, Mattighofen only.</p> </div> </div>			



- ⑤ Ø 5 mm
- ⑥ Ø 6 mm
- ⑧ Ø 8 mm
- ⑩ Ø 10 mm
- ⑫ Ø 12 mm
- ⑭ Ø 14-14,5 mm
- ⑯ Ø 16 mm
- ⑳ Ø 20 mm
- ㉑ Ø 21 mm
- ㉒ Ø 22 mm
- ㉓ Ø 23 mm
- ㉔ Ø 24,5 mm
- ㉘ Ø 28,5 mm
- ㉚ Ø 32 mm
- ㉜ Ø 52 mm

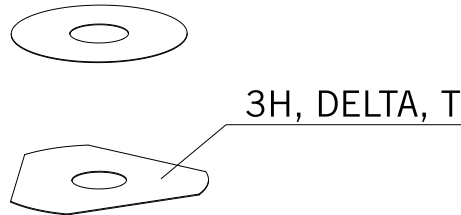

POS	PARTNUMBER	PARTNAME	PIECE
5	44906890	WASHER 5X15X2	X
6	40540400	SHIM 6X12X0,1	X
6	40540401	SHIM 6X14X0,1	X
6	40540402	SHIM 6X16X0,1	X
6	40540403	SHIM 6X18X0,1	X
6	40540404	SHIM 6X12X0,15	X
6	40540405	SHIM 6X14X0,15	X
6	40540406	SHIM 6X16X0,15	X
6	40540407	SHIM 6X18X0,15	X
6	40540408	SHIM 6X12X0,2	X
6	40540409	SHIM 6X14X0,2	X
6	40540410	SHIM 6X16X0,2	X
6	40540411	SHIM 6X18X0,2	X
6	48600095	* SHIM 6X20X0,20	X
6	40540412	SHIM 6X12X0,25	X
6	40540413	SHIM 6X14X0,25	X
6	40540414	SHIM 6X16X0,25	X
6	40540415	SHIM 6X18X0,25	X
6	40540417	SHIM 6X8,5X0,10	X
6	40540418	SHIM 6X9X0,10	X
6	40540419	SHIM 6X9,5X0,10	X
6	40540423	SHIM 6X9,5X0,15	X
6	40540425	SHIM 6X8,5X0,20	X
6	40540426	SHIM 6X9X0,20	X
6	40540427	SHIM 6X9,5X0,20	X
6	40540447	SHIM 6X10X0,3	X
6	40540449	SHIM 6X9X0,3	X
6	40540450	SHIM 6X9,5X0,3	X
6	40540494	SHIM 6X18X0,4	X
6	40540774	SHIM 6X18X0,1 DELTA	X
6	40541383	SHIM 6X11X0,1	X
6	40541391	SHIM 6X11X0,3	X
6	40541402	SHIM 6X11X0,2	X
6	40541403	SHIM 6X10X0,20	X
6	40541404	SHIM 6X10X0,1	X
6	40541405	SHIM 6X10X0,15	X
6	40541406	SHIM 6X11X0,15	X
6	40541408	SHIM 6X8,0X0,30	X

080000190

C070000190

* NEW PART

X ON DEMAND



- ⑤ Ø 5 mm
- ⑥ Ø 6 mm
- ⑧ Ø 8 mm
- ⑩ Ø 10 mm
- ⑫ Ø 12 mm
- ⑭ Ø 14-14,5 mm
- ⑯ Ø 16 mm
- ⑳ Ø 20 mm
- ㉑ Ø 21 mm
- ㉒ Ø 22 mm
- ㉓ Ø 23 mm
- ㉔ Ø 24,5 mm
- ㉘ Ø 28,5 mm
- ㉚ Ø 32 mm
- ㉜ Ø 52 mm



POS	PARTNUMBER	PARTNAME	PIECE
6	40541414	SHIM 6X8,0X0,10	X
6	40541416	SHIM 6X8X0,3	X
6	40541417	SHIM 6X11X0,25	X
6	48600102	* SHIM 6X24X0,25	X
6	48600063	SHIM 6X24X0,1	X
6	48600064	SHIM 6X22X0,1	X
6	48600065	SHIM 6X20X0,1	X
6	48600069	SHIM 6X20X0,15	X
6	48600100	SHIM 6X24X0,15	X
6	48600116	SHIM 6X24X0,1 DELTA	X
6	48600139	SHIM 6X22X0,1 DELTA	X
6	48600217	BACKPLATE 6X10X0,25	X
6	48600325	SHIM 6X13X0,1	X
6	48600327	SHIM 6X15X0,1	X
6	48600329	SHIM 6X17X0,1	X
6	48600331	SHIM 6X19X0,1	X
6	48600096	* SHIM 6X20X0,25	X
6	48600097	SHIM 6X22X0,15	X
6	48600099	* SHIM 6X22X0,25	X
6	40540448	BACKPLATE 6X8,5X0,30	X
6	48600479	SHIM 6X20X0,1 T/3H	X
6	48600332	SHIM 6X21X0,1	X
6	48600333	SHIM 6X23X0,1	X
6	40541393	* SHIM 6X12X0,3	X
8	40540477	SHIM 8X18X0,4	X
8	43570120	SHIM 8X18X0,10	X
8	44916098	WASHER 8,4X16X0,8	X
8	44916130	WASHER 8,2X15X1	X
8	44916180	WASHER 8,2X11X1	X
8	48600214	SHIM 8X16X0,1	X
8	48600346	SHIM 8X11X0,2	X
8	48600215	CHECK VALVE 8X20X0,1	X
8	48600061	CHECK VALVE 8X24X0,4	X
8	48600062	CHECK VALVE 8X24X0,1	X
8	48600216	CHECK VALVE 8X22X0,1	X
8	48600480	SHIM 8X10X0,20	X
8	48600555	SHIM 8X16X0,20	X
8	48600213	SHIM 8X14X0,10	X

080000190

C070000190

* NEW PART

X ON DEMAND



- ⑤ Ø 5 mm
- ⑥ Ø 6 mm
- ⑧ Ø 8 mm
- ⑩ Ø 10 mm
- ⑫ Ø 12 mm
- ⑭ Ø 14-14,5 mm
- ⑯ Ø 16 mm
- ⑰ Ø 20 mm
- ⑱ Ø 21 mm
- ⑳ Ø 22 mm
- ㉑ Ø 23 mm
- ㉒ Ø 24,5 mm
- ㉔ Ø 28,5 mm
- ㉖ Ø 32 mm
- ㉘ Ø 52 mm



POS	PARTNUMBER	PARTNAME	PIECE
8	48600357	CHECK VALVE 8X11X0,1	X
8	48600351	CHECK VALVE 8X12X0,1	X
8	48600607	SHUTTLE VALVE 8X20X0,4	X
10	36120284	SHIM 10X16X0,10	X
10	36120298	SHIM 10X16X0,2	X
10	36120312	SHIM 10X16X0,30	X
10	36120314	SHIM 10X18X0,30	X
10	36120325	SHIM 10X19X0,15	X
10	36120327	SHIM 10X23X0,15	X
10	36120328	SHIM 10X25X0,15	X
10	36120329	SHIM 10X27X0,15	X
10	36120330	SHIM 10X29X0,15	X
10	36120331	SHIM 10X31X0,15	X
10	36120332	SHIM 10X33X0,15	X
10	36120334	SHIM 10X21X0,20	X
10	36120335	SHIM 10X23X0,20	X
10	36120336	SHIM 10X25X0,20	X
10	36120337	SHIM 10X27X0,20	X
10	36120338	SHIM 10X29X0,20	X
10	36120339	SHIM 10X31X0,20	X
10	36120340	SHIM 10X33X0,20	X
10	36120342	SHIM 10X21X0,25	X
10	36120343	SHIM 10X23X0,25	X
10	36120344	SHIM 10X25X0,25	X
10	36120345	SHIM 10X27X0,25	X
10	36120349	SHIM 10X19X0,30	X
10	36120350	SHIM 10X21X0,30	X
10	40140275	WASHER 10X35X0,15	X
10	36120346	* SHIM 10X29X0,25	X
10	50180010	* SHIM 16X24X0,10	X
10	36120604	SHIM D10XD22X2,5	X
12	46810490	SHIM 12X24X0,20	X
12	46810491	SHIM 12X26X0,20	X
12	46810492	SHIM 12X28X0,20	X
12	46810493	SHIM 12X30X0,20	X
12	46810494	SHIM 12X32X0,20	X
12	46810495	SHIM 12X34X0,20	X
12	46810496	SHIM 12X36X0,20	X

080000190

C070000190

* NEW PART

X ON DEMAND

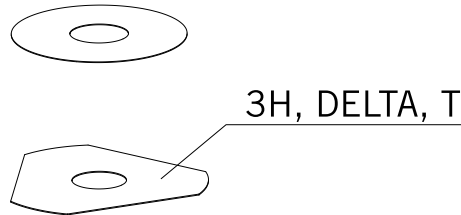

- ⑤ Ø 5 mm
- ⑥ Ø 6 mm
- ⑧ Ø 8 mm
- ⑩ Ø 10 mm
- ⑫ Ø 12 mm
- ⑭ Ø 14-14,5 mm
- ⑯ Ø 16 mm
- ⑳ Ø 20 mm
- ㉑ Ø 21 mm
- ㉒ Ø 22 mm
- ㉓ Ø 23 mm
- ㉔ Ø 24,5 mm
- ㉘ Ø 28,5 mm
- ㉚ Ø 32 mm
- ㉜ Ø 52 mm

POS	PARTNUMBER	PARTNAME	PIECE
12	46810497	SHIM 12X38X0,20	X
12	46810498	SHIM 12X40X0,20	X
12	46810499	SHIM 12X24X0,25	X
12	46810500	SHIM 12X26X0,25	X
12	46810501	SHIM 12X28X0,25	X
12	46810502	SHIM 12X30X0,25	X
12	46810504	SHIM 12X34X0,25	X
12	46810505	SHIM 12X36X0,25	X
12	46810507	SHIM 12X40X0,25	X
12	46810508	SHIM 12X24X0,30	X
12	46810509	SHIM 12X26X0,30	X
12	46810510	SHIM 12X28X0,30	X
12	46810512	SHIM 12X32X0,30	X
12	46810513	SHIM 12X34X0,30	X
12	46810518	SHIM 12X26X0,15	X
12	46810519	SHIM 12X28X0,15	X
12	46810520	SHIM 12X30X0,15	X
12	46810521	SHIM 12X32X0,15	X
12	46810522	SHIM 12X34X0,15	X
12	46810523	SHIM 12X36X0,15	X
12	46810524	SHIM 12X38X0,15	X
12	46810525	SHIM 12X40X0,15	X
12	46810604	SHIM 12X20X0,10	X
12	46810606	SHIM 12X22X0,10	X
12	46810607	SHIM 12X23X0,10	X
12	46810608	SHIM 12X24X0,10	X
12	46810610	SHIM 12X27X0,15	X
12	46810611	SHIM 12X18X0,15	X
12	46810612	SHIM 12X19X0,15	X
12	46810615	SHIM 12X22X0,15	X
12	46810636	BACKPLATE 12X16X0,30	X
12	46810637	BACKPLATE 12X17X0,30	X
12	46810638	BACKPLATE 12X18X0,30	X
12	46810639	SHIM 12X19X0,30	X
12	46810641	BACKPLATE 12X21X0,30	X
12	46811582	BACKPLATE 12X30X0,10	X
12	46810631	SHIM 12X20X0,25	X
12	46810633	SHIM 12X22X0,25	X

080000190

C070000190

* NEW PART

X ON DEMAND



- ⑤ Ø 5 mm
- ⑥ Ø 6 mm
- ⑧ Ø 8 mm
- ⑩ Ø 10 mm
- ⑫ Ø 12 mm
- ⑭ Ø 14-14,5 mm
- ⑯ Ø 16 mm
- ⑳ Ø 20 mm
- ㉑ Ø 21 mm
- ㉒ Ø 22 mm
- ㉓ Ø 23 mm
- ㉔ Ø 24,5 mm
- ㉘ Ø 28,5 mm
- ㉚ Ø 32 mm
- ㉜ Ø 52 mm



POS	PARTNUMBER	PARTNAME	PIECE
12	46810624	* SHIM 12X22X0,20	X
12	46811580	SHIM 12X32X0,10	X
12	46810503	SHIM 12X32X0,25	X
12	46810517	* SHIM 12X24X0,15	X
12	46810640	SHIM 12X20X0,30	X
14	46811046	SHIM 14,5X35,4X1,25	X
16	50180006	BACKPLATE 16X20X0,10	X
16	50180007	SHIM 16X21X0,10	X
16	50180028	SHIM 16X21X0,25	X
16	50180210	WASHER 16X21X1	X
16	50180008	SHIM 16X22X0,10	X
16	50180022	SHIM 16X22X0,20	X
16	50180037	SHIM 16X23X0,30	X
16	50180038	SHIM 16X24X0,30	X
16	50180032	SHIM 15X25X0,25	X
16	50180039	SHIM 16X25X0,30	X
16	50180012	SHIM 16X26X0,10	X
16	50180019	SHIM 16X26X0,15	X
16	50180026	SHIM 16X26X0,20	X
16	50180040	SHIM 16X26X0,30	X
16	50180041	SHIM 16X28X0,10	X
16	50180045	SHIM 16X28X0,15	X
16	50180054	SHIM 16X28X0,20	X
16	50180063	SHIM 16X28X0,25	X
16	50180072	SHIM 16X28X0,30	X
16	50180046	SHIM 16X30X0,15	X
16	50180055	SHIM 16X30X0,20	X
16	50180064	SHIM 16X30X0,25	X
16	50180073	SHIM 16X30X0,30	X
16	50180047	SHIM 16X32X0,15	X
16	50180056	SHIM 16X32X0,20	X
16	50180065	SHIM 16X32X0,25	X
16	50180074	SHIM 16X32X0,30	X
16	50180044	SHIM 16X34X0,10	X
16	50180048	SHIM 16X34X0,15	X
16	50180057	SHIM 16X34X0,20	X
16	50180066	SHIM 16X34X0,25	X
16	50180075	SHIM 16X34X0,30	X

080000190

C070000190

* NEW PART

X ON DEMAND



- ⑤ Ø 5 mm
- ⑥ Ø 6 mm
- ⑧ Ø 8 mm
- ⑩ Ø 10 mm
- ⑫ Ø 12 mm
- ⑭ Ø 14-14,5 mm
- ⑯ Ø 16 mm
- ⑳ Ø 20 mm
- ㉑ Ø 21 mm
- ㉒ Ø 22 mm
- ㉓ Ø 23 mm
- ㉔ Ø 24,5 mm
- ㉘ Ø 28,5 mm
- ㉚ Ø 32 mm
- ㉜ Ø 52 mm



POS	PARTNUMBER	PARTNAME	PIECE
16	50180049	SHIM 16X36X0,15	X
16	50180058	SHIM 16X36X0,20	X
16	50180067	SHIM 16X36X0,25	X
16	50180076	SHIM 16X36X0,30	X
16	50180050	SHIM 16X38X0,15	X
16	50180059	SHIM 16X38X0,20	X
16	50180068	SHIM 16X38X0,25	X
16	50180077	SHIM 16X38X0,30	X
16	50180051	SHIM 16X40X0,15	X
16	50180060	SHIM 16X40X0,20	X
16	50180069	SHIM 16X40X0,25	X
16	50180078	SHIM 16X40X0,30	X
16	50180052	SHIM 16X42X0,15	X
16	50180061	SHIM 16X42X0,20	X
16	50180070	SHIM 16X42X0,25	X
16	50180079	SHIM 16X42X0,30	X
16	50180053	SHIM 16X44X0,15	X
16	50180062	SHIM 16X44X0,20	X
16	50180071	SHIM 16X44X0,25	X
16	50180080	SHIM 16X44X0,30	X
16	50180177	WASHER 16X8,2X0,6	X
16	50180033	SHIM 16X26X0,25	X
16	50180034	BACKPLATE 16X20X0,30	X
16	50180035	BACKPLATE 16X21X0,30	X
16	50180036	BACKPLATE 16X22X0,30	X
16	50180043	SHIM	X
16	50180024	* SHIM 16X24X0,20	X
16	50180027	* SHIM 16X20X0,25	X
16	50180031	SHIM	X
20	48600212	PRESSURE-RING 20X16,25X0,20	X
20	50180666	SHIM 20X24X0,30	X
20	50180654	SHIM 20X36X0,20	X
20	50180655	SHIM 20X38X0,20	X
20	50180656	SHIM 20X40X0,20	X
20	50180665	SHIM 20X40X0,25	X
20	50180662	SHIM 20X34X0,25	X
20	50180657	SHIM 20X24X0,25	X
20	50180653	SHIM 20X34X0,20	X

080000190

C070000190

* NEW PART

X ON DEMAND



- ⑤ Ø 5 mm
- ⑥ Ø 6 mm
- ⑧ Ø 8 mm
- ⑩ Ø 10 mm
- ⑫ Ø 12 mm
- ⑭ Ø 14-14,5 mm
- ⑯ Ø 16 mm
- ⑳ Ø 20 mm
- ㉑ Ø 21 mm
- ㉒ Ø 22 mm
- ㉓ Ø 23 mm
- ㉔ Ø 24,5 mm
- ㉘ Ø 28,5 mm
- ㉚ Ø 32 mm
- ㉜ Ø 52 mm

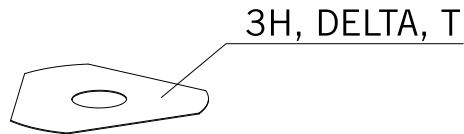

POS	PARTNUMBER	PARTNAME	PIECE
20	50180634	RING 20X22,9X1	X
21	50180209	WASHER 21X36X0,25	X
22	50180330	* PRESS. RING 22X18X0,30	X
23	50180635	SHUTTLE VALVE 23X38X0,25	X
23	50180578	SHIM D23XD16X2	X
24	40541061	WASHER 24,5X34X2	X
28	36120469	SHIM 28,5X14X2	X
28	36120471	SHIM 28,5X14X5	X
32	48600460	WASHER 32X42X2,5	X
32	50600065	SHIM 32X45X2	X
32	46811637	PRESSURE RING 36X32,25	X
52	50600002	SHIM 52X59X2,2	X

080000190

C070000190

* NEW PART

X ON DEMAND

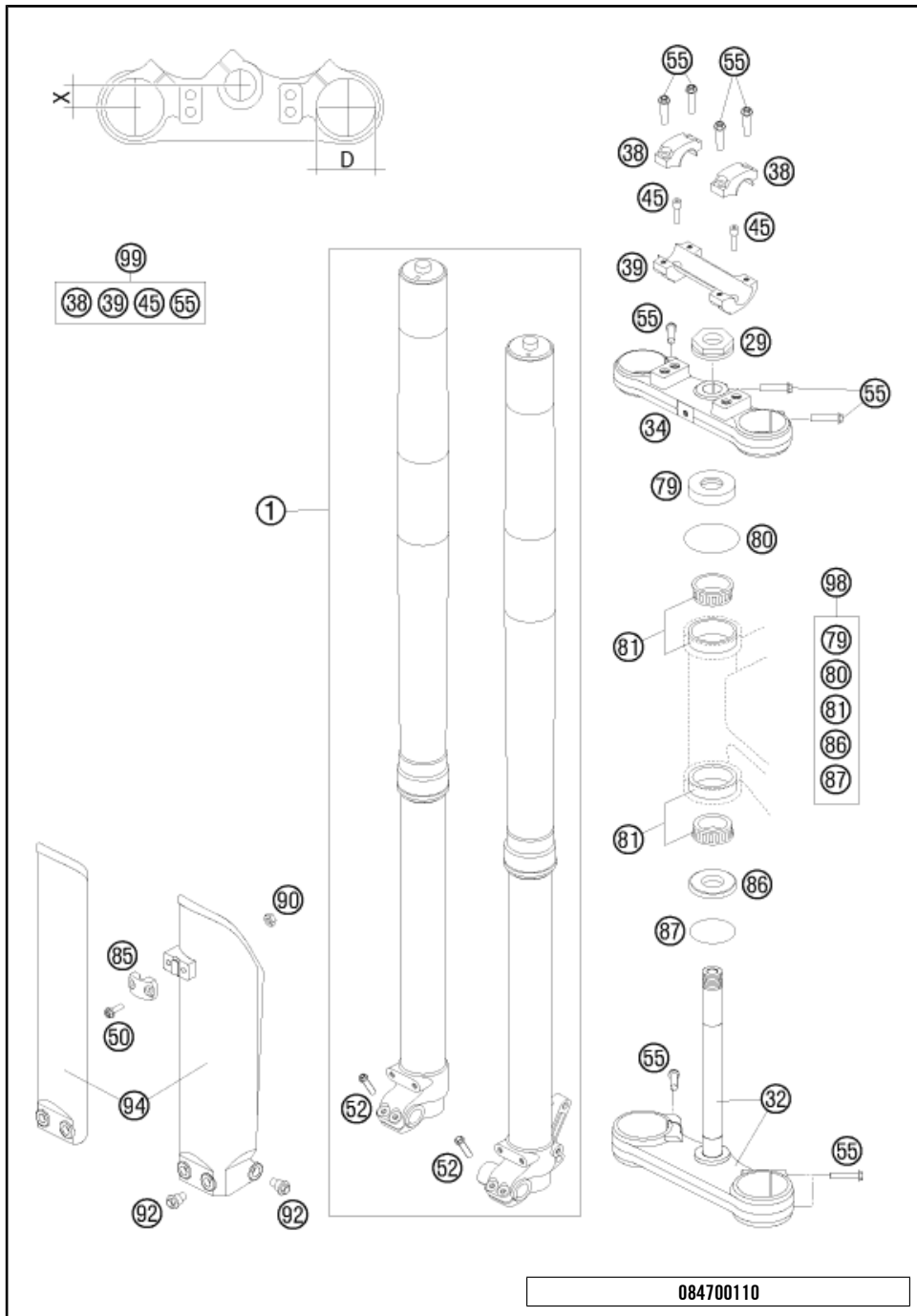

POS	PARTNUMBER	PARTNAME	PIECE
1*	05187K0501	FORK KTM 85/105 SX 2011	1
29	59030029000	HH NUT M20X1,5 WS=27 RIGHT	1
32	47001032014	BOT.TRIPLE CLAMP CPL. 85 SX 03	1
34	47001034014	TOP TRIPLE CLAMP 85 SX 2003	1
38	50301038000	HANDLEBAR CLAMP D=22MM 2001	2
39	59001039000	HANDLEBAR SUPPORT 22MM 2T 2000	1
45*	0032100256S	AH-COLLAR SCREW M10X25 ISA45	2
50	0025050166	HH COLLAR SCREW M5X16 TX30	2
52	0025060206	HH COLLAR SCREW M6X20 TX30	4
55	0025080306	HH COLLAR SCREW M8X30 TX40	11
79	49001086000	COVERING CAP	1
80	0770021300	O-RING 40,94X2,62 NBR70	1
81	49001081000	TAPERED ROLLER BEARING 32004X	2
85*	5460108500028	BRAKE HOSE CLIP	1
86	46001086000	PROTECTION RING 20,1X39X5	1
87	0770360030	O-RING 36,00X3,00 NBR	1
90	0985050003	SELF LOCKING NUT DIN0985-M 5	2
92	59001092050	SPECIAL SCREW M6X12,5 WS=8	6
94*	4700109400028	%FORK PROTECTOR SET 85/105 WHI	1
98	00050000931	STEERING HEAD REP. KIT MINI	x
99	00050000923	HANDLEBAR SUPPORT KIT	x

* NEW PART X ON DEMAND

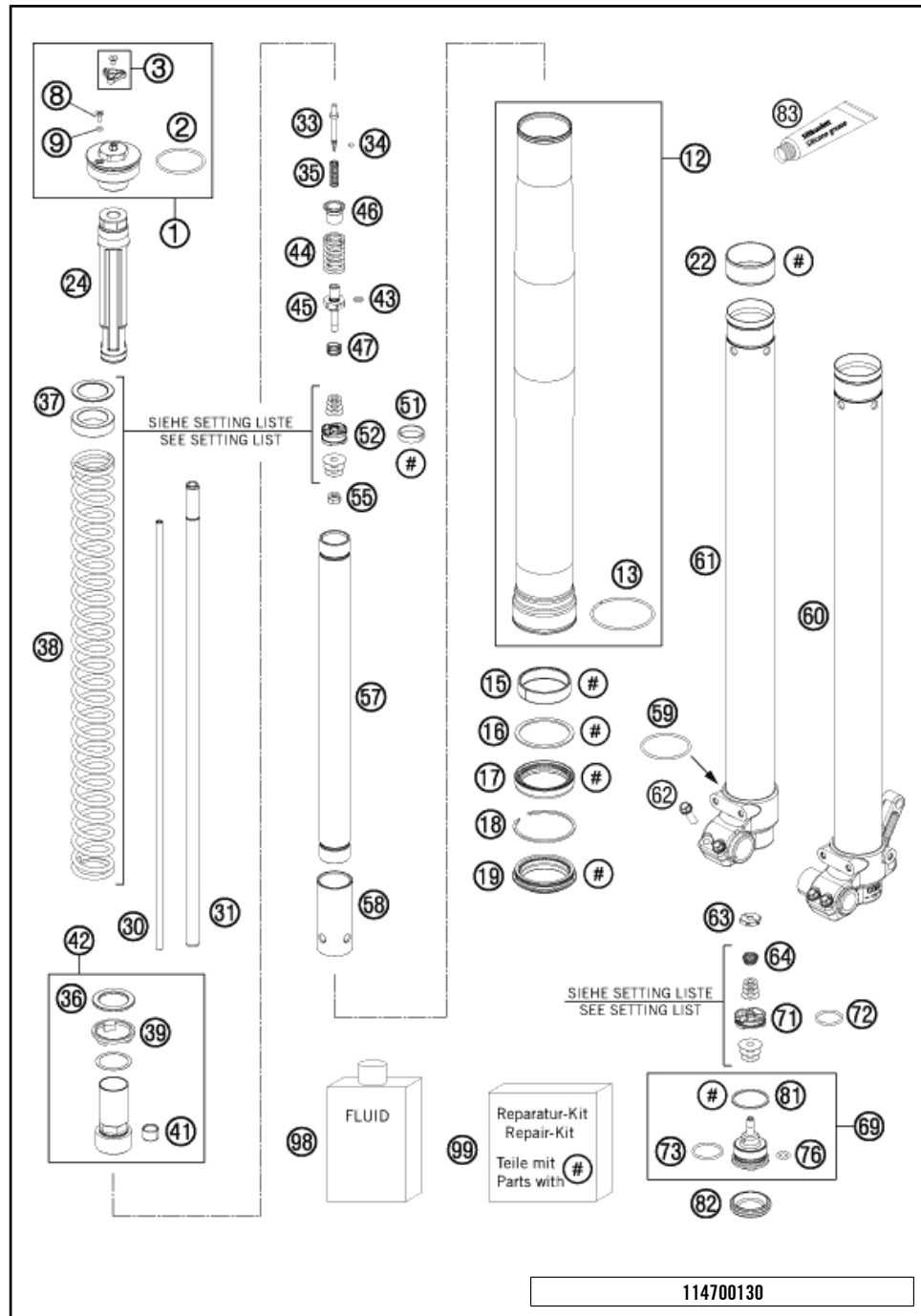

POS	PARTNUMBER	PARTNAME	PIECE
1*	43570395S1	SCREW CAP M4X1,5 CPL.	2
2	46811042	O-RING 40,00X2,00 WP	2
3*	48600812S	ADJUSTING KNOB + SCREW	2
8	48600481	VENT SCREW M4X8	2
9	48600046	O-RING NBR 3X1,5	2
12*	43570614E	OUTER TUBE L510 D49/53	2
13	43570099	GUIDING RING D=53MM	2
15	43570204	DU-BUSH 43X47X12 DAIDO	2
16	43570092	SUPPORT RING 45 X 52,5 X 1,5	2
17	43570201	OIL SEAL RING 43 X 52,9 X 9,5	2
18	43570008	LOCK WASHER SB53	2
19	43570202	DUST STRIPPER 43 X 53,4 X 11,8	2
22	43570203	DU-BUSH 42X44X20	2
24	43570396S	STOP L135MM D28,6MM D12MM CPL.	2
30	48600695	ADJUSTMENT TUBE L=442 MM	2
31	48600694	PISTON ROD D=12MM L=476MM	2
33	48600277	ADJUSTER NEEDLE 07	2
34	48600298	O-RING 2X1,5 NBR	2
35	48600444	REBOUND SPRING C=4N/MM	2
36*	43570133	SPACER 26X38X2,5	2
37	43570133	SPACER 26X38X2,5	2
37	43570134	SPACER 26X38X5	2
37	43570135	SPACER 26X38X10	2
37	43570136	SPACER 26X38X1,5	2
38	95010032S	SPRING 3,4 N/MM SET D=4,4MM	x
38	95010033S	SPRING 3,6 N/MM SET	x
38	95010031S	SPRING 3,2 N/MM SET D=4,2MM	x
39	43570131	INTERM. RING 26,2X38,5X3	2
41	48600430	DU BUSH FOR PISTON ROD	2
42*	48600830S2	SCREW SLEEVE M27X0,8 CPL.	2
43	48600299	O-RING 6X1,2 NBR	2
44	48600511	REBOUND SPRING L=32 C=17	2
45	48600513	TAP REBOUND 07	2
46	48600525	GUIDING BUSH REBOUND SPRING	2
47	48600382	SHUTTLE VALVE SPRING C=0,4	2
51*	48600455	PISTON RING 5X1X68	2
52*	48600575	PISTON REBOUND SX 2007	2
55	40540486	NUT M6X0,5 REBOUND	2

114700130

C114700130

* NEW PART X ON DEMAND

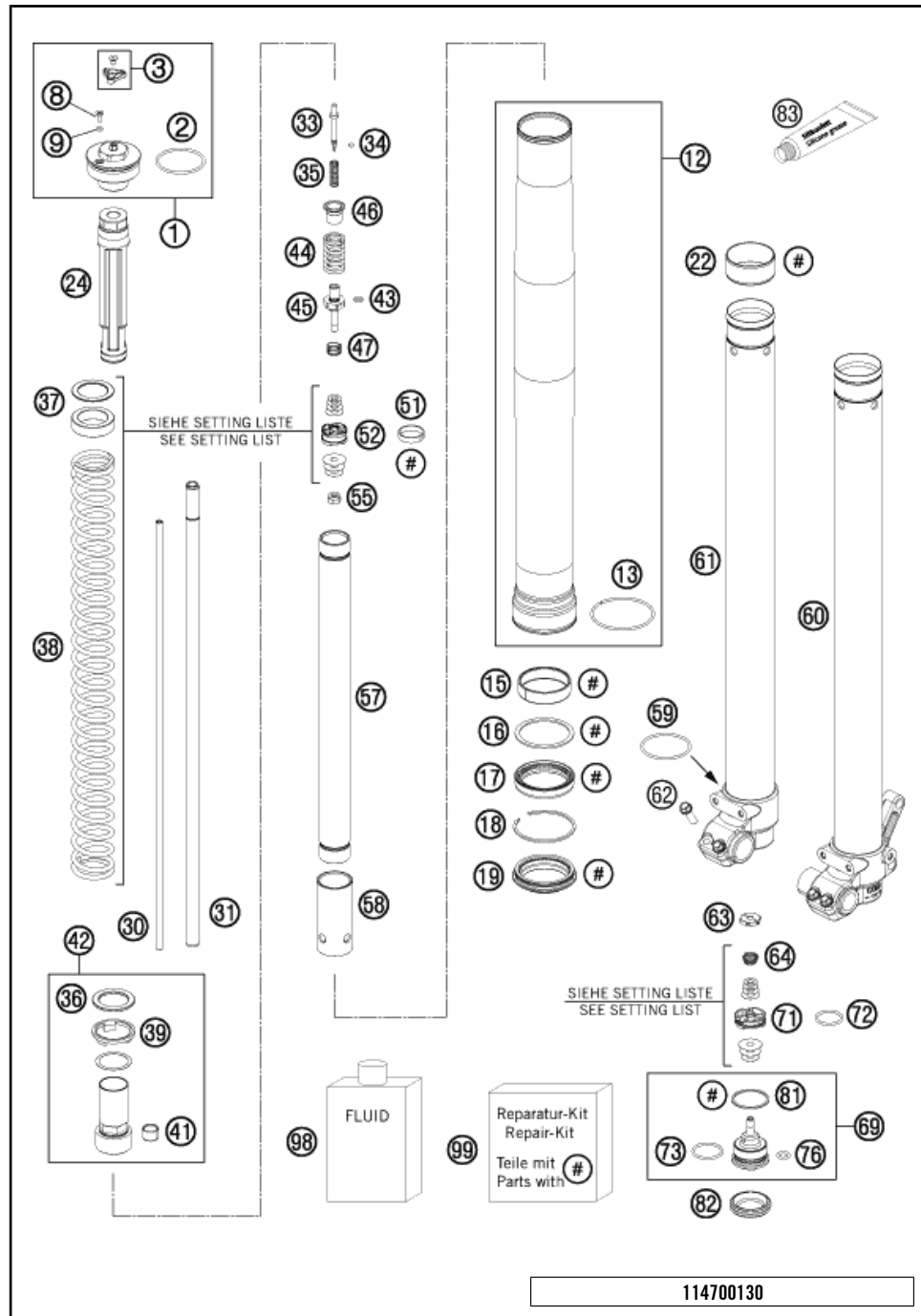

POS	PARTNUMBER	PARTNAME	PIECE
57*	48600870	TUBE 23 L=330	2
58*	48600764	ADAPTER SLEEVE D23/D28	2
59	43570023	O-RING NBR 41X2	2
60*	43570528S1	AXLE CLAMP L/S + TUBE CPL.	1
61*	43570527S1	AXLE CLAMP R/S + TUBE CPL.	1
62	0025060206	HH COLLAR SCREW M6X20 TX30	4
63*	48600885	NUT VALVE M6X0,5 LH=1,2	2
64	48600202	SPRING CHECK VALVE D=0,7	2
69	48600586S	TAP COMPRESSION CPL. 07	2
71	48600047	PISTON COMPRESSION D=27,9	2
72	46811499	O-RING NBR 21X2	2
73	35480320	O-RING NBR 24X2	2
76	48600049	O-RING NBR 8X2	2
81	48600004	COPPER WASHER 29,5X33,5X1	2
82	48600141	RUBBER CAP D=35MM	2
83	T511	SILICONE GREASE F. DUST STRI	1
98	48600765S1	% FORK OIL SAE5 5L 2008	1
99*	R511	REPAIR-KIT	1

114700130

C114700130

* NEW PART X ON DEMAND

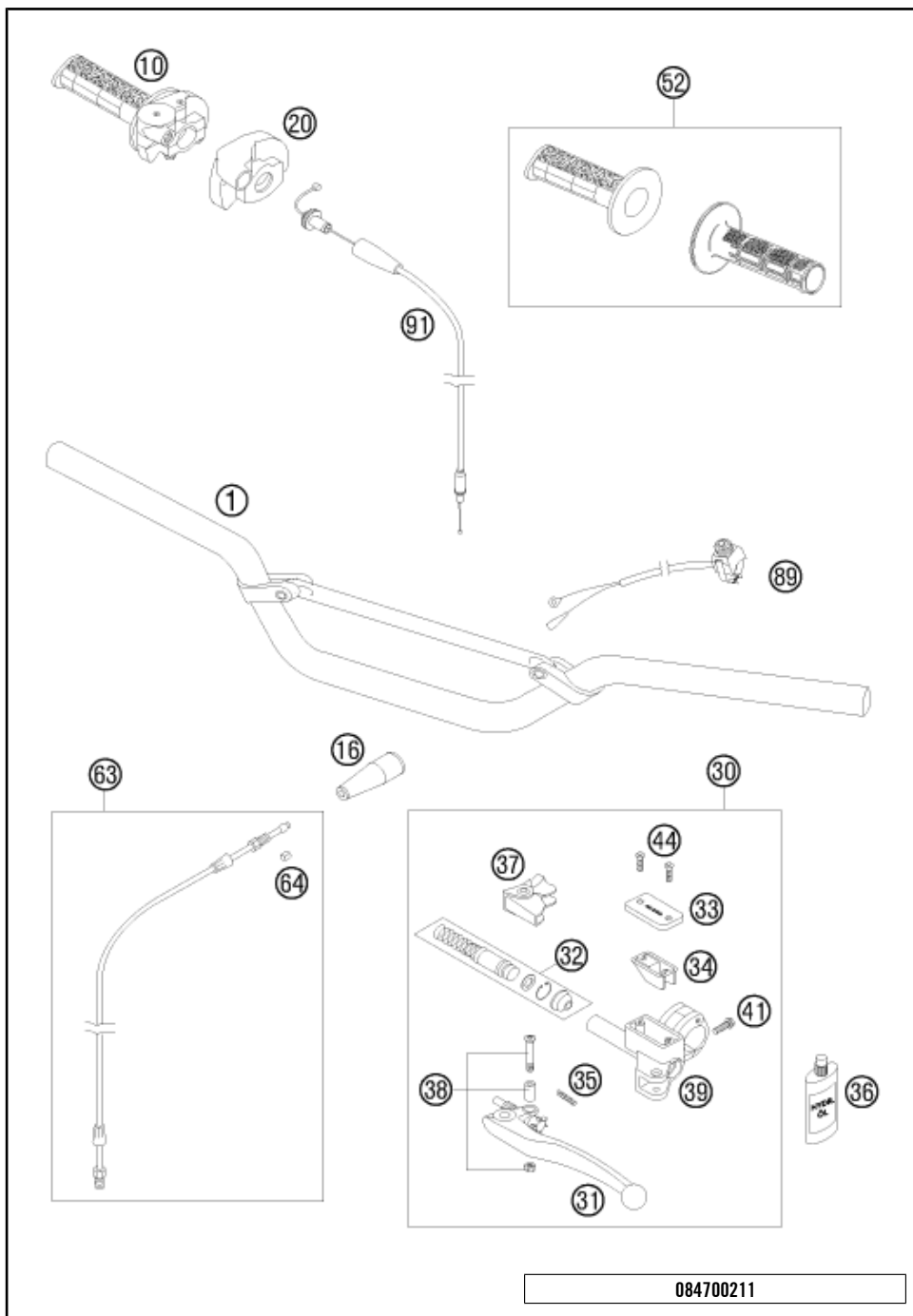

POS	PARTNUMBER	PARTNAME	PIECE
1	47002001100	HANDLEBAR D=22MM 85 SX 2005	1
10	50302010000	%THR.TWIST CRIP CPL. W.O C.'97	1
16	54002016000	PROTECTION CAP	1
20	50302020000	PROTECTION COVER '97	1
30	46102030100	MASTER CYLINDER CPL. D=9MM 05	1
31	54602031000	CLUTCH LEVER SHORT CPL. 2003	1
31	59002031000	CLUTCH LEVER LONG CPL. 2003	x
32	59002032100	REP.KIT PISTON 9,0MM RAC. 2004	1
33	50302033100	COVER HYD.CLUTCH 2T 2000	1
34	50302034000	RUBBER FOR RESERVOIR '98	1
35	59002035000	SPRING FOR CLUTCH LEVER 03	1
36	50302036200	OIL FOR HYD. CLUTCH 100 ML	1
37	50302037000	PROTECT.CAP FOR LEVER PERCH'98	1
38	50302038000	LEVER SCREW CPL. 125-200 '98	1
39	50302030150	CLAMP WITH PIN 2000	1
41	0025060206	HH COLLAR SCREW M6X20 TX30	1
44	0965040123	FLAT HEAD SCREW DIN0965-M 4X12	2
52	50202021000	GRIPP SET HALF WAFFLE	x
63	46132063000	PIPE KIT FOR HYDR.CLUTCH 65 SX	1
64	50332063050	SELF CUTTING RING HYDR.PIPE	1
89	50311089200	SHORT CIRCUIT BUTTON 02	1
91	50302091000	% THROTTLE C. 125-380 DOM/KEIH	1

C094700211

* NEW PART X ON DEMAND

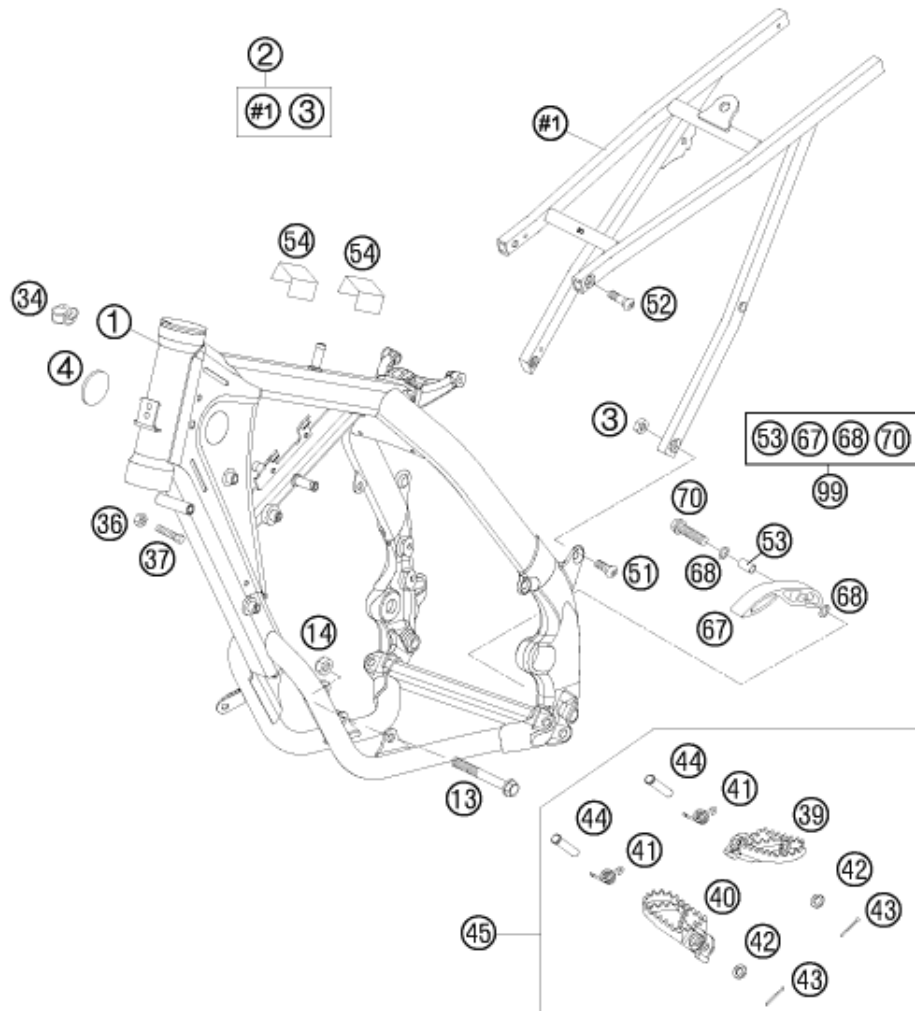

084700312

POS	PARTNUMBER	PARTNAME	PIECE
1	4700300120030	FRAME CPL. 85 SX "AA06" 06	1
2	47003002144	SUB FRAME 85 SX 06	1
3	0934080006	HEXAGON NUT DIN 934 M8	2
4	54606004000	PLUG 37MM	2
13	47003013000	ENGINE BRACKET SCREW 85 SX	2
14	54310086100	SELF LOCKING NUT M10 CU WS=14	2
34	58111076000	CABLE SUPPORT KHS NR.150-47610	2
36	0934080003	HEXAGON NUT DIN0934-M 8	2
37	59001037000	SPECIAL SCREW M8X26 WS=10	1
39	59003040050	FOOT PED L/S EXC SILVER 2000	1
40	59003041050	FOOT PED R/S EXC SILVER 2000	1
41	54603041000	FOOTREST SPRING L/S & R/S	2
42	0125100003	WASHER DIN0125-A10,5	2
43	0094032253	PIN DIN0094-3,2X25 STEEL	2
44	54803044000	BOLT FOR FOOT PED 03	2
45	4700304003390	FOOTPEG L.+R. CPL. 85 SX 03	1
51	0019080206S	FLAT HEAD SCREW M. ISA45 M8X20	2
52	0019080266S	COUNTER-SUNK SCREW ISA45 M8X26	2
53	51103053051	BUSHING 8,2X10X20	1
54	58711054050	METAMOLL FOR BATTERY BRACKET	2
67	51103053000	CHAIN SLIDING PIECE BELOW '97	1
68	36003014000	LOCK WASHER 8MM	2
70	0025080306	HH COLLAR SCREW M8X30 TX40	1
99*	51103053110	CHAIN SLIDING KIT BELOW MINI	1

C104700312

* NEW PART

X ON DEMAND

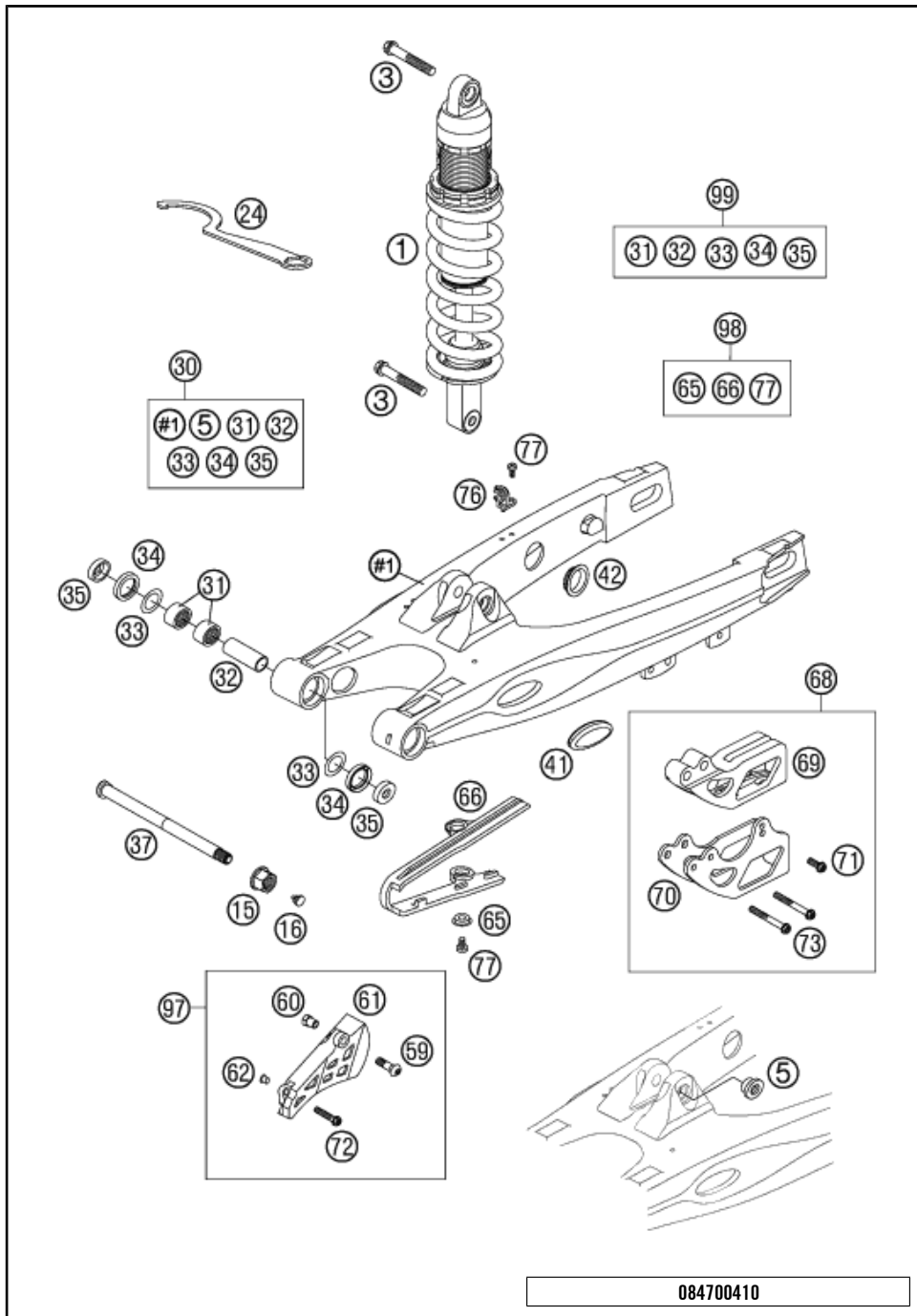

084700410

POS	PARTNUMBER	PARTNAME	PIECE
1	15187E02	MONOSHOCK 85 / 105 SX 2009	1
3	0015120556S	HH COLLAR M12X55 WS=13 06	2
5	50180105	THREADED BUSH M12 PDS	1
15	54603015000	SELF LOCKING NUT M14X1,5 WS=19	1
16	54403135000	PLASTIC CAP SFL10	1
24	46012024000	HOOK WRENCH FOR SHOCK ABSORBER	1
30	47004030144	SWINGARM 85SX CPL. 2004	1
31	59004031000	NEEDLE BUSH HK2012V	4
32	50203081700	BUSHING SLEEVE 15X20X38,75	2
33	59033080000	SHIM 20X32X1	2
34	0760253270	SHAFT SEAL RING 25X32X7	4
35	54603090000	BUCKET F.SHAFTSEALRING 15X25X9	4
37	47004037000	SWINGARM BOLT 85 SX 2003	1
41	58404041000	CLOSING COVER SWINGARM SM 03	2
42	58404041100	CLOSING COVER ROUND 03	4
59	0019080206	COUNTER-SUNK SCREW ISA45 M8X20	1
60	47030060051	THREADED BUSH FOR CHAIN GUARD	1
61	47007061000	CHAIN GUARD 85 SX 2003	1
62	58314060050	SPACER BUSH. F. SPEEDOMET.BRA.	1
65	72210079000	BUCKET	2
66	58404066000	CHAIN SLIDING GUARD SM 03	1
68	54607069000	CHAIN GUIDE KIT REAR CPL.	x
69	54607066100	CHAIN GUIDE REAR '94	1
70	54607070144	RETAINING PLATE CPL.	1
71	0025060166	HH COLLAR SCREW M6X16 TX30	1
72	0025060306	HH COLLAR SCREW M6X30 TX30	1
73	0025060506	HH COLLAR SCREW M6X50 TX30	2
76	54611076100	RETAIN.CLAMP FOR BRAKE HOSE'96	2
77	0009050103	% SPECIAL SCREW M 5,0X10	4
97	47007061010	SPROCKET COVER KIT	x
98*	58404066010	CHAIN GUARD KIT 105/85 SX	1
99*	47004230010	SWINGARM REP. KIT 105/85 SX	1

C104700411

* NEW PART

X ON DEMAND

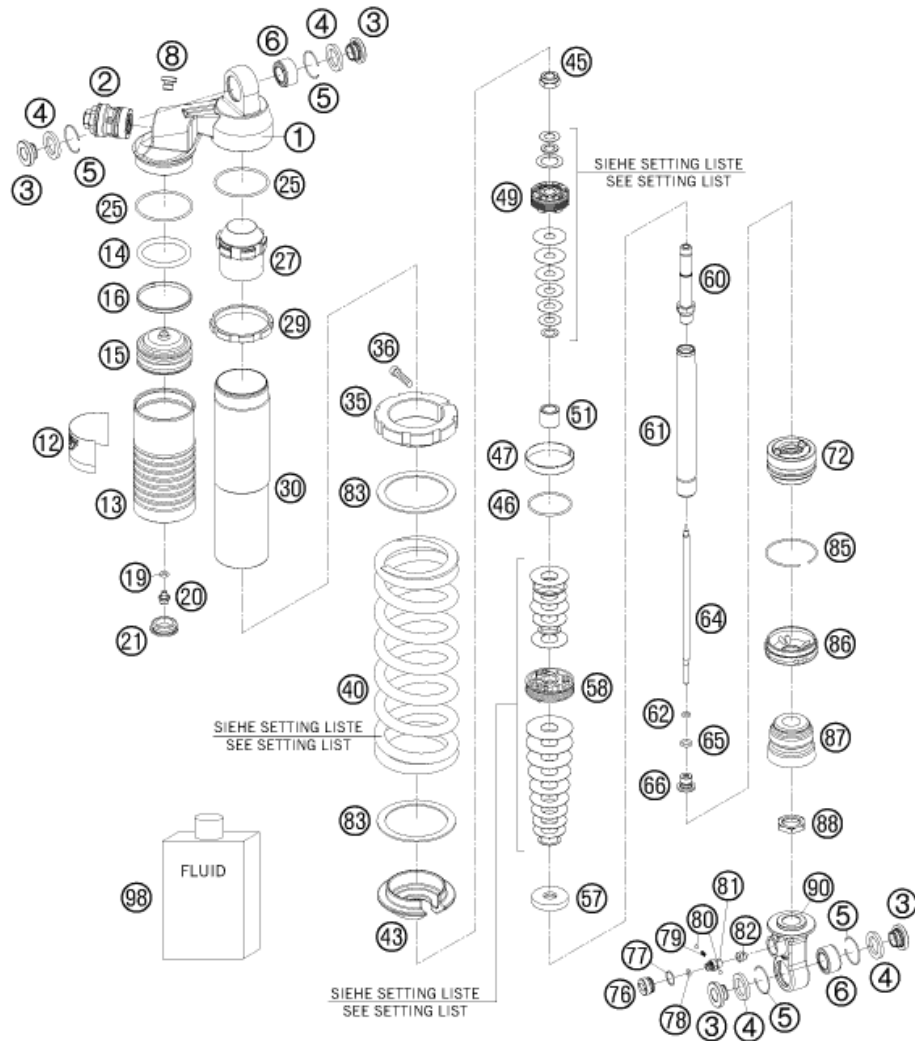

POS	PARTNUMBER	PARTNAME	PIECE
1	46180348	SHOCK ABSORBER TOP H40 135DEG.	1
2	50180213S10	DCC-COMPR.DAMP.CONTROL CPL. 07	1
3	46180007	ADAPTOR BUSH KGW 12X24	4
4	46180003	OIL SEAL KGW D=25	4
5	50180168	WASHER KGW D=25	4
6	50180005	BUSHING KGW 1525 HD	2
8	50180095	BLEED PLUG R 1/8	1
12	52000014	STICKER WP 35X55	1
13	50180522	RES. SCREW L=100 D=52 BLACK	1
14	46180014	O-RING VITON 41X5	1
15	46180002	SEPARATION PISTON D=52, H=32	1
16	46180015	PISTON RING 3,9X1,5X156	1
19	46810893	O-RING NBR 5,28X1,78	1
20	36120151	SCREW PLUG M5X6	1
21	46811208	RUBBER CAP "DO NOT OPEN"	1
25	46810016	O-RING NBR 48X2	2
27	46180340	SLEEVE D=48	1
29	46180352	LOCK WASHER M52X1,5	1
30	46180345	TUBE M52X1,5	1
35	46180353	SPRING RETAINER M52X1,5	1
36	0912050253	AH SCREW DIN0912-M 5X25	1
40	91010272	SPRING 215 30 N/MM D=9,00 ORAN	x
40	91010273	SPRING 215 35 N/MM D=9,25 ORAN	1
40	91010274S	SPRING 215 40 N/MM D=9,50 ORG	x
40	91010201	SPRING (59) 215 45 N/MM D=10	x
43	46180349	SPRING WASHER H=15 D=28	1
45	46180356	PISTON ROD NUT M10X1	1
46	46810035	O-RING VITON 37,82X1,78	1
47	46811206	PISTON RING 8X46	1
49	14460016	PISTON + PISTON SPRING	1
51	46180339	SEPARATION BUSH 17X12X18	1
57	46180179	REBOUND DISC H=0	x
57	46180337	REBOUND DISC H=4	1
58	46180441	PISTON 5X4,5X/6X6	1
60	46180343	TAP PISTON ROD D=13,5	1
61	46180342S	SPINDEL D=18 LC=159 CPL.	1
62	50180397	O-RING VITON 5X1,5	1
64	46180346	NEEDLE REBOUND L=169	1

084700430

C094700430

* NEW PART X ON DEMAND

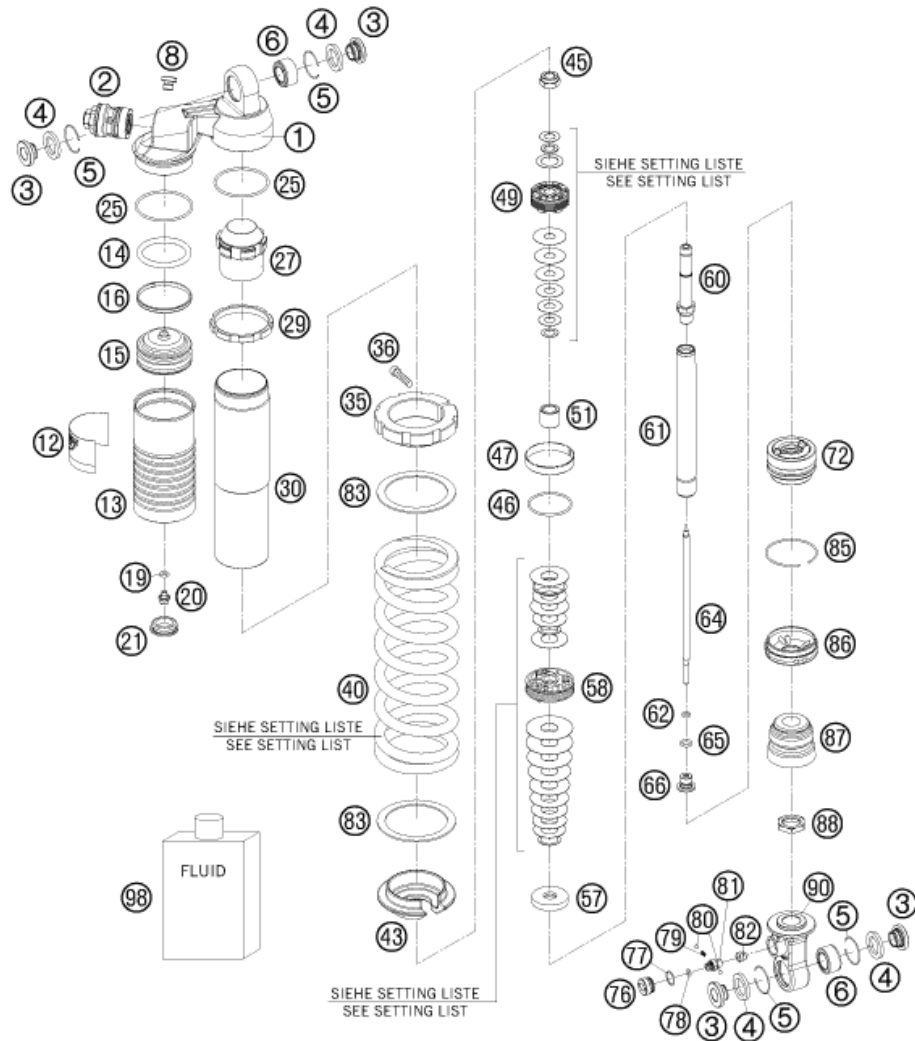

POS	PARTNUMBER	PARTNAME	PIECE
65	46180018	O-RING NBR 7,5X2	1
66	46180350	NEEDLE GUIDE	1
72	46180669S	ADAPTOR CPL. D=46 H=28 07	1
76	46180355	% RESERVOIR CAP M16X1	1
77	46180013	O-RING NBR 12X1	1
78	50180222	O-RING NBR 4X1,5	1
79	48600028	SPRING D=2,9 L=7,9	1
80	40540603	STEEL BALL D=3MM	2
81	46180006	ADJUSTING SCREW L=15,5	1
82	46180016	ADJUSTING ADAPTOR REBOUND	1
83	50180410	INTERM.RING D=58	2
85	46810010	CIRCLIP 49X1,5	1
86	46180338	CAP D=46 H=9,5	1
87	50180276	BUMP RUBBER WP60 D=18-26	1
88	50180283	CONTRA NUT M18X1 H=5	1
90	46180347	SHOCK ABSORBER BOT. KGW L=54,5	1
98	50180342S1	%SHOCK ABSORBER FLUID 5 LT '03	1

084700430

C094700430

* NEW PART X ON DEMAND

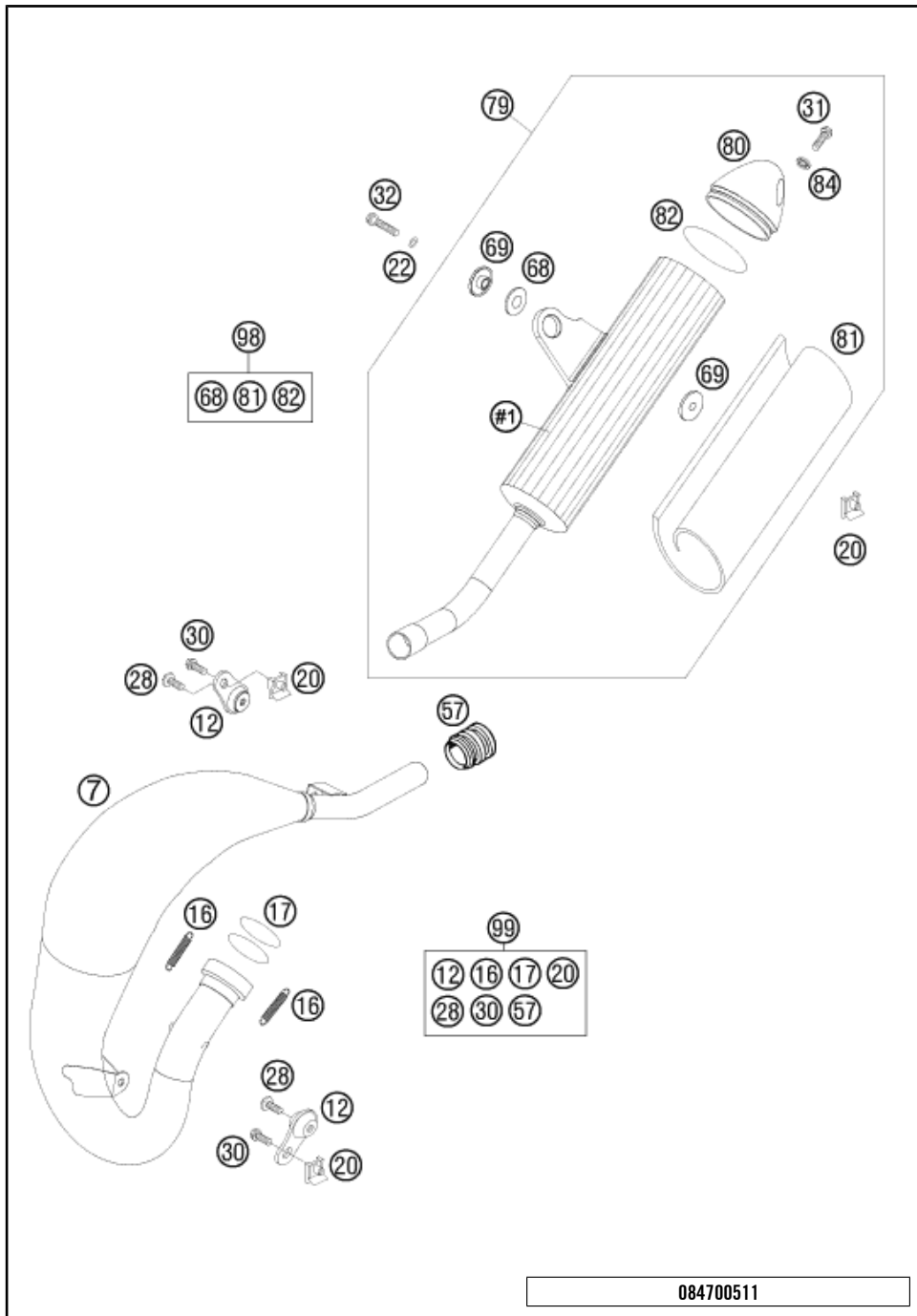

POS	PARTNUMBER	PARTNAME	PIECE
7	47005007100	EXHAUST PIPE 85 SX 07	1
12	50305012000	SWINGELEMENT FOR EXHAUST PIPE	2
16	50305016000	TEN.SPRING L=62MM EY.MOVEABLE	2
17	0770380030	O-RING 38,00X3,00 VITON	2
20	54603048100	RANGE CHANGE METAL NUT M6	3
22	0137060003	SPRING WASHER DIN0137-B 6	1
28	0024060106	HH COLLAR SCREW M6X10 TX30	2
30	0025060166	HH COLLAR SCREW M6X16 TX30	2
31	0025060206	HH COLLAR SCREW M6X20 TX30	2
32	0025060306	HH COLLAR SCREW M6X30 TX30	1
57	54605057000	RUBBER SLEEVE D=21MM/23MM '93	1
68	54605068000	EXHAUST BRACKET RUBBER BLACK	1
69	54605069000	BUSHING 7,5X12X28X7,8 '96	2
79	47005079100	SILENCER 85 SX 06	1
80	50305079169	SILENCER ENDCAP SX REAR	1
81	50305079160	STUFFING YARN 160 GRAM	1
82	0770055020	O-RING 55,00X2,00 NBR70	2
84	50233041000	PAIR OF WASHERS M 6 NORDLOCK	2
98	00050000804	SILENCER REP. KIT 160 GRAM	1
99	00050000812	EXHAUST HARDWARE KIT MINI	1

084700511

C094700511

* NEW PART X ON DEMAND

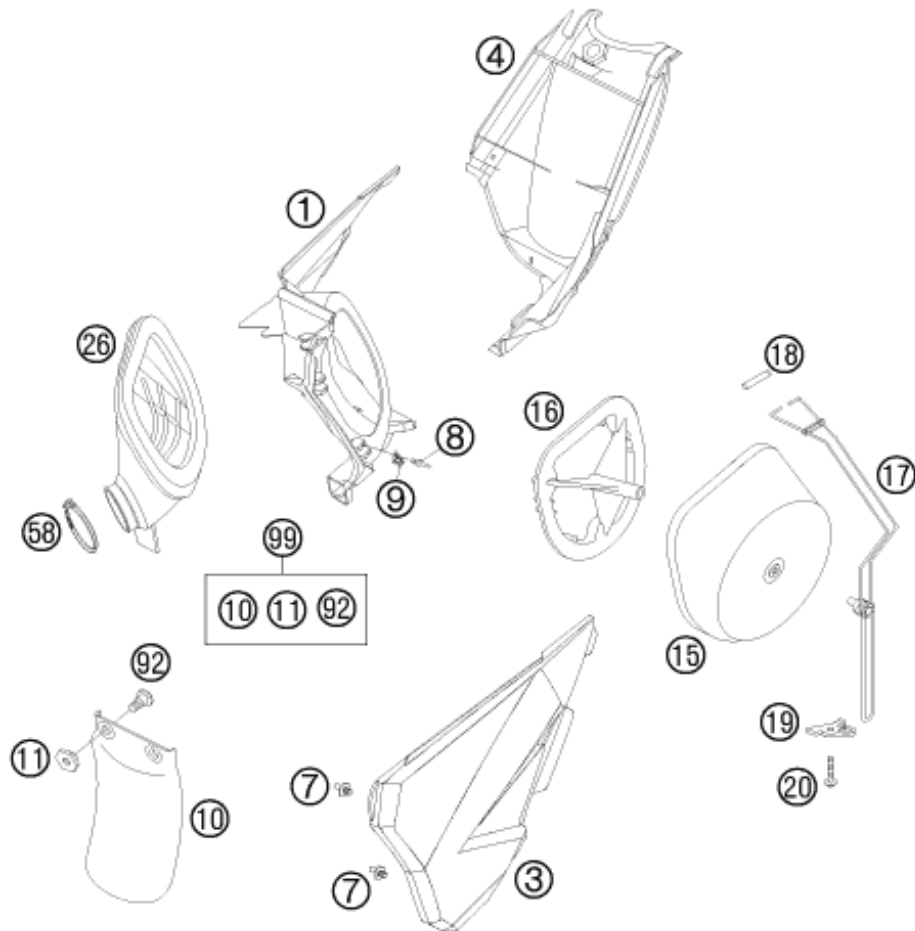

POS	PARTNUMBER	PARTNAME	PIECE
1	47006001051	FILTER WALL 85 SX 2003	1
3	47006003000	FILTER BOX COVER 85 SX 2003	1
4	47006001052	REAR PART FILTER BOX 85 SX 03	1
7	54806008051	QUICK RELEASE-NIPPLE 03	2
8	54806108052	BLIND RIVET 3,3X9,7 GROOVED 04	4
9	54806008050	QUICK RELEASE-SPRING HANGER	2
10	46006010000	SPLASH PROTECTOR 60/65 SX '98	1
11	47006010050	SCREW CONNECTION SPLASH SHIELD	2
15	59006015000	AIR FILTER RACING 2001	1
16	54806016000	FILTER CARRIER 2-STROKE 04	1
17	50306017000	FILTER SUPPORT CPL.2-STROKE'98	1
18	50306018000	FILTER SUPPORT BUSH 125-380'98	1
19	47006019000	FASTEN. DEVICE FILTER SUPPORT	1
20	0017060203	EJOT PT SCREW K6X20 WS=6	1
26	47006026000	CARB. CONNECTING BOOT 85 SX 03	1
58	78006027000	HOSE CLAMP 45-65MM	1
92	59001092050	SPECIAL SCREW M6X12,5 WS=8	2
99	46006010010	SPLASH PROTECTOR KIT 85/65	1

084700612

C104700612

* NEW PART

X ON DEMAND

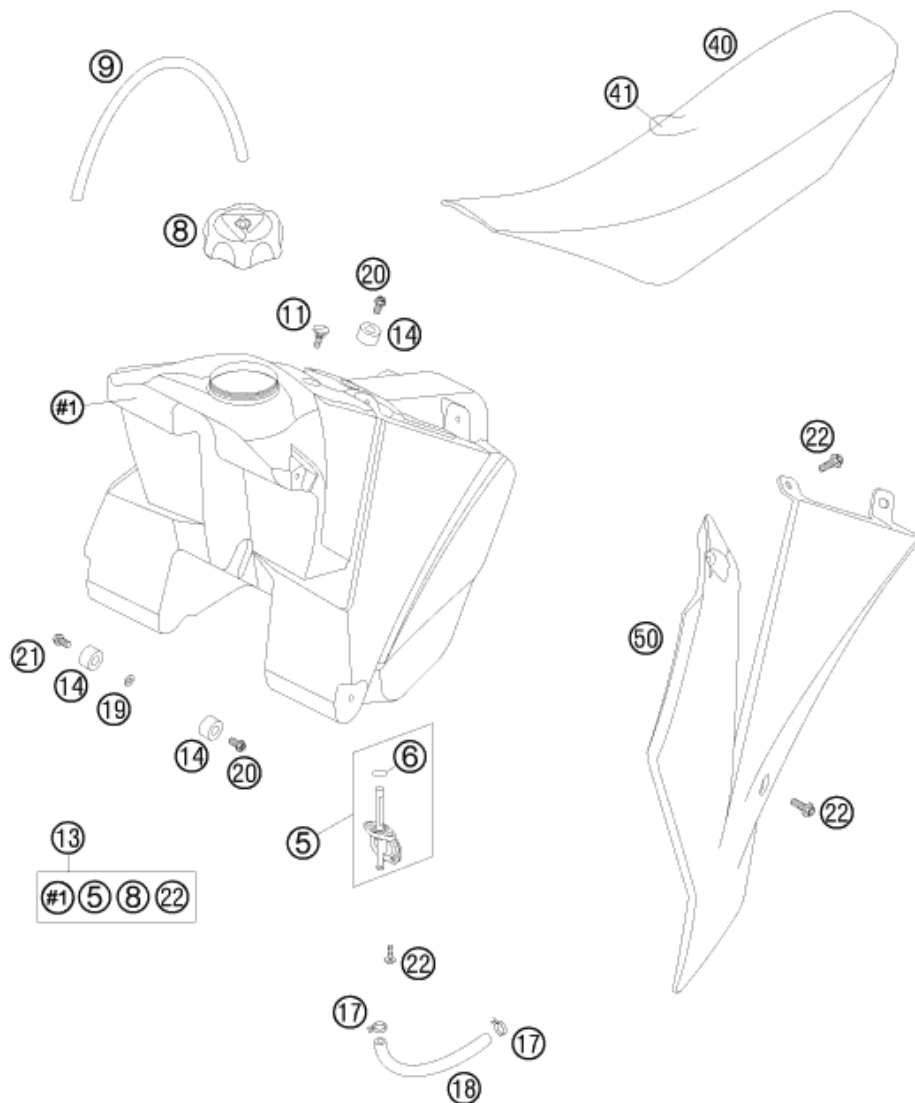

POS	PARTNUMBER	PARTNAME	PIECE
5	50307005000	GAS COCK MIKUNI ON/OFF 2001	1
6	0770130023	O-RING 13,00X2,30	1
8	49007008044	FILLER CAP CPL. SMALL	1
9	50332095200	TUBE RUBBER 6X9 DVOH 200MM	1
11	50307011000	SCREW SEAT FASTENING D=6X23/18	1
13	4700701300030	FUEL TANK 85 SX 07	1
14	50307014000	TANK ROLLER 12X26X12 '98	3
17	45031005000	YDNAC-CLAMP FUEL HOSE (8MM)	2
18	58307016001	FUEL HOSE VITON 6X1,5 PER/M	0
19	12011016000	WASHER 6 X 12 X 3	1
20	0025060126	HH COLLAR SCREW M6X12 TX30	2
21	0025060166	HH COLLAR SCREW M6X16 TX30	1
22	0017060203	EJOT PT SCREW K60X20 WS=6	10
40	47007040100	SEAT 85 SX 2005	1
41	47007040150	SEAT COVER 85 SX 2005	1
50	47008054300X4	SPOILER LS/RS 85/105 ORANGE	1

084700710

C114700710

* NEW PART

X ON DEMAND

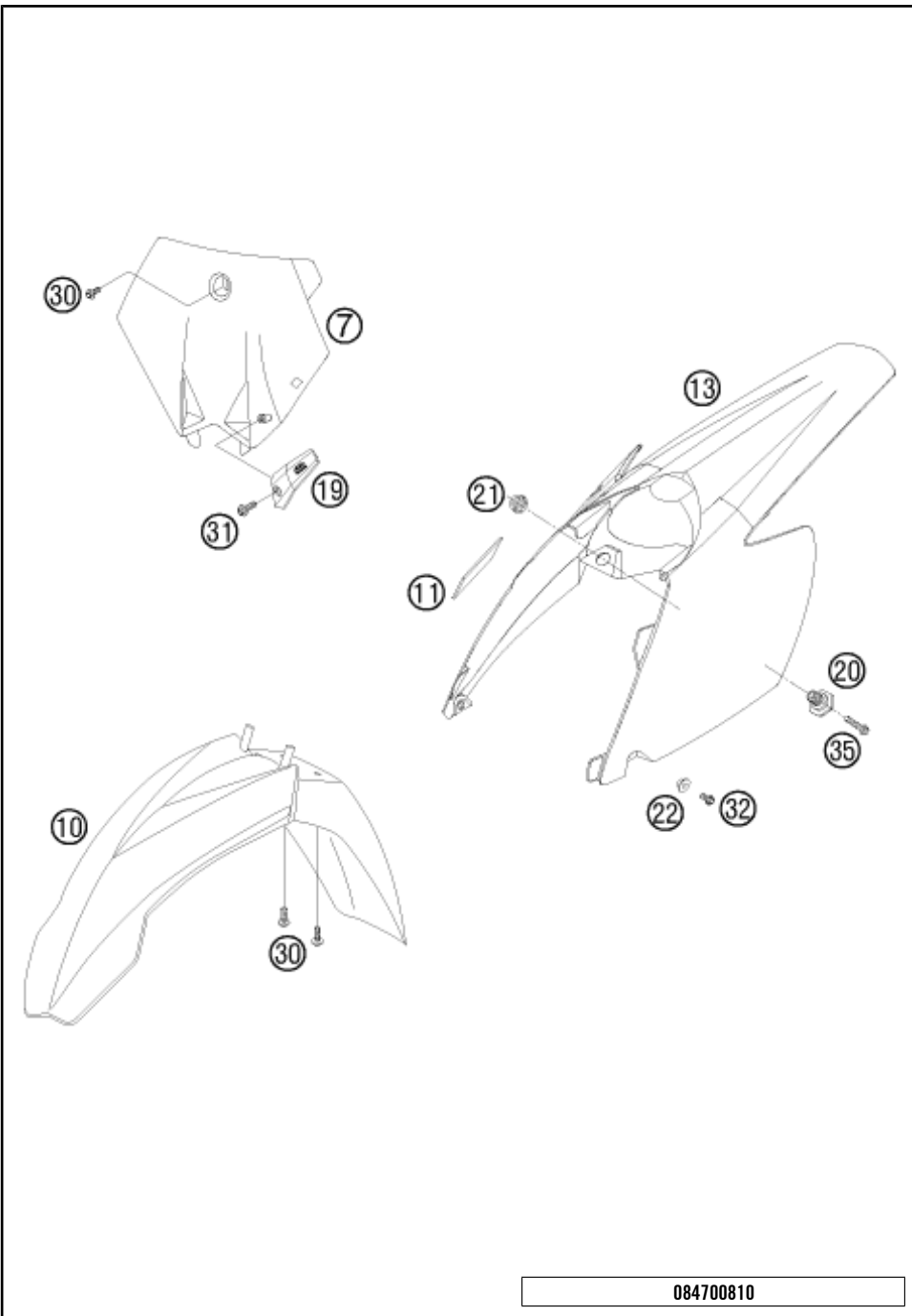

POS	PARTNUMBER	PARTNAME	PIECE
7*	4700800700028	START NUMBER PLATE	1
10	47008010000X4	FENDER FRONT 85 SX	1
11	59003001099	METAMOLL 90X45X3MM 03	1
13*	4700801300028	REAR PART	1
19	54808019100	BRAKE HOSE GUIDE	1
20	54807048000	BUSHING FOR SEAT FASTENING 03	1
21	50314057050	COLLAR NUT M12X1/WS17 H=5MM	1
22	50308052000	BUSH FOR SPOILER 6X11X16X5 MM	2
30	0024060156	HH COLLAR SCREW M6X15 TX30	5
31	0017060203	EJOT PT SCREW K60X20 WS=6	1
32	0025060166	HH COLLAR SCREW M6X16 TX30	2
35	0025060256	HH COLLAR SCREW M6X25 TX30	1

084700810

C114700810

* NEW PART X ON DEMAND

POS	PARTNUMBER	PARTNAME	PIECE
1*	47008199000	DECAL SET 85 SX 2011	1

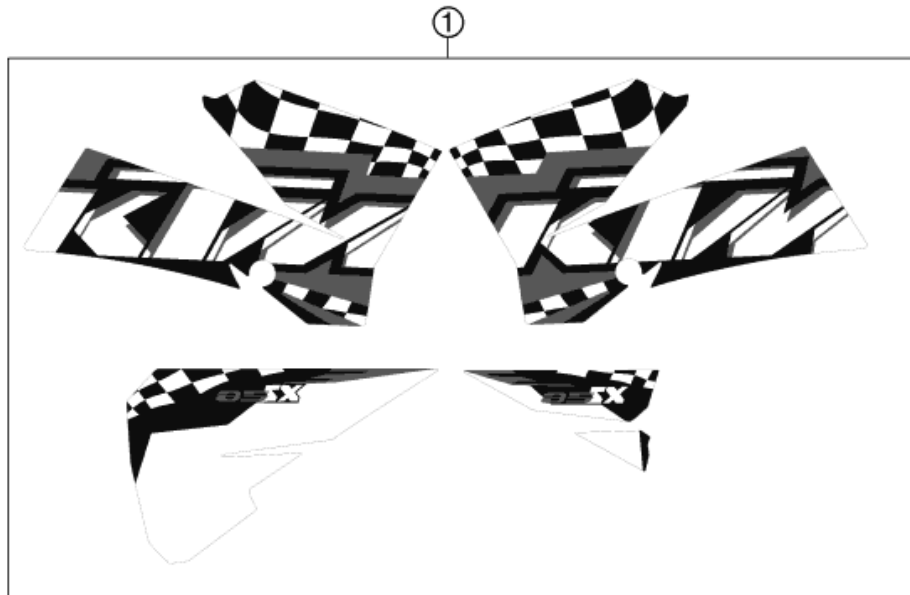

114700830

C114700830

* NEW PART

X ON DEMAND

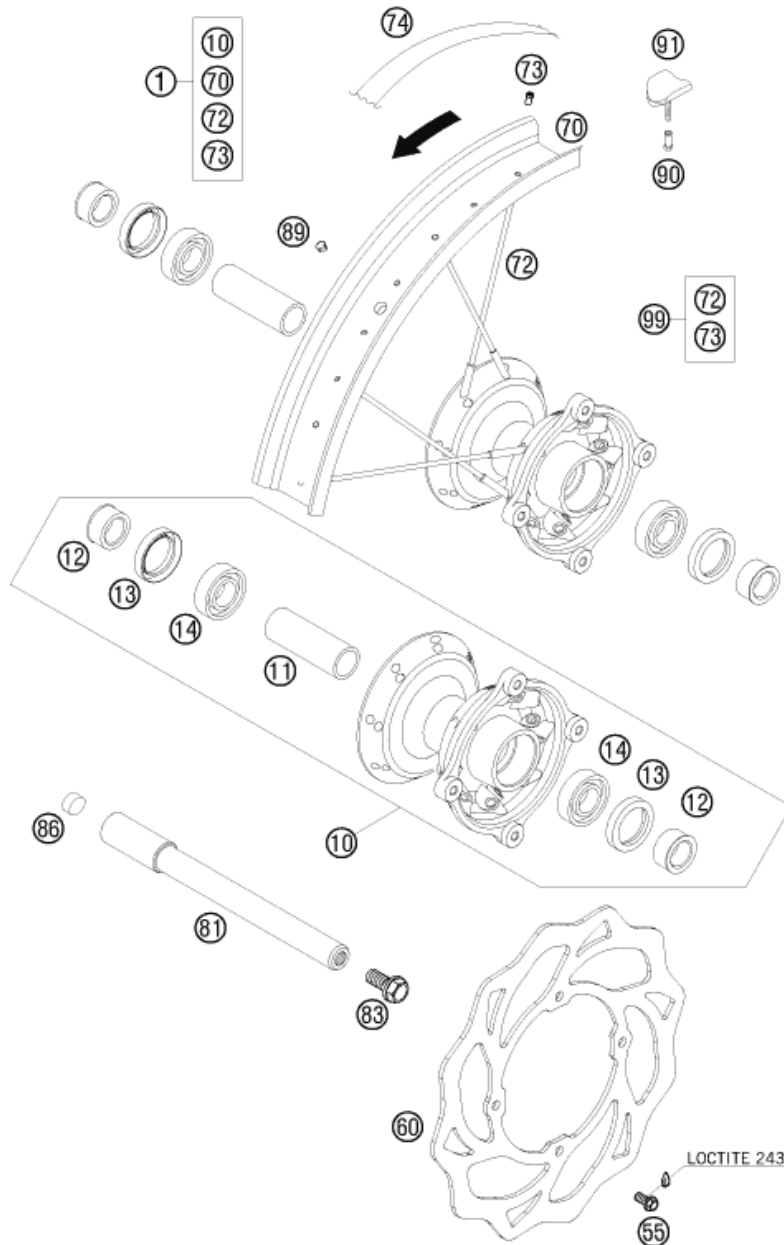

POS	PARTNUMBER	PARTNAME	PIECE
1	47009001344	FRONT WHEEL ET 85 SX 19" 06	1
10	4700901004491	FRONT WHEEL HUB CPL. 85 SX 06	1
11	47009011000	BEARING SPACER TUBE 85 SX 03	1
12	47009012000	SPACER BUSHING 85 SX 03	2
13	0760253572	% SEAL SHAFT RING 25X35X7 BSL	2
14	0625060037	GR.BALL BEAR. 6003-2RSH/C3HMTF	2
55	59009062013	SPECIAL SCREW M6X13 WS=8 10.9	4
60	47009060300	BRAKE DISC FRONT D=219MM 09	1
70	47009070100	RIM FRONT AL4 19X1,60-32 03	1
72	47009074210	% SPOKE FRT 19" 4/3,5/4-210 07	32
73	50309072100	SPOKE NIPPLE M4,5X0,75 8X21	32
74	47009073100	RIM BAND 85 SX 19" 2003	1
81	47009081000	AXLE FRONT 85 SX 03	1
83	49032011000	HH COLLAR SCREW M10X20 WS=17	1
86	55009086000	PLUG SFL13	1
89	55003135000	PLUG FOR RIM	x
90	50310090050	NUT FOR WHEEL HOLDER '96	1
91	51009100100	RIM LOCK VM1 (1,60")	1
99	00050000910	SPOKE KIT FRONT "19"	x

084700910

C104700910

* NEW PART

X ON DEMAND

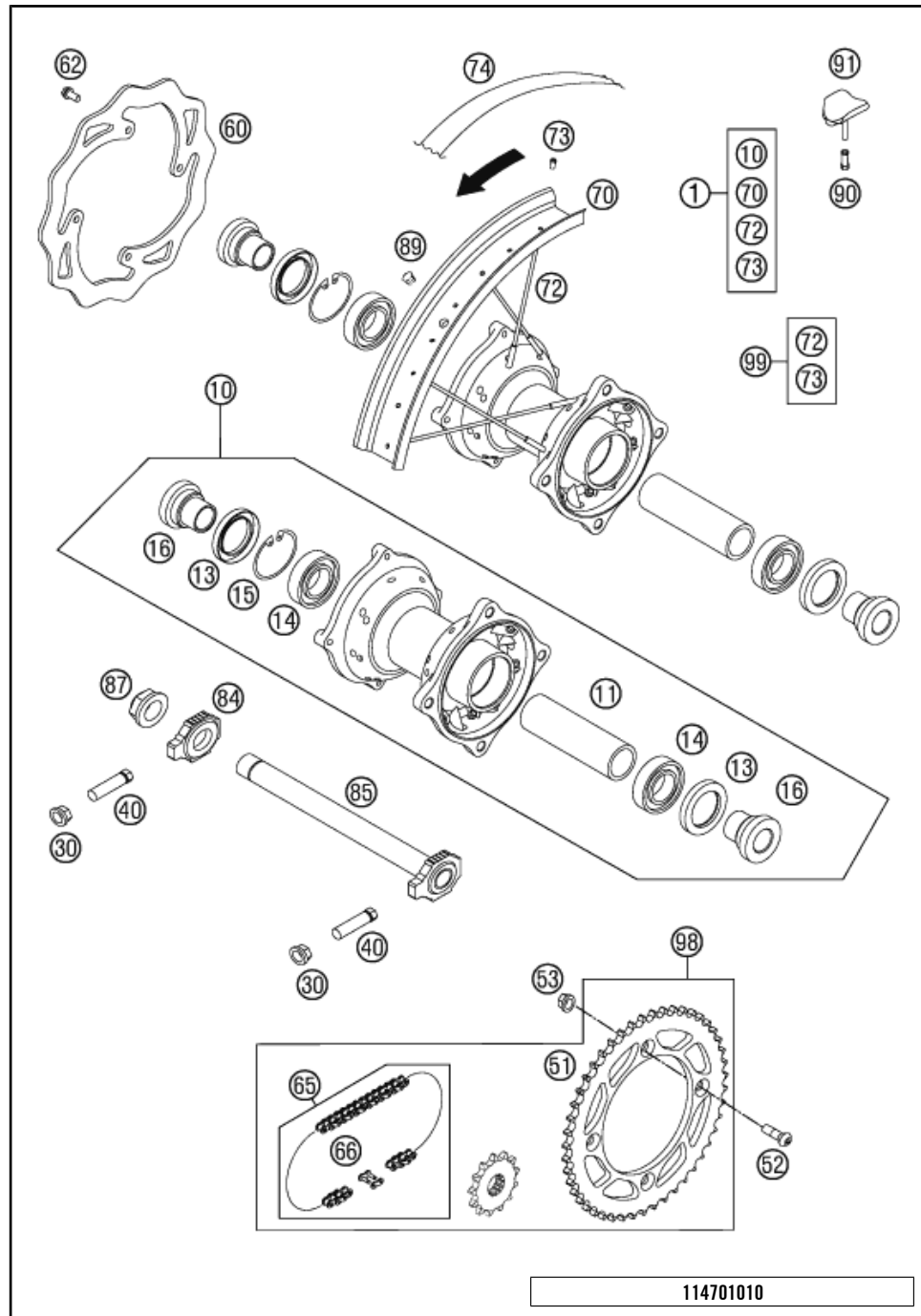

POS	PARTNUMBER	PARTNAME	PIECE
1	47010001544	% REAR WHEEL SP 85 SX 16" 06	1
10	4701001004491	REAR WHEEL HUB CPL. 85 SX 06	1
11	47010011000	BEARING SPACER TUBE 85 SX 03	1
13	0760324771	SHAFT SEAL RING 32X47X7 BSL	2
14	0625060058	GR.BALL BEAR.6005 DDU2CG23S6NM	2
15	0472047175	CIRCLIP DIN0472-47X1,75	1
16	54610016000	% BUSHING FOR HUB	2
30	58414030000	HH COLLAR NUT M10X1,25 WS=13	2
40	50304040100	SCREW M10X1,25X50 WS=10	2
51	47010051044	REAR SPROCKET 44-T 85 SX 03	x
51	47010051045	REAR SPROCKET 45-T 85 SX 03	x
51	47010051046	REAR SPROCKET 46-T 85 SX 03	x
51	47010051047	REAR SPROCKET 47-T 85 SX 03	x
51	47010051048	REAR SPROCKET 48-T 85 SX 03	x
51	47010051049	REAR SPROCKET 49-T 85 SX 03	1
51	47010051050	REAR SPROCKET 50-T 85 SX 03	x
51	47010051051	REAR SPROCKET 51-T 85 SX 06	x
52	0019080266S	COUNTER-SUNK SCREW ISA45 M8X26	4
53	54310086200	SELF LOCKING NUT M8 10.9	4
60*	47010060500	REAR BRAKE DISC	1
62	59009062016	SPECIAL SCREW M6X16 WS=8 10.9	4
65	47010165124	CHAIN 124 ROLLS 85 SX	1
66	47010166000	CONNECTING LINK 85 SX	1
70	47010070200	RIM REAR AL4 16X1,85-32 03	1
72	47010074171	SPOKE REAR 16"4/3,5/4-171 07	32
73	50309072100	SPOKE NIPPLE M4,5X0,75 8X21	32
74	47010073200	RIM BAND 85 SX 16" 2003	1
84	50310084000	CHAIN TENSIONER R/S 2000	1
85	47010085044	AXLE REAR CPL. 85 SX 2003	1
87	50310099000	HEXAGON NUT M20X1,5 '98	1
89	55003135000	PLUG FOR RIM	x
90	50310090050	NUT FOR WHEEL HOLDER '96	1
91	51010100100	RIM LOCK VM2 (1,85") MX	1
98*	00050002003	DRIVETRAIN KIT 105 SX 14T/49T	1
99	00050000909	SPOKE KIT REAR "16"	x

114701010

C114701010

* NEW PART X ON DEMAND

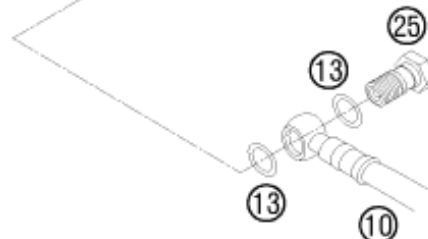
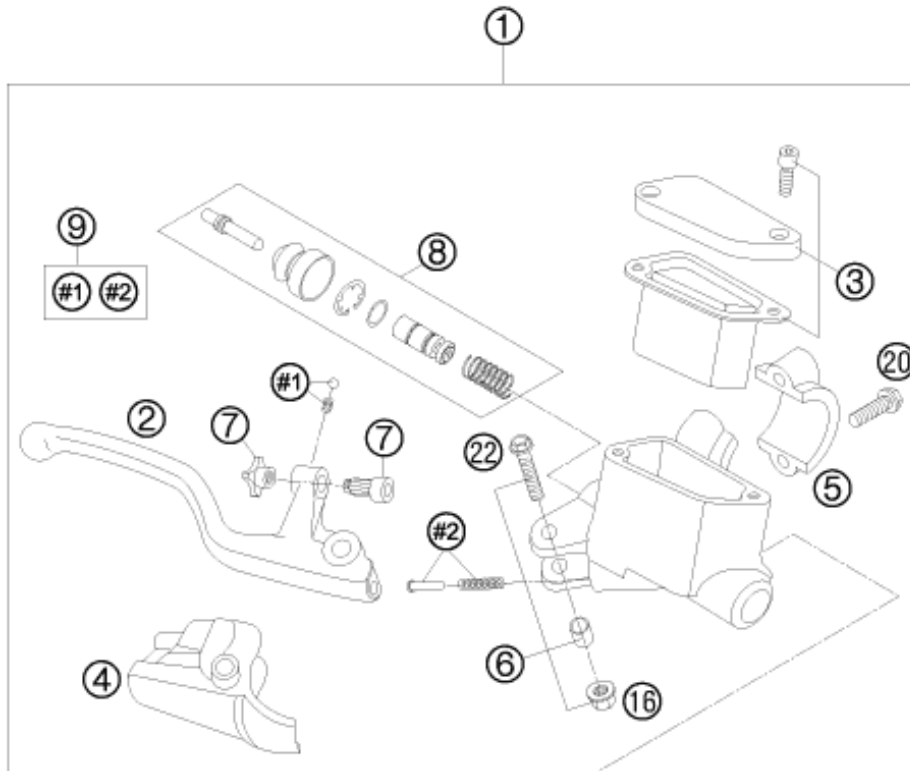

POS	PARTNUMBER	PARTNAME	PIECE
1	47013001100	H.BRAKE CYL. CPL. 9,5MM CPL.05	1
2	47013002000	BRAKE LEVER LOOSE 85 SX 2003	1
3	47013003000	CYLINDER COVER CPL. FRONT 2003	1
4	47013004000	PROTECTION COVER 85 SX 2003	1
5	47013005000	CLAMP FOR BRAKE CYLINDER 2003	1
6	47013006000	SCREW+BUSHING+NUT 03	1
7	47013007000	ADJUSTING SCREW CPL. 85 SX 03	1
8	47013008100	REP.SET PISTON FRONT D=9,5MM	1
9	47013009000	BALL+SPRING+SPRING GUIDE 03	1
10	47013010000	% BRAKE HOSE FRONT 85 SX 03	1
13	0770080019	O-RING 8,00X1,00 FORMULA	2
16	56509064100	SELF LOCKING NUT M6 10.9	1
20	0025060206	HH COLLAR SCREW M6X20 TX30	2
22	0025060306	HH COLLAR SCREW M6X30 TX30	1
25	47013025000	HOLLOW SCREW BRAKE CYLINDER 03	1
80	00062030000	BRAKE FLUID DOT5.1 0,25L	1

094701310

C094701310

* NEW PART

X ON DEMAND

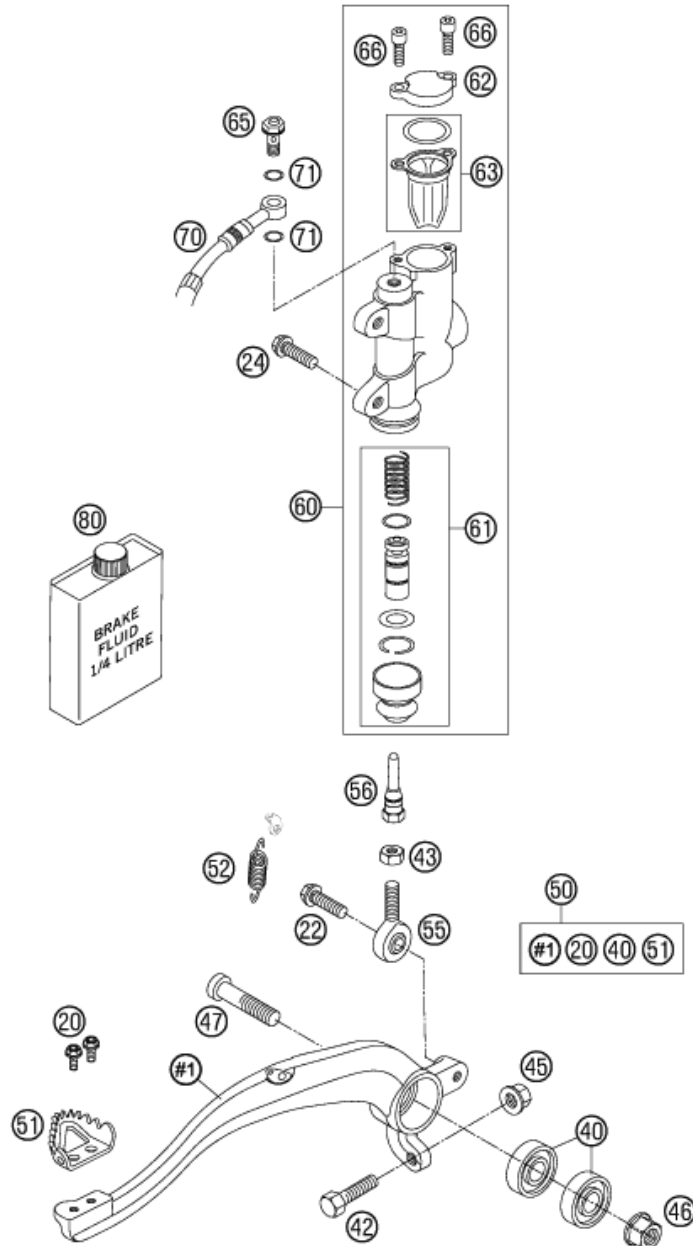

084701330

POS	PARTNUMBER	PARTNAME	PIECE
20	0025050126	HH COLLAR SCREW M5X12 TX30	2
22	0025060206	HH COLLAR SCREW M6X20 TX30	1
24	0025060126	HH COLLAR SCREW M6X12 TX30	2
40	0625060002	BALL BEARING SKF 6000-2RS1	2
42	59001037000	SPECIAL SCREW M8X26 WS=10	1
43	0934060003	HEXAGON NUT DIN0934-M 6	1
45	46030045000	COLLAR NUT M8 WS=10	1
46	54630044000	COLLAR NUT M10 WS=13	1
47*	0032100406S	AH-COLLAR SCREW M10X40 ISA45	1
50	47013050044	FOOT BRAKE LEVER CPL. 85 SX 03	1
51	54813051000	STEP PLATE FOR BRAKE LEVER	1
52	54603062000	RETURN SPRING FOR BRAKE LEVER	1
55	54813055000	SWIVEL HEAD KA6 03	1
56	47013056100	PRESSURE ROD 85 SX 06	1
60	47013060200	FOOT BRAKE CYL.R. CPL. D=11 05	x
60	47013060300	FOOT BRAKE CYL.R. CPL. D=12 05	1
61	47013061000	REP. SET PISTON REAR D=11 2003	x
61	47013061100	REP. SET PISTON REAR D=12 2004	1
62	47013062000	CYLINDER COVER REAR 85 SX 03	1
63	47013063000	GASKET CYLINDER COVER REAR 03	1
65	47013025000	HOLLOW SCREW BRAKE CYLINDER 03	1
66	0912040103	AH.SCREW DIN0912-M 4X10	2
70	47013070000	BRAKE HOSE REAR 85 SX 03	1
71	0770080019	O-RING 8,00X1,00 FORMULA	2
80	00062030000	BRAKE FLUID DOT5.1 0,25L	1

C114701330

* NEW PART

X ON DEMAND

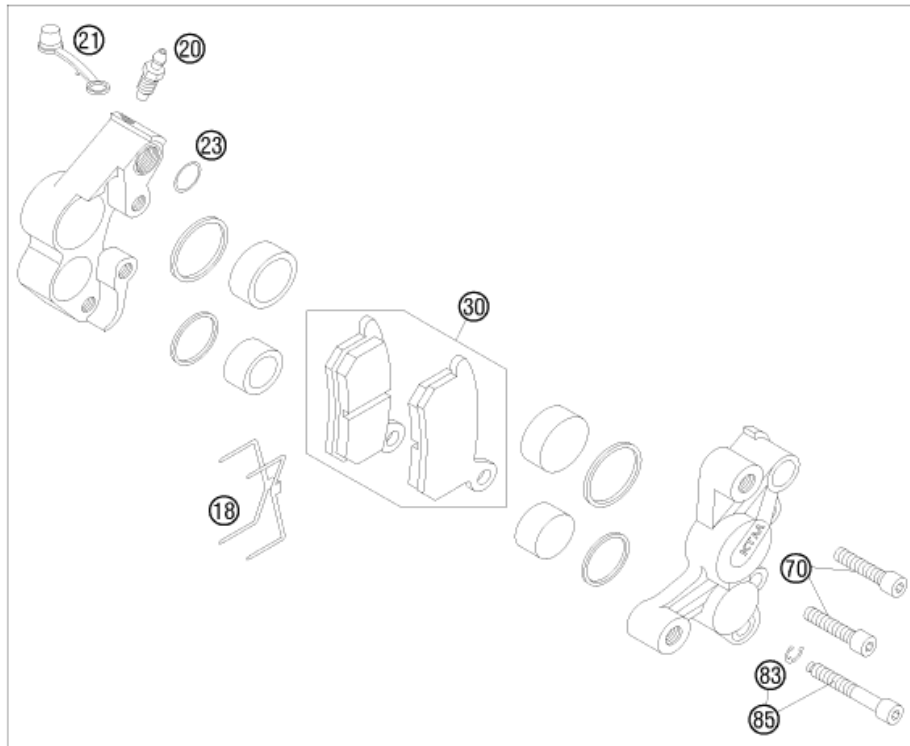

POS	PARTNUMBER	PARTNAME	PIECE
10*	47013010100	HOSE-BRAKE 85 SX 2012	1
11	0770080019	O-RING 8,00X1,00 FORMULA	2
14	46113019050	REPAIR KIT BRAKEPISTON	1
15	47013015000	%BRAKE CALIPER FR CPL.85 SX 03	1
18	46113018000	RETAINING SPRING 65 SX	1
20	47013020000	BLEEDER SCREW M6	1
21	47013021000	CAP FOR BLEEDER SCREW	1
23	0770100019	O-RING 10X1 EPDM	1
25	47013125000	HOLLOW SCREW M8X38,8	1
30	46113030000	BRAKE PAD SET FRONT 2002	1
70	0912060283	AH SCREW DIN0912-M 6X28	2
75	0025080306	HH COLLAR SCREW M8X30 TX40	2
81	46113019000	REPAIR KIT SEAL RING 2002	1
83	0799040009	TAB WASHER DIN6799-RA 4,0	1
85	46113125000	AH SCREW + CIRCLIP 2002	1

084701360

C094701360

* NEW PART

X ON DEMAND

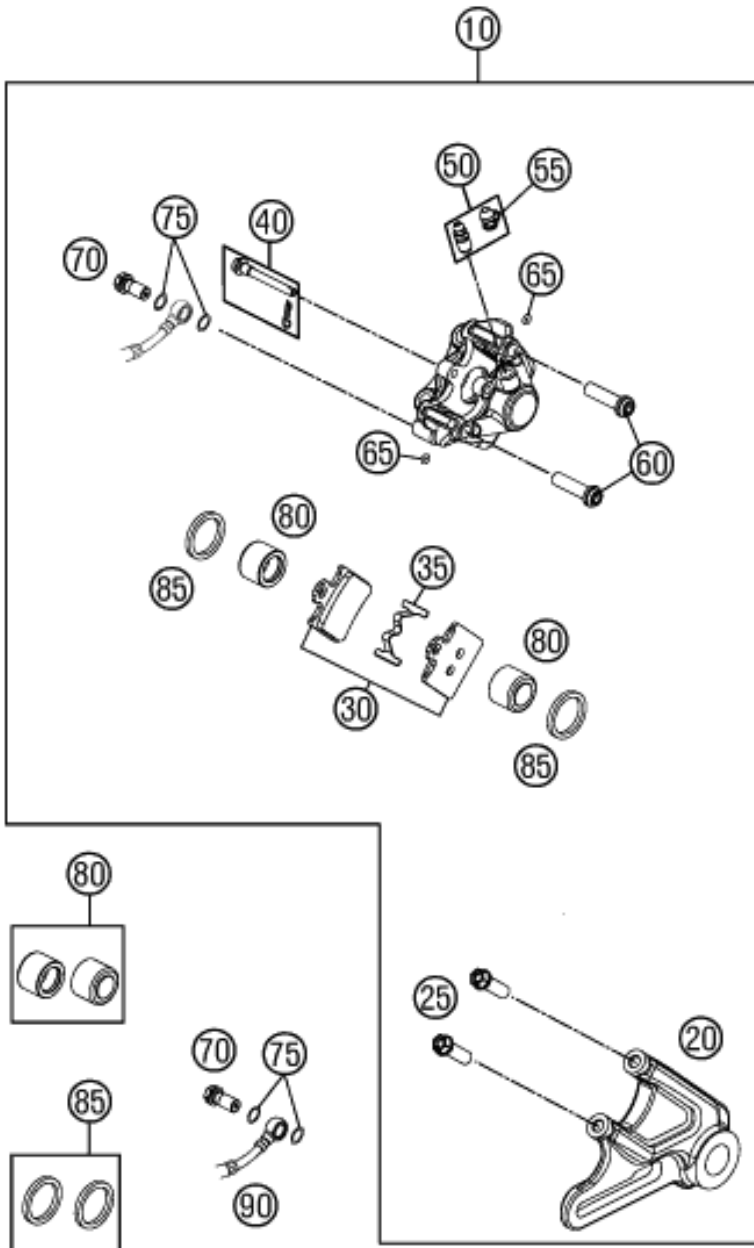

POS	PARTNUMBER	PARTNAME	PIECE
10*	47013080300	BREAK CALIPER REAR CPL. 2011	1
20*	47013075000	BRAKE CALIPER SUPPORT CPL.	1
25	0025080256	HH COLLAR SCREW M8X25 TX40	2
30*	47013090300	BRAKE PADS REAR 85 SX 2011	1
35*	47013018000	RETAINING SPRING 85 SX 2011	1
40*	47013092000	SPECIAL SCREW WITH SPLINT PIN	1
50	47013085000	BLEEDER SCREW M8X1	1
55	47013021000	CAP FOR BLEEDER SCREW	1
60*	47013084000	SPECIAL SCREW CALIPER M8X30	2
65*	07700257178	O-RING 2,57X1,78	2
70	47013025000	HOLLOW SCREW BRAKE CYLINDER 03	1
75	0770080019	O-RING 8,00X1,00 FORMULA	2
80*	47013083200	REPAIR KIT BRAKEPISTON 2011	1
85*	47013081100	REP. KIT SEAL. RINGS REAR 2011	2
90	47013070000	BRAKE HOSE REAR 85 SX 03	1

114701390

C114701390

* NEW PART

X ON DEMAND

①
OHNE ABBILDUNG
WITHOUT ILLUSTRATION

①
TECHNISCHE DOKUMENTATION
TECHNICAL DOCUMENTATION
DOCUMENTACION TECNICA
DOCUMENTATION TECHNIQUE
NOTE TECNICHE

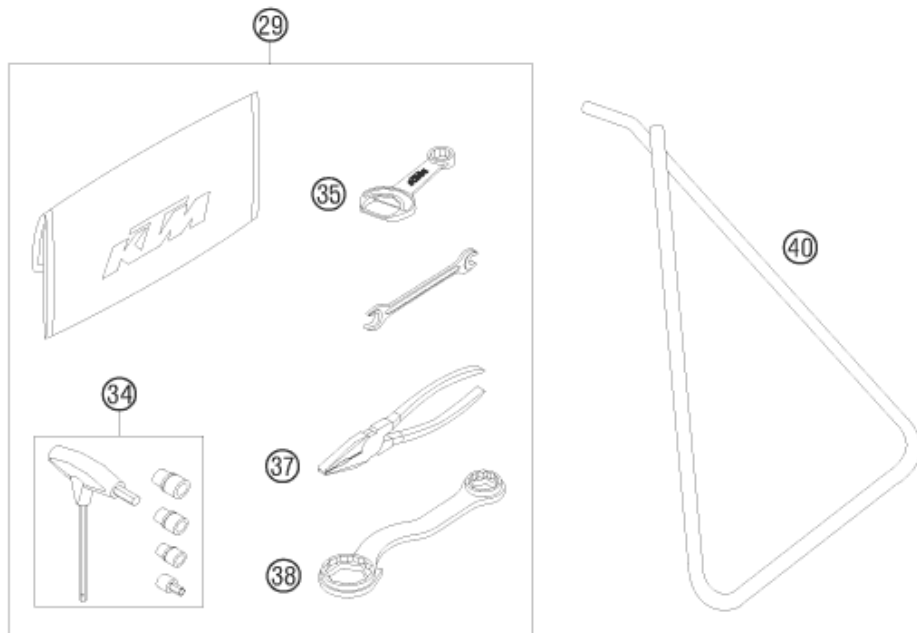

POS	PARTNUMBER	PARTNAME	PIECE
0	3210039	* CUSTOMER WELCOME LETTER	1
0	4700801000004	% FRONT FENDER 85 SX 2003	1
0	46012024000	HOOK WRENCH FOR SHOCK ABSORBER	1
0	312313	KTM BALLPOINT PEN ORANGE	1
0	312305	DOCUMENTS BAG 2006	1
1	3CF6001K9EN	SPC CHASSIS 85 SX 2011	1
1	3CM080404KEN	SPC ENGINE 85 SX 2011	1
1	3211595EN	OWN.MAN. 85-105 SX 2011	1
1	322000	SAFETY BROCHURES SPORTMINICYC.	1
29	54829099000	% ORIGINAL EQUIPMENT TOOL KIT	1
34	60029070200	% T-WRENCH WS=6/8/10 TX=45 B&F	1
35	50329071100	WRENCH WS=13 B&F + OPENER	1
37	53012028200	GRIP ORANGE B&F	1
38	50329080100	WRENCH SW=17/21/27/32 B&F	1
40	47003020000	PLUG IN STAND SX 85 2003	1

084702013

C114702010

* NEW PART

X ON DEMAND







WWW.KTM.COM



KTM-Sportmotorcycle AG
5230 Mattighofen, Austria
www.ktm.com



KTM_POWERPARTS

KTM_POWERWEAR

KTM_ORIGINAL SPARE PARTS



3CF 6001K9EN

Art. Nr.: 3CF 6001K9EN 10. Jun 2013