

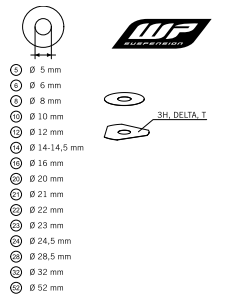

# 450 EXC SIX DAYS EU 2010

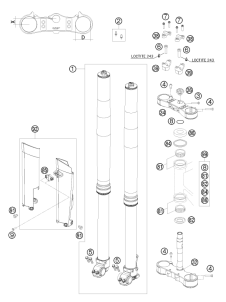

ART.-NR.: 3CF 8403J2EN

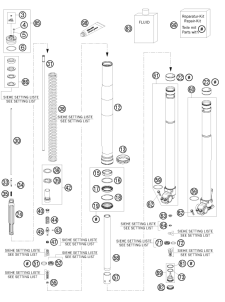
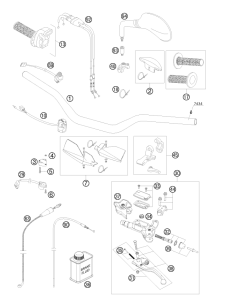
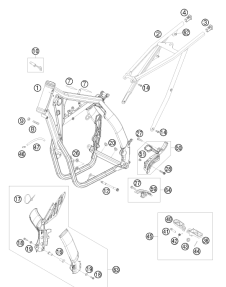
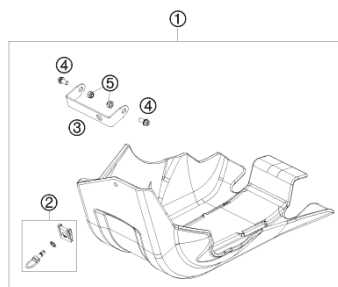
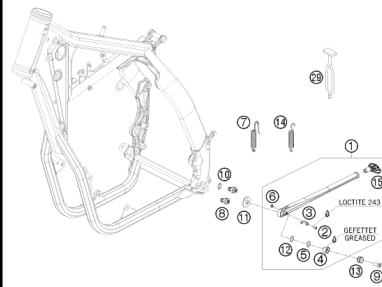
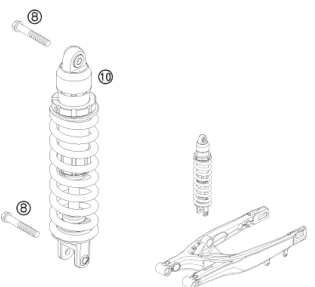
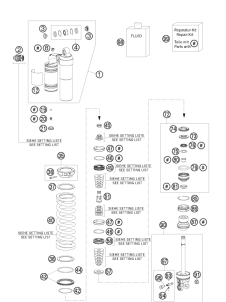
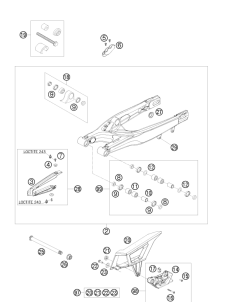
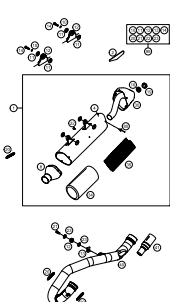
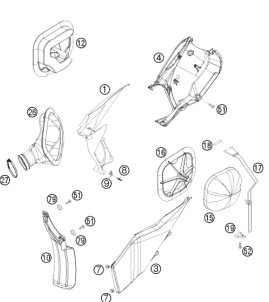

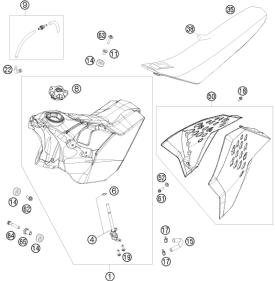
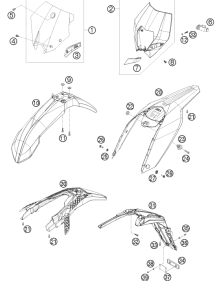

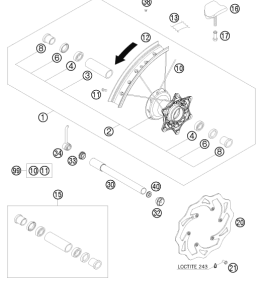
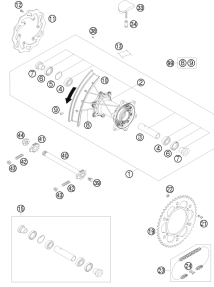
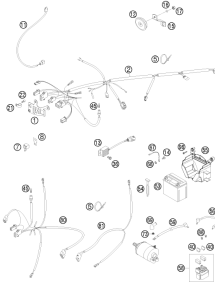
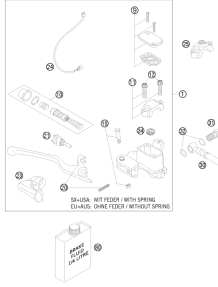
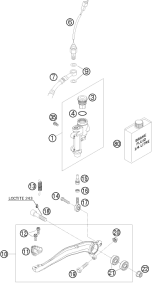
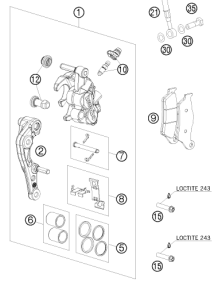
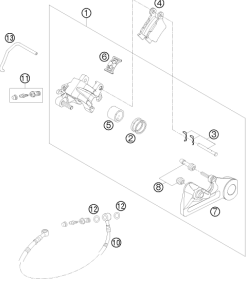
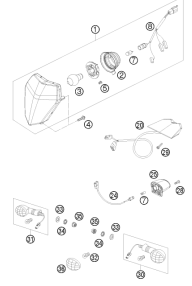
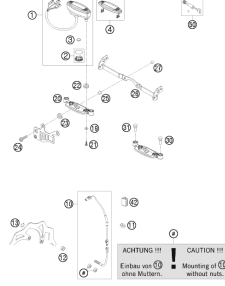
<p><b>WP SHIMS FOR SETTING</b></p>  <p style="text-align: right;"><b>4</b></p>	<p><b>FRONT FORK, TRIPLE CLAMP</b></p>  <p style="text-align: right;"><b>11</b></p>	<p><b>FRONT FORK DISASSEMBLED</b></p>  <p style="text-align: right;"><b>12</b></p>	<p><b>HANDLEBAR, CONTROLS</b></p>  <p style="text-align: right;"><b>14</b></p>
<p><b>FRAME</b></p>  <p style="text-align: right;"><b>15</b></p>	<p><b>ENGINE GUARD</b></p>  <p style="text-align: right;"><b>16</b></p>	<p><b>SIDE / CENTER STAND</b></p>  <p style="text-align: right;"><b>17</b></p>	<p><b>SHOCK ABSORBER</b></p>  <p style="text-align: right;"><b>18</b></p>
<p><b>SHOCK ABSORBER DISASSEMBLED</b></p>  <p style="text-align: right;"><b>19</b></p>	<p><b>SWING ARM</b></p>  <p style="text-align: right;"><b>21</b></p>	<p><b>EXHAUST SYSTEM</b></p>  <p style="text-align: right;"><b>22</b></p>	<p><b>AIR FILTER</b></p>  <p style="text-align: right;"><b>23</b></p>

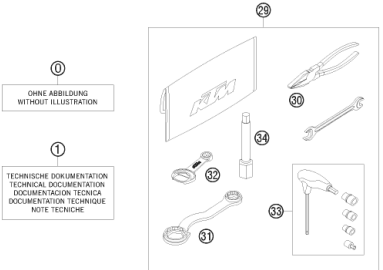
<p><b>TANK, SEAT, COVER</b></p>  <p style="text-align: right;"><b>24</b></p>	<p><b>MASK, FENDERS</b></p>  <p style="text-align: right;"><b>25</b></p>	<p><b>DECAL</b></p>  <p style="text-align: right;"><b>26</b></p>	<p><b>FRONT WHEEL</b></p>  <p style="text-align: right;"><b>27</b></p>
<p><b>REAR WHEEL</b></p>  <p style="text-align: right;"><b>28</b></p>	<p><b>WIRING HARNESS</b></p>  <p style="text-align: right;"><b>29</b></p>	<p><b>HAND BRAKE CYLINDER</b></p>  <p style="text-align: right;"><b>30</b></p>	<p><b>REAR BRAKE CONTROL</b></p>  <p style="text-align: right;"><b>31</b></p>
<p><b>BRAKE CALIPER FRONT</b></p>  <p style="text-align: right;"><b>32</b></p>	<p><b>BRAKE CALIPER REAR</b></p>  <p style="text-align: right;"><b>33</b></p>	<p><b>LIGHTING SYSTEM</b></p>  <p style="text-align: right;"><b>34</b></p>	<p><b>INSTRUMENTS / LOCK SYSTEM</b></p>  <p style="text-align: right;"><b>35</b></p>

<p><b>ACCESORIES KIT</b></p>  <p><b>36</b></p>			
	 <p>All information contained is without obligation. KTM-Sportmotorcycle AG particularly reserves the right to modify any equipment, technical specifications, prices, colors, shapes, materials, services, service work, constructions, equipment and the like so as to adapt them to local conditions or to cancel any of the above items, all without previous announcement and without giving reasons. KTM may stop manufacturing certain models without previous notice. KTM shall not be held liable for any deviations of availability and/or ability to deliver, illustrations, descriptions, printing and/or other errors. The illustrated models partly contain extra equipment, which is not applied to standard models.</p> <p>© by KTM-SPORTMOTORCYCLE AG, Mattighofen AUSTRIA; All rights reserved; Reprint, also in extracts, with written allowance of KTMSPORTMOTORCYCLE AG, Mattighofen only.</p>		



- ⑤ Ø 5 mm
- ⑥ Ø 6 mm
- ⑧ Ø 8 mm
- ⑩ Ø 10 mm
- ⑫ Ø 12 mm
- ⑭ Ø 14-14,5 mm
- ⑯ Ø 16 mm
- ⑳ Ø 20 mm
- ㉑ Ø 21 mm
- ㉒ Ø 22 mm
- ㉓ Ø 23 mm
- ㉔ Ø 24,5 mm
- ㉘ Ø 28,5 mm
- ㉚ Ø 32 mm
- ㉜ Ø 52 mm



POS	PARTNUMBER	PARTNAME	PIECE
5	44906890	WASHER 5X15X2	X
6	40540400	SHIM 6X12X0,1	X
6	40540401	SHIM 6X14X0,1	X
6	40540402	SHIM 6X16X0,1	X
6	40540403	SHIM 6X18X0,1	X
6	40540404	SHIM 6X12X0,15	X
6	40540405	SHIM 6X14X0,15	X
6	40540406	SHIM 6X16X0,15	X
6	40540407	SHIM 6X18X0,15	X
6	40540408	SHIM 6X12X0,2	X
6	40540409	SHIM 6X14X0,2	X
6	40540410	SHIM 6X16X0,2	X
6	40540411	SHIM 6X18X0,2	X
6	48600095	* SHIM 6X20X0,20	X
6	40540412	SHIM 6X12X0,25	X
6	40540413	SHIM 6X14X0,25	X
6	40540414	SHIM 6X16X0,25	X
6	40540415	SHIM 6X18X0,25	X
6	40540417	SHIM 6X8,5X0,10	X
6	40540418	SHIM 6X9X0,10	X
6	40540419	SHIM 6X9,5X0,10	X
6	40540423	SHIM 6X9,5X0,15	X
6	40540425	SHIM 6X8,5X0,20	X
6	40540426	SHIM 6X9X0,20	X
6	40540427	SHIM 6X9,5X0,20	X
6	40540447	SHIM 6X10X0,3	X
6	40540449	SHIM 6X9X0,3	X
6	40540450	SHIM 6X9,5X0,3	X
6	40540494	SHIM 6X18X0,4	X
6	40540774	SHIM 6X18X0,1 DELTA	X
6	40541383	SHIM 6X11X0,1	X
6	40541391	SHIM 6X11X0,3	X
6	40541402	SHIM 6X11X0,2	X
6	40541403	SHIM 6X10X0,20	X
6	40541404	SHIM 6X10X0,1	X
6	40541405	SHIM 6X10X0,15	X
6	40541406	SHIM 6X11X0,15	X
6	40541408	SHIM 6X8,0X0,30	X

080000190

C070000190

\* NEW PART

X ON DEMAND



3H, DELTA, T

- ⑤ Ø 5 mm
- ⑥ Ø 6 mm
- ⑧ Ø 8 mm
- ⑩ Ø 10 mm
- ⑫ Ø 12 mm
- ⑭ Ø 14-14,5 mm
- ⑯ Ø 16 mm
- ⑳ Ø 20 mm
- ㉑ Ø 21 mm
- ㉒ Ø 22 mm
- ㉓ Ø 23 mm
- ㉔ Ø 24,5 mm
- ㉘ Ø 28,5 mm
- ㉚ Ø 32 mm
- ㉜ Ø 52 mm

POS	PARTNUMBER	PARTNAME	PIECE
6	40541414	SHIM 6X8,0X0,10	X
6	40541416	SHIM 6X8X0,3	X
6	40541417	SHIM 6X11X0,25	X
6	48600102	* SHIM 6X24X0,25	X
6	48600063	SHIM 6X24X0,1	X
6	48600064	SHIM 6X22X0,1	X
6	48600065	SHIM 6X20X0,1	X
6	48600069	SHIM 6X20X0,15	X
6	48600100	SHIM 6X24X0,15	X
6	48600116	SHIM 6X24X0,1 DELTA	X
6	48600139	SHIM 6X22X0,1 DELTA	X
6	48600217	BACKPLATE 6X10X0,25	X
6	48600325	SHIM 6X13X0,1	X
6	48600327	SHIM 6X15X0,1	X
6	48600329	SHIM 6X17X0,1	X
6	48600331	SHIM 6X19X0,1	X
6	48600096	* SHIM 6X20X0,25	X
6	48600097	SHIM 6X22X0,15	X
6	48600099	* SHIM 6X22X0,25	X
6	40540448	BACKPLATE 6X8,5X0,30	X
6	48600479	SHIM 6X20X0,1 T/3H	X
6	48600332	SHIM 6X21X0,1	X
6	48600333	SHIM 6X23X0,1	X
6	40541393	* SHIM 6X12X0,3	X
8	40540477	SHIM 8X18X0,4	X
8	43570120	SHIM 8X18X0,10	X
8	44916098	WASHER 8,4X16X0,8	X
8	44916130	WASHER 8,2X15X1	X
8	44916180	WASHER 8,2X11X1	X
8	48600214	SHIM 8X16X0,1	X
8	48600346	SHIM 8X11X0,2	X
8	48600215	CHECK VALVE 8X20X0,1	X
8	48600061	CHECK VALVE 8X24X0,4	X
8	48600062	CHECK VALVE 8X24X0,1	X
8	48600216	CHECK VALVE 8X22X0,1	X
8	48600480	SHIM 8X10X0,20	X
8	48600555	SHIM 8X16X0,20	X
8	48600213	SHIM 8X14X0,10	X

080000190

C070000190

\* NEW PART

X ON DEMAND



- ⑤ Ø 5 mm
- ⑥ Ø 6 mm
- ⑧ Ø 8 mm
- ⑩ Ø 10 mm
- ⑫ Ø 12 mm
- ⑭ Ø 14-14,5 mm
- ⑯ Ø 16 mm
- ⑳ Ø 20 mm
- ㉑ Ø 21 mm
- ㉒ Ø 22 mm
- ㉓ Ø 23 mm
- ㉔ Ø 24,5 mm
- ㉘ Ø 28,5 mm
- ㉚ Ø 32 mm
- ㉜ Ø 52 mm



POS	PARTNUMBER	PARTNAME	PIECE
8	48600357	CHECK VALVE 8X11X0,1	X
8	48600351	CHECK VALVE 8X12X0,1	X
8	48600607	SHUTTLE VALVE 8X20X0,4	X
10	36120284	SHIM 10X16X0,10	X
10	36120298	SHIM 10X16X0,2	X
10	36120312	SHIM 10X16X0,30	X
10	36120314	SHIM 10X18X0,30	X
10	36120325	SHIM 10X19X0,15	X
10	36120327	SHIM 10X23X0,15	X
10	36120328	SHIM 10X25X0,15	X
10	36120329	SHIM 10X27X0,15	X
10	36120330	SHIM 10X29X0,15	X
10	36120331	SHIM 10X31X0,15	X
10	36120332	SHIM 10X33X0,15	X
10	36120334	SHIM 10X21X0,20	X
10	36120335	SHIM 10X23X0,20	X
10	36120336	SHIM 10X25X0,20	X
10	36120337	SHIM 10X27X0,20	X
10	36120338	SHIM 10X29X0,20	X
10	36120339	SHIM 10X31X0,20	X
10	36120340	SHIM 10X33X0,20	X
10	36120342	SHIM 10X21X0,25	X
10	36120343	SHIM 10X23X0,25	X
10	36120344	SHIM 10X25X0,25	X
10	36120345	SHIM 10X27X0,25	X
10	36120349	SHIM 10X19X0,30	X
10	36120350	SHIM 10X21X0,30	X
10	40140275	WASHER 10X35X0,15	X
10	36120346	* SHIM 10X29X0,25	X
10	50180010	* SHIM 16X24X0,10	X
10	36120604	SHIM D10XD22X2,5	X
12	46810490	SHIM 12X24X0,20	X
12	46810491	SHIM 12X26X0,20	X
12	46810492	SHIM 12X28X0,20	X
12	46810493	SHIM 12X30X0,20	X
12	46810494	SHIM 12X32X0,20	X
12	46810495	SHIM 12X34X0,20	X
12	46810496	SHIM 12X36X0,20	X

080000190

C070000190

\* NEW PART

X ON DEMAND





- ⑤ Ø 5 mm
- ⑥ Ø 6 mm
- ⑧ Ø 8 mm
- ⑩ Ø 10 mm
- ⑫ Ø 12 mm
- ⑭ Ø 14-14,5 mm
- ⑯ Ø 16 mm
- ⑳ Ø 20 mm
- ㉑ Ø 21 mm
- ㉒ Ø 22 mm
- ㉓ Ø 23 mm
- ㉔ Ø 24,5 mm
- ㉘ Ø 28,5 mm
- ㉚ Ø 32 mm
- ㉜ Ø 52 mm

POS	PARTNUMBER	PARTNAME	PIECE
12	46810497	SHIM 12X38X0,20	X
12	46810498	SHIM 12X40X0,20	X
12	46810499	SHIM 12X24X0,25	X
12	46810500	SHIM 12X26X0,25	X
12	46810501	SHIM 12X28X0,25	X
12	46810502	SHIM 12X30X0,25	X
12	46810504	SHIM 12X34X0,25	X
12	46810505	SHIM 12X36X0,25	X
12	46810507	SHIM 12X40X0,25	X
12	46810508	SHIM 12X24X0,30	X
12	46810509	SHIM 12X26X0,30	X
12	46810510	SHIM 12X28X0,30	X
12	46810512	SHIM 12X32X0,30	X
12	46810513	SHIM 12X34X0,30	X
12	46810518	SHIM 12X26X0,15	X
12	46810519	SHIM 12X28X0,15	X
12	46810520	SHIM 12X30X0,15	X
12	46810521	SHIM 12X32X0,15	X
12	46810522	SHIM 12X34X0,15	X
12	46810523	SHIM 12X36X0,15	X
12	46810524	SHIM 12X38X0,15	X
12	46810525	SHIM 12X40X0,15	X
12	46810604	SHIM 12X20X0,10	X
12	46810606	SHIM 12X22X0,10	X
12	46810607	SHIM 12X23X0,10	X
12	46810608	SHIM 12X24X0,10	X
12	46810610	SHIM 12X27X0,15	X
12	46810611	SHIM 12X18X0,15	X
12	46810612	SHIM 12X19X0,15	X
12	46810615	SHIM 12X22X0,15	X
12	46810636	BACKPLATE 12X16X0,30	X
12	46810637	BACKPLATE 12X17X0,30	X
12	46810638	BACKPLATE 12X18X0,30	X
12	46810639	SHIM 12X19X0,30	X
12	46810641	BACKPLATE 12X21X0,30	X
12	46811582	BACKPLATE 12X30X0,10	X
12	46810631	SHIM 12X20X0,25	X
12	46810633	SHIM 12X22X0,25	X

080000190

C070000190

\* NEW PART

X ON DEMAND



- ⑤ Ø 5 mm
- ⑥ Ø 6 mm
- ⑧ Ø 8 mm
- ⑩ Ø 10 mm
- ⑫ Ø 12 mm
- ⑭ Ø 14-14,5 mm
- ⑯ Ø 16 mm
- ⑳ Ø 20 mm
- ㉑ Ø 21 mm
- ㉒ Ø 22 mm
- ㉓ Ø 23 mm
- ㉔ Ø 24,5 mm
- ㉘ Ø 28,5 mm
- ㉚ Ø 32 mm
- ㉜ Ø 52 mm

POS	PARTNUMBER	PARTNAME	PIECE
12	46810624	* SHIM 12X22X0,20	X
12	46811580	SHIM 12X32X0,10	X
12	46810503	SHIM 12X32X0,25	X
12	46810517	* SHIM 12X24X0,15	X
12	46810640	SHIM 12X20X0,30	X
14	46811046	SHIM 14,5X35,4X1,25	X
16	50180006	BACKPLATE 16X20X0,10	X
16	50180007	SHIM 16X21X0,10	X
16	50180028	SHIM 16X21X0,25	X
16	50180210	WASHER 16X21X1	X
16	50180008	SHIM 16X22X0,10	X
16	50180022	SHIM 16X22X0,20	X
16	50180037	SHIM 16X23X0,30	X
16	50180038	SHIM 16X24X0,30	X
16	50180032	SHIM 15X25X0,25	X
16	50180039	SHIM 16X25X0,30	X
16	50180012	SHIM 16X26X0,10	X
16	50180019	SHIM 16X26X0,15	X
16	50180026	SHIM 16X26X0,20	X
16	50180040	SHIM 16X26X0,30	X
16	50180041	SHIM 16X28X0,10	X
16	50180045	SHIM 16X28X0,15	X
16	50180054	SHIM 16X28X0,20	X
16	50180063	SHIM 16X28X0,25	X
16	50180072	SHIM 16X28X0,30	X
16	50180046	SHIM 16X30X0,15	X
16	50180055	SHIM 16X30X0,20	X
16	50180064	SHIM 16X30X0,25	X
16	50180073	SHIM 16X30X0,30	X
16	50180047	SHIM 16X32X0,15	X
16	50180056	SHIM 16X32X0,20	X
16	50180065	SHIM 16X32X0,25	X
16	50180074	SHIM 16X32X0,30	X
16	50180044	SHIM 16X34X0,10	X
16	50180048	SHIM 16X34X0,15	X
16	50180057	SHIM 16X34X0,20	X
16	50180066	SHIM 16X34X0,25	X
16	50180075	SHIM 16X34X0,30	X

080000190

C070000190

\* NEW PART

X ON DEMAND

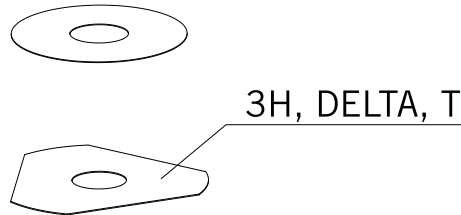

- ⑤ Ø 5 mm
- ⑥ Ø 6 mm
- ⑧ Ø 8 mm
- ⑩ Ø 10 mm
- ⑫ Ø 12 mm
- ⑭ Ø 14-14,5 mm
- ⑯ Ø 16 mm
- ⑳ Ø 20 mm
- ㉑ Ø 21 mm
- ㉒ Ø 22 mm
- ㉓ Ø 23 mm
- ㉔ Ø 24,5 mm
- ㉘ Ø 28,5 mm
- ㉚ Ø 32 mm
- ㉜ Ø 52 mm

POS	PARTNUMBER	PARTNAME	PIECE
16	50180049	SHIM 16X36X0,15	X
16	50180058	SHIM 16X36X0,20	X
16	50180067	SHIM 16X36X0,25	X
16	50180076	SHIM 16X36X0,30	X
16	50180050	SHIM 16X38X0,15	X
16	50180059	SHIM 16X38X0,20	X
16	50180068	SHIM 16X38X0,25	X
16	50180077	SHIM 16X38X0,30	X
16	50180051	SHIM 16X40X0,15	X
16	50180060	SHIM 16X40X0,20	X
16	50180069	SHIM 16X40X0,25	X
16	50180078	SHIM 16X40X0,30	X
16	50180052	SHIM 16X42X0,15	X
16	50180061	SHIM 16X42X0,20	X
16	50180070	SHIM 16X42X0,25	X
16	50180079	SHIM 16X42X0,30	X
16	50180053	SHIM 16X44X0,15	X
16	50180062	SHIM 16X44X0,20	X
16	50180071	SHIM 16X44X0,25	X
16	50180080	SHIM 16X44X0,30	X
16	50180177	WASHER 16X8,2X0,6	X
16	50180033	SHIM 16X26X0,25	X
16	50180034	BACKPLATE 16X20X0,30	X
16	50180035	BACKPLATE 16X21X0,30	X
16	50180036	BACKPLATE 16X22X0,30	X
16	50180043	SHIM	X
16	50180024	* SHIM 16X24X0,20	X
16	50180027	* SHIM 16X20X0,25	X
16	50180031	SHIM	X
20	48600212	PRESSURE-RING 20X16,25X0,20	X
20	50180666	SHIM 20X24X0,30	X
20	50180654	SHIM 20X36X0,20	X
20	50180655	SHIM 20X38X0,20	X
20	50180656	SHIM 20X40X0,20	X
20	50180665	SHIM 20X40X0,25	X
20	50180662	SHIM 20X34X0,25	X
20	50180657	SHIM 20X24X0,25	X
20	50180653	SHIM 20X34X0,20	X

080000190

C070000190

\* NEW PART

X ON DEMAND



- ⑤ Ø 5 mm
- ⑥ Ø 6 mm
- ⑧ Ø 8 mm
- ⑩ Ø 10 mm
- ⑫ Ø 12 mm
- ⑭ Ø 14-14,5 mm
- ⑯ Ø 16 mm
- ⑳ Ø 20 mm
- ㉑ Ø 21 mm
- ㉒ Ø 22 mm
- ㉓ Ø 23 mm
- ㉔ Ø 24,5 mm
- ㉘ Ø 28,5 mm
- ㉚ Ø 32 mm
- ㉜ Ø 52 mm



POS	PARTNUMBER	PARTNAME	PIECE
20	50180634	RING 20X22,9X1	X
21	50180209	WASHER 21X36X0,25	X
22	50180330	* PRESS. RING 22X18X0,30	X
23	50180635	SHUTTLE VALVE 23X38X0,25	X
23	50180578	SHIM D23XD16X2	X
24	40541061	WASHER 24,5X34X2	X
28	36120469	SHIM 28,5X14X2	X
28	36120471	SHIM 28,5X14X5	X
32	48600460	WASHER 32X42X2,5	X
32	50600065	SHIM 32X45X2	X
32	46811637	PRESSURE RING 36X32,25	X
52	50600002	SHIM 52X59X2,2	X

080000190

C070000190

\* NEW PART

X ON DEMAND

# FRONT FORK, TRIPLE CLAMP

450 EXC SIX DAYS EU 2010

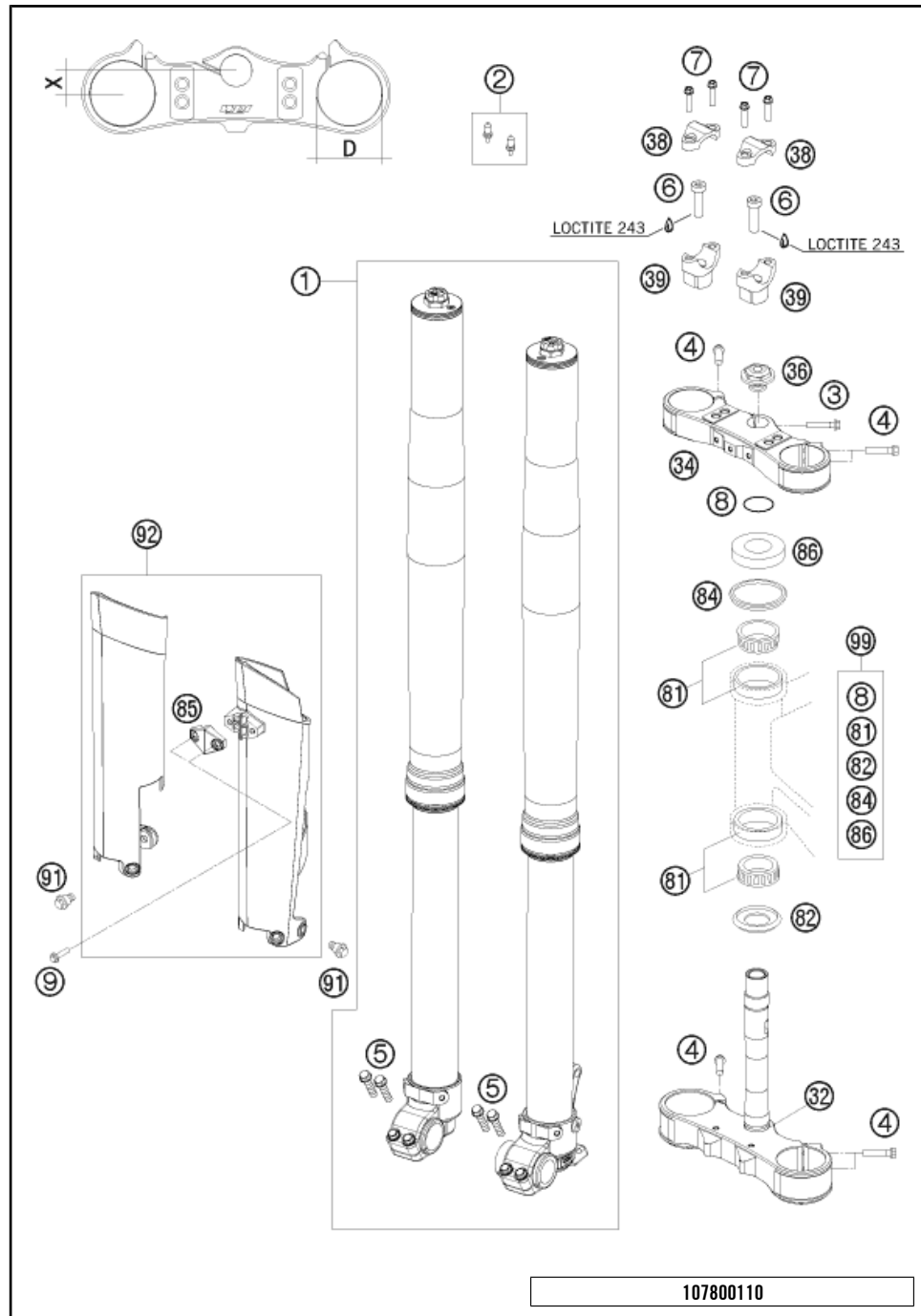

POS	PARTNUMBER	PARTNAME	PIECE
1*	14187J0601	FORK KTM450/530EXC/XC-W 2010	1
2	SXS08125610	BLEEDER VALVE SET	1
3	0025080256S	HH COLLAR SCREW M8X25 TX40	1
4	0025080356	HH COLLAR SCREW M8X35 TX40	8
5	0025080256	HH COLLAR SCREW M8X25 TX40	4
6	0912100356	%AH SCREW DIN6912-M10X35 10.9	2
7	0025080306	HH COLLAR SCREW M8X30 TX40	4
8	0770025035	O-RING 25X3,55 NBR70 05	1
9	0017060204	EJOT PT SCREW K60X20 ALU WS=6	2
32	7800103211930	BOT. TR. CLAMP CPL. X=19MM 09	1
34	5940103401930	TOP TRIPLE CLAMP D=54MM 09	1
36	54801036000	STEER.HEAD SCREW M20X1,5 WS=27	1
38*	59401038000	% HANDLEBAR CLAMP 28MM 05	4
39*	59401039032	HANDLEB.SUPP. D=28MM H=32MM 05	2
39*	59401039037	HANDLEB.SUPP. D=28MM H=37MM 05	2
39*	59401039042	HANDLEB.SUPP. D=28MM H=42MM 05	2
81	54201081100	TAPERED ROLLER BEARING CPL. 06	2
82	54601084100	O-RING SUPPORT W. SEALING LIP	1
84	54601184000	STEERING HEAD GASKET TOP	1
85	7800108500004	CLAMP FOR SPEED CABLE D=6MM 08	1
86	54201086000	% STEERING HEAD COVER	1
91	59001092050	SPECIAL SCREW M6X12,5 WS=8	6
92	7800109410030	FORK PROTECTION LE+RI BLACK	1
99	00050000930	STEERING HEAD REP. KIT 06-13	x

107800110

C107800115

\* NEW PART X ON DEMAND

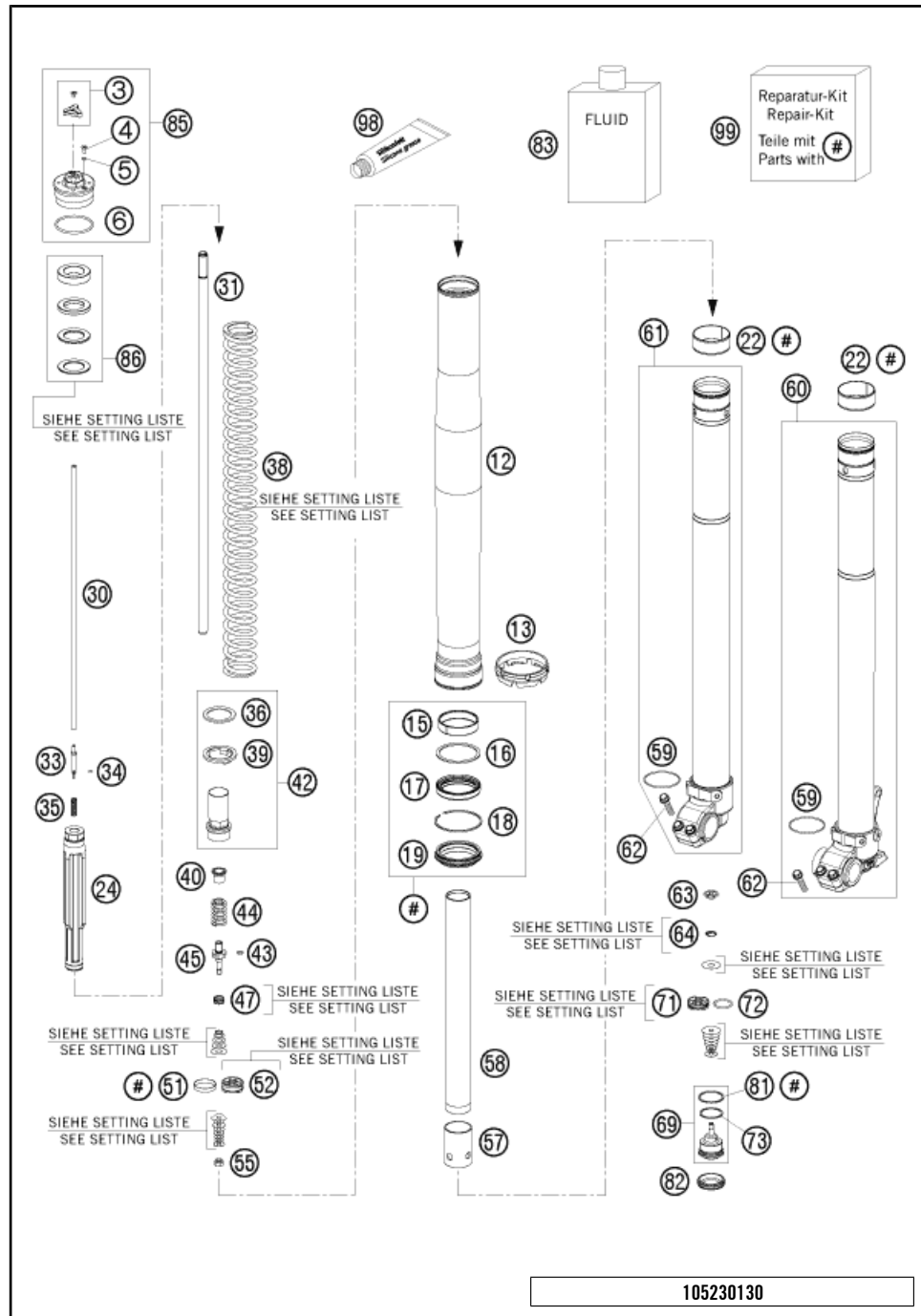

105230130

POS	PARTNUMBER	PARTNAME	PIECE
3	48600812S	ADJUSTING KNOB + SCREW	2
4	48600481	VENT SCREW M4X8	2
5	48600046	O-RING NBR 3X1,5	2
6*	46810340	O-RING NBR 45X2	1
12	48600736	OUTER TUBE L577 D54/60MM 2L	2
13	48600698	FORK PROTECTION RING 08	2
15	48600429	DU-BUSH D48XD52X12DDL02	2
16	48600013	SUPPORT RING 50 X 57,6 X 1,5	2
17	48600347	OIL SEAL RING 48X57,8X9,5 03	2
18	48600070	LOCK WASHER SB58	2
19	48600400	DUST CAP D=48 58,4X11,8	2
22	48600428	DU-BUSH D47XD49X20DDL02	2
24	48600557S	HYDR.STOP L=200 D=31,9 CPL. 07	2
30	48600559	ADJUSTING TUBE L=520 07	2
31	48600568	PISTON ROD D=12 L=554 ALU	2
33	48600277	ADJUSTER NEEDLE 07	2
34	48600298	O-RING 2X1,5 NBR	2
35	48600444	REBOUND SPRING C=4N/MM	2
36	48600113	WASHER 32X42X2,5	2
38	91410012S	SPRING 3,8N/MM SET D=4,9MM	x
38	91410013S	SPRING 4,0N/MM SET D=5,0MM	x
38	91410014S	SPRING 4,2N/MM SET D=5,0MM	x
38	91410015S	SPRING 4,4N/MM SET D=5,1MM	x
38	91410016S	SPRING 4,6N/MM SET	x
38	91410017S	SPRING 4,8N/MM SET	x
39	48600021	INTERM. RING 26,2 X 43 X 3	2
40	48600525	GUIDING BUSH REBOUND SPRING	2
42*	48600830S	SCREW SLEEVE M27X0,8	2
43	48600299	O-RING 6X1,2 NBR	2
44	48600511	REBOUND SPRING L=32 C=17	2
45	48600576	PISTON ROD REBOUND	2
47	48600382	SHUTTLE VALVE SPRING C=0,4	2
51	48600455	PISTON RING 5X1X68	2
52	48600575	PISTON REBOUND SX 2007	2
55	40540486	NUT M6X0,5 REBOUND	2
57	48600764	ADAPTER SLEEVE D23/D28	2
58	48600763	PIPE D23/L350 09	2
59	48600048	O-RING NBR 46 X 2	2

C105230130

\* NEW PART

X ON DEMAND

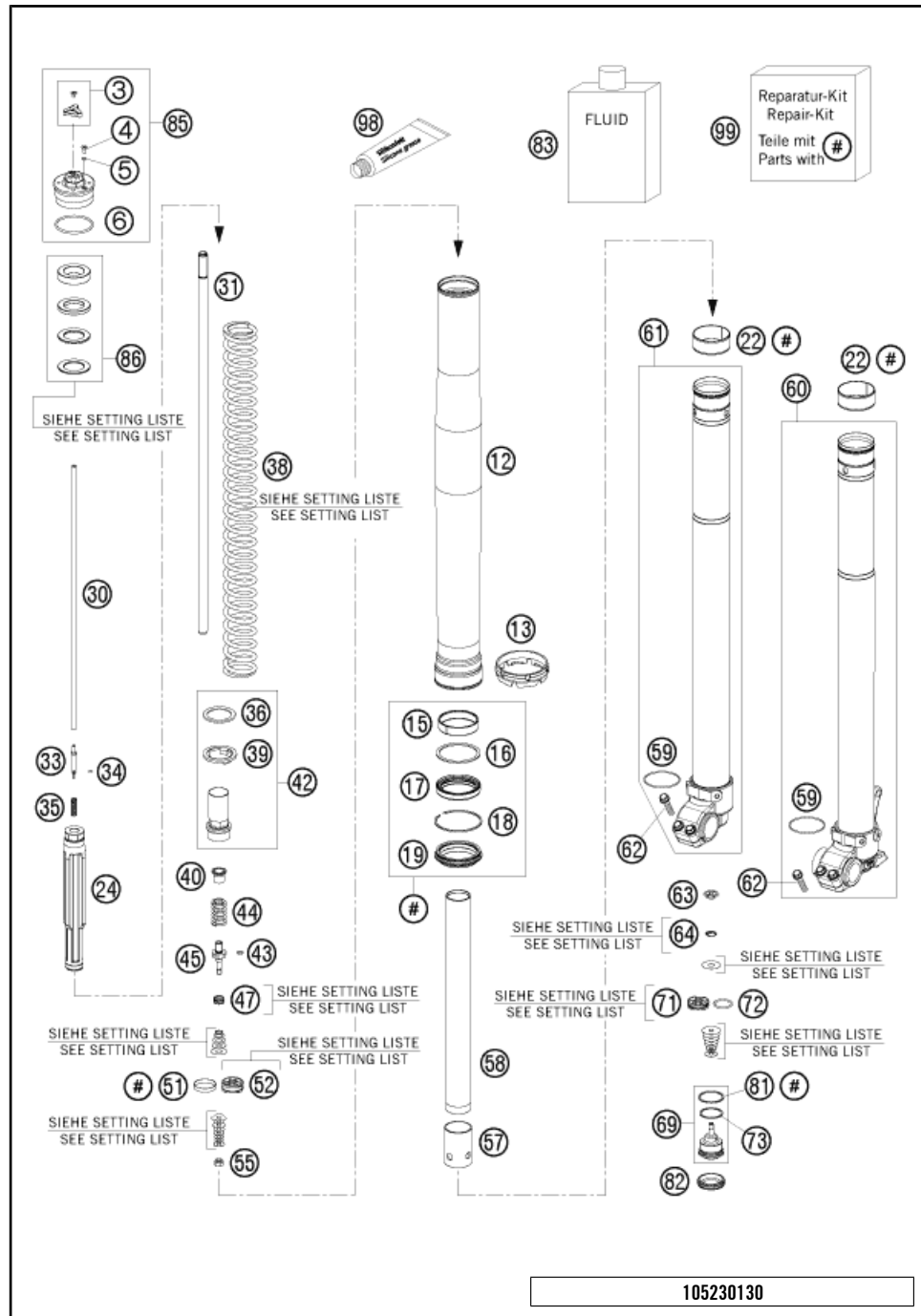

105230130

POS	PARTNUMBER	PARTNAME	PIECE
60*	48600860SA	AXLE CLAMP L/S + TUBE CPL.	1
61*	48600861S1	AXLE CLAMP R/S + TUBE CPL. 09	1
62	0025080256	HH COLLAR SCREW M8X25 TX40	4
63	48600163	CHECK VALVE NUT M6X0,5 D=2	2
64	48600202	SPRING CHECK VALVE D=0,7	2
69	48600586S	TAP COMPRESSION CPL. 07	2
71	48600047	PISTON COMPRESSION D=27,9	2
72	46811499	O-RING NBR 21X2	2
73	35480320	O-RING NBR 24X2	2
81	48600004	COPPER WASHER 29,5X33,5X1	2
82	48600141	RUBBER CAP D=35MM	2
83	48600765S1	% FORK OIL SAE5 5L 2008	1
85	48600431S2	PRE-LOAD ADJ. M51X1,5 09	2
86	48600038	SPACER 42X26,5X10	x
86	48600037	SPACER 42X26,5X5	x
86	48600036	SPACER 42X26,5X2,5	x
86	48600053	SPACER 42X26,5X1,5	x
98	T511	SILICONE GREASE F. DUST STRI	1
99	R14016	REPAIR-KIT EXC FRONT FORK 2009	1

C105230130

\* NEW PART

X ON DEMAND

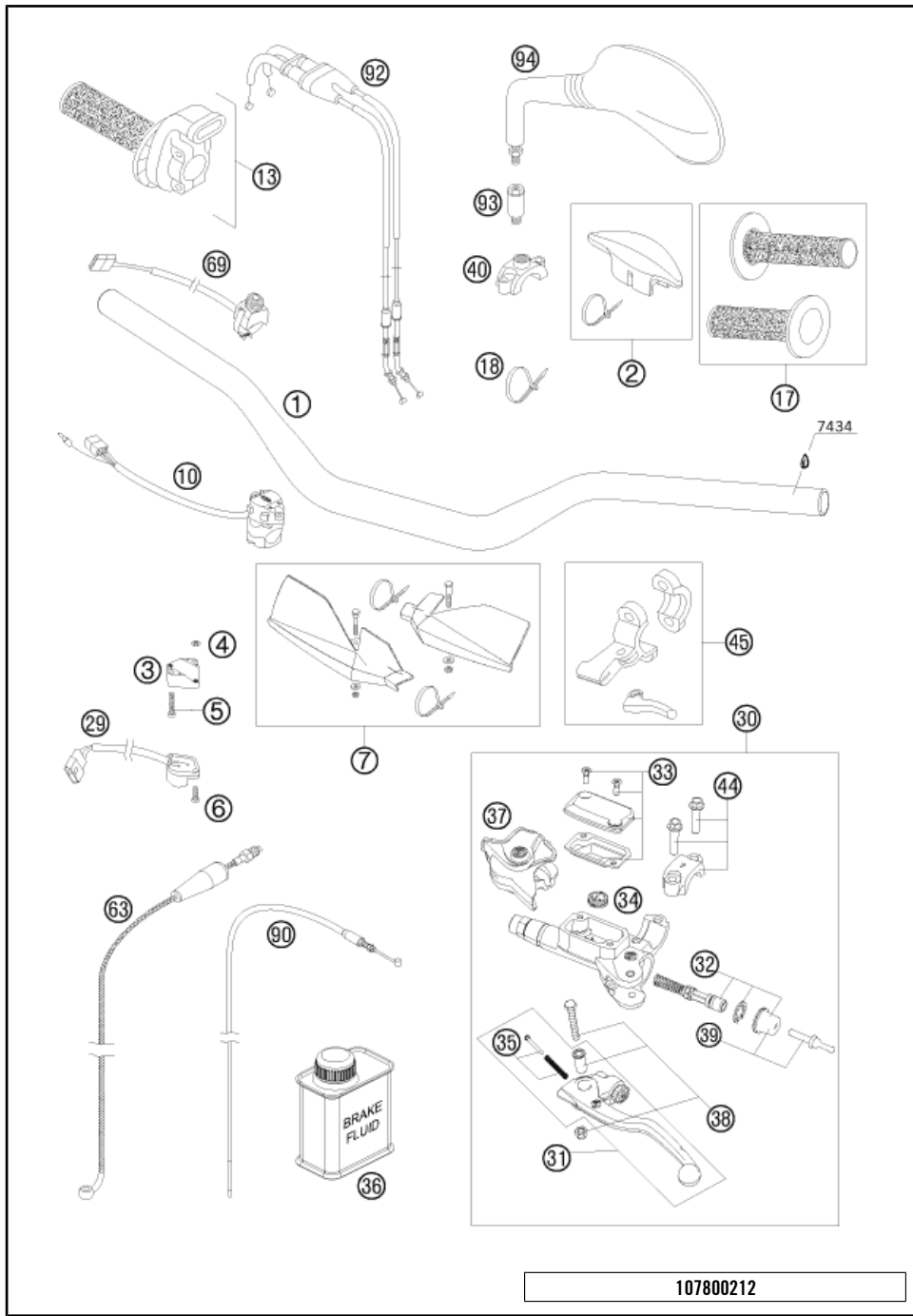

107800212

POS	PARTNUMBER	PARTNAME	PIECE
1	7800200100017	HANDLEBAR D=28MM	1
2	77202002000	% BAR PAD CPL.	1
3	13011070060	ADAPTER FOR FLASHER SWITCH '98	1
4	0934040003	HEXAGON NUT DIN0934-M 4	2
5	0084040223	CYL.HEAD SCREW DIN0084-M 4X22A	2
6	0985040203	FLAT HEAD SCREW DIN7985-M 4X20	2
7	7700207900004	HAND GUARDS CPL.L/S+R/S OR. 06	1
10	50311070000	H.LIGHT SWITCH CEV 2/4TAKT '98	1
13*	77002010100	THROTTLE GRIP CPL. 4-ST. 09	1
17*	54802021200	GRIP-SET GRAY/ORANGE 09	1
18	44011076200	CABLE TIE 200/3,6MM BLACK	x
29	50311029000	FLASHER SWITCH CEV '98	1
30	54802030044	MASTER CYLINDER CPL. 06	1
31	54802031000	CLUTCH LEVER CPL. BREMBO 06	1
32	54802032000	REP. KIT PISTON 06	1
33	54802003000	COVER HYD. CLUTCH CPL.	1
34	54802051000	VALVE	1
35	54802052000	BOLT KPL.	1
36	00062030000	BRAKE FLUID DOT5.1 0,25L	1
37	54802037000	PROTECTION CAP 06	1
38	54802038100	LEVER SCREW CPL. 06	1
39	54802046000	PUSH ROD CPL.	1
40	58012040150	CLAMP FOR MIRROR '94	x
44	54802005100	CLAMP CPL. 06	1
45	78002050000	LEVER F. COLD START ACT. 08	1
63	54832063000	CLUTCH PIPE 06	1
69	59411074000	STARTER CONTROL 04	1
90	78031078000	CABLE F. COLD START ACT. 08	1
92	77002091000	THROTTLE CABLE 250 SXF 2005	1
93	58412040050	SUPPORT FOR MIRROR LC4 '98	2
94	58412040000	MIRROR L/S 98	1
94	58412041000	MIRROR R/S 98	1

C107800215

\* NEW PART

X ON DEMAND



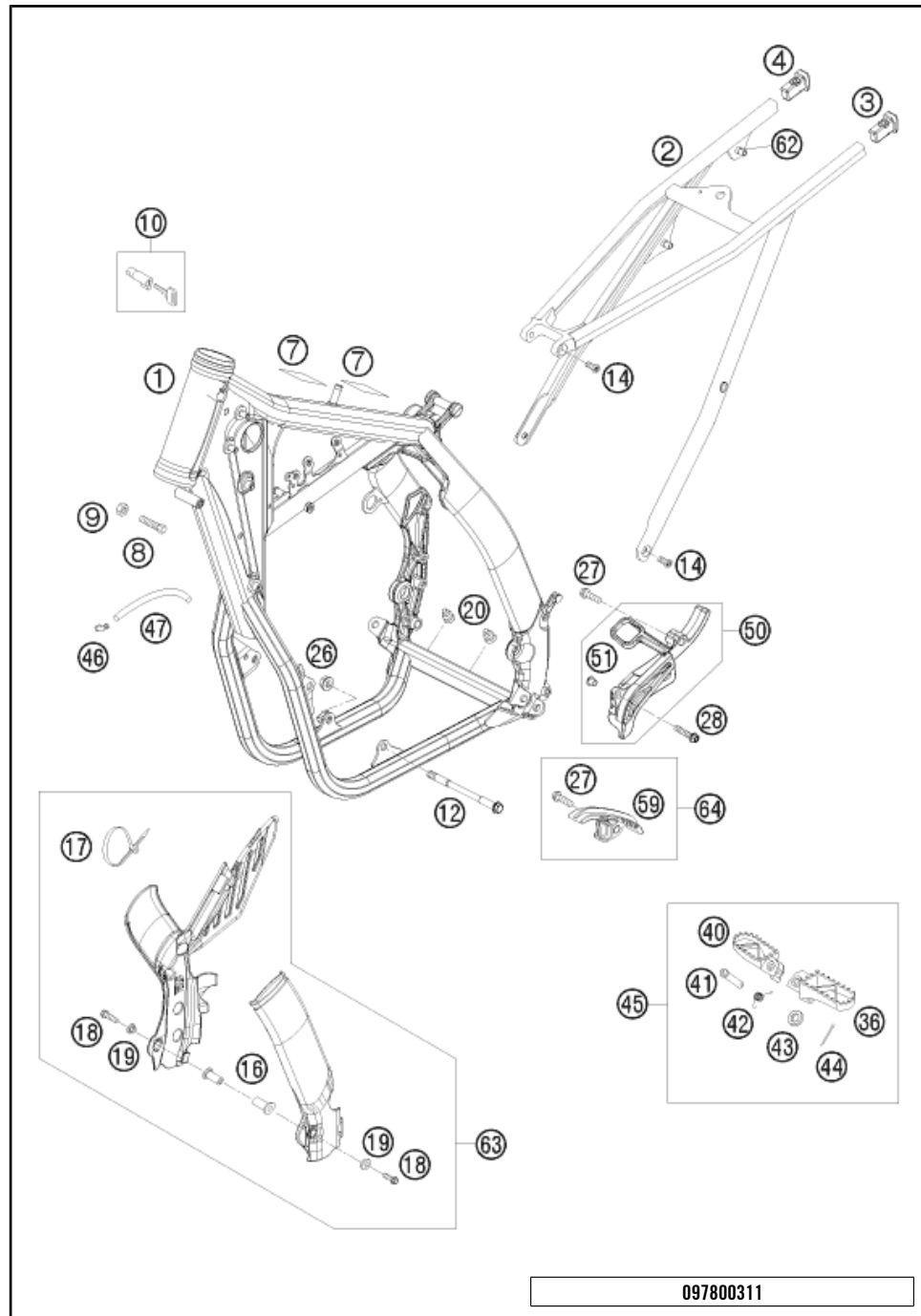

POS	PARTNUMBER	PARTNAME	PIECE
1*	7800300150033	FRAME BLACK "DC10"	1
2	77303002000	SUB FRAME SX "Q7" 07	1
3	78003002010	SUB FRAME APPLICATION LEFT 08	1
4	78003002020	SUB FRAME APPLICATION RIGHT 08	1
7	50307012000	ADH. FOIL TRANSP. 80X80 MM 04	2
8	59001037000	SPECIAL SCREW M8X26 WS=10	2
9	0934080003	HEXAGON NUT DIN0934-M 8	2
10	78003035000	STEERING HEAD LOCK 08	1
12	59003013000	ENGINEBRAC.SCREW M10X123 WS=13	2
14	0019080206S	FLAT HEAD SCREW M. ISA45 M8X20	4
16	54803092050	BLIND PLUG-IN NUT M5 WN 22A 03	2
17	44011076305	CABLE TIE 300/4,8MM BLACK	3
18	0738050250	COU.SUNK SCR. AH ISO7380 M5X25	2
19	54803092050	BLIND PLUG-IN NUT M5 WN 22A 03	2
20	54403135000	PLASTIC CAP SFL10	2
26	54310086100	SELF LOCKING NUT M10 CU WS=14	2
27	0025080306	HH COLLAR SCREW M8X30 TX40	2
28	0025060356	HH COLLAR SCREW M6X35 TX30	1
36	78003040050	FOOTREST L/S 08	1
40	78003041050	FOOTREST R/S 08	1
41	54803044000	BOLT FOR FOOT PED 03	2
42	54603041000	FOOTREST SPRING L/S & R/S	2
43	0125100003	WASHER DIN0125-A10,5	2
44	0094032253	PIN DIN0094-3,2X25 STEEL	2
45	78003040033	FOOTREST L/S + R/S CPL. 09	1
46	50303089000	ANGLE PIECE '97	2
47	78015019000	HOSE EPA D=6/10 L=2000MM	x
50	78003096000	CHAIN SPR. COV. 450/525 EXC-F	1
51	58314060050	SPACER BUSH. F. SPEEDOMET.BRA.	1
59	77303053000	CHAIN SLIDING PIECE BELOW 07	1
62	77303139000	BLIND RIVET NUT EM6-60LF/HX	x
63	77303094100	PLASTIC FRAME PROTECTION SET	1
64	77303053010	CHAIN SLIDING KIT BELOW CPL07	1

097800311

C107830310

\* NEW PART X ON DEMAND

POS	PARTNUMBER	PARTNAME	PIECE
1	78003190000	SKID PLATE PLASTIC	1
2	59003090350	QUICK RELEASE 03	1
3	78003190010	BRACKET	1
4	0025060126	HH COLLAR SCREW M6X12 TX30	2
5	0985060003	SELF LOCK. NUT DIN0985-M 6	2

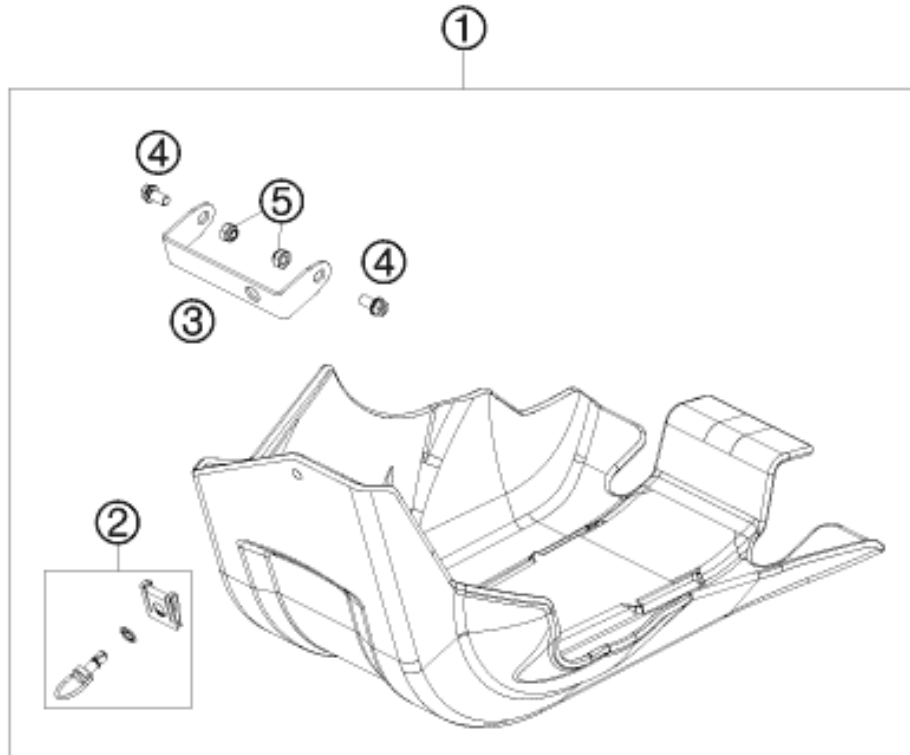

097800330

C107800330

\* NEW PART

X ON DEMAND

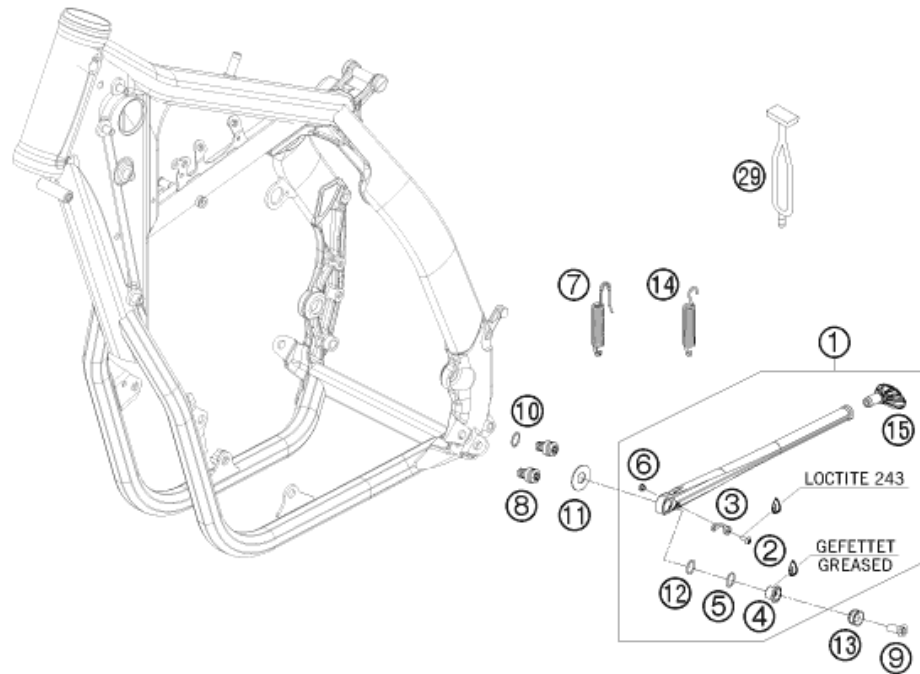

POS	PARTNUMBER	PARTNAME	PIECE
1	78003023044	SIDE STAND CPL. 08	1
2	58605083014	SCREW M5X14 TORX 25 07	1
3	78003023090	SPRING BRACKET F. SIDE ST. 08	1
4	78003023080	SIDE STAND BUSHING EXC USA 08	1
5	0770180020	O-RING 18,00X2,00 NBR 70	1
6	78003023070	SPACER BUSH. SPRING BRACKET	1
7*	81203024000	SIDE STAND SPRING EYE MOVEABLE	1
8	78003023182	SIDE STAND STOP SCREW M10X12	2
9	0019080266S	COUNTER-SUNK SCREW ISA45 M8X26	1
9	0019080206S	FLAT HEAD SCREW M. ISA45 M8X20	1
10	0770120020	O-RING 12,00X2,00 NBR 70	1
11	78003023083	WASHER F. SIDE STAND 12,2X29,5	1
12	0770125015	O-RING 12,5X1,5 NBR	1
13	78003023081	SIDE STAND BUSHING EXC-EU 08	1
14	78003024100	SIDE STAND SPRING 08	1
15	78003023055	% STAND BASE	1
29	50303018000	RUBBER L=145MM	1

097800360

C097800360

\* NEW PART

X ON DEMAND

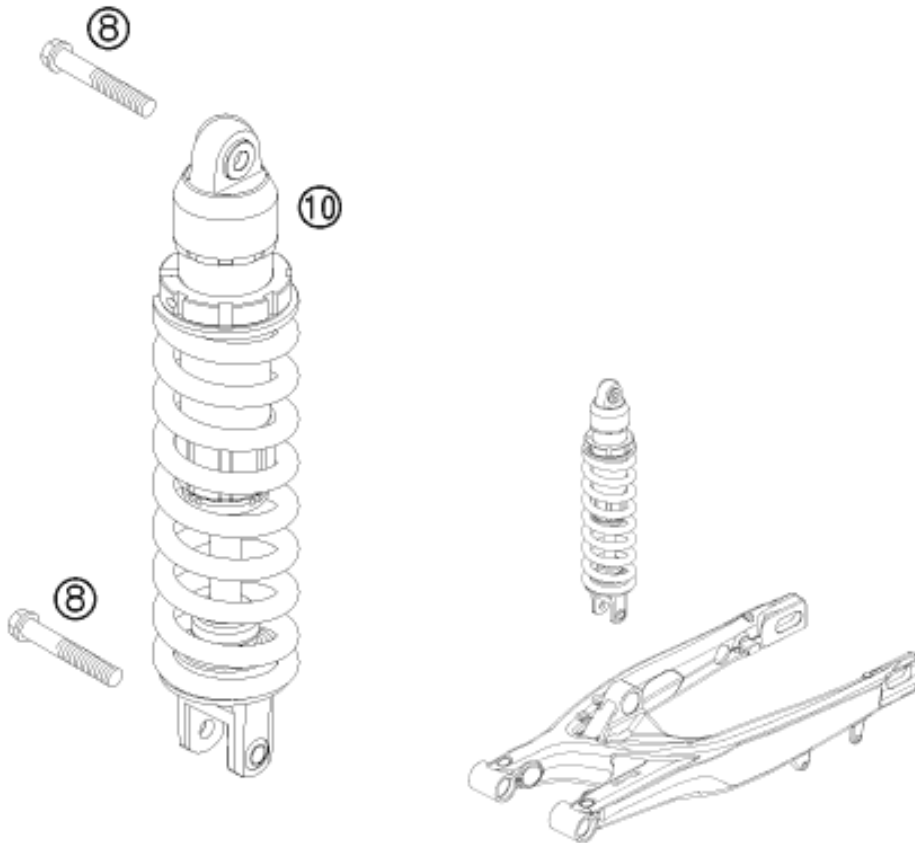

POS	PARTNUMBER	PARTNAME	PIECE
8	0025120506S	HH COLLAR SCREW M12X50 TX45	2
10*	12187J0601	MONOSH.PDS B07MA450/530EXC-F10	1

085030410

C107830410

\* NEW PART

X ON DEMAND

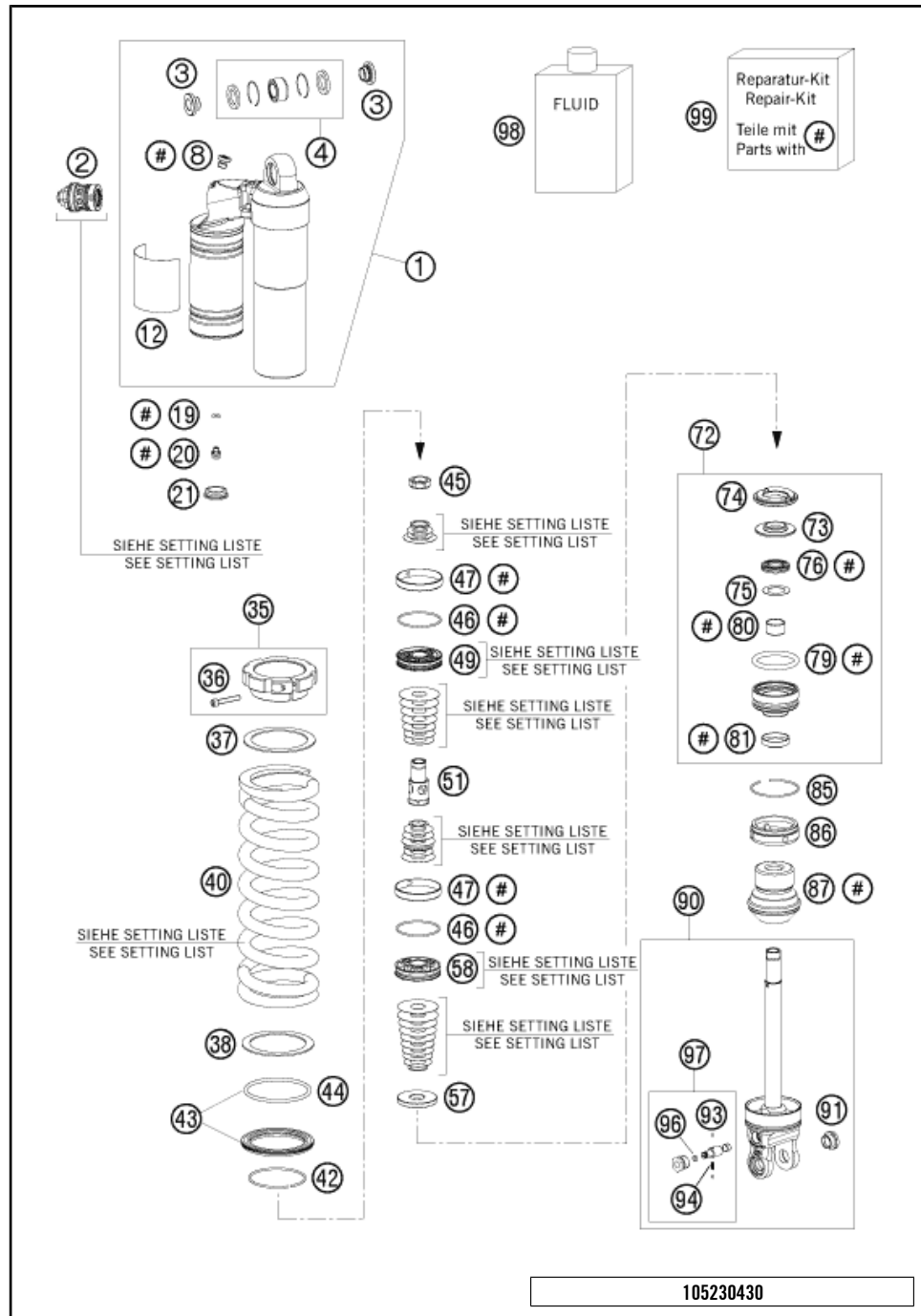

POS	PARTNUMBER	PARTNAME	PIECE
1*	50180733SA	TOP PART CPL. M57,5X1 H30,5 10	1
2	50180213S10	DCC-COMPR.DAMP.CONTROL CPL. 07	1
3	46180007	ADAPTOR BUSH KGW 12X24	2
4	R12012	REP. KIT BEAR./SEAL UP. 07	1
8	50180095	BLEED PLUG R 1/8	1
12*	52000085	WP CAUTION (PDS KTM)	1
19	46810893	O-RING NBR 5,28X1,78	1
20	36120151	SCREW PLUG M5X6	1
21	46811208	RUBBER CAP "DO NOT OPEN"	1
35	50180520S	SPRING RETAINER M57,5X1 +SCREW	1
36	50180327	AH SCREW M5X30 DIN912	1
37	50180818	INTERM.RING SCREW SPRING RET.	1
38	50180114	SPACER RING FOR SPRING	1
40	91210053S	SPRING 250 63N/MM ORANGE	x
40	91210055S	SPRING 250 60N/MM ORANGE	x
40	91210054S	SPRING 250 66N/MM ORANGE	x
40	91210068S	SPRING 250 69N/MM ORANGE	x
40	91210069S	SPRING 250 72N/MM ORANGE	x
40	91210070S	SPRING 250 76N/MM	x
42	50180273	CIRCLIP 58,2X2	1
43	50180463S	SPRING RET. D=80 W. O-RING 05	1
44	50180352	O-RING VITON 66,27X3,53	1
45	50180627	PISTON ROD NUT M20X1	1
46	50180099	O-RING VITON 44,17X1,78	2
47	50180135	PISTON RING 50-8	2
49	50180675	PISTON D=20	1
51	50180764	TAP D20 M20X1 L45,3 09	1
57	50180631	% REBOUND DISC D43 HO T4	1
58	50180197	PISTON 6+6X7/4,5	1
72	50180603S	ADAPTOR CPL. D=50 H=28 08	1
73	50180113	STEEL DISC 18X,5X43,7X6	1
74	50180107	REBOUND RUBBER	1
75	50180604	SHIM D29,75 X D19 X T0,4 08	1
76	50180605S	SEAL D18X30X5 08	1
79	50180103	O-RING 41X5	1
80	46180119	DU-BUSH 18X20X12	1
81	50180606	DUST SEAL 1828 08	1
85	50180126	CIRCLIP 53X1,75	1

\* NEW PART

X ON DEMAND

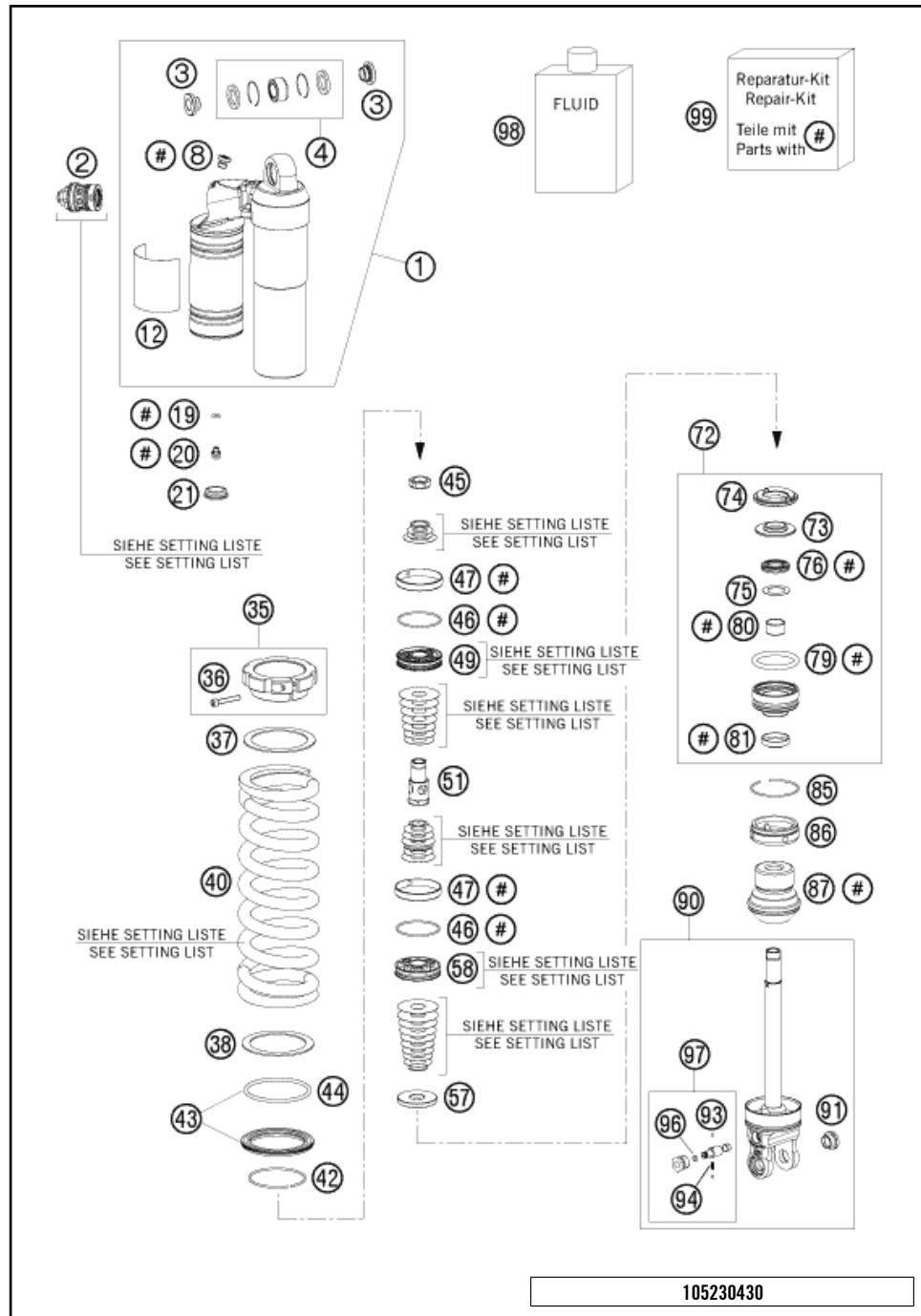

POS	PARTNUMBER	PARTNAME	PIECE
86	50180626	RESERVOIR CAP D=50 H=10 09	1
87	50180600	BUMP RUBBER D58 D17 H59 2008	1
90*	50180512SA2	SHOCK ABS. LOWER PART CPL. 10	1
91	50180105	THREADED BUSH M12 PDS	1
93	40540603	STEEL BALL D=3MM	2
94	48600028	SPRING D=2,9 L=7,9	1
96	50180222	O-RING NBR 4X1,5	1
97	50180434S	ADJUSTING SCREW REBOUND TRAVEL	1
98	50180342S1	%SHOCK ABSORBER FLUID 5 LT '03	1
99	R12015	REPAIR KIT 5018 PDS 08	1

105230430

C105230430

\* NEW PART X ON DEMAND

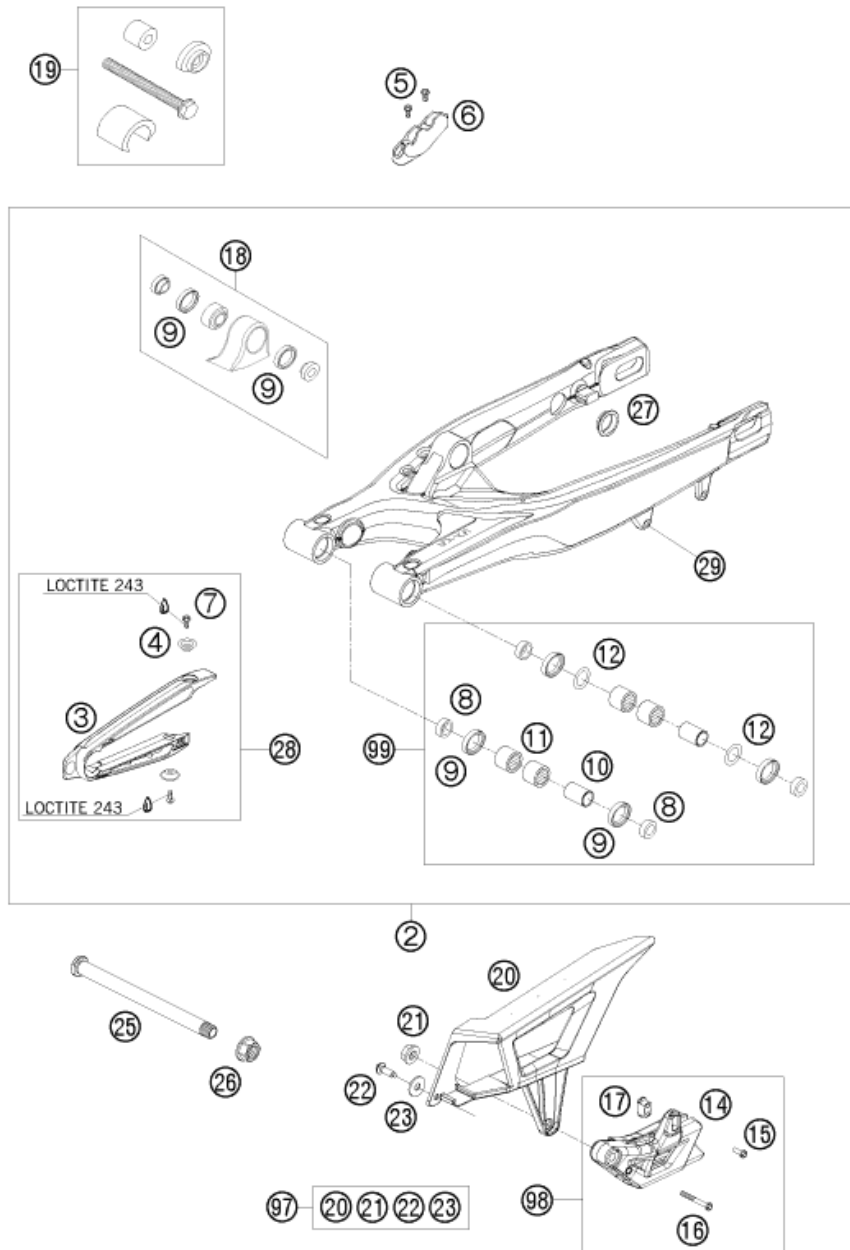

105030491

POS	PARTNUMBER	PARTNAME	PIECE
2	78004030144	% SWING ARM CPL. 08	1
3	77304066000	CHAIN SLIDING PROTECTION	1
4	77304066050	BUSHING F. CHAIN SLIDING PR.07	2
5	0009050103	% SPECIAL SCREW M 5,0X10	2
6	77313047000	BRAKE HOSE GUIDE LOWER 07	1
7	59009062013	SPECIAL SCREW M6X13 WS=8 10.9	2
8	54804034000	BUCKET F. SHAFT SEAL RING 03	4
9	0760253270	SHAFT SEAL RING 25X32X7	6
10	59404032000	BEARING SLEEVE 17X22X38,7 03	2
11	59004031100	% NEEDLE BEARING HK2212V	4
12	54603036000	STOP DISK 22,2X31,7X1	2
14	78004070000	% CHAIN GUIDE CPL.	1
15	59009062019	SPECIAL SCREW M6X19 WS=8 10.9	1
16	0025060506	HH COLLAR SCREW M6X50 TX30	1
17	77304070030	INSERTION NUT F. CHAIN GUIDE	1
18	50304090044	% PIVOT BEARING+BUSH. PDS '99	1
19	50329000044	TOOL BEARING MOUNTING PDS	1
20	78004060000	CHAIN GUARD 08	1
21	56509064100	SELF LOCKING NUT M6 10.9	1
22	0021060003	WASHER DIN9021-A 6,4	1
23	0017060203	EJOT PT SCREW K60X20 WS=6	1
25	77304037000	SWINGARM BOLT M16X1,5 07	1
26	54804038000	SELF LOCK.NUT M16X1,5 WS=19 03	1
27	58404041100	CLOSING COVER ROUND 03	4
28	77304066010	CHAIN GUARD CPL. 07-11	1
29	54603055051	PRESS IN NUT M6 STEEL ZINC	1
97	78004060010	CHAIN PROTECTION KIT EXC 08-11	x
98	77304070310	CHAIN GUIDE KIT REAR 08-12	x
99	59404230110	SWINGARM-REPAIR KIT 05-12	x

C107800490

\* NEW PART

X ON DEMAND

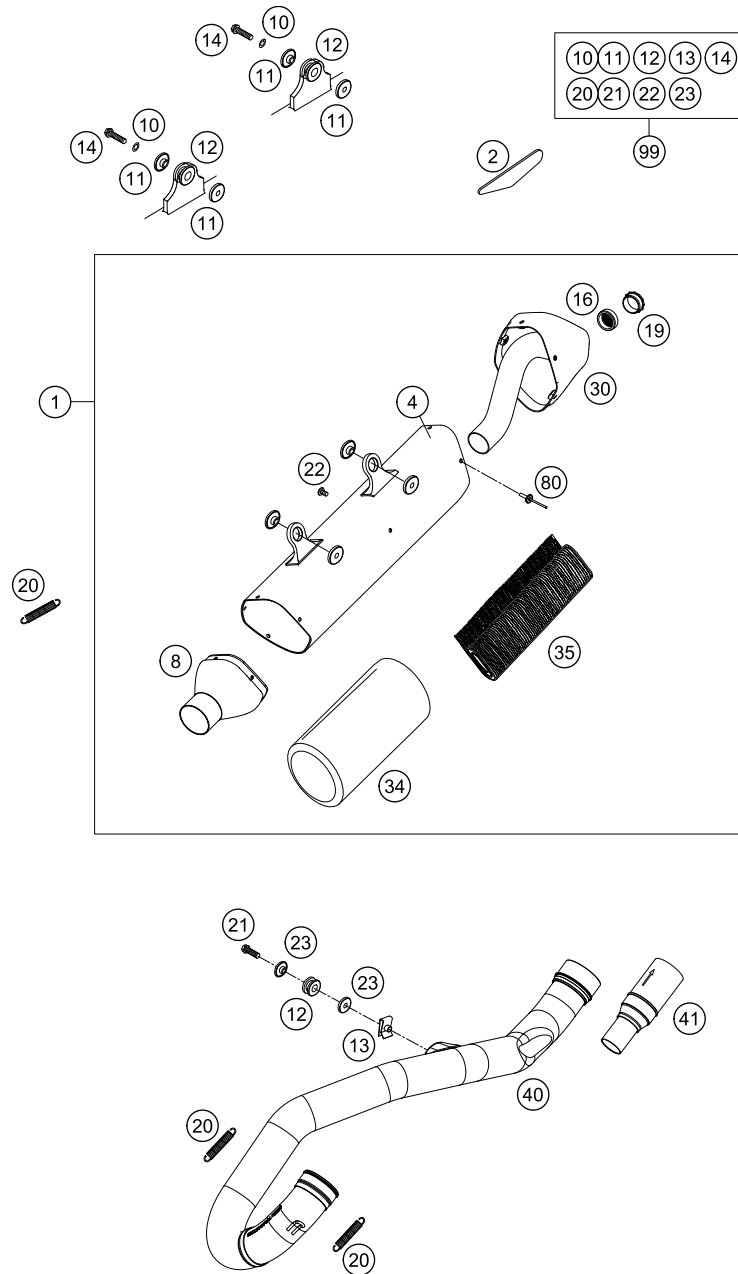

POS	PARTNUMBER	PARTNAME	PIECE
1	77005081000	SILENCER EXC-F THROTTLED 07	1
2	77308013050	THERMAL PROTECTION FOIL 07	1
4	77005081050	SILENCER HOUSING EXC-F 07	1
8	77005081109	CONNECTING CAP CPL. EXC-F 08	1
10	0137060003	SPRING WASHER DIN0137-B 6	2
11	77305069000	BUSHING 7.5x12x28x7.6 07	4
12	54605068000	EXHAUST BRACKET RUBBER BLACK	3
13	54603048000	RANGE CHANGE METAL NUT M8	1
14	0025060306	HH COLLAR SCREW M6X30 TX30	2
16	77005081065	THROTTLE ELEMENT CPL. EXC 07	1
19	77005081055	SIL. ELEMENT EXC-F 07	1
20	50305016000	TEN.SPRING L=62MM EY.MOVEABLE	3
21	0025080256	HH COLLAR SCREW M8X25 TX40	1
22	58605083010	SCREW TORX M5X10 05	12
23	59405069000	BUSHING FOR EXHAUST SUPPORT 03	2
30	77005081007	ENDCAP W. SILENCER ELEMENT 09	1
34	77005078315	% STUFFINGYARN 315 GRAMS	1
35	77005081016	% STUFFING YARN EXC-F 07	1
40	78005007000	EXHAUST PIPE 450 EXC-F 08	1
41	77005009033	CATALYST WELDED EXC 08	1
80	0011401200	DUMMY RIVET 4,0X12 ALU	x
99	00050000809	EXHAUST PARTS KIT 10-11	x

097800510

C097800510

\* NEW PART

X ON DEMAND



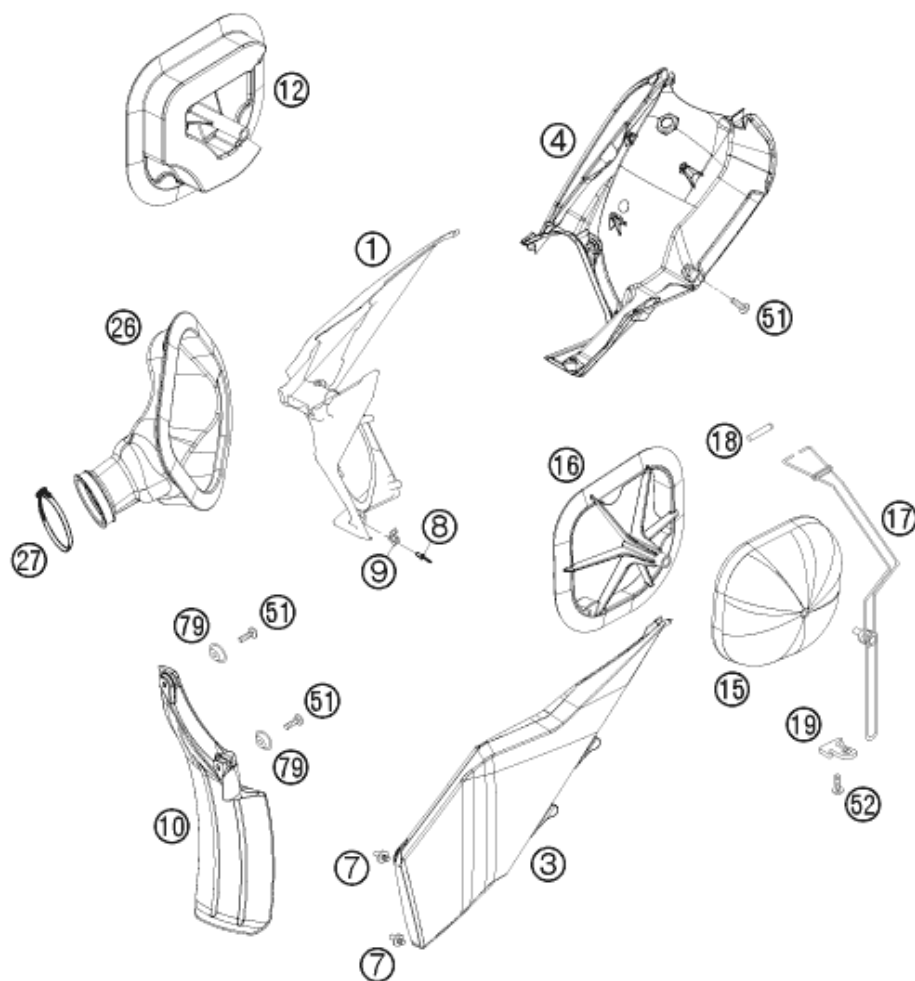

POS	PARTNUMBER	PARTNAME	PIECE
1*	7730600111030	AIR BOX PART BLACK	1
3	7730600300030	AIR BOX COVER SX BLACK 07	1
4	77306001020	REAR PART FILTER BOX 07	1
7	54806008051	QUICK RELEASE-NIPPLE 03	2
8	54806108052	BLIND RIVET 3,3X9,7 GROOVED 04	4
9	54806008050	QUICK RELEASE-SPRING HANGER	2
10	77306010000	FENDER FOR FILTER BOX	1
12	78006012000	THROTTLE CAP CPL. EXC 08	1
15*	78006015000	AIR FILTER	1
16	77306016000	FILTER CARRIER 4S SX 07	1
17	77306017000	FILTER SUPPORT CPL. 07	1
18	77306018000	FILTER SUPPORT BUSH 07	1
19	77306019000	FASTEN. DEVICE FILTER S. SX 07	1
26	78006026000	CARBURETOR CONNECTING 08	1
27	78006027000	HOSE CLAMP 45-65MM	1
51	0017060204	EJOT PT SCREW K6X20 ALU WS=6	x
52	0017060203	EJOT PT SCREW K6X20 WS=6	1
79	77304066050	BUSHING F. CHAIN SLIDING PR.07	2

087800611

C107800610

\* NEW PART

X ON DEMAND

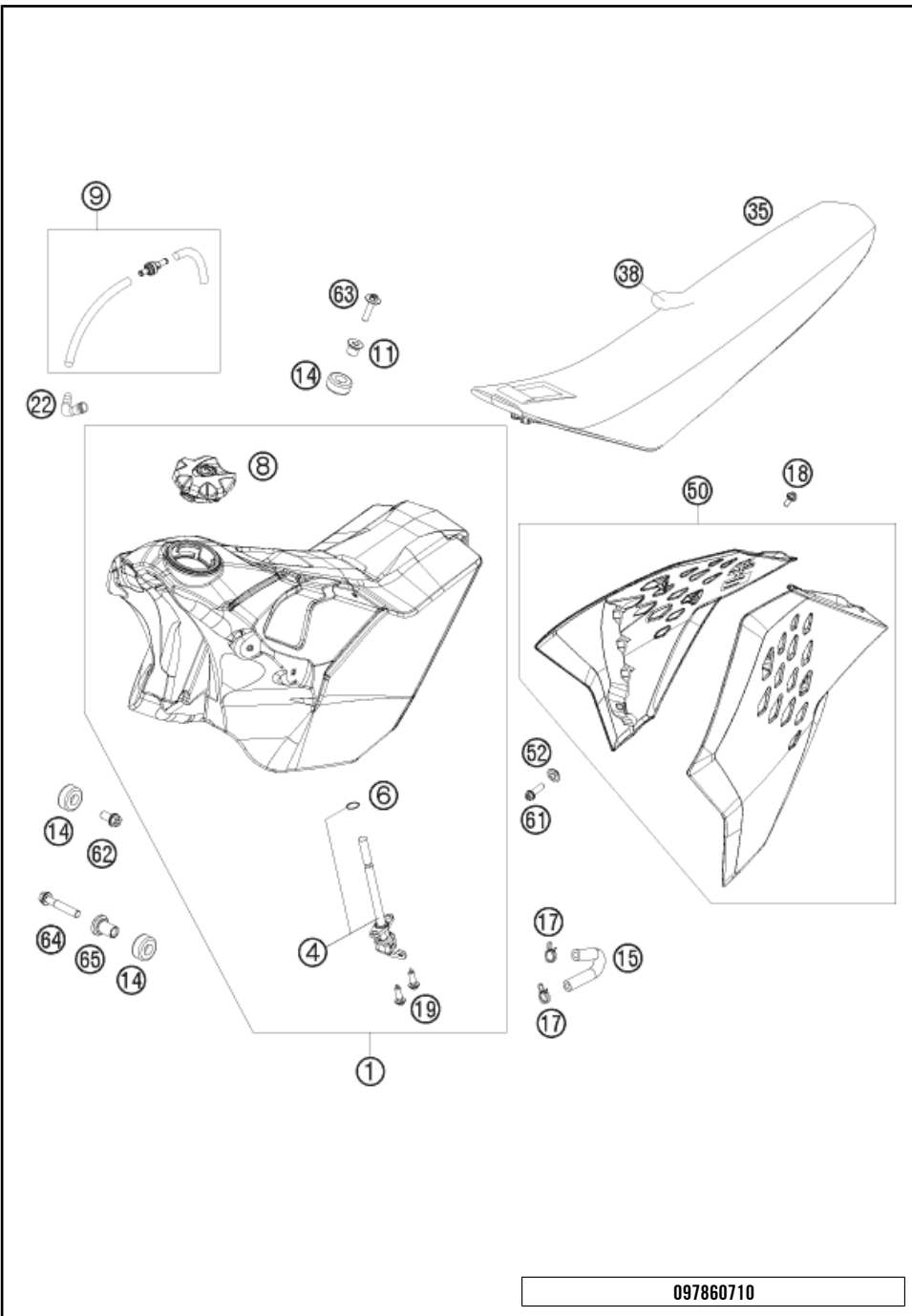

POS	PARTNUMBER	PARTNAME	PIECE
1	7800701306699	FUEL TANK CPL. 9,5L EXC SD 09	1
4	78007004000	GAS COCK ON/OFF/RES 08	1
6	0770110021	O-RING 11X2 VITON	1
8	7800700804404	% TANK PLUG ORANGE/BLACK	1
9	78007029000	TANK BREATHER HOSE + VALVE	1
11	77307026000	TANK BUSHING 07	1
14	50307014000	TANK ROLLER 12X26X12 '98	3
15	59007016000	FUEL HOSE 7,5X13MM	1
17	58031005000	CLAMP YDNAC 10128 12MM	2
18	0017060204	EJOT PT SCREW K60X20 ALU WS=6	8
19	0017060203	EJOT PT SCREW K60X20 WS=6	2
22	51030022000	ANGLE PIECE 90 DEGREE M10X1	1
35	78007040000	SEAT SIX-DAYS 08	1
38	78007040050	SEAT COVER SIX-DAYS 08	1
50*	7730805410030K	SPOILER KIT BLACK SD 10	1
52	50308052000	BUSH FOR SPOILER 6X11X16X5 MM	2
61	0025060206	HH COLLAR SCREW M6X20 TX30	2
62	0025060126	HH COLLAR SCREW M6X12 TX30	1
63	0024060273	COLLAR SCREW M6X27 TX	1
64	0025060356	HH COLLAR SCREW M6X35 TX30	1
65	78003001055	SUPPORT BUSH. TANK ROLL450/530	1

097860710

C107860712

\* NEW PART X ON DEMAND

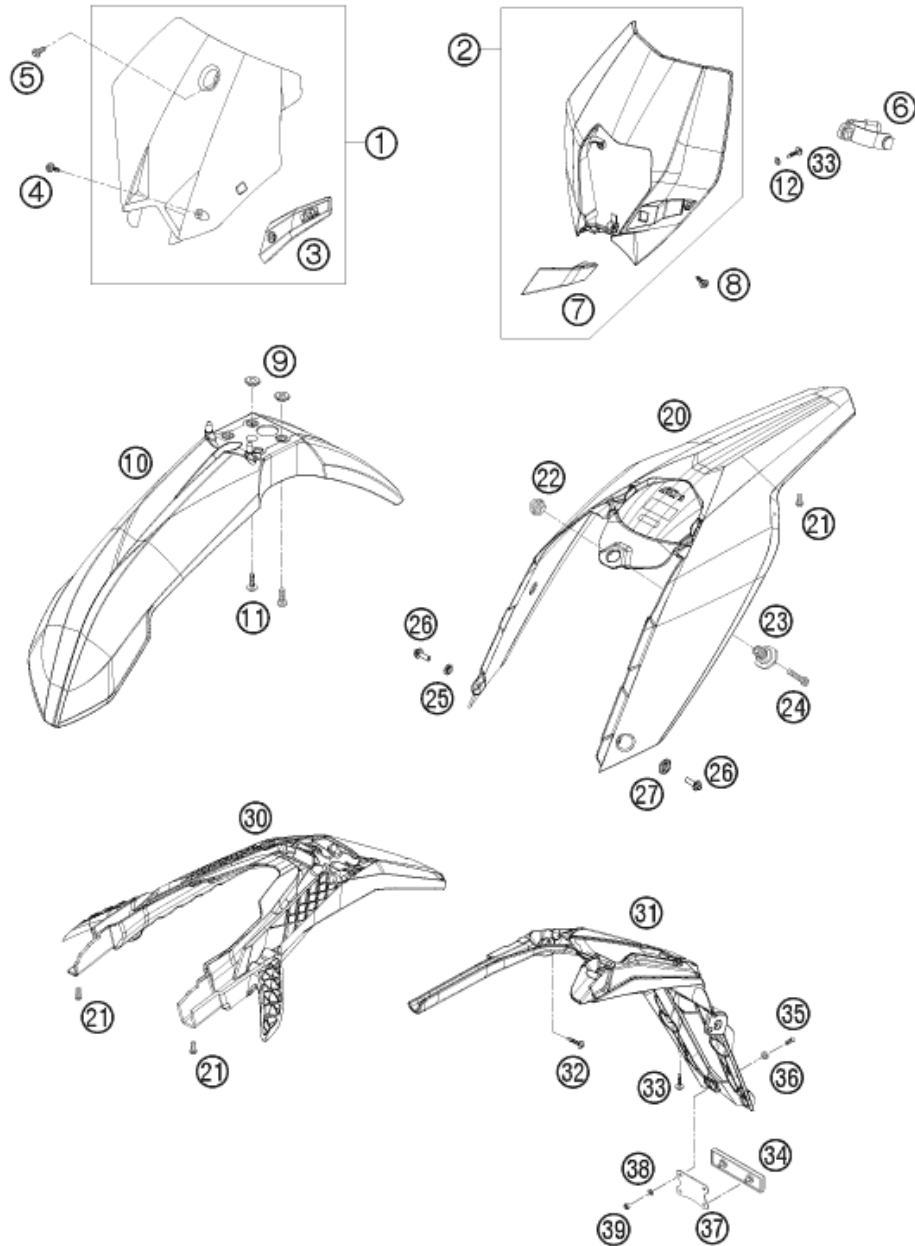

095030810

POS	PARTNUMBER	PARTNAME	PIECE
1	7730800704404	START NUMBER PLATE ORANGE 07	1
2	7800800100004	HEAD LIGHT MASK ORANGE 08	1
3	7730802200004	BRAKE HOSE GUIDE ORANGE 07	1
4	0017060204	EJOT PT SCREW K60X20 ALU WS=6	1
5	0024060106	HH COLLAR SCREW M6X10 TX30	1
6	50211086000	MASK RUBBER UFO WP '95	2
7	7800802200004	BRAKE HOSE GUIDE ORANGE 08	1
8	0081500181	% SCREW FOR PLASTIC D=5X18	3
9	54808020000	SPACER BUSHING 03	4
10	7730801000004	FRONT FENDER 07	1
11	0024060206	HH COLLAR SCREW M6X20 TX30	4
12	0125060003	WASHER DIN0125-A 6,4	1
20	7800801300004	REAR PART EXC ORANGE 08	1
21	0025050206	HH COLLAR SCREW M5X20 TX30	2
22	50314057050	COLLAR NUT M12X1/WS17 H=5MM	1
23	54807048000	BUSHING FOR SEAT FASTENING 03	1
24	0025060256	HH COLLAR SCREW M6X25 TX30	1
25	50308052000	BUSH FOR SPOILER 6X11X16X5 MM	1
26	0025060206	HH COLLAR SCREW M6X20 TX30	2
27	77306001030	COLLAR BUSHING 4,5/12,6/23	1
30	78008016000	NUMBER PL. CARRIER TOP PART 08	1
31	78008016050	NUMBER PL. CARRIER LOW PART 08	1
32	0017060303	SPECIAL SCREW T60 6X30 WS=6	2
33	0017060203	EJOT PT SCREW K60X20 WS=6	3
34	58412080000	REFLECTOR RED LC4 '98	1
35	0966050203	OVAL HEAD SCREW DIN0966-M 5X20	2
36	40006006000	WASHER 6MM	2
37	58412080050	BRACKET FOR REFLECTOR	1
38	0125050003	WASHER DIN0125-A 5,3	2
39	0985050003	SELF LOCKING NUT DIN0985-M 5	2

C095030811

\* NEW PART

X ON DEMAND



POS	PARTNUMBER	PARTNAME	PIECE
1*	52308399200	DECAL KIT EXC/XC-W SD 2010	1
2*	78008291200	DISPLACEM. STI. 450 EXC SD 10	1
3*	52000091	STICKER FRONT FORK-SET WP 48	1

C107800838

\* NEW PART

X ON DEMAND

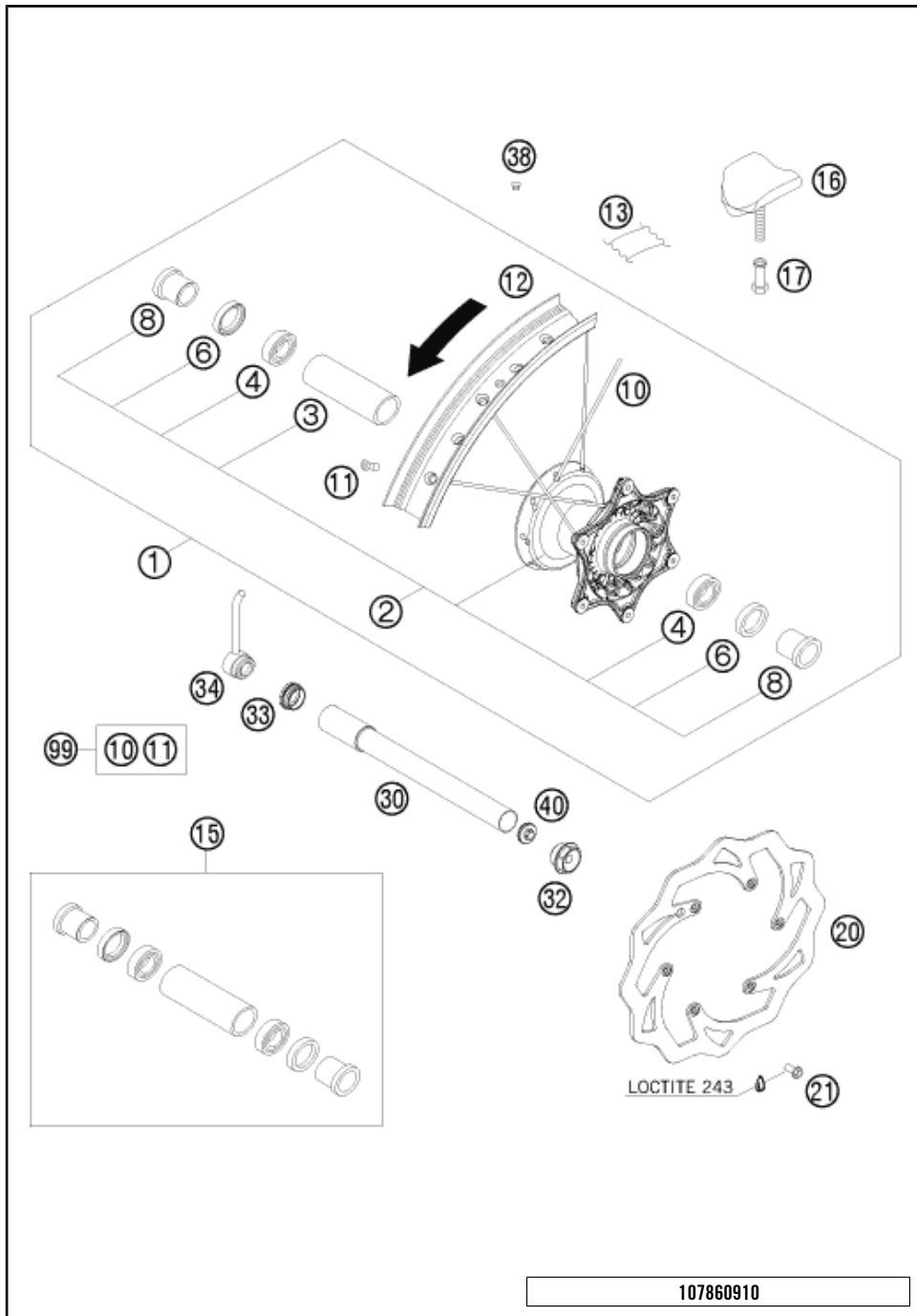

POS	PARTNUMBER	PARTNAME	PIECE
1	7800900124430	FRONT WHEEL CPL.1,6X21"EXC.10	1
2	78009010144	FRONT WHEEL HUB CPL.	1
3	54809011000	BEA.SPACERTUBE 35X2 L=79,4 03	1
4	0625069068	GR.BALL BEAR.6906 DDU2CG23S6NM	2
6	0760354771	SHAFT SEAL RING 35X47X7 TC	2
8	78009012000	SPACER BUSHING F. FR. WHEEL 08	2
10	78009174226	SPOKE M4,5x226-21" 08	36
11	50309072100	SPOKE NIPPLE M4,5X0,75 8X21	36
12	7800907000030	RIM FRONT 1,6X21" EXCEL AL7	1
13	50309073000	RIM BAND 21"	1
15	78009015000	FRONT WHEEL REP. KIT	x
16	51009100100	RIM LOCK VM1 (1,60")	1
17	50310090050	NUT FOR WHEEL HOLDER '96	1
20	77309060000	BRAKE DISC FRONT 260	1
21	59009062013	SPECIAL SCREW M6X13 WS=8 10.9	6
30	77309081000	WHEEL SPIN.FR. D=26 M24x1,5 07	1
32	54809082000	SPINDLE SCREW M24X1,5 WS=27 03	1
33	54809081050	PLUG BUSHING WS=27 03	1
34	54809081060	FRONT AXLE PULL 26MM 04	1
38	55003135000	PLUG FOR RIM	x
40	54809081070	AUXILIARY SCREW FRONT 06	1
99	00050000905	SPOKE KIT FRONT "21"	x

107860910

C107860910

\* NEW PART X ON DEMAND

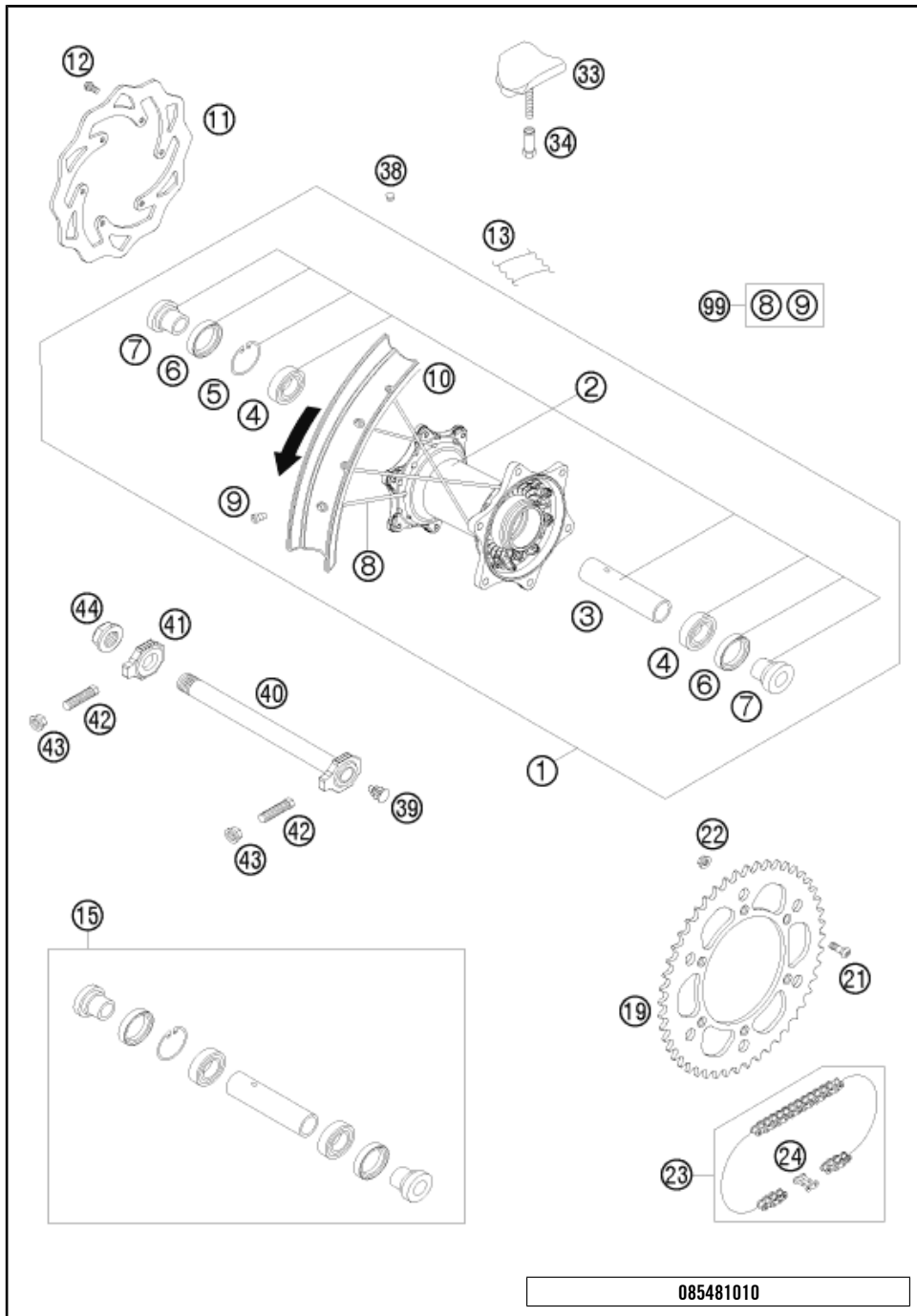

085481010

POS	PARTNUMBER	PARTNAME	PIECE
1	7801000114430	REAR WHEEL CPL. 2,15X18"EXC.09	1
2	78010010144	REAR WHEEL HUB CPL.	1
3	59010011000	BUSHING SPACER TUBE 121,5MM 01	1
4	0625060058	GR.BALL BEAR.6005 DDU2CG23S6NM	2
5	0472047175	CIRCLIP DIN0472-47X1,75	1
6	0760324771	SHAFT SEAL RING 32X47X7 BSL	2
7	78010016000	BUSHING FOR HUB 08	2
8	78010174193	SPOKE M5X193- 18"	36
9	58309072100	SPOKE NIPPLE M5-TA 8X21MM	36
10	7801007000030	RIM 2,15X18" EXCEL AL7 BLACK	1
11	77310060000	BRAKE DISC REAR 220	1
12	59009062013	SPECIAL SCREW M6X13 WS=8 10.9	6
13	50310073200	RIM BAND 18" AND 19"	1
15	78010015000	REAR WHEEL REP. KIT	1
19	5841005103804	REAR SPROCKET ORANGE 38-T	x
19	5841005104004	REAR SPROCKET ORANGE 40-T	x
19	5841005104204	REAR SPROCKET ORANGE 42-T	x
19	5841005104404	REAR SPROCKET ORANGE 44-T	x
19	5841005104804	REAR SPROCKET ORANGE 48-T	x
19	5841005104904	REAR SPROCKET ORANGE 49-T	x
19	5841005105004	REAR SPROCKET ORANGE 50-T	x
19	5841005105104	REAR SPROCKET ORANGE 51-T	x
19	5841005105204	REAR SPROCKET ORANGE 52-T	x
21	0019080266S	COUNTER-SUNK SCREW ISA45 M8X26	6
22	06923080003	HEXAGON NUT DIN EN1661 M8 SW13	6
23	78010167118	CHAIN DID 118 ROLLS	1
24	78010166000	CONNECTING LINK F. 78010167118	1
33	54010100100	RIM LOCK VM3 (2.15")	2
34	50310090050	NUT FOR WHEEL HOLDER '96	2
38	55003135000	PLUG FOR RIM	x
39	50210086000	COVERING CAP SFL16	1
40	77310085044	WHEEL SPINDLE RE. CPL.265MM 07	1
41	50310084000	CHAIN TENSIONER R/S 2000	1
42	50304040100	SCREW M10X1,25X50 WS=10	2
43	58414030000	HH COLLAR NUT M10X1,25 WS=13	2
44	50310099000	HEXAGON NUT M20X1,5 '98	1
99	00050000901	SPOKE KIT REAR 18"	x

C107801010

\* NEW PART

X ON DEMAND

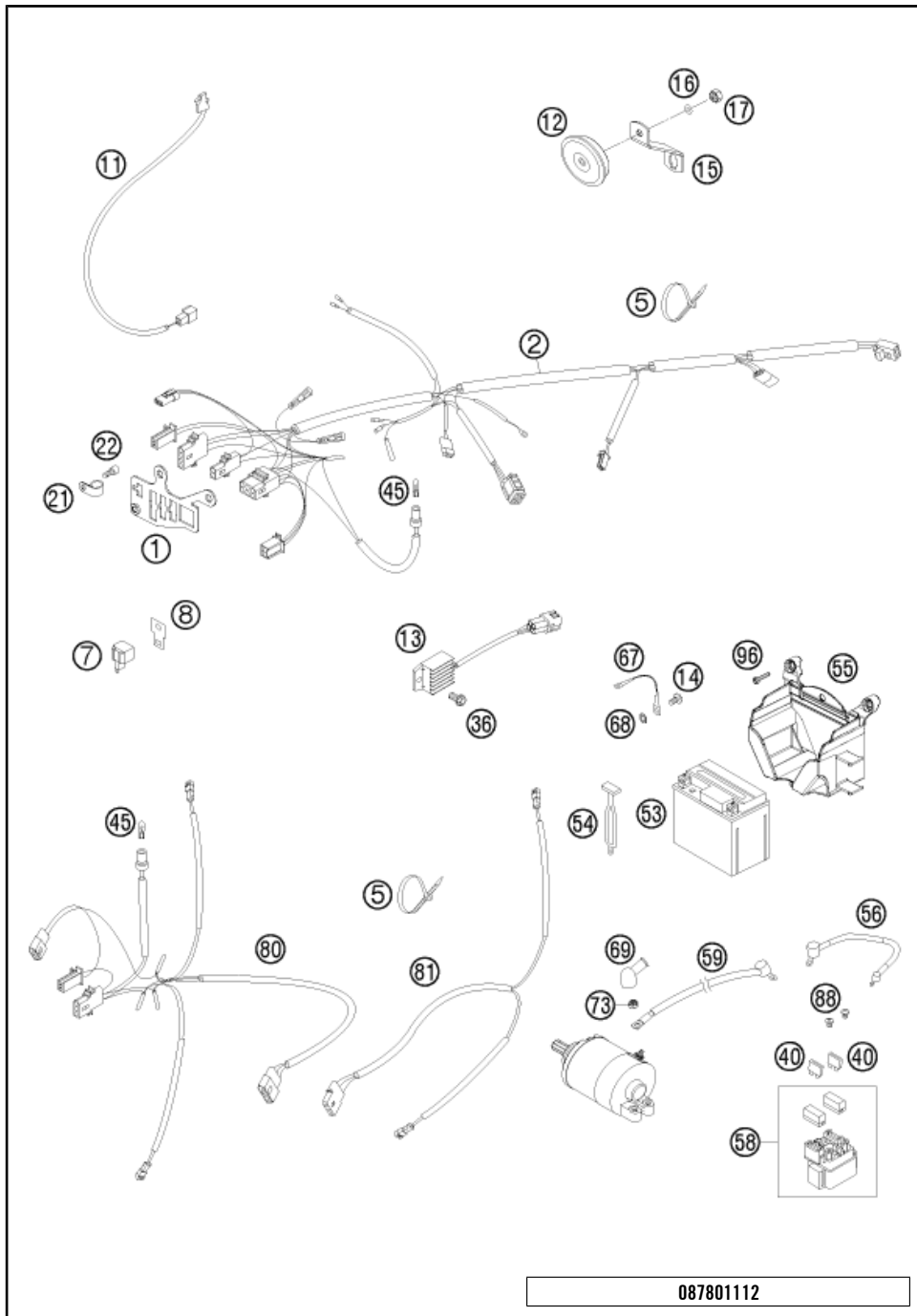

087801112

POS	PARTNUMBER	PARTNAME	PIECE
1	54811083100	SUPPORT BRACKET EXC 2005	1
2	59411075150	%WIRING HARNESS 250-525EXCEU06	1
5	44011076100	% CABLE TIE 100/2,5MM BLACK	x
5	44011076200	CABLE TIE 200/3,6MM BLACK	x
5	44011076305	CABLE TIE 300/4,8MM BLACK	x
7	44611207200	FLASHER UNIT 97	1
8	58211031100	BRACKET FOR FLASHER RELAY	1
11	50311050100	BRAKE LIGHT SWITCH FRONT 2002	1
12	50311060200	DC HORN 12V 07	1
13	80011034000	VOLTAGE REGULATOR 04	1
14	0009050103	% SPECIAL SCREW M 5,0X10	1
15	78011061000	HORN BRACKET EXC 08	1
16	0125050003	WASHER DIN0125-A 5,3	1
17	0934050003	HEXAGON NUT DIN0934-M 5	1
21	57013070000	PVC-CLAMP 7/16" HEYCO 3377	1
22	0912050083	AH SCREW DIN 912 M 5X8	1
36	0025060126	HH COLLAR SCREW M6X12 TX30	1
40	58011109110	FUSE 10 A 2000	2
45	49111425000	% BULB 12V 1,2W (W2X4,6D)	2
53	58511053000	BATTERY 12V 4AH YTX5L-BS	1
54	50303018000	RUBBER L=145MM	2
55	78011055000	BATTERY CASE EXC 08	1
56	58711086000	WIRING HARNESS BATTERY DUKE'99	1
58	58211058000	STARTER RELAY 12V '99	1
59	58411059100	STARTERCABLE 700 MM '97	1
67	58411097100	GROUND CABLE D=6MM L=140MM '97	1
68	58411098100	CONTACT WASHER M6 VSV-K6	1
69	58440099000	PROTECTION CAP F. STARTER ENG.	1
73	0985060003	SELF LOCK. NUT DIN0985-M 6	1
80	59011080100	FLASH. WIRINGHARNESS FRONT 06	1
81	59011081100	% FLASH. WIRINGHARNESS REAR 06	1
88	0902060083	AH OVAL SCREW ISO 7380 M 6X8	2
96	0017060203	EJOT PT SCREW K6X20 WS=6	3

C087801112

\* NEW PART

X ON DEMAND

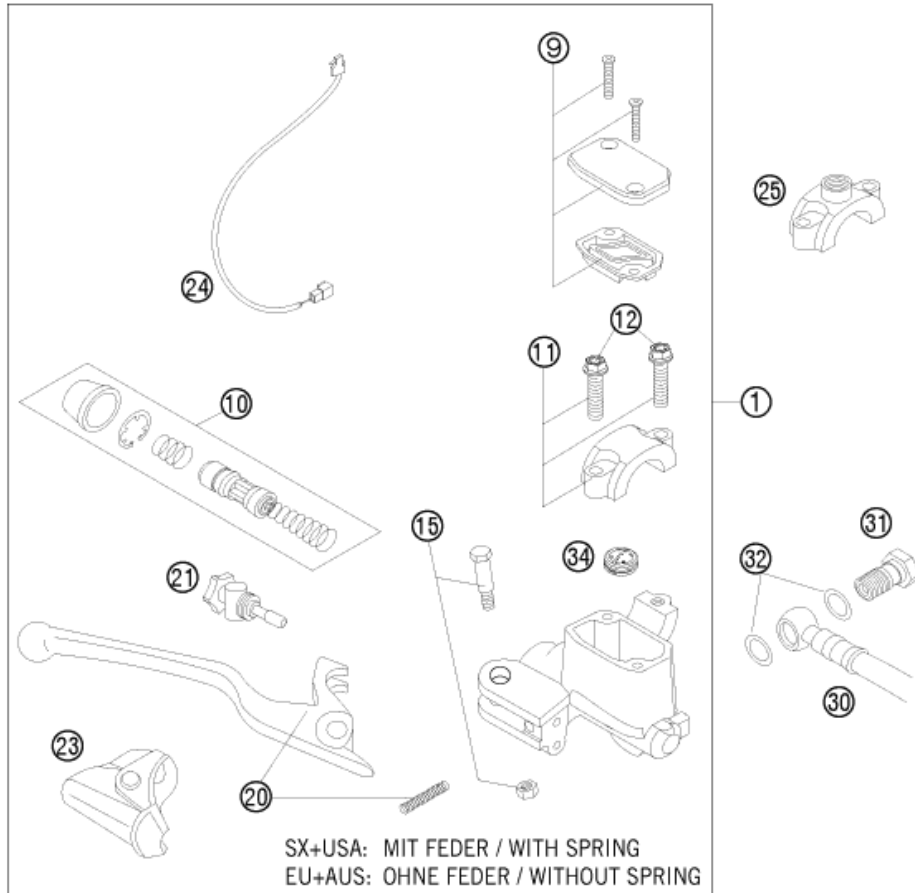

POS	PARTNUMBER	PARTNAME	PIECE
1	77013001144	HAND BRAKE CYLINDER CPL.EXC 09	1
9	50313003000	HANDBRAKE CYL.COVER CPL.NATURE	1
10	54813008300	REP.SET PISTON D=9MM 2009	1
11	50313005000	CLAMP CPL. NATURE	1
12	0025060256	HH COLLAR SCREW M6X25 TX30	2
15	50313006100	LEVER SCREW CPL. 2001	1
20	54813002200	HAND BRAKE LEVER + SPRING 2009	1
21	54813007300	ADJUSTING SCREW CPL. SX 2009	1
23	50313004000	PROTECTION CAP HAND BRAKE CYL.	1
24	50311050100	BRAKE LIGHT SWITCH FRONT 2002	1
25	58012040150	CLAMP FOR MIRROR '94	1
30	59013011000	BRAKEHO. FRONT 1300MM 2000	1
31	54813020200	% BANJO SCREW 08	1
32	0603100141	COPPER GASKET DIN7603-10X14X1	2
34	54802051000	VALVE	1
80	00062030000	BRAKE FLUID DOT5.1 0,25L	1

095511310

C107801311

\* NEW PART

X ON DEMAND



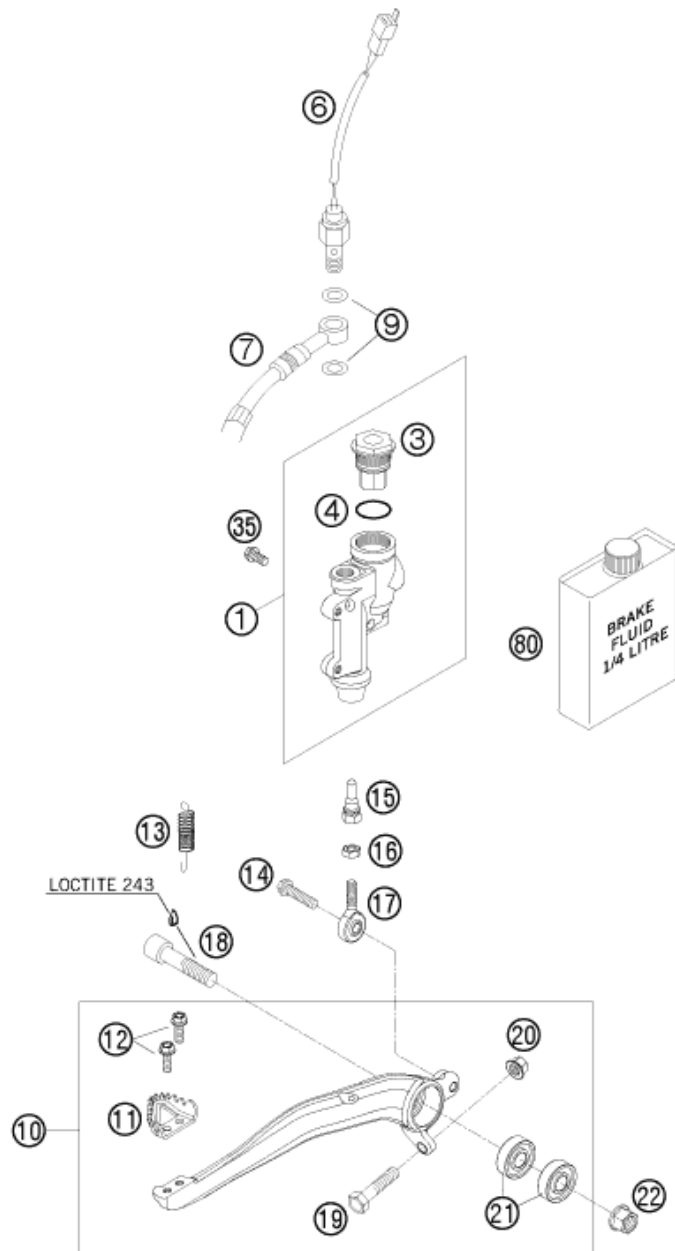

POS	PARTNUMBER	PARTNAME	PIECE
1	77013060044	REAR BRAKE CYLINDER CPL.SX 09	1
3	54813062100	REAR BRAKE CYL. COVER CPL. 04	1
4	54813063000	FOOT-BRAKE CYL. GASKET SX 03	1
6	50311051100	BRAKE LIGHT SWITCH REAR '98	1
7	54813070000	BRAKE HOSE REAR 655MM 03	1
9	0603100141	COPPER GASKET DIN7603-10X14X1	2
10	78013050044	FOOT BRAKE LEVER CPL.	1
11	54813051000	STEP PLATE FOR BRAKE LEVER	1
12	0025050126	HH COLLAR SCREW M5X12 TX30	2
13	54603062000	RETURN SPRING FOR BRAKE LEVER	1
14	0025060206	HH COLLAR SCREW M6X20 TX30	1
15	54813056000	PUSH ROD L=28MM 03	1
16	0934060003	HEXAGON NUT DIN0934-M 6	1
17	54813055000	SWIVEL HEAD KA6 03	1
18	0912100406	% AH SCREW DIN6912 M10X40 10.9	1
19	59001037000	SPECIAL SCREW M8X26 WS=10	1
20	46030045000	COLLAR NUT M8 WS=10	1
21	0625060002	BALL BEARING SKF 6000-2RS1	2
22	54630044000	COLLAR NUT M10 WS=13	1
35	0025060126	HH COLLAR SCREW M6X12 TX30	2
80	00062030000	BRAKE FLUID DOT5.1 0,25L	1

097801330

C107801333

\* NEW PART

X ON DEMAND

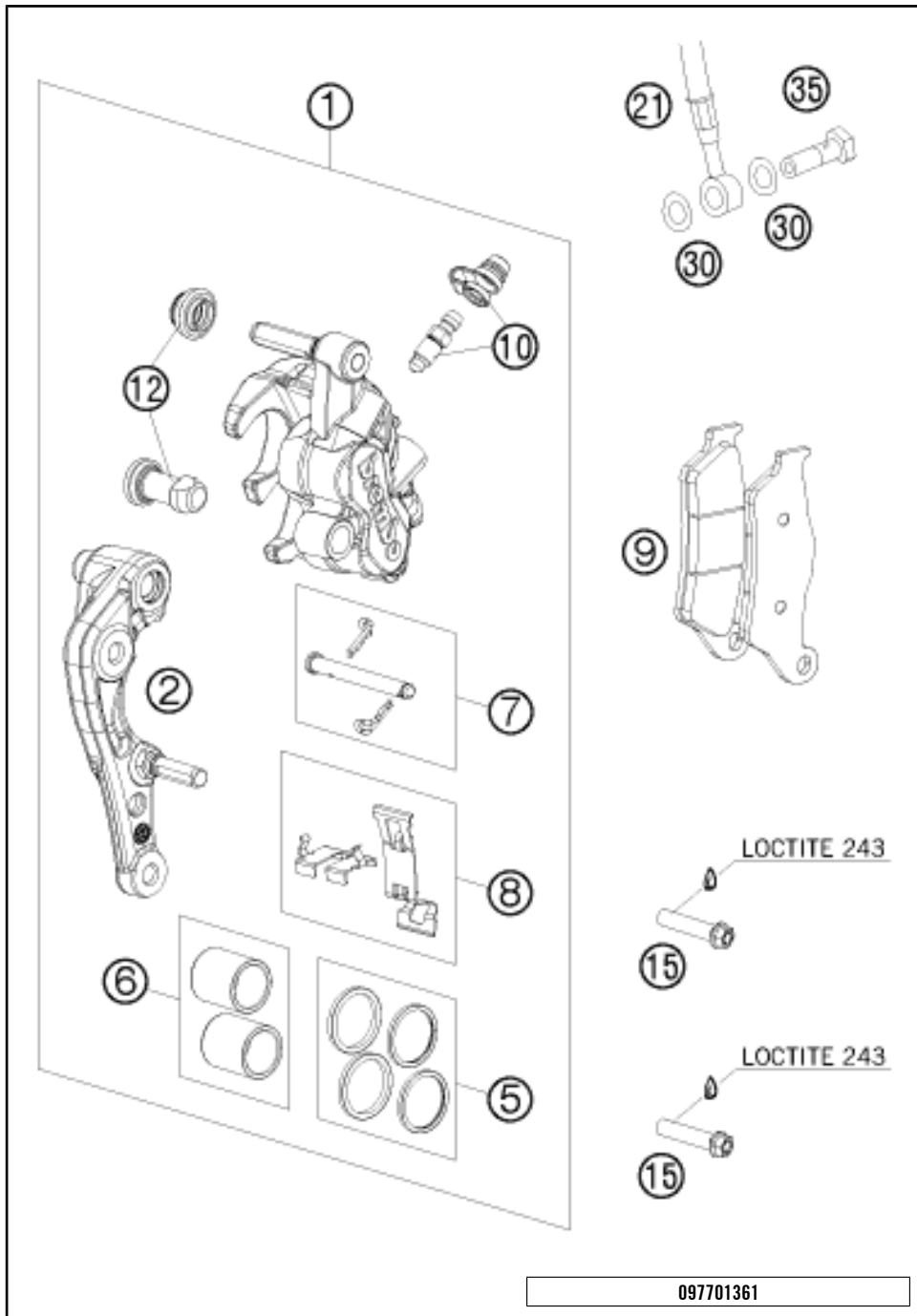

POS	PARTNUMBER	PARTNAME	PIECE
1	7701301500101	CALIPER NAT. WITHOUT PADS	1
2	77013014000	BRAKE CALIPER SUPPORT FRONT 09	1
5	77013021000	REP. KIT SEALS 24MM	1
6	77013019000	REP. KIT PISTON 24MM	1
7	77013017000	BOLT CPL. 09	1
8	77013018000	RETAINING PLATE SET BREMBO	1
9	77013020000	BRAKE PADS TOYO B153	1
10	61013020100	BLEEDER SCREW WITH CAP	1
12	54613218000	CUP SET SHORT	1
15	0025080356S	HH COLLAR SCREW M8X35 TX40	2
21	59013011000	BRAKEHO. FRONT 1300MM 2000	1
30	0603100141	COPPER GASKET DIN7603-10X14X1	2
35	50213025000	HOLLOW SCREW M10X1X19	1

097701361

C107801361

\* NEW PART X ON DEMAND

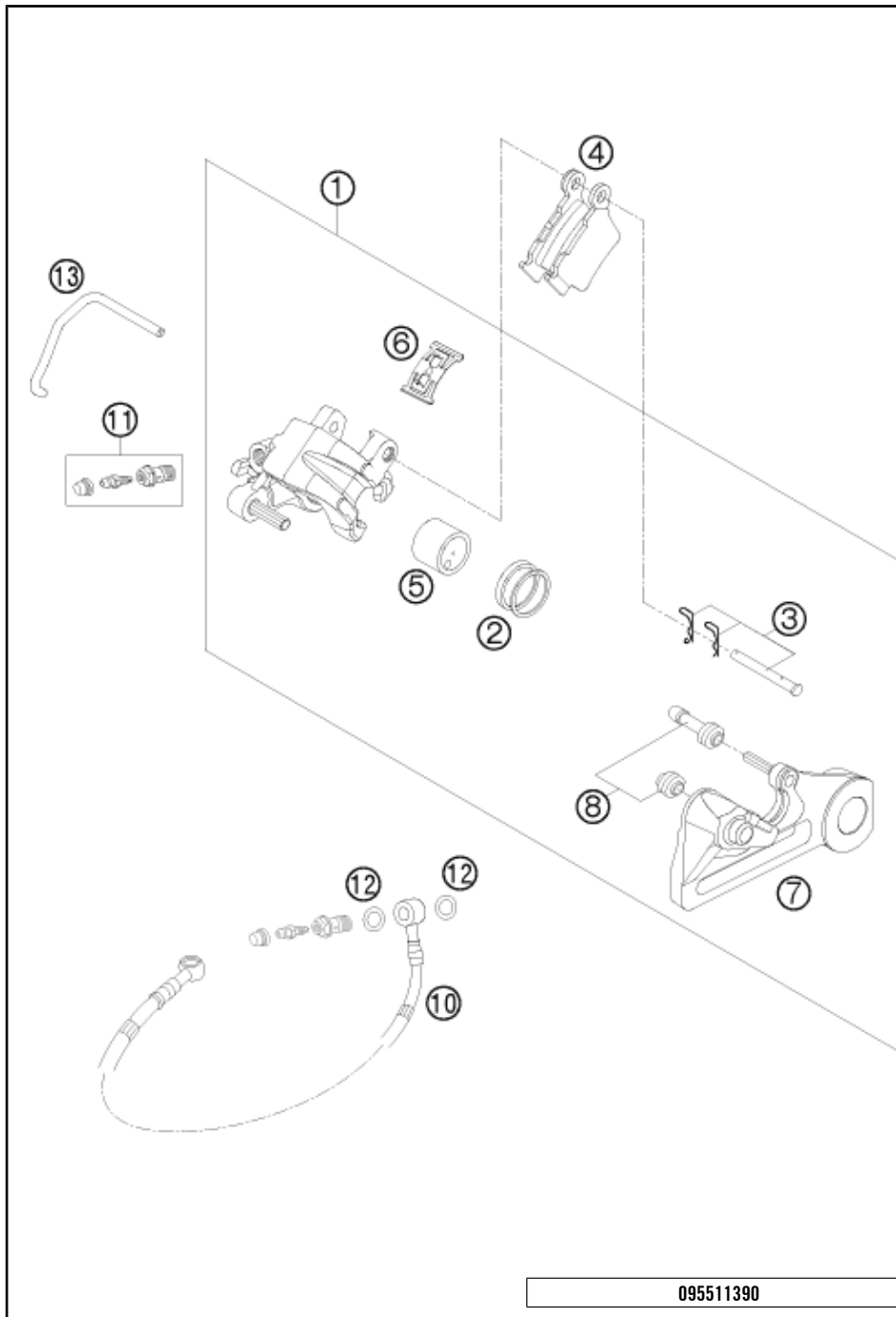

POS	PARTNUMBER	PARTNAME	PIECE
1	54813080101	BRAKE CAL. RE. - WITHOUT PADS	1
2	50313081200	REPAIR KIT SEALING RINGS 26MM	1
3	54813082000	BOLT SET FOR BRAKE CALIPER 03	1
4	54813090300	BRAKE PAD SET REAR TOYO	1
5	54813083000	BRAKE PISTON 26MM 2003	1
6	54813018000	RETAINING SPRING SET 2003	1
7	54813075000	BRAKE CALIPER SUPPORT REAR	1
8	54613218000	CUP SET SHORT	1
10	54813070000	BRAKE HOSE REAR 655MM 03	1
11	62513020000	BLEEDER SCREW CPL. 05	1
12	0603100141	COPPER GASKET DIN7603-10X14X1	2
13	50313082200	*BRAKE PAD RETAINING PIN	1

095511390

C105511390

\* NEW PART

X ON DEMAND

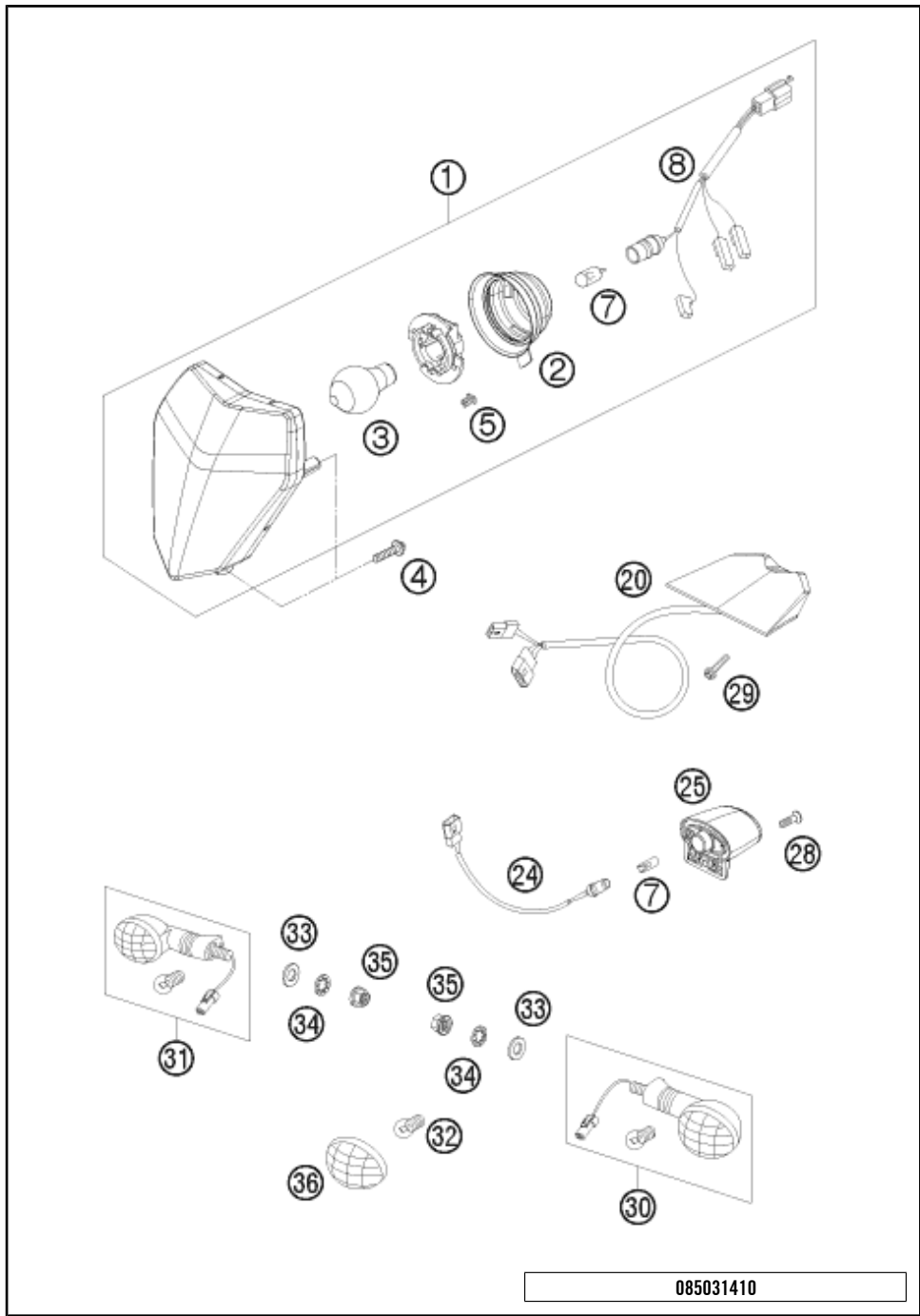

POS	PARTNUMBER	PARTNAME	PIECE
1	78014001000	HEAD LIGHT CPL. EXC-EU 08	1
2	54814001050	RUBBER CAP FOR HEAD LIGHT 05	1
3	44111038000	BILUX-BULB 12V 35/35W BA20D	1
4	0081050181	SCREW FOR PLASTIC K50X18 T20	3
5	78014009000	DRAIN HOLE COVER	1
7	49011435100	BULB 12V 5W (W2,1X9,5D) PHIL.	2
8	54811001050	CABLE FOR HEAD LIGHT 2005	1
20	78014040000	REAR LIGHT EXC-EU 2008	1
24	78011093000	WIRING H. LICENSE PL. ILLUM.08	1
25	75014047000	LICENSE PLATE ILLUMINATION 07	1
28	0081250181	SCREW FOR PLASTIC 50X18 T20	1
29	0017060203	EJOT PT SCREW K60X20 WS=6	2
30	54814025200	FLASHER CPL. FR.L/S RE.R/S 09	2
31	54814026200	FLASHER CPL. FR.R/S RE.L/S 09	2
32	44111015100	BULB 12V 10W (BA15S)	4
33	0125100003	WASHER DIN0125-A10,5	4
34	0797100003	LOCK WASHER DIN6797-J10,5 ZI	4
35	58414030000	HH COLLAR NUT M10X1,25 WS=13	4
36	54814028000	FLASHER LENS L/S R/S 05	4

085031410

C087801410

\* NEW PART

X ON DEMAND

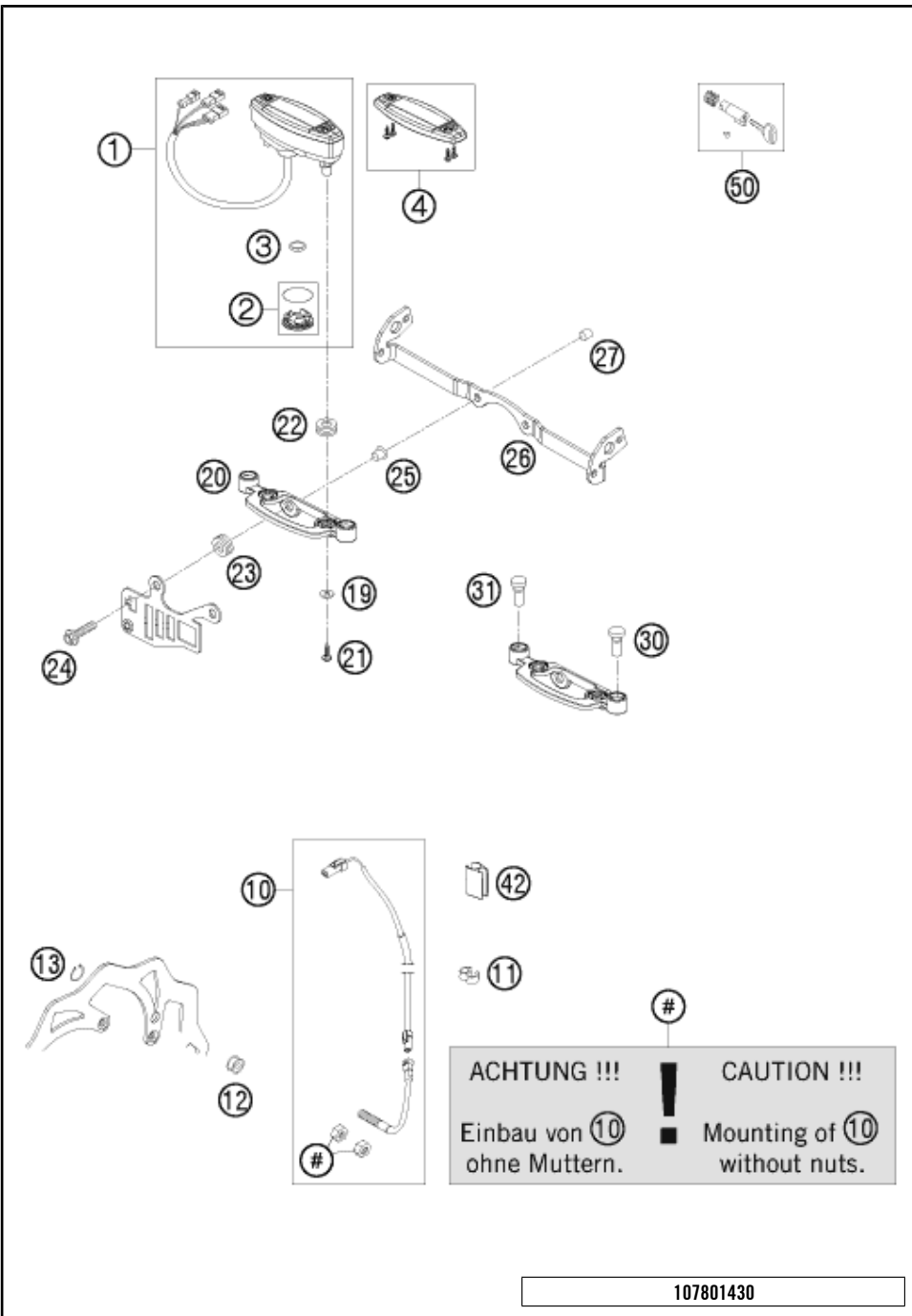

POS	PARTNUMBER	PARTNAME	PIECE
1	54814069000	SPEEDOMETER KM/H F. 21" 2005	1
2	54814069010	BATTERY COVER F. SPEEDOM. 2005	1
3	58314068000	BATTERY F. SPEEDOM. M.A.E. 02	1
4	54814069020	SPEEDOMETER TOP PART 05	1
10	54814068100	CABLE FOR DIGITAL SPEEDOM. 06	1
11	55011022100	CLAMP D=6/8MM, BLACK	3
12	54814069050	MAGNET FOR DIGITAL SPEEDOM. 03	1
13	0471009104	CIRCLIP DIN0471- 9X1 INOX	1
19	0021050003	WASHER DIN9021-A 5,3	2
20	54814060000	SPEEDOMETER BRACKET 05	1
21	0081050121	SCREW FOR PLASTIC K50X12 T20	2
22	58214069051	RUBBER GROMMET 16X10,8X3 02	2
23	31008060000	RUBBER SLEEVE D=8MM OPEN	2
24	0025060306	HH COLLAR SCREW M6X30 TX30	2
25	58314060050	SPACER BUSH. F. SPEEDOMET.BRA.	2
26	78014033000	FLASHER BRACKET EXC 08	1
27	50208020000	SPACER BUSHING 7X10X7,5	2
30	58011021300	H.BEAM INDICATOR LIGHT BLUE'98	1
31	58011024300	FLASHER INDICAT.LIGHT GREEN'98	1
42	54813026000	CABLE SUPPORT 10/6MM 06	2
50	78003035000	STEERING HEAD LOCK 08	1

107801430

C107801431

\* NEW PART X ON DEMAND

①  
OHNE ABBILDUNG  
WITHOUT ILLUSTRATION

②  
TECHNISCHE DOKUMENTATION  
TECHNICAL DOCUMENTATION  
DOCUMENTACION TECNICA  
DOCUMENTATION TECHNIQUE  
NOTE TECNICHE

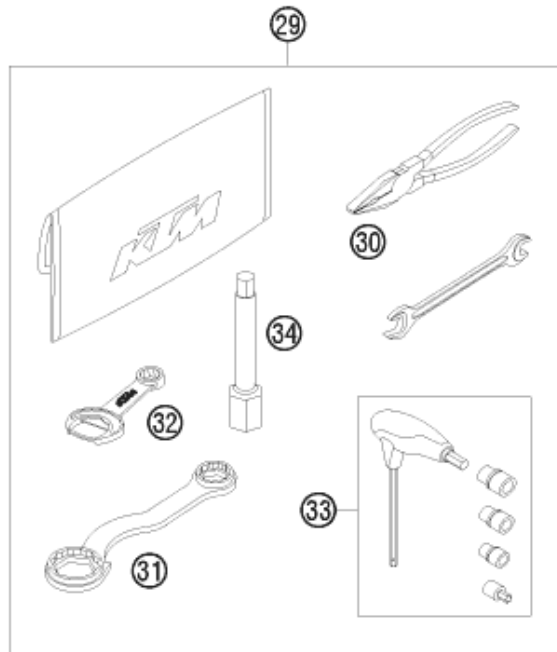

087802001

POS	PARTNUMBER	PARTNAME	PIECE
0	312313	KTM BALLPOINT PEN ORANGE	1
0	3210039	* CUSTOMER WELCOME LETTER	1
0	312305	DOCUMENTS BAG 2006	1
0	78003040033	FOOTREST L/S + R/S CPL. 09	1
0	77303094100	PLASTIC FRAME PROTECTION SET	1
0	0125050003	WASHER DIN0125-A 5,3	2
0	0985050003	SELF LOCKING NUT DIN0985-M 5	2
0	58511053000	BATTERY 12V 4AH YTX5L-BS	1
0	58412040000	MIRROR L/S 98	1
0	58412041000	MIRROR R/S 98	1
0	58412040050	SUPPORT FOR MIRROR LC4 '98	2
0	58012040150	CLAMP FOR MIRROR '94	2
0	58412080000	REFLECTOR RED LC4 '98	1
0	58412080050	BRACKET FOR REFLECTOR	1
0	0966050203	OVAL HEAD SCREW DIN0966-M 5X20	2
0	40006006000	WASHER 6MM	2
0	50033029013	FRONT SPROCKET 13-T	1
0	5841005105204	REAR SPROCKET ORANGE 52-T	1
0	0019080266S	COUNTER-SUNK SCREW ISA45 M8X26	6
0	0019080206S	FLAT HEAD SCREW M. ISA45 M8X20	1
0	78010165116	CHAIN DID 116 ROLLS	1
0	54809081060	FRONT AXLE PULL 26MM 04	1
0	50313082200	*BRAKE PAD RETAINING PIN	1
0	SXS08125610	BLEEDER VALVE SET	1
0	77202002000	% BAR PAD CPL.	1
0	78003190000	SKID PLATE PLASTIC	1
0	7700207900004	HAND GUARDS CPL.L/S+R/S OR. 06	1
0	77306016000	FILTER CARRIER 4S SX 07	1
1	3CF8403J2EN	SPC CHASSIS 450 EXC EU SD 2010	1
1	3CM089521JEN	SPC ENGINE 450 EXC 2010	1
1	3211355EN	* OWN.MAN.400-530 EXC/XC-W/S09	1
29	78029099000	% TOOL SET 08	1
30	53012028200	GRIP ORANGE B&F	1
31	50329080100	WRENCH SW=17/21/27/32 B&F	1
32	50329071100	WRENCH WS=13 B&F + OPENER	1
33	60029070200	T-WRENCH WS=6/8/10 TX=45 B&F	1
34	78029072000	SPARK PLUG SOCKET	1

C107802012

\* NEW PART

X ON DEMAND



WWW.KTM.COM



KTM-Sportmotorcycle AG  
5230 Mattighofen, Austria  
[www.ktm.com](http://www.ktm.com)



**KTM**\_POWERPARTS

**KTM**\_POWERWEAR

**KTM**\_ORIGINAL SPARE PARTS



3CF 8403J2EN

Art. Nr.: 3CF 8403J2EN 9. Jan 2013