

SCHALTPLAN » WIRING DIAGRAM

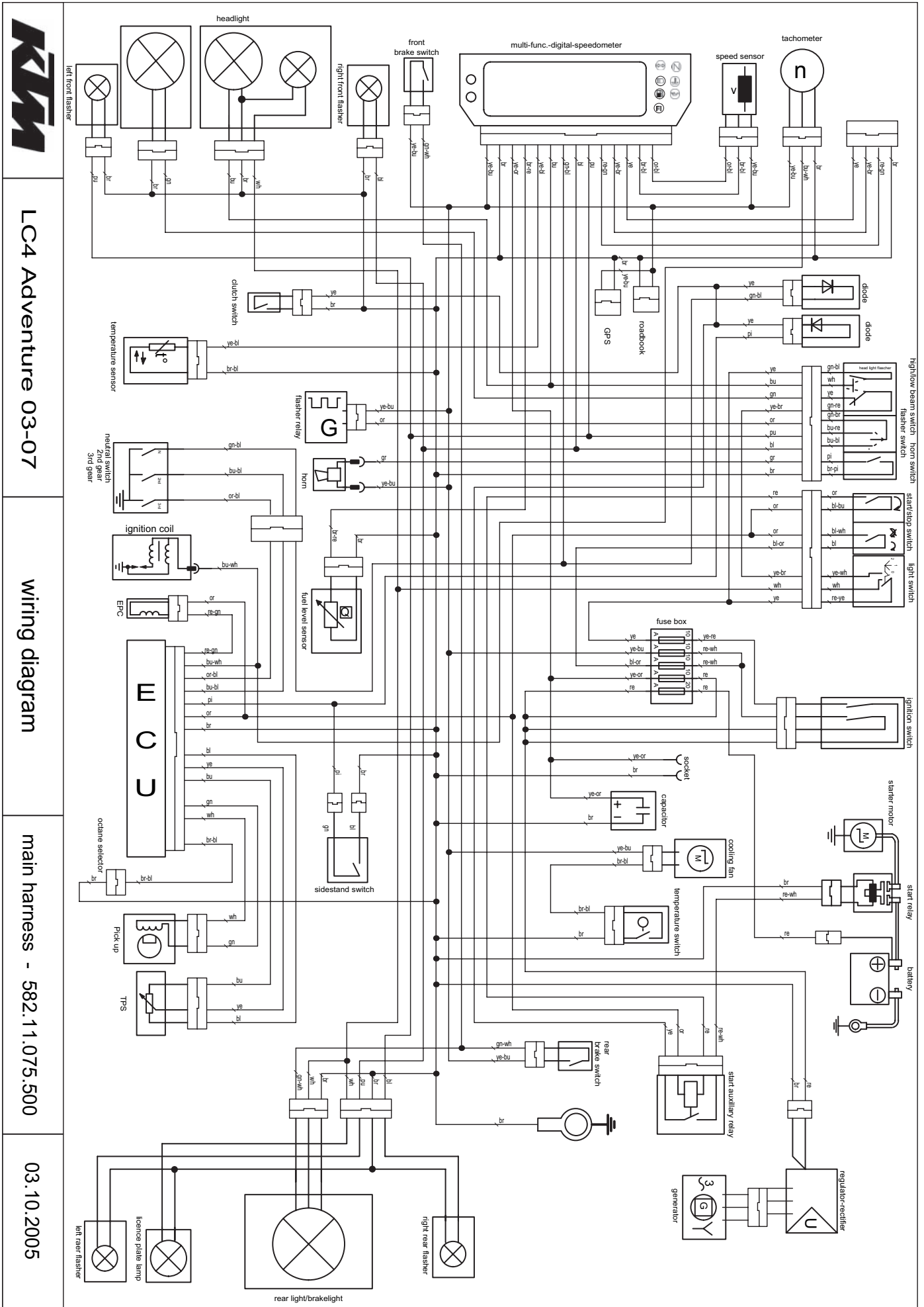

LC4 Adventure 03-07

wiring diagram

main harness - 582.11.075.500

03.10.2005

SCHALTPLAN » WIRING DIAGRAM

ignition switch

	r-w	r-w	r-w	o	y-r	r-w
ON 		●	●		●	●
OFF						
LOCKED						



brake switch

cable harness	gn-wh	ye-bu
cable switch	bl	bl
pushed 	●	●
unpushed		

sidestand switch

cable harness	br	pi
cable switch	bl	bl
folded up 	●	●
folded down		

high/low beam switch

cable harness	bu	gn	ye-br
cable switch	wh	ye	gn-re
LO 		●	●
HI 	●	●	



clutch switch

switch position	ye	br
pulled 	●	●
unpulled		

horn switch

cable harness	gr	br
cable switch	pi	br-pi
HORN 	●	●
OFF		



flasher switch

cable harness	or	pu	bl	gr	br
cable switch	gn-br	bu-re	bu-bl	pi	br-pi
TURN L 	●	●			
TURN R 	●	●			
OFF					

passing light

cable harness	ye	bu
cable switch	gn-bl	wh
P. HORN 	●	●
OFF		

light switch

cable harness	ye-br	wh	ye
cable switch	ye-wh	wh	re-ye
LIGHT OFF			
P. LIGHT 	●	●	
LIGHT 	●	●	

kill switch

cable harness	re	or
cable switch	or	bl-wh
RUN 	●	●
STOP		

start switch

cable harness	or	bl-or
cable switch	bl-bu	bl
START 	●	●
unpushed		

SCHALTPLAN » WIRING DIAGRAM

ENGLISH	DEUTSCH	ITALIANO
Additional instruments (roadbook;GPS;...)	Externe Instrumente	Strumenti supplementari
Battery	Batterie	Batteria
Clutch switch	Kupplungsschalter	Interruttore frizione
Cooling fan	Lüftermotor	Motorino ventola
Diode	Diode	Diodo
Electronic Power Control (EPS)	Electronic Power Control (EPS)	Electronic Power Control (EPS)
Flasher relay	Blinkerrelais	Relè indicatori
Flasher switch	Blinkerschalter	Deviatore indicatori di direzione
Front brake switch	vorderer Bremslichtschalter	Interruttore luce ant. di stop
Fuel level sensor	Benzinstandgeber	Sensore livello benzina
Fuse box	Sicherungskasten	Scatola fusibili
Gear sensor	Gangerkennung	Sensore marce
Generator	Generator	Generatore
Headlight	Scheinwerfer	Faro anteriore
High / low beam switch	Auf-Abblendschalter	Commutatore abbagliante/anabbagliante
Horn	Hupe	Avvisatore acustico
Horn switch	Hornschalter	Interruttore avvisatore acustico
Ignition coil	Zündspule	Bobina d'accensione
Ignition switch	Zündschloss	Interruttore d'accensione
Left front flasher	linker vorderer Blinker	Indicatore ant. sx
Left rear flasher	linker hinterer Blinker	Indicatore post. sx
Licence plate lamp	Kennzeichenbeleuchtung	Luce targa
Light switch	Lichtschalter	Deviatore luci
Multi-func.-digital-speedometer	Multifunktionsdigitaltacho	Tachimetro digitale multifunzione
Neutral switch	Leerlaufschalter	Interruttore folle
Octane selector	Oktanangepassung	Adattamento anticipo agli ottano
Pick up	Impulsgeber	Pick up
Rear brake switch	hinterer Bremslichtschalter	Interruttore luce post. di stop
Rear light / brakelight	hinteres Begrenzungslicht / Bremslicht	Luce post. di posizione/stop
Regulator-rectifier	Regelgleichrichter	Regolatore-raddrizzatore
Right front flasher	rechter vorderer Blinker	Indicatore ant. dx
Right rear flasher	Rechter hinterer Blinker	Indicatore post. dx
Sidestand switch	Seitenständerschalter	Interruttore cavalletto lat.
Speed sensor	Geschwindigkeitssensor	Sensore velocità
Start auxillary relay	Starterhilfsrelais	Relè ausiliario d'avviamento
Start relay	Startrelais	Relè d'avviamento
Start/stop switch	Start / stop schalter	Interruttore combinato d'avviamento e d'emergenza
Starter motor	Startermotor	Motorino d'avviamento
Tachometer	Drehzahlmesser	Contagiri
Temperature sensor	Temperatursensor	Sensore temperatura
Temperature switch	Temperaturschalter	Interruttore termico
Throttle position sensor (TPS)	Vergaserpotentiometer	Potenzometro carburatore (sensore TPS)

CABLE COLOURS	KABELFARBEN	CAVO COLORATO
bl: black	bl: schwarz	bl: nero
ye: yellow	ye: gelb	ye: giallo
bu: blue	bu: blau	bu: blu
gr: green	gr: grün	gr: verde
re: red	re: rot	re: rosso
wh: white	wh: weiß	wh: bianco
br: brown	br: braun	br: marrone
or: orange	or: orange	or: arancione
pi: pink	pi: rosa	pi: rosa
gr: grey	gr: grau	gr: grigio
pu: purple	pu: violett	pu: violetto

SCHALTPLAN » WIRING DIAGRAM

ENGLISH	FRANCAIS	ESPANOL
Additional instruments (roadbook; GPS;...)	Accessoires	Instrumentos externos
Battery	Batterie	Batería
Clutch switch	Contacteur d'embrayage	Interruptor de embrague
Cooling fan	Ventilateur	Motor del ventilador
Diode	Diode	Diodos
Electronic Power Control (EPS)	Electronic Power Control (EPS)	Electronic Power Control (EPS)
Flasher relay	Relais de clignotants	Relé de la luz intermitente
Flasher switch	Bouton de clignotants	Interruptor de la luz intermitente
Front brake switch	Contacteur de frein avant	Interruptor de luz del freno delantero
Fuel level sensor	Jauge à essence	Indicador del nivel de gasolina
Fuse box	Boîte à fusibles	Caja de fusibles
Gear sensor	Contacteur de rapport de boîte engagé	Reconocimiento de marchas
Generator	Alternateur	Generador
Headlight	Phare	Faro
High / low beam switch	Contacteur code/phare	Interruptor de encender/apagar la luz larga
Horn	Avertisseur sonore	Cláxon
Horn switch	Bouton d'avertisseur sonore	Interruptor del cláxon
Ignition coil	Bobine d'allumage	Bobina de encendido
Ignition switch	Contacteur d'allumage	Cerradura de encendido
Left front flasher	Clignotant avant gauche	Luz intermitente izquierda delantera
Left rear flasher	Clignotant arrière gauche	Luz intermitente izquierda trasera
Licence plate lamp	Eclairage de plaque	Luz de la matrícula
Light switch	Contacteur d'éclairage	Interruptor de luces
Multi-func.-digital-speedometer	Ordinateur de bord	Velocímetro digital multifuncional
Neutral switch	Contacteur de point mort	Interruptor de ralentí
Octane selector	Sélection pour l'indice d'octane	Ajuste de octano
Pick up	Capteur d'allumage	Generador de impulsos
Rear brake switch	Contacteur de frein arrière	Interruptor de luz del freno trasero
Rear light / brakelight	Feu rouge/stop	Luces de parqueo traseras /luces de freno
Regulator-rectifier	Régulateur/redresseur	Regulador rectificador
Right front flasher	Clignotant avant droit	Luz intermitente derecha delantera
Right rear flasher	Clignotant arrière droit	Luz intermitente derecha trasera
Sidestand switch	Contacteur de béquille latérale	Interruptor del caballete lateral
Speed sensor	Capteur de vitesse	Sensor de velocidad
Start auxillary relay	Relais secondaire de démarreur	Relé auxiliar del arranque
Start relay	Relais de démarreur	Relé del arranque
Start/stop switch	Contacteur start/stop	Interruptor arranque / parada
Starter motor	Démarreur	Motor de arranque eléctrico
Tachometer	Compte-tours	Cuenta revoluciones
Temperature sensor	Sonde de température	Sensor de temperatura
Temperature switch	Contacteur de température	Interruptor de temperatura
Throttle position sensor (TPS)	Capteur d'ouverture de carburateur	Potenciómetro del carburador

CABLE COLOURS	COULEUR DE CABLE	COLOR DE CABLE
bl: black	bl: noir	bl: negro
ye: yellow	ye: jaune	ye: amarillo
bu: blue	bu: bleu	bu: azul
gr: green	gr: vert	gr: verde
re: red	re: rouge	re: rojo
wh: white	wh: blanc	wh: blanco
br: brown	br: brun	br: marron
or: orange	or: orange	or: naranja
pi: pink	pi: rose	pi: rosado
gr: grey	gr: gris	gr: gris
pu: purple	pu: violet	pu: violeta