

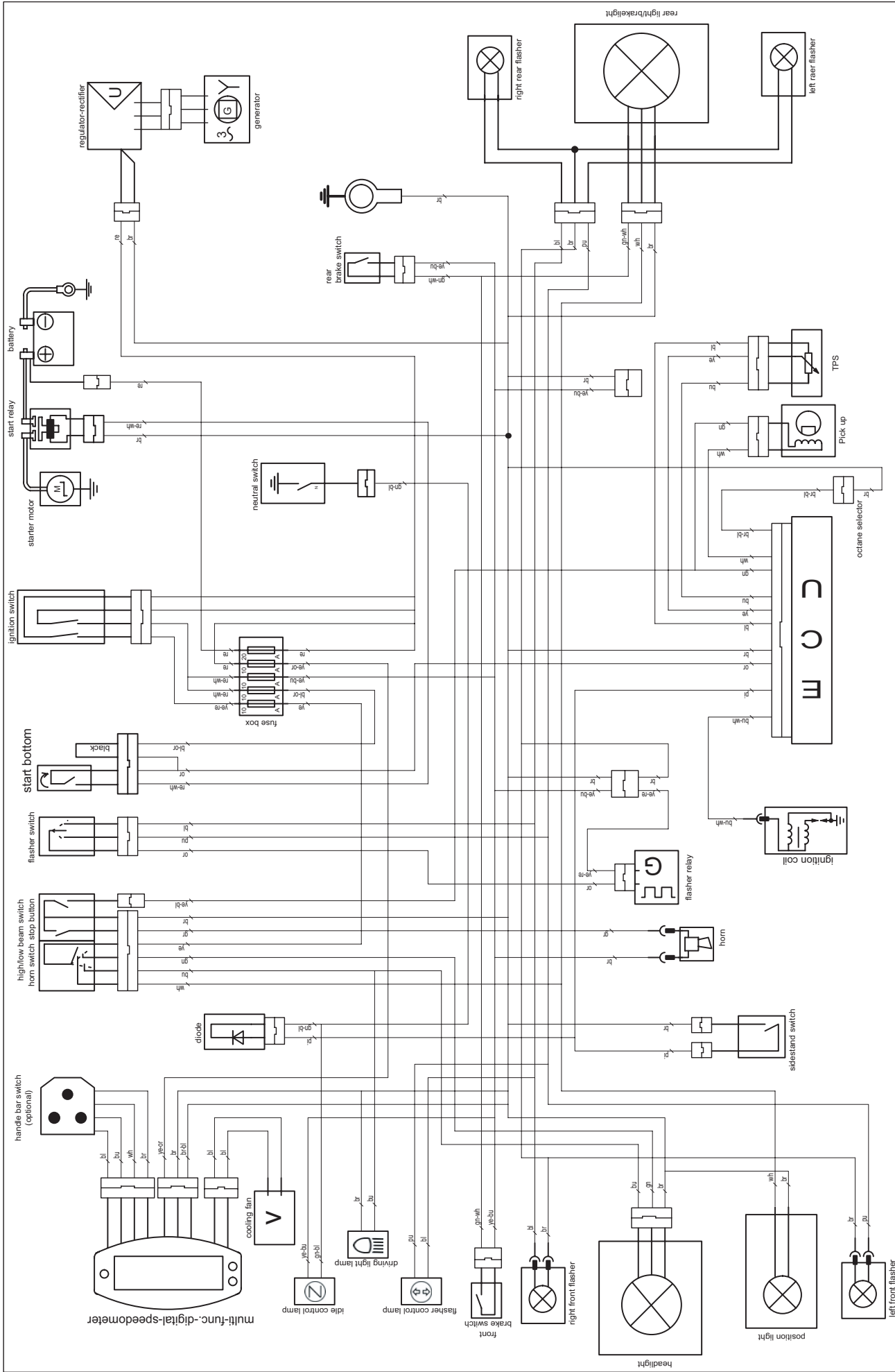



SCHALTPLAN » WIRING DIAGRAM











	<p>625 SXC 2005-07</p>	<p>wiring diagram</p>	<p>main harness - 583.11.375.750</p>	<p>20.07.2006</p>
---	------------------------	-----------------------	--------------------------------------	-------------------



ignition switch

cable switch	gn	or	bu	re- wh
cable harness	re	ye- re	re	re- wh
ON 				
light				
OFF				



light switch
high/low beam switch

cable color	bu	ye	gn	wh
LIGHT OFF				
P.LIGHT 				
LO 				
HI 				
P.LIGHT 				

start switch

cable harness	or	bl- or
cable switch		bl- bl
START 		
unpushed		





horn switch

cable color	re	br
HORN 		
OFF		

kill switch

cable color	ye- bl	br
pushed		
unpushed		

flasher switch

cable harness	or	pu	bl
TURN L 			
TURN R 			
OFF			

brake switch

cable harness	gn- wh	ye- bu
cable switch	bl	bl
pushed		
unpushed		

sidestand switch

cable harness	br	pi
cable switch	bl	bl
folded up		
folded down		

SCHALTPLAN » WIRING DIAGRAMM

ENGLISH	DEUTSCH	ITALIANO
headlight	Scheinwerfer	faro
parking light	Standlicht	luce di posizione
turn indic left fr	Blinker li vo	lampegg ant sn
turn indic left fr	Blinker re vo	lampegg ant dx
ignition controll ON	Zündungskontrolle ON	spiedicontrollo ON
high beam indicator	Fernlichtkontrolle	spia abbagliante
turn indicator	Blinkerkontrolle	spia lampeggiatori
multip cont plug (2)	2-Pol Stecker	connettore a 2 poli
multip cont plug (3)	3-Pol Stecker	connettore a 3 poli
multip cont plug (4)	4-Pol Stecker	connettore a 4 poli
stoplight switch f	Bremslichtsch vo	int luce arresto ant
stoplight switch r	Bremslichtsch vo	int luce arresto post
horn	Horn	clacson
turn indicator	Blinkgeber	trasmitt di lampeg
CDI	CDI	CDI
spark plug	Zündkerze	candela
ignition coil	Zündspule	bobina d'accens
generator	Genrator	dinamo
pulser coil	Impulsgeber	trasmettitore d imp
regulator-rectifier	Regelgleichrichter	regol di tens
TPS	TPS	TPS
blink switch	Blinkerschalter	int lampeggiatori
combinat switch	Kombischalter	multicomando
blinker left rear	Blinker li hi	lampegg post sn
blinker right rear	blinker re hi	lampegg post dx
rear-stoplight	Brems-Schlusslicht	fanal post di freno
fan connection	Lüfteranschluss	connet ventilatore
licence pl lightning	Kennzeichenbel.	iluminat de targa
fusebox	Sicherungskasten	scatola fusibili
capacitor	Kondensator	condensatore
ground connection	Masseanschluss	collegam di masse
multip cont plug (6)	6-pol stecker	connettore a 6 poli
sensorcable	Sensorkabel	cavo sensor
battery 12V	Batterie 12V	batteria 12V
ignition switch	Zündschloss	interruttore accesion
starter relay	Startrelaise	rele d avviamento
starter engine	Startermotor	mot d avviamento ele
run-off/start switch	Start-Not-Aus	disinsertor/partire
<hr/>		
CABLE COLOURS	KABELFARBEN	CAVO COLORATO
bl: black	bl: schwarz	bl: nero
ye: yellow	ye: gelb	ye: giallo
bu: blue	bu: blau	bu: blu
gn: green	gn: grün	gn: verde
re: red	re: rot	re: rosso
wh: white	wh: weiß	wh: bianco
br: brown	br: braun	br: marrone
or: orange	or: orange	or: arancione
pi: pink	pi: rosa	pi: rosa
gr: grey	gr: grau	gr: grigio
pu: purple	pu: violett	pu: violetto

ENGLISH

headlight
 parking light
 turn indic left fr
 turn indic left fr
 ignition controll ON
 high beam indicator
 turn indicator
 multip cont plug (2)
 multip cont plug (3)
 multip cont plug (4)
 stoplight switch f
 stoplight switch r
 horn
 turn indicator
 CDI
 spark plug
 ignition coil
 generator
 pulser coil
 regulator-rectifier
 TPS
 blink switch
 combinat switch
 blinker left rear
 blinker right rear
 rear-stoplight
 fan connection
 licence pl lightning
 fusebox
 capacitor
 ground connection
 multip cont plug (6)
 sensor cable
 battery 12V
 ignition switch
 starter relay
 starter engine
 run-off/start switch

FRANCAIS

phare
 feu de position
 clignoteur av gauche
 clignoteur av droit
 temion ON
 temoin feu route
 temoin de clignoteur
 connect multiple (2)
 connect multiple (3)
 connect multiple (4)
 contact de stop av
 contact Harr de stop
 klaxon
 centrale clignot
 CDI
 bougie
 bobine d'allumage
 gnerateur
 capteur
 regulat redresseur
 TPS
 contact d clignoteur
 commodo
 clign arr gauche
 clign arr droite
 feu arr et de stop
 connect ventilateur
 ecl plaque d immat
 boite a fusibles
 condensateur
 masse
 connect multiple (6)
 capteur cable
 batterie 12V
 contact d allum
 relaise de demarreur
 demarreur electrique
 bout de demar/arr d urg

ESPANIOL

faro
 luz de posicion
 interm izquierdo delantero
 intermitene derecho delantero
 luces de aviso ON
 lampara aviso luces largas
 lampara aviso intermitentes
 conector multiple 2
 conector multiple 3
 conector multiple 4
 interr luz de freno del
 interr luz de fren tras
 claxon
 conjunto del intermintente
 CDI
 bujia
 bobina de encendido
 generador
 generado de impusos
 regulador de tension
 TPS
 interruptor clingoteur
 interruptor combinado
 intermitente izquierdo trasero
 intermitente derecho trasero
 luz de freno trasero
 conector ventilador
 luz lpaca de matricula
 caja de fusibles
 condensador
 conector de massa
 conecotr multiple (6)
 sensor cable
 batteria 12V
 llave de contata
 rele de arranque
 motor de arranque
 boton de arranque per de urg

CABLE COLOURS

bl: black
 ye: yellow
 bu: blue
 gn : green
 re: red
 wh: white
 br: brown
 or: orange
 pi: pink
 gr: grey
 pu: purple

COULEUR DE CABLE

bl: noir
 ye: jaune
 bu: bleu
 gn: vert
 re: rouge
 wh: blanc
 br: brun
 or: orange
 pi: rose
 gr: gris
 pu: violet

COLOR DE CABLE

bl: negro
 ye: amarillo
 bu: azul
 gn: verde
 re: rojo
 wh: blanco
 br: marron
 or: naranja
 pi: rosado
 gr: gris
 pu: violeta