

# 690 LC4 DUKE 2010



**SPARE PARTS MANUAL: ENGINE**



**ART.NO.: 3CM088515JEN**

**ENGLISH**

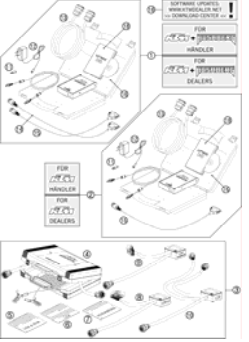
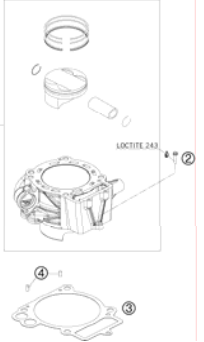
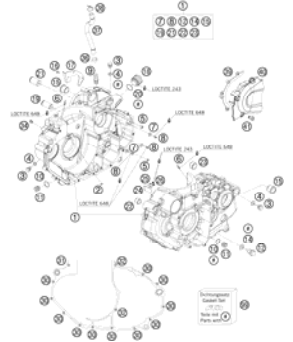
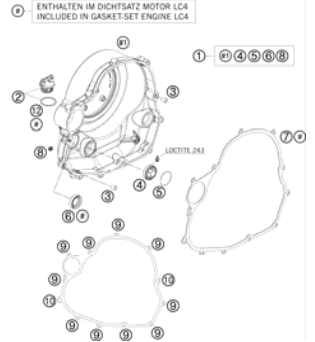
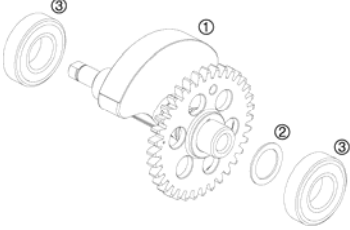
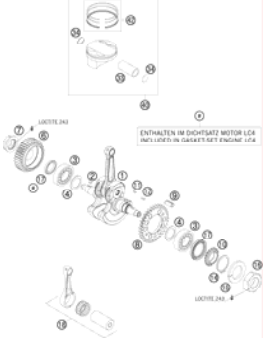
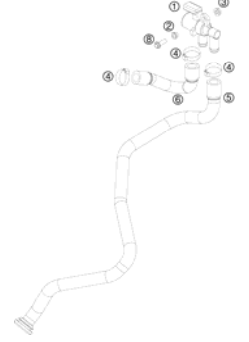
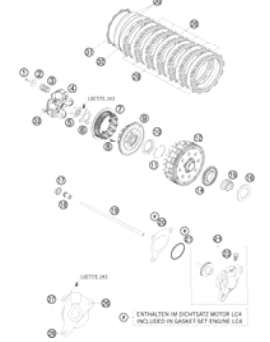
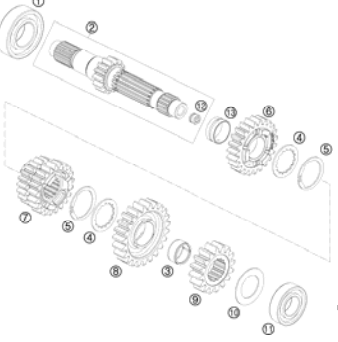

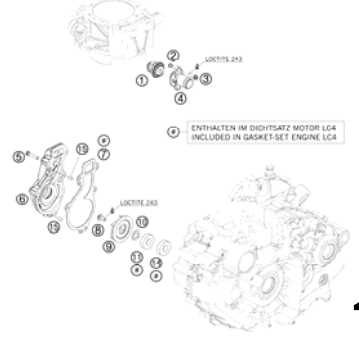

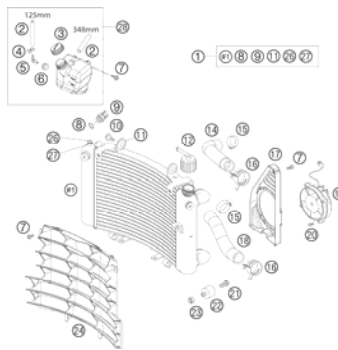
<p><b>DIAGNOSTIC TOOL</b></p>  <p><b>3</b></p>	<p><b>CYLINDER</b></p>  <p><b>4</b></p>	<p><b>ENGINE CASE</b></p>  <p><b>5</b></p>	<p><b>CLUTCH COVER</b></p>  <p><b>6</b></p>
<p><b>BALANCER SHAFT</b></p>  <p><b>7</b></p>	<p><b>CRANKSHAFT, PISTON</b></p>  <p><b>8</b></p>	<p><b>SECONDARY AIR SYSTEM SAS</b></p>  <p><b>9</b></p>	<p><b>CLUTCH</b></p>  <p><b>10</b></p>
<p><b>TRANSMISSION I - MAIN SHAFT</b></p>  <p><b>11</b></p>	<p><b>TRANSMISSION II - COUNTERSHAFT</b></p>  <p><b>12</b></p>	<p><b>SHIFTING MECHANISM</b></p>  <p><b>13</b></p>	<p><b>WATER PUMP</b></p>  <p><b>14</b></p>

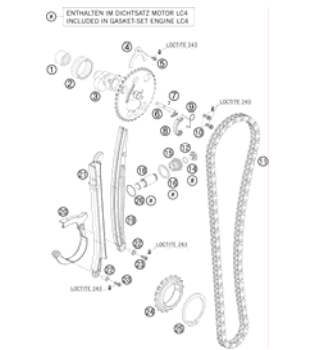
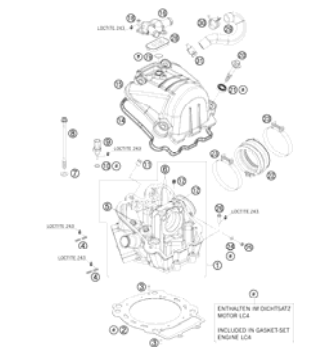
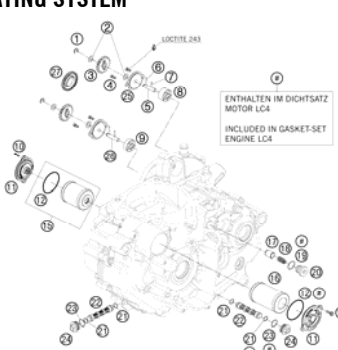
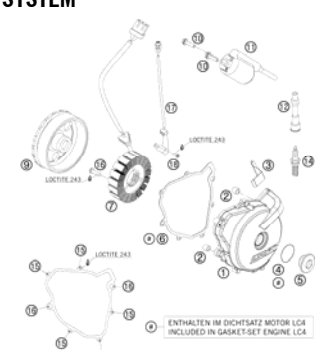
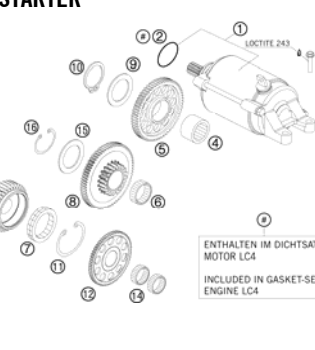
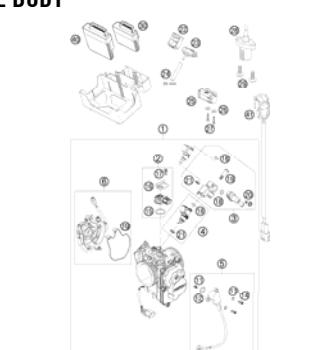
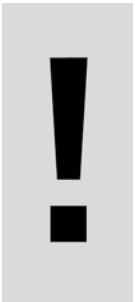
<p><b>COOLING SYSTEM</b></p>  <p style="text-align: right;"><b>15</b></p>	<p><b>VALVE DRIVE</b></p>  <p style="text-align: right;"><b>16</b></p>	<p><b>TIMING DRIVE</b></p>  <p style="text-align: right;"><b>18</b></p>	<p><b>CYLINDER HEAD</b></p>  <p style="text-align: right;"><b>19</b></p>
<p><b>LUBRICATING SYSTEM</b></p>  <p style="text-align: right;"><b>20</b></p>	<p><b>IGNITION SYSTEM</b></p>  <p style="text-align: right;"><b>21</b></p>	<p><b>ELECTRIC STARTER</b></p>  <p style="text-align: right;"><b>22</b></p>	<p><b>THROTTLE BODY</b></p>  <p style="text-align: right;"><b>23</b></p>
<div style="display: flex; align-items: center;"> <div style="flex: 1; text-align: center;">  </div> <div style="flex: 3;"> <p>All information contained is without obligation. KTM-Sportmotorcycle AG particularly reserves the right to modify any equipment, technical specifications, prices, colors, shapes, materials, services, service work, constructions, equipment and the like so as to adapt them to local conditions or to cancel any of the above items, all without previous announcement and without giving reasons. KTM may stop manufacturing certain models without previous notice. KTM shall not be held liable for any deviations of availability and/or ability to deliver, illustrations, descriptions, printing and/or other errors. The illustrated models partly contain extra equipment, which is not applied to standard models. © by KTM-SPORTMOTORCYCLE AG, Mattighofen AUSTRIA; All rights reserved; Reprint, also in extracts, with written allowance of KTM-SPORTMOTORCYCLE AG, Mattighofen only.</p> </div> </div>			

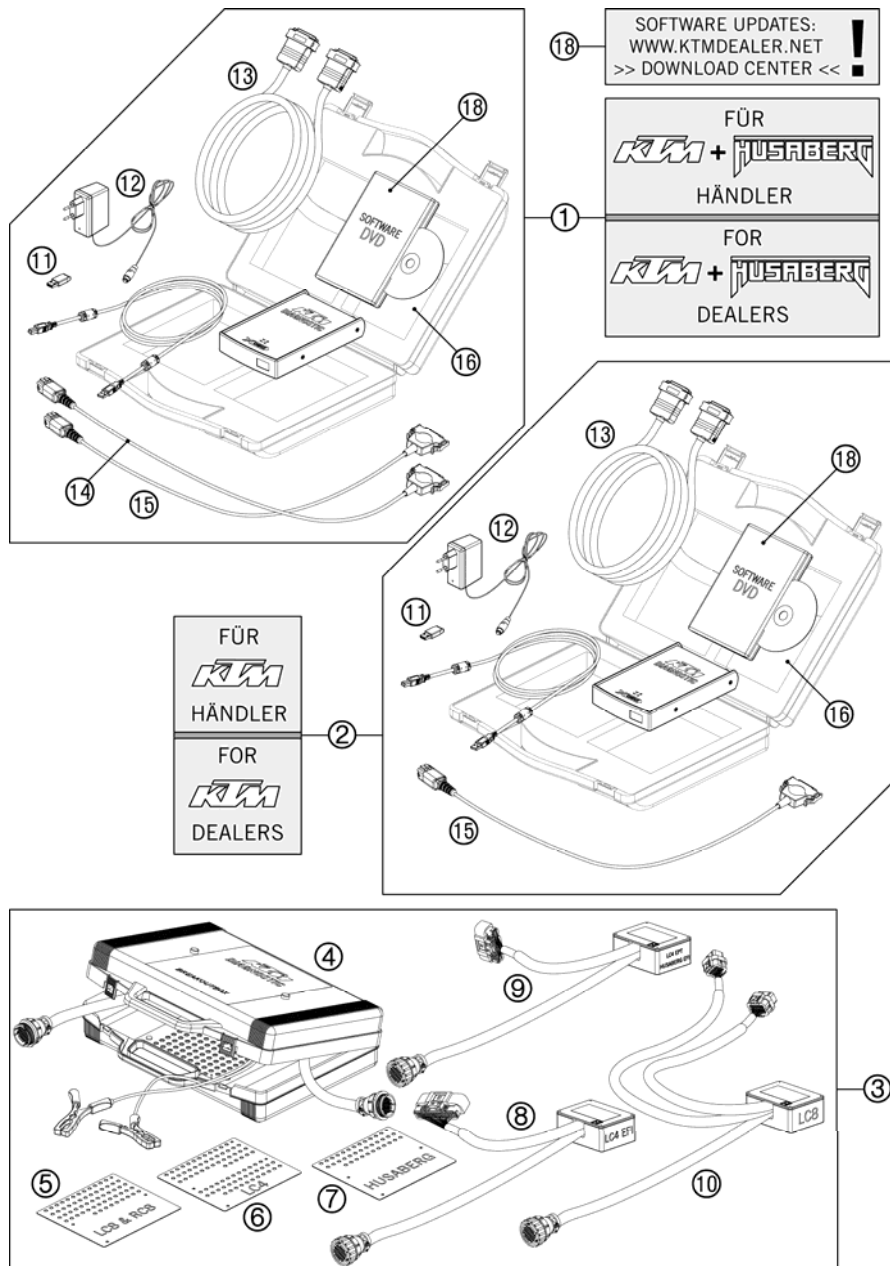

FIG	PART NUMBER	DESCRIPTION	QTY
1	00029096200	DIAGNOSTIC TOOL HUSABERG/KTM	1
2	00029096100	DIAGNOSTIC TOOL KTM	1
3	00029095000	BREAKOUT-BOX KPL.	1
4	00029095001	BREAKOUT-BOX	1
5	00029095005	TEMPLATE LC8 / RC8	1
6	00029095006	TEMPLATE LC4	1
7	00029095007	TEMPLATE HUSABERG	1
8	00029095003	ADAPTER LC4 EFI	1
9	00029095004	ADAPTER LC4 EPT/HUSABERG EFI	1
10	00029095002	ADAPTER LC8	1
11	00029096006	DIAGNOSTIC HASP DONGLE XC1	2
12	00029096003	POWERSUPPLY 220V/12V FOR AVL	2
13	00029096002	EXTENSION CABLE	2
14	00029096001	DIAGNOSTIC CABLE HUSABERG	1
15	00029096009	DIAGNOSTIC CABLE KTM	2
16	00029096004	CASE FOR DIAGNOSTIC-TOOL	1
18	00029096007	BASIC SOFTWARE DVD KTM	2

100002921 / C100002921

\* NEW PART

X AS REQUIRED

# CYLINDER

690 LC4 DUKE 2010

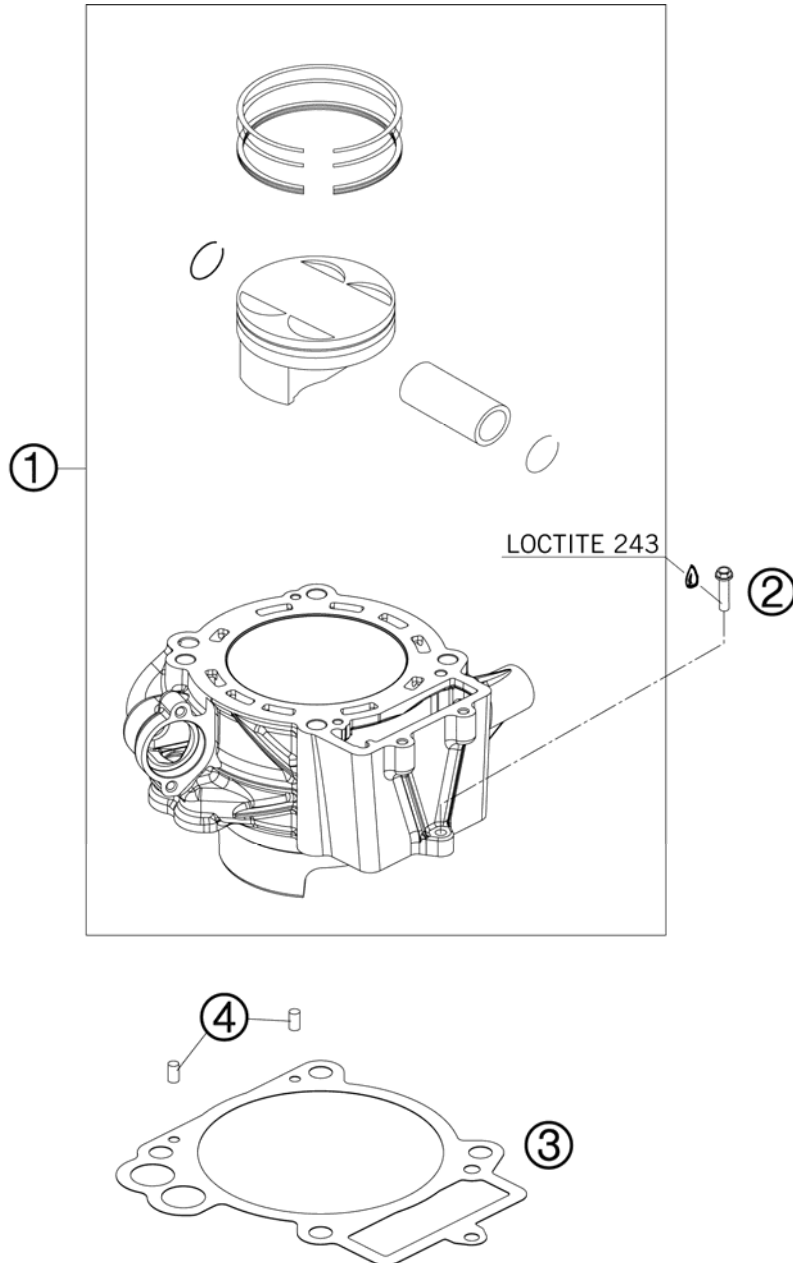

FIG	PART NUMBER	DESCRIPTION	QTY
1	75030038200	CYLINDER AND PISTON	1
2	0025060256	HH COLLAR SCREW M6X25 TX30	1
3	75030035000	CYLINDER BASE GASKET 07	1
4	0474050100	GROOVED PIN DIN1474 5X10	2

097503041 / C097503041

\* NEW PART

X AS REQUIRED

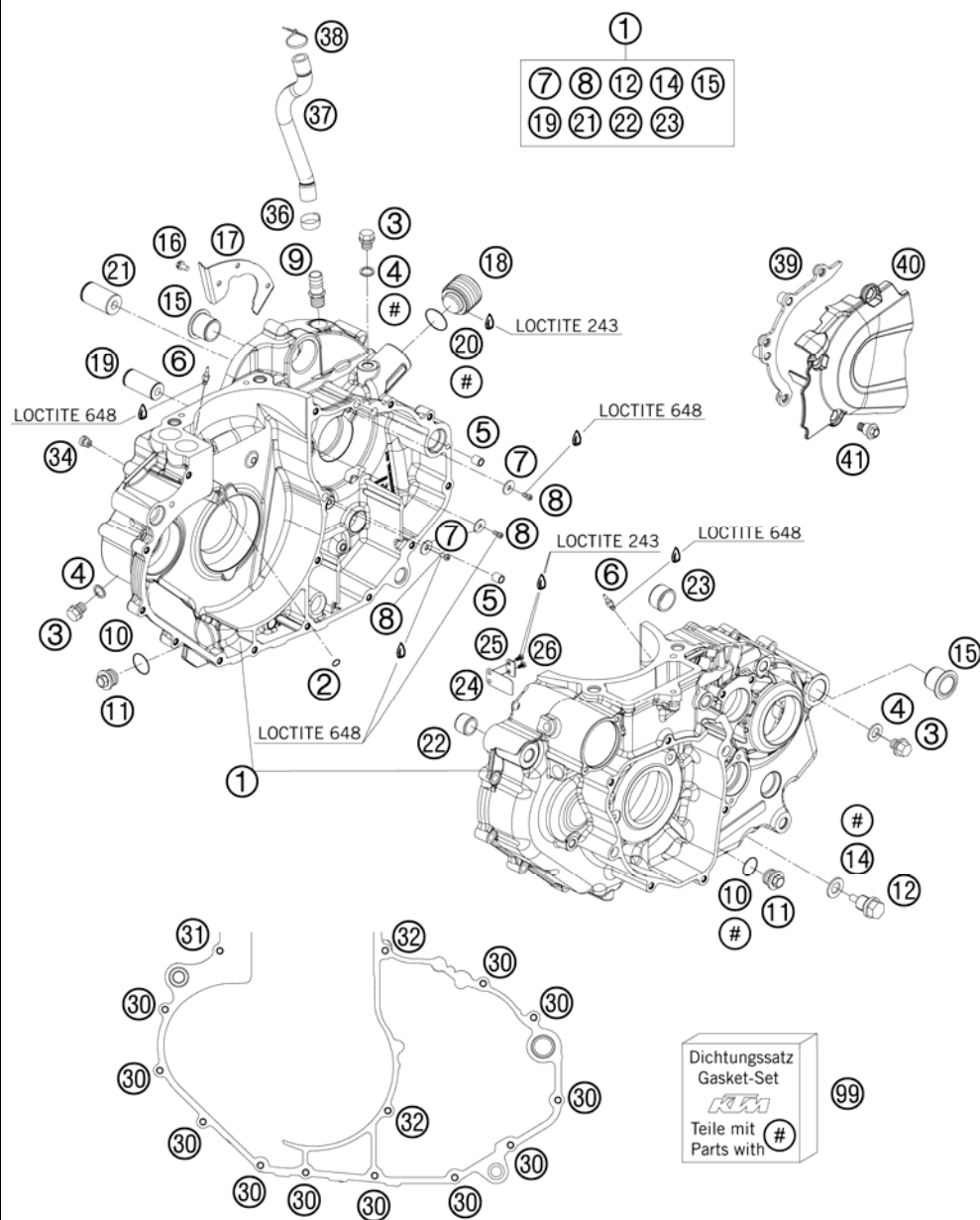

FIG	PART NUMBER	DESCRIPTION	QTY
1	75030000133	ENGINE CASE CPL.W.BEAR. LC4 07	1
2	0770060018	O-RING 6,00X1,78	1
3	0910100003	PLUG DIN0910-M 10X1	3
4	0603100141	COPPER GASKET DIN7603-10X14X1	3
5	59030023000	DOWEL 6X8X11,5	3
6	60030064050	OIL JET 50 M6X0,75 WS8 05	2
7	0021050003	WASHER DIN9021-A 5,3	3
8	073800501001	FLAT HEAD SCREW ISO 7380 M5X10	3
9	60030022000	VENTILATION CONNECTOR M16X1,5	1
10	0770020170	O-RING 17,17X1,78 GLO	2
11	59038017000	PLUG M20X1,5 WS=13	2
12	58030021000	OILDRAIN PLUG W.MAG. M 12X1,5	1
14	58038022000	CU-SEAL RING DIN7603-12X18X1,5	1
15	75030010000	CASE BUSH	2
16	07984050100	AH SCREW DIN7984 M5X10 A2	3
17	75030042000	COVER	1
18	75038048100	LOCK PIECE	1
19	54633018400	BUSHING PIN	1
20	0770180020	O-RING 18,00X2,00 NBR 70	1
21	59040028000	BUSHING PIN	1
22	51030026100	DOWEL 17 X 13 X 12	1
23	54830027000	DOWEL 21X12 03	1
24	75030003051	MEMBRANE 07	1
25	75030003050	STOP SHEET MEMBRANE 07	1
26	0458030080	CYLIND.SCREW M3X8 ISO 14580 SS	2
30	0025060306	HH COLLAR SCREW M6X30 TX30	11
31	0025060256	HH COLLAR SCREW M6X25 TX30	1
32	0025060706	HH COLLAR SCREW M6X70 TX30	2
34	75030058000	JET 125	1
36	00049220121	CLAMP STD DN22	1
37	75030086000	HOSE BREATHER SYSTEM 07	1
38	44011076200	CABLE TIE 200/3,6MM BLACK	1
39	75030047000	SECURING GUIDE 07	1
40	75030060000	CHAIN GUARD 07	1
41	59001092050	SPECIAL SCREW M6X12,5 WS=8	3
99	75030099000	GASKET SET LC4 2007	1

097563010 / C097563010

\* NEW PART

X AS REQUIRED

# CLUTCH COVER

690 LC4 DUKE 2010

# ENTHALTEN IM DICHTSATZ MOTOR LC4  
INCLUDED IN GASKET-SET ENGINE LC4

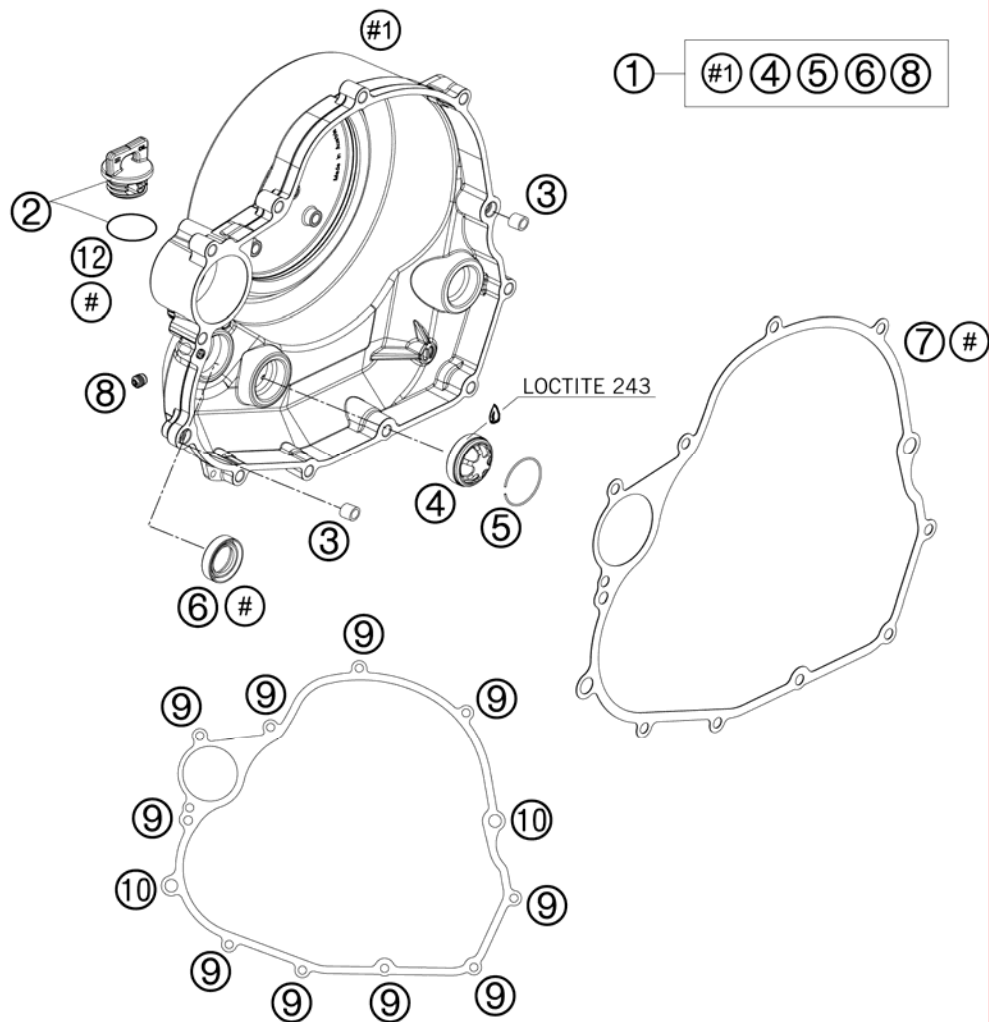

FIG	PART NUMBER	DESCRIPTION	QTY
1	75030001044	CLUTCH COVER CPL. 07	1
2	58030020100	PLUG CPL. M24X3	1
3	49030090000	DOWEL 9,8 X 7 X 10	2
4	59030019000	OIL LEVEL GLASS G 1777 Y	1
5	61030019050	CIRCLIP OIL LEVEL GLASS 03	1
6	0760172871	SHAFT SEAL RING 17X28X7B VITON	1
7	75030025000	CLUTCH CASE GASKET 07	1
8	59030296000	SCREW PLUG	1
9	0025060256	HH COLLAR SCREW M6X25 TX30	9
10	0025060306	HH COLLAR SCREW M6X30 TX30	2
12	0770191015	O-RING 19,00X3,00 NBR	1

097563020 / C097563020

\* NEW PART

X AS REQUIRED



# BALANCER SHAFT

690 LC4 DUKE 2010

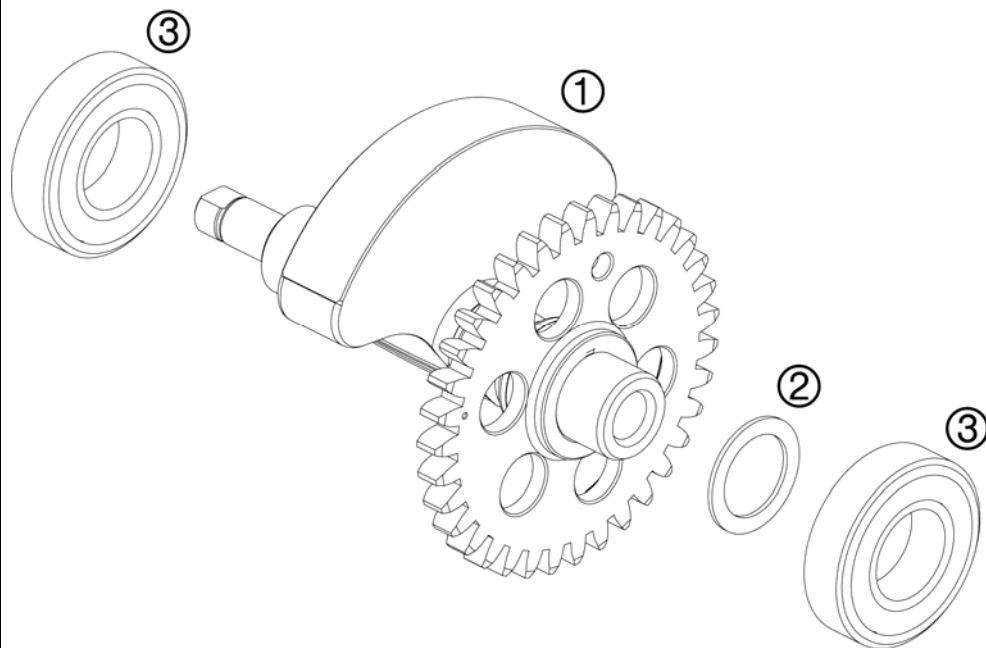

FIG	PART NUMBER	DESCRIPTION	QTY
1	75030057144	BALANCER SHAFT CPL	1
2	0988223201	THRUST WASHER DIN0988-22X32X,1	x
2	09882232015	THRUST WASHERDIN0988-22X32X,15	x
2	0988223202	THRUST WASHER DIN0988-22X32X,2	x
2	0988223203	THRUST WASHER DIN0988-22X32X,3	x
3	0625062221	BALL BEARING 62/22 C4	2

087503030 / C107503030

\* NEW PART

X AS REQUIRED

# CRANKSHAFT, PISTON

690 LC4 DUKE 2010

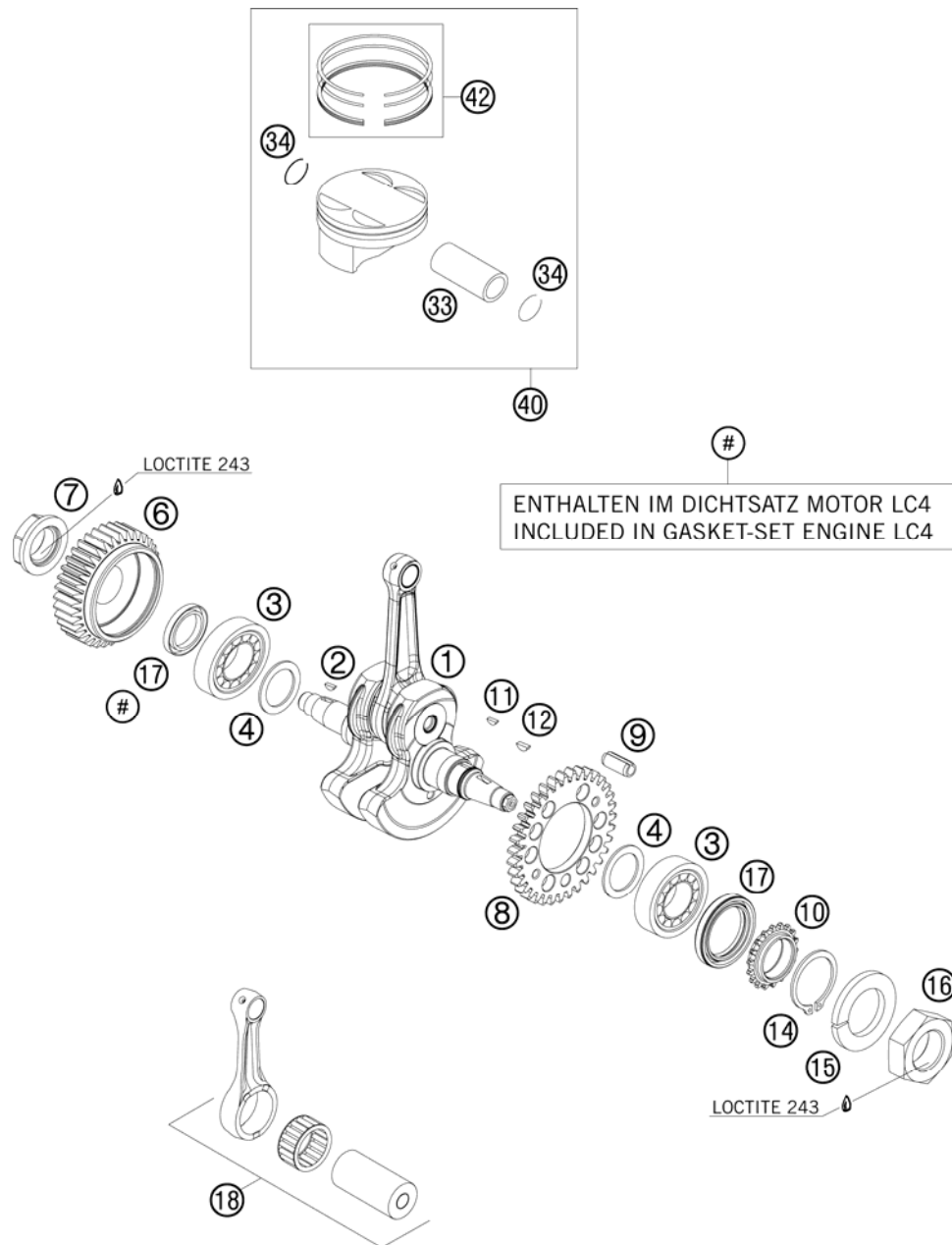

FIG	PART NUMBER	DESCRIPTION	QTY
1	75030018100	CRANKSHAFT CPL	1
2	0888040050	WOODRUFF KEY DIN6888 4X5X13	1
3	75030018150	CYL.ROLLER BEARING NJ207 ECPC4	2
4	56530081000	SHIM WASHER 36X48X0,10	x
4	56530081100	SHIM WASHER 36X48X0,15	x
4	56530081200	SHIM WASHER 36X48X0,20 STEEL	x
4	56530081300	SHIM WASHER 36X48X0,30	x
6	75032000002	PRIMARY GEAR 36 T 07	1
7	75030029100	NUT FOR PRIMARY GEAR	1
8	75030055000	DRIVE WHEEL BALANCER SHAFT 07	1
9	0749080300	TENSION PIN ISO13337 8X30	1
10	75036014000	TIMING PULLEY 07	1
11	0888030050	WOODRUFF KEY DIN6888-3X5X13	1
12	6946005	WOODRUFF KEY 5X6,5 HARDED	1
14	0471300151	CIRCLIP DIN0471-30X1,5 NIRO	1
15	58132072000	LOCK WASHER VSK 18	1
16	0936181505	HEXAGON NUT DIN0936-M18X1,5 R.	1
17	0760355070	SHAFT SEAL R.35X50X7B VITON	2
18	75030015144	CONNECT. ROD REPAIR SET LC4 08	1
33	75030033000	PISTON PIN EB 22/72 d22x56	1
34	77630074000	CIRCLIP	2
40	75030007300 I	PISTON CPL. I	x
40	75030007300 II	PISTON CPL. II	x
42	75030031044	PISTONRING SET LC4 07	1

097503060 / C107563060

\* NEW PART

X AS REQUIRED

# SECONDARY AIR SYSTEM SAS

690 LC4 DUKE 2010

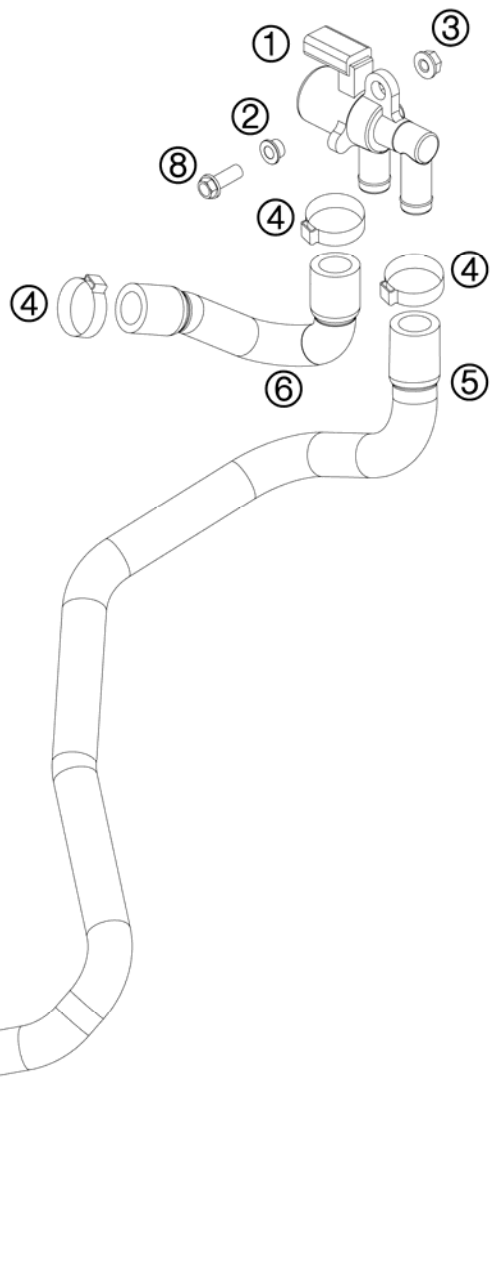

FIG	PART NUMBER	DESCRIPTION	QTY
1	75005026000	SLS-VALVE 07	1
2	75005033000	COLLAR BUSH SAS-VALVE	1
3	56509064100	SELF LOCKING NUT M6 10.9	1
4	00049200121	CLAMP STD DN20	3
5	75005032000	HOSE SLS AIRFILTERBOX 07	1
6	75005031000	HOSE SLS CYLINDER 07	1
8	0025060166	HH COLLAR SCREW M6X16 TX30	1

097563130 / C107563130

\* NEW PART

X AS REQUIRED

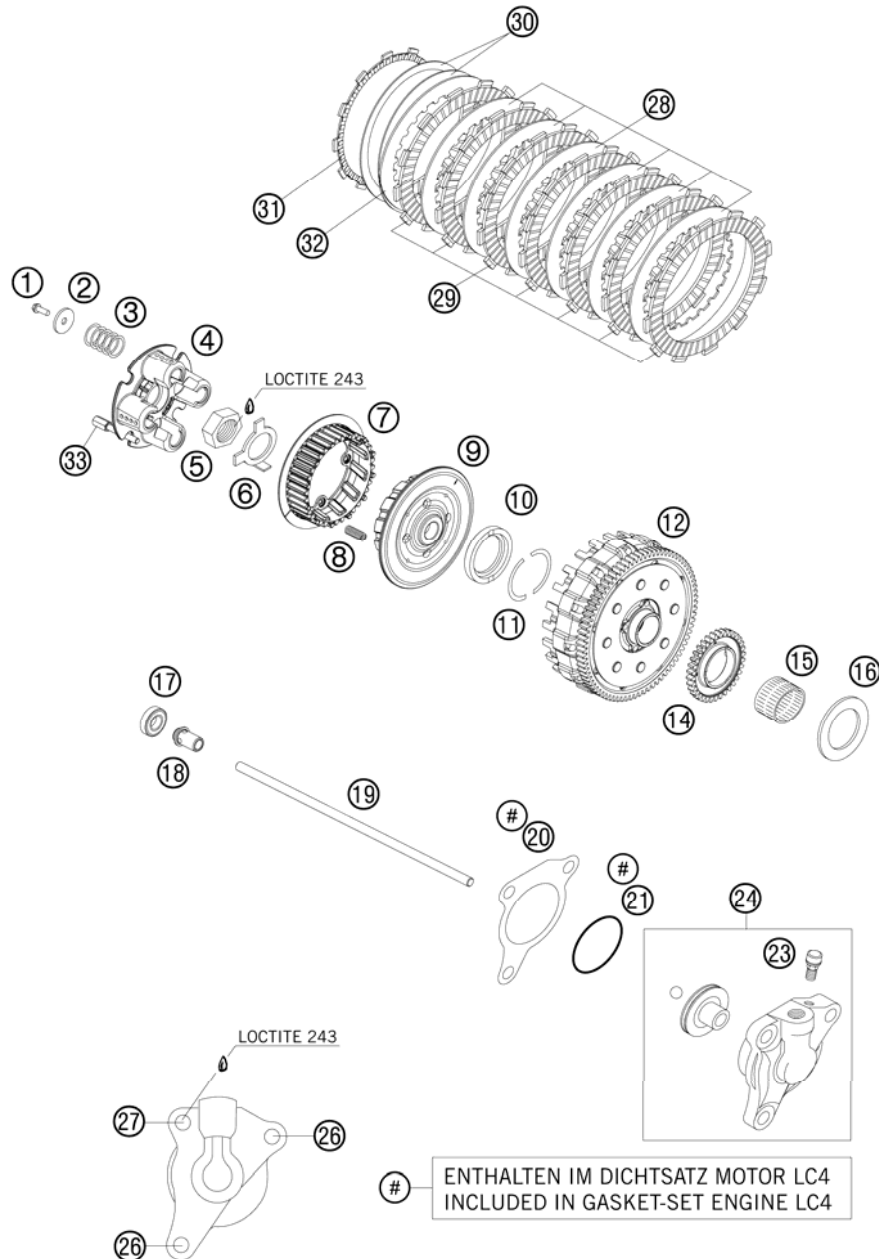

FIG	PART NUMBER	DESCRIPTION	QTY
1	0025050256	HH COLLAR SCREW M5X25 ISA30	4
2	75032006000	SPRING RING 07	4
3	58532080000	CLUTCHSPRING 3,0X33,5	4
4	75032003000	PRESSURE CAP	1
5	60036073050	HEXAGON NUT M20X1,5 7MM	1
6	75032018000	LOCK WASHER 07	1
7	75032002002	INNER CLUTCH HUB MOVABLE	1
8	75032033000	CLUTCH RELEASE SPRING	4
9	75032002001	INNER CLUTCH HUB FIXED	1
10	75032009000	STEPPED WASHER 07	1
11	75032007000	HALF-WASHER 07	2
12	75032001044	OUTER CLUTCH HUB CPL.	1
14	75032050001	OIL PUMP DRIVE WHEEL 07	1
15	56532095000	NEEDLE BEARING K26X30X22ZW.KSE	1
16	75032017000	WASHER 26X40X2 07	1
17	0625060016	GROOV.BALL BEAR. 6001.2RSR C3	1
18	75032055100	PRESSURE BOLT 08	1
19	75032054200	PUSH ROD 08	1
20	59032065000	GASKET FOR SLAVE CYLINDER	1
21	0770300015	O-RING 30,00X1,50 NBR 70	1
23	54732064000	BLEEDER SCREW WITH CAP	1
24	75032061044	OUTPUT CYL. WITH BLEEDER SCREW	1
26	0025060356	HH COLLAR SCREW M6X35 TX30	2
27	0025060206	HH COLLAR SCREW M6X20 TX30	1
28	75032112000	STEEL DISK 1,5 MM LC4 07	6
29	58332011300	LINING DISK 2,7MM FCC 02	7
30	58632016000	RONDELLA ANTIVIBRAZIONE SET	1
31	75032111100	LINING DISC CUT OUT	1
32	75032112100	STEEL DISK 1,5MM NITRIDED	1
33	75032032000	HOLDING SCREW GMB-M5X35	2

097503210 / C107503210

\* NEW PART

X AS REQUIRED

# TRANSMISSION I - MAIN SHAFT

690 LC4 DUKE 2010

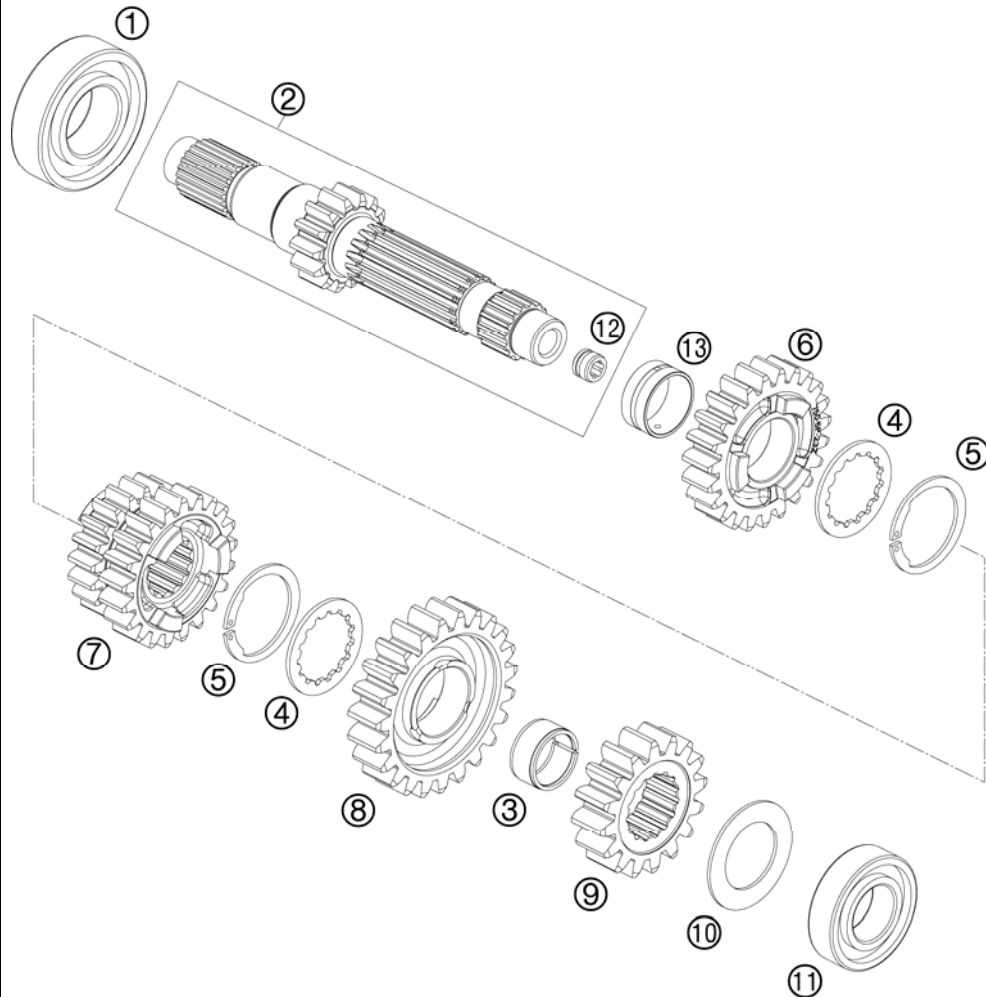

FIG	PART NUMBER	DESCRIPTION	QTY
1	06252858161	BALL BEARING 58/28 C4 N	1
2	76233001000	MAIN SHAFT	1
3	0405222613	NEEDLE BEAR. K 22X26X13 TN	1
4	56533016300	STOP DISK 22,7 X 32 X 1,5	2
5	75033041000	STOP-V-RING AV25	2
6	75033105000	IDLER GEAR 5.G.	1
7	75033003000	3/4TH GEAR MAINSHAFT 07	1
8	75033006000	IDLER 6. GEAR 07	1
9	75033002000	SOLID GEAR 2.G. 07	1
10	59033080000	SHIM 20X32X1	1
11	0625060041	BALL BEARING 6004 TNH C3	1
12	77333001160	GUIDE BUSHING	1
13	76233022100	BEARING BUSH	1

097503330 / C107503330

\* NEW PART

X AS REQUIRED

# TRANSMISSION II - COUNTERSHAFT

690 LC4 DUKE 2010

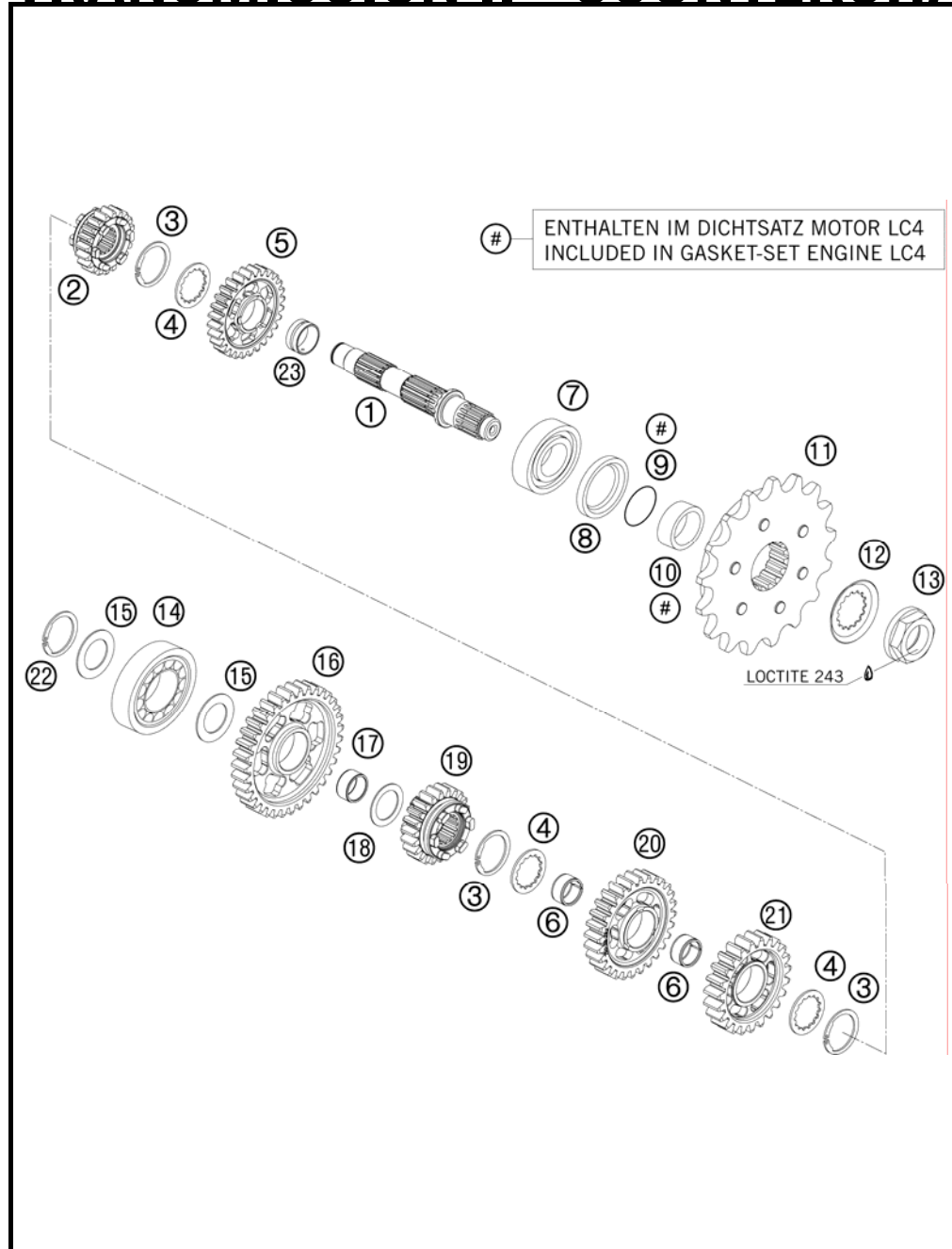

FIG	PART NUMBER	DESCRIPTION	QTY
1	76233010000	COUNTER SHAFT	07
2	75033016000	SLIDING GEAR 6TH G.	07
3	0417025000	CIRCLIP SW25	3
4	56533016300	STOP DISK 22,7 X 32 X 1,5	3
5	76233012100	IDLER 2. GEAR	1
6	0405222613	NEEDLE BEAR. K 22X26X13 TN	2
7	49030023100	CYL.ROLLER BEARING NJ205 C4	1
8	0760324773	SHAFT SEAL R. 32X47X7BSL VITON	1
9	0770020220	O-RING 25,12X1,78 NBR70	1
10	54633014100	SPACER BUSHING 12MM	1
11	58033029115	ENGINE SPROCKET 15 T DAMPED	x
11	58033029116	ENGINE SPROCKET 16 T DAMPED	x
11	58033029117	ENGINE SPROCKET 17 T DAMPED	x
12	51033031000	LOCK WASHER	1
13	58033032200	SPROCKET NUT LC4	03
14	0625204213	BALL BEARING 6004 C4 N	1
15	59033080000	SHIM 20X32X1	2
16	75033011000	IDLER GEAR 1ST GEAR	07
17	56533098000	NEEDLE BEARING K22X26X13H	1
18	54603036000	STOP DISK 22,2X31,7X1	1
19	75033015000	5TH GEAR COUNTERSHAFT	07
20	75033013000	IDLER GEAR 3.G	07
21	75033014000	IDLER GEAR 4.G	07
22	0471200120	CIRCLIP DIN471 20X1,2	1
23	76233022100	BEARING BUSH	1

097503360 / C107503360

\* NEW PART

X AS REQUIRED



# SHIFTING MECHANISM

690 LC4 DUKE 2010

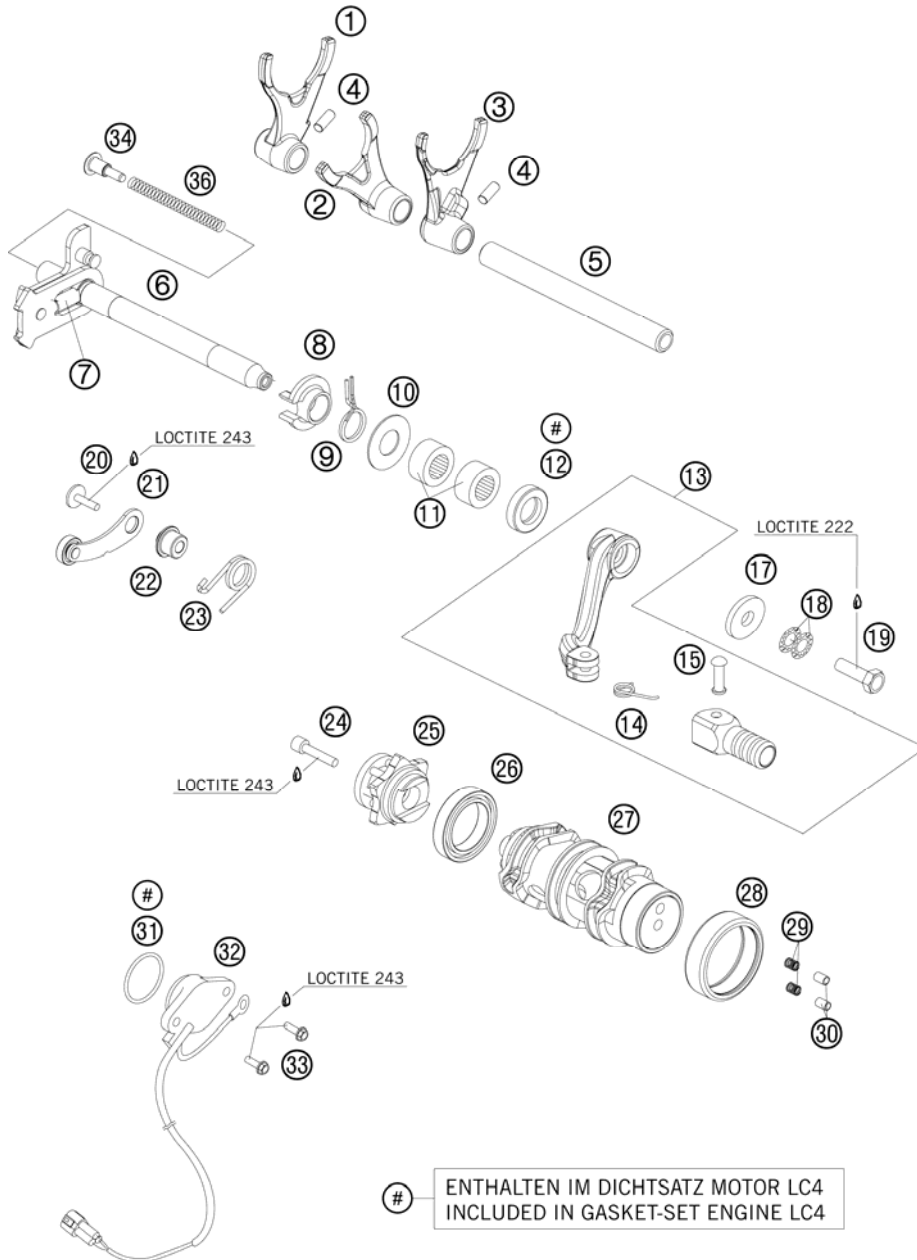

FIG	PART NUMBER	DESCRIPTION	QTY
1	75034002000	SHIFT FORK F. SLIDINGGEAR 5 07	1
2	75034001000	SHIFT FORK F. SLIDINGG. 3/4 07	1
3	75034003000	SHIFT FORK F. SLIDINGGEAR 6 07	1
4	0402061480	NEEDLE ROLLER DIN5402 6X14,8	2
5	75034019000	SHIFTRAIL 07	1
6	75034005044	SHIFT SHAFT CPL. 07	1
7	56534013100	TENSIONING SPRING 0,8MM	1
8	54634020000	SPRING GUIDE	1
9	54634014100	RETURN SPRING 2,2MM '95	1
10	75034050000	STOP DISK 14X30X1,5 STEEL	1
11	54632095000	NEEDLE BEAR.HK 1412 14X20X12	2
12	0760142461	SHAFT SEAL RING 14X24X6B VITON	1
13	75034031000	SHIFT LEVER CPL. 07	1
14	75034032000	SHIFTING LEVER SPRING	1
15	54634031050	BOLT 6X25 FOR SHIFT LEVER	1
17	50232050001	STEEL WASHER 6,4X17X3	1
18	50233041000	PAIR OF WASHERS M 6 NORDLOCK	1
19	59009062016	SPECIAL SCREW M6X16 WS=8 10.9	1
20	0024060206	HH COLLAR SCREW M6X20 TX30	1
21	75034024044	LOCKING LEVER CPL. 07	1
22	75034052000	SLEEVE FOR LOCKING LEVER 07	1
23	60034023000	ARRESTING LEVER SPRING 03	1
24	0012060303	AH SCREW DIN6912 M6X30 8.8	1
25	75034015000	SHIFT DRUM LOCATING CPL. 07	1
26	0625618052	BALL BEARING 6805 C3 JR	1
27	75034012044	SHIFT ROLLER CPL. 07	1
28	0618354212	NEEDLE BEAR HK3512 35X42X12	1
29	60034014000	CONTACT SPRING 03	2
30	60034037000	CONTACT BOLT 03	2
31	0770275025	O-RING 27,5X2,5 NBR	1
32	60011023100	GEAR-POSITION SENSOR 06	1
33	0025050166	HH COLLAR SCREW M5X16 TX30	2
34	75034006000	SPACER	1
36	75034007000	SPRING FOR OPERATING SHAFT	1

097503411 / C097503411

\* NEW PART

X AS REQUIRED

# WATER PUMP

690 LC4 DUKE 2010

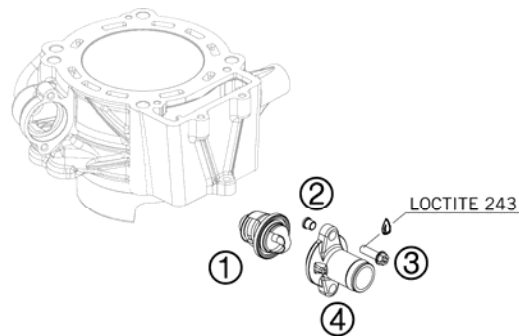

# ENTHALTEN IM DICHTSATZ MOTOR LC4  
INCLUDED IN GASKET-SET ENGINE LC4

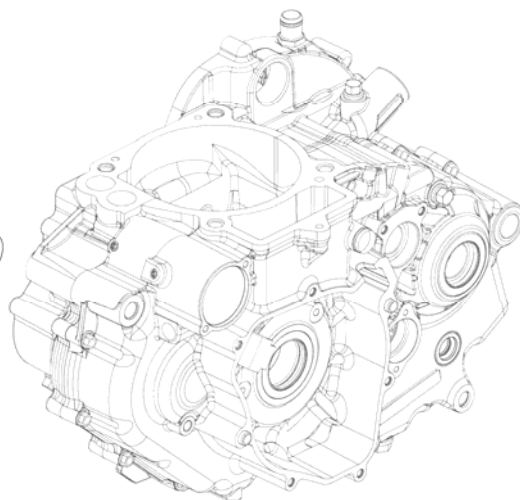
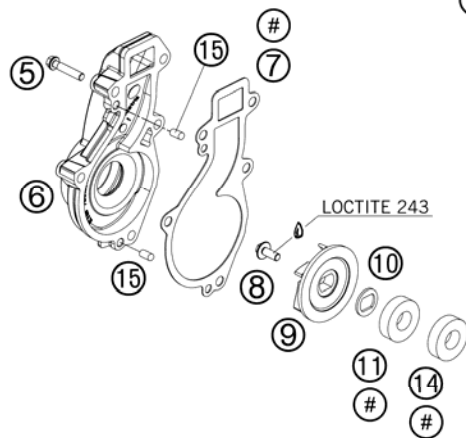

FIG	PART NUMBER	DESCRIPTION	QTY
1	75035017000	THERMOSTAT 07	1
2	60040027050	SUPPORTING SLEEVE 03	2
3	0025060206	HH COLLAR SCREW M6X20 TX30	2
4	75035016000	THERMOSTATCOVER 07	1
5	0025060306	HH COLLAR SCREW M6X30 TX30	5
6	75035052100	WATERPUMP COVER 07	1
7	75035053000	WATER PUMP COVER GASKET 07	1
8	0024060156	HH COLLAR SCREW M6X15 TX30	1
9	75035055000	WATER PUMP ROTOR 07	1
10	60035055150	FORM WASHER 16X1 NIRO 03	1
11	0760123071	SHAFT SEAL RING. 12X30X7 VITON	1
14	0760123073	SHAFT SEAL RING 12X30X7 PTFE	1
15	0474050100	GROOVED PIN DIN1474 5X10	2

097503510 / C097503510

\* NEW PART

X AS REQUIRED



# COOLING SYSTEM

690 LC4 DUKE 2010

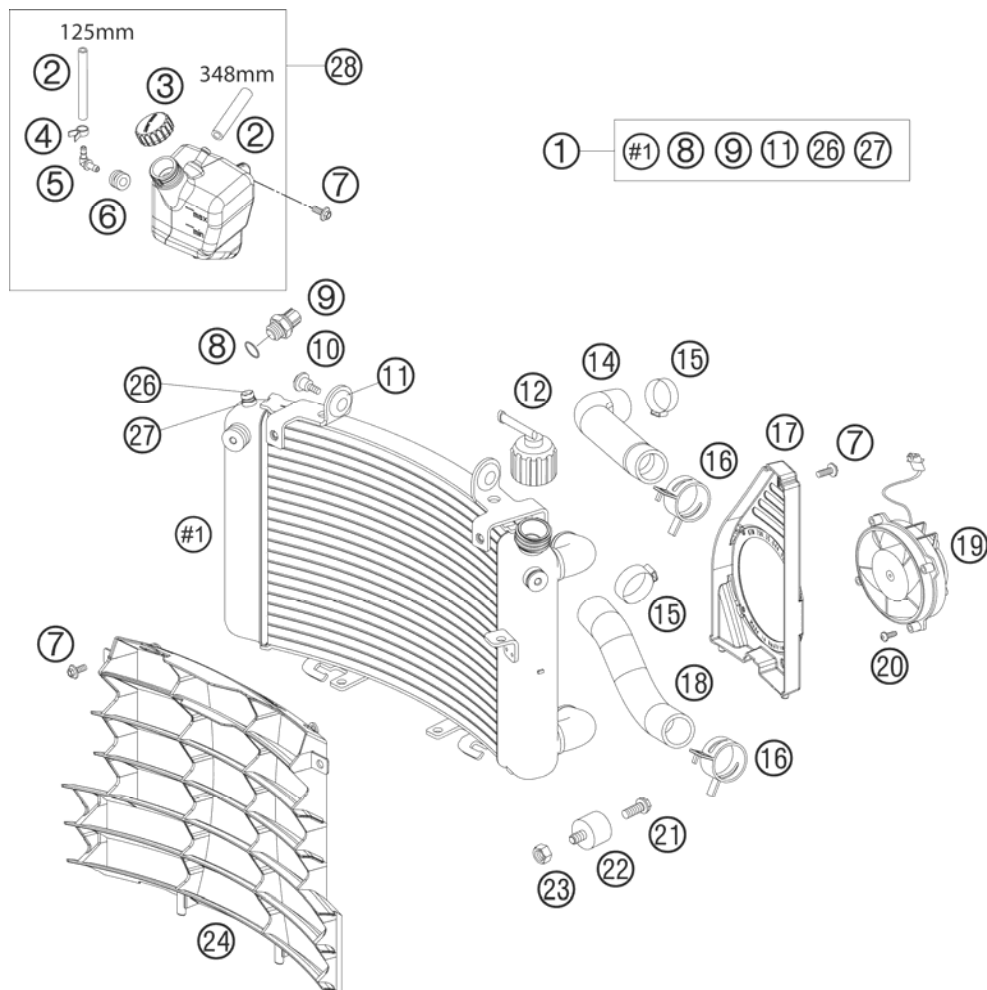

FIG	PART NUMBER	DESCRIPTION	QTY
1	75035010000	RADIATOR "45529"	07
2	60035067001	HOSE 6X10 EPDM	03
3	60035066000	PLUG F. EXPANSION TANK	1
4	58007117000	YDNAC-CLAMP 10107 10MM	x
5	60035068000	ANGLE CONNECTION EXPANS. TANK	1
6	60035069000	RUBBER GROMMET 6X9X13MM	04
7	0024060106	HH COLLAR SCREW M6X10 TX30	4
8	0770017015	O-RING 17X1,5 NB75	1
9	60035045000	THERMOSWITCH LC8 102DG '03	1
10	60035001000	SPECIAL SCREW M6X21 WS=8	2
11	41001052000	RUBBER SLEEVE D=12MM	2
12	62535009000	RADIATOR CAP 1,4 BAR	1
14	75035027000	RADIATOR HOSE	07
15	00050331706	VARIABLE ONE-EAR CLAMP 33,1MM	2
16	00049320121	CLAMP STD DN32	2
17	75035044000	FAN COWL	07
18	75035026000	RADIATOR HOSE	07
19	58435041000	FAN CPL. 12V LC4	2000
20	0020050163	% EJOT SCREW K50X16 1451	4
21	0024060106	HH COLLAR SCREW M6X10 TX30	2
22	43205062100	RUBBER GROMMET 20X15-M6X10 (1)	2
23	0985060003	SELF LOCK. NUT DIN0985-M 6	2
24	75035040000	RADIATOR PROTECTOR	07
26	0025060106	HH COLLAR SCREW M6X10 TX30	1
27	60035048000	ALU-GASKET 6X10X1.5	1
28	75035065000	EXPANSION TANK CPL.	07

087503530 / C097503531

\* NEW PART

X AS REQUIRED

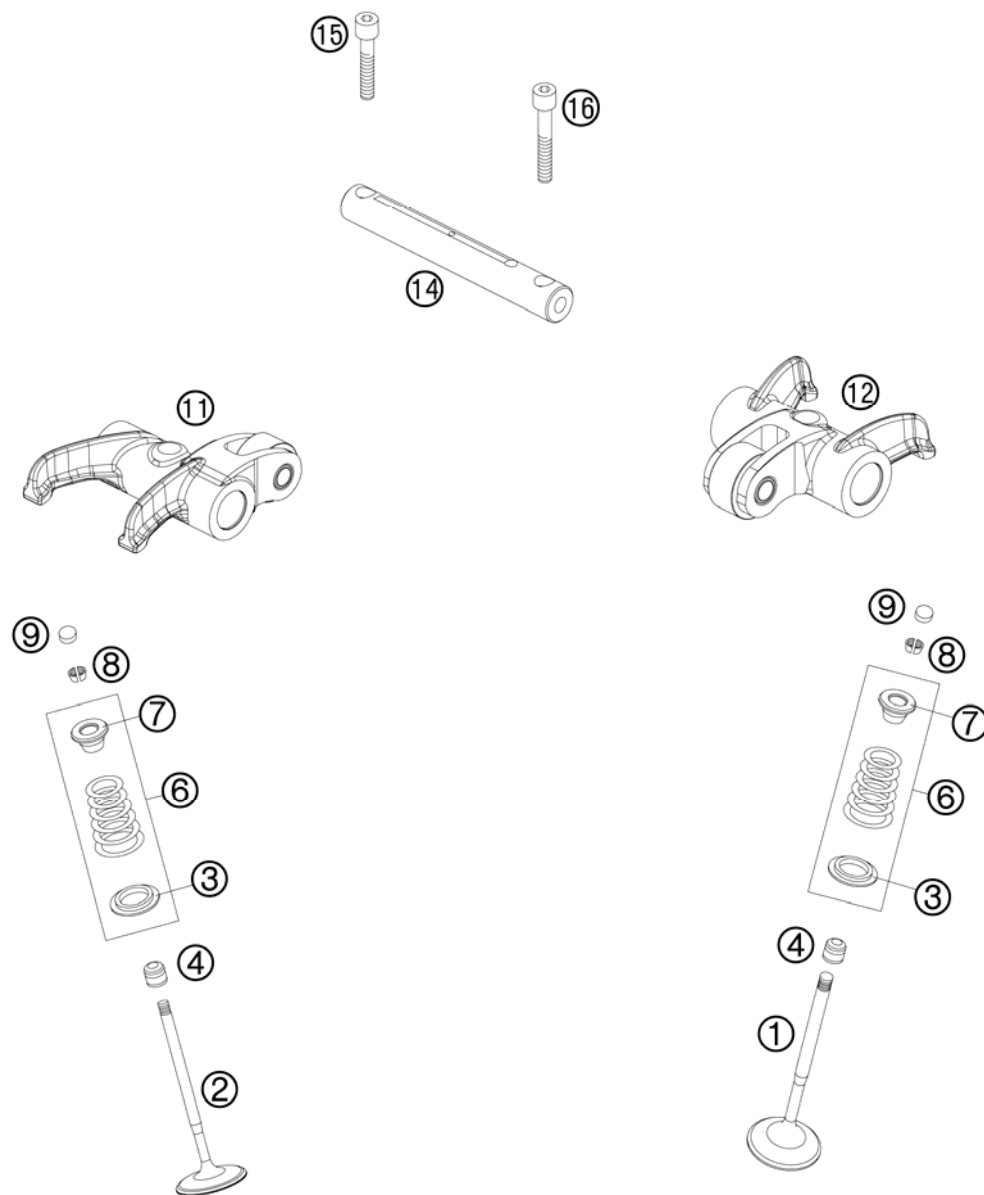

FIG	PART NUMBER	DESCRIPTION	QTY
1	75036030000	INTAKE VALVE 07	2
2	75036031000	EXHAUST VALVE 07	2
3	75036036000	VALVE SPRING HOLDER 07	4
4	59036027000	VALVE-STEM SEALING RACING	4
6	75036028044	VALVE SPRING KIT 07	4
7	75036032000	VALVE SPRING RETAINER 07	4
8	60036033000	VALVE COLLET MK6 03	8
9	60036035185	SHIM D=10/1,85 03	x
9	60036035190	SHIM D=10/1,90 03	x
9	60036035195	SHIM D=10/1,95 03	x
9	60036035200	SHIM D=10/2,00 03	x
9	60036035205	SHIM D=10/2,05 03	x
9	60036035210	SHIM D=10/2,10 03	x
9	60036035215	SHIM D=10/2,15 03	x
9	60036035220	SHIM D=10/2,20 03	x
9	60036035225	SHIM D=10/2,25 03	x
9	60036035230	SHIM D=10/2,30 03	x
9	60036035235	SHIM D=10/2,35 03	x
9	60036035240	SHIM D=10/2,40 03	x
9	60036035245	SHIM D=10/2,45 03	x
9	60036035250	SHIM D=10/2,50 03	x
9	60036035255	SHIM D=10/2,55 03	x
9	60036035260	SHIM D=10/2,60 03	x
9	60036035265	SHIM D=10/2,65 03	x
9	60036035270	SHIM D=10/2,70 03	x
9	60036035275	SHIM D=10/2,75 03	x
9	60036035280	SHIM D=10/2,80 03	x
9	60036035285	SHIM D=10/2,85 03	x
9	60036035290	SHIM D=10/2,90 03	x
9	60036035295	SHIM D=10/2,95 03	x
9	60036035300	SHIM D=10/3,00 03	x
9	60036035305	SHIM D=10/3,05 03	x
9	60036035310	SHIM D=10/3,10 03	x
9	60036035315	SHIM D=10/3,15 03	x
9	60036035320	SHIM D=10/3,20 03	x
11	75036061044	ROCKER ARM EXHAUST CPL. 07	1

087503610 / C087503610

\* NEW PART

X AS REQUIRED

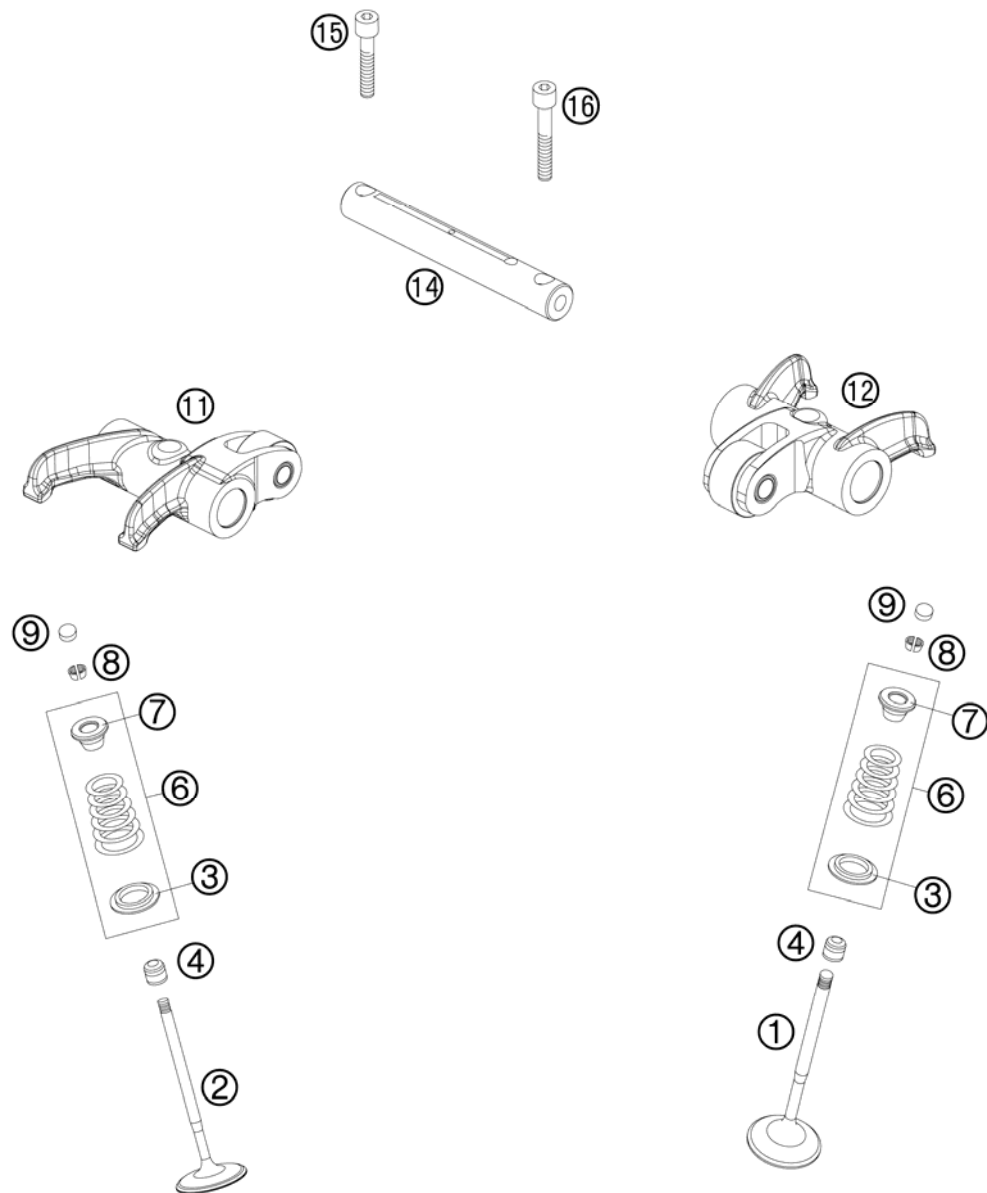

FIG	PART NUMBER	DESCRIPTION	QTY
12	75036060044	ROCKER ARM INTAKE CPL. 07	1
14	75036056000	ROCKER ARM SHAFT 07	2
15	0912060306	AH SCREW DIN912 M6x30	2
16	0912060406	AH SCREW DIN0912 M 6X40	2

087503610 / C087503610

\* NEW PART

X AS REQUIRED

# TIMING DRIVE

690 LC4 DUKE 2010

# ENTHALTEN IM DICHTSATZ MOTOR LC4  
INCLUDED IN GASKET-SET ENGINE LC4

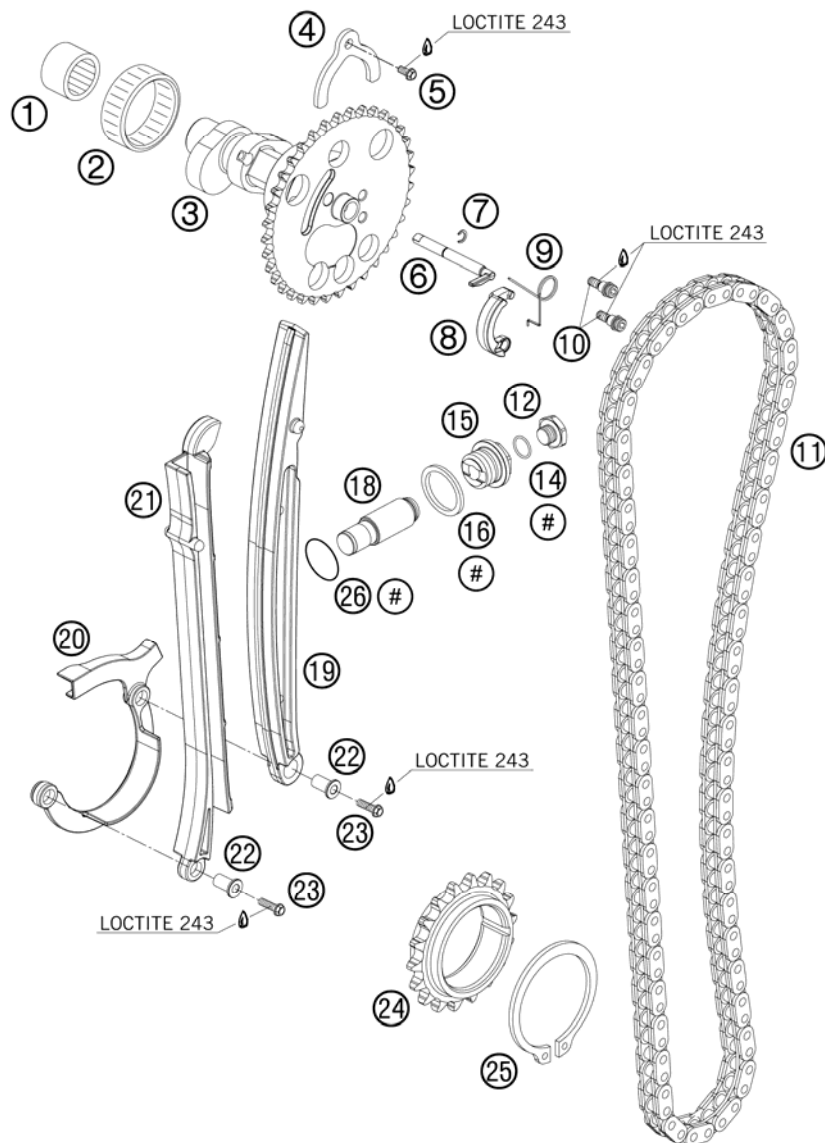

FIG	PART NUMBER	DESCRIPTION	QTY
1	0618182414	NEEDLE SLEEVE HK1814RS18/24/14	1
2	0618404712	NEEDLE SLEEVE HK4012B40X47X12	1
3	76536010000	CAMSHAFT	1
4	75036010050	CAMSHAFT HOLDER 07	1
5	0025060126	HH COLLAR SCREW M6X12 TX30	1
6	75036016000	AUTO DECOMPRESSION 07	1
7	75036016050	HALF MOON RING H6-BLS 07	1
8	75036015000	AUTO DECO WEIGHT 07	1
9	75036017000	SPRING FOR AUTO DECOMPR. 07	1
10	75036019000	DECO SCREW 07	2
11	75036013000	TIMING CHAIN 104 LINKS 07	1
12	77336008010	HOLDING BOLT	1
14	0770010010	O-RING 10,00X1,00 NBR 70 SH	1
15	75036008000	SCREW PLUG CHAIN ADJ. 07	1
16	0603202702	CU SEAL-RING 20X27X1	1
18	77036003000	CHAIN ADJUSTER HYD. 05	1
19	75036002000	TENSIONER RAIL 07	1
20	75036018000	SECURING GUIDE 07	1
21	75036001000	GUIDE RAIL 07	1
22	75036018050	SUPPORTING SLEEVE 07	2
23	0025060306S	HH COLLAR SCREW M6X30 TX30	2
24	75036014000	TIMING PULLEY 07	1
25	0471300151	CIRCLIP DIN0471-30X1,5 NIRO	1
26	0770180020	O-RING 18,00X2,00 NBR 70	1

097503620 / C107563620

\* NEW PART

X AS REQUIRED

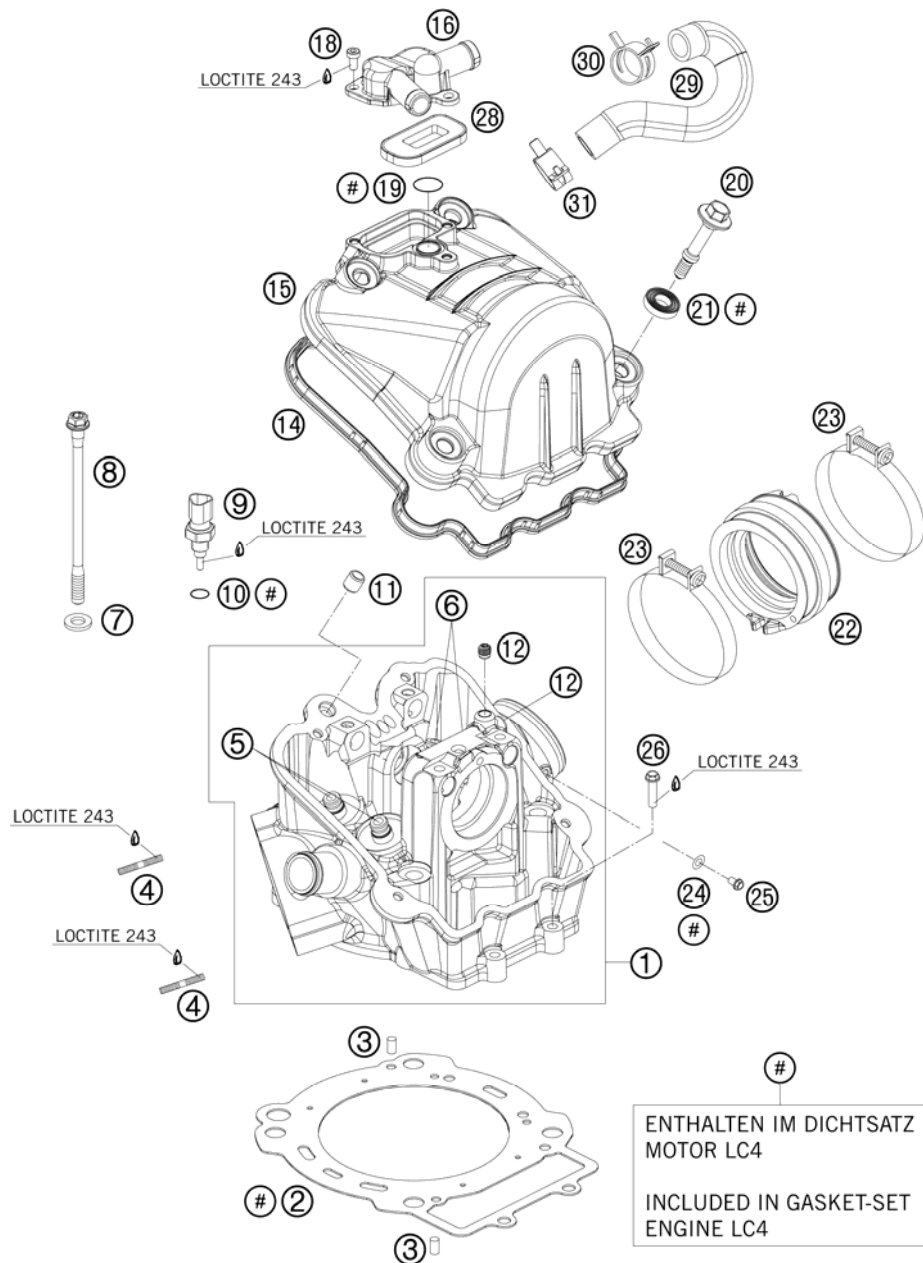

FIG	PART NUMBER	DESCRIPTION	QTY
1	75036020144	CYLINDER HEAD CPL.	1
2	75030036000	CYLINDER HEAD GASKET	07
3	0474050100	GROOVED PIN DIN1474 5X10	2
4	0835080256	STUD DIN0835-M 8X25 10.9	2
5	60036026101	VALVE GIUDE EXHAUST	2
6	60036025101	VALVE GIUDE INTAKE	2
7	60036078050	SHIM 10,2X19X1,5MM	05
8	75036079000	CYLINDERHEAD SCREW M10X168WS14	4
9	75035047000	TEMPERATURE SENSOR WATER	07
10	0770100020	O-RING 10,00X2,00 SILCONE	1
11	49030090000	DOWEL 9,8 X 7 X 10	1
12	59030296000	SCREW PLUG	4
14	75036053000	VALVE COVER GASKET	07
15	75036052000	VALVE COVER	07
16	75036052050	BREATHER COVER	07
18	07984050100	AH SCREW DIN7984 M5X10 A2	3
19	0770150151	O-RING 15,00X1,50 VITON	1
20	75036055000	VALVE COVER SCREW	05
21	75036052010	DECOUPLING ELEMENT	07
22	75036044000	INTAKE BOOT	07
23	75036047000	HOSE CLAMP GEMI 70MM	2
24	0603061001	CU-SEAL RING DIN7603-6X10X1	1
25	0025060086	HH COLLAR SCREW M6X8 TX30	1
26	0025060256	HH COLLAR SCREW M6X25 TX30	2
28	60005026000	SLS-VALVE	03
29	75030084000	BREATHER SYSTEM CYL. BOX	07
30	00049200121	CLAMP STD DN20	1
31	00049210121	CLAMP 21X12 STD-DES	1

097563630 / C107563630

\* NEW PART

X AS REQUIRED

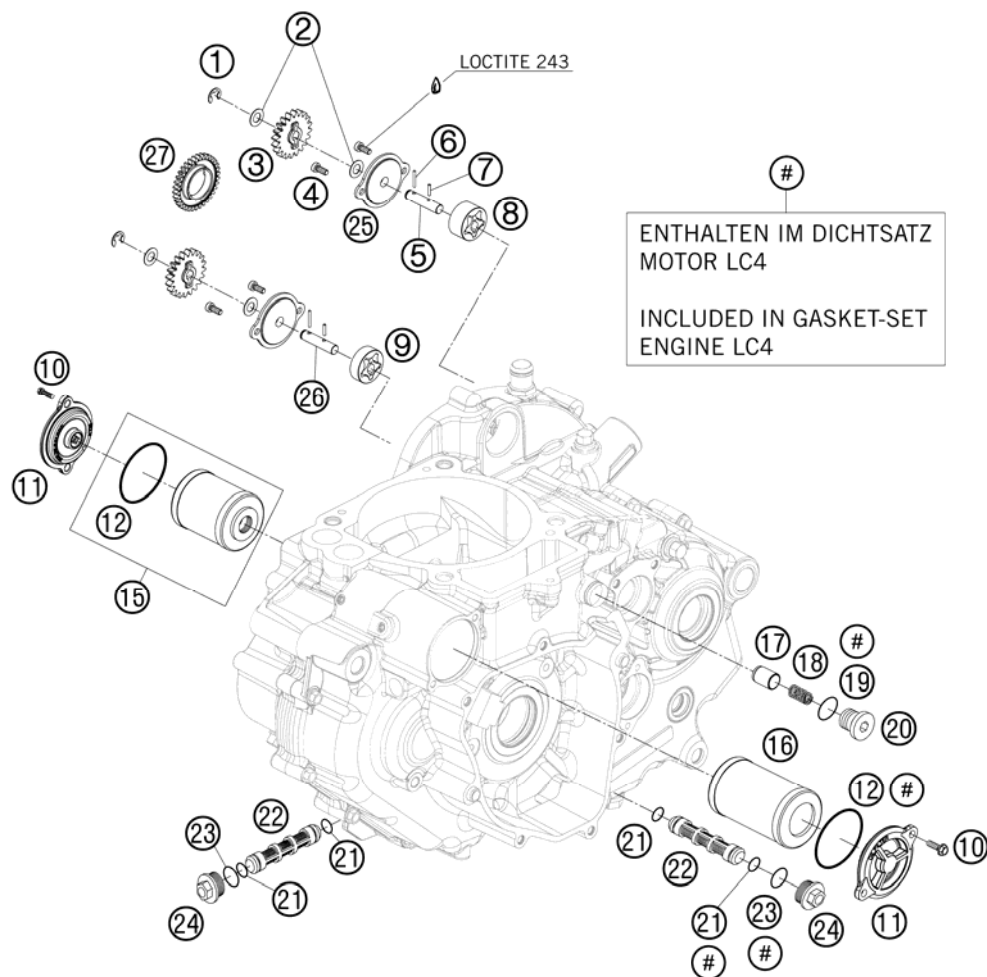

FIG	PART NUMBER	DESCRIPTION	QTY
1	0799060000	TAB WASHER DIN6799-RS 6,0	2
2	58038007755	STOP DISK 8,1 X 15 X 0,5	4
3	75038001020	OIL PUMP GEAR 20-T	2
4	07984050100	AH SCREW DIN7984 M5X10 A2	4
5	75038002000	OIL PUMP SHAFT 07	1
6	0402251980	NEEDLEROL.DIN5402 NRA 2,5X19,8	2
7	0402251180	NEEDLE ROLLER DIN5402 2,5X11,8	2
8	77038011000	OILPUMP ROTOR 15MM G-164	1
9	59038011010	OILPUMP ROTOR CPL. 10MM G-73R	1
10	0025050166	HH COLLAR SCREW M5X16 TX30	4
11	75038041200	OILFILTER CAP	2
12	0770039026	O-RING 39,34X2,62 NBR 70 SH	2
15	59038046144	OIL FILTER SHORT WITH GASKET	1
16	58038005100	OIL FILTER LONG	1
17	58038028000	VALVE PISTON D=10MM	1
18	58538023000	OIL PRES.SPRING 5 BAR RED 2001	1
19	58038022000	CU-SEAL RING DIN7603-12X18X1,5	1
20	0908120153	PLUG DIN0908-M12X1,5	1
21	07701250151	O-RING 12,5X1,5 VITON V75	4
22	59038016000	OIL SCREEN 15X83MM	2
23	0770020170	O-RING 17,17X1,78 GLO	2
24	59038017000	PLUG M20X1,5 WS=13	2
25	75038003000	OIL PUMP COVER 07	2
26	75038004000	OIL PUMP SHAFT 07	1
27	75032050001	OIL PUMP DRIVE WHEEL 07	1

097503810 / C097503810

\* NEW PART

X AS REQUIRED

# IGNITION SYSTEM

690 LC4 DUKE 2010

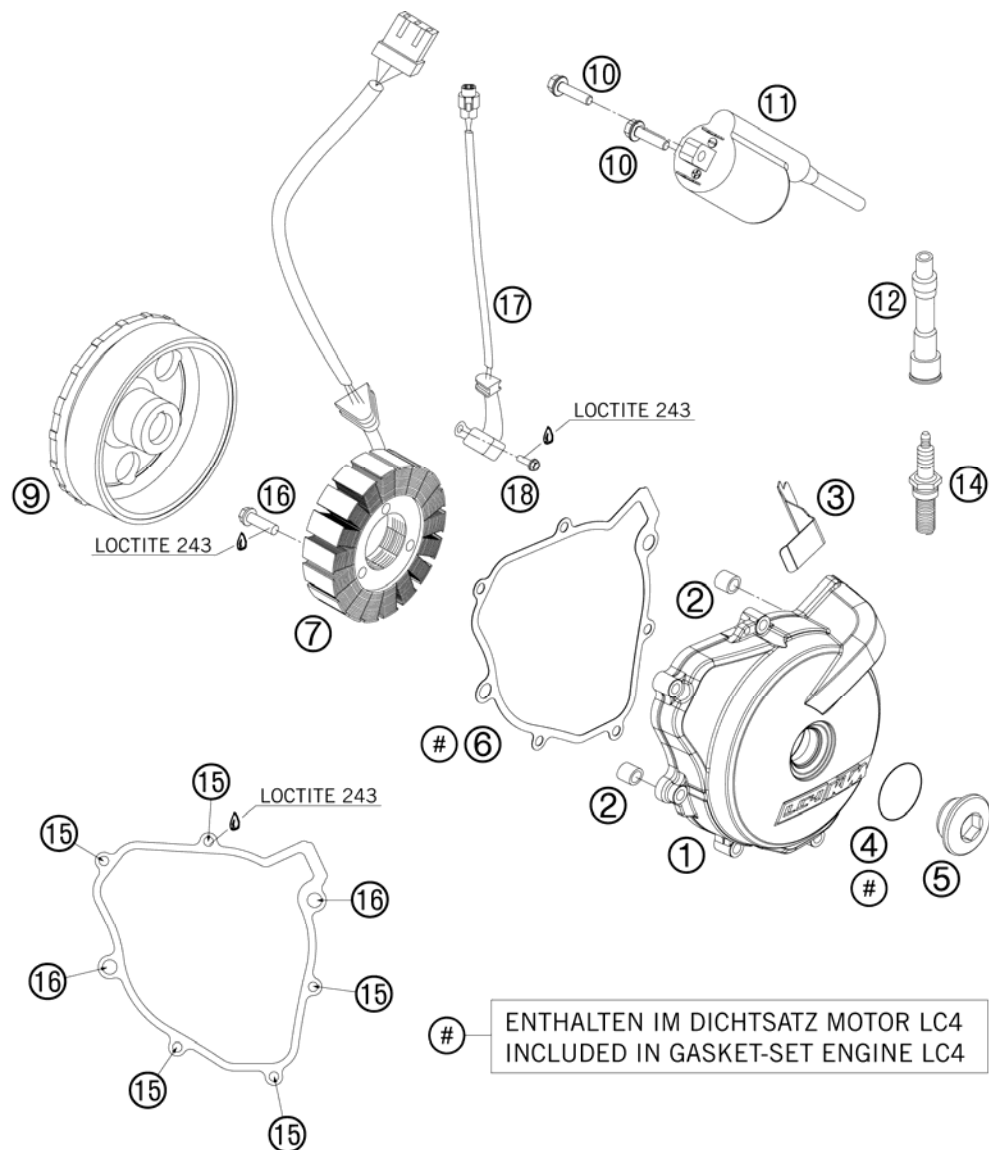

FIG	PART NUMBER	DESCRIPTION	QTY
1	75030002000	IGNITION COVER 07	1
2	49030090000	DOWEL 9,8 X 7 X 10	2
3	60039040020	CABLE SUPPORT GENERATOR 03	1
4	07700240251	O-RING 24X2,5 VITON	1
5	6003009400030	SCREW PLUG M24X1,5 PA 6.6	1
6	75030040000	IGNITI.COVER GASKET 07	1
7	75039004000	STATOR	1
9	75039005000	FLYWHEEL	1
10	0025050166	HH COLLAR SCREW M5X16 TX30	2
11	75039006000	IGNITIONCOIL 07	1
12	75039090000	SPARK PLUG CONNECT.	1
14	75039093000	SPARK PLUG M12X1,25 LKAR8AI-9	1
15	0025060256	HH COLLAR SCREW M6X25 TX30	5
16	0025060306	HH COLLAR SCREW M6X30 TX30	5
17	75039034000	PULSER COIL	1
18	0025060166	HH COLLAR SCREW M6X16 TX30	2

097503910 / C097503910

\* NEW PART

X AS REQUIRED

# ELECTRIC STARTER

690 LC4 DUKE 2010

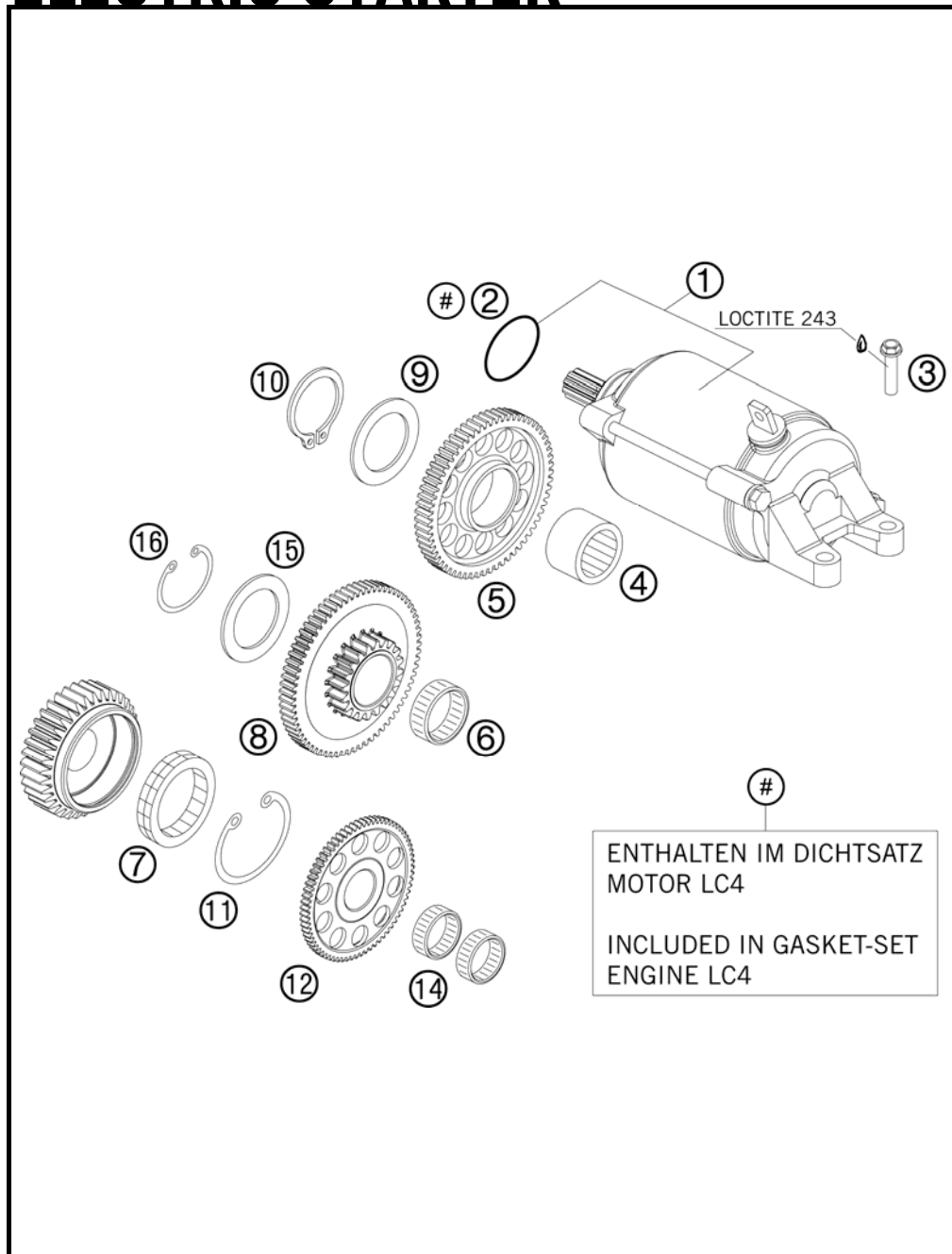

FIG	PART NUMBER	DESCRIPTION	QTY
1	75040001000	E-STARTER ENGINE CPL. 07	1
2	0770335030	O-RING 33,5X3 VITON	1
3	0025060206	HH COLLAR SCREW M6X20 TX30	2
4	0618172312	NEEDLE SLEEVE HK 1712 17X23X12	1
5	75040022000	INTERMEDIATE GEAR	1
6	0405172117	NEEDLE BEARING K17X21X17	1
7	75040026000	FREE WHEEL	1
8	75040015000	TORQUE LIMITER 07	1
9	54633090000	STOP DISK 17,2X25X1	1
10	0471170010	CIRCLIP DIN0471-17X1	1
11	0472056200	CIRCLIP DIN0472 J56	1
12	75040020000	FREEWHEEL GEAR 07	1
14	0405263013	NEEDLE BEAR. K 26X30X13	2
15	75040015007	STOP DISK 17,2X22X1	1
16	0471170100	CIRCLIP DIN 0471-17X1	1

097504010 / C097504010

\* NEW PART

X AS REQUIRED



# THROTTLE BODY

690 LC4 DUKE 2010

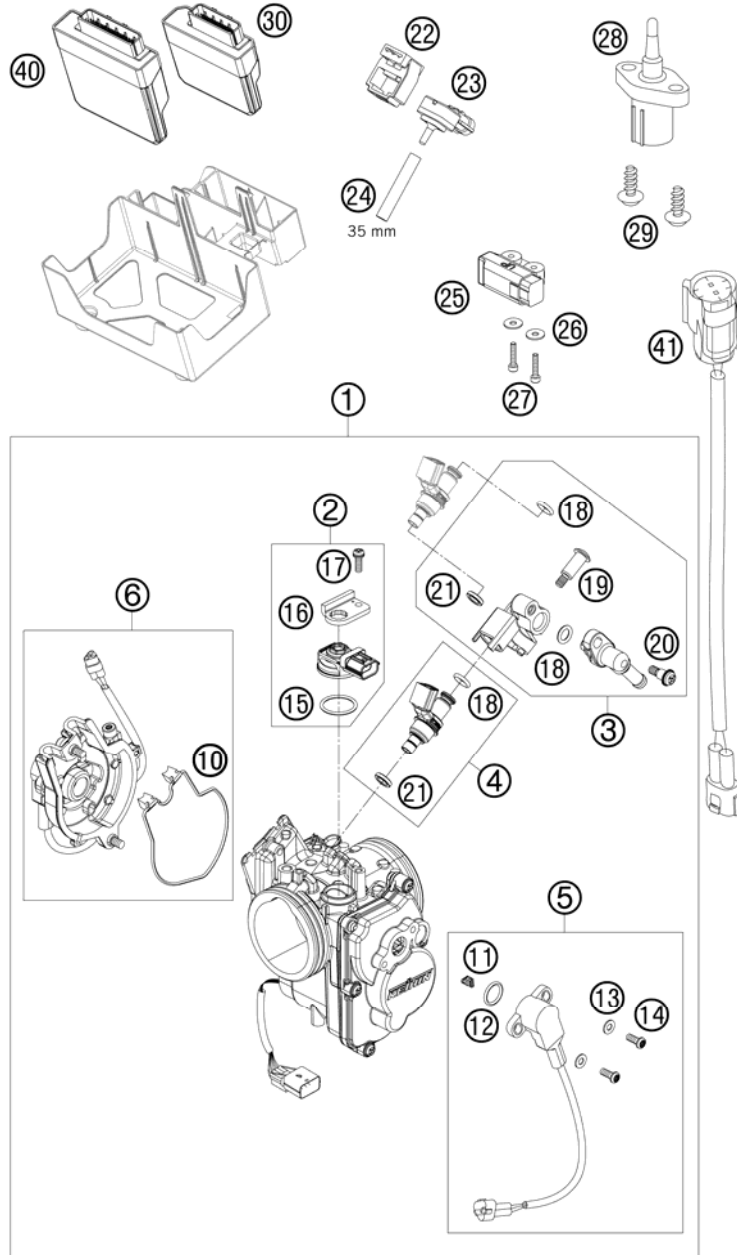

FIG	PART NUMBER	DESCRIPTION	QTY
1	75041001000	THROTTLE BODY	1
2	75041085044	MAP SENSOR CPL. 07	1
3	75041013044	FUEL RAIL ASSY SET 07	1
4	75041023044	FUEL INJECTOR ASSY SET 07	1
5	75041077044	TPS SENSOR CPL. 07	1
6	75041001044	APS UNIT CPL. 07	1
10	75041001060	PACKING	1
11	75041077020	CONNECTOR JOINT	1
12	75041077010	O-RING	1
13	75041077040	WASHER	2
14	75041077030	SCREW TORX	2
15	75041085010	O-RING	1
16	75041085020	PLATE, STAY	1
17	75041085030	SCREW WASHER	1
18	75041023020	O-RING	2
19	75041013060	SCREW SHOULDER	1
20	75041013010	SCREW SHOULDER	1
21	75041023010	SEAL RING	1
22	61041085150	RUBBER SUPP. PRESSURE SENS. 06	1
23	61041085100	PRESSURE SENSOR 06	1
24	60031098001	HOSE 3,2X8,5 PER METER	x
25	61041088000	ROLLOVER SENSOR 05	1
26	61041088050	SHIM 4,3X15X1,25MM GALVANIZED	2
27	0912040203	AH SCREW DIN 912-M 4X20	2
28	61041080000	AMBIENT-AIR TEMPERATURE SENSOR	1
29	0016050121	SCREW FOR PLASTIC 50X12	2
30	75041032000	TIMING CHARGER EPT 07	1
40	75041031000	TIMING CHARGER EFI 07	1
41	75011047000	AMBIENT-AIR TEMP. SENSOR CABLE	1

097504110 / C087504111

\* NEW PART

X AS REQUIRED







KTM-Sportmotorcycle AG  
A-5230 Mattighofen  
[www.ktm.at](http://www.ktm.at)

KTM Group Partner



3CM088515JEN



Art.Nr.: 3CM088515JEN 9/2009