

640 DUKE II

OWNER'S MANUAL
MANUALE D'USO
MANUEL D'UTILISATION
MANUAL DE INSTRUCCIONES

ART.NR: 3.210.87



10/2003

FOTO: MITTERBAUER

IMPORTANT

WE STRONGLY SUGGEST THAT YOU READ THIS MANUAL CAREFULLY AND COMPLETELY BEFORE GOING ON YOUR FIRST RIDE. IT CONTAINS A GREAT DEAL OF INFORMATION AND ADVICE WHICH WILL HELP YOU USE AND HANDLE YOUR BIKE PROPERLY. IN YOUR OWN INTEREST, PLEASE PAY PARTICULAR ATTENTION TO NOTICES THAT ARE MARKED AS FOLLOWS:

△ **WARNING** △

IGNORING THESE INSTRUCTIONS, CAN ENDANGER YOUR BODY AND YOUR LIFE.

! **CAUTION** !

IGNORING THESE INSTRUCTIONS COULD CAUSE DAMAGE TO PARTS OF YOUR MOTORCYCLE OR THAT THE MOTOR-CYCLE IS NOT ROAD-SAFE ANYMORE.

Please insert the serial numbers of your motorcycle in the boxes below

Frame number

Engine number

Key number

Stamp of dealer

CONSUMER INFORMATION FOR AUSTRALIA ONLY

Tampering with noise control system prohibited

Owners are warned that the law may prohibit:

- (a) The removal or rendering inoperative by any person other than for purposes of maintenance, repair or replacement, of any device or element of design incorporated into any new vehicle for the purpose of noise control prior to its sale or delivery to the ultimate purchaser or while it is in use; and
- (b) the use of the vehicle after such device or element of design has been removed or rendered inoperative by any person.

KTM SPORTMOTORCYCLE AG RESERVES THE RIGHT TO MODIFY ANY EQUIPMENT, TECHNICAL SPECIFICATIONS, COLORS, MATERIALS, SERVICES OFFERED AND RENDERED, AND THE LIKE SO AS TO ADAPT THEM TO LOCAL CONDITIONS WITHOUT PREVIOUS ANNOUNCEMENT AND WITHOUT GIVING REASONS, OR TO CANCEL ANY OF THE ABOVE ITEMS WITHOUT SUBSTITUTING THEM WITH OTHERS. IT SHALL BE ACCEPTABLE TO STOP MANUFACTURING A CERTAIN MODEL WITHOUT PREVIOUS ANNOUNCEMENT. IN THE EVENT OF SUCH MODIFICATIONS, PLEASE ASK YOUR LOCAL KTM DEALER FOR INFORMATION.

Introduction

We would like to congratulate you on your purchase of a KTM motorcycle.

You are now the owner of a state-of-the-art sport motorcycle that guarantees to bring you lots of fun and enjoyment, provided that you clean and maintain it appropriately. **Before you go for your first ride, be sure to read this manual carefully and thoroughly in order to familiarize yourself with how to operate your new motorcycle and with its characteristics, even if this means that you will have to dedicate some of your valuable time to this task. Only by doing so will you learn how to tune your motorcycle to your specific needs and how to protect yourself against injury. Besides, this manual contains important information on motorcycle maintenance.** At the time this manual was typeset, it was up-to-date with the latest state of this production series. It cannot be completely ruled out, however, that minor discrepancies may exist resulting from further design upgrades of these motorcycles. This manual is an important part of your motorcycle and should be passed on to any subsequent owner in case you decide to sell it.

We expressly point out that work marked with an asterisk in the chapter "Maintenance work on the chassis and engine" must be performed. If maintenance work should become necessary during a competition it should be performed by a trained mechanic. KTM strongly recommends that all service work to your KTM should be performed by a qualified KTM dealer.

For your own safety, use KTM-approved parts and accessories only. KTM is not liable for damage that arises in connection with the use of other products.

Take special care to follow the recommended run in, inspection, and maintenance intervals. Heeding these guidelines will significantly increase the life of your motorcycle. To ensure that all work to your KTM is performed properly and to avoid warranty conflicts, KTM recommends that you always have your KTM serviced by a recognized and qualified KTM dealer.

Motorcycle driving is a wonderful sport and we hope that you will be able to enjoy it to the full. It may, however, involve potential problems for the environment or lead to conflicts with others. These problems or conflicts can be avoided if the motorcycle is used responsibly. To safeguard the future of motorcycle sports, make sure that you use the motorcycle in accordance with the law, show that you are environmentally conscious and respect the rights of others.

We wish you a lot of fun when driving !

KTM SPORTMOTORCYCLE AG
5230 MATTIGHOFEN, AUSTRIA

ALL RIGHTS RESERVED TO MAKE ALTERATIONS TO DESIGN AND MODEL.

IMPORTANT LIMITED WARRANTY AND LIMITED GUARANTEE INFORMATION

The 640 DUKE model is designed for regular on-road service but not for use off of paved roads.

The service, care and operating instructions for the engine and chassis specified in the owner's manual must be observed to ensure that the bike runs smoothly and to avoid premature wear.

The service work specified in the "Lubrication and Maintenance Schedule" must be performed and service records must be kept for warranty documentation. Lack of proper service and maintenance records or documentation could void warranty.

The fuels and lubricants specified in the owner's manual or those of an equal quality must be used in accordance with the maintenance schedule.

The warranty or guarantee shall become void for damage and consequential damage caused by manipulations or conversions to the motorcycle.

The use of the motorcycle under extreme conditions, e.g. on extremely muddy and wet terrain, can lead to higher than average wear on components such as the drive train or the brakes. In this case it may become necessary to service or replace wear parts before the service limit specified in the maintenance schedule has been reached.



REG.NO. 12 100 6061

In accordance with the international quality management ISO 9001 standard, KTM uses quality assurance processes that lead to the highest possible product quality.

INDEX

	Page		Page
SERIAL NUMBER LOCATIONS5		
Chassis number5	Correcting chain tension21
Engine number, engine type5	Chain maintenance21
OPERATION INSTRUMENTS5	Chain wear22
Clutch lever5	Maintaining chain tension eccentrics22
Hand decompression lever5	General information about KTM disc brakes23
Choke lever5	Changing the basic position of the handbrake lever ..	.24
Hand brake lever6	Checking of brake fluid level - front brake24
Speedometer6	Refilling the front brake fluid reservoir24
Tachometer6	Checking the front brake pads24
Indicator lamps6	Changing the basic position of the foot brake pedal ..	.25
Ignition lock with 3 switch positions6	Checking the rear brake fluid level25
Combination switch7	Refilling the rear brake fluid reservoir25
Starter tip switch, emergency OFF tip switch, light switch	7	Checking the rear brake pads25
Filler cap7	Dismounting and mounting the front wheel26
Fuel tap8	Dismounting and mounting the rear wheel26
Shift lever8	Checking the damping rubbers in the rear wheel27
Kickstarter8	Tires, air pressure27
Foot brake pedal8	Battery28
Compression damping of fork9	Charging the battery28
Rebound damping of fork9	Main fuse29
Compression damping of shock absorber9	Fuses29
Rebound damping of shock absorber9	Opening the headlight mask29
Seat lock9	Headlight range adjustment30
GENERAL TIPS AND WARNINGS FOR STARTING THE		Headlight - replacing the bulbs30
MOTORCYCLE10	Parking light - replacing the bulb30
Instructions for initial operation10	Flasher - replacing the bulbs30
Running in10	Stop light and tail light - replacing the bulb31
Driving instructions11	Cooling system31
Check the following before each start11	Checking the cooling liquid level32
Starting when the engine is cold12	Cleaning of air filter32
Starting when the engine is warm12	Changing the original position of the clutch lever33
What to do when the engine is „flooded“12	Checking the oil level of the hydraulic clutch33
Kickstart instructions13	Checking and adjusting the choke cable play33
Starting off13	Checking the adjustment of the hand decompression cable *	.33
Shifting/Riding13	Adjust idling speed34
Braking13	Draining of float chamber of the carburetor34
Stopping and parking14	Engine oil34
Refueling14	Checking the engine oil level34
Activating the ignition curve for low-octane fuel15	Oil circuit35
PERIODIC MAINTENANCE SCHEDULE16	Oil and screen filter change, bleeding of the oil system	.35
MAINTENANCE WORK ON CHASSIS AND ENGINE18	Changing oil filter36
Removing the seat18	TROUBLE SHOOTING37
Supporting strap for the passenger18	CLEANING40
Tool kit18	CONSERVATION FOR WINTER OPERATION40
Checking and adjusting the steering head bearing19	STORAGE40
Bleeder screw front fork19	Re-initiation after time of storage40
Cleaning the dust sleeves of the telescopic fork19	TECHNICAL DATA – ENGINE 640 DUKE II 200441
Changing the spring preload of the shock absorber ..	.20	TECHNICAL SPECIFICATIONS - CHASSIS 640 DUKE II 2004	.42
Checking the rubber ring of the rear shock absorber ..	.20	HEAD WORD INDEX44
Lubricating the shock absorber linkage20	WIRING DIAGRAMMappendix
Checking chain tension21		

SERIAL NUMBER LOCATIONS

Chassis number

The frame number is stamped on the right side of the steering head tube. Write this number into the relevant box on page 1.

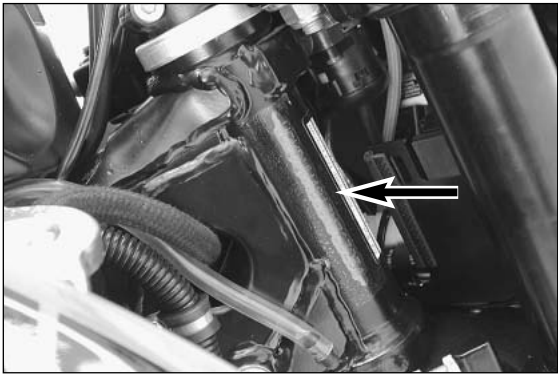

Engine number, engine type

The engine number and engine type are stamped on the right hand side of the engine below the engine sprocket. Write the number into the box on page no 1.

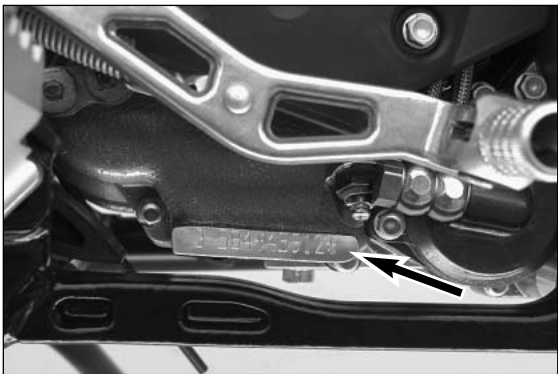

OPERATION INSTRUMENTS

Clutch lever

The clutch lever ❶ is fitted on the left hand side of the handle bar. The adjusting screw ❸ is used to change the original position of the clutch lever (see maintenance work on chassis and engine).

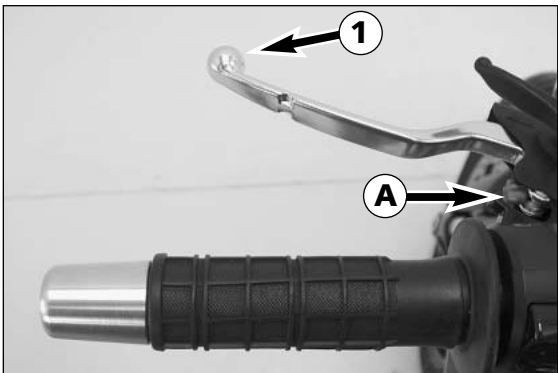

Hand decompression lever

The hand decompression lever ❷ is only used in two special cases:

- a) When the engine stalled.
It is possible that the starter motor is not able to crank the engine on the next attempt. This is due to the fact that the automatic decompressor doesn't work properly. If this happens, pull the manual decompression lever and start again. Afterwards normal starting will be possible.
- b) When you want to push the motorcycle.
While pushing, pull the hand decompression lever to make it easier to get the engine going.

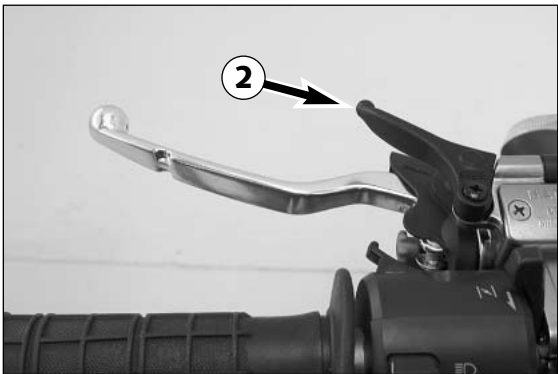

Choke lever

When the choke lever ❸ is pulled backwards, a bore is opened in the carburetor which enables the engine to draw in additional fuel. This produces a „rich“ fuel/air mixture necessary for cold start. When the choke lever is pushed forward as far as it will go, the bore will be closed again. In this position the choke cable must have a play of approx. 2 mm.

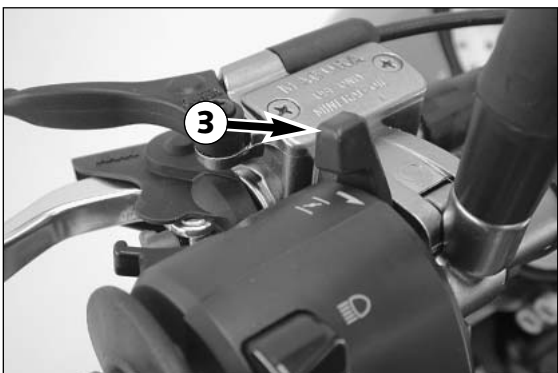

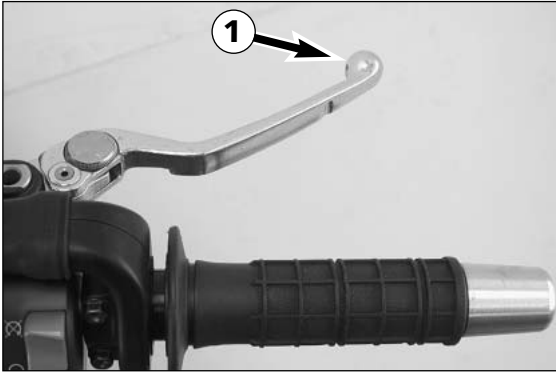

Hand brake lever

The hand brake lever ❶ is mounted on the right side of the handlebar. The basic position of the handbrake lever can be changed in 4 steps (see Maintenance work on chassis and engine).

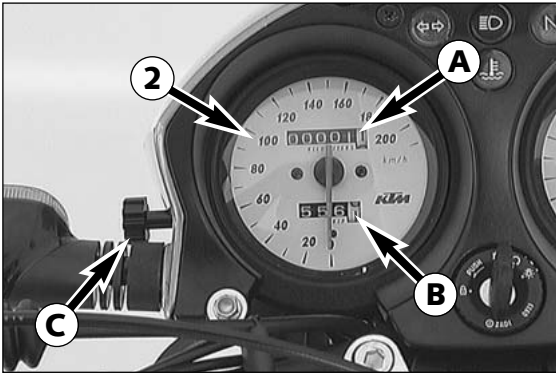

Speedometer

The mileage indicator A in the speedometer ❷ indicates overall mileage. The day mileage indicator B can be set to 0 by means of the setting wheel C. Turn the setting wheel forward until only zeros can be seen in the display.

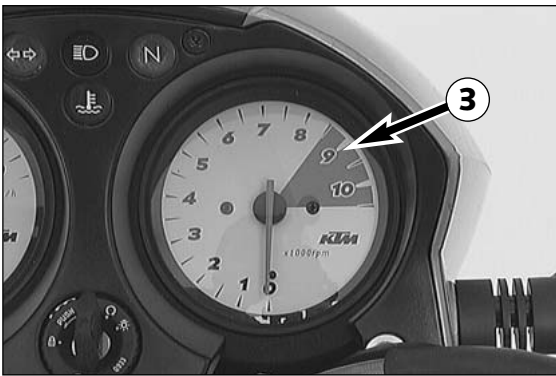



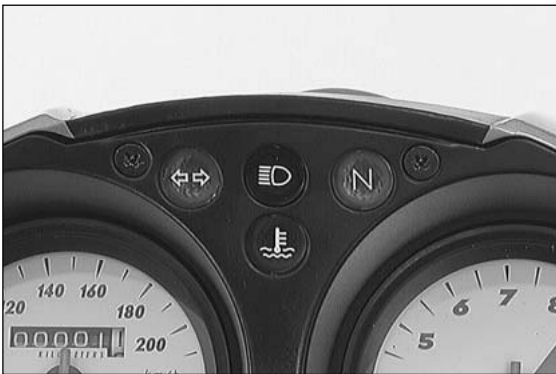

Tachometer

The tachometer ❸ shows the engine speed in revolutions per minute (rpm). Do not push the engine into the orange zone, which begins at 8500 rpm.





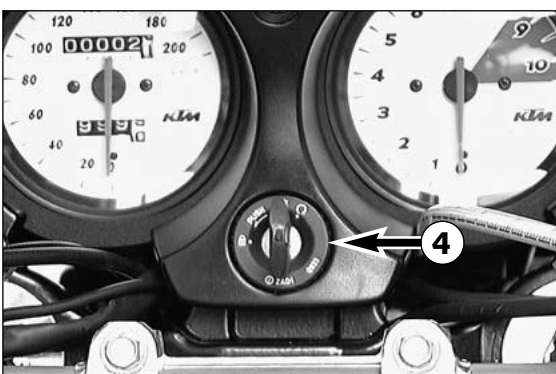

Indicator lamps



-  The green indicator lamp flashes when the flasher light is working in the same rhythm as the flasher light. Faster flashing of the flasher control lamp indicates a defect bulb
-  The blue indicator lamp lights up when the high beam is on.
-  The green indicator lamp lights up when the neutral gear is selected
-  The red cooling liquid temperature warning lamp lights up as soon as the cooling liquid has reached a temperature of approximately 110° C (230° F).



Ignition lock with 3 switch positions

Switch positions of ignition lock ❹:

-  Ignition off, (engine can't be started)
-  Ignition on, (engine can be started)
-  Ignition off, handlebar blocked
To switch the ignition to position  and firmly press it into the lock. Turn the handlebar all the way to the left, then turn the ignition key to the left.

The ignition key can be withdrawn in position  and .

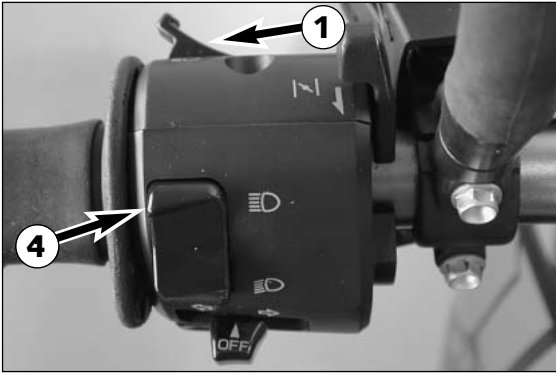

Combination switch

The rocker switch LIGHTS ❶ actuates the high beam or low beam.

☰☉ = High-beam light

☰☉ = Low-beam light

↔ The indicator switch ❷ returns to central position after actuation. Press flasher switch towards switch housing to switch off the flasher.

🔊 The horn is sounded with button ❸.

☰☉ The light signal (high beam) is actuated with button ❹.

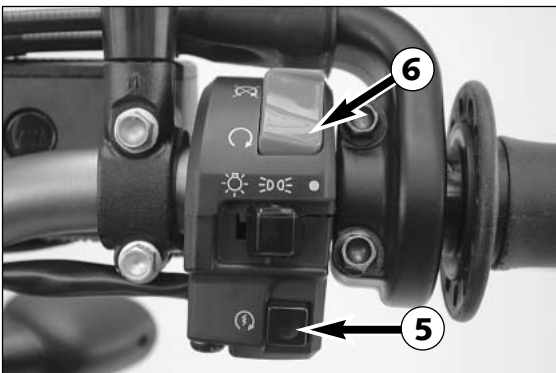
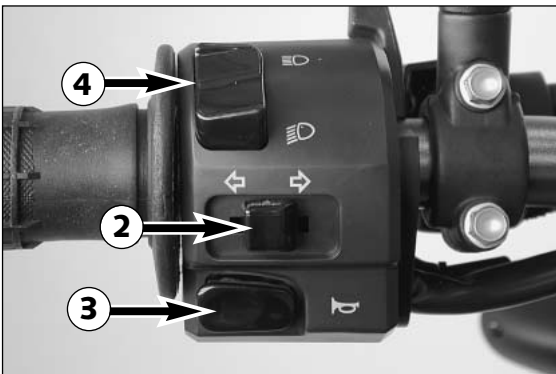

Starter tip switch, emergency OFF tip switch, light switch

⚡ Use the starter tip switch ❺ to operate the electric starter.

The light switch has 3 positions:

● = Light off

☰☉ = Parking light on

☰☉☉ = Headlight on

The emergency off switch ❻ is provided for emergency situations and should not be used to switch off the engine.

The engine is ready for operation in position ○ (ignition circuit and starter circuit are switched on).

The engine cannot be started in position ☒ (ignition circuit and starter circuit are interrupted).

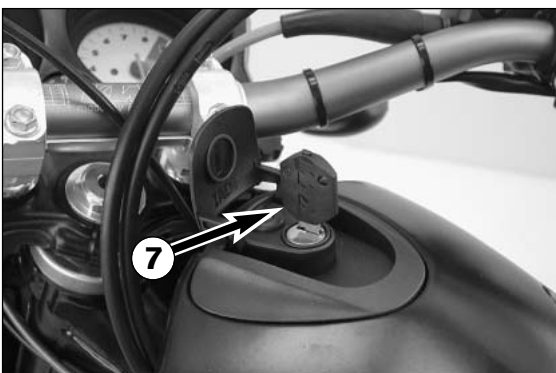

Filler cap

The filler cap ❷ can be locked and is provided with a fuel evaporation control system.

To open the cap insert the ignition key, turn it 90° counterclockwise, then lift off the filler cap.

To close the tank insert the filler cap, turn the ignition key 90° clockwise and take out the key.

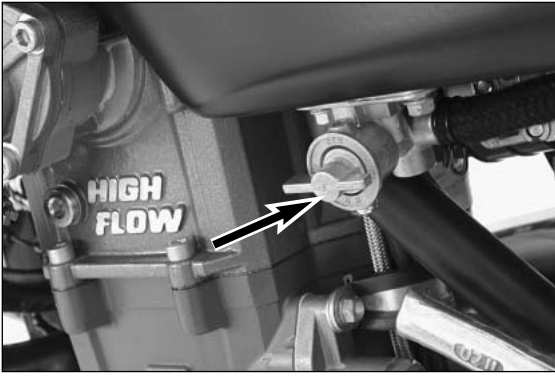

Fuel tap

- OFF** In this position the fuel tap is closed. No fuel may flow to the carburetor.
- ON** When using the motorcycle, the twist grip must be set to the ON position. Now fuel may flow to carburetor. In this position the tank empties down to the fuel reserve of approx. 2.5 liters.
- RES** The reserve, approximately 2.5 liters, cannot be tapped until the twist grip is turned to the RES position. Fill the tank as soon as possible and remember to turn the twist grip back to the **ON** position so that you will have backup fuel next time, too.

! CAUTION !

THE FUEL TAP SHOULD BE LOCKED WHENEVER THE MOTORCYCLE IS PARKED. IF THE TAP IS NOT CLOSED THE CARBURETOR MAY OVERFLOW AND FUEL CAN GET INTO THE ENGINE.

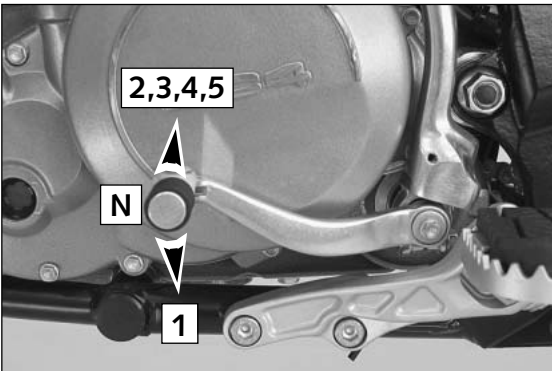
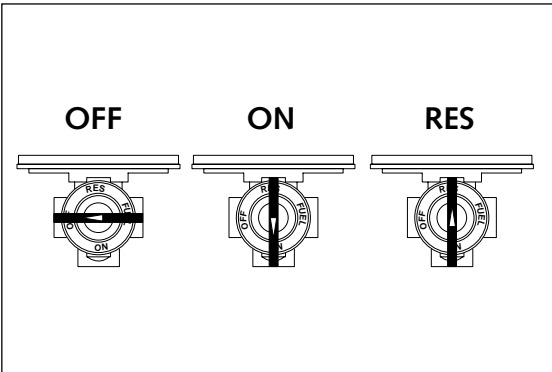

Shift lever

The shift lever is mounted on the left side of the engine. The position of the gears is shown in the illustration. Neutral, or the idle speed, is located between first and second gear.

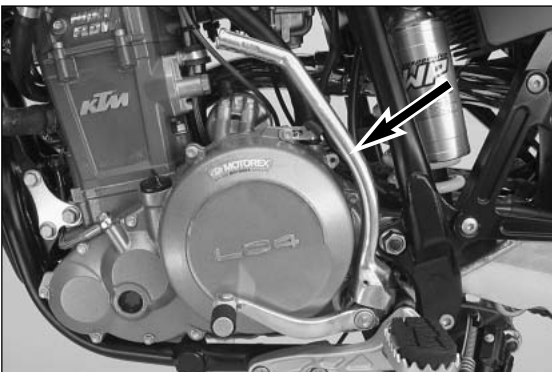

Kickstarter

The kickstarter is mounted on the left side of the engine. Its upper part can be swivelled.

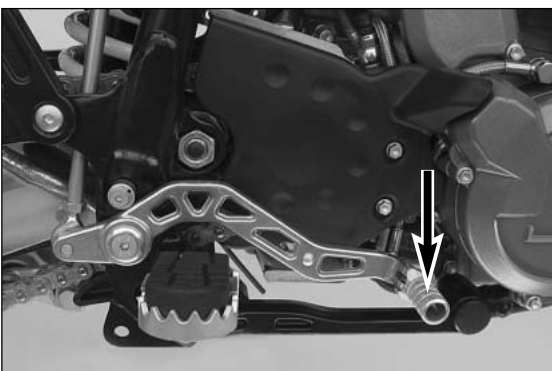

Foot brake pedal

The foot brake pedal is located in front of the right footrest. The basic position can be adjusted to the seat position (see maintenance work).

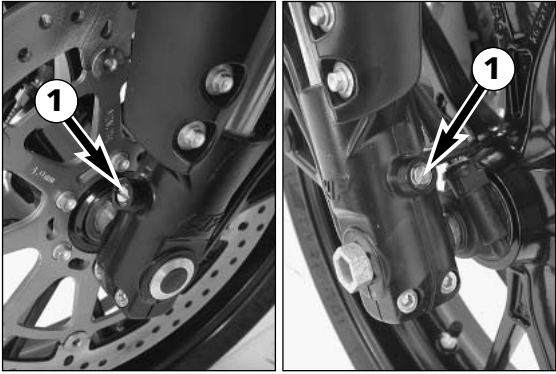

Compression damping of fork

Hydraulic compression damping determines the reaction when the fork is compressed. The degree of compression can be adjusted with adjusting screws at the bottom of the fork legs.

The damping rate of the compression damping mechanism can be readjusted at the adjusting screws 1 located at the fork leg. Turn it clockwise to increase damping, and counterclockwise to reduce damping during compression.

STANDARD ADJUSTMENT

- turn adjusting screw clockwise as far as it will go
- turn it back by as many clicks as are specified for the relevant type of fork

WP 1418Y75514 clicks

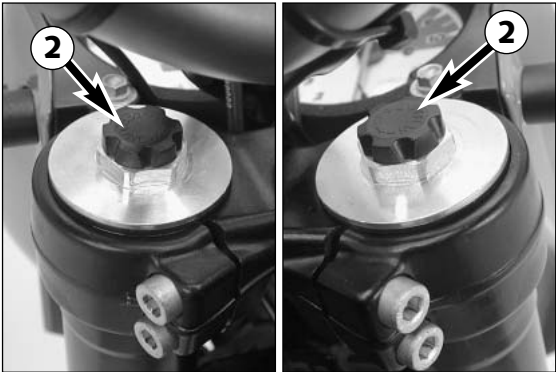

Rebound damping of fork

Hydraulic rebound damping determines the reaction when the fork is rebound. By turning the adjusting screw 2 (REB), the degree of damping of the rebound can be adjusted. Turn the knob clockwise to increase damping, turn it counterclockwise to reduce damping during rebounding.

STANDARD ADJUSTMENT

- turn adjusting screw clockwise as far as it will go
- turn it back by as many clicks as are specified for the relevant type of fork

WP 1418Y755 16 clicks

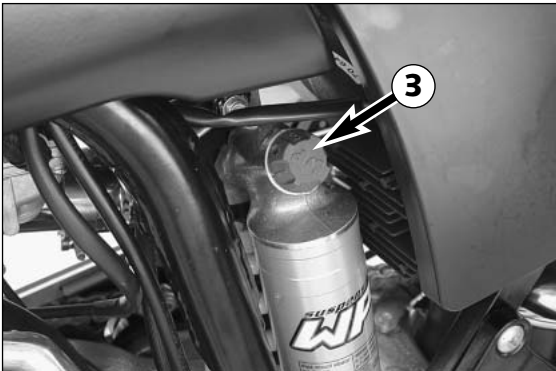

Compression damping of shock absorber

With the knob 3 the degree of damping of the compression can be adjusted to 7 positions. Turn the knob counterclockwise to increase damping, turn it clockwise to reduce damping during rcompressing.

STANDARD ADJUSTMENT:

WP 0118Y736 position 3

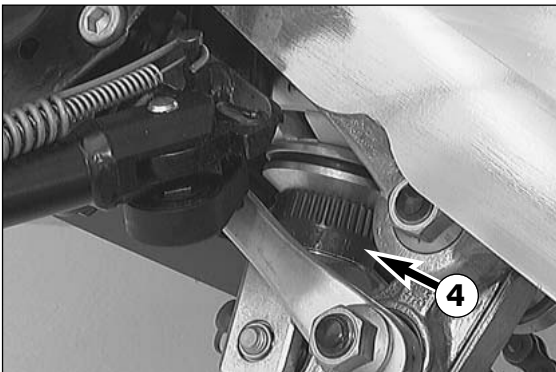

Rebound damping of shock absorber

With the setting wheel 4 the degree of damping of the rebound can be adjusted to 11 positions. Turn the knob to the left side to increase damping, turn it to the right side to reduce damping during rebounding.

STANDARD ADJUSTMENT:

WP 0118Y736 position 5

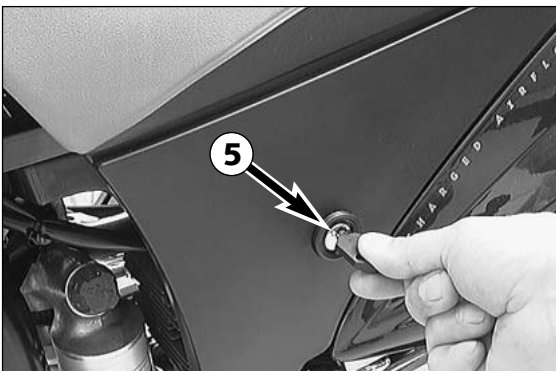

Seat lock

The seat is secured by the lock on the side of the seat 5

GENERAL TIPS AND WARNINGS FOR STARTING THE MOTORCYCLE

Instructions for initial operation

- Verify that your KTM dealer performed the PREPARATION OF VEHICLE jobs (see Customer Service Manual).
- Read the entire manual carefully before your first drive.
- Enter the chassis, engine and key numbers on page 1.
- Familiarize yourself with the operating elements.
- Adjust the foot brake pedal and the hand brake lever to the most comfortable positions for you.
- Get used to handling the motorcycle on an empty car park, before starting on a longer drive. Also try to drive as slowly as possible and in standing position, to improve your feeling for the vehicle.
- Hold the handlebar with both hands and leave your feet on the foot rests while driving.
- Remove your foot from the foot brake pedal when you are not braking. If the foot brake pedal is not released the brake pads rub continuously and the braking system is overheated.
- You may only be accompanied by a passenger if your motorcycle is fitted and registered for such purposes. The passenger must hold on to the supporting strap or the driver and keep his feet on the passenger footrests throughout the ride.
- Do not make any alterations to the motorcycle and always use ORIGINAL KTM SPARE PARTS. Spare parts from other manufacturers can impair the safety of the motorcycle.
- New tires have a smooth surface and must be run in. For this purpose, carefully ride the motorcycle at moderate speed, tilting the vehicle at different angles so that the surface is evenly roughened. Tires will not display their full grip characteristics before they are properly run in.
- Motorcycles are sensitive to alterations in the distribution of weight. If you are taking luggage with you, this should be secured as close as possible to the middle of the vehicle; distribute the weight evenly between the front and rear wheel. Never exceed the maximum permissible laden weight and the axle weights. The maximum permissible laden weight is made up of the following components:
 - Motorcycle ready for operation and tank full
 - Luggage
 - Driver and passenger with protective clothing and helmet.
- Pay attention to running in instructions.

Running in

Even finely machined surfaces of engine parts have rougher surfaces than parts that slide on each other for a long time. Therefore, every engine must be run in. For this reason, do not demand maximum performance from the engine for the first 1000 kilometers. The vehicle must be run in at low, changing performance level for the first 1000 KM (620 miles). The maximum number of revolutions per minute must not go exceed 4800 rpm. Once you have run your engine in for 1000 km (620 mi), you may push it to its 8500 rpm limit, i.e. up to the red zone indicated in the tachometer. Exceeding the above listed rotations as well as pushing high rpm when the engine is cold will have an adverse effect on the life of your engine.



WARNING



- WEAR SUITABLE CLOTHING WHEN DRIVING A MOTORCYCLE. CLEVER KTM DRIVERS ALWAYS WEAR A HELMET, BOOTS, GLOVES AND A JACKET, REGARDLESS OF WHETHER DRIVING ALL DAY OR JUST FOR A SHORT TRIP. THE PROTECTIVE CLOTHING SHOULD BE BRIGHTLY COLOURED SO THAT OTHER USERS OF THE ROADS CAN SEE YOU AS EARLY AS POSSIBLE. YOUR PASSENGER OF COURSE WILL ALSO NEED SUITABLE PROTECTIVE CLOTHING.
- ALWAYS TURN ON THE LIGHT TO MAKE SURE THAT OTHER DRIVERS BECOME AWARE OF YOU AS EARLY AS POSSIBLE.
- DO NOT DRIVE AFTER HAVING CONSUMED ALCOHOL.
- ONLY USE ACCESSORIES THAT HAVE BEEN RELEASED BY KTM. FOR EXAMPLE, FRONT PANNELLING CAN IMPAIR THE DRIVING PROPERTIES OF THE MOTORCYCLE. CASES, EXTRA TANKS ETC. CAN ALTER THE WEIGHT DISTRIBUTION AND THUS ALSO IMPAIR THE VEHICLE'S DRIVING PROPERTIES.
- THE FRONT AND REAR WHEEL ARE ONLY ALLOWED TO BE TIRED WITH TIRES THAT HAVE THE SAME PROFILE TYPE.
- OBSERVE THE TRAFFIC REGULATIONS, DRIVE DEFENSIVELY AND TRYING TO LOOK AHEAD AS FAR AS POSSIBLE SO THAT ANY HAZARDS CAN BE RECOGNIZED AS EARLY AS POSSIBLE.
- ADJUST YOUR DRIVING SPEED ACCORDING TO THE CONDITIONS AND YOUR DRIVING SKILLS.
- DRIVE CAREFULLY ON UNKNOWN ROADS
- REPLACE THE HELMET VISOR RESPECTIVELY GOGGLE GLASSES IN PLENTY OF TIME. WHEN LIGHT SHINES DIRECTLY ON SCRATCHED VISOR OR GOGGLES, YOU WILL BE PRACTICALLY BLIND.
- NEVER LEAVE YOUR MOTORCYCLE WITHOUT SUPERVISION AS LONG AS THE ENGINE IS RUNNING.

DRIVING INSTRUCTIONS



Check the following before each start

When you start off, the motorcycle must be in a perfect technical condition. For safety reasons, you should make a habit of performing an overall check of your motorcycle before each start.

The following checks should be performed:

- 1 CHECK THE OIL LEVEL**
Insufficient oil results in premature wear and consequently to engine damage.
 - 2 FUEL**
Check that there is sufficient fuel in the tank.
 - 3 CHAIN**
A loose chain can fall off; an extremely worn chain can tear, and insufficient lubrication can result in unnecessary wear to the chain and rear sprockets.
 - 4 TIRES**
Check for damaged tires. Tires showing cuts or dents must be replaced. The tread depth must comply with the legal regulations. Also check the air pressure. Insufficient tread and incorrect air pressure reduce the driving performance.
 - 5 BRAKES**
Check correct functioning of the braking system. Check for sufficient brake fluid in the reservoir. If the level of brake fluid falls below the minimum value, this indicates a leak in the braking system or completely worn out brake pads. Arrange for the braking system to be checked by a KTM specialist garage, as complete failure of the braking system can be expected.
Also check the state of the brake hoses and the thickness of the brake linings. Brake linings measured at their thinnest point should not be less than 1 mm since extremely worn linings can lead to brake failure.
-
- ⚠ WARNING ⚠**
-
- IF THE RESISTANCE IN THE HAND BRAKE LEVER OR FOOT BRAKE PEDAL FEELS "SPONGY" (NOT ENOUGH RESISTANCE), THIS IS AN INDICATION THAT SOMETHING IS WRONG WITH THE BRAKE SYSTEM. DON'T RIDE YOUR MOTORCYCLE ANYMORE WITHOUT FIRST HAVING THE BRAKE SYSTEM LOOKED OVER BY A KTM DEALER.
- 6 CABLES**
Check correct setting and easy running of all control cables.
 - 7 COOLING LIQUID**
Check the level of cooling liquid when the engine is cold.
 - 8 ELECTRICAL SYSTEM**
Check correct functioning of headlamps, parking light, tail-light, brake light, flashers, indicator lamps and horn while the engine is running.
 - 9 LUGGAGE**
If you are taking luggage with you, check that this is securely fastened.

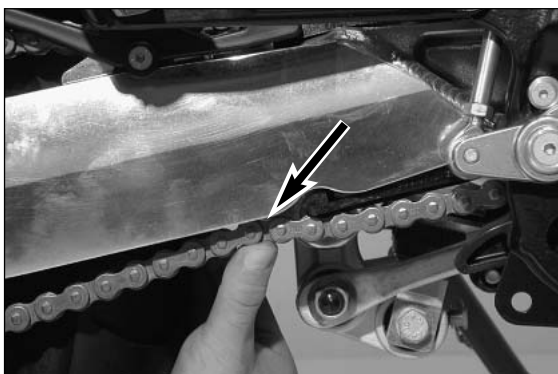

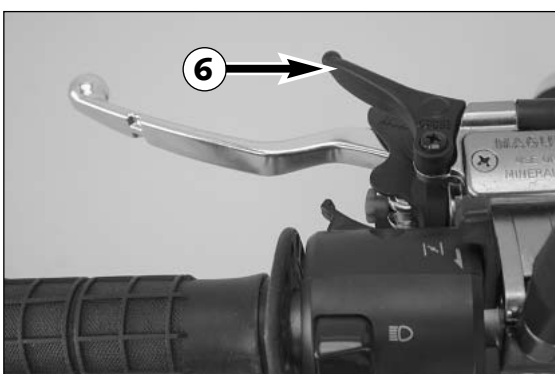
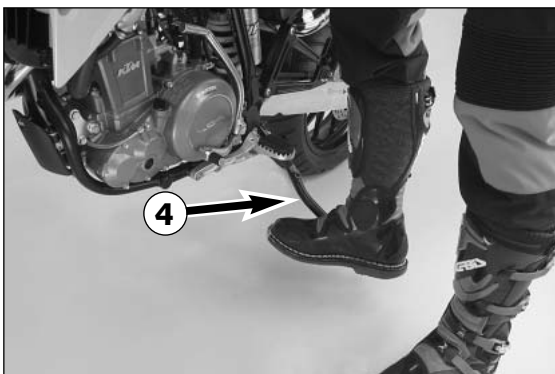
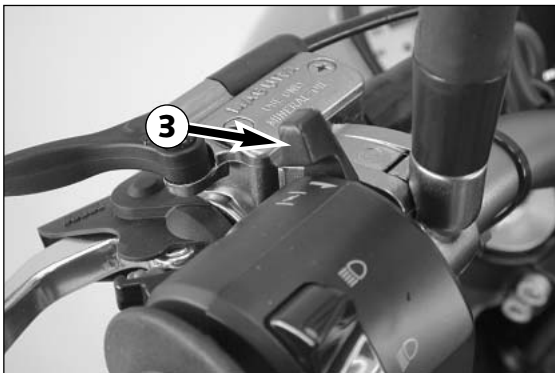
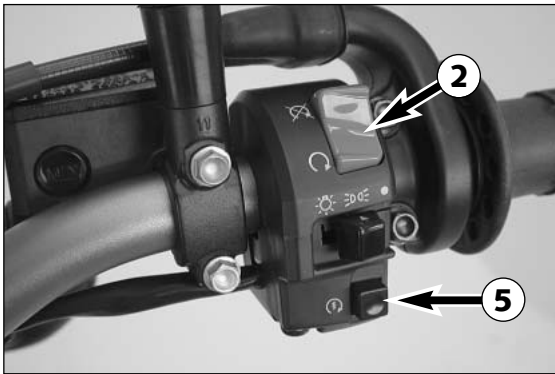
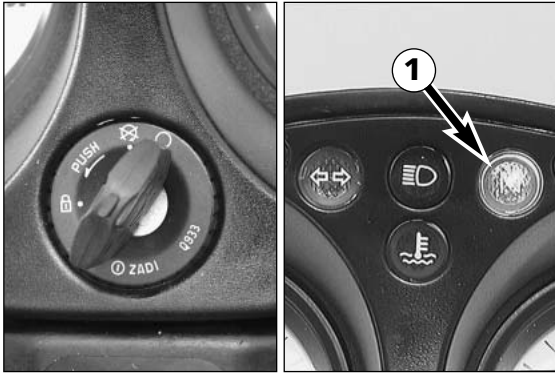

Starting when the engine is cold

- 1 Open the fuel tap.
- 2 Turn on the ignition.
- 3 Switch the gear to neutral (green lamp ① lights).
- 4 Turn on the emergency OFF switch ②.
- 5 Operate the choke lever ⑥.
- 6 Operate the starter button ⑤ without accelerating.
- 7 If the engine starts, push the choke lever back a little bit, as soon as the engine runs unevenly.
- 8 Swing up the sidestand ④.
- 9 Switch on the light before setting off.

⚠ **WARNING** ⚠

DO NOT START THE ENGINE AND ALLOW IT TO IDLE IN A CLOSED ROOM. EXHAUST FUMES ARE POISONOUS AND CAN CAUSE LOSS OF CONSCIOUSNESS AND DEATH. ALWAYS PROVIDE ADEQUATE VENTILATION WHILE THE ENGINE IS RUNNING.

! **CAUTION** !

- MAXIMUM PERIOD FOR CONTINUOUS STARTING: 5 SECONDS. WAIT AT LEAST 5 SECONDS BEFORE TRYING AGAIN.
- DON'T RIDE YOUR MOTORCYCLE WITH FULL LOAD AND DON'T REV ENGINE WHEN COLD. BECAUSE THE PISTON IS WARMING UP FASTER THAN THE WATER COOLED CYLINDER, IT CAN CAUSE ENGINE DAMAGE. ALWAYS KEEP IN MIND THAT THE ENGINE SHOULD BE WARMED UP WITH SMALL LOAD AT MEDIUM R.P.M.

IF THE ENGINE DOES NOT CRANK WHEN YOU ACTUATE THE STARTER TIP SWITCH:

- Check if the ignition is on
- whether the emergency OFF switch
- Check if the emergency off switch is on
- the headlight is on.
- If this is not the case, the battery is discharged
- If the lights are on, proceed as described in the „Trouble-shooting“ section or contact a KTM dealer.

⚠ **WARNING** ⚠

WHEN STARTING THE ENGINE, PUT ON MOTORCYCLE BOOTS IN ORDER TO AVOID INJURIES. YOU MAY SLIP OFF THE KICKSTARTER, OR THE ENGINE MAY STRIKE BACK WHEN KICKING NOT VEHEMENTLY ENOUGH.

IF THE ENGINE CRANKS BUT DOES NOT START, WHEN YOU ACTUATE THE STARTER TIP SWITCH:

- Check if the fuel tap is open
- Check if the choke lever has been operated
- Check if sufficient fuel is in the tank
- If this is not the case, refill the tank
- if sufficient fuel is in the tank, proceed as described in the „Trouble-shooting“ section or contact a KTM dealer.

THE ELECTRIC STARTER DOESN'T CRANK THE ENGINE WHEN THE STARTER TIP SWITCH IS OPERATED EVEN THOUGH SUFFICIENT ELECTRIC CURRENT IS AVAILABLE:

- Pull the hand decompression lever ③, start and release the lever.

NOTE:

This motorcycle is equipped with a safety starter system. The engine can only be started when the transmission is switched to idle or the clutch lever is pulled, respectively.

Motorcycles with side stands are also equipped with a safety starting system.

If you put in a gear with the side stand in its swung-out position, and if you let go of the clutch lever, the engine will stop.

Starting when the engine is warm

- 1 Open the fuel tap.
- 2 Turn on the ignition.
- 3 Switch the gear to neutral (green lamp ① lights).
- 4 Turn on the emergency OFF switch ②.
- 5 Operate the starter button ⑤ without accelerating.
- 6 Swing up the sidestand ④.
- 7 Switch on the light before setting off.

What to do when the engine is „flooded“

The throttle must be fully opened when starting. If necessary change spark plug.

Kickstart instructions

Be sure to kick up the side stand before you start the engine to avoid any damage. Start as described above, then push the kickstarter hard all the way.

⚠ **WARNING** ⚠

- IF YOU WANT TO START THE ENGINE, MAKE SURE THAT YOU ALWAYS PUT ON STURDY MOTORCYCLE BOOTS IN ORDER TO AVOID INJURIES. YOU MIGHT SLIP OFF THE KICKSTARTER, OR THE ENGINE MAY KICK BACK AND PROPEL YOUR FOOT UPWARD WITH GREAT VEHEMENCE.
- ALWAYS KICK KICKSTARTER BRISKLY ALL THE WAY WITHOUT OPENING THE THROTTLE. KICKING THE KICKSTARTER WITH NOT ENOUGH MOMENTUM, AND AN OPENED THROTTLE GRIP INCREASE THE KICK-BACK HAZARD.

Starting off

Pull the clutch lever. Put the engine into first gear, slowly release the clutch lever and open throttle at the same time.

⚠ **WARNING** ⚠

BEFORE YOU START OFF, CHECK THAT THE SIDE STAND HAS BEEN SWUNG RIGHT UP TO THE TOP. IF THE STAND DRAGS ON THE GROUND, THE MOTORCYCLE CAN GO OUT OF CONTROL.



Shifting/Riding

You are now in first gear, referred to as the drive or uphill gear. Depending on the conditions (traffic, road gradient, etc.), you can shift to a higher gear. Close throttle, at the same time pull clutch lever and shift to the next higher gear. Let clutch lever go again and open throttle. If you turned on the choke, make sure you turn it off again as soon as engine is warm.

When you reach full speed through turning the throttle grip all the way, turn throttle back to 3/4; the speed hardly decreases although the engine will use less gas. Never open the throttle wider than the engine can handle. Excessive turning of the throttle grip will increase full consumption.

By shifting down, use the brakes if necessary and close throttle at the same time. Pull clutch lever and shift down to the next gear. Let clutch lever go slowly and open throttle or shift down again.

If the engine is killed f.ex. at a crossing, simply pull the clutch lever and start. It is not necessary to switch the gear to NEUTRAL.

⚠ **WARNING** ⚠

- AVOID ABRUPT LOAD CYCLES IN CURVES AND ON WET OR SLIPPERY ROADS. OTHERWISE, THE MOTORCYCLE COULD EASILY GET OUT OF CONTROL.
- NEVER TURN THE IGNITION KEY TO POSITION OR WHILE THE MOTORCYCLE IS MOVING.
- AFTER FALLING WITH THE MOTORCYCLE, CHECK ALL FUNCTIONS THOROUGHLY BEFORE STARTING UP OPERATIONS AGAIN.
- A BENT HANDLEBAR MUST ALWAYS BE REPLACED. NEVER TRY TO STRAIGHTEN THE HANDLEBAR BECAUSE THIS WILL CAUSE IT TO LOSE ITS STABILITY.

! **CAUTION** !

- HIGH RPM RATES WHEN THE ENGINE IS COLD HAVE AN ADVERSE EFFECT ON THE LIFE OF YOUR ENGINE. WE RECOMMEND YOU RUN THE ENGINE IN A MODERATE RPM RANGE FOR A FEW MILES GIVING IT A CHANCE TO WARM UP. AFTER THAT NO FURTHER PRECAUTIONS IN THIS RESPECT NEED BE TAKEN.
- SHIFT TO THE NEXT HIGHER GEAR BY 8500 RPM AT THE LATEST. ENGINE SPEEDS IN THE RED RANGE MUST STRICTLY BE AVOIDED.
- NEVER HAVE THE THROTTLE WIDE OPEN WHEN CHANGING DOWN TO A LOWER GEAR. THE ENGINE WILL OVERSPEED, DAMAGING THE VALVES. IN ADDITION, THE REAR WHEEL BLOCKS SO THAT THE MOTORCYCLE CAN EASILY GET OUT OF CONTROL.
- LONG WHEELIE DRIVING CAUSES THE OIL PRESSURE TO DROP. THE OIL PRESSURE WILL AUTOMATICALLY INCREASE AS SOON AS YOU DRIVE ON NORMALLY. DOING WHEELIES FOR A LONG TIME WILL DAMAGE YOUR ENGINE.
- IF THE RED COOLING LIQUID TEMPERATURE LAMP LIGHTS UP WHILE YOU ARE DRIVING, THIS INDICATES COOLING SYSTEM TROUBLE. IMMEDIATELY STOP AND TURN OFF THE ENGINE. DRIVING WITH THE WARNING LAMP ON WILL CAUSE ENGINE DAMAGE.
 - PLACE A CLOTH ON THE RADIATOR CAP. OPEN THE CAP SLOWLY, SO THE EXCESS PRESSURE IN THE COOLING SYSTEM CAN ESCAPE. - **CAUTION SCALDING HAZARD!** - AND CHECK THE COOLING LIQUID LEVEL.
 - DO NOT DRIVE ON, UNTIL THERE IS SUFFICIENT LIQUID IN THE COOLING SYSTEM. HOWEVER, CALL ON ONE OF KTM'S DEALERS AS SOON AS POSSIBLE IN ORDER TO HAVE THE DEFECT REMEDIED.
- IF ANY ABNORMAL VIBRATIONS OCCUR WHILE DRIVING, CHECK THAT THE ENGINE FASTENING SCREWS ARE TIGHT.
- IN THE EVENT THAT, WHILE RIDING YOUR MOTORCYCLE, YOU NOTICE ANY UNUSUAL OPERATION-RELATED NOISE, STOP IMMEDIATELY, TURN THE ENGINE OFF, AND CONTACT AN AUTHORIZED KTM DEALER.

Braking

Close throttle and apply the hand and foot brakes at the same time. When driving on sandy, wet or slippery ground use mainly the rear wheel brake. Always brake with feeling, blocking wheels can cause you to skid or fall. Also change down to lower gears depending on your speed.

When driving downhill, use the braking effect of the engine. Change down one or two gears but do not overspeed the engine. In this way, you will not need to brake so much and the brakes will not overheat.

⚠ **WARNING** ⚠

- DELAYED BRAKE ACTION MUST BE EXPECTED DUE TO WET BRAKE DISKS DURING RAINY WEATHER OR AFTER CLEANING OF THE MOTORCYCLE. IN THIS CASE, REPEATEDLY APPLY THE BRAKES UNTIL THEY ARE DRY.
- DELAYED BRAKE ACTION CAN ALSO OCCUR ON SALTED OR DIRTY ROADS. IN THIS CASE, REPEATEDLY APPLY THE BRAKES TO REMOVE THE DIRT.
- WHEN YOU BRAKE, THE BRAKE DISCS, BRAKE PADS, BRAKE CALIPER AND BRAKE FLUID HEAT UP. THE HOTTER THESE PARTS GET, THE WEAKER THE BRAKING EFFECT. IN EXTREME CASES, THE ENTIRE BRAKING SYSTEM CAN FAIL.
- DIRTY BRAKE DISCS CAUSE INCREASED TEAR OF BRAKE PADS AND BRAKE DISCS.
- IF THE RESISTANCE IN THE HAND BRAKE LEVER OR FOOT BRAKE PEDAL FEELS "SPONGY" (TOO MUCH PLAY), THIS IS AN INDICATION THAT SOMETHING IS WRONG WITH THE BRAKE SYSTEM. DON'T RIDE YOUR MOTORCYCLE ANYMORE WITHOUT FIRST HAVING THE BRAKE SYSTEM LOOKED OVER BY A KTM DEALER.

Stopping and parking

Apply the brakes fully and put the engine into neutral. To stop the engine, switch off the ignition. Close fuel tap. Park on solid ground and lock the vehicle.



WARNING



- MOTORCYCLE ENGINES PRODUCE A GREAT AMOUNT OF HEAT WHILE RUNNING. THE ENGINE RADIATORS, EXHAUST, EXHAUST SYSTEM, BRAKE DISCS, AND SHOCK ABSORBERS CAN BECOME VERY HOT. DO NOT TOUCH ANY OF THESE PARTS AFTER OPERATING THE MOTORCYCLE, AND TAKE CARE TO PARK IT WHERE PEDESTRIANS ARE NOT LIKELY TO TOUCH IT AND GET BURNED.
- NEVER PARK YOUR MOTORCYCLE IN PLACES WHERE THERE EXIST FIRE HAZARDS DUE TO DRY GRASS OR OTHER EASILY FLAMMABLE MATERIALS.



CAUTION



- PARK YOUR MOTORCYCLE, SO THAT IT RESTS STABLY ON THE SIDESTAND (HARD GROUND, LEVEL SURFACE) AND CAN'T TIP OVER.
- CLOSE THE FUEL TAP WHEN LEAVING YOUR VEHICLE. OTHERWISE THE CARBURETOR CAN OVERFLOW AND FUEL WILL ENTER THE ENGINE.
- ALWAYS TAKE OUT THE IGNITION KEY WHEN PARKING YOUR MOTORCYCLE SO THAT IT CANNOT BE USED BY UNAUTHORIZED PERSONS.



NOTE REGARDING THE SIDE STAND:

Use your foot to kick side stand forward up to the stop and lean the motorcycle sideways. Make sure that the ground is solid and that your motorcycle is standing securely. Just in case, you can shift into first gear.



CAUTION



THE SIDE STAND IS DESIGNED TO BEAR ONLY THE LOAD OF THE MOTORCYCLE. THE SIDE STAND AND/OR THE FRAME CAN BE DAMAGED AND THE MOTORCYCLE CAN FALL OVER IF YOU MOUNT THE MOTORCYCLE, THUS PUTTING AN ADDITIONAL LOAD ON THE SIDE STAND.

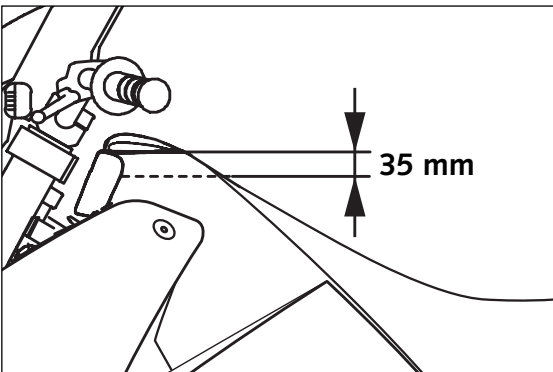

Refueling

In the condition at delivery, the LC4 engine requires leaded or unleaded premium-grade fuel with at least 95 octane (ROZ) (USA=Premium RON 91). If this type of fuel is not available it is easy to change over to the pre-programmed ignition curve for 80 - 94 octane (ROZ) (see activating the ignition curve for low-octane fuel).



CAUTION



USE LEADED OR UNLEADED PREMIUM-GRADE 95 OCTANE (ROZ) FUEL. IF USING LOWER OCTANE FUEL, THE IGNITION CURVE MUST BE CHANGED, OTHERWISE ENGINE DAMAGE WILL OCCUR.



WARNING



GASOLINE IS HIGHLY FLAMMABLE AND POISONOUS. EXTREME CAUTION SHOULD BE USED WHEN HANDLING GASOLINE. DO NOT REFUEL THE MOTORCYCLE NEAR OPEN FLAMES OR BURNING CIGARETTES. ALWAYS SWITCH OFF THE ENGINE BEFORE REFUELLING. BE CAREFUL NOT TO SPILL GASOLINE ON THE ENGINE OR EXHAUST PIPE WHILE THE ENGINE IS HOT. WIPE UP SPILLS PROMPTLY. IF GASOLINE IS SWALLOWED OR SPLASHED IN THE EYES, SEEK A DOCTOR'S ADVICE IMMEDIATELY.

Fuel expands when its temperature rises. Therefore do not fill the tank to the top (see fig.).

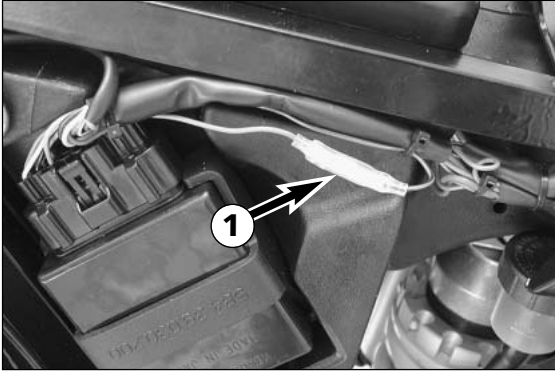

Activating the ignition curve for low-octane fuel

If you are traveling to a country where fuel having at least 95 octane (ROZ) is not available, you can easily activate the corresponding ignition curve. A plug and socket connection ❶ on a brown/black cable is located on the right side of the vehicle next to the CDI box .

If the two connectors are connected to each other, the ignition curve for fuel having at least 95 octane (ROZ) is activated.

If you disconnect the plug and socket connection, the ignition curve for fuel having 80 - 94 octane (ROZ) is activated. Although this causes the engine to lose some of its power output, it prevents poor glow ignitions and engine damage.

!

CAUTION

!

IF FUEL HAVING AT LEAST 95 OCTANE (ROZ) IS NOT AVAILABLE, THE IGNITION CURVE FOR 80 - 94 OCTANE (ROZ) MUST BE ACTIVATED TO PREVENT ENGINE DAMAGE.



PERIODIC MAINTENANCE SCHEDULE

640 Duke II

A washed motorcycle can be checked more quickly which saves money!

1st Service after 1000 km

2nd Service after 5000 km, then every 5000 km or once a year

		1st Service after 1000 km	2nd Service after 5000 km, then every 5000 km or once a year
ENGINE	Change engine oil, oil filters, and fine filter	●	●
	Clean oil screens and magnet of drain plug	●	●
	Check oil lines for damage and kink-less arrangement	●	●
	Check and adjust spark plug, replace it every 10,000 km		●
	Check and adjust valve clearance	●	●
	Check engine fastening screws for tight fit	●	●
CARBURETOR	Check carburetor connection boots for cracks and leaks		●
	Check idle setting	●	●
	Check bleeder hoses for damage and kink-free arrangement	●	●
ADD-ON-PARTS	Check cooling system for leaks, antifreeze protection	●	●
	Check radiator fan for proper function		●
	Check exhaust system for leaks and suspension	●	●
	Check actuating cables for damage, smooth operation, and kink-less arrangement, adjust and lubricate	●	●
	Check fluid level of the clutch master cylinder	●	●
	Clean air filter and air filter box		●
	Check cables for damage and kink-less arrangement		●
	Check headlamp adjustment		●
	Check electrical system for function (low/high beams, stop light, turn indicators, headlamp flasher, tell-tale lamps, speedometer illumination, horn, side-stand switch, clutch switch, emergency-off switch)	●	●
BRAKES	Check brake fluid level, lining thickness, and brake discs	●	●
	Check brake lines for damage and leaks	●	●
	Check/adjust smooth operation, free travel of handbrake/foot brake levers		●
	Check screws of brake system for tight fit	●	●
CHASSIS	Check suspension strut and fork for leaks and proper function	●	●
	Check O-ring of suspension strut for wear		●
	Clean dust sleeves		●
	Bleed fork legs	●	●
	Check swinging-fork pivot	●	●
	Check/adjust steering-head bearing	●	●
	Service eccentric for chain tension		●
	Lubricate reversing lever		●
Check all chassis screws for tight fit (fork plates, fork leg, axle nuts/screws, swinging-fork pivot, reversing lever, suspension strut)	●	●	
WHEELS	Check tire condition, inflation pressure, and rim condition	●	●
	Check chain, chain wheels, chain wheel guides for wear, tight fit, and tension	●	●
	Lubricate chain	●	●
	Check wheel bearings and jerk damper for play		●

IMPORTANT RECOMMENDED MAINTENANCE PROCEDURES TO BE PERFORMED BASED ON A SEPARATE SUPPLEMENTARY ORDER

	at least once a year	every 2 years or 20000 km
Perform complete fork maintenance	●	
Perform complete suspension strut maintenance		●
Perform complete reversing lever maintenance		●
Replace glass-fiber yarn packing of the silencers		●
Clean and lubricate steering-head bearing and sealing elements	●	
Clean and adjust the carburetor	●	
Treat the electrical contacts and switches with contact spray	●	
Treat battery connections with contact grease	●	
Change the brake fluid	●	

IF MOTORCYCLE IS USED FOR COMPETITION 5000 KM SERVICE SHOULD BE CARRIED OUT AFTER EVERY RACE!
SERVICE INTERVALLS SHOULD NEVER BE EXCEED BY MORE THAN 500 KM!
 MAINTENANCE WORK DONE BY KTM AUTHORISED WORKSHOPS IS NOT A SUBSTITUTE OF CARE AND CHECKS DONE BY THE RIDER!

VITAL CHECKS AND CARE PROCEDURES TO BE CONDUCTED BY THE OWNER OR THE MECHANIC

	before each start	after every cleaning	once a year
Check oil level	●		
Check brake fluid level	●		
Check brake pads for wear	●		
Check lighting system for proper operation	●		
Check horn for proper operation	●		
Lubricate and adjust actuating cables and nipples		●	
Bleed fork legs in regular intervals			●
Remove and clean fork dust sleeves in regular intervals			●
Clean and lubricate chain as necessary		●	
Check chain tension	●	●	
Clean air filter and filter box			●
Check tire pressure and wear	●		
Check coolant level	●		
Check fuel lines for leaks	●		
Drain float chamber		●	
Check all control elements for smooth running.	●		
Check brake performance	●	●	
Treat exposed metal components (except for the braking and exhaust systems) with wax-based anti-corrosion agents		●	
Treat ignition/steering lock and light switch with contact spray		●	
Check all bolts, nuts, and hose clamps for their tight fit			●

MAINTENANCE WORK ON CHASSIS AND ENGINE



WARNING



MAINTENANCE AND ADJUSTING WORK MARKED WITH AN ASTERISK (*) REQUIRES EXPERT SKILLS AND TECHNICAL KNOW-HOW. FOR YOUR OWN SAFETY, ALWAYS HAVE SUCH WORK PERFORMED BY A SPECIALIZED KTM DEALER WHERE YOUR MOTORCYCLE WILL BE OPTIMALLY SERVICED BY APPROPRIATELY QUALIFIED SKILLED STAFF.



CAUTION



- WHEN CLEANING THE MOTORCYCLE, DO NOT USE A HIGH PRESSURE CLEANING UNIT IF POSSIBLE, OTHERWISE WATER WILL PENETRATE THE BEARINGS, CARBURETOR, ELECTRIC CONNECTORS ETC.
- WHEN TRANSPORTING YOUR KTM, ENSURE THAT IT IS HELD UPRIGHT WITH RESTRAINING STRAPS OR OTHER MECHANICAL FASTENING DEVICES. IF THE MOTORCYCLE SHOULD FALL OVER, FUEL CAN LEAK FROM THE CARBURETOR OR FUEL TANK
- DO NOT USE TOOTHED WASHERS OR SPRING WASHERS WITH THE ENGINE FASTENING SCREWS, AS THESE WORK INTO THE FRAME PARTS AND KEEP WORKING LOOSE. INSTEAD, USE SELF-LOCKING NUTS.
- LET YOUR MOTORCYCLE COOL DOWN BEFORE BEGINNING ANY MAINTENANCE WORK IN ORDER TO AVOID GETTING BURNED.
- PROPERLY DISPOSE OF OIL, GREASE, FILTERS, FUEL, CLEANSERS, BRAKE FLUID, COOLING LIQUID, ETC. OBSERVE THE REGULATIONS EFFECTIVE IN YOUR COUNTRY. ALSO OBSERVE THE SAFETY REGULATIONS WHEN HANDLING THESE SUBSTANCES.
- UNDER NO CIRCUMSTANCES MAY USED OIL BE DISPOSED OF IN THE SEWAGE SYSTEM OR IN THE OPEN COUNTRYSIDE. 1 LITER USED OIL CONTAMINATES 1,000.000 LITERS WATER.
- IF YOU UNFASTEN SELF-LOCKING NUTS, YOU HAVE TO REPLACE THEM BY NEW ONES.
- IF YOU UNFASTEN SCREWS AND NUTS SECURED BY LOCTITE, YOU HAVE TO REATTACH AND SECURE THEM IN THE SAME WAY. SEE TECHNICAL SPECIFICATIONS - FASTENING TORQUES ON PAGE 41.

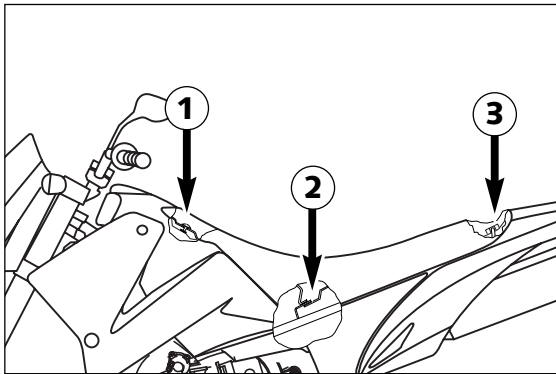

Removing the seat

Put the ignition key into the lock. Turn it counter clockwise all the way to the stop to unlock the seat.

Lift the rear portion of the seat, pull it backwards and disengage it from the oval head screw ①.

The tool set, the battery and the main fuse are located below the seat. Additionally, there is a compartment where small items can be stored.

FIXING THE SEAT:

Hook the seat onto the oval head screw ①.

Push the seat forward, at the same time depressing the middle section so that the retaining bracket ② engages at the seat.

Depress the rear portion of the seat until the locking bolt ③ engages.

Take out the key.



WARNING



CHECK IF THE LOCKING BOLT IS PROPERLY ENGAGED. THE REAR PORTION OF THE SEAT MUST BE FIXED SO THAT IT CAN'T BE LIFTED. IF THE SEAT IS LOOSE, THE MOTORBIKE CAN EASILY GET OUT OF CONTROL.

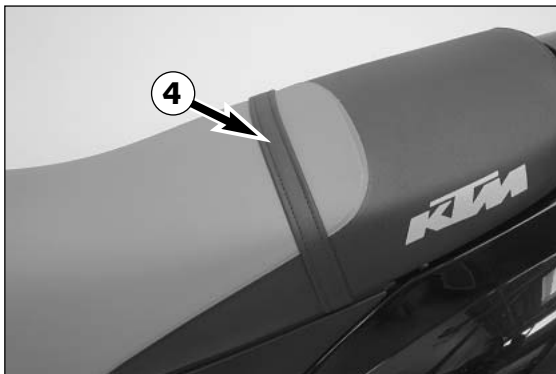

Supporting strap for the passenger

The passenger can hold on to the supporting strap ④ on the seat.

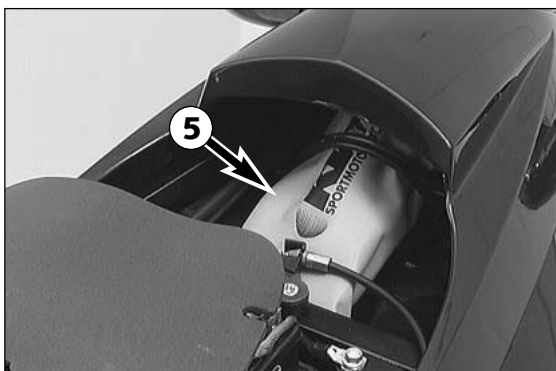

Tool kit

The tool kit ⑤ is stored below the seat.

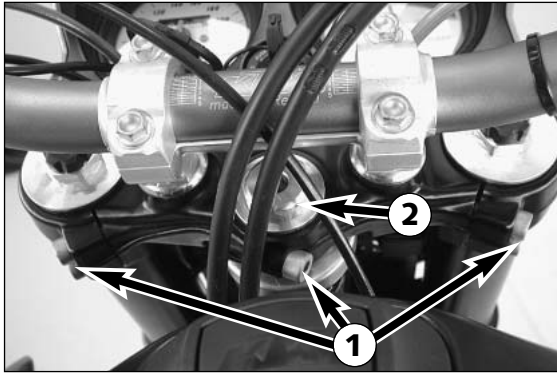

Checking and adjusting the steering head bearing*

Check steering head bearing for play periodically. To check this, put motorcycle on stand so that the front wheel is off the ground. Now try to move the fork forward and backward - no play should be discernable. To adjust, loosen the five clamp screws ❶ of the top triple clamp and turn steering stem bolt clockwise ❷ until there is no more play. Don't tighten the steering stem bolt all the way, otherwise the bearings will be damaged. With a plastic hammer, lightly tap on the top triple clamp to release tension. Re-tight the five clamp screws to 15 Nm (11 ft.lb).



WARNING



IF THE STEERING HEAD BEARING IS NOT ADJUSTED TO BE FREE OF PLAY, THE MOTORCYCLE WILL SHOW AN UNSTEADY DRIVING PERFORMANCE AND CAN GET OUT OF CONTROL.



CAUTION



IF YOU DRIVE WITH PLAY IN THE STEERING HEAD BEARING FOR LONGER PERIODS, FIRSTLY THE BEARINGS AND THEN THE BEARING SEATS IN THE FRAME WILL BE DESTROYED.

At least once a year, the steering head bearings should be greased. (e.g. Motorex Long Therm 2000)

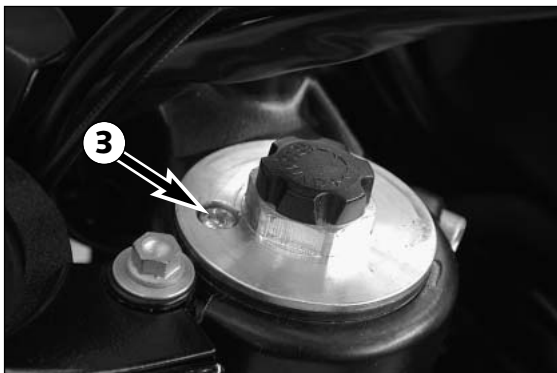
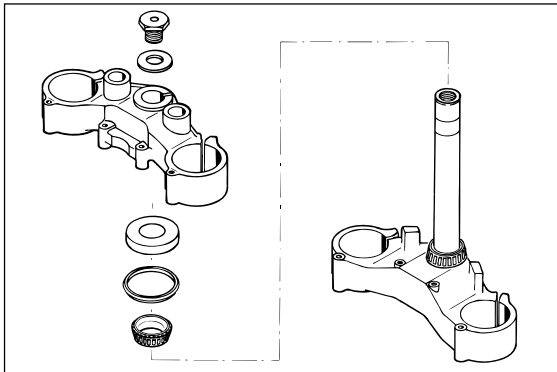

Bleeder screw front fork

The bleeder screws ❸ should now and then be released a few turns to let overpressure, if any, escape from the interior of the fork. To do this, place the motorcycle on a stand with the front wheel lifted off the ground. When riding the motorcycle mainly on street, it will be enough to have this job performed in the course of the periodical maintenance service.



CAUTION



EXCESSIVE PRESSURE IN THE INTERIOR OF THE FORK CAN CAUSE LEAKS IN THE FORK. IF YOUR FORK IS LEAKING, IT IS RECOMMENDED TO OPEN THE BLEEDER SCREWS BEFORE HAVING THE SEALS REPLACED.



Cleaning the dust sleeves of the telescopic fork

The dust-protection bellows ❹ are to remove dust and coarse dirt particles from the fork tube. However, after some time, dirt may also get in behind the dust-protection bellows. If this dirt is not removed, the oil sealing rings located behind it may start to leak.

Use a screwdriver to lever the dust-protection bellows out of the outer tubes and slide them downward.



Clean dust-protection bellows, outer tubes, and fork tubes thoroughly, and oil them thoroughly with silicone spray or engine oil. Then, push dust-protection bellows into the outer tubes by hand.



WARNING



NO SILICONE OIL MAY REACH THE FRONT TIRE OR THE BRAKE DISKS SINCE THIS WOULD CONSIDERABLY REDUCE THE TIRE'S ROAD GRIP AND THE BRAKING EFFECT OF THE FRONT BRAKE.

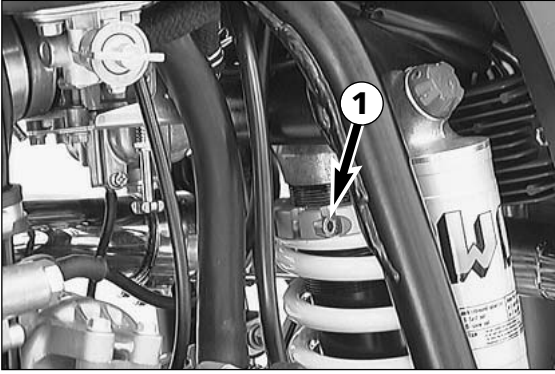

Changing the spring preload of the shock absorber

KTM sets the shock absorber for a driver only, weighing approximately 75 kg (165 lb). If you want to take a passenger with you, or if you weigh considerably more or less than 75 kg (165 lb), you should change the spring preload accordingly. This is easily done.

NOTE:

- Before changing the spring preload note down the basic setting, e.g. how many threads are visible above the adjusting ring.
- One rotation of the adjusting ring ② changes the spring preload by approximately 2 mm.

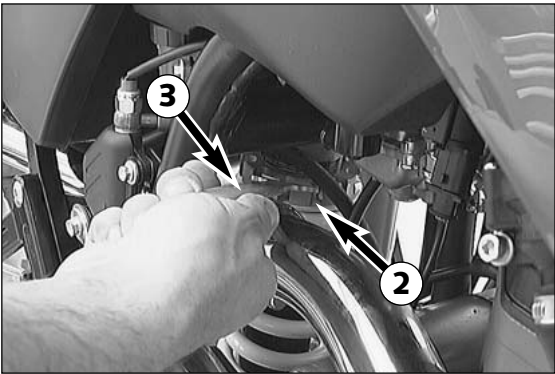

Loosen the allen head screw ① at the adjustment ring ②. Use the special wrench ③ from the tool set to turn the adjusting ring as required. Place the adjusting ring in a suitable position, and tighten the allen head screw with 8 Nm (6 ft.lb).

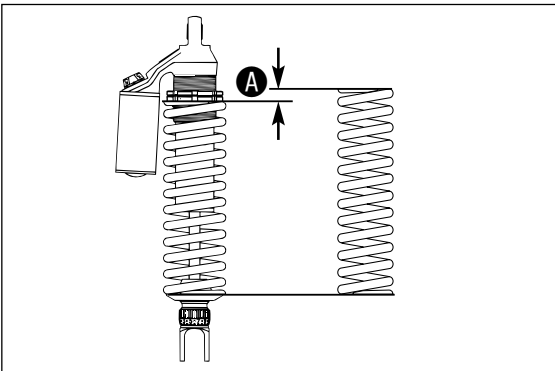

ADJUSTMENT VALUES - SPRING PRELOAD:

Minimum preload.....	10 mm
Preload driver only 75 kg BASIC SETTING	23 mm
Preload with passenger.....	28 mm

Ⓐ = spring preload

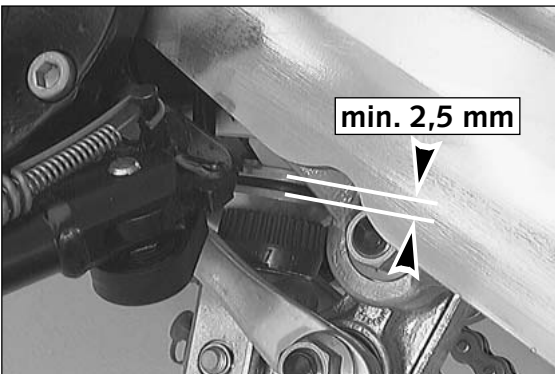

Checking the rubber ring of the rear shock absorber

A rubber ring mounted on the rear shock absorber serves as a vibration damper. This ring gets pressed together with time and loses its shock absorbing quality.

Measure the distance between the two discs at various points around their circumferences. The space should be at least 2.5 mm wide. Have the rubber ring replaced in a KTM garage when compaction due to wear has exceeded the limit.

! CAUTION !

NOT REPLACING THE RUBBER RING IN TIME CAN RESULT IN DAMAGE TO THE SHOCK ABSORBER.

⚠ WARNING ⚠

THE DAMPING UNIT OF THE SHOCK ABSORBER IS FILLED WITH HIGHLY COMPRESSED NITROGEN. NEVER TRY TO TAKE THE SHOCK ABSORBER APART OR TO DO ANY MAINTENANCE WORK YOURSELF. SEVERE INJURIES COULD BE THE RESULT.

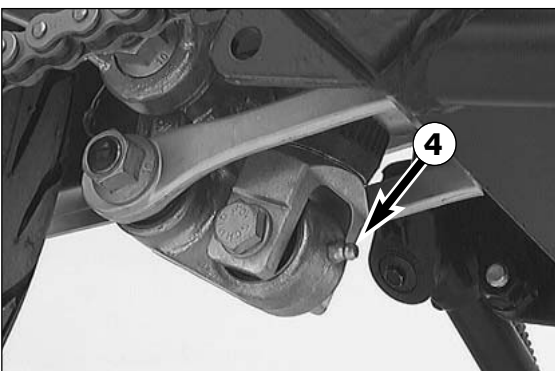

Lubricating the shock absorber linkage

The bearings in the rocker arm must be greased in regular intervals. For this purpose, a grease nipple ④ is mounted on the rocker arm.

! CAUTION !

AFTER EACH TIME THE MOTORCYCLE IS WASHED, IT IS ESPECIALLY IMPORTANT TO GREASE THE GREASE NIPPLE TO PUSH ANY WATER OUT OF THE BEARINGS.

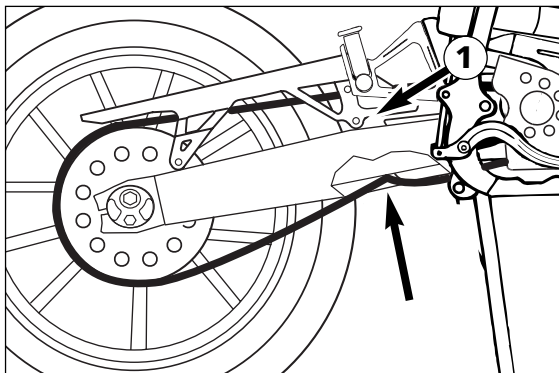

Checking chain tension

To check chain tension, turn off the engine and shift into neutral. Chain tension is correct when the chain can just barely be pushed up to touch the swingarm at the level of the screw ❶ (see illustration). If necessary, correct chain tension.

-
- ⚠ WARNING ⚠**
- If CHAIN TENSION IS TOO GREAT, PARTS WITHIN THE SECONDARY POWER TRANSMISSION (CHAIN, CHAIN SPROCKETS, TRANSMISSION AND REAR WHEEL BEARINGS) WILL BE SUBJECTED TO UNNECESSARY STRESS, RESULTING IN PREMATURE WEAR AND EVEN CHAIN BREAKAGE.
 - TOO MUCH SLACK IN THE CHAIN, ON THE OTHER HAND, CAN RESULT IN THE CHAIN JUMPING OFF THE CHAIN WHEELS. IF THIS HAPPENS, THE CHAIN COULD ALSO BLOCK THE REAR WHEEL OR DAMAGE THE ENGINE.
 - IN EITHER CASE THE OPERATOR IS LIKELY TO LOSE CONTROL OF THE MOTORCYCLE.

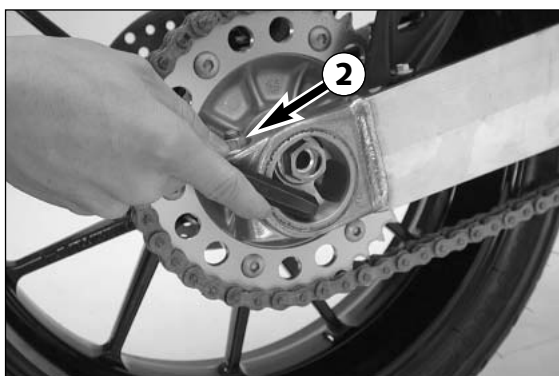

Correcting chain tension

Loosen hexagon nuts ❷ on the left and right swingarm fists. Loosen allen head screw ❸. Insert the hexagon socket wrench that comes with the tool set into the hexagon socket of the eccentric and rotate the eccentric upwards (i.e. the wheel spindle must move upwards).

-
- ! CAUTION !**
- IF THE WHEEL SPINDLE BECOMES LOOSE DURING THE PROCESS, RETURN ECCENTRICS TO THEIR ORIGINAL POSITION BEFORE RETIGHTENING THE WHEEL SPINDEL (SEE MAINTAINING ECCENTRICS)
- Tighten hexagon nuts on swing arm fists to 40 Nm (30 ft.lb).
Tighten allen head screw ❸ to 40 Nm (30 ft.lb).

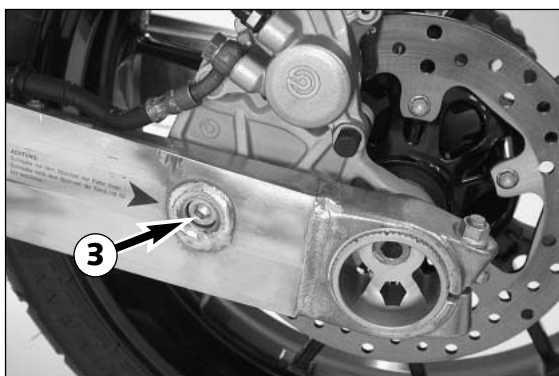

-
- ⚠ WARNING ⚠**
- DO NOT ROTATE THE ECCENTRIC DOWNWARDS (I.E. THE WHEEL SPINDLE MOVES DOWNWARDS). THIS WILL RAISE THE TAIL OF THE MOTORCYCLE AND WORSEN THE MOTORCYCLE'S PERFORMANCE ON THE STRAIGHTAWAY.
 - IF YOU DON'T HAPPEN TO HAVE A TORQUE WRENCH AT HAND, MAKE SURE YOU HAVE THE TIGHTENING TORQUE CORRECTED BY A KTM DEALER AS SOON AS POSSIBLE.

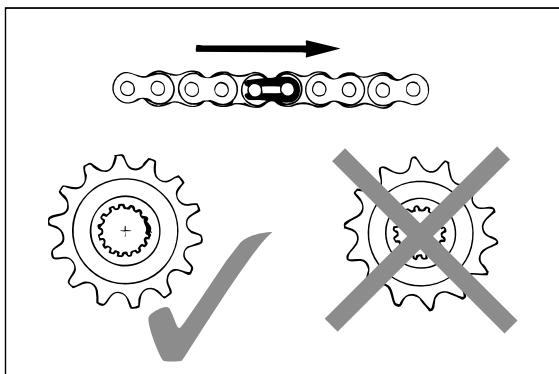

Chain maintenance

For long chain life, good maintenance is very important. X-ring chains require only modest maintenance. The best way is to use lots of water, but never use brushes or solvents. After letting the chain dry, you can use a special X-ring chain spray (Motorex Chainlube Racing).

-
- ⚠ WARNING ⚠**
- NO LUBRICATION IS ALLOWED TO REACH THE REAR TIRE OR THE BRAKE DISK, OTHERWISE THE ROAD ADHERENCE AND THE REAR WHEEL BRAKING EFFECTS WOULD BE STRONGLY REDUCED AND THE MOTORCYCLE COULD EASILY GET OUT OF CONTROL.

-
- ! CAUTION !**
- WHEN MOUNTING THE CHAIN JOINT, THE CLOSED SIDE OF THE SAFETY DEVICE MUST POINT IN RUNNING DIRECTION.

Also check sprockets and chain guides for wear, and replace if necessary.

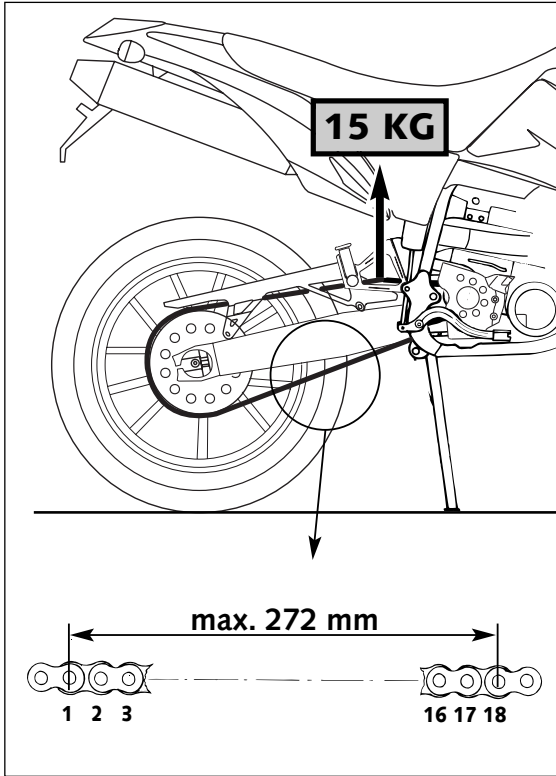

Chain wear

In order to check the chain wear, regard the following instructions: Shift the gear into idling and pull the upper chain strand with approx. 10-15 kilogram (33 lb) upwards (see figure). Now one can measure a space of 18 chain reels at the lower chain strand. The chain should be replaced at the latest when a space of 272 mm (10,70 in) is measured. Chains do not always wear off evenly, therefore repeat the measurement at different places on the chain.

NOTE:

If you mount a new chain, the sprockets should also be replaced. New chains wear faster if used on old used sprockets.

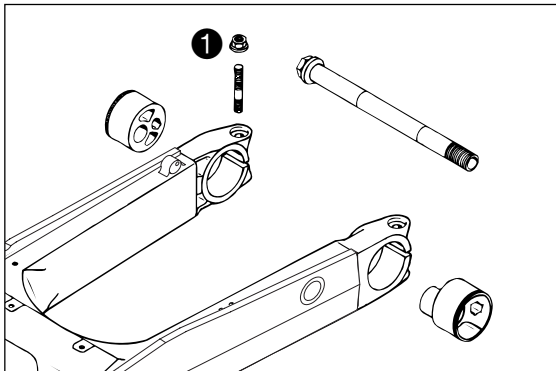

Maintaining chain tension eccentrics

To ensure trouble-free adjustment, take the chain tension eccentrics out at least once a year for maintenance them. To do this:

Remove rear wheel.

Loosen hexagon nuts ❶ on the left and right swing arm fists.

Remove eccentrics.

Clean eccentrics and swing arm fists thoroughly and grease the slide faces with a Molykote grease or spray.

Replace eccentrics (eccentric with the thread goes in the left swing arm fist).

Turn both eccentrics to the same position (marks should be aligned with the notches in the swing arm fists).

Tighten hexagon nuts on the swing arm fists with 40 Nm (30 ft.lb).

Mount the rear wheel and tighten the wheel spindle to 80 Nm (59 ft.lb).

Adjust the chain tension.

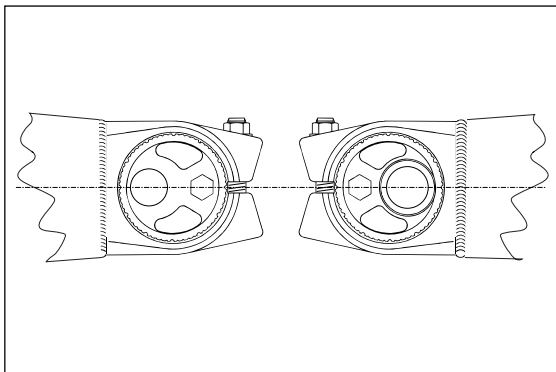

WARNING



IF YOU DON'T HAPPEN TO HAVE A TORQUE WRENCH AT HAND, MAKE SURE YOU HAVE THE TIGHTENING TORQUE CORRECTED BY A KTM DEALER AS SOON AS POSSIBLE.



CAUTION



IF THE ECCENTRICS ARE NOT ALIGNED, THE REAR WHEEL WILL REST AT AN ANGLE IN THE SWING ARM. THIS WILL STRESS THE REAR WHEEL AND SWING ARM BEARINGS AND DAMAGE THEM IF NOT CORRECTED.

General information about KTM disc brakes

BRAKE CALIPERS:

The front brake caliper ❶ has 4 brake pistons and is rigidly connected to the fork leg. The rear brake caliper has one brake piston and "floats", which means that it is not rigidly connected to the brake caliper support. The resulting lateral adjustment ensures that the brake pads ❷ optimally rest against the brake disk at any time. Secure the screws of the caliper support with Loctite 243 and tighten to 45 Nm (33,2 ft.lb).

BRAKE PADS:

The motorcycle is equipped with organic brake linings. The thinnest point of the lining must not be thinner than 1 mm.

⚠ WARNING ⚠

BRAKE PADS AVAILABLE IN THE ACCESSORY TRADE ARE OFTEN NOT AUTHORIZED FOR OPERATION OF YOUR KTM MOTORCYCLE IN ROAD TRAFFIC. THE BRAKE PADS DESIGN AND FRICTION FACTOR AND THEREFORE THE BRAKING POWER CAN DEVIATE SIGNIFICANTLY FROM ORIGINAL KTM BRAKE PADS. IF YOU USE DIFFERENT BRAKE PADS THAN THOSE PROVIDED WITH THE ORIGINAL EQUIPMENT, IT CANNOT BE WARRANTED THAT THEY ARE AUTHORIZED FOR USE IN ROAD TRAFFIC. YOUR MOTORCYCLE WILL NOT LONGER COMPLY WITH THE REGULATIONS AUTHORIZING THE USE OF VEHICLES FOR ROAD TRAFFIC AND THE WARRANTY WILL BE VOID.

BRAKE DISCS:

Due to wear, the thickness of the brake disc in the area of the contact face ❸ of the brake pads decreases. At their thinnest point ❹, the brake discs must not be more than 0.4 mm (0,016 in) thinner than the pad's nominal thickness. Measure the nominal thickness in a location ❺ outside the contact face. Check wear in several locations.

⚠ WARNING ⚠

- BRAKE DISCS SUFFERING FROM WEAR GREATER THAN 0,4 MM (0,016 IN) CONSTITUTE A SAFETY RISK. HAVE THE BRAKE DISCS REPLACED IMMEDIATELY AS SOON AS THEY REACH THE WEAR LIMIT.
- HAVE ANY REPAIRS ON THE BRAKE SYSTEM BE PERFORMED BY A KTM DEALER

BRAKE FLUID RESERVOIRS:

The brake fluid reservoirs on front and rear wheel brakes have been designed in such a way that even if the brake pads are worn it is not necessary to top up the brake fluid. If the brake fluid level drops below the minimum level either the brake system has a leak or the brake pads are completely worn. In this case, consult an authorized KTM dealer immediately.

BRAKE FLUID:

KTM fills the brake systems with Motorex Brake Fluid DOT 5.1 brake fluid, one of the best brake fluids that is currently available. We recommend that you continue to use it. DOT 5.1 brake fluid is based on glycol ether and of an amber color. If you do not have any DOT 5.1 for refilling, you may use DOT 4 brake fluid. However, you should replace it as soon as possible by DOT 5.1.

Never use brake fluid DOT 5. The color of this silicon oil-based product is purple red. The gaskets and brake hoses of KTM motorcycles are not designed for DOT 5 brake fluid!

⚠ WARNING ⚠

CHANGE BRAKE FLUID AT LEAST ONCE A YEAR. IF THE MOTORCYCLE IS BEING WASHED VERY OFTEN, CHANGE BRAKE FLUID MORE OFTEN. BRAKEFLUID HAS THE ABILITY TO ADMIT WATER; THEREFORE, STEAM BUBBLES CAN FORM IN „OLD“ BRAKE FLUID AT RELATIVELY LOW TEMPERATURES THUS CAUSING THE BRAKE SYSTEM TO FAIL.

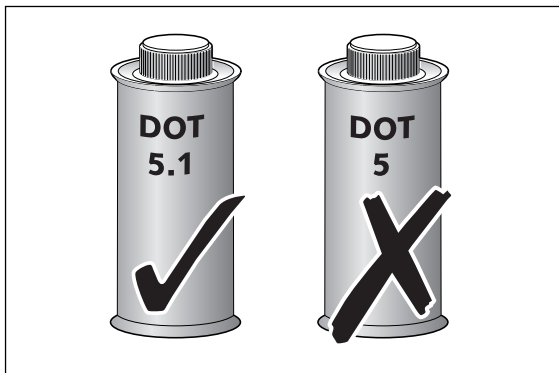
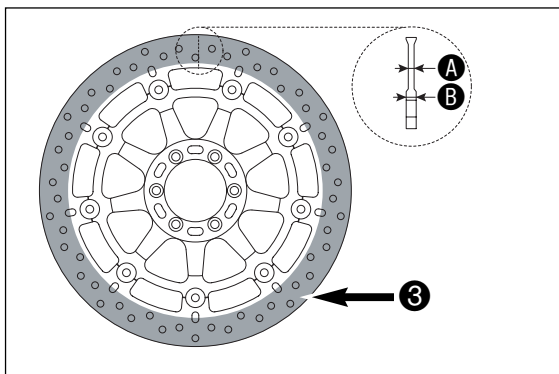
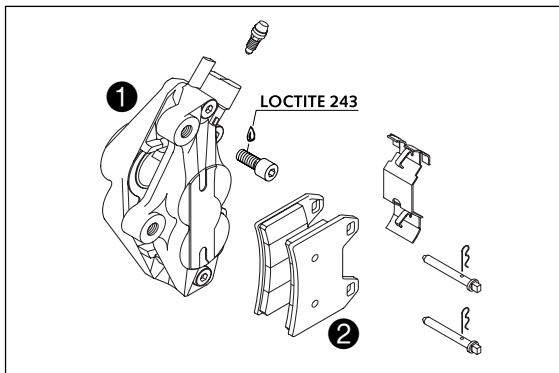

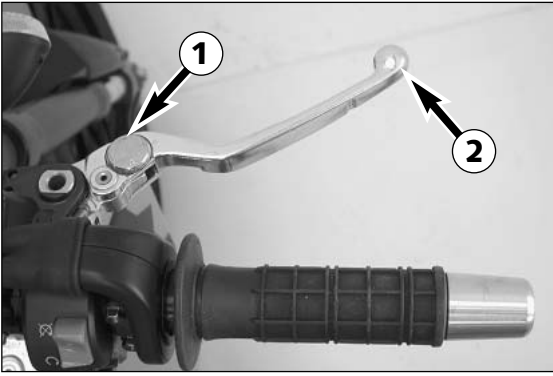

Changing the basic position of the handbrake lever

The adjusting screw ❶ allows you to change the basic position of the handbrake lever ❷. Press the handbrake lever's outer end forward, and, at the same time, turn the adjusting screw.

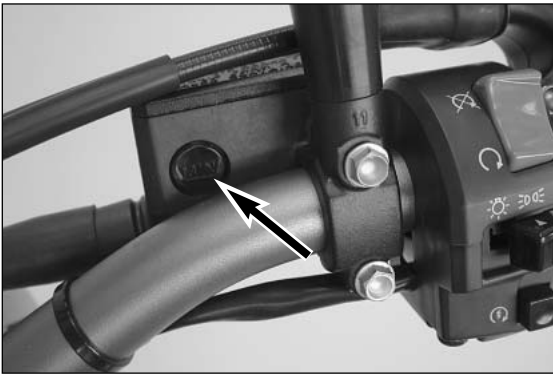

Checking of brake fluid level - front brake

The brake fluid reservoir is linked with the hand brake cylinder at the handlebar and the reservoir is provided with an inspection glass. With the reservoir in a horizontal position, the brake fluid level should not drop below the middle of the glass. The reservoir should be kept completely full at all times for best performance.



WARNING



IF THE BRAKE FLUID LEVEL DROPS BELOW THE MINIMUM EITHER THE BRAKE SYSTEM HAS A LEAK OR THE BRAKE PADS ARE COMPLETELY WORN. IN THIS CASE, CONSULT AN AUTHORIZED KTM DEALER IMMEDIATELY.

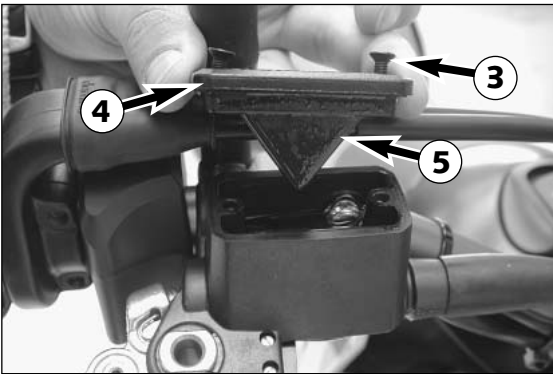

Refilling the front brake fluid reservoir *

When the brake fluid falls to the middle of the inspection glass, new brake fluid has to be added.

Loosen screws ❸ and remove lid ❹ and membrane ❺.

Place hand brake cylinder in a horizontal position and fill the brake fluid reservoir to 5 mm (0,2 in) below the rim with clean brake fluid DOT 5.1 (Motorex Brake Fluid 5.1). Replace membrane and lid, tighten screws. Rinse off spilled or overflowing brake fluid with water.



WARNING



- NEVER USE DOT 5 BRAKE FLUID! IT IS BASED ON SILICONE OIL AND OF A PURPLE COLOR. SEALS AND BRAKE HOSES MUST BE ESPECIALLY ADAPTED TO IT.
- STORE BRAKE FLUID OUT OF REACH OF CHILDREN.
- BRAKE FLUID CAN CAUSE SKIN IRRITATION. AVOID CONTACT WITH SKIN AND EYES. IF YOU GET BRAKE FLUID IN YOUR EYES, RINSE WITH PLENTY OF WATER AND CONSULT A DOCTOR.



CAUTION



- DON'T LET BRAKE FLUID GET IN CONTACT WITH PAINT, IT IS AN EFFECTIVE PAINT REMOVER.
- USE ONLY CLEAN BRAKE FLUID TAKEN FROM A TIGHTLY SEALED CONTAINER.

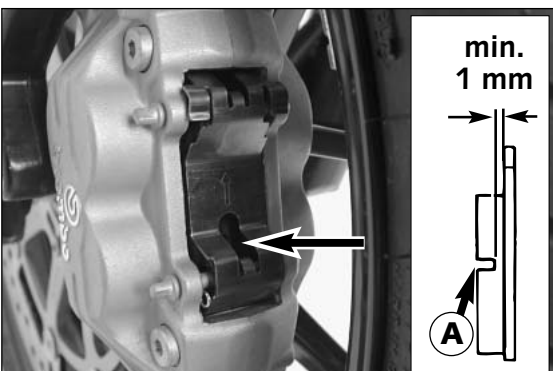
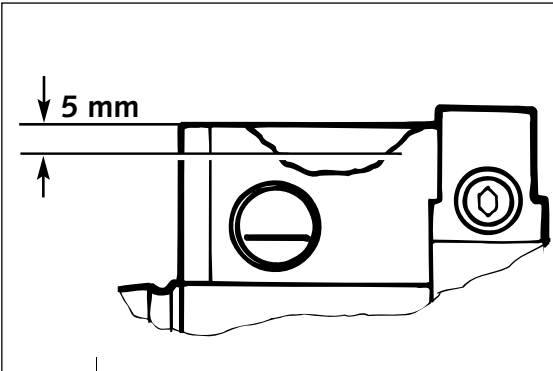

Checking the front brake pads

The brake pads can be inspected from behind. Always inspect the brake pad linings before taking off on your motorcycle. They should not be thinner than 1 mm which is the case when the notch ❶ is no longer discernable.



WARNING



AT THEIR MOST WORN POINT BRAKE PAD LININGS SHOULD NOT BE THINNER THAN 1 MM, OTHERWISE THEY COULD LEAD TO BRAKE FAILURE. FOR YOUR OWN SAFETY DON'T PUT OFF HAVING YOUR BRAKE PADS CHANGED.



CAUTION



IF THE BRAKE PADS ARE REPLACED TOO LATE SO THAT THE LINING IS PARTLY OR ENTIRELY WORN AWAY, THE STEEL COMPONENTS OF THE BRAKE PAD WILL RUB AGAINST THE BRAKE DISC, SIGNIFICANTLY IMPAIRING THE BRAKING EFFECT AND DESTROYING THE BRAKE DISC.

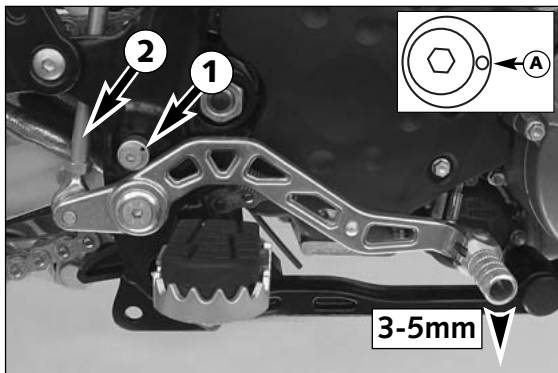

Changing the basic position of the foot brake pedal*

The basic position of the foot brake pedal can be altered by turning the stop roller ①. The free play at the foot brake pedal must then be adjusted by means of the piston rod ②.

Measured on the outside, the foot brake pedal must have 3-5 mm (0,12–0,20 in) of free play, before the piston rod can move the piston in the brake cylinder (to be recognised from the resistance on the foot brake pedal).

! CAUTION !

IF THIS FREE PLAY IS NOT PRESENT, THEN PRESSURE CAN BUILD UP IN THE BRAKE SYSTEM WHEN DRIVING, CAUSING CONSTANT FRICTION OF THE BRAKE PADS. THE BRAKING SYSTEM OVERHEATS AND CAN FAIL COMPLETELY IN EXTREME CASES.



Checking the rear brake fluid level

The reservoir for the rear disc brake is located on the left-hand side of the vehicle next to the carburetor carburetor connection boot. The brake fluid level may not drop below the „MIN” marking when the vehicle is in an upright position.

⚠ WARNING ⚠

IF THE BRAKE FLUID LEVEL DROPS BELOW THE MINIMUM EITHER THE BRAKE SYSTEM HAS A LEAK OR THE BRAKE PADS ARE COMPLETELY WORN. IN THIS CASE, CONSULT AN AUTHORIZED KTM DEALER IMMEDIATELY.



Refilling the rear brake fluid reservoir*

When the brake fluid level has dropped to the MIN mark, you need to refill the brake fluid reservoir.

For easier access to the brake fluid reservoir it is recommended to remove the hexagon screw ③. Then move the container outwards as indicated in the illustration. Remove plug ④ with rubber boot ⑤ and add brake fluid DOT 5.1 (Motorex Brake Fluid DOT 5.1) up to the „MAX” mark. Replace rubber boot and plug. Overflowed or spilled brake liquid must be rinsed off with water. Mount the screw and fix the brake fluid reservoir to the frame, always making sure to prevent kinks in the connecting hose.

⚠ WARNING ⚠

- NEVER USE DOT5 BRAKE FLUID! IT IS BASED ON SILICONE OIL AND OF A PURPLE COLOR. SEALS AND BRAKE HOSES MUST BE ESPECIALLY ADAPTED TO IT.
- STORE BRAKE FLUID OUT OF REACH OF CHILDREN.
- BRAKE FLUID CAN CAUSE SKIN IRRITATION. AVOID CONTACT WITH SKIN AND EYES. IF YOU GET BRAKE FLUID IN YOUR EYES, RINSE WITH PLENTY OF WATER AND CONSULT A DOCTOR

! CAUTION !

- DON'T LET BRAKE FLUID GET IN CONTACT WITH PAINT, IT IS AN EFFECTIVE PAINT REMOVER.
- USE ONLY CLEAN BRAKE FLUID TAKEN FROM A TIGHTLY SEALED CONTAINER.

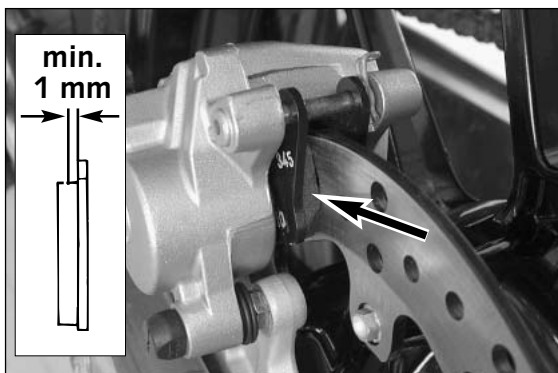
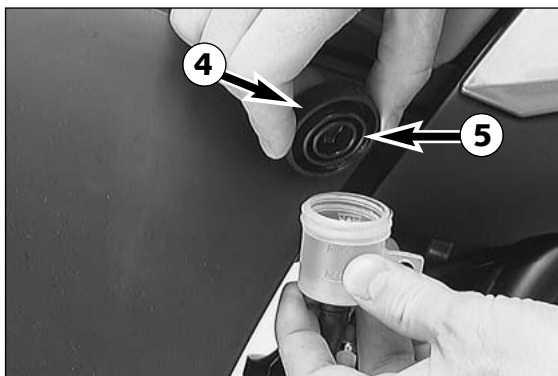

Checking the rear brake pads

The brake pads can be inspected from the rear. The thickness of the linings may not be less than 1 mm (0.04 in).

⚠ WARNING ⚠

AT THEIR MOST WORN POINT BRAKE PAD LININGS SHOULD NOT BE THINNER THAN 1 MM, OTHERWISE THEY COULD LEAD TO BRAKE FAILURE. FOR YOUR OWN SAFETY DON'T PUT OFF HAVING YOUR BRAKE PADS CHANGED.

! CAUTION !

IF THE BRAKE PADS ARE REPLACED TOO LATE SO THAT THE LINING IS PARTLY OR ENTIRELY WORN AWAY, THE STEEL COMPONENTS OF THE BRAKE PAD WILL RUB AGAINST THE BRAKE DISC, IMPAIRING THE BRAKING EFFECT AND DESTROYING THE BRAKE DISC.

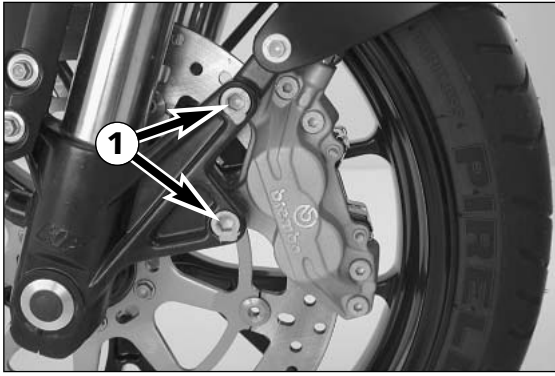

Dismounting and mounting the front wheel*

To remove the front wheel, jack the motorcycle up by the frame so that the front wheel no longer touches the ground.
Take out both AH screws **1** and remove brake caliper from brake disc.

! CAUTION !

WHEN REMOVING THE BRAKE CALIPER, MAKE SURE THAT THE BRAKE LINE, THE BRAKE DISC AND THE BRAKE LININGS ARE NOT DAMAGED.

Screw speedometer cable **2** from speedometer drive.
Loosen the clamp screws **3** on the right fork leg axle passage (leave the clamp screws on the left fork fist tightened).
Loosen wheel spindle **4**.
Hold the front wheel, pull the wheel spindle out, remove the front wheel from the fork by pulling it forward.

! CAUTION !

- DO NOT OPERATE THE HAND BRAKE WHEN THE FRONT WHEEL HAS BEEN REMOVED.
- ALWAYS PUT DOWN THE WHEEL WITH THE BRAKE DISC ON TOP TO PREVENT DAMAGING OF THE BRAKE DISC.

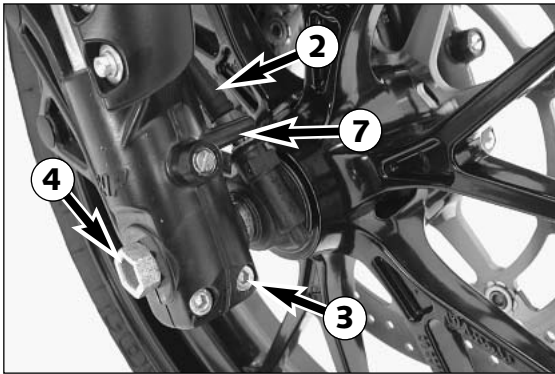

Prior to mounting the front wheel, clean and grease the shaft seal ring **5** and running surface **6** at the speedometer drive.
To mount the front wheel insert speedometer drive into the front wheel.
Lift the front wheel into the fork and position the speedometer drive as shown in the illustration (the connection for the speedometer cable must be below the nose **7**).

Replace the wheel spindle and tighten it with 40 Nm (30 ft.lb).
Mount the brake caliper, apply Loctite 243 to the thread of the allen head screws and tighten it 45 Nm (33 ft.lb).
Attach speedometer drive cable.

Jack the motorcycle back down, work the front brake and bounce the fork hard a few times to align the fork tubes.

Now you can tighten the clamp screws on the right fork leg axle passage to 10 Nm (7 ft.lb).

⚠ WARNING ⚠

- THE AH SCREWS **1** OF THE BRAKE CALIPER MUST BE SECURED WITH LOCTITE 243 TO PREVENT LOOSENING.
- IF YOU DON'T HAPPEN TO HAVE A TORQUE WRENCH AT HAND, MAKE SURE YOU HAVE THE TIGHTENING TORQUE CORRECTED BY A KTM DEALER AS SOON AS POSSIBLE.
- IT IS VERY IMPORTANT TO KEEP THE BRAKE DISK FREE FROM OIL AND GREASE, OTHERWISE THE BRAKING EFFECTS WOULD BE STRONGLY REDUCED.
- AFTER MOUNTING THE FRONT WHEEL, KEEP OPERATING THE HAND BRAKE UNTIL THE PRESSURE POINT RETURNS.

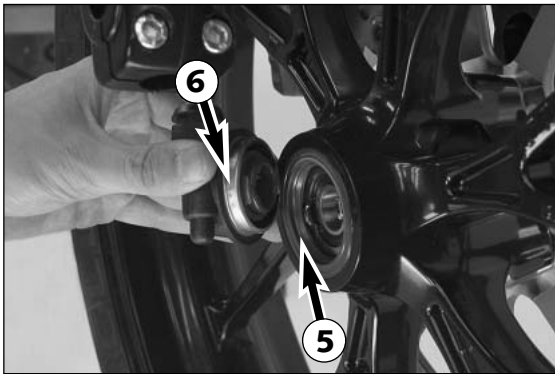

Dismounting and mounting the rear wheel*

Jack up the motorcycle under the frame to lift the rear wheel of the ground.
Remove the hexagon nut **8** on the left swing arm fist.
Loosen the AH screw **9** and the wheel spindle **10** and pull the eccentric **11** out on the left side. Remove the brake caliper from the brake disk.
Hold the rear wheel and remove the wheel spindle. Move the rear wheel down and forward and take the chain off of the rear sprocket.

! CAUTION !

- DO NOT OPERATE THE FOOT BRAKE WHEN THE REAR WHEEL HAS BEEN DISMOUNTED.
- ALWAYS PUT DOWN THE WHEEL WITH THE BRAKE DISC ON TOP TO PREVENT DAMAGING OF THE BRAKE DISC.

NOTE:
When removing the rear wheel always check the damping rubbers.

Clean and lubricate the wheel spindle thread.
Lift the rear wheel together with the rear sprocket carrier into the swinging fork and place the chain on the rear sprocket.
Insert the wheel spindle to hold the rear wheel and position the brake caliper. Align the eccentric and tighten the wheel spindle to 80 Nm (59 ft.lb).
Tighten the hexagon nut to 40 Nm(30 ft.lb) and the AH screw on the brake caliper to 40 Nm(30 ft.lb).

⚠ WARNING ⚠

- IF YOU DON'T HAPPEN TO HAVE A TORQUE WRENCH AT HAND, MAKE SURE YOU HAVE THE TIGHTENING TORQUE CORRECTED BY A KTM DEALER AS SOON AS POSSIBLE.
- IT IS VERY IMPORTANT TO KEEP THE BRAKE DISK FREE FROM OIL AND GREASE, OTHERWISE THE BRAKING EFFECTS WOULD BE STRONGLY REDUCED.
- AFTER MOUNTING THE REAR WHEEL, KEEP OPERATING THE FOOT BRAKE UNTIL THE PRESSURE POINT RETURNS.

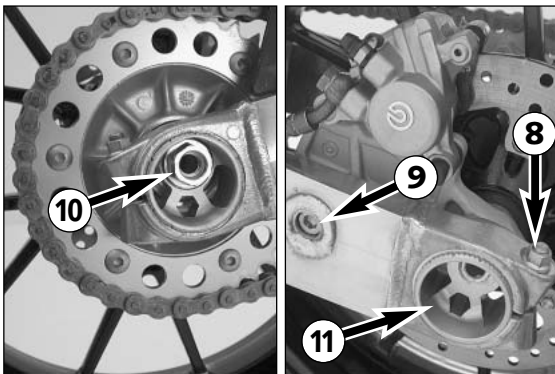

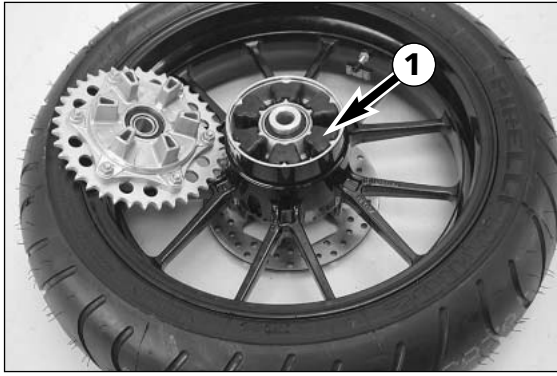

Checking the damping rubbers in the rear wheel *

In the Duke, the transmission of power to the rear wheel is damped. For this purpose, the engine power is conveyed from the rear sprocket via 6 damping rubbers ❶ to the rear wheel. These 6 damping rubbers wear with increasing operation time, and should be checked for wear whenever the rear wheel is dismantled.

For this purpose, lie the rear wheel on a work bench with the rear sprocket upwards, and put the wheel spindle in the hub. Now hold the rear wheel firmly and try to turn the rear sprocket. The rear sprocket may not turn more than maximum 5 mm (0,2 in) measured on the outside. If the play in the chain wheel is larger, all 6 shock damping rubbers are to be replaced. Check the shock damping rubbers for signs of damage and dirt.

! CAUTION !

IF THE DAMPING RUBBERS ARE NOT REPLACED IN GOOD TIME, THE REAR SPROCKET CARRIER AND THE REAR WHEEL WILL BE DAMAGED.

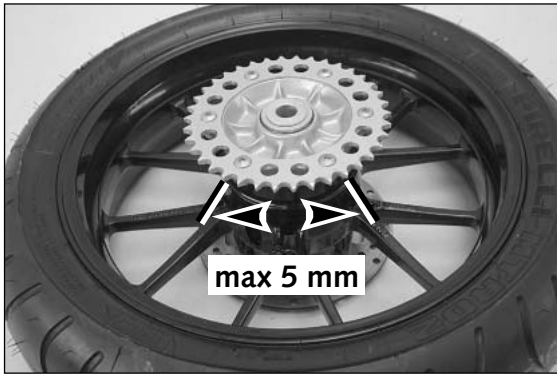

Tires, air pressure

Tire type, tire condition, and how much air pressure the tires have in them affect the way your motorcycle rides, and they must therefore be checked whenever you're getting ready to go anywhere on your motorcycle.

Tire type and size can be found in the technical specifications and in the homologation certificate.

Tire condition has to be checked every time you want to ride your motorcycle. Before leaving check for punctures and nails or other sharp objects that might have become embedded in the tire.

Refer to the specific regulations in your country for minimum tire tread requirements. We recommend replacing tires at the latest when the tread is down to 2 mm.

Tire pressure should be checked regularly on a "cold" tire. Proper pressure ensures optimum driving comfort and extends the life of your tires.

⚠ WARNING ⚠

- DO NOT MOUNT TIRES WHICH HAVE NOT BEEN APPROVED BY KTM. OTHER TIRES COULD HAVE ADVERSE EFFECTS ON THE WAY YOUR MOTORCYCLE RIDES.
- THE FRONT AND REAR WHEEL ARE ONLY ALLOWED TO BE TIRED WITH TIRES THAT HAVE THE SAME PROFILE TYPE.
- FOR YOUR OWN SAFETY REPLACE DAMAGED TIRES IMMEDIATELY.
- WORN TIRES CAN HAVE A NEGATIVE EFFECT ON HOW YOUR MOTORCYCLE PERFORMS, ESPECIALLY ON WET SURFACES
- IF AIR PRESSURE IS TOO LOW, ABNORMAL WEAR AND OVERHEATING OF THE TIRE CAN RESULT.
- NEW WHEELS HAVE A SMOOTH SURFACE, WHICH MEANS THAT THEY MUST BE RUN IN TO ACHIEVE FULL GRIP. FOR THIS PURPOSE, RIDE THE MOTORCYCLE CAREFULLY AT MODERATE SPEED DURING THE FIRST 200 KILOMETERS WITH NEW TIRES, TILTING THE VEHICLE AT DIFFERENT ANGLES SO THAT ALL SECTIONS ARE PROPERLY ROUGHENED. TIRES WILL NOT DISPLAY THEIR FULL GRIP CHARACTERISTICS UNTIL THEY ARE PROPERLY RUN IN.
- FOR REASONS OF SAFETY, IT IS RECOMMENDED TO EXCHANGE THE VALVE INSERT WHENEVER A NEW TIRE IS MOUNTED.



TIRES - AIR PRESSURE		
	front	rear
Road, driver only	2,0 bar (29psi)	2,2 bar (31psi)
Road, with passenger	2,2 bar (31psi)	2,4 bar (34psi)



Battery

The battery is mounted under the seat (see "Removing the seat")

MAINTENANCE:

The battery has a closed system and therefore requires no maintenance. It is not necessary to check the electrolyte level or to refill water. Simply keep the battery poles clean and slightly grease them with an acid-free grease if necessary.

REMOVING THE BATTERY:

First disconnect the negative and then the positive pole of the battery.

Remove screws ❶ and take off retaining bracket.

Remove battery.

When replacing, connect first the positive and then the negative pole.

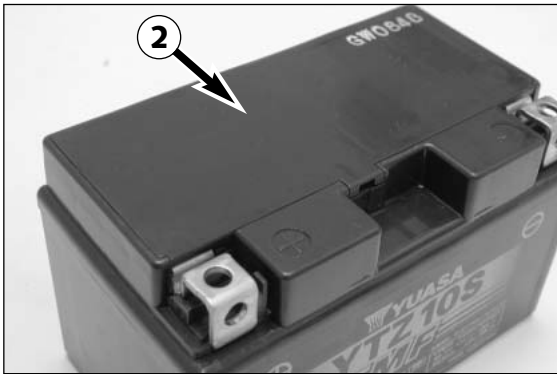
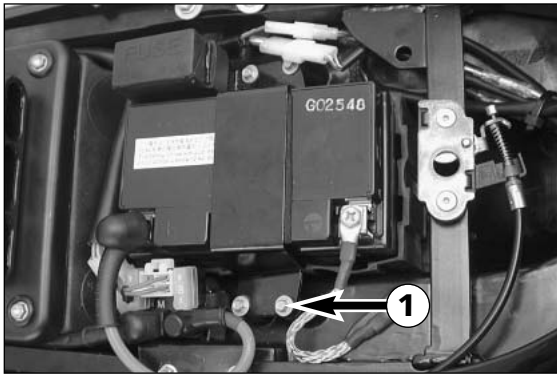

⚠ **WARNING** ⚠

- IF ELECTROLYTE (SULPHURIC ACID) LEAKS FROM THE BATTERY, PROCEED WITH GREAT CARE. THE ELECTROLYTE CAN CAUSE SEVERE BURNS.
- IN THE CASE OF SKIN CONTACT RINSE THOROUGHLY WITH WATER.
- IN THE CASE OF CONTACT WITH THE EYES, THOROUGHLY RINSE EYES WITH WATER FOR AT LEAST 15 MINUTES. IMMEDIATELY CONSULT A DOCTOR!
- THE BATTERY IS A CLOSED MODEL BUT CAN NEVERTHELESS EMIT EXPLOSIVE GASES. AVOID SPARKS AND OPEN FIRE NEAR THE BATTERY.
- DEFECT BATTERIES MUST BE STORED OUT OF THE REACH OF CHILDREN. ENSURE PROPER DISPOSAL OF DISCARDED BATTERIES.

! **CAUTION** !

- TO AVOID DAMAGE, DO NOT REMOVE THE LOCKING BAR ❷ !
- NEVER DISCONNECT THE BATTERY WHILE THE ENGINE IS RUNNING. THIS WILL DESTROY THE RECTIFIER-REGULATOR.

STORAGE:

When preparing the motorcycle for a longer period of standstill, remove the battery and recharge it. Storage temperature: 0 - 35° C. Do not expose to direct sun radiation.

Charging the battery

NOTE: A battery charger, item no. 58429074000 is available from your KTM dealer.

You can also use the battery charger to test the battery's off load voltage, startability and the generator capacity.

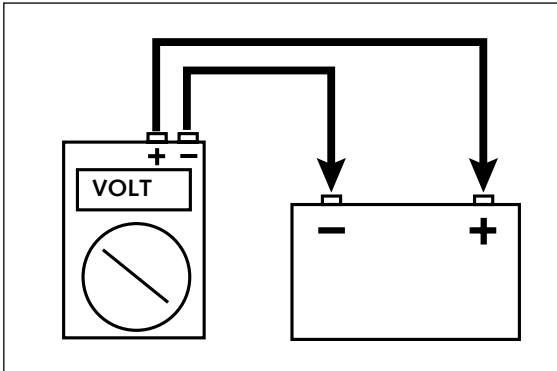

Remove the battery and check the charging level. Use a voltmeter to measure the voltage between the battery poles (off-load voltage).

Accurate results can only be obtained if the battery has neither been charged nor discharged during a period of 30 minutes preceding the measuring.

Recharging is not required if the voltage exceeds 12.4 V.

Recharge if the voltage is below 12.4 V.

CHARGING:

Charge the battery for 5 to a max. of 10 hours with 0.9 amperes and a max. of 14.4 volts.

For a quick charge, do not charge the battery longer than 1 hour with 4.5 amperes and a max. of 14.4 volts.



! **CAUTION** !

- IF THE CHARGE CONDITION CANNOT BE ESTABLISHED, THE BATTERY MAY ONLY BE CHARGED 5 TO A MAX. OF 10 HOURS WITH 0.9 AMPERES AND A MAX. OF 14.4 VOLTS.
- ALWAYS CONNECT THE BATTERY TO THE CHARGING UNIT BEFORE TURNING THE CHARGING UNIT ON.
- WHEN RECHARGING THE BATTERY IN CLOSED ROOMS THERE IS SUFFICIENT VENTILATION. EXPLOSIVE GASES ARE RELEASED DURING THE BATTERY CHARGING PROCESS.
- CHARGING TIME AND CHARGING VOLTAGE SHOULD NOT EXCEED THE STATED VALUES. OTHERWISE ELECTROLYTE WILL BE RELEASED THROUGH THE SAFETY VALVES.
- AVOID QUICK CHARGING IF POSSIBLE.
- TO AVOID DAMAGE, DO NOT REMOVE THE LOCKING BAR.

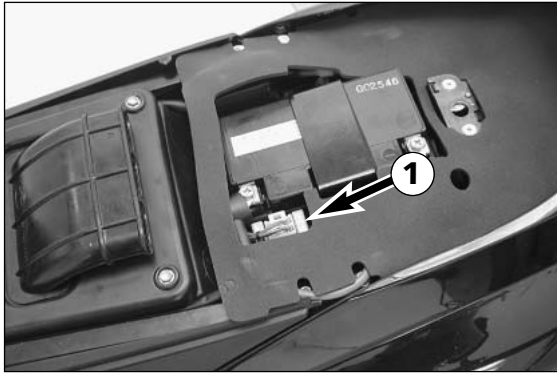

Main fuse

The main fuse ❶ protects all power-consuming units on the motorcycle. It is located below the seat at the starter relay.

For access to the fuse, remove the cover ❷. The capacity of the fuse is 20 A. A spare fuse can be found under the other cover ❸. When using the spare fuse, remember to replace it as soon as possible so that a spare fuse is always at hand. Replace a blown fuse only with an equivalent one. If a new fuse that has just been set in gets blown again, you are strongly advised to have it inspected by a KTM dealer. The fuse capacity is 20 Ampere.

! CAUTION !

- UNDER NO CIRCUMSTANCES IS A STRONGER FUSE ALLOWED TO BE SET IN OR A FUSE ALLOWED TO BE "REPAIRED". AN INEXPERT TREATMENT COULD DAMAGE THE WHOLE ELECTRICAL INSTALLATION!
- CONTACT A SPECIALIZED KTM DEALER, SHOULD DEFECTS OF THE ELECTRIC SYSTEM OCCUR MORE FREQUENTLY.

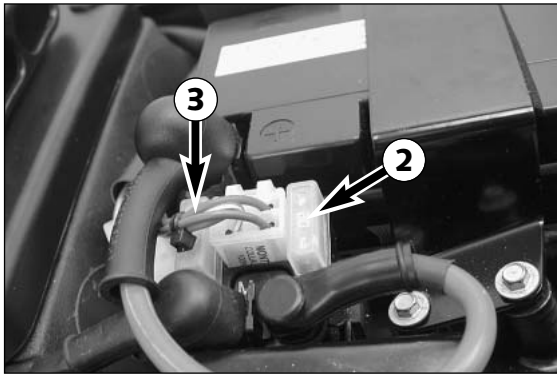

Fuses

Fuse box ❶ is located under the seat.

See "Removing the seat" to remove and mount the seat.

The fuses are numbered on the inside of the fuse box.

The fuses marked "RES" are spare fuses.

Fuse 1 (10 Ampere) protects the following power-consuming units:

- ignition
- starter system

Fuse 2 (10 Ampere) protects the following power-consuming units:

- flasher lights
- brake light
- horn
- fan

Fuse 3 (10 Ampere) protects the following power-consuming units:

- headlight
- parking light

Replace a blown fuse only with an equivalent one. If a new fuse that has just been set in gets blown again, you are strongly advised to have it inspected by a KTM dealer.

! CAUTION !

UNDER NO CIRCUMSTANCES IS A STRONGER FUSE ALLOWED TO BE SET IN OR A FUSE ALLOWED TO BE "REPAIRED". AN INEXPERT TREATMENT COULD DAMAGE THE WHOLE ELECTRICAL INSTALLATION!

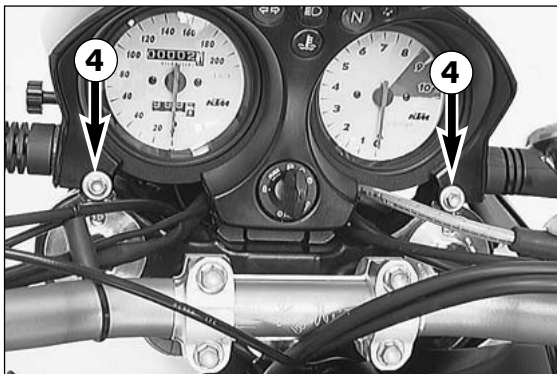
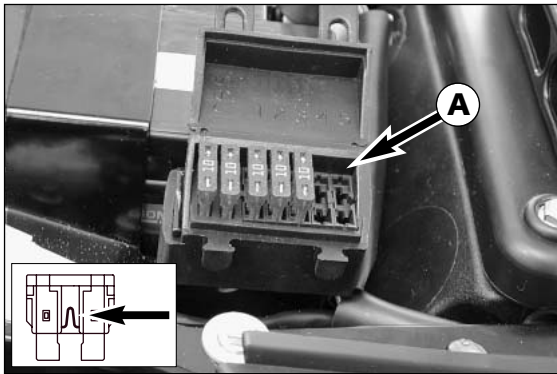

Opening the headlight mask

The headlight mask can be opened, thus providing easy access to headlight lamps, instrument lights and indicator lamps.

Remove the screws ❹ and take out the ignition key.

Lift the instrument cover in the area of the ignition lock, simultaneously swinging the headlight mask forward.

The headlight mask can be swung forward until it rests against the fork legs. To prevent damaging of painted surfaces, it is recommended to put a cloth or similar material between the mask and the fork legs.



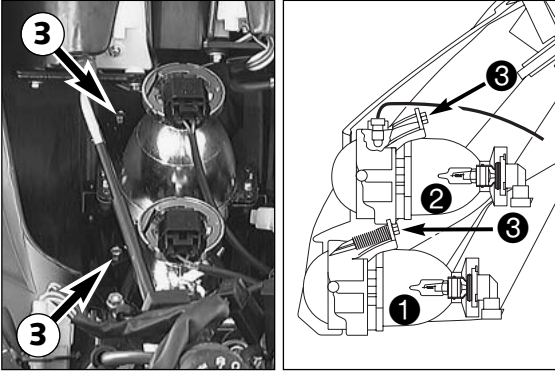

Headlight range adjustment *

The range by the low beam ① and the high beam ② can be adjusted by means of the screws ③. These screws ③ are accessible when the headlight mask is opened. Turn the screws clockwise to reduce the distance lighted. Turn the screws counterclockwise to increase the distance lighted.

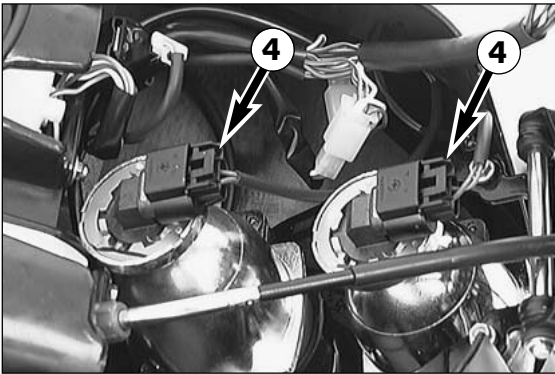

Headlight - replacing the bulbs *

Open the headlight mask. Take off the cable plug ④. Turn the bulb ⑤ counterclockwise all the way to the stop, then take it out of the headlight. The glass bulb and the bulb socket are one single unit. Do not attempt to pull the bulb out of the socket. The lamp is a special bulb (Type HB3) which is not available everywhere. Therefore, always make sure to have a spare lamp with you. Insert the new bulb into the headlight, avoiding to touch the glass of the bulb with bare fingers.

! CAUTION !

NEVER TOUCH THE GLASS OF THE BULB WITH YOUR FINGERS. THE GLASS OF THE BULB MUST REMAIN ABSOLUTELY FREE FROM GREASE. HEAT WILL OTHERWISE CAUSE THE GREASE TO EVAPORATE AND SETTLE DOWN ON THE REFLECTOR.

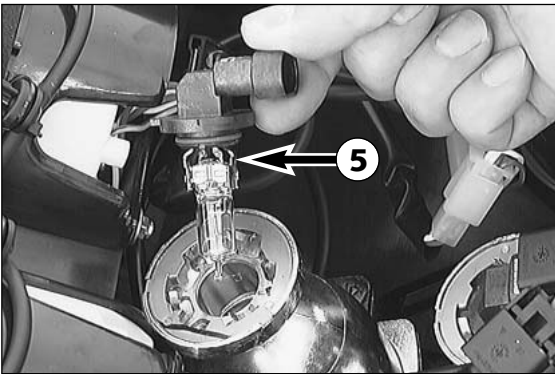

Reconnect the cable plug. Start the engine and check the headlight for proper functioning. Close the headlight mask.

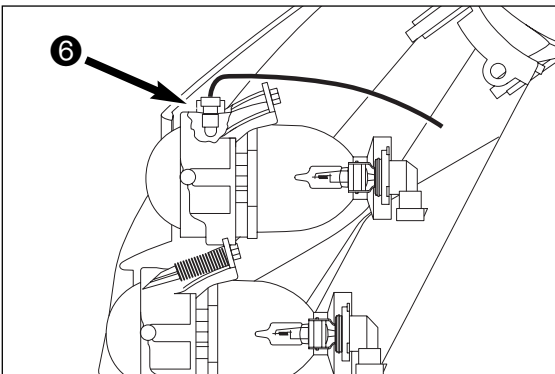

Parking light - replacing the bulb *

The parking light is located in the upper headlight. Open the headlight mask. Pull the bulb socket ⑥ upward and out of the headlight. Pull the old bulb out of the bulb socket and insert a new bulb.

! CAUTION !

NEVER TOUCH THE GLASS OF THE BULB WITH YOUR FINGERS. THE GLASS OF THE BULB MUST REMAIN ABSOLUTELY FREE FROM GREASE. HEAT WILL OTHERWISE CAUSE THE GREASE TO EVAPORATE AND SETTLE DOWN ON THE REFLECTOR. Check if the lamp works properly. Reassemble the unit, reversing the worksteps indicated above.

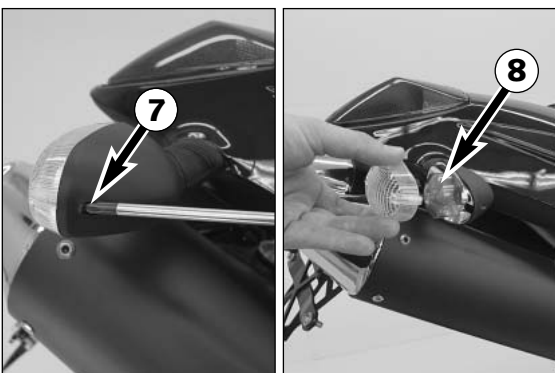

Replacing the flasher bulbs

Remove the screw ⑦ on the back of the turn signal, carefully fold the lens towards the motorcycle and remove. Turn the cap ⑧ approx. 15° in a counterclockwise direction and remove. To reassemble the flasher light, reverse the above-described sequence.

Stop light and tail light - replacing the bulb

Remove seat.

Turn the lamp socket ❶ approximately 30° counterclockwise and pull it out of the tail light housing.

Slightly depress the bulb, turn it approx. 30° counterclockwise and pull it out of the socket.

To mount the lamp reverse the worksteps indicated above.

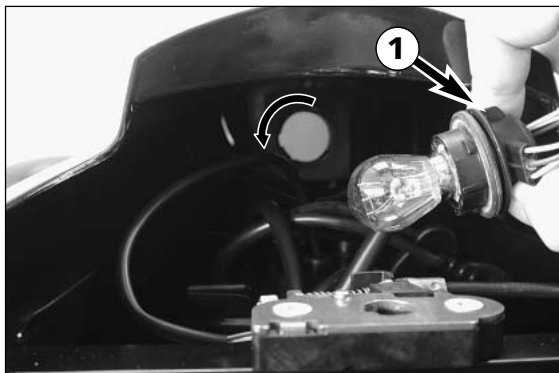

Cooling system

Cooling liquid is circulated by a water pump ❷ located in the engine. When the engine is cold the cooling liquid circulates only through the cylinder and the cylinder head. After the engine has reached its operating temperature (about 70° C, 158° F), the thermostat ❸ opens and the cooling liquid is also pumped through both aluminum radiators.

Air blowing in through the radiators cools the cooling liquid. The slower the speed of the motorcycle, the less the cooling liquid is cooled down. Dirty radiator fins also reduce the cooling efficiency.

If little or no air blows through the radiators, for example when riding through slow traffic or waiting at traffic lights, the cooling liquid temperature will rise. If the cooling liquid temperature rises to 85° C (185° F), the fan on the left radiator will switch on. This fan will provide additional air circulation through the radiator thereby preventing the cooling system from overheating.

Pressure induced by heating of the cooling liquid in the cooling system is controlled by a valve in the radiator cap ❹; a water temperature rising up to 120° C (248° F) is admissible, without fear of problems.

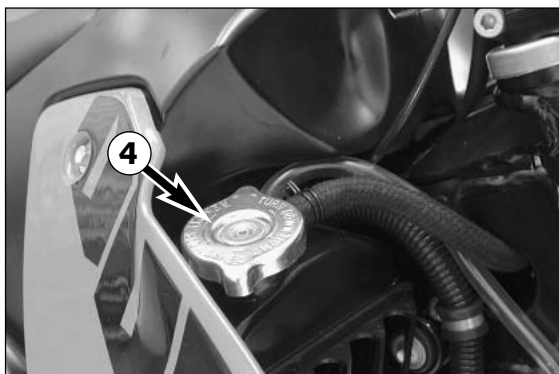
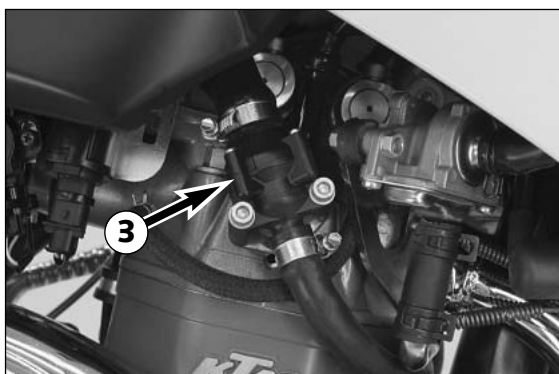
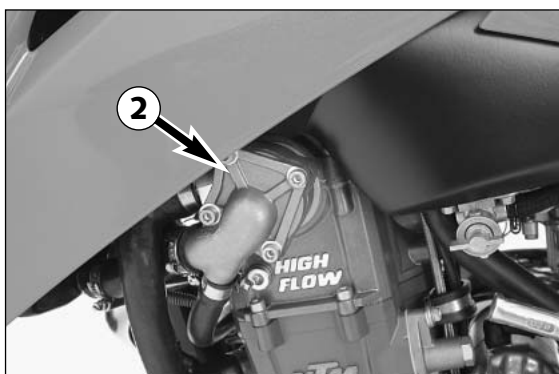

! CAUTION !

The red cooling liquid temperature warning light ❺ will begin to light up, if the cooling liquid temperature reaches approx. 110°C and henceforth has exceeded its normal operating temperature.

Possible causes:

- riding slowly with a large load at a higher air temperature:
If possible increase your running speed, so that more air can blow through the radiators. Should the warning light still be on off after 300 meters, stop immediately, switch off the engine and look for other possible causes.
- Too little cooling liquid in the system:
Let the engine cool down, and check the system for leakage's. Also examine the cooling liquid level **CAUTION SCALDING HAZARD!** Do not drive on, until there is sufficient liquid in the cooling system. Go to your nearest KTM garage and get it seen to. If you drive with the cooling liquid temperature warning light on, you will cause even more damages to the engine.
- The cooling fan on the left cooler is not working:
The cooling fan must be running, when the cooling liquid temperature is 110°C and the ignition is on. If the fan is not working, and there appears to be sufficient cooling liquid, the only thing you can do is to drive on to your nearest KTM garage at the least possible engine load.

A mixture of 40% antifreezer and 60% water is used as cooling liquid. How-ever, the anti-freeze protection must be at least -25° C (-13° F). Aside from antifreezing protection, this mixture also provides great corrosion protection which is why it must not be replaced by pure water.

! CAUTION !

FOR THE COOLING SYSTEM, USE ONLY HIGH-GRADE ANTIFREEZER (MOTOREX ANTI-FREEZE). USING LOWERGRADE ANTIFREEZE AGENTS, CAN CAUSE CORROSION AND COOLANT FOAMING.

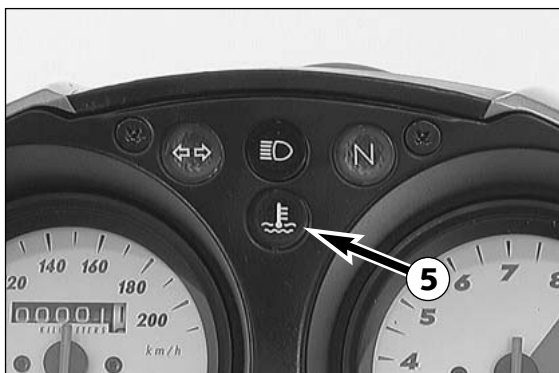

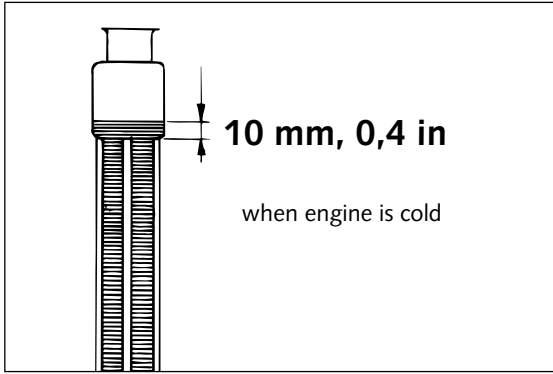

Checking the cooling liquid level

The cooling liquid should be 10 mm (0,4 in) above the cooling elements when the engine is cold (cf. diagram). In the event of the cooling liquid being drained, always fill the system before hand, then top off while the engine is running.



WARNING



- IF POSSIBLE, ALWAYS CHECK LEVEL OF COOLING LIQUID WHEN ENGINE IS COLD. IF YOU HAVE TO OPEN THE RADIATOR CAP WHEN THE ENGINE IS HOT, USE A RAG TO COVER THE CAP AND OPEN SLOWLY TO RELEASE PRESSURE. **CAUTION - SCALDING HAZARD !**
- DO NOT DETACH ANY RADIATOR HOSES WHILE THE ENGINE IS HOT. THE ESCAPING HOT COOLANT AND THE STEAM MAY CAUSE SERIOUS BURNS.
- IN CASE YOU GET BURNT, HOLD THE AFFECTED PART OF YOUR BODY UNDER RUNNING COLD WATER RIGHT AWAY!
- COOLANT IS TOXIC. KEEP THE COOLANT OUT OF THE REACH OF CHILDREN!
- IN CASE COOLANT IS INGESTED, GO SEE A DOCTOR IMMEDIATELY!
- IF COOLANT GETS INTO YOUR EYES, RINSE THEM OUT WITH WATER IMMEDIATELY AND GO SEE A DOCTOR!

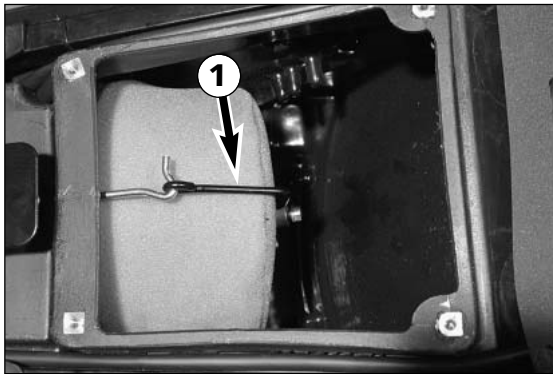

Cleaning of air filter *

To do this, remove the seat and the air filter cover from the air filter box. Unclip the filter holder ①, swing back and remove air filter plus filter carrier from the filter box.

Thoroughly wash the air filter in special cleaning fluid and allow to dry well. Motorex offers environmentally-friendly products for professional oil filter maintenance (Motorex Bio Dirt Remover + Motorex Liquid Bio Power). Only press out the filter, do not wring out under any circumstances. Oil the dry air filter with a high grade filter oil. Also clean the air filter box. Check carburetor collar for damage and that it is fitted correctly.

Mount the air filter on the filter support ②. Grease the front side ③ of the filter, to improve the seal. Mount the air filter and the filter support in the filter box. Make sure they are centered ④, and lock into place with the filter holder ①.

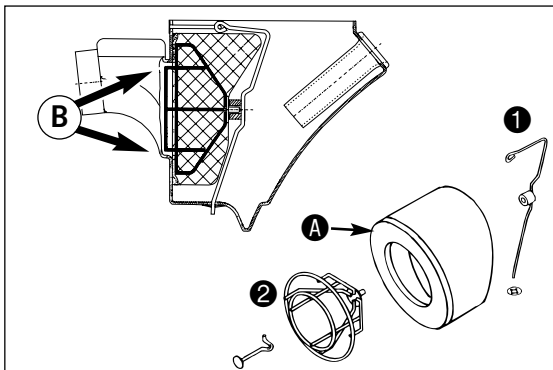

CAUTION



- DO NOT CLEAN AIR FILTER WITH FUEL OR PETROLEUM SINCE THESE DAMAGE THE FOAM. KTM RECOMMENDS THE PRODUCTS OF THE COMPANY „MOTOREX“ FOR AIR FILTER MAINTENANCE.
- HAVING MOUNTED THE AIR FILTER, CHECK IT FOR CORRECT FIT. THE FRONT END ③ MUST ABOUT THE AIR FILTER BOX. OTHERWISE, DUST AND DIRT MAY GET INTO THE ENGINE AND LEAD TO INCREASED WEAR.
- NEVER OPERATE YOUR MOTORCYCLE WITHOUT AIR FILTER. OTHERWISE, DUST AND DIRT MAY GET INTO THE ENGINE AND LEAD TO INCREASED WEAR.

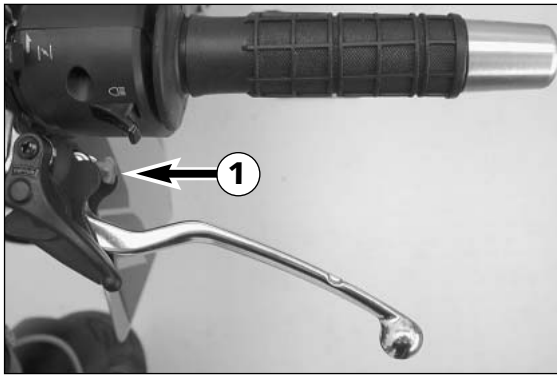

Changing the original position of the clutch lever

The adjusting screw ① can be used for individual adjustment of the original position of the clutch lever, thus allowing adjustment to an optimal position for every hand size.

Turning the adjusting screw clockwise reduces the distance between the clutch lever and the handlebar. Turning the adjusting screw counterclockwise increases the distance between the clutch lever and the handlebar.

! CAUTION !

ADJUSTMENT OF THE CLUTCH LEVER POSITION IS ONLY POSSIBLE WITHIN CERTAIN LIMITS. ONLY TURN THE ADJUSTING SCREW MANUALLY AND NEVER APPLY EXCESSIVE FORCE.

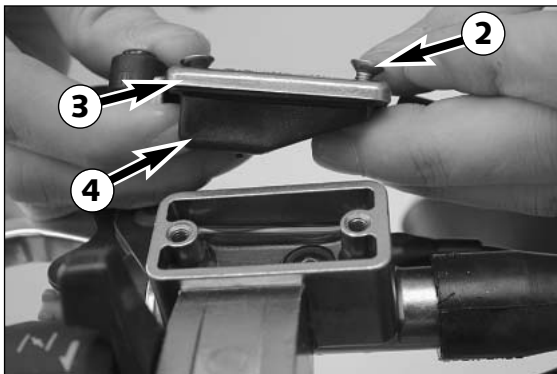

Checking the oil level of the hydraulic clutch

To check the oil level in the master cylinder of the clutch remove the cover. For this purpose, remove screws ② and cover ③ together with the rubber boot ④. The oil level in the horizontal-standing master cylinder should be 4 mm below the upper edge.

If necessary, fill up with biodegradable hydraulic oil SAE 10 (e.g. Motorex Clutchfluid 75). Biodegradable hydraulic oil is available from your KTM dealer (50ml).

! CAUTION !

KTM USES BIODEGRADABLE HYDRAULIC OIL FOR THE HYDRAULIC CLUTCH CONTROL. NEVER MIX BIODEGRADABLE HYDRAULIC OILS WITH MINERAL OILS. ALWAYS USE BIODEGRADABLE HYDRAULIC OIL SAE 10 TO FILL UP THE MASTER CYLINDER. NEVER REFILL WITH MINERAL HYDRAULIC OIL OR BRAKE FLUID.

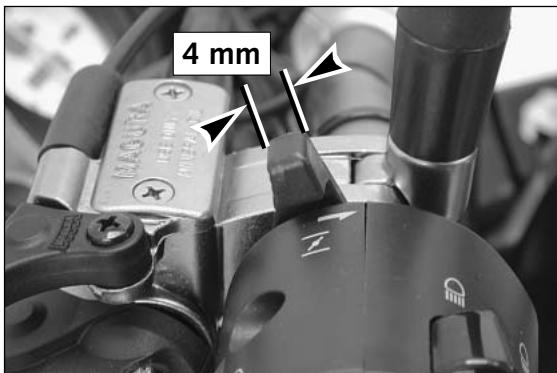

Checking and adjusting the choke cable play *

The choke lever must always have a play of approx. 4 mm (0,16 in).

! CAUTION !

IF THERE IS NO PLAY IN THE CHOKE CABLE, THE BORE OF THE COLD STARTER SYSTEM CANNOT BE COMPLETELY CLOSED. THIS RESULTS IN HIGH FUEL CONSUMPTION, AN UNEVEN RUNNING ENGINE, AND AN EXTREME WEAR OF PISTON AND CYLINDER.

Remove the seat and tank to adjust.

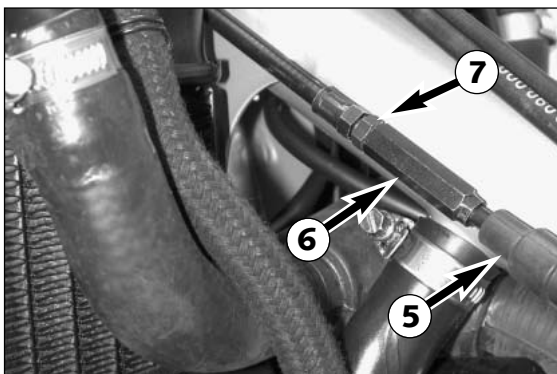

Push the choke lever all the way to the front and slide the protecting cap ⑤ from the adjusting part ⑥.

Loosen the lock nut ⑦ and correct the play by turning the adjusting part. Tighten lock nut and slide protecting cap back on. Mount the tank and seat.

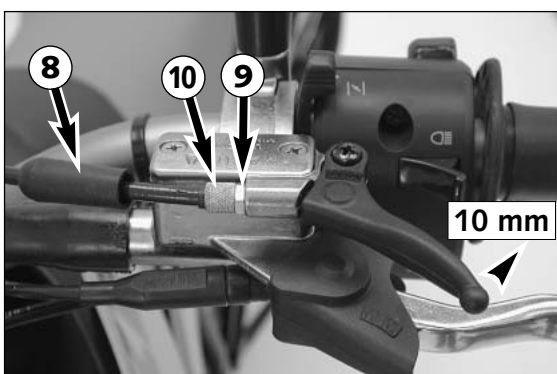

Checking the adjustment of the hand decompression cable *

To check, set piston at compression, so that the valves are closed. While doing this, slowly operate the kick starter until the clicking sound (disengaging) of the automatic decompression release can be heard. Now it must be possible to operate the decompression lever 10 mm (0,39 in) until resistance is felt (the exhaust valves begin to open). To adjust move back the protective cover ⑧, loosen the counter nut ⑨ and correct the adjusting screw ⑩ accordingly. Tighten counter nut and push back protective cover.

! CAUTION !

THE SETTING OF THE HAND DECOMPRESSION CABLE SHOULD BE REGULARLY CHECKED (SEE MAINTENANCE WORK). A LACK OF PLAY IN THE HAND DECOMPRESSION LEVER CAN RESULT IN ENGINE DAMAGE.

NOTE: No adjustment need be made to the automatic decompressor.

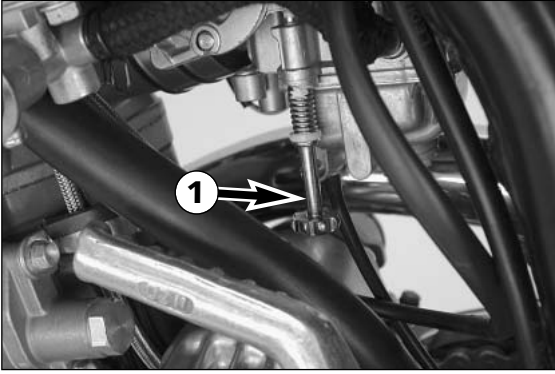

Adjust idling speed *

Use the adjusting screw ❶ to adjust the basic position of the throttle valve and, thus, the idle speed. Turning in clockwise direction will increase the idling speed, turning in counterclockwise direction will reduce the idling speed. Normal idling speed 1400 - 1500 rpm.

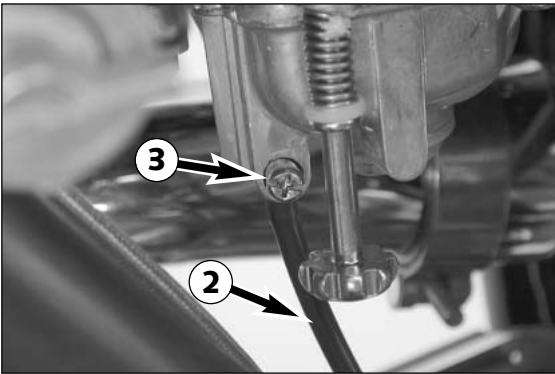

Draining of float chamber of the carburetor

Following every wet-cleaning procedure, the float chamber of the carburetor should be drained in order to remove any water that may have penetrated into it. Water in the float chamber leads to engine malfunction.

Wait until the engine is cold before commencing to perform the worksteps indicated below.

Close the fuel tap.

Put the end of the hose ❷ that leads downward behind the engine into an appropriate container.

Open the drain plug ❸, turning it counterclockwise a few times, and let the fuel drain from the float chamber.

Then tighten the drain plug and open the fuel tap.

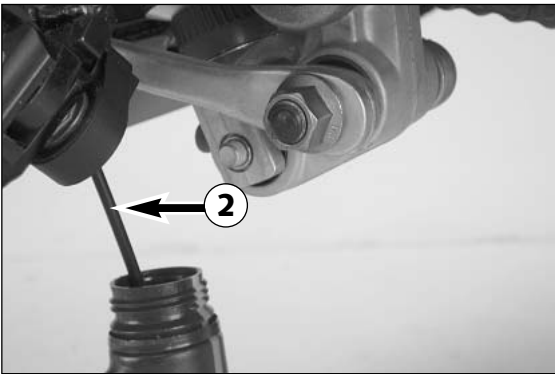

WARNING

FUEL IS EASILY FLAMMABLE AND TOXIC. WHEN HANDLING FUEL, BE SURE TO EXERCISE THE UTMOST CAUTION. NEVER PERFORM ANY WORK ON THE FUEL SYSTEM IN THE PROXIMITY OF OPEN FLAMES OR BURNING CIGARETTES. ALWAYS ALLOW THE ENGINE TO COOL OFF FIRST. IMMEDIATELY CLEAN UP ANY FUEL WHICH MAY HAVE BEEN SPILLED. MATERIALS SATURATED WITH FUEL ARE ALSO EASILY FLAMMABLE. IN CASE YOU INGESTED FUEL OR FUEL SPLASHED INTO YOUR EYES, CONSULT A DOCTOR IMMEDIATELY.

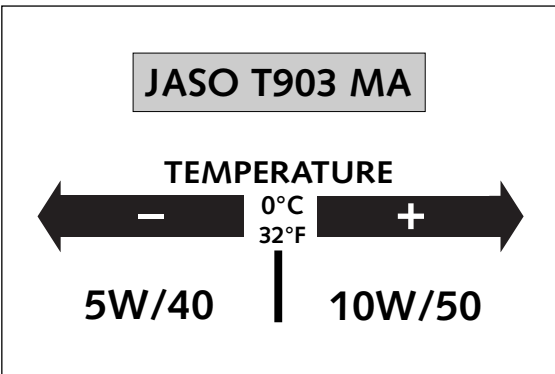

Engine oil

Automobile engine oil used to be used for four-stroke motorcycles before there were separate motorcycle specifications. Different technical developments made it necessary to have a separate specification for four-stroke motorcycles - the JASO T903 MA standard. Whereas car engines require long changing intervals, motorcycle engines require a higher power output at higher speeds. Most motorcycle engines also use the same oil to lubricate the transmission and the clutch. The JASO MA standard responds to these special requirements.

Only use fully synthetic engine oils that meet the JASO MA quality requirements (see information on the can).

KTM recommends Motorex Power Synt 4T in the 10W/50 viscosity (for temperatures over 0°C, 32°F) or 5W/40 (for temperatures under 0°C, 32°F).

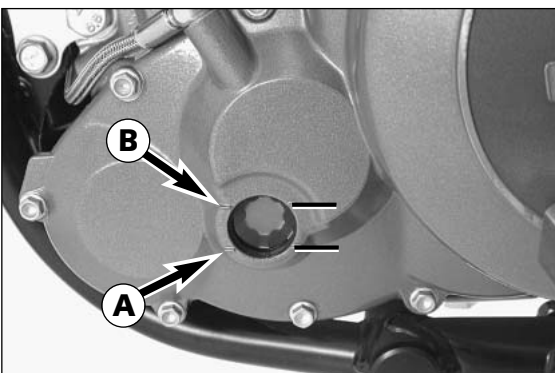

Checking the engine oil level

The engine oil level can be checked when the engine is cold or warm.

To check, place the motorcycle in an upright position on a level surface (center stand).

If the engine is cold, the oil level should be visible at the lower edge ❶ of the inspection glass.

If the engine is warm, the oil level should be visible at the upper edge ❷ of the inspection glass.

Add engine oil if necessary.

CAUTION

- INSUFFICIENT AMOUNTS OF OR LOW-GRADE ENGINE OIL LEAD TO PREMATURE WEAR IN THE ENGINE.
- DO NOT OVERFILL THE ENGINE CASE.

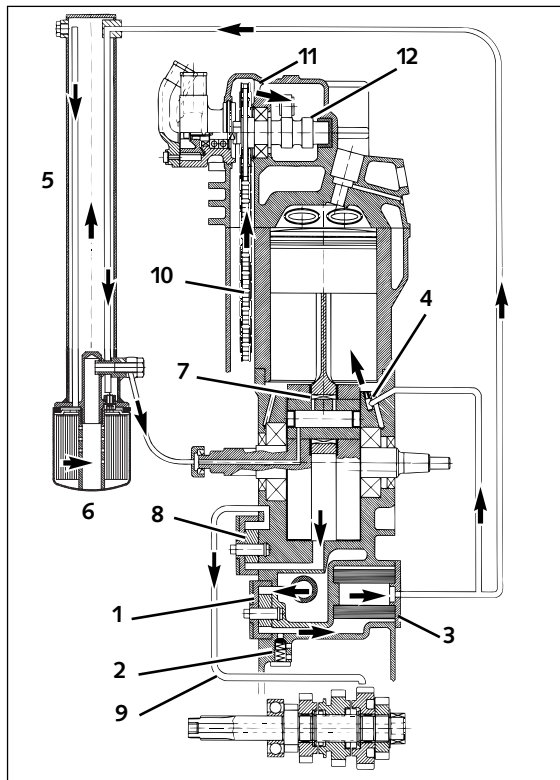

Oil circuit

The oil pump ① pumps the motor oil past the bypass valve ② and through the oil filter ③. Beyond the oil filter, one of the oil lines forks off to a jet ④ that injects motor oil to the piston pin bearing and the piston head. The second oil line leads the main oil flow to the frame breast pipe ⑤ where the motor oil is cooled off. Then the motor oil flows through the fine screen filter ⑥ that removes even the finest of contaminants from the motor oil. The cleansed motor oil is pumped via an oil line and the clutch cover into the crankshaft to the conrod bearing ⑦ and drains from there into the crank case. A additional oil pump ⑧ suctions the motor oil out of the crank case and pumps it through the oil canal ⑨ to the gear wheels of the 4th and 5th gears. The motor oil reaches the oil sump via the gear wheels. The timing chain ⑩ also dips into the oil sump and propels motor oil upwards to the cylinder head. The motor oil reaches the camshaft ⑪ and the valves through the bore ⑫.

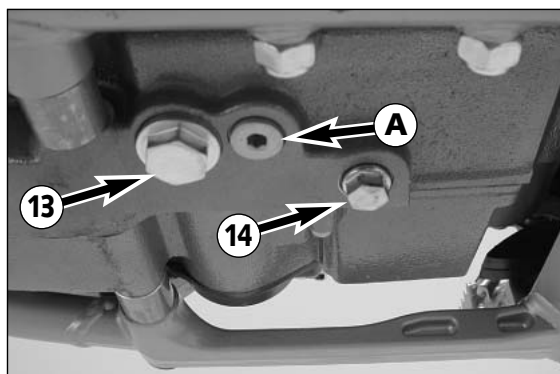

Oil and screen filter change, bleeding of the oil system *

Note: The frame breast pipe is integrated into the oil circuit for the sake of more effectively cooling the motor oil. It is thus important when changing the oil to also remove the fine screen filter, to drain the motor oil from the breast pipe and to de-aerate the oil system.

If the oil system is not bled at all or bled insufficiently, the bearings of the engine will not get enough lubrication, which in turn may result in engine failure.

Therefore, we recommend that you have the engine oil changed by your authorized KTM mechanic. During the guaranty period, the oil change must be performed by an authorized KTM mechanic. Otherwise, the guarantee will become void.

The engine oil change is to be carried out when the engine is still warm.

⚠ **WARNING** ⚠

AN ENGINE HAVING BEEN RUN WARM, AND THE ENGINE OIL IN IT IS VERY HOT - DO NOT BURN YOURSELF.

Place the motorcycle on a horizontal surface. Remove the two plugs ⑬ and ⑭, and drain oil into a container.

! **CAUTION** !

PLUG A MUST NOT BE REMOVED, THIS IS PART OF THE BY-PASS VALVE.

Remove the screws and the cover ⑮. Loosen the fine screen filter ⑯ with an oil filter wrench and then screw it off by hand.

The screw ⑰ must be removed to allow the motor oil to flow out of the frame breast pipe.

Clean the plugs thoroughly with petroleum and compressed air in order to remove any metal filings. After the oil has drained completely, clean the sealing areas and remount the plugs together with their gaskets. Tighten plug ⑮ with 30 Nm and plug ⑭ with 20 Nm. Tighten the screw ⑰ with 10 Nm. Clean sealing surfaces on the frame breast pipe ⑱, fill new fine screen filter with engine oil, and oil rubber gasket ⑲. Replace fine screen filter and screw it back in place, your bare hand will do.

Remove screw connection on the clutch cover, fill with 1,3 litre engine oil and attach plug again.

! **CAUTION** !

- USE ONLY ORIGINAL KTM FINE SCREEN FILTERS. USING ANOTHER FILTER BRAND CAN RESULT IN DAMAGE TO THE ENGINE.
- IF THE ENGINE OIL HAS BEEN DRAINED FROM THE FRONT PIPE OF THE FRAME, YOU MUST BLEED THE OIL SYSTEM !

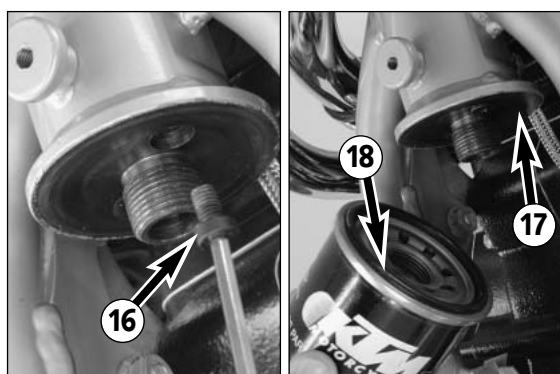



BLEEDING THE OIL SYSTEM

To facilitate bleeding of the oil system, we have added a hose connection piece and a plastic hose to the set of tools. Take an empty oil can (1 liter) and drill a 7 mm-diameter hole into the lid. Screw the hose connection piece into the lid from the outside, and secure it from the inside with the M8 hexagon nut. Slip the plastic hose onto the hose connection piece, and you will have your filling tool.

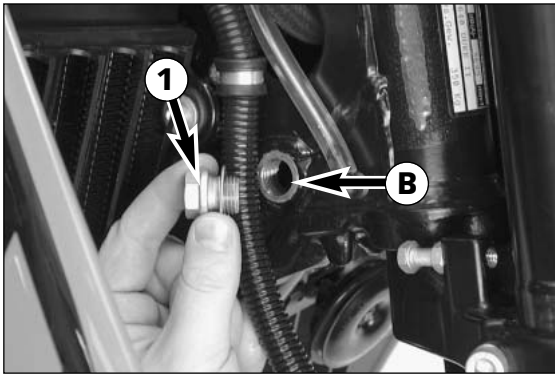

Fill 0.6 liters of engine oil into the can and remove the plug ① next to the steering head. Introduce the plastic hose into the vent hole ②, and fill 0.6 liters of engine oil into the frame's front tube. Remove plastic hose, start engine, and let it idle (approx. 20 seconds) until oil escapes at the hole ③. As soon as oil starts to escape, turn off the engine, and mount the plug together with the gasket.

Allow the engine to warm up, check the engine oil level and correct if necessary. Afterwards, check the entire oil system for leakage. Mount the engine guard.

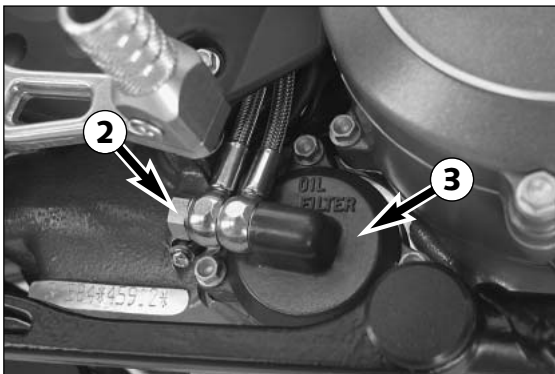

Changing oil filter *

Replace the oil filter when changing the engine oil. Press the foot brake pedal and place a screwdriver or similar between foot brake pedal and stopper roll so that the oil filter cover is more accessible. Remove banjo bolt ② and the three screws. Remove oil filter cover ③ and oil filter. Clean the filter case, oil filter cover and sealing areas. Make sure the oil duct in the oil filter cover is not clogged.

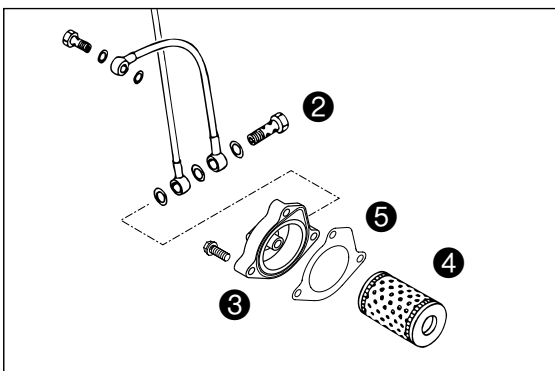

Place the new oil filter ④ on the connection in the oil filter cover and mount together with a new seal ⑤. Tighten the 3 screws in the filter cover to 5 Nm (4 ft.lb). Tighten the hollow screw with seals and tighten to 15 Nm (11 ft.lb).

Finally, start the engine and check the oil system for leakage.

TROUBLE SHOOTING

If you let the specified maintenance work on your motorcycle be carried out, disturbances can hardly be expected. Should an error occur nevertheless, we advise you to use the trouble shooting chart in order to find the cause of error. We would like to point out that many operations cannot be performed by oneself. In case of uncertainty, please contact a KTM-dealer.

TROUBLE	CAUSE	REMEDY
Engine doesn't crank.	Operating error	Turn on the ignition, switch the gear to neutral and switch the emergency OFF switch on.
	Discharged battery.	Recharge the battery and investigate the causes for discharging; contact a KTM dealer.
	Defect ignition lock or emergency OFF switch	Check ignition lock and emergency OFF switch, contact a KTM dealer.
The engine doesn't crank. The neutral indicator lamp doesn't light up.	Blown fuse safe-starting system.	Replace fuse (1).
	Blown main fuse.	Remove seat and replace the main fuse. If fuse blows again contact a KTM dealer.
The engine cranks only with pulled clutch lever	Defect safe-starting system.	Contact a KTM dealer.
Engine cranks with gear engaged.	Defect safe-starting system.	Contact a KTM dealer.
Engine cranks but doesn't start.	Operating error	Open fuel tap, tank fuel, you did not use choke i.e. the warm-start device. Pay attention to starting off information (see driving instructions).
	The motorcycle has been out of operation for a longer period of time. Therefore old fuel has accumulated in the float chamber	The easily inflammable components of the new fuels evaporate during longer periods of standstill. When the motorcycle has been out of operation for more than a week, it is therefore recommended to drain the old fuel from the float chamber. The engine will immediately start off when the float chamber is filled with new fuel.
	Fuel supply interrupted	Loosen fuel hose at carburettor, lead into a basin and open fuel tap – if fuel leaks out, the carburetor might need cleaning – if no fuel leaks out, check tank ventilation, i.e. clean fuel tap
	Flooded engine	Fully open the throttle when starting or exchange the spark plug, respectively
	Sooty or wet spark plug	Clean and dry the spark plug or exchange it, respectively
	Electrode gap too large	Adjust spark plug electrode gap to 0,9 mm
	Spark plug connector or spark plug faulty	Dismount spark plug, connect ignition cable, hold to ground (blank place on engine) and actuate starter, a strong spark must be produced at the spark plug – If no spark is created exchange the spark plug. – If the new spark plug doesn't produce a spark either, disconnect the spark plug connector from the ignition cable, hold it a distance of approx. 5 mm from ground and start. – If a spark now occurs, replace spark plug cap – If no spark is produced, control ignition system
	The plug connection of the CDI-unit, the pulse generator or the ignition coil has oxydized	Remove the seat and the fuel tank. Clean the plug connection and treat it with contact spray
Water in carburetor or jets blocked	Dismount and clean carburetor	

TROUBLE	CAUSE	REMEDY
Engine fails to idle	<p>Glogged idling jet</p> <p>Oncorrect adjustment of adjusting screws on carburetor</p> <p>Defective spark plug</p> <p>Defective ignition system</p>	<p>Disassemble carburetor and clean jets</p> <p>Have carburetor adjusted</p> <p>Replace spark plug</p> <p>Have ignition system checked</p>
Engine does not rev high	<p>Carburetor fuel level too high because</p> <p>Float needle is dirty or worn out</p> <p>Float leaks</p> <p>The cold starting system is permanently activated due to a lack of play in the choke cable.</p> <p>Defective membrane of slide</p> <p>Carburetor leaking</p> <p>Loose carburettor jets</p> <p>Electronic ignition timing faulty</p>	<p>Dismount carburetor and check if worn out</p> <p>Replace float needle</p> <p>Replace float</p> <p>Adjust choke cable.</p> <p>Replace membrane</p> <p>Check vacuum hose and venting hoses of carburetor for correct position (no kinks)</p> <p>Tighten jets</p> <p>Have ignition system checked</p>
Engine will not reach full power	<p>Fuel supply partially interrupted or carburetor dirty</p> <p>Float leaks</p> <p>Defective membrane of slide</p> <p>Carburetor leaking</p> <p>Air filter very dirty</p> <p>Valve clearance too small</p> <p>Loss of compression because hand decompressor has no play</p> <p>Electronic ignition timing faulty</p>	<p>Clean and check fuel system as well as carburetor</p> <p>Replace the float</p> <p>Replace membrane</p> <p>Check vacuum hose and venting hoses of carburetor for correct position (no kinks)</p> <p>Clean or replace air filter, contact a KTM dealer</p> <p>Have valve clearance adjusted</p> <p>Check setting of the hand decompression cable</p> <p>Have ignition system checked</p>
Engine overheats	<p>Insufficient cooling liquid</p> <p>Radiator fins are extremely dirty</p> <p>Foam forms in cooling system</p> <p>Bent radiator hose</p> <p>Thermostat defective</p> <p>Blown fan fuse</p> <p>Defect thermostwitch</p> <p>Fan defective</p>	<p>Refill cooling liquid (see maintenance work), check cooling system for leaks</p> <p>Clean radiator with water jet</p> <p>Replace cooling liquid, use antifreezer with brand name</p> <p>Shorten or replace cooling hose</p> <p>Remove and check thermostat (opening temperature 70°C (158°F) or replace it, contact a KTM dealer</p> <p>Replace fuse and check if fan operates properly (see below)</p> <p>Contact a KTM dealer</p> <p>Check if fan operates properly. To do this, start the engine, then bypass the connections to the thermostwitch (bottom right radiator), contact a KTM dealer</p>

TROUBLE	CAUSE	REMEDY
High oil consumption	Buckling gear ventilation hose Engine oil level too high Engine oil too thin (viscosity)	Readjust or replace ventilation hose Check engine oil level when the engine is warm; correct if necessary Use thicker engine oil; see chapter „Engine oil“
Headlight and parking light fail	Blown fuse	Replace fuse (3).
Flasher lights, brake light, fan and horn fail	Blown fuse	Replace fuse (2).
The NEUTRAL lamp is not on even though the gear is in NEUTRAL	Defect indicator lamp. Defect neutral switch. Loose connections, defect cable.	Replace bulb Connect cable to ground; neutral switch must be replaced if indicator lamp lights up. Check connections and cables.
The battery is discharged	The ignition (power consumer) hasn't been switched off The battery isn't charged by the generator because	Recharge the battery according to the relevant instructions. Remove seat and tank and check voltage regulator connections; voltage regulator and generator should be checked by a KTM dealer.

CLEANING

Clean your motorcycle regularly in order to keep its painted finish looking shiny and new.

The best manner would be to use warm water that has been mixed with a normal trade washing detergent and a sponge. The hard dirt can be removed before with the help of a soft water jet.

!

CAUTION

!

NEVER CLEAN YOUR MOTORCYCLE WITH A HIGH-PRESSURED CLEANER OR A HIGH-PRESSURED WATER JET. THE WATER COULD OTHERWISE RUN INTO THE ELECTRICAL COMPONENTS, CONNECTORS, SHEATHED CABLES, BEARINGS, CARBURETOR, ETC. AND CAUSE DISTURBINGS OR LEAD TO A PREMATURE DESTRUCTION OF THESE PARTS.

- You should use normal trade-mark detergents to clean the engine. Strongly dirtied parts should be cleaned additionally with the help of a paint brush.
- Before cleaning with water, plug the exhaust pipe to prevent water ingress.
- After the motorcycle has been rinsed with a soft water jet, it should be dried by air pressure and a cloth. Then take a short drive until the engine has reached the working temperature and also apply the brakes. Due to the heat, the water also evaporates at the unapproachable parts of the engine and the brakes.
- Slide back the protective covers on the handlebar-mounted instruments so that any water that may have seeped into this part of the motorcycle is allowed to evaporate.
- After the motorcycle has cooled down, oil and grease all sliding and pivot points. Treat the chain with a chain spray too.
- Finally all painted parts should be treated with a gentle paint cleaner.
- To prevent failures in the electric system, you should treat the ignition lock, the emergency off switch, light switch and the socket connectors with contact spray.

CONSERVATION FOR WINTER OPERATION

In the event that the motorcycle is also used in winter and on roads where one has to expect salt spraying, you will have to take precautions against the aggressive road salt.

- clean motorcycle thoroughly and let it dry after each ride
- treat engine, carburetor, swing arm, and all other bare or galvanized parts (except for brake discs) with a wax-based anti-corrosion agent.

⚠

WARNING

⚠

KEEP THE ANTI-CORROSION AGENT FROM GETTING INTO CONTACT WITH THE BRAKE DISCS, FOR OTHERWISE THIS WILL SIGNIFICANTLY REDUCE THE BRAKING POWER.

!

CAUTION

!

AFTER RIDES ON SALTED ROADS, CLEAN MOTORCYCLE THOROUGHLY WITH COLD WATER AND LET IT DRY WELL!

STORAGE

Should you desire to make a pause over a longer space of time, please observe the following instructions:

- Clean motorcycle thoroughly (see chapter: CLEANING)
- Change engine oil, oil filter and fine screen filter (old engine oil contains aggressive contaminants).
- Check antifreeze and amount of cooling liquid.
- Warm up the engine once again, close the fuel tap and wait until the engine dies. Then open the drain plug from the float chamber to remove the remaining fuel.
- Remove spark plug and fill in approx. 5 cc of engine oil into the cylinder through the opening. Actuate kick-starter 10 times in order to distribute the oil onto the cylinder walls and mount the spark plug.
- Set piston to compression so that the valves will be closed (slowly operate the kickstarter until you can hear the automatic decompressor click (release))
- Let fuel flow out of tank into an appropriate container.
- Correct tire pressure.
- Lubricate pivot points of the control levers, footrests, etc. as well as the chain.
- Servicing the shock absorber linkage and swing arm bearings.
- Remove and charge battery (see chapter: BATTERY).
- The storage place should be dry and not subject to excessive temperature fluctuations.
- Cover the motorcycle with an air permeated tarpaulin or blanket. Do not use non air permeable materials as any humidity may not be able to escape and could cause corrosion.

!

CAUTION

!

DO NOT LET THE ENGINE RUN FOR SHORT PERIODS OF TIME WHEN THE MOTORCYCLE IS KEPT IN STORAGE. SINCE IN THIS CASE THE ENGINE WOULD NOT GET WARM ENOUGH, THE STEAM PRODUCED DURING THE COMBUSTION PROCESS WOULD CONDENSE AND CAUSE RUSTING ON CRANKSHAFT, MAIN BEARING, AND EXHAUST SYSTEM.

RE-INITIATION AFTER TIME OF STORAGE:

- Mount the charged battery (match polarity).
- Fill up tank with fresh fuel and turn the fuel tap to the ON position.
- Check motorcycle as before each start.
- Take a short, careful test ride first.

NOTE: Before you put your motorcycle away for the winter, you have to check all parts for their function and wear. Should any service jobs, repairs, or any refitting be necessary, you should have them carried out during the off-season (lower workload at mechanics' shops). This way, you can avoid the long waiting times at your mechanic at the beginning of the next biking season.

TECHNICAL DATA – ENGINE 640 DUKE II 2004

Type	640 LC4
Design	Liquid-cooled single cylinder 4-stroke engine with balancer shaft and electric starter
Displacement	625 ccm
Bore / Stroke	101 / 78 mm
Ratio	11.7 : 1
Fuel	unleaded premium gasoline with a least RON 95
Valve timing	4 valves over rocker arm and 1 overhead camshaft, camshaft drive through single chain
Camshaft	549/1
Valve diameter	Intake: 36 mm Exhaust: 32 mm
Valve clearance cold	Intake: 0.15 mm Exhaust: 0.15 mm
Crank shaft bearing	2 cylinder roller bearing
Connecting rod bearing	needle bearing
Top end bearing	bronze bushing
Piston	forged aluminium alloy
Piston rings	1 compression ring, 1 taper face ring, 1 oil scraper ring
Engine lubrication	2 Eaton-Oilpumps
Quantity of engine oil	see table #
Engine oil	2.1 liters including frame
Primary ratio	straight geared spur wheels 31 : 79 teeth
Clutch	multi-disc clutch in oil bath
Transmission	5-speed claw shifted
Gear ratio	1st 14:35 2nd 15:24 3rd 18:21 4th 20:19 5th 22:18
Ignition system	contactless DC- CDI ignition with digital advanced system type KOKUSAN
Ignition timing	adjustment to max. 38° BTDC at 6000 rpm
Generator	12V 200W
Spark plug	NGK DCPR 8E
Spark plug gap	0.9 mm
Cooling system	liquid cooled, permanent rotation of cooling liquid through mechanically driven water pump
Cooling liquid	1 liter, 40% antifreeze, 60% water, at least -25° C (-13° F)
Starting equipment	electric starter, kick starter

BASIC CARBURETOR SETTING	
	640 DUKE 40 kW
Carburetor	BST40-258
Main jet	145
Needle jet	689 X-6
Idling jet	45
Jet needle	6G5
Needle position from top	3 rd
Mixture.adju. screw open	2.25 turn

#

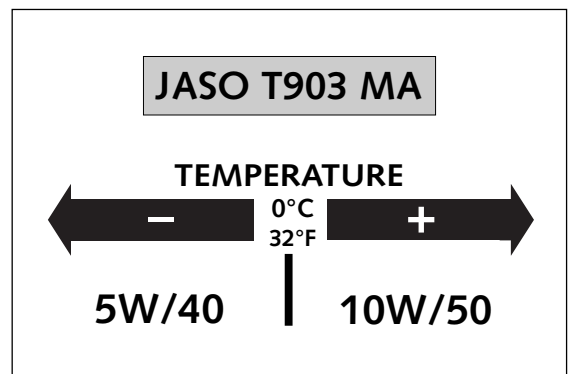

Engine oil

Only use fully synthetic engine oils that meet the JASO MA quality requirements (see information on the can).

KTM recommends Motorex Power Synt 4T in the 10W/50 viscosity (for temperatures over 0°C, 32°F) or 5W/40 (for temperatures under 0°C, 32°F).

TECHNICAL SPECIFICATIONS - CHASSIS 640 DUKE II 2004

Frame	Central chrome-moly-steel frame
Fork	type..... WP 43 ROMA 1418Y755 wheel travel..... 140 mm (5.5 in) standard adjustment compression driver only = 14, with passenger = 14 standard adjustment rebound driver only = 16, with passenger = 16 fork leg projection upper fork bridge 3 mm (0.12 in) oil capacity per fork leg appr. 400 ccm (24 cubic in) / SAE 5 air chamber lenght..... 100 mm (4 in)
Rear suspension	WP central shock absorber with PRO-LEVER linkage to rear- swing-arm with needle bearing
Shock absorber	type..... WP central shock absorber BAVP 4681 0118Y736 rear wheel travel 170 mm (6.7 in) standard adjustment compression driver only = 3, with passenger = 5 standard adjustment rebound driver only = 5, with passenger = 3 spring preload..... driver only = 23 mm (0.9 in),with passenger = 28 mm (1.1 in) spring type 70 - 260
Front brake	Disc brake with carbon-steel floated brake disc Ø 320 mm (12.6 in) and 4-piston brake caliper
Rear brake	Disc brake with carbon-steel brake disc Ø 220 mm (8.7 in) and single-piston brake caliper floated
Tyres	front: 120/70 R 17 58H - MTR 01 rear: 160/60 R 17 69H - MTR 02
Air pressure rider only	2.0 bar (29 psi) 2.2 bar (32 psi)
Air pressure with passenger	2.2 bar (32 psi) 2.4 bar (35 psi)
Fuel tank capacity	11,2 liters (2.96 US gallons), out of this 2.5 liters (0.62 US gallons) reserve
Final drive ratio	17 : 42
Chain	X-ring 5/8 x 1/4"
Lamps	low beam HB3 12V 60W (socket P20d) high beam..... HB3 12V 60W (socket P20d) parking light 12V 5W (socket W2,1x9,5d) speedometer, tachometer light 12V 1,7W (socket W2x4,6d) indicator lamp 12V 1,2W (socket W2x4,6d) stop and taillight 12V 21/5W (socket BaY15d) flasher..... 12V 10W (socket Ba15s)
Battery	maintenance-free battery 12V 8Ah
Steering angle	63.5°
Wheel base	1460 ± 15 mm (57.5 ± 0.6 in)
Seat high	900 mm (35.5 in)
Ground clearance	270 mm (10.6 in)
Dead weight without fuel	149 kg (329 lbs)
Max. permissible front axle load	150 kg (331 lbs)
Max. permissible rear axle load	200 kg (441 lbs)
Max. permissible laden weight	350 kg (773 lbs)

TIGHTENING TORQUES - CHASSIS			
Collar nut front axle	M17	40 Nm	(30ft.lb)
Collar nut rear axle	M20x1.5	80 Nm	(59ft.lb)
Shock absorber bolts top	M10	45 Nm	(33ft.lb)
Shock absorber bolts bottom	M10	45 Nm	(33ft.lb)
Collar screws brake disk front + rear	M6 (10.9)	Loctite 243 + 10Nm	(7ft.lb)
Bolts brake caliper front	M8	Loctite 243 + 25 Nm	(19ft.lb)
Allen head bolts brake caliper front	M10x1.25	Loctite 243 + 45 Nm	(33ft.lb)
Allen head bolts brake caliper support rear	M10	50 Nm	(37ft.lb)
Bearing bolt linkage arm/frame	M12	60 Nm	(44ft.lb)
Collar nuts rocker arm bolts	M14x1.5	100 Nm	(74ft.lb)
Engine mounting screw	M10	45 Nm	(33ft.lb)
Ball joint for push rod	M8	Loctite 243 + 25 Nm	(19ft.lb)
Sprocket bolts with nuts	M8	Loctite 243 + 35 Nm	(25ft.lb)
Collar nut swing arm bolt	M14x1.5	100 Nm	(74ft.lb)
Clamp bolts for top triple clamp	M8	20 Nm	(15ft.lb)
Clamp bolts for bottom triple clamp	M8	15 Nm	(11ft.lb)
Clamp bolts for fork stubs	M8	10 Nm	(7ft.lb)
Collar nut for eccentric chain adjuster	M10	40 Nm	(30ft.lb)
Bolts, handlebar clamp	M8	Loctite 243 + 20 Nm	(15ft.lb)
Allen head bolts handlebar support	M10	Loctite 243 + 40 Nm	(30ft.lb)
Bleeder screw oil reservoir frame	M16x1,5	25 Nm	(19ft.lb)
Other screws on chassis	M6	10 Nm	(7ft.lb)
	M8	25 Nm	(19ft.lb)
	M10	45 Nm	(33ft.lb)
Other collar nuts on chassis	M6	15 Nm	(11ft.lb)
	M8	30 Nm	(22ft.lb)
	M10	50 Nm	(37ft.lb)

HEAD WORD INDEX

	Page		Page
Activating the ignition curve for low-octane fuel	15	General information about KTM disc brakes	23
Adjust idling speed	34	General tips and warnings for starting the motorcycle	10
Battery	28	Hand brake lever	6
Bleeder screw front fork	19	Hand decompression lever	5
Braking	13	Headlight - replacing the bulbs	30
Chain maintenance	21	Headlight range adjustment	30
Chain wear	22	Ignition lock with 3 switch positions	6
Changing oil filter	36	Indicator lamps	6
Changing the basic position of the foot brake pedal	25	Instructions for initial operation	10
Changing the basic position of the handbrake lever	24	Kickstart instructions	13
Changing the original position of the clutch lever	33	Kickstarter	8
Changing the spring preload of the shock absorber	20	Lubricating the shock absorber linkage	20
Charging the battery	28	Main fuse	29
Chassis number	5	Maintaining chain tension eccentrics	22
Check the following before each start	11	Maintenance work on chassis and engine	18
Checking and adjusting the choke cable play	33	Oil and screen filter change, bleeding of the oil system	35
Checking and adjusting the steering head bearing	19	Oil circuit	35
Checking chain tension	21	Opening the headlight mask	29
Checking of brake fluid level - front brake	24	Operation instruments	5
Checking the adjustment of the hand decompression cable	33	Parking light - replacing the bulb	30
Checking the cooling liquid level	32	Periodic maintenance schedule	16
Checking the damping rubbers in the rear wheel	27	Rebound damping of fork	9
Checking the engine oil level	34	Rebound damping of shock absorber	9
Checking the front brake pads	24	Refilling the front brake fluid reservoir	24
Checking the oil level of the hydraulic clutch	33	Refilling the rear brake fluid reservoir	25
Checking the rear brake fluid level	25	Refueling	14
Checking the rear brake pads	25	Removing the seat	18
Checking the rubber ring of the rear shock absorber	20	Running in	10
Choke lever	5	Seat lock	9
Cleaning	40	Serial number locations	5
Cleaning of air filter	32	Shift lever	8
Cleaning the dust sleeves of the telescopic fork	19	Shifting/Riding	13
Clutch lever	5	Speedometer	6
Combination switch	7	Starter tip switch, emergency OFF tip switch, light switch	7
Compression damping of fork	9	Starting off	13
Compression damping of shock absorber	9	Starting when the engine is cold	12
Conservation for winter operation	40	Starting when the engine is warm	12
Cooling system	31	Stop light and tail light - replacing the bulb	31
Correcting chain tension	21	Stopping and parking	14
Dismounting and mounting the front wheel	26	Storage	40
Dismounting and mounting the rear wheel	26	Supporting strap for the passenger	18
Draining of float chamber of the carburetor	34	Tachometer	6
Driving instructions	11	Technical data – engine 640 Duke 2004	41
Engine number, engine type	5	Technical specifications - chassis 640 Duke 2004	42
Engine oil	34	Tires, air pressure	27
Filler cap	7	Tool kit	18
Flasher - replacing the bulbs	30	Trouble shooting	37
Foot brake pedal	8	What to do when the engine is „flooded“	12
Fuel tap	8	Wiring diagramm	appendix
Fuses	29		

ENGLISH	DEUTSCH	ITALIANO
Battery	Batterie	Batteria
Capacitor	Kondensator	Condensatore
CDI	CDI	CDI
Clutch switch	Kupplungsschalter	Interruttore frizione
Cooling fan	Lüftermotor	Motorino ventola
Diode	Diode	Diode
Driving light control lamp	Fernlichtkontrolle	Driving light control lamp
EPC	EPC	EPC
flasher control lamp	Blinkerkontrolllampe	Spia lampeggiatori
Flasher relay	Blinkerrelais	Relè indicatori
Flasher switch	Blinkerschalter	Deviatore indicatori di direzione
Front brake switch	vorderer Bremslichtschalter	Interruttore luce ant. di stop
Fuse box	Sicherungskasten	Scatola fusibili
Generator	Generator	Generatore
headlight	Scheinwerfer	faro
High / low beam switch	Auf-Abblendschalter	Commutatore abbagliante/anabbagliante
Horn	Hupe	Avvisatore acustico
Horn switch	Hornschalte	Interruttore avvisatore acustico
Idle control lamp	Leerlaufkontrolllampe	Indicat marcia folle
Ignition coil	Zündspule	Bobina d'accensione
Ignition switch	Zündschloss	Interruttore d'accensione
Left front flasher	linker vorderer Blinker	Indicatore ant. sx
Left rear flasher	linker hinterer Blinker	Indicatore post. sx
Licence plate lamp	Kennzeichenbeleuchtung	Luce targa
Light switch	Lichtschalter	Deviatore luci
Neutral switch	Leerlaufschalter	Interruttore folle
Octane selector	Oktanpassung	Adattamento anticipo agli ottano
Pick up	Impulsgeber	Pick up
Rear brake switch	Hinterer Bremslichtschalter	Interruttore luce post. di stop
Rear light / brakelight	Hinteres Begrenzungslicht / Bremslicht	Luce post. di posizione/stop
Regulator-rectifier	Regelgleichrichter	Regolatore-raddrizzatore
Right front flasher	Rechter vorderer Blinker	Indicatore ant. dx
Right rear flasher	Rechter hinterer Blinker	Indicatore post. dx
Sidestand switch	Seitenständerschalter	Interruttore cavalletto lat.
Speedometer	Tachometer	tachimetro
Start auxillary relay	Starterhilfsrelais	Relè ausiliario d'avviamento
Start relay	Startrelais	Relè d'avviamento
Start/stop switch	Start / stop schalter	Interruttore combinato d'avviamento e d'emergenza
Starter motor	Startermotor	Motorino d'avviamento
Tachometer	Drehzahlmesser	Contagiri
Temperature control lamp	Temperaturkontrolle	Controllo temperatura
Temperature sensor	Temperatursensor	Sensore temperatura
Temperature switch	Temperaturschalter	Interruttore termico
Throttle position sensor (TPS)	Vergaserpotentiometer	Potenziometro carburatore (sensore TPS)

Cable colours

bl: black
br: brown
bu: blue
gn: green
gr: grey
or: orange
pi: pink
pu: purple
re: red
wh: white
ye: yellow

Kabelfarben

bl: blau
br: braun
bu: blau
gn: grün
gr: grau
or: orange
pi: rosa
pu: violett
re: rot
wh: weiß
ye: gelb

Cavo colorato

bl: nero
br: marrone
bu: blu
gn: verde
gr: grigio
or: arancione
pi: rosa
pu: violetto
re: rosso
wh: bianco
ye: giallo

ENGLISH	FRANCAIS	ESPAÑOL
Battery	Batterie	Batería
capacitor	condensateur	condensador
CDI	CDI	CDI
Clutch switch	Contacteur d'embrayage	Interruptor de embrague
Cooling fan	Ventilateur	Motor del ventilador
Diode	Diode	Diodos
driving light control lamp	temoin de feu route	lampara aviso luces largas
EPC	EPC	EPC
flasher control lamp	temion de clignoteur	lampara aviso intermitentes
Flasher relay	Relais de clignotants	Relé de la luz intermitente
Flasher switch	Bouton de clignotants	Interruptor de la luz intermitente
Front brake switch	Contacteur de frein avant	Interruptor de luz del freno delantero
Fuse box	Boîte à fusibles	Caja de fusibles
Generator	Alternateur	Generador
headlight	phare	faro
High / low beam switch	Contacteur code/phare	Interruptor de encender/apagar la luz larga
Horn	Avertisseur sonore	Cláxon
Horn switch	Bouton d'avertisseur sonore	Interruptor del cláxon
idle control lamp	ind de point mort	indicador punto muerto
Ignition coil	Bobine d'allumage	Bobina de encendido
Ignition switch	Contacteur d'allumage	Cerradura de encendido
Left front flasher	Clignotant avant gauche	Luz intermitente izquierda delantera
Left rear flasher	Clignotant arrière gauche	Luz intermitente izquierda trasera
Licence plate lamp	Eclairage de plaque	Luz de la matrícula
Light switch	Contacteur d'éclairage	Interruptor de luces
Neutral switch	Contacteur de point mort	Interruptor de ralentí
Octane selector	Sélection pour l'indice d'octane	Ajuste de octano
Pick up	Capteur d'allumage	Generador de impulsos
Rear brake switch	Contacteur de frein arrière	Interruptor de luz del freno trasero
Rear light / brakelight	Feu rouge/stop	Luces de parqueo traseras /luces de freno
Regulator-rectifier	Régulateur/redresseur	Regulador rectificador
Right front flasher	Clignotant avant droit	Luz intermitente derecha delantera
Right rear flasher	Clignotant arrière droit	Luz intermitente derecha trasera
Sidestand switch	Contacteur de béquille latérale	Interruptor del caballete lateral
Speedometer	Compteur	Velocímetro
Start auxillary relay	Relais secondaire de démarreur	Relé auxiliaire del arranque
Start relay	Relais de démarreur	Relé del arranque
Start/stop switch	Contacteur start/stop	Interruptor arranque / parada
Starter motor	Démarreur	Motor de arranque eléctrico
Tachometer	Compte-tours	Cuenta revoluciones
temperature control lamp	temion de temperature	control temperatura
Temperature sensor	Sonde de température	Sensor de temperatura
Temperature switch	Contacteur de température	Interruptor de temperatura
Throttle position sensor (TPS)	Capteur d'ouverture de carburateur	Potenciómetro del carburador

Cable colours

bl: black
br: brown
bu: blue
gn: green
gr: grey
or: orange
pi: pink
pu: purple
re: red
wh: white
ye: yellow

Couleur de cable

bl: noir
br: brun
bu: bleu
gn: vert
gr: gris
or: orange
pi: rose
pu: violet
re: rouge
wh: blanc
ye: jaune

Color de cable

bl: negro
br: marron
bu: azul
gn: verde
gr: gris
or: naranja
pi: rosado
pu: violeta
re: rojo
wh: blanco
ye: amarillo



KTM Group Partner



KTM-Sportmotorcycle AG
A-5230 Mattighofen
www.ktm.at