

KTM

640 ADVENTURE **mit MIKUNI Vergaser '99** **with MIKUNI carburetor '99**

Ergänzungen zur BEDIENUNGSANLEITUNG

Art.Nr. 3.205.56

Supplement to the OWNER'S HANDBOOK

Art.Nr. 3.205.56



1.99

Art.Nr. 3.205.70

CHANGES AND SUPPLEMENTATION OF OWNERS HANDBOOK 3.205.56 FOR 640 ADVENTURE WITH MIKUNI CARBURETOR

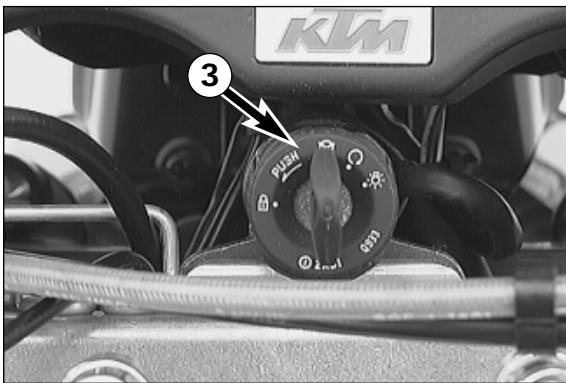

OPERATION INSTRUMENTS





Page 5:



Ignition lock with 4 switch positions

Switch positions of ignition lock ③:

-  Ignition off, light off (engine can't be started)
-  Ignition on, light off (engine can be started)
-  Ignition on, light on (engine can be started)



-  Ignition off, light off, handlebar blocked
To switch the ignition to position  turn the ignition key to position  and firmly press it into the lock. Turn the handlebar all the way to the left, then turn the ignition key to the left.

The ignition key can be withdrawn in position  and .

Page 9:

HOT START DEVICE - not applicable

Page 11:

HELMET LOCK - not applicable

Check the following before each start

When you start off, the motorcycle must be in a perfect technical condition. For safety reasons, you should make a habit of performing an overall check of your motorcycle before each start.

The following checks should be performed:

- 1 **CHECK THE OIL LEVEL**
Insufficient oil results in premature wear and consequently to engine damage.
- 2 **FUEL**
Check that there is sufficient fuel in the tank; when closing the filler cap, check that the tank venting hose is free of kinks.
- 3 **CHAIN**
A loose chain can fall off; an extremely worn chain can tear, and insufficient lubrication can result in unnecessary wear to the chain and rear sprockets.
- 4 **TIRES**
Check for damaged tires. Tires showing cuts or dents must be replaced. The tread depth must comply with the legal regulations. Also check the air pressure. Insufficient tread and incorrect air pressure reduce the driving performance.
- 5 **BRAKES**
Check correct functioning of the braking system. Check for sufficient brake fluid in the reservoir. The reservoirs have been designed in such a way that brake fluid does not need to be refilled even when the brake pads are worn. If the level of brake fluid falls below the minimum value, this indicates a leak in the braking system or completely worn out brake pads. Arrange for the braking system to be checked by a KTM specialist garage, as complete failure of the braking system can be expected.
Also check the state of the brake hoses and the thickness of the brake linings.
Check free travel at hand brake lever and foot brake pedal.
- 6 **CABLES**
Check correct setting and easy running of all control cables.
- 7 **COOLING LIQUID**
Check the level of cooling liquid when the engine is cold.
- 8 **ELECTRICAL SYSTEM**
Check headlight, parking light, tail light, brake light, flashers, indicator lamps and horn for faultless operation.
- 9 **LUGGAGE**
If you are taking luggage with you, check that this is securely fastened.



WARNING



- WEAR SUITABLE CLOTHING WHEN DRIVING A MOTORCYCLE. CLEVER KTM DRIVERS ALWAYS WEAR A HELMET, BOOTS, GLOVES AND A JACKET, REGARDLESS OF WHETHER DRIVING ALL DAY OR JUST FOR A SHORT TRIP. THE PROTECTIVE CLOTHING SHOULD BE BRIGHTLY COLOURED SO THAT OTHER USERS OF THE ROADS CAN SEE YOU AS EARLY AS POSSIBLE. YOUR PASSENGER OF COURSE WILL ALSO NEED SUITABLE PROTECTIVE CLOTHING.
- DO NOT DRIVE AFTER HAVING CONSUMED ALCOHOL.
- ONLY USE ACCESSORIES THAT HAVE BEEN RELEASED BY KTM. FOR EXAMPLE, FRONT PANELLING CAN IMPAIR THE DRIVING PROPERTIES OF THE MOTORCYCLE. CASES, EXTRA TANKS ETC. CAN ALTER THE WEIGHT DISTRIBUTION AND THUS ALSO IMPAIR THE VEHICLE'S DRIVING PROPERTIES.
- THE FRONT AND REAR WHEEL ARE ONLY ALLOWED TO BE TIRED WITH TIRES THAT HAVE THE SAME PROFILE TYPE.

Instructions for initial operation

- Verify that your KTM dealer performed the PREPARATION OF VEHICLE jobs (see Customer Service Manual).
- Read the entire manual carefully before your first drive.
- Familiarize yourself with the operating elements.
- Adjust the foot brake pedal to the most comfortable positions for you.
- Get used to handling the motorcycle on an empty car park, before starting on a longer drive. Also try to drive as slowly as possible and in standing position, to improve your feeling for the vehicle.

- Do not drive along off-road tracks which go beyond your ability and experience.
- Hold the handlebar with both hands and leave your feet on the foot rests while driving.
- Remove your foot from the foot brake pedal when you are not braking. If the foot brake pedal is not released the brake pads rub continuously and the braking system is overheated.
- You may only be accompanied by a passenger if your motorcycle is fitted and registered for such purposes. The passenger must hold tight to the brackets or hold on to the driver during the drive, with his feet on the passenger foot rests.
- Do not make any alterations to the motorcycle and always use ORIGINAL KTM SPARE PARTS. Spare parts from other manufacturers can impair the safety of the motorcycle.
- Motorcycles are sensitive to alterations in the distribution of weight. If you are taking luggage with you, this should be secured as close as possible to the middle of the vehicle; distribute the weight evenly between the front and rear wheel. Never exceed the maximum permissible laden weight and the axle weights. The maximum permissible laden weight is made up of the following components:
 - Motorcycle ready for operation and tank full
 - Luggage
 - Driver and passenger with protective clothing and helmet.
- Pay attention to running in instructions.

Running in

Even finely machined surfaces of engine parts have rougher surfaces than parts that slide on each other for a long time. Therefore, every engine must be run in. For this reason, do not demand maximum performance from the engine for the first 100 kilometers. The vehicle must be run in at low, changing performance level for the first 1000 KM (620 miles). The maximum number of revolutions per minute must not go exceed 4800 rpm. Do not accelerate the engine up to the red mark on the tachometer (8500 r.p.m.) during a running-in period of 1000 km. Exceeding the above listed rotations as well as pushing high rpm when the engine is cold will have an adverse effect on the life of your engine.

NOTE:

DURING THE STAGE OF RUNNING THE ENGINE IN, THAT IS THE FIRST 1000 KM (620 MILES), THE ENGINE OIL USED SHOULD BE OF A MINERAL OIL FORMULA. THIS ALSO APPLIES IF THE ENGINE HAS BEEN REPAIRED.

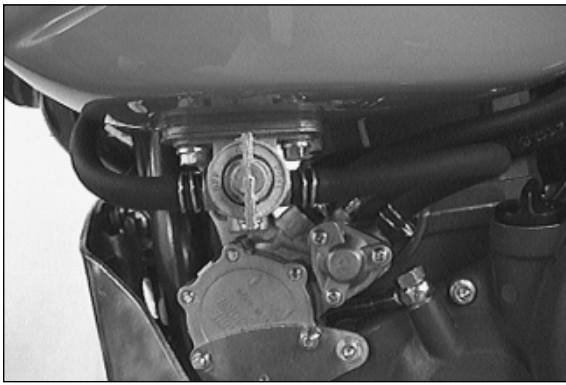

Starting when the engine is cold

- 1 Open the fuel tap.
- 2 Turn on the ignition (ignition key position: ○).
- 3 Switch the gear to neutral (green lamp ① lights).
- 4 Switch on the emergency off switch ② (symbol ☒ must be visible).
- 5 Operate the choke lever ③.
- 6 Operate the starter tip switch ⑤ without accelerating.
- 7 If the engine starts, push the choke lever back a little bit, as soon as the engine runs unevenly.
- 8 Swing up the centerstand



WARNING



DO NOT START THE ENGINE AND ALLOW IT TO IDLE IN A CLOSED ROOM. EXHAUST FUMES ARE POISONOUS AND CAN CAUSE LOSS OF CONSCIOUSNESS AND DEATH. ALWAYS PROVIDE ADEQUATE VENTILATION WHILE THE ENGINE IS RUNNING.



CAUTION



- MAXIMUM PERIOD FOR CONTINUOUS STARTING: 5 SECONDS. WAIT AT LEAST 5 SECONDS BEFORE TRYING AGAIN.
- DON'T RIDE YOUR MOTORCYCLE WITH FULL LOAD AND DON'T REV ENGINE WHEN COLD. BECAUSE THE PISTON IS WARMING UP FASTER THAN THE WATER COOLED CYLINDER, IT CAN CAUSE ENGINE DAMAGE. ALWAYS KEEP IN MIND THAT THE ENGINE SHOULD BE WARMED UP WITH SMALL LOAD AT MEDIUM R.P.M.

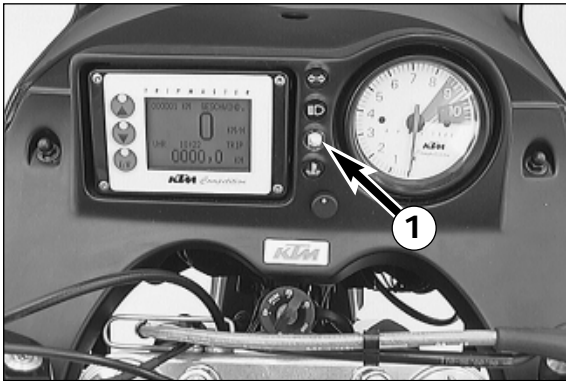

IF THE ENGINE DOES NOT CRANK WHEN YOU ACTUATE THE STARTER TIP SWITCH:

- the transmission is switched to idle
- Check if the emergency OFF switch is on
- Check if the ignition is on
- the headlight is on (ignition lock in position ☼).
 - If this is not the case, the battery is discharged
 - If the lights are on, proceed as described in the „Trouble-shooting“ section or contact a KTM dealer.

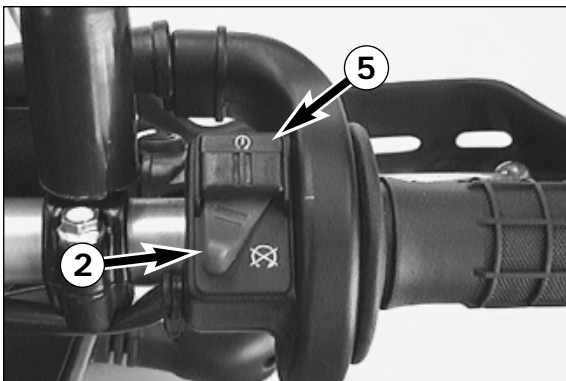

IF THE ENGINE CRANKS BUT DOES NOT START, WHEN YOU ACTUATE THE STARTER TIP SWITCH:

- Check if the fuel tap is open
- Check if the choke lever has been operated
- Check if sufficient fuel is in the tank
 - If this is not the case, refill the tank
 - if sufficient fuel is in the tank, proceed as described in the „Trouble-shooting“ section or contact a KTM dealer.

NOTE:

THIS MOTORCYCLE IS EQUIPPED WITH A SAFETY STARTER SYSTEM. THE ENGINE CAN ONLY BE STARTED WHEN THE TRANSMISSION IS SWITCHED TO IDLE OR THE CLUTCH LEVER IS PULLED, RESPECTIVELY.

THE ELECTRIC STARTER DOESN'T CRANK THE ENGINE WHEN THE STARTER TIP SWITCH IS OPERATED EVEN THOUGH SUFFICIENT ELECTRIC CURRENT IS AVAILABLE:

- Pull the hand decompression lever ⑥, start and release the lever.

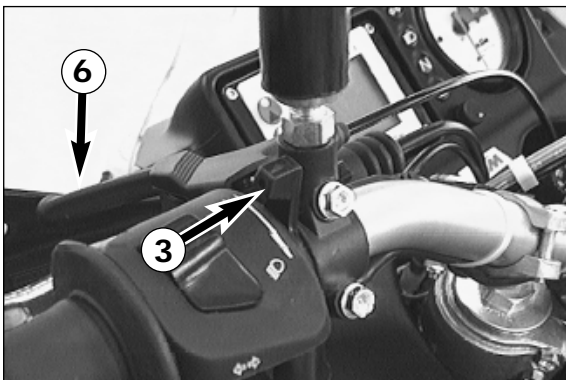

Starting when the engine is warm or hot

- 1 Open the fuel tap.
- 2 Turn on the ignition (ignition key position: ○).
- 3 Switch the gear to neutral (green lamp ① lights).
- 4 Switch on the emergency off switch ② (symbol ☒ must be visible).
- 5 Operate the starter switch ⑤ without accelerating.
- 6 Swing up the centerstand

What to do when the engine is „flooded“

The throttle must be fully opened when starting. If necessary change spark plug.

Kickstart instructions

Start as described above, then push the kickstarter hard all the way.

⚠️ WARNING ⚠️

WHEN STARTING THE ENGINE, PUT ON MOTORCYCLE BOOTS IN ORDER TO AVOID INJURIES. YOU MAY SLIP OFF THE KICKSTARTER, OR THE ENGINE MAY STRIKE BACK WHEN KICKING NOT VEHEMENTLY ENOUGH.

Starting off

Pull the clutch lever. Put the engine into first gear, slowly release the clutch lever and open throttle at the same time.

⚠️ WARNING ⚠️

BEFORE YOU START OFF, CHECK THAT THE CENTER STAND HAS BEEN SWUNG RIGHT UP TO THE TOP. IF THE STAND DRAGS ON THE GROUND, THE MOTORCYCLE CAN GO OUT OF CONTROL.

Shifting/Riding

You are now in first gear, referred to as the drive or uphill gear. Depending on the conditions (traffic, road gradient, etc.), you can shift to a higher gear. Close throttle, at the same time pull clutch lever and shift to the next higher gear. Let clutch lever go again and open throttle. If you turned on the choke, make sure you turn it off again as soon as engine is warm.

When you reach full speed through turning the throttle grip all the way, turn throttle back to 3/4; the speed hardly decreases although the engine will use less gas. Never open the throttle wider than the engine can handle. Excessive turning of the throttle grip will increase full consumption.

By shifting down, use the brakes if necessary and close throttle at the same time. Pull clutch lever and shift down to the next gear. Let clutch lever go slowly and open throttle or shift down again.

If the engine is killed f.ex. at a crossing, simply pull the clutch lever and start. It is not necessary to switch the gear to NEUTRAL.

⚠️ WARNING ⚠️

- OBSERVE THE TRAFFIC REGULATIONS, DRIVE DEFENSIVELY AND TRYING TO LOOK AHEAD AS FAR AS POSSIBLE SO THAT ANY HAZARDS CAN BE RECOGNIZED AS EARLY AS POSSIBLE.
- ADJUST YOUR DRIVING SPEED ACCORDING TO THE CONDITIONS AND YOUR DRIVING SKILLS.
- DRIVE CAREFULLY ON UNKNOWN ROADS
- NEVER LEAVE A HELMET ATTACHED TO HELMET LOCK WHEN RIDING YOUR MOTORCYCLE BECAUSE THE HELMET CAN GET CAUGHT IN THE REAR WHEEL AND THROW THE VEHICLE OUT OF CONTROL.
- REPLACE THE HELMET VISOR RESPECTIVELY GOGGLE GLASSES IN PLENTY OF TIME. WHEN LIGHT SHINES DIRECTLY ON SCRATCHED VISOR OR GOGGLES, YOU WILL BE PRACTICALLY BLIND.
- AFTER FALLING WITH THE MOTORCYCLE, CHECK ALL FUNCTIONS THOROUGHLY BEFORE STARTING UP OPERATIONS AGAIN.

! CAUTION !

- HIGH RPM RATES WHEN THE ENGINE IS COLD HAVE AN ADVERSE EFFECT ON THE LIFE OF YOUR ENGINE. WE RECOMMEND YOU RUN THE ENGINE IN A MODERATE RPM RANGE FOR A FEW MILES GIVING IT A CHANCE TO WARM UP. AFTER THAT NO FURTHER PRECAUTIONS IN THIS RESPECT NEED BE TAKEN.
- SHIFT TO THE NEXT HIGHER GEAR BY 8500 RPM AT THE LATEST.
- NEVER HAVE THE THROTTLE WIDE OPEN WHEN CHANGING DOWN TO A LOWER GEAR. THE ENGINE WILL OVERSPEED, DAMAGING THE VALVES. IN ADDITION, THE REAR WHEEL BLOCKS SO THAT THE MOTORCYCLE CAN EASILY GET OUT OF CONTROL.
- IF THE RED COOLING LIQUID TEMPERATURE LAMP LIGHTS UP WHILE YOU ARE DRIVING, THIS INDICATES COOLING SYSTEM TROUBLE. IMMEDIATELY STOP AND TURN OFF THE ENGINE. DRIVING WITH THE WARNING LAMP ON WILL CAUSE ENGINE DAMAGE.
 - PLACE A CLOTH ON THE RADIATOR CAP. OPEN THE CAP SLOWLY, SO THE EXCESS PRESSURE IN THE COOLING SYSTEM CAN ESCAPE. CAUTION SCALDING HAZARD! - AND CHECK THE COOLING LIQUID LEVEL.
 - DO NOT DRIVE ON, UNTIL THERE IS SUFFICIENT LIQUID IN THE COOLING SYSTEM. HOWEVER, CALL ON ONE OF KTM'S DEALERS AS SOON AS POSSIBLE IN ORDER TO HAVE THE DEFECT REMEDIATED.

- IF ANY ABNORMAL VIBRATIONS OCCUR WHILE DRIVING, CHECK THAT THE ENGINE FASTENING SCREWS ARE TIGHT.
- IN THE EVENT THAT, WHILE RIDING YOUR MOTORCYCLE, YOU NOTICE ANY UNUSUAL OPERATION-RELATED NOISE, STOP IMMEDIATELY, TURN THE ENGINE OFF, AND CONTACT AN AUTHORIZED KTM DEALER.

Braking

Close throttle and apply the hand and foot brakes at the same time. When driving on sandy, wet or slippery ground use mainly the rear wheel brake. Always brake with feeling, blocking wheels can cause you to skid or fall. Also change down to lower gears depending on your speed.

When driving downhill, use the braking effect of the engine. Change down one or two gears but do not overspeed the engine. In this way, you will not need to brake so much and the brakes will not overheat.

⚠️ WARNING ⚠️

WHEN YOU BRAKE, THE BRAKE DISCS, BRAKE PADS, BRAKE CALIPER AND BRAKE FLUID HEAT UP. THE HOTTER THESE PARTS GET, THE WEAKER THE BRAKING EFFECT. IN EXTREME CASES, THE ENTIRE BRAKING SYSTEM CAN FAIL.

Stopping and parking

Apply the brakes fully and put the engine into neutral. To stop the engine, switch off the ignition. Close fuel tap. Park on solid ground and lock the vehicle.

⚠️ WARNING ⚠️

- NEVER LEAVE YOUR MOTORCYCLE WITHOUT SUPERVISION AS LONG AS THE ENGINE IS RUNNING.
- MOTORCYCLE ENGINES PRODUCE A GREAT AMOUNT OF HEAT WHILE RUNNING. THE ENGINE RADIATORS, EXHAUST, EXHAUST SYSTEM, BRAKE DISCS, AND SHOCK ABSORBERS CAN BECOME VERY HOT. DO NOT TOUCH ANY OF THESE PARTS AFTER OPERATING THE MOTORCYCLE, AND TAKE CARE TO PARK IT WHERE PEDESTRIANS ARE NOT LIKELY TO TOUCH IT AND GET BURNED.
- NEVER PARK YOUR MOTORCYCLE IN PLACES WHERE THERE EXIST FIRE HAZARDS DUE TO DRY GRASS OR OTHER EASILY FLAMMABLE MATERIALS.

! CAUTION !

- PARK YOUR MOTORCYCLE, SO THAT IT RESTS STABLY ON THE SIDE-STAND (HARD GROUND, LEVEL SURFACE) AND CAN'T TIP OVER.
- THE FUEL TAPS MUST ALWAYS BE CLOSED WHEN PARKING THE MOTORCYCLE. OTHERWISE THE CARBURETOR CAN OVERFLOW AND FUEL COULD FLOW INTO THE ENGINE.
- ALWAYS TAKE OUT THE IGNITION KEY WHEN PARKING YOUR MOTORCYCLE SO THAT IT CANNOT BE USED BY UNAUTHORIZED PERSONS.



NOTE REGARDING THE CENTER STAND:

We advise the following procedure to place the motorcycle on the center stand as effortlessly as possible:

- a) press main stand to ground using foot,
- b) swing out kickstarter and pull motorcycle backwards at an angle as illustrated (see illustration).

Make sure that the ground is solid and that your motorcycle is standing securely.

!

CAUTION

!

BEFORE YOU START OFF, CHECK THAT THE CENTER STAND HAS BEEN SWUNG RIGHT UP TO THE TOP. IF THE STAND DRAGS ON THE GROUND, THE MOTORCYCLE CAN GO OUT OF CONTROL.

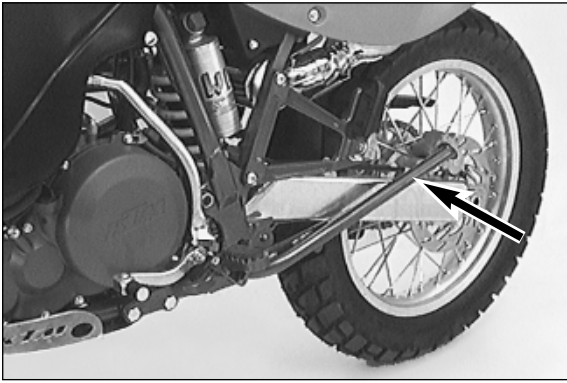

Page 26:

FUSE / FAN - not applicable

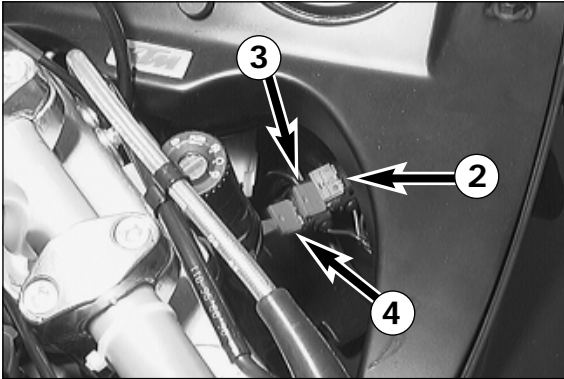

Fuses for individual power-consuming units

Additional fuses separately protecting different power-consuming units are mounted under the cockpit cover.

The fuses can be pulled out underneath the cockpit cover for replacement.

Fuse ② (10 Ampere) protects the following power-consuming units:

- headlight
- parking light
- tripmaster

Fuse ③ (10 Ampere) protects the following power-consuming units:

- flasher lights
- brake light - foot brake lever
- horn
- radiator fan

Fuse ④ (10 Ampere) protects the following power-consuming units:

- ignition
- starter system
- brake light - hand brake lever

Replace a blown fuse only with an equivalent one. If a new fuse that has just been set in gets blown again, you are strongly advised to have it inspected by a KTM dealer.

! CAUTION !

UNDER NO CIRCUMSTANCES IS A STRONGER FUSE ALLOWED TO BE SET IN OR A FUSE ALLOWED TO BE "REPAIRED". AN INEXPERT TREATMENT COULD DAMAGE THE WHOLE ELECTRICAL INSTALLATION!

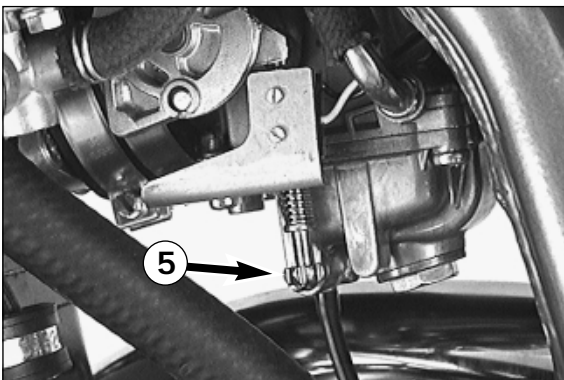

Adjust idling speed *

Use the adjusting screw ⑤ to adjust the basic position of the throttle valve and, thus, the idle speed. Turning in clockwise direction will increase the idling speed, turning in counterclockwise direction will reduce the idling speed. Normal idling speed 1400 - 1500 rpm.

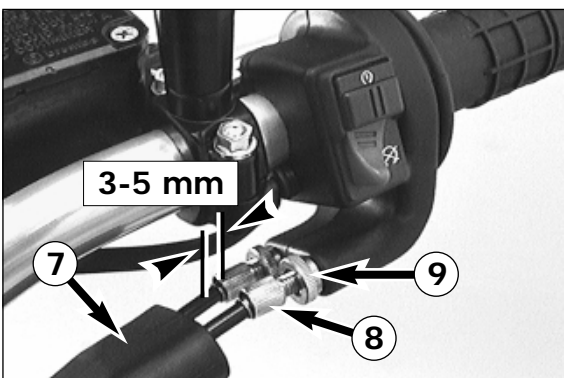

Adjusting the throttle cable *

A play of 3-5 mm must at any time be left in the throttle cables. To check the play of the throttle cables, first push back the protective cap ⑦ on the throttle twist grip. Now it should be possible to lift the outer sleeve of one of the two cables 3-5 mm off the adjusting screw ⑧ before resistance is felt. The play of the throttle cables can be adjusted, if necessary, using the two adjusting screws.

For this purpose, undo counter nut ⑨ and turn the adjusting screw until the desired play is achieved. Then tighten the counter nut and replace the protective cap.

TROUBLE SHOOTING

If you let the specified maintenance work on your motorcycle be carried out, disturbances can hardly be expected. Should an error occur nevertheless, we advise you to use the trouble shooting chart in order to find the cause of error. We would like to point out that many operations cannot be performed by oneself. In case of uncertainty, please contact a KTM-dealer.

TROUBLE	CAUSE	REMEDY
Engine doesn't crank.	Operating error	Turn on the ignition, switch the gear to neutral and switch the emergency OFF switch on.
	Discharged battery.	Recharge the battery and investigate the causes for discharging; contact a KTM dealer.
	Defect ignition lock or emergency OFF switch	Check ignition lock and emergency OFF switch, contact a KTM dealer.
The engine doesn't crank. The neutral indicator lamp doesn't light up.	Blown fuse safe-starting system.	Replace fuse (below the cockpit cover).
	Blown main fuse.	Remove seat and replace the main fuse. If fuse blows again contact a KTM dealer.
	Discharged battery.	Recharge the battery and investigate the causes for discharging; contact a KTM dealer.
The engine cranks only with pulled clutch lever	Defect safe-starting system.	Contact a KTM dealer.
Engine cranks with gear engaged.	Defect safe-starting system.	Contact a KTM dealer.
Engine cranks but doesn't start.	Operating error	Open fuel tap / emergency fuel tap, tank fuel, you did not use choke i.e. the warmstart device. Pay attention to starting off information (see driving instructions).
	The motorcycle has been out of operation for a longer period of time. Therefore old fuel has accumulated in the float chamber	The easily inflammable components of the new fuels evaporate during longer periods of standstill. When the motorcycle has been out of operation for more than a week, it is therefore recommended to drain the old fuel from the float chamber. The engine will immediately start off when the float chamber is filled with new fuel.
	Fuel supply interrupted	Disconnect the fuel hose coming from the fuel tap at the fuel pump. Put the end of the fuel hose into an appropriate container and open the fuel tap. <ul style="list-style-type: none"> - If fuel flows out, check the fuel pump. - If no fuel flows out, the fuel evaporation control system must be checked or the fuel tap must be cleaned, respectively.
	Defective fuel pump	Disconnect the fuel hose at the carburetor. Put the end of the fuel hose into an appropriate container, open the fuel taps and start the engine. <ul style="list-style-type: none"> - If fuel flows out, clean the carburetor. - If no fuel flows out <ul style="list-style-type: none"> - check the underpressure tube between the cylinder head and the fuel pump for leaks. - check if the fuel filter is clogged. - contact a KTM dealer.
	Flooded engine	Fully open the throttle when starting or exchange the spark plug, respectively
	Sooty or wet spark plug	Clean and dry the spark plug or exchange it, respectively
Electrode gap too large	Adjust spark plug elektrode gap to 0,7 mm	

TROUBLE	CAUSE	REMEDY
Engine cranks but doesn't start.	<p>Spark plug connector or spark plug faulty</p> <p>The plug connection of the CDI-unit, the pulse generator or the ignition coil has oxydized</p> <p>Water in carburetor or jets blocked</p> <p>Carburetor does not fit in properly at intake flange</p>	<p>Dismount spark plug, connect ignition cable, hold to ground (blank place on engine) and actuate starter, a strong spark must be produced at the spark plug</p> <ul style="list-style-type: none"> - If no spark is created exchange the spark plug. - If the new spark plug doesn't produce a spark either, disconnect the spark plug connector from the ignition cable, hold it a distance of approx. 5 mm from ground and start. - If a spark now occurs, replace spark plug cap - If no spark is produced, control ignition system <p>Remove the seat, the right side cover and the fuel tank. Clean the plug connection and treat it with contact spray</p> <p>Dismount and clean carburetor</p> <p>Check if carburetor is fitted in correctly</p>
Engine fails to idle	<p>Glogged idling jet</p> <p>Oncorrect adjustment of adjusting screws on carburetor</p> <p>Defective spark plug</p> <p>Defective ignition system</p>	<p>Disassemble carburetor and clean jets</p> <p>Have carburetor adjusted</p> <p>Replace spark plug</p> <p>Have ignition system checked</p>
Engine does not rev high	<p>Carburetor fuel level too high because</p> <p>Float needle is dirty or worn out</p> <p>Float leaks</p> <p>The cold starting system is permanently activated due to a lack of play in the choke cable.</p> <p>Defective membrane of slide</p> <p>Carburetor leaking</p> <p>Loose carburettor jets</p> <p>Electronic ignition timing faulty</p>	<p>Dismount carburetor and check if worn out</p> <p>Replace float needle</p> <p>Replace float</p> <p>Adjust choke cable.</p> <p>Replace membrane</p> <p>Check vacuum hose and venting hose of carburetor for correct position (no kinks)</p> <p>Tighten jets</p> <p>Have ignition system checked</p>
Engine will not reach full power	<p>Fuel supply partially interrupted or carburetor dirty</p> <p>Float leaks</p> <p>Defective membrane of slide</p> <p>Carburetor leaking</p> <p>Air filter very dirty</p> <p>Valve clearance to small</p> <p>Loss of compression because hand decompressor has no play</p> <p>Electronic ignition timing faulty</p>	<p>Clean and check fuel system as well as carburetor Have fuel pump checked.</p> <p>Replace the float</p> <p>Replace membrane</p> <p>Check vacuum hose and venting hose of carburetor for correct position (no kinks)</p> <p>Clean or replace air filter, contact a KTM dealer</p> <p>Have valve clearance adjusted</p> <p>Check setting of the hand decompression cable</p> <p>Have ignition system checked</p>

TROUBLE	CAUSE	REMEDY
Engine overheats	<p>Insufficient cooling liquid</p> <p>Radiator fins are extremely dirty</p> <p>Foam forms in cooling system</p> <p>Bent radiator hose</p> <p>Thermostat defective</p> <p>Blown fan fuse</p> <p>Defect thermoswitch</p> <p>Fan defective</p>	<p>Refill cooling liquid (see maintenance work), check cooling system for leaks</p> <p>Clean radiator with water jet</p> <p>Replace cooling liquid, use antifreezer with brand name</p> <p>Shorten or replace cooling hose</p> <p>Remove and check thermostat (opening temperature 70°C (158°F) or replace it, contact a KTM dealer</p> <p>Replace fuse and check if fan operates properly (see below)</p> <p>Contact a KTM dealer</p> <p>Check if fan operates properly. To do this, start the engine, then bypass the connections to the thermoswitch (bottom right radiator), contact a KTM dealer</p>
High oil consumption	<p>Buckling gear ventilation hose</p> <p>Engine oil level too high</p> <p>Engine oil too thin (viscosity)</p>	<p>Readjust or replace ventilation hose</p> <p>Check engine oil level when the engine is warm; correct if necessary</p> <p>Use thicker engine oil; see chapter „Engine oil“</p>
Electric system not operational	<p>Blown main fuse.</p> <p>Discharged battery.</p>	<p>Remove seat and replace the main fuse. If fuse blows again contact a KTM dealer.</p> <p>Recharge the battery and investigate the causes for discharging; contact a KTM dealer.</p>
All switched on lamps blown out	Voltage regulator faulty	Remove seat and check connections. Have voltage regulator checked
Headlight and parking light fail, no power on tripmaster	Blown fuse	Replace fuse (below the cockpit cover).
Flasher lights, brake light, fan and horn fail	Blown fuse	Replace fuse (below the cockpit cover).
The NEUTRAL lamp is not on even though the gear is in NEUTRAL	<p>Defect indicator lamp.</p> <p>Defect neutral switch.</p> <p>Loose connections, defect cable.</p>	<p>Replace indicator lamp</p> <p>Connect cable to ground; neutral switch must be replaced if indicator lamp lights up.</p> <p>Check connections and cables.</p>
The battery is discharged	<p>The ignition (power consumer) hasn't been switched off</p> <p>The battery isn't charged by the generator because</p>	<p>Recharge the battery according to the relevant instructions.</p> <p>Remove seat and check voltage regulator connections; voltage regulator and generator should be checked by a KTM dealer.</p>
<p>No values are visible in the Tripmaster display.</p> <p>No speed display.</p>	<p>The contrast potentiometer is set incorrectly.</p> <p>Defective sensor cable or oxidized socket connector.</p>	<p>Turn the contrast potentiometer until the display can be easily read.</p> <p>Check the sensor cable for damage and replace it if necessary. Remove the headlight mask and check the socket connector. Contact a KTM dealer.</p>
A time entry is requested by the Tripmaster every time the ignition is switched on.	The lithium battery in the device is empty.	Contact a KTM dealer.

BASIC CARBURETOR SETTING		
	640 Adventure 25 kW	640 Adventure 37 kW
Carburetor	BST40-225	BST40-225
Carburetor setting number	080298	080298
Main jet	142,5	142,5
Needle jet	689 X-6	689 X-6
Idling jet	45	45
Jet needle	6G5	6G5
Needle position from top	3 rd	3 rd
Mixture.adju. screw open	-	-
Throttle valve	-	-
Starting jet	-	-
Performance restrictor	slide stop 17 mm	-



320569

K T M - S P O R T M O T O R C Y C L E A G
A-5230 Mattighofen • Postfach 91 • Austria
Internet: <http://www.ktm.co.at>
FN 102019 d - Landesgericht Ried im Innkreis