

Additional instruments (roadbook;...)	Externe Instrumente	Strumenti supplementari	Accessoires	Instrumentos externos
Battery	Batterie	Batteria	Batterie	Bateria
Carb heater (Carburator heater element)	Vergaserheizelement	Resistore di riscaldamento carburatori	Éléments de réchauffage de carburateur	Elemento de calefacción del carburador
Clutch switch	Kupplungsschalter	Interruttore frizione	Contacteur d'embrayage	Interruptor de embrague
Cooling fan	Lüftermotor	Motorino ventola	Ventilateur	Motor del ventilador
Diode	Diode	Diode	Diode	Diodos
Flasher relay	Blinkerrelais	Relè indicatori	Relais de clignotants	Relé de la luz intermitente
Flasher switch	Blinkerschalter	Deviatore indicatori di direzione	Bouton de clignotants	Interruptor de la luz intermitente
Front brake switch	vorderer Bremslichtschalter	Interruttore luce ant. di stop	Contacteur de frein avant	Interruptor de luz del freno delantero
Fuel level sensor	Benzinstandgeber	Sensore livello benzina	Jauge à essence	Indicador del nivel de gasolina
Fuel pump	Kraftstoffpumpe	Pompa benzina	Pompe à essence	Bomba de gasolina
Fuel pump relay	Kraftstoffpumpenrelais	Relè pompa benzina	Relais de pompe à essence	Relé de la bomba de gasolina
Fuse box	Sicherungskasten	Scatola fusibili	Boîte à fusibles	Caja de fusibles
Gear sensor	Gangerkennung	Sensore marce	Contacteur de rapport de boîte engagé	Reconocimiento de marchas
Generator	Generator	Generatore	Alternateur	Generador
Headlight	Scheinwerfer	Faro anteriore	Phare	Faro
High / low beam switch	Auf-Abblendschalter	Commutatore abbagliante/anabbagliante	Contacteur code/phare	Interruptor de encender/apagar la luz larga
Horn	Hupe	Avvisatore acustico	Avertisseur sonore	Cláxon
Horn switch	Hornschalter	Interruttore avvisatore acustico	Bouton d'avertisseur sonore	Interruptor del cláxon
Ignition coil	Zündspule	Bobina d'accensione	Bobine d'allumage	Bobina de encendido
Ignition switch	Zündschloss	Interruttore d'accensione	Contacteur d'allumage	Cerradura de encendido
Left front flasher	linker vorderer Blinker	Indicatore ant. sx	Clignotant avant gauche	Luz intermitente izquierda delantera
Left rear flasher	linker hinterer Blinker	Indicatore post. sx	Clignotant arrière gauche	Luz intermitente izquierda trasera
Licence plate lamp	Kennzeichenbeleuchtung	Luce targa	Eclairage de plaque	Luz de la matrícula
Light switch	Lichtschalter	Deviatore luci	Contacteur d'éclairage	Interruptor de luces
Multi-func.-digital-speedometer	Multifunktionsdigitaltacho	Tachimetro digitale multifunzione	Ordinateur de bord	Velocimetro digital multifuncional
Neutral switch	Leerlaufschalter	Interruttore folle	Contacteur de point mort	Interruptor de ralenti
Oil pressure sensor	Öldruckschalter	Pressostato olio	Contacteur de pression d'huile	Interruptor de la presión del aceite
Pick up	Impulsgeber	Pick up	Capteur d'allumage	Generador de impulsos
Rear brake switch	hinterer Bremslichtschalter	Interruttore luce post. di stop	Contacteur de frein arrière	Interruptor de luz del freno trasero
Rear light / brakelight	hinteres Begrenzungslicht/ Bremslicht	Luce post. di posizione/stop	Feu rouge/stop	Luces de parque traseras /luces de freno
Regulator-rectifier	Regelgleichrichter	Regolatore-raddrizzatore	Régulateur/redresseur	Regulador rectificador
Right front flasher	rechter vorderer Blinker	Indicatore ant. dx	Clignotant avant droit	Luz intermitente derecha delantera
Right rear flasher	Rechter hinterer Blinker	Indicatore post. dx	Clignotant arrière droit	Luz intermitente derecha trasera
Sidestand switch	Seitenständerschalter	Interruttore cavalletto lat.	Contacteur de béquille latérale	Interruptor del caballete lateral
Speed sensor	Geschwindigkeitssensor	Sensore velocità	Capteur de vitesse	Sensor de velocidad
Start auxiliary relay	Starterhilfsrelais	Relè ausiliario d'avviamento	Relais secondaire de démarrage	Relé auxiliair del arranque
Start relay	Startrelais	Relè d'avviamento	Relais de démarrage	Relé del arranque
Start/stop switch	Start / stop schalter	Interruttore combinato d'avviamento e d'emergenza	Contacteur start/stop	Interruptor arranque / parada
Starter motor	Startermotor	Motorino d'avviamento	Démarrreur	Motor de arranque eléctrico
Temperature sensor	Temperatursensor	Sensore temperatura	Sonde de température	Sensor de temperatura
Temperature switch	Temperaturschalter	Interruttore termico	Contacteur de température	Interruptor de temperatura
Throttle position sensor (TPS)	Vergaserpotentiometer	Potenzionometro carburatori (sensore TPS)	Capteur d'ouverture de carburateur	Potenciómetro del carburador

Kabelfarben

bl: schwarz / **ye:** gelb
bu: blau / **gn:** grün
re: rot / **wh:** weiß
br: braun / **or:** orange
pi: rosa / **gr:** grau
pu: violett

Colori dei cavi

bl: nero / **ye:** giallo
bu: blu / **gn:** verde
re: rosso / **wh:** bianco
br: marrone / **or:** arancione
pi: viola / **gr:** grigio
pu: violetto



Couleur des fils

bl: noir / **ye:** jaune
bu: bleu / **gn:** vert
re: rouge / **wh:** blanc
br: marron / **or:** orange
pi: rose / **gr:** gris
pu: violet



Colores de cable

bl: negro / **ye:** amarillo
bu: azul / **gn:** verde
re: rojo / **wh:** blanco
br: marron / **or:** naranja
pi: rosa / **gr:** gris
pu: violeta



start switch

cable harness	or	bl-or
cable switch	bl-bu	bl
START 		
unpushed		

Stop switch

cable harness	re	or
cable switch	or	bl-wh
RUN 		
STOP		





ignition switch

	bl-or	r-w	re	r-w
ON 				
OFF				
LOCKED				



clutch switch

switch position	ye	br
pulled		
unpulled		





flasher switch

cable harness	or	pu	bl	gr	br
cable switch	gn-br	bu-re	bu-bl	pi	br-pi
TURN L 					
TURN R 					
OFF					





horn switch

cable harness	gr	br
cable switch	pi	br-pi
HORN 		
OFF		

light switch

cable harness	ye-br	wh	ye
cable switch	ye-wh	wh	re-ye
LIGHT OFF			
P. LIGHT 			
LIGHT 			

high/low beam switch

cable harness	bu	gn	ye-br
cable switch	wh	ye	gn-re
LO 			
HI 			

brake switch

cable harness	gn-wh	ye-bu
cable switch	bl	bl
pushed		
unpushed		

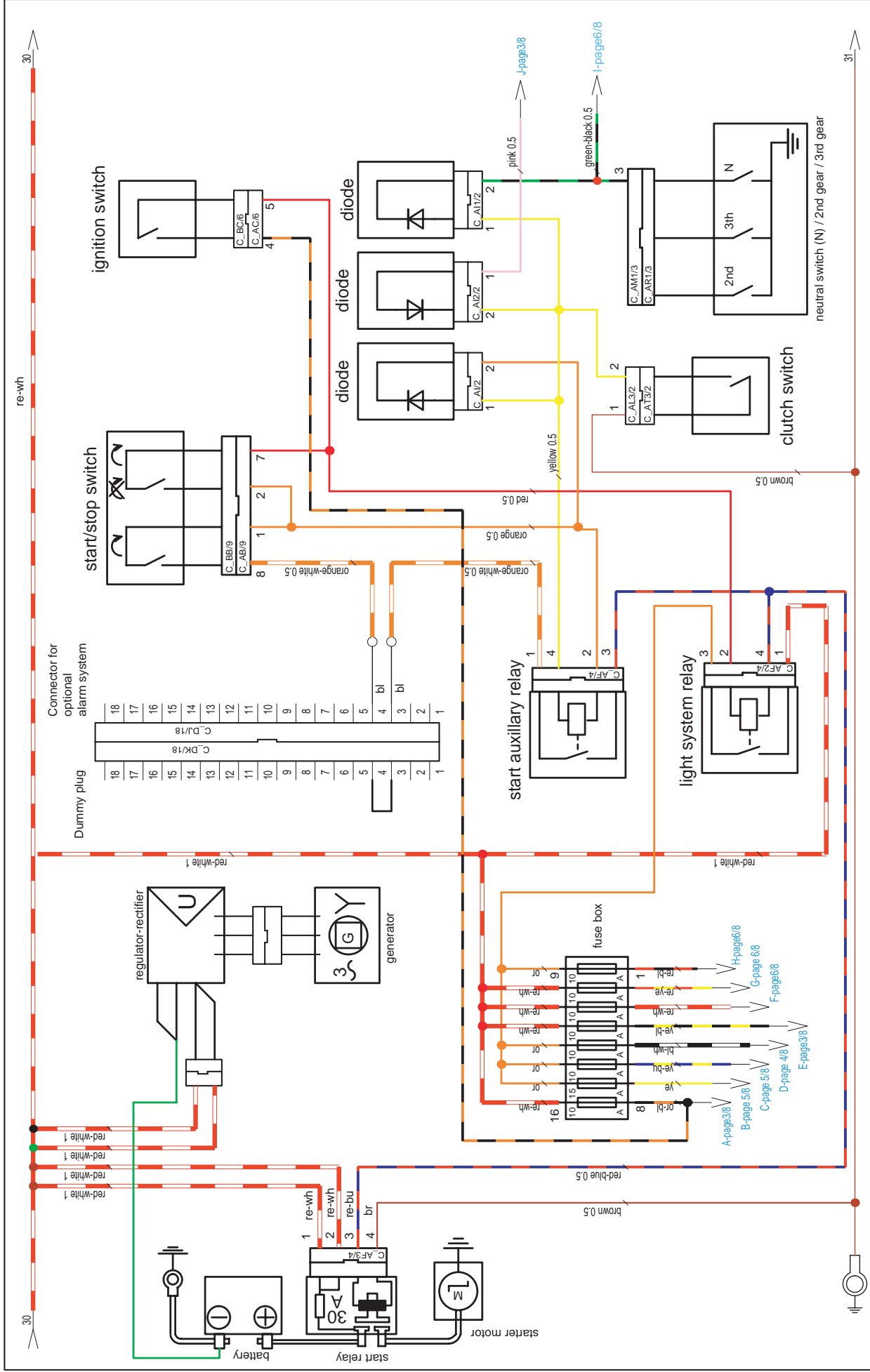

LC8 SM 950

start system

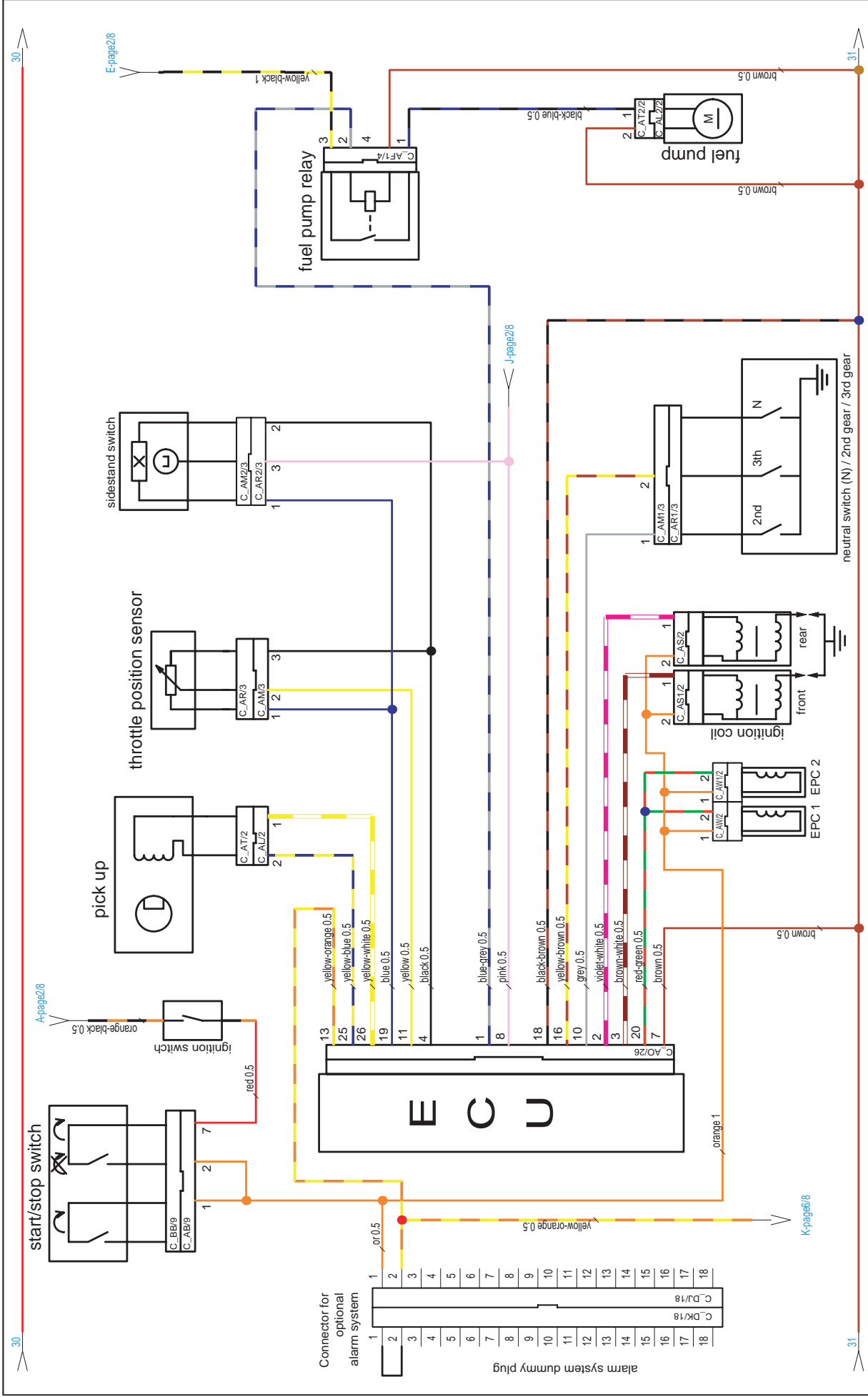

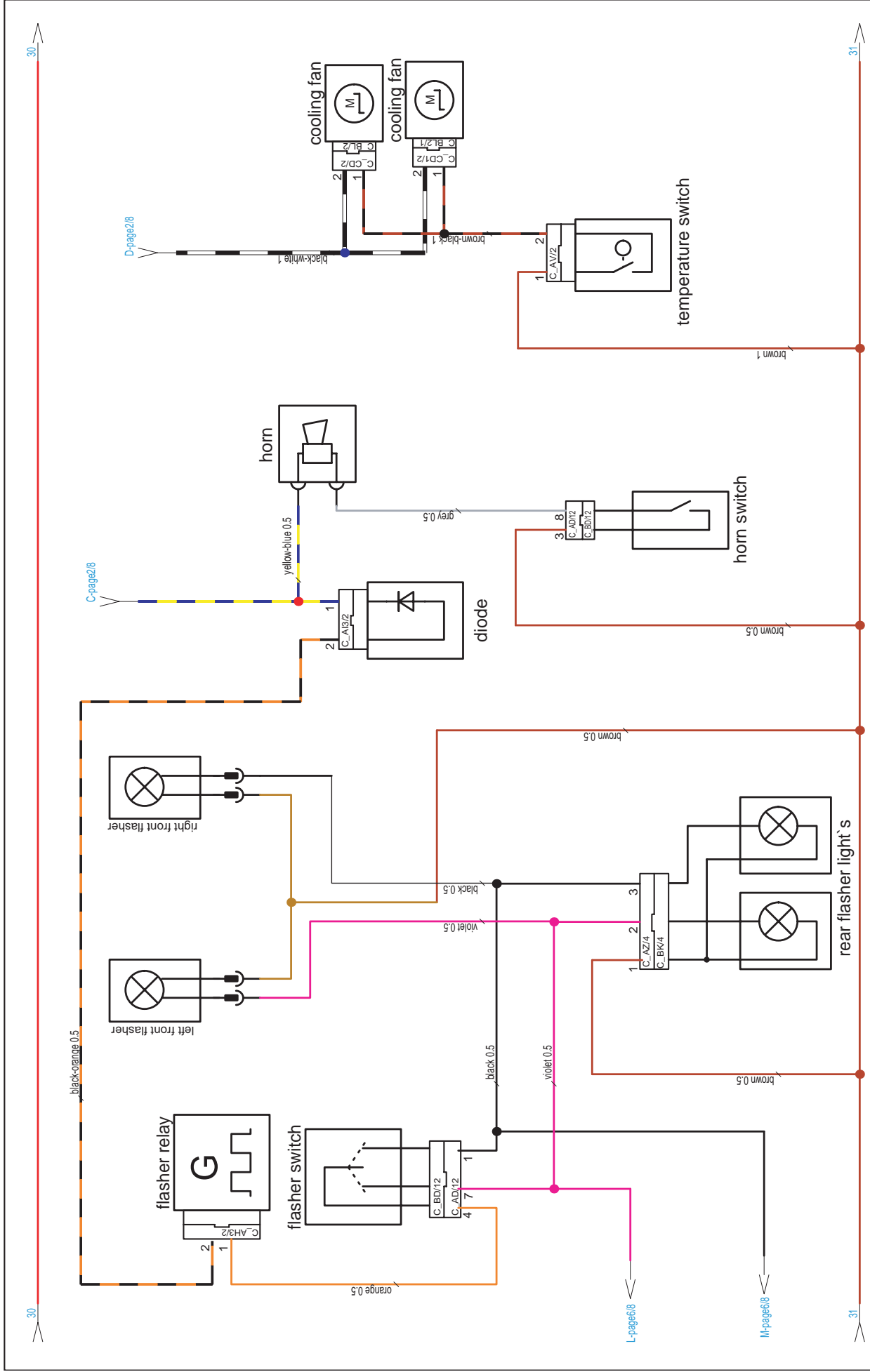

LC8 SM 950

turn indicator system

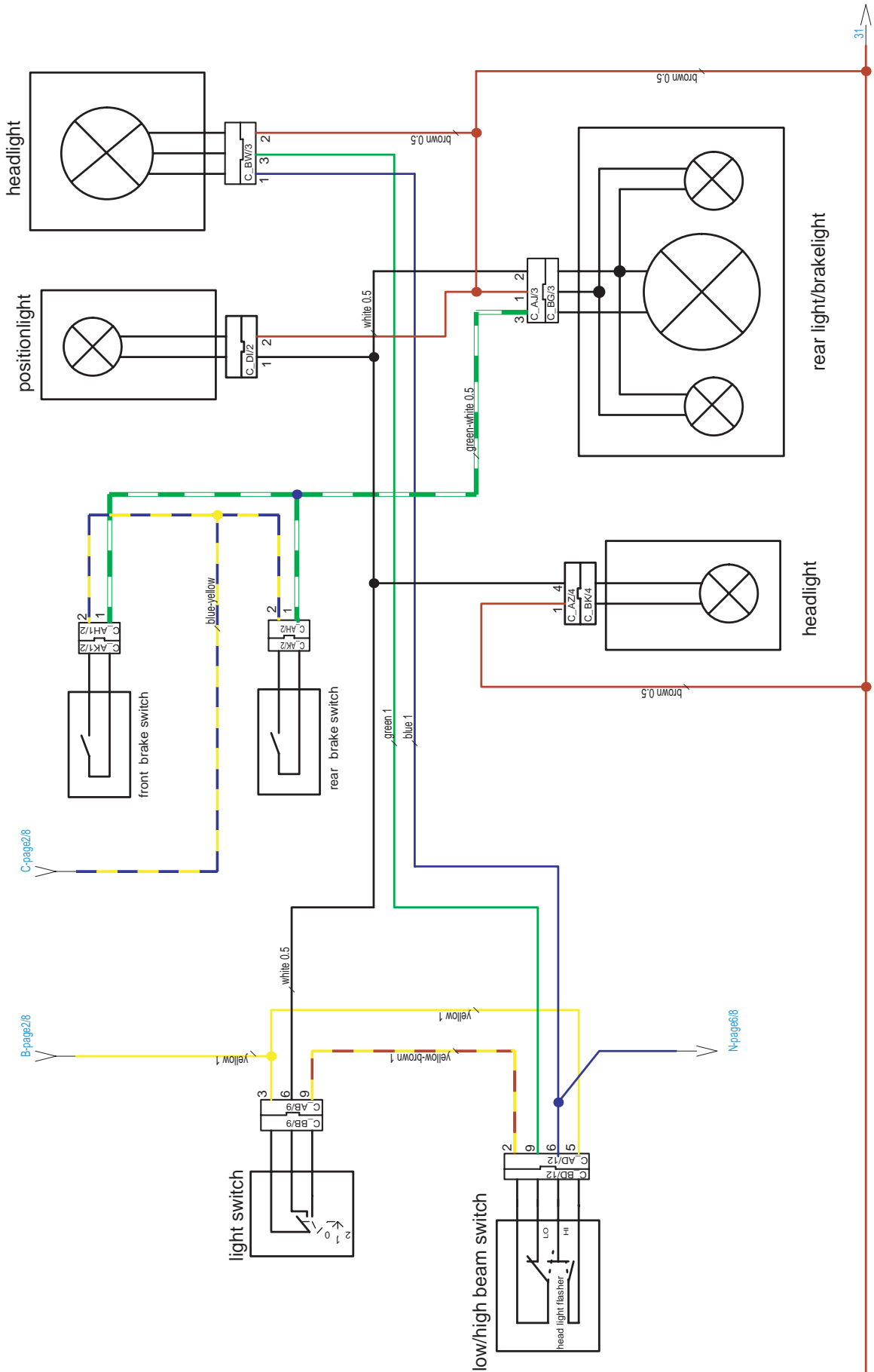

C-page2/8

B-page2/8

N-page6/8



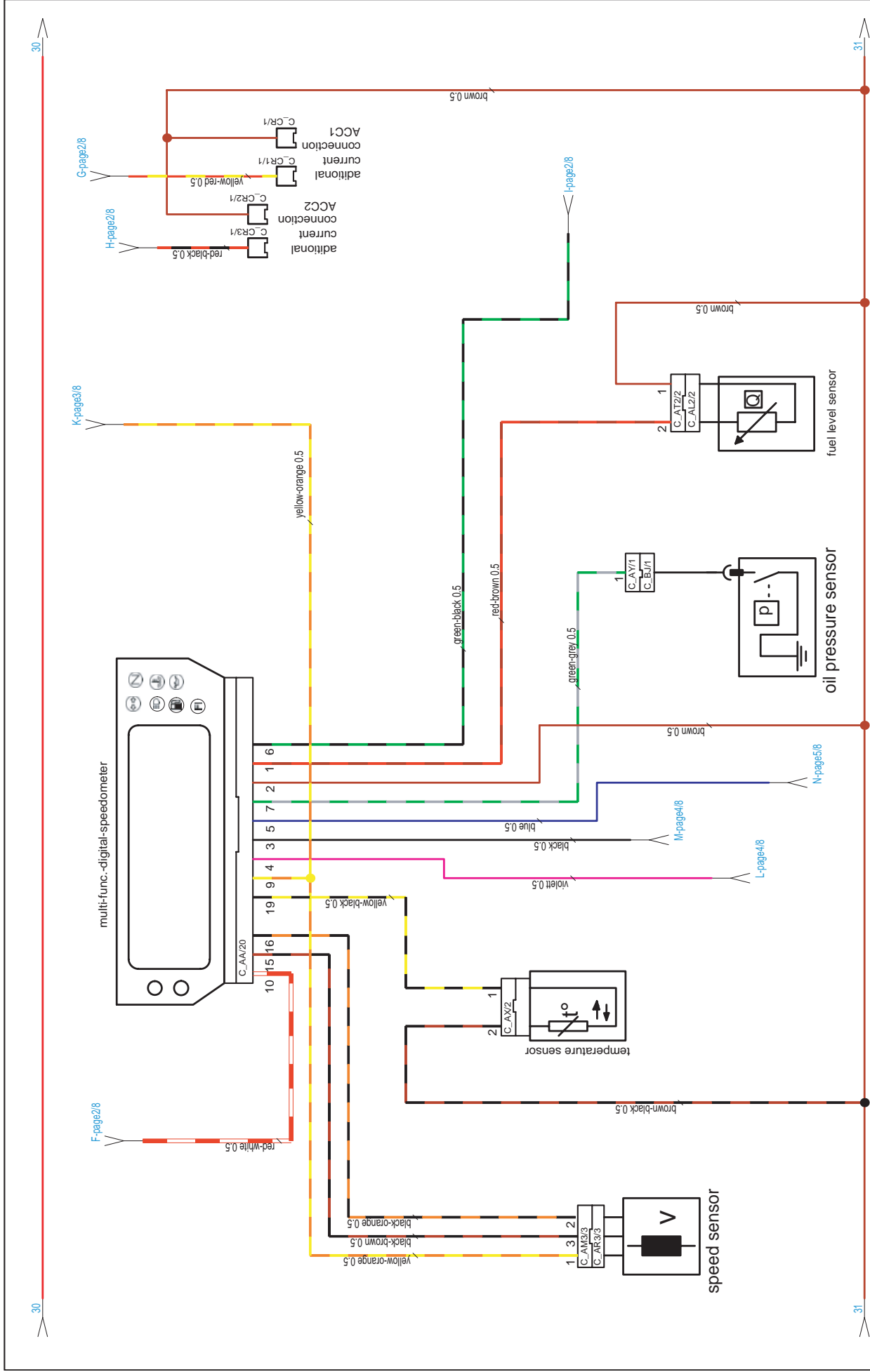

LC8 SM 950

instruments-tachometer

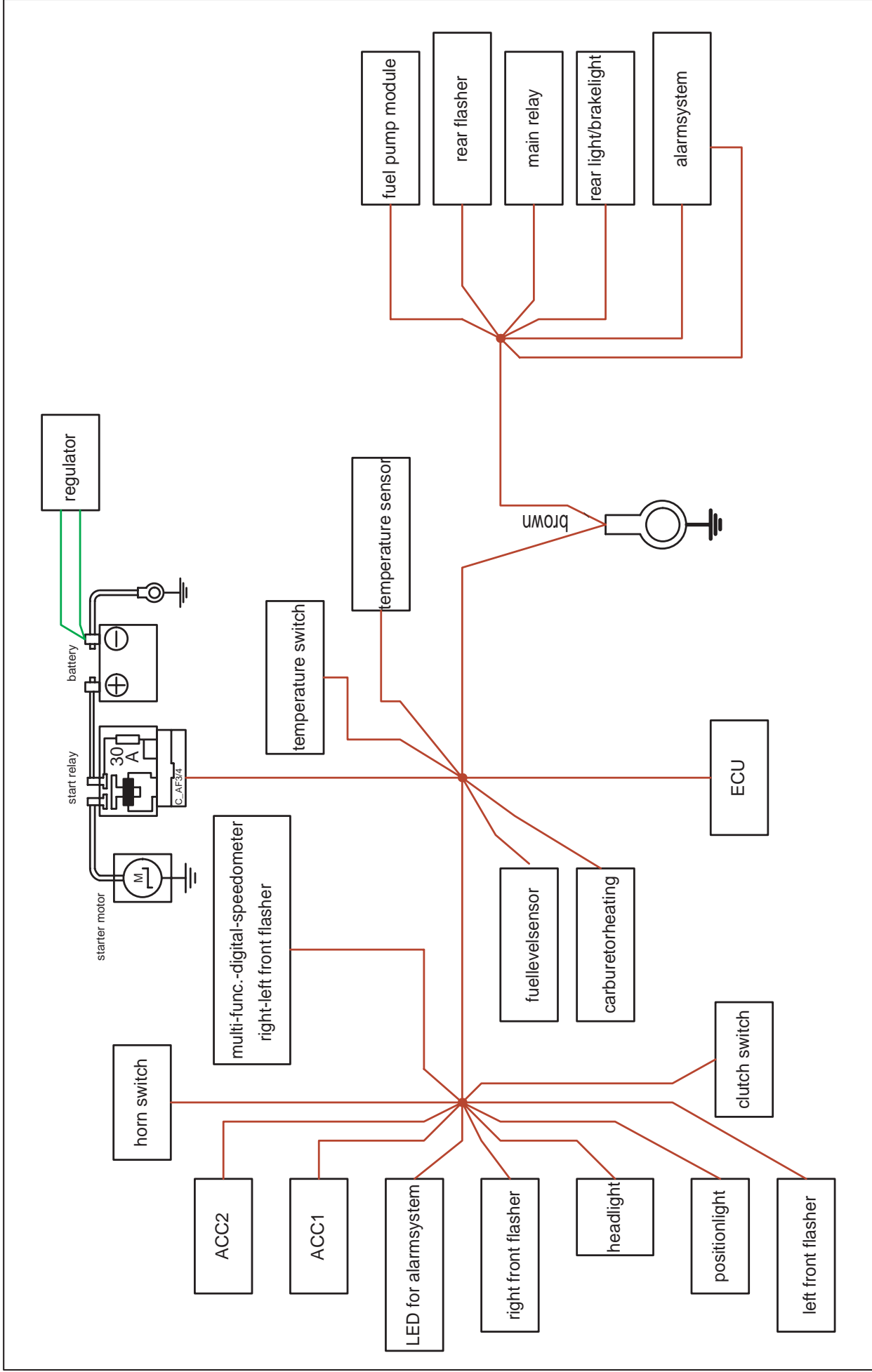

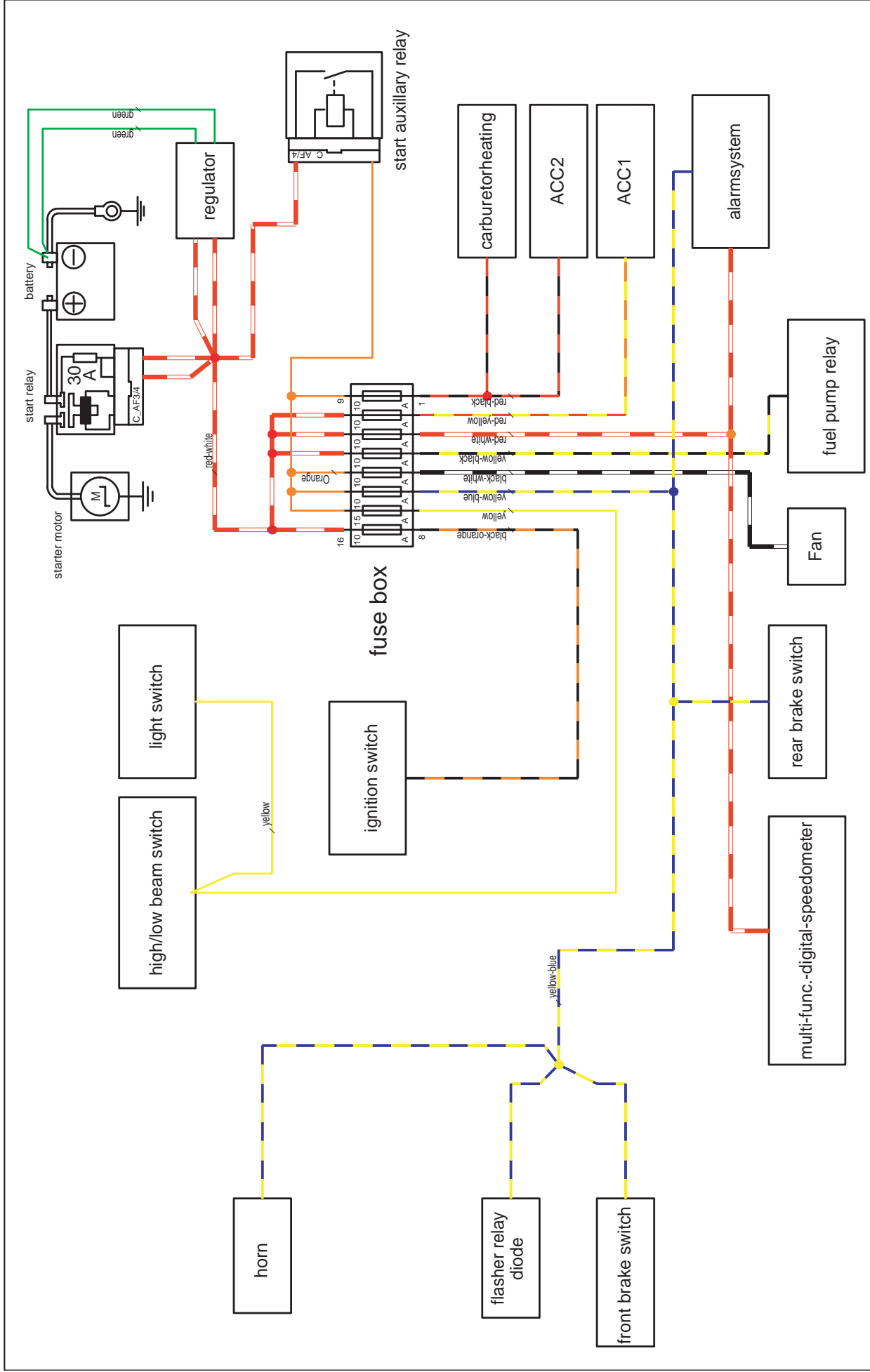

LC8 SM 950

positive connection