

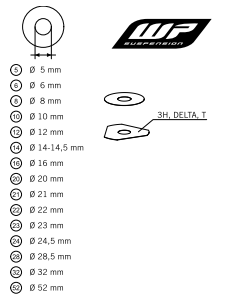

990 SUPERMOTO T ORANGE ABS EU 2012

ART.-NR.: 3CF 9803L2EN

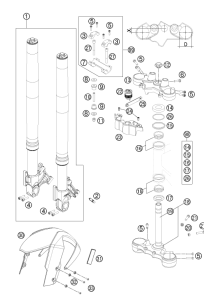
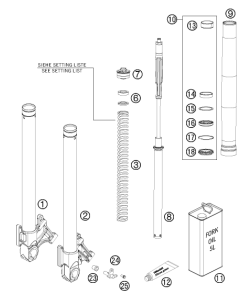
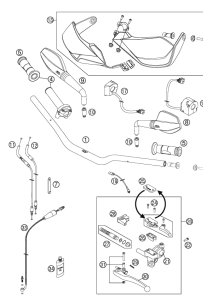
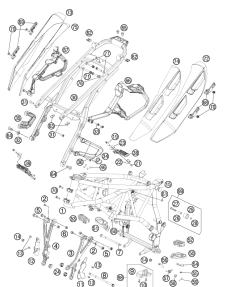
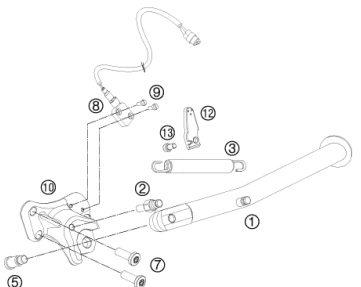
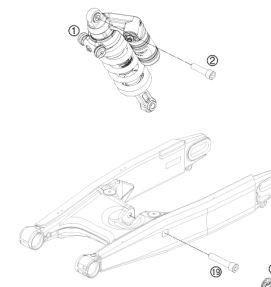
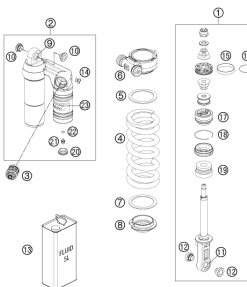
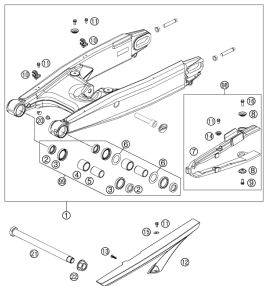
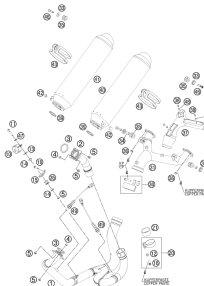
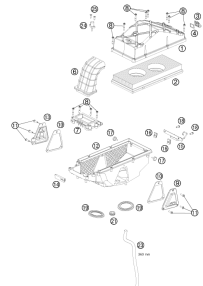
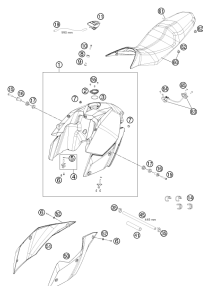
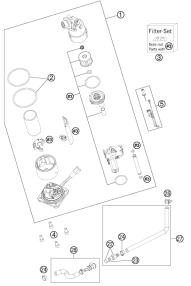
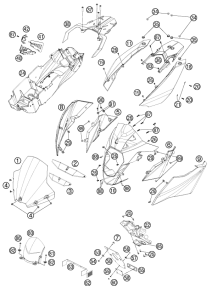
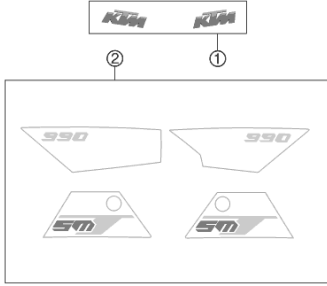
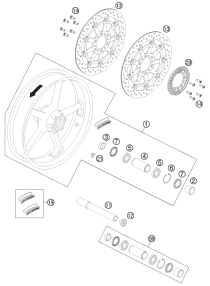
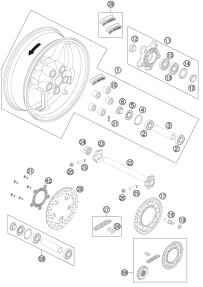
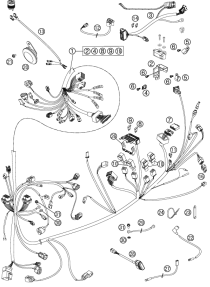
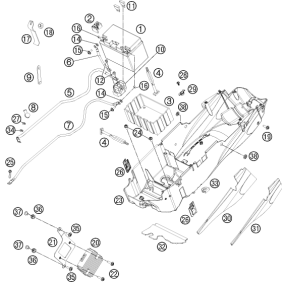
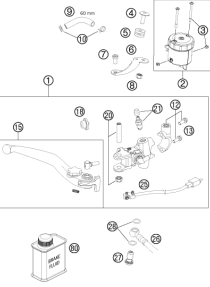
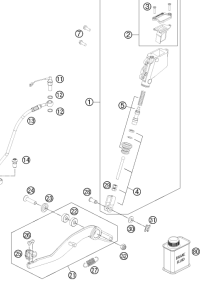
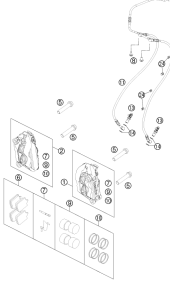
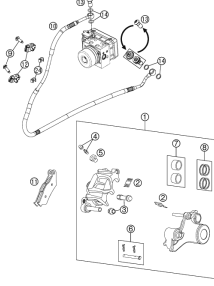
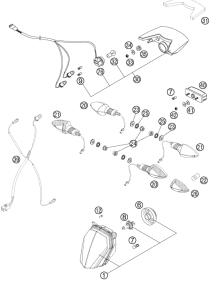

<p>WP SHIMS FOR SETTING</p>  <p> ① Ø 5 mm ② Ø 6 mm ③ Ø 8 mm ④ Ø 10 mm ⑤ Ø 12 mm ⑥ Ø 14-14,5 mm ⑦ Ø 16 mm ⑧ Ø 20 mm ⑨ Ø 21 mm ⑩ Ø 22 mm ⑪ Ø 23 mm ⑫ Ø 24,5 mm ⑬ Ø 28,5 mm ⑭ Ø 32 mm ⑮ Ø 52 mm </p> <p>4</p>	<p>FRONT FORK, TRIPLE CLAMP</p>  <p>11</p>	<p>FRONT FORK DISSASSEMBLED</p>  <p>12</p>	<p>HANDLEBAR, CONTROLS</p>  <p>13</p>
<p>FRAME</p>  <p>14</p>	<p>SIDE STAND</p>  <p>16</p>	<p>MONOSHOCK</p>  <p>17</p>	<p>MONOSHOCK DISSASSEMBLED</p>  <p>18</p>
<p>SWING ARM</p>  <p>19</p>	<p>EXHAUST SYSTEM</p>  <p>20</p>	<p>AIR FILTER BOX</p>  <p>21</p>	<p>TANK, SEAT, COVER</p>  <p>22</p>

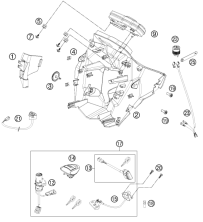
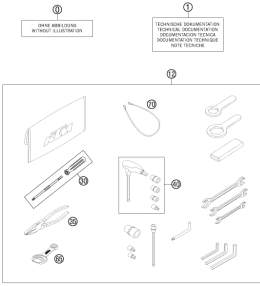
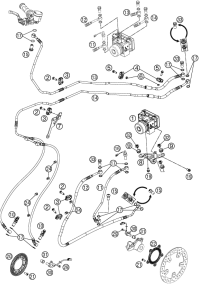
<p>FUEL PUMP</p>  <p>23</p>	<p>MASK, FENDER</p>  <p>24</p>	<p>DECAL</p>  <p>26</p>	<p>FRONT WHEEL</p>  <p>27</p>
<p>REAR WHEEL</p>  <p>28</p>	<p>WIRING HARNESS</p>  <p>29</p>	<p>BATTERY</p>  <p>30</p>	<p>HAND BRAKE CYLINDER</p>  <p>31</p>
<p>REAR BRAKE CONTROL</p>  <p>32</p>	<p>BRAKE CALIPER FRONT</p>  <p>33</p>	<p>BRAKE CALPIER REAR</p>  <p>34</p>	<p>LIGHTNING SYSTEM</p>  <p>35</p>

<p>INSTRUMENS / LOCK SYSTEM</p>  <p>36</p>	<p>ACCESSORIES KIT</p>  <p>37</p>	<p>ANTI SKID SYSTEM ABS</p>  <p>38</p>	
	 <p>All information contained is without obligation. KTM Sportmotorcycle GmbH particularly reserves the right to modify any equipment, technical specifications, prices, colors, shapes, materials, services, service work, constructions, equipment and the like so as to adapt them to local conditions or to cancel any of the above items, all without previous announcement and without giving reasons. KTM may stop manufacturing certain models without previous notice. KTM shall not be held liable for any deviations of availability and/or ability to deliver, illustrations, descriptions, printing and/or other errors. The illustrated models partly contain extra equipment, which is not applied to standard models.</p> <p>© by KTM Sportmotorcycle GmbH, Mattighofen AUSTRIA; All rights reserved; Reprint, also in extracts, with written allowance of KTM Sportmotorcycle GmbH, Mattighofen only.</p>		

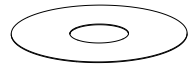

3H, DELTA, T

- ⑤ Ø 5 mm
- ⑥ Ø 6 mm
- ⑧ Ø 8 mm
- ⑩ Ø 10 mm
- ⑫ Ø 12 mm
- ⑭ Ø 14-14,5 mm
- ⑯ Ø 16 mm
- ⑳ Ø 20 mm
- ㉑ Ø 21 mm
- ㉒ Ø 22 mm
- ㉓ Ø 23 mm
- ㉔ Ø 24,5 mm
- ㉘ Ø 28,5 mm
- ㉚ Ø 32 mm
- ㉜ Ø 52 mm

POS	PARTNUMBER	PARTNAME	PIECE
5	44906890	WASHER 5X15X2	X
6	40540400	SHIM 6X12X0,1	X
6	40540401	SHIM 6X14X0,1	X
6	40540402	SHIM 6X16X0,1	X
6	40540403	SHIM 6X18X0,1	X
6	40540404	SHIM 6X12X0,15	X
6	40540405	SHIM 6X14X0,15	X
6	40540406	SHIM 6X16X0,15	X
6	40540407	SHIM 6X18X0,15	X
6	40540408	SHIM 6X12X0,2	X
6	40540409	SHIM 6X14X0,2	X
6	40540410	SHIM 6X16X0,2	X
6	40540411	SHIM 6X18X0,2	X
6	48600095	* SHIM 6X20X0,20	X
6	40540412	SHIM 6X12X0,25	X
6	40540413	SHIM 6X14X0,25	X
6	40540414	SHIM 6X16X0,25	X
6	40540415	SHIM 6X18X0,25	X
6	40540417	SHIM 6X8,5X0,10	X
6	40540418	SHIM 6X9X0,10	X
6	40540419	SHIM 6X9,5X0,10	X
6	40540423	SHIM 6X9,5X0,15	X
6	40540425	SHIM 6X8,5X0,20	X
6	40540426	SHIM 6X9X0,20	X
6	40540427	SHIM 6X9,5X0,20	X
6	40540447	SHIM 6X10X0,3	X
6	40540449	SHIM 6X9X0,3	X
6	40540450	SHIM 6X9,5X0,3	X
6	40540494	SHIM 6X18X0,4	X
6	40540774	SHIM 6X18X0,1 DELTA	X
6	40541383	SHIM 6X11X0,1	X
6	40541391	SHIM 6X11X0,3	X
6	40541402	SHIM 6X11X0,2	X
6	40541403	SHIM 6X10X0,20	X
6	40541404	SHIM 6X10X0,1	X
6	40541405	SHIM 6X10X0,15	X
6	40541406	SHIM 6X11X0,15	X
6	40541408	SHIM 6X8,0X0,30	X

080000190

C070000190

* NEW PART

X ON DEMAND

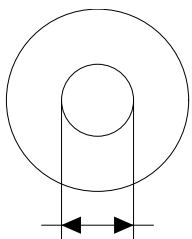

- ⑤ Ø 5 mm
- ⑥ Ø 6 mm
- ⑧ Ø 8 mm
- ⑩ Ø 10 mm
- ⑫ Ø 12 mm
- ⑭ Ø 14-14,5 mm
- ⑯ Ø 16 mm
- ⑳ Ø 20 mm
- ㉑ Ø 21 mm
- ㉒ Ø 22 mm
- ㉓ Ø 23 mm
- ㉔ Ø 24,5 mm
- ㉘ Ø 28,5 mm
- ㉚ Ø 32 mm
- ㉜ Ø 52 mm

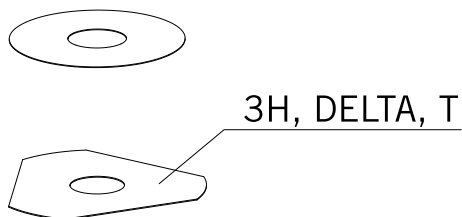

POS	PARTNUMBER	PARTNAME	PIECE
6	40541414	SHIM 6X8,0X0,10	X
6	40541416	SHIM 6X8X0,3	X
6	40541417	SHIM 6X11X0,25	X
6	48600102	* SHIM 6X24X0,25	X
6	48600063	SHIM 6X24X0,1	X
6	48600064	SHIM 6X22X0,1	X
6	48600065	SHIM 6X20X0,1	X
6	48600069	SHIM 6X20X0,15	X
6	48600100	SHIM 6X24X0,15	X
6	48600116	SHIM 6X24X0,1 DELTA	X
6	48600139	SHIM 6X22X0,1 DELTA	X
6	48600217	BACKPLATE 6X10X0,25	X
6	48600325	SHIM 6X13X0,1	X
6	48600327	SHIM 6X15X0,1	X
6	48600329	SHIM 6X17X0,1	X
6	48600331	SHIM 6X19X0,1	X
6	48600096	* SHIM 6X20X0,25	X
6	48600097	SHIM 6X22X0,15	X
6	48600099	* SHIM 6X22X0,25	X
6	40540448	BACKPLATE 6X8,5X0,30	X
6	48600479	SHIM 6X20X0,1 T/3H	X
6	48600332	SHIM 6X21X0,1	X
6	48600333	SHIM 6X23X0,1	X
6	40541393	* SHIM 6X12X0,3	X
8	40540477	SHIM 8X18X0,4	X
8	43570120	SHIM 8X18X0,10	X
8	44916098	WASHER 8,4X16X0,8	X
8	44916130	WASHER 8,2X15X1	X
8	44916180	WASHER 8,2X11X1	X
8	48600214	SHIM 8X16X0,1	X
8	48600346	SHIM 8X11X0,2	X
8	48600215	CHECK VALVE 8X20X0,1	X
8	48600061	CHECK VALVE 8X24X0,4	X
8	48600062	CHECK VALVE 8X24X0,1	X
8	48600216	CHECK VALVE 8X22X0,1	X
8	48600480	SHIM 8X10X0,20	X
8	48600555	SHIM 8X16X0,20	X
8	48600213	SHIM 8X14X0,10	X

080000190

C070000190

* NEW PART

X ON DEMAND

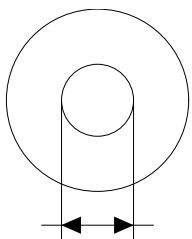

- ⑤ Ø 5 mm
- ⑥ Ø 6 mm
- ⑧ Ø 8 mm
- ⑩ Ø 10 mm
- ⑫ Ø 12 mm
- ⑭ Ø 14-14,5 mm
- ⑯ Ø 16 mm
- ⑰ Ø 20 mm
- ⑱ Ø 21 mm
- ⑳ Ø 22 mm
- ㉑ Ø 23 mm
- ㉒ Ø 24,5 mm
- ㉔ Ø 28,5 mm
- ㉖ Ø 32 mm
- ㉘ Ø 52 mm

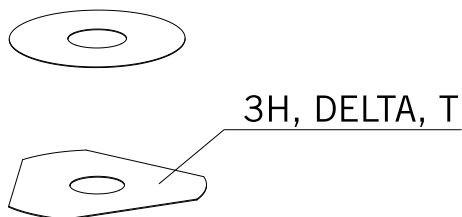

POS	PARTNUMBER	PARTNAME	PIECE
8	48600357	CHECK VALVE 8X11X0,1	X
8	48600351	CHECK VALVE 8X12X0,1	X
8	48600607	SHUTTLE VALVE 8X20X0,4	X
10	36120284	SHIM 10X16X0,10	X
10	36120298	SHIM 10X16X0,2	X
10	36120312	SHIM 10X16X0,30	X
10	36120314	SHIM 10X18X0,30	X
10	36120325	SHIM 10X19X0,15	X
10	36120327	SHIM 10X23X0,15	X
10	36120328	SHIM 10X25X0,15	X
10	36120329	SHIM 10X27X0,15	X
10	36120330	SHIM 10X29X0,15	X
10	36120331	SHIM 10X31X0,15	X
10	36120332	SHIM 10X33X0,15	X
10	36120334	SHIM 10X21X0,20	X
10	36120335	SHIM 10X23X0,20	X
10	36120336	SHIM 10X25X0,20	X
10	36120337	SHIM 10X27X0,20	X
10	36120338	SHIM 10X29X0,20	X
10	36120339	SHIM 10X31X0,20	X
10	36120340	SHIM 10X33X0,20	X
10	36120342	SHIM 10X21X0,25	X
10	36120343	SHIM 10X23X0,25	X
10	36120344	SHIM 10X25X0,25	X
10	36120345	SHIM 10X27X0,25	X
10	36120349	SHIM 10X19X0,30	X
10	36120350	SHIM 10X21X0,30	X
10	40140275	WASHER 10X35X0,15	X
10	36120346	* SHIM 10X29X0,25	X
10	50180010	* SHIM 16X24X0,10	X
10	36120604	SHIM D10XD22X2,5	X
12	46810490	SHIM 12X24X0,20	X
12	46810491	SHIM 12X26X0,20	X
12	46810492	SHIM 12X28X0,20	X
12	46810493	SHIM 12X30X0,20	X
12	46810494	SHIM 12X32X0,20	X
12	46810495	SHIM 12X34X0,20	X
12	46810496	SHIM 12X36X0,20	X

080000190

C070000190

* NEW PART

X ON DEMAND

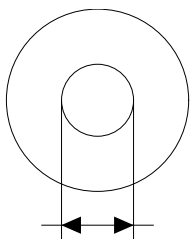

3H, DELTA, T

- ⑤ Ø 5 mm
- ⑥ Ø 6 mm
- ⑧ Ø 8 mm
- ⑩ Ø 10 mm
- ⑫ Ø 12 mm
- ⑭ Ø 14-14,5 mm
- ⑯ Ø 16 mm
- ⑳ Ø 20 mm
- ㉑ Ø 21 mm
- ㉒ Ø 22 mm
- ㉓ Ø 23 mm
- ㉔ Ø 24,5 mm
- ㉘ Ø 28,5 mm
- ㉚ Ø 32 mm
- ㉜ Ø 52 mm

POS	PARTNUMBER	PARTNAME	PIECE
12	46810497	SHIM 12X38X0,20	X
12	46810498	SHIM 12X40X0,20	X
12	46810499	SHIM 12X24X0,25	X
12	46810500	SHIM 12X26X0,25	X
12	46810501	SHIM 12X28X0,25	X
12	46810502	SHIM 12X30X0,25	X
12	46810504	SHIM 12X34X0,25	X
12	46810505	SHIM 12X36X0,25	X
12	46810507	SHIM 12X40X0,25	X
12	46810508	SHIM 12X24X0,30	X
12	46810509	SHIM 12X26X0,30	X
12	46810510	SHIM 12X28X0,30	X
12	46810512	SHIM 12X32X0,30	X
12	46810513	SHIM 12X34X0,30	X
12	46810518	SHIM 12X26X0,15	X
12	46810519	SHIM 12X28X0,15	X
12	46810520	SHIM 12X30X0,15	X
12	46810521	SHIM 12X32X0,15	X
12	46810522	SHIM 12X34X0,15	X
12	46810523	SHIM 12X36X0,15	X
12	46810524	SHIM 12X38X0,15	X
12	46810525	SHIM 12X40X0,15	X
12	46810604	SHIM 12X20X0,10	X
12	46810606	SHIM 12X22X0,10	X
12	46810607	SHIM 12X23X0,10	X
12	46810608	SHIM 12X24X0,10	X
12	46810610	SHIM 12X27X0,15	X
12	46810611	SHIM 12X18X0,15	X
12	46810612	SHIM 12X19X0,15	X
12	46810615	SHIM 12X22X0,15	X
12	46810636	BACKPLATE 12X16X0,30	X
12	46810637	BACKPLATE 12X17X0,30	X
12	46810638	BACKPLATE 12X18X0,30	X
12	46810639	SHIM 12X19X0,30	X
12	46810641	BACKPLATE 12X21X0,30	X
12	46811582	BACKPLATE 12X30X0,10	X
12	46810631	SHIM 12X20X0,25	X
12	46810633	SHIM 12X22X0,25	X

080000190

C070000190

* NEW PART

X ON DEMAND



- ⑤ Ø 5 mm
- ⑥ Ø 6 mm
- ⑧ Ø 8 mm
- ⑩ Ø 10 mm
- ⑫ Ø 12 mm
- ⑭ Ø 14-14,5 mm
- ⑯ Ø 16 mm
- ⑳ Ø 20 mm
- ㉑ Ø 21 mm
- ㉒ Ø 22 mm
- ㉓ Ø 23 mm
- ㉔ Ø 24,5 mm
- ㉘ Ø 28,5 mm
- ㉚ Ø 32 mm
- ㉞ Ø 52 mm

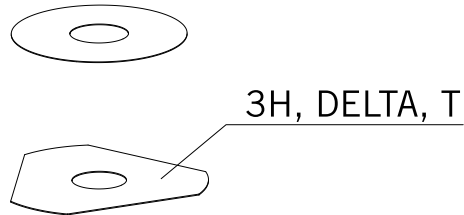

POS	PARTNUMBER	PARTNAME	PIECE
12	46810624	* SHIM 12X22X0,20	X
12	46811580	SHIM 12X32X0,10	X
12	46810503	SHIM 12X32X0,25	X
12	46810517	* SHIM 12X24X0,15	X
12	46810640	SHIM 12X20X0,30	X
14	46811046	SHIM 14,5X35,4X1,25	X
16	50180006	BACKPLATE 16X20X0,10	X
16	50180007	SHIM 16X21X0,10	X
16	50180028	SHIM 16X21X0,25	X
16	50180210	WASHER 16X21X1	X
16	50180008	SHIM 16X22X0,10	X
16	50180022	SHIM 16X22X0,20	X
16	50180037	SHIM 16X23X0,30	X
16	50180038	SHIM 16X24X0,30	X
16	50180032	SHIM 15X25X0,25	X
16	50180039	SHIM 16X25X0,30	X
16	50180012	SHIM 16X26X0,10	X
16	50180019	SHIM 16X26X0,15	X
16	50180026	SHIM 16X26X0,20	X
16	50180040	SHIM 16X26X0,30	X
16	50180041	SHIM 16X28X0,10	X
16	50180045	SHIM 16X28X0,15	X
16	50180054	SHIM 16X28X0,20	X
16	50180063	SHIM 16X28X0,25	X
16	50180072	SHIM 16X28X0,30	X
16	50180046	SHIM 16X30X0,15	X
16	50180055	SHIM 16X30X0,20	X
16	50180064	SHIM 16X30X0,25	X
16	50180073	SHIM 16X30X0,30	X
16	50180047	SHIM 16X32X0,15	X
16	50180056	SHIM 16X32X0,20	X
16	50180065	SHIM 16X32X0,25	X
16	50180074	SHIM 16X32X0,30	X
16	50180044	SHIM 16X34X0,10	X
16	50180048	SHIM 16X34X0,15	X
16	50180057	SHIM 16X34X0,20	X
16	50180066	SHIM 16X34X0,25	X
16	50180075	SHIM 16X34X0,30	X

080000190

C070000190

* NEW PART

X ON DEMAND

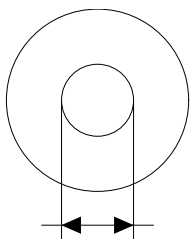

- ⑤ Ø 5 mm
- ⑥ Ø 6 mm
- ⑧ Ø 8 mm
- ⑩ Ø 10 mm
- ⑫ Ø 12 mm
- ⑭ Ø 14-14,5 mm
- ⑯ Ø 16 mm
- ⑳ Ø 20 mm
- ㉑ Ø 21 mm
- ㉒ Ø 22 mm
- ㉓ Ø 23 mm
- ㉔ Ø 24,5 mm
- ㉘ Ø 28,5 mm
- ㉚ Ø 32 mm
- ㉜ Ø 52 mm

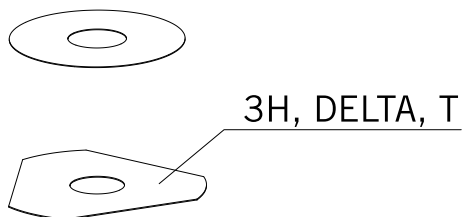

POS	PARTNUMBER	PARTNAME	PIECE
16	50180049	SHIM 16X36X0,15	X
16	50180058	SHIM 16X36X0,20	X
16	50180067	SHIM 16X36X0,25	X
16	50180076	SHIM 16X36X0,30	X
16	50180050	SHIM 16X38X0,15	X
16	50180059	SHIM 16X38X0,20	X
16	50180068	SHIM 16X38X0,25	X
16	50180077	SHIM 16X38X0,30	X
16	50180051	SHIM 16X40X0,15	X
16	50180060	SHIM 16X40X0,20	X
16	50180069	SHIM 16X40X0,25	X
16	50180078	SHIM 16X40X0,30	X
16	50180052	SHIM 16X42X0,15	X
16	50180061	SHIM 16X42X0,20	X
16	50180070	SHIM 16X42X0,25	X
16	50180079	SHIM 16X42X0,30	X
16	50180053	SHIM 16X44X0,15	X
16	50180062	SHIM 16X44X0,20	X
16	50180071	SHIM 16X44X0,25	X
16	50180080	SHIM 16X44X0,30	X
16	50180177	WASHER 16X8,2X0,6	X
16	50180033	SHIM 16X26X0,25	X
16	50180034	BACKPLATE 16X20X0,30	X
16	50180035	BACKPLATE 16X21X0,30	X
16	50180036	BACKPLATE 16X22X0,30	X
16	50180043	SHIM	X
16	50180024	* SHIM 16X24X0,20	X
16	50180027	* SHIM 16X20X0,25	X
16	50180031	SHIM	X
20	48600212	PRESSURE-RING 20X16,25X0,20	X
20	50180666	SHIM 20X24X0,30	X
20	50180654	SHIM 20X36X0,20	X
20	50180655	SHIM 20X38X0,20	X
20	50180656	SHIM 20X40X0,20	X
20	50180665	SHIM 20X40X0,25	X
20	50180662	SHIM 20X34X0,25	X
20	50180657	SHIM 20X24X0,25	X
20	50180653	SHIM 20X34X0,20	X

080000190

C070000190

* NEW PART

X ON DEMAND



- ⑤ Ø 5 mm
- ⑥ Ø 6 mm
- ⑧ Ø 8 mm
- ⑩ Ø 10 mm
- ⑫ Ø 12 mm
- ⑭ Ø 14-14,5 mm
- ⑯ Ø 16 mm
- ⑳ Ø 20 mm
- ㉑ Ø 21 mm
- ㉒ Ø 22 mm
- ㉓ Ø 23 mm
- ㉔ Ø 24,5 mm
- ㉘ Ø 28,5 mm
- ㉚ Ø 32 mm
- ㉜ Ø 52 mm



3H, DELTA, T

POS	PARTNUMBER	PARTNAME	PIECE
20	50180634	RING 20X22,9X1	X
21	50180209	WASHER 21X36X0,25	X
22	50180330	* PRESS. RING 22X18X0,30	X
23	50180635	SHUTTLE VALVE 23X38X0,25	X
23	50180578	SHIM D23XD16X2	X
24	40541061	WASHER 24,5X34X2	X
28	36120469	SHIM 28,5X14X2	X
28	36120471	SHIM 28,5X14X5	X
32	48600460	WASHER 32X42X2,5	X
32	50600065	SHIM 32X45X2	X
32	46811637	PRESSURE RING 36X32,25	X
52	50600002	SHIM 52X59X2,2	X

080000190

C070000190

* NEW PART

X ON DEMAND

FRONT FORK, TRIPLE CLAMP

990 SUPERMOTO T ORANGE ABS EU 2012

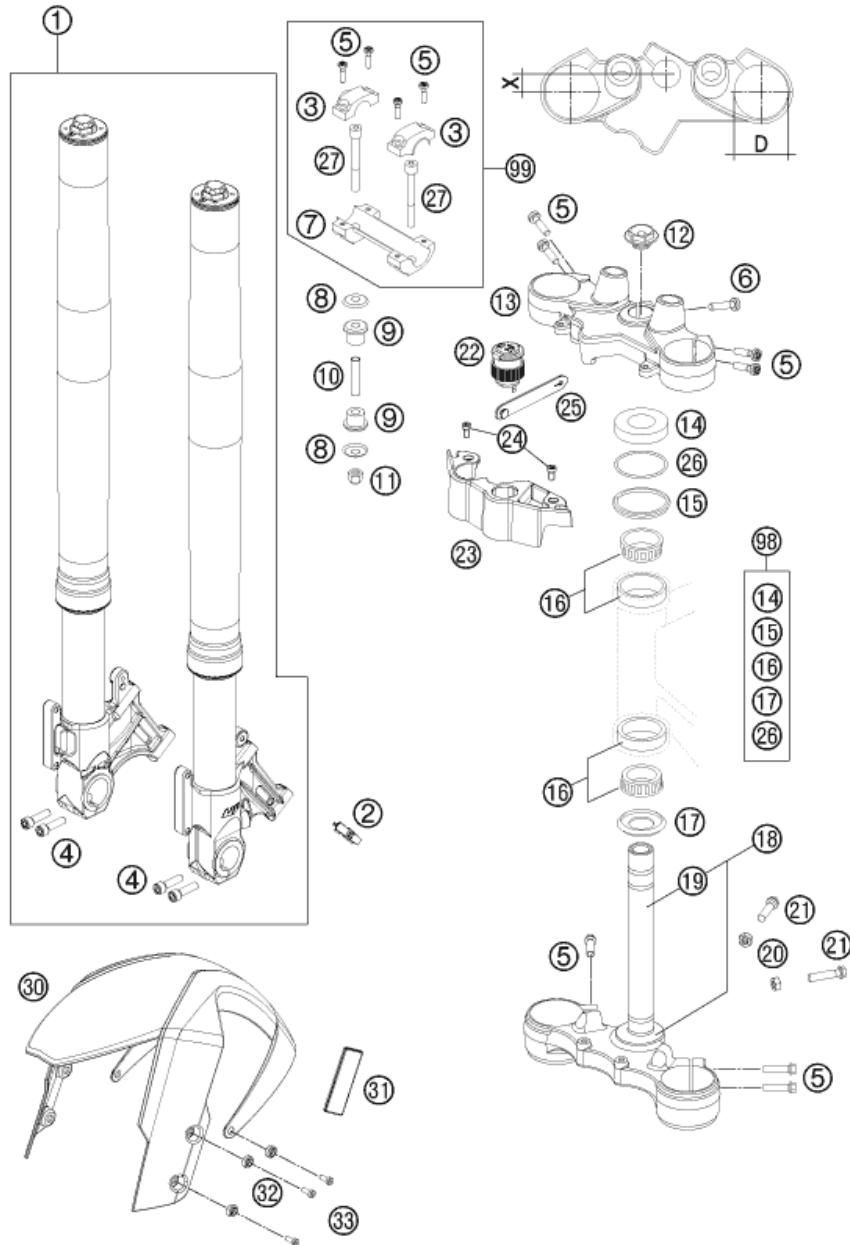

POS	PARTNUMBER	PARTNAME	PIECE
1	14187K4301	FORK KTM 990 SM-T 2011	1
2	62142025050	CABLE SUPPORT	1
3	5900103830001S	HANDLEBAR CLAMP 28MM 07	2
4	0912080303	AH SCREW DIN0912-M 8X30	4
5	0035080306	AH-COLLAR SCREW M8X30 ISA45	12
6	0035080356	AH-COLLAR SCREW M8X35 ISA45	1
7	5900103920001S	HANDLEBAR SUPPORT 28MM 07	1
8	56401042000	WASHER 10,5X32X2	4
9	56401040000	RUBBER BUSHING	4
10	56401041100	SPACER TUBE 10,2X12X44	2
11	0982100003	SELF LOCK.NUT DIN0982-M10 HIGH	2
12	54801036200	STEER.HEAD SCREW M20x1,5 SW=27	1
13	6250103402633S	TOP TRIPLE CLAMP	1
14	61001086000	STEERING HEAD COVER 05	1
15	54601184000	STEERING HEAD GASKET TOP	1
16	54201081100	TAPERED ROLLER BEARING CPL. 06	2
17	54601084100	%O-RING SUPPORT W. SEALING LIP	1
18	6250103202633S	BOTTOM TRIPLE CLAMP CPL.	1
19	60001033000	FORK TUBE LC8 ADV 03	1
20	0934080003	HEXAGON NUT DIN0934-M 8	2
21	0933080303	HH SCREW DIN0933-M 8X30	2
22	60111042100	SOCKET	1
23	62001070100	CABLE SUPPORT	1
24	014580060126	CYL. SCREW DIN14580 M 6X12	2
25	60011093075	RUBBER CABLE TIE 75MM 03	1
26	0770275025	O-RING 27,5X2,5 NBR	1
27	0984100703	AH SCREW DIN6912-M10X70	2
30	6110801000030	FRONT FENDER BLACK 07	1
31	58412080100	REFLECTOR YELLOW '99	2
32	61108045000	SPECIAL WASHER	6
33	014580060166	CYL. SCREW DIN14580 M 6X16	6
98	00050000930	STEERING HEAD REP. KIT 06-15	x
99	00050000922	HANDLEBAR SUPPORT KIT	x

116210110

C126210110

* NEW PART

X ON DEMAND

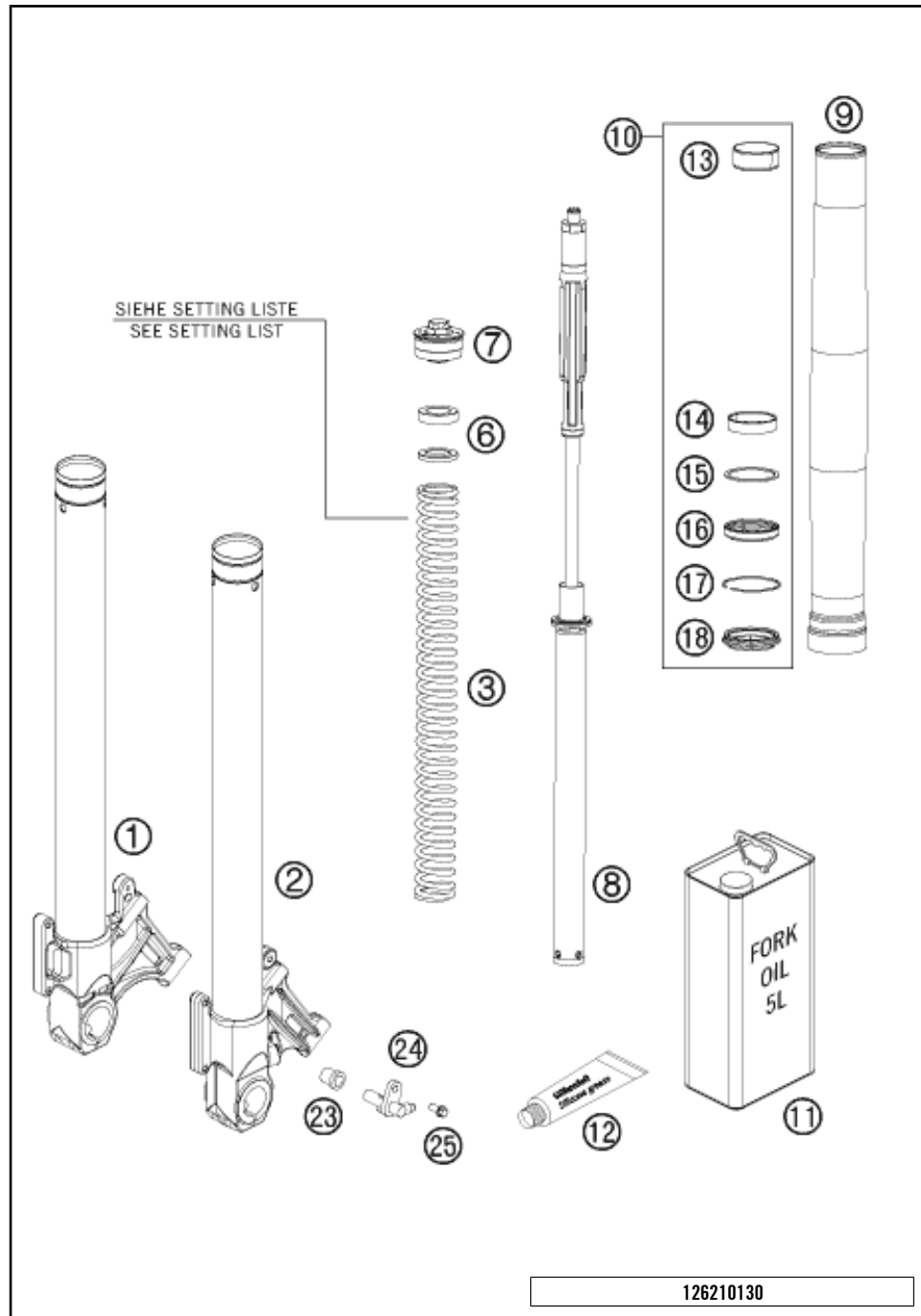

POS	PARTNUMBER	PARTNAME	PIECE
1	48600685S4	AXLE CLAMP R/S CPL. 09	1
2	48600963S5	AXLE CLAMP L/S ABS. CPL. 2011	1
3	91410075S	SPRING	1
6	48600053	SPACER 42X26,5X1,5	2
6	48600036	SPACER 42X26,5X2,5	2
6	48600037	SPACER 42X26,5X5	2
7	48600431S	PRE-LOAD ADJ. CPL. M51X1,5 05	2
8	48600839S1	CARTRIDGE CPL. 990 SM-R 2009	1
9	48600712	OUTER TUBE L610 D54/D60 2L ROA	2
10	R14017	REPAIR-KIT GASKET 09	1
11	48601166S1	FORK OIL SAE4 5L	1
12	T511	SILICONE GREASE F. DUST STRI	1
13	48600428	% DU-BUSH D47XD49X20DDL02	2
14	48601009	GUIDING BUSH 48X52X12 R11	2
15	48600013	SUPPORT RING 50 X 57,6 X 1,5	2
16	48600399	OIL SEAL RING 48X57,8X9,5	2
17	48600070	LOCK WASHER SB58	2
18	48600816	DUST SEAL	2
23	60142024050	SLEEVE SENSOR HOLDER ABS	1
24	60142025000	ABS-SENSOR 06	1
25	59009062013	SPECIAL SCREW M6X13 WS=8 10.9	1

C126210130

* NEW PART X ON DEMAND

HANDLEBAR, CONTROLS

990 SUPERMOTO T ORANGE ABS EU 2012

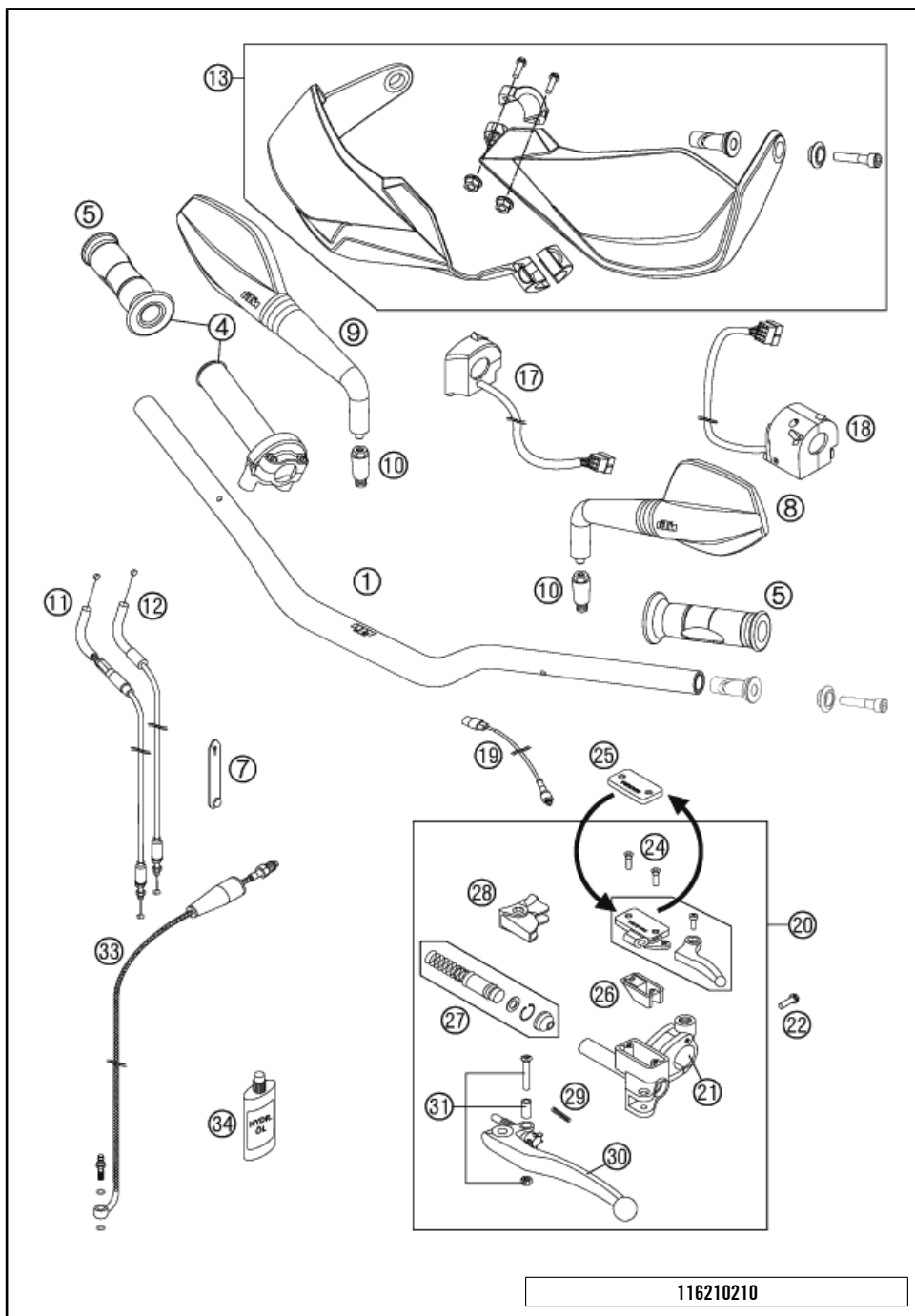

POS	PARTNUMBER	PARTNAME	PIECE
1	62602001000	HANDLEBAR 990 SM	1
4	61002010000	THROTTLE GRIP 05	1
5	61002021000	GRIPP SET	1
7	60011093045	RUBBER CABLE TIE 45MM 03	x
8	61112040000	REVIEW MIRROR L/S 07	1
9	61112041000	REVIEW MIRROR R/S 07	1
10	58412040050	SUPPORT FOR MIRROR LC4 '98	2
11	62502091100	THROTTLE CABLE OPEN	1
12	62502092100	TROTTLE CABLE CLOSE	1
13	6200207904430	HAND GUARDS CPL.L/S+R/S BLACK	1
17	62011074000	START-STOP SWITCH	1
18	60011070000	LIGHT SWITCH A.D. 03	1
19	62011049000	CLUTCH SWITCH 09	1
20	60002130000	MASTER CYLINDER MAGURA D=10.5	1
21	60002044000	CLAMP MIRROR WITH CLAMP	1
22	0025060206	HH COLLAR SCREW M6X20 TX30	1
24	0965040123	FLAT HEAD SCREW DIN0965-M 4X12	2
25	50302033000	COVER FOR HYDR. CLUTCH '98	1
26	50302034000	RUBBER FOR RESERVOIR '98	1
27	50302032000	REP.SET PISTON MAGURA D=10.5	1
28	50302037000	PROTECT.CAP FOR LEVER PERCH'98	1
29	59002035000	SPRING FOR CLUTCH LEVER 03	1
30	60002031000	CLUTCH LEVER LONG CPL. 2003	1
31	50302038000	LEVER SCREW CPL. 125-200 '98	1
33	60032063100	CLUTCH PIPE LC8 ADV '03	1
34	50302036200	OIL FOR HYD. CLUTCH 100 ML	1

116210210

C126210210

* NEW PART X ON DEMAND

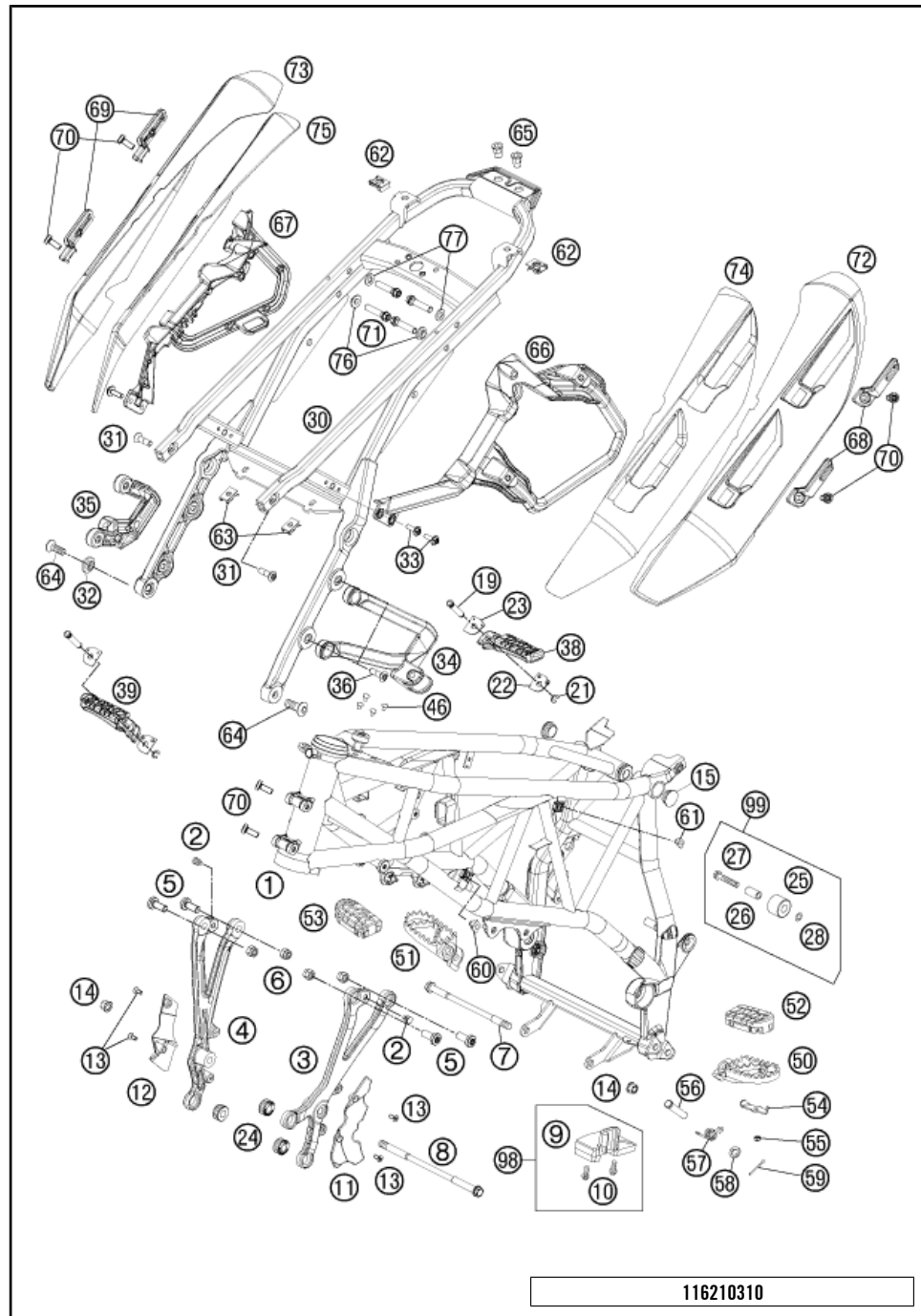

116210310

POS	PARTNUMBER	PARTNAME	PIECE
1	6210300100033	FRAME "621KA" 990 SM-T SW 11	1
2	54403135000	PLASTIC CAP SFL10	2
3	6250300500033S	ENGINE SUPPORT L/S 07	1
4	6250300600033S	ENGINE SUPPORT R/S 07	1
5	0035100249	AH-COLLAR SCREW M10X24 ISA45	4
6	54310086100	SELF LOCKING NUT M10 CU WS=14	4
7	60003013000	ENGINE BRAC. SCREW M10X172 03	1
8	60003014000	ENGINE BRAC. SCREW M10X206 03	1
9	60004076100	CHAIN SLIDING BLOCK 05	1
10	0017060204	%EJOT PT SCREW K60X20 ALU WS=6	2
11	62603005050	COVER ENGINE SUPPORT LEFT	1
12	62603006050	COVER ENGINE	1
13	0019050121	COUNTERSUNK SCREW ISA25 M5X12	4
14	54630044000	COLLAR NUT M10 WS=13	2
15	61003088000	PLUG SFL28 05	2
19	60003044000	BOLT FOR FOOTREST REAR 03	2
21	0799060003	TAB WASHER DIN6799-RS 6,0	2
22	60003152000	ENGAGE PANEL FOOTREST L/S 03	2
23	60003052000	ENGAGE PANEL FOOTREST R/S 03	2
24	60003098000	RUBBER SLEEVE 03	3
25	58403060000	CHAIN ROLL 12X29X22,5 '98	1
26	58403060065	BUSH CHAIN ROLL 8X12X23 '98	1
27	0025080406	HH COLLAR SCREW M8X40 TX40	1
28	36003014000	LOCK WASHER 8MM	1
30	6260300220092	SUB FRAME SM PLATIN 2011	1
31	0019100289S	COUNTERSUNK SCREW ISA45 M10X28	2
32	60003001051	COLLAR BUSHING 10X15X25X4 03	1
33	0024060206	HH COLLAR SCREW M6X20 TX30	4
34	6250304800001S	FOOTREST BRACKET REAR L/S 07	1
35	6250304900001S	FOOTREST BRACKET REAR R/S 07	1
36	0019080266S	COUNTER-SUNK SCREW ISA45 M8X26	4
38	60003050000	FOOTREST CPL. L/S REAR 03	1
39	60003051000	FOOTREST CPL. R/S REAR 03	1
46	60103088000	PLUG ZK 8/5 06	4
50	59003040250	% FOOT PEG L/S SILVER 02	1
51	59003041250	% FOOT PEG R/S SILVER 02	1
52	60003040010	FOOTREST RUBBER FRONT L/S 03	1
53	60003041010	FOOTREST RUBBER FRONT R/S 03	1

C126210310

* NEW PART

X ON DEMAND

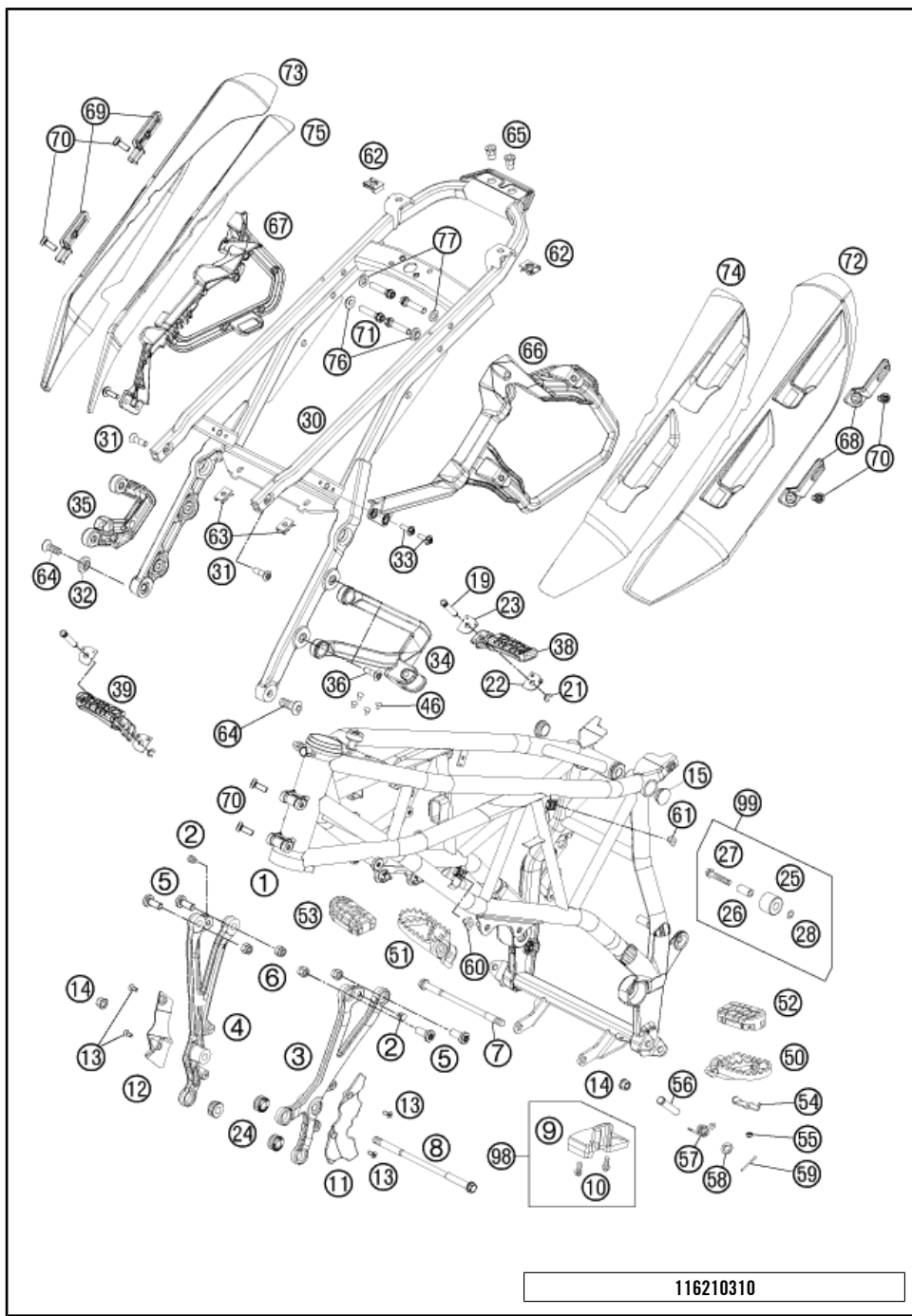

116210310

POS	PARTNUMBER	PARTNAME	PIECE
54	60003044010	CLOSING PANEL FRONT L/S R/S 03	2
55	0985050003	SELF LOCKING NUT DIN0985-M 5	2
56	54803044000	PIN FOR FOOT PED 51.5X9.8 MM	2
57	54603041000	FOOTREST SPRING L/S & R/S	2
58	0125100003	WASHER DIN0125-A10,5	2
59	0094032253	PIN DIN0094-3,2X25 STEEL	2
60	60003095100	CAGE NUT M8	2
61	60011038000	CAGE NUT M6 SL K100-1 1,5MM	2
62	54603048000	RANGE CHANGE METAL NUT M8	2
63	54603048100	RANGE CHANGE METAL NUT M6	2
64	0019100239S	COUNTERSUNK SCREW ISA45 M10X23	2
65	61003002080	BLIND RIVET NUT M8 HUC/ROF 5 0	2
66	62008041050	SUPPORT SIDE PART L/S	1
67	62008042050	SUPPORT SIDE PART R/S	1
68	62008041070	BAG SUPPORT L/S CPL.	2
69	62008042070	BAG SUPPORT R/S CPL.	2
70	0035080206S	AH-COLLAR SCREW M8X20 ISA45	8
71	0025080356	HH COLLAR SCREW M8X35 TX40	4
72	62005090000	HEAT SHIELD L/S 09	1
73	62005091000	HEAT SHIELD R/S 09	1
74	62005090050	THERMAL PROTECTION FOIL L/S	1
75	62005091050	THERMAL PROTECTION FOIL R/S	1
76	0125080003	WASHER DIN0125-A 8,4	2
77	54803013050	BUSHING F.REINFORCING	2
98	60004076110	CHAIN SLIDING KIT BELOW	x
99	58403060010	CHAIN ROLL KIT 06-13	1

C126210310

* NEW PART

X ON DEMAND

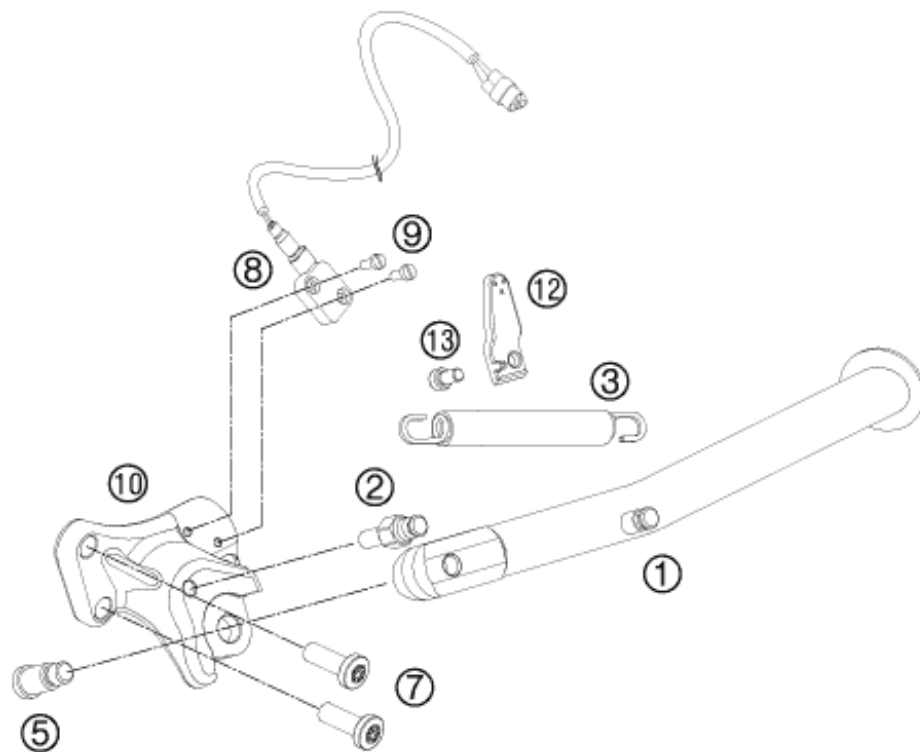

POS	PARTNUMBER	PARTNAME	PIECE
1	6250302300033	SIDE STAND L=236MM 07	1
2	76503028001	SPECIAL SCR. SIDE STAND SPRING	1
3	61003024000	SPRING L=116 MM 05	1
5	62503027200	SCREW FOR SIDE STAND M10X31,2	1
7	0035100309S	AH-COLLAR SCREW M10X30 ISA45	2
8	61011045000	SIDE STAND SENSOR 05	1
9	0084040103	CYL.HEAD SCREW DIN84A M4x10	2
10	62603026000	SIDE STAND BRACKET	1
12	60103029050	MAGNET HOLDER ADV. 06	1
13	014580060126	CYL. SCREW DIN14580 M 6X12	1

116210360

C116210360

* NEW PART

X ON DEMAND

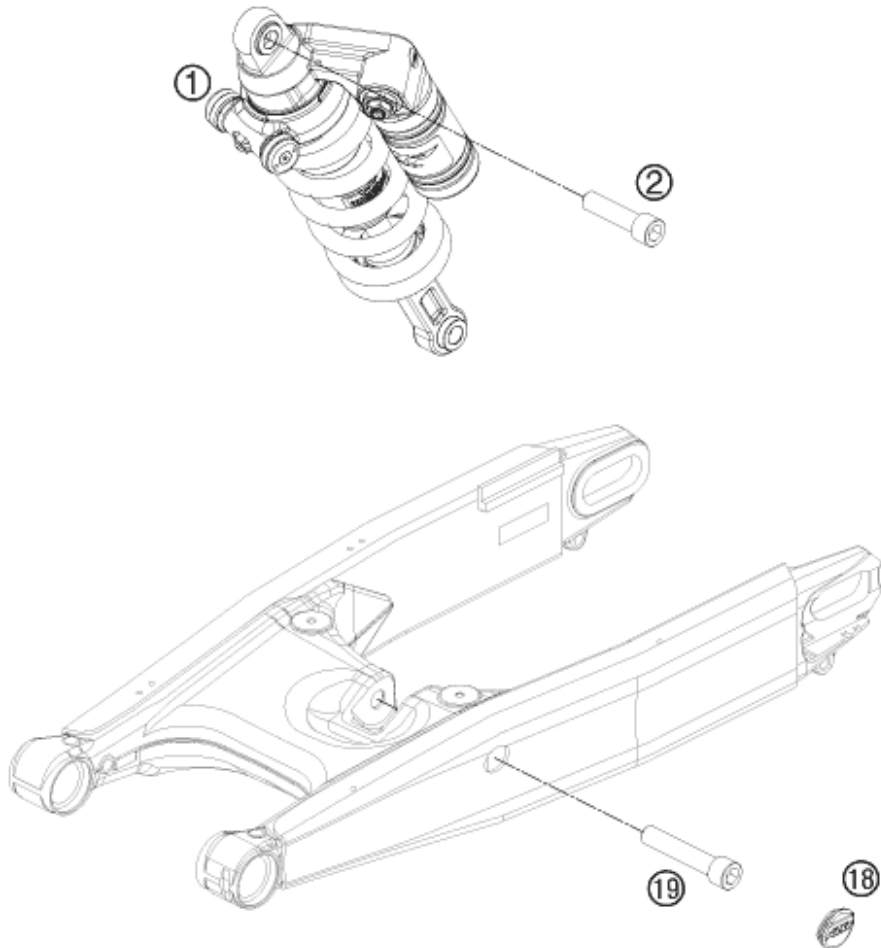

POS	PARTNUMBER	PARTNAME	PIECE
1*	15187L2001	MONOSHOCK SM-T 2012	1
2	60004016000	SCREW M14X1,5 L=55MM 03	1
18	60004041000	PLUG SWINGARM 03	1
19	60004017000	SCREW M14X1,5 L=73MM 03	1

126210410

C126210410

* NEW PART

X ON DEMAND

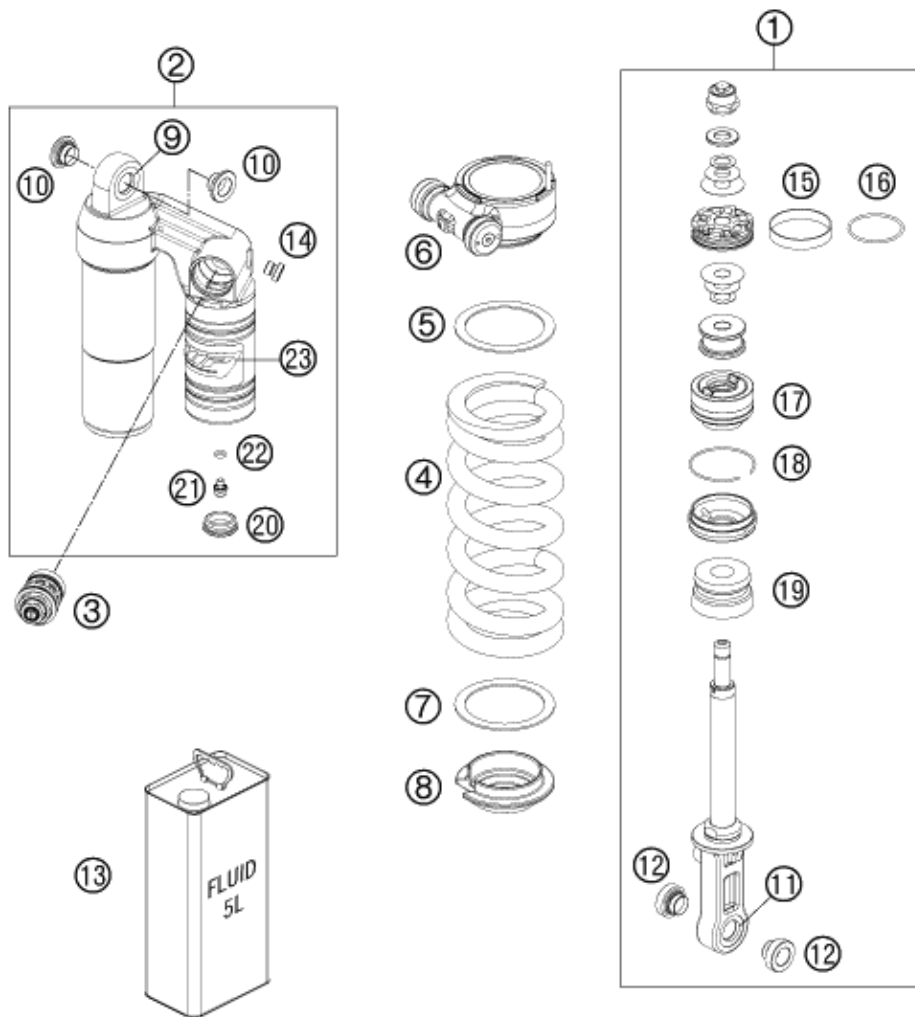

POS	PARTNUMBER	PARTNAME	PIECE
1	46180654S11	MONOSHOCK LOWER PART 990 SM-T	1
2*	46181056S1	MONOSHOCK CASE CPL.	1
3	50180213S6	DCC-COMPR.DAMP.CONTROL CPL. 04	1
4*	91010318	SPRING 150-195(59) D13,5 ORANG	1
5*	46180737	INTERMEDIATE RING D59	1
6*	15000L20	PA 4618 CPL. SM-T	1
7	50180410	INTERM.RING D=58	1
8	46180396	SPRING RETAINER H=15 D=28	1
9	R12012	REP. KIT BEAR./SEAL UP. 07	1
10	50180366	ADAPTOR BUSH KGW 14X24	2
11	R15009	BEARING KIT KGW 1525 990 DUKE	1
12	46180362	% ADAPTOR BUSH KGW 14X32 07	2
13	50180751S1	SHOCK ABSORBER FLUID 5 LT	1
14	50180095	BLEED PLUG R 1/8	1
15	46810361	PISTON RING	1
16	46810035	O-RING VITON 37,82X1,78	1
17	46180669S	ADAPTOR CPL. D=46 H=28 07	1
18	46810010	CIRCLIP 49X1,5	1
19	46180365	BUMP RUBBER WP60 H=30 D=18-26	1
20	46811208	RUBBER CAP "DO NOT OPEN"	1
21	36120151	SCREW PLUG M5X6	1
22	46810893	O-RING NBR 5,28X1,78	1
23*	52000088	STICKER WP 35X75	1

126210430

C126210430

* NEW PART X ON DEMAND

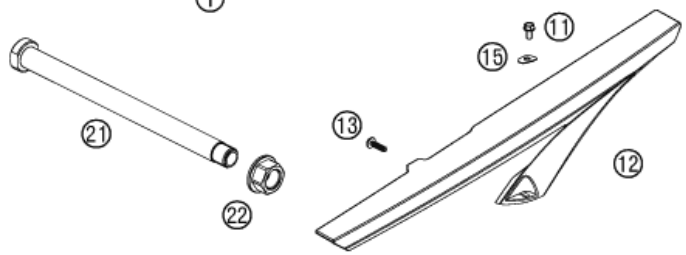
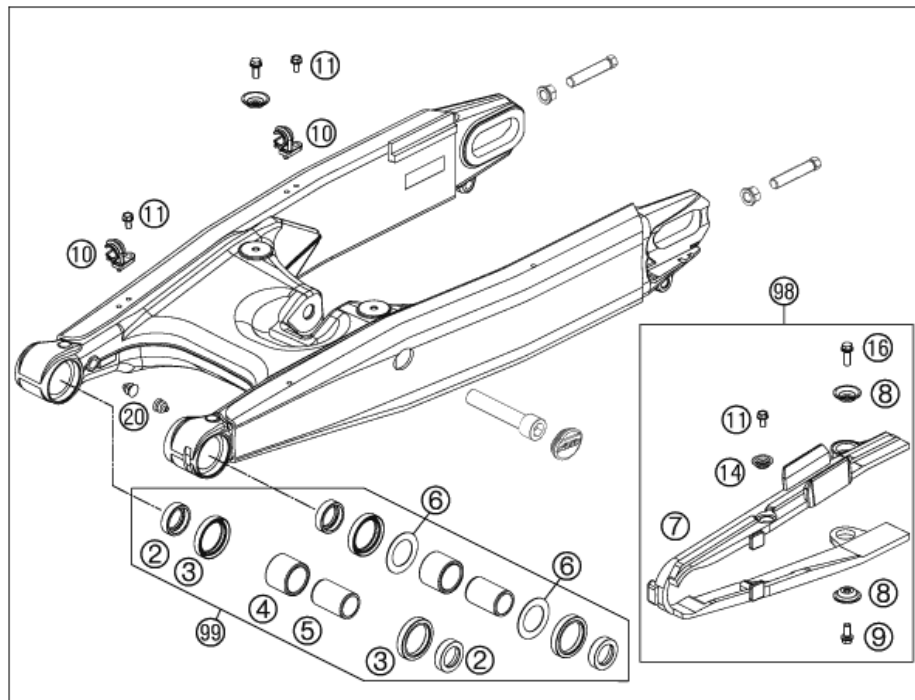

116210490

POS	PARTNUMBER	PARTNAME	PIECE
1	6100403004433	SWING ARM CPL. SM-R SD-R 07	1
2	60004034000	BUCKET F. SHAFT SEAL RING 03	4
3	0760304073	SHAFT SEAL RING 30X40X7	4
4	60004032000	INNER RING JR20X25X38,5 03	2
5	60004031000	NEEDLE BUSH HK2526B 03	2
6	60004033000	STOP DISK 03	2
7	63004066100	CHAIN SLID.GUARD SWINGARM 10	1
8	72210079000	BUCKET	2
9	59009062013	SPECIAL SCREW M6X13 WS=8 10.9	1
10	60104042000	RET. CLAMP F. BRAKE HOSE	2
11	0009050106	EJOT SPIRAL SCREW SF M5X10-K	3
12	61004060000	CHAINGUARD 05	1
13	0081050181	SCREW FOR PLASTIC K50X18 T20	1
14	46104066050	BUSH FOR CHAINSLIDER GUARD 02	1
15	61004060050	WASHER CHAINGUARD 05	1
16	59009062016	SPECIAL SCREW M6X16 WS=8 10.9	1
20	60004042000	PLUG SFL12 GREY 05	2
21	60004037244	SWINGARM BOLT CPL.	1
22	60004038000	COLLAR NUT M19X1,5 WS=27MM 03	1
98	60004066110	CHAIN GUARD KIT	x
99	60004230010	SWINGARM REP. KIT	1

C126210490

* NEW PART X ON DEMAND

EXHAUST SYSTEM

990 SUPERMOTO T ORANGE ABS EU 2012

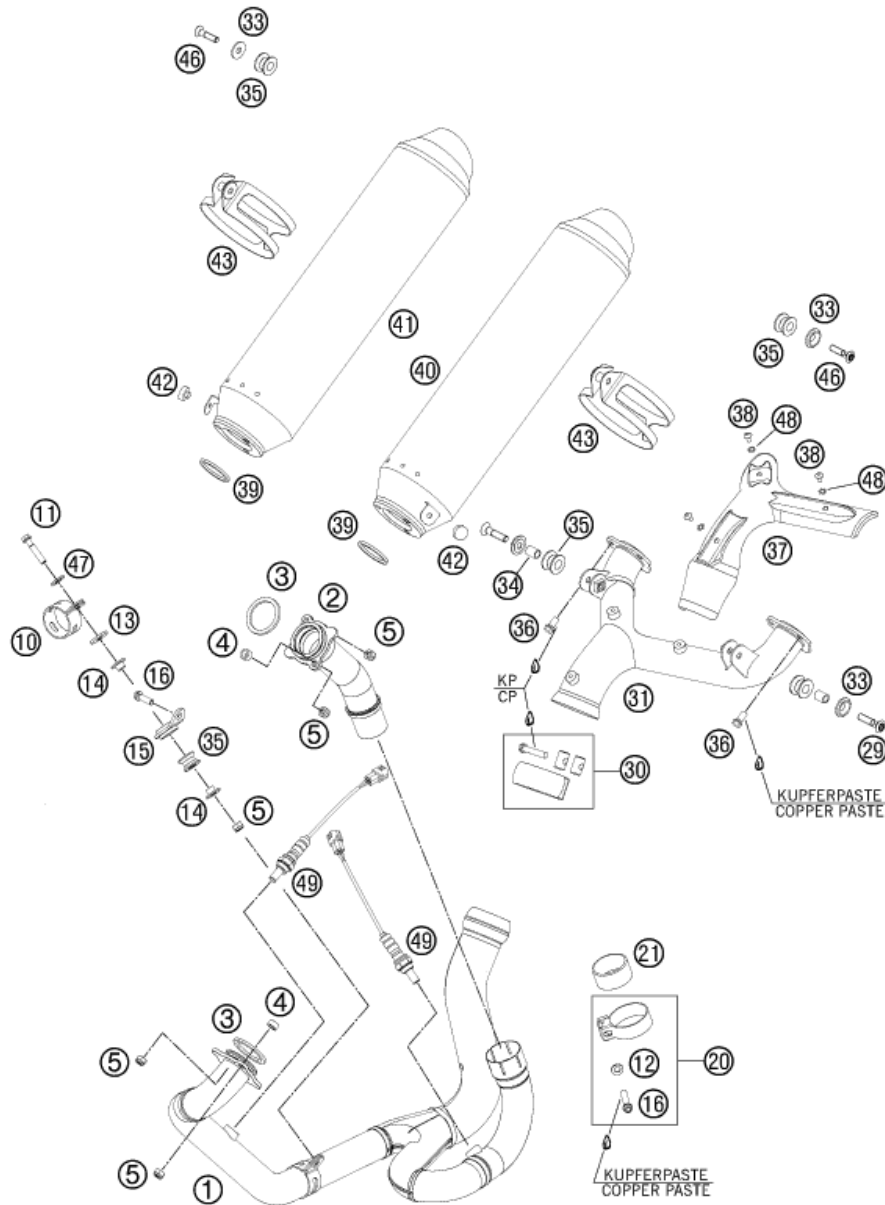

POS	PARTNUMBER	PARTNAME	PIECE
1	62605007000	EXHAUST MANIFOLD	1
2	61105008000	EXHAUST PIPE REAR 07	1
3	61005005000	EXHAUST GASKET 05	2
4	61005009000	SPACER BUSH. 8,5X15X7,5 05	2
5	51010086100	SELF LOCKING NUT M 8 CU	5
10	61005007049	CLAMP EXHAUST PIPE 05	1
11	0025080406	HH COLLAR SCREW M8X40 TX40	1
12	0125080003	WASHER DIN0125-A 8,4	1
13	51005067000	INSULATE WASHER 8,5X28X3	1
14	58405050065	COLLAR BUSH 8,5X12X23,5X10	2
15	62505015150	EXHAUST PIPE BRACKET FRONT 07	1
16	0025080356	HH COLLAR SCREW M8X35 TX40	2
20	61105051000	EXHAUST CLAMP 52,2MM 07	1
21	58405005001	GRAPHITRING 45X50X25	1
29	0019080356	COUNTERSUNK SCREW ISA45 M8X35	2
30	61005052000	EXHAUST CLAMP CPL. 05	1
31	62505048100	DISTRIBUTOR TUBE 05	1
32	0025080306	HH COLLAR SCREW M8X30 TX40	4
33	62603061000	SPECIAL WASHER 8X24 ALU H=4,2	4
34	62505069000	SPACER BUSH. 8,5X12X18MM 05	2
35	54305068100	DAMP. COMPONENT SILICONE GREY	5
36	0025080166	HH COLLAR SCREW M8X16 TX40	6
37	62505047000	THERMAL SHIELD 05	1
38	78105081010	SCREW TORX M5X10	3
39	60005005002	EXHAUST GASKET 03	2
40	62605082000	SILENCER L/S 08	1
41	62605083000	SILENCER R/S 08	1
42	54308042000	RUBBER BUFFER	2
43	60005095000	CLAMP FOR SILENCER CPL. 03	2
46	0019080306S	COUNTER-SUNK SCREW ISA45 M8X30	2
47	0021080003	WASHER DIN9021-A 8,4	1
48	07970500000	TOOTH LOCK WASHER DIN6797-J	3
49	61041090000	LAMBDA SENSOR 05	2

116210510

C116210510

* NEW PART

X ON DEMAND

AIR FILTER BOX

990 SUPERMOTO T ORANGE ABS EU 2012

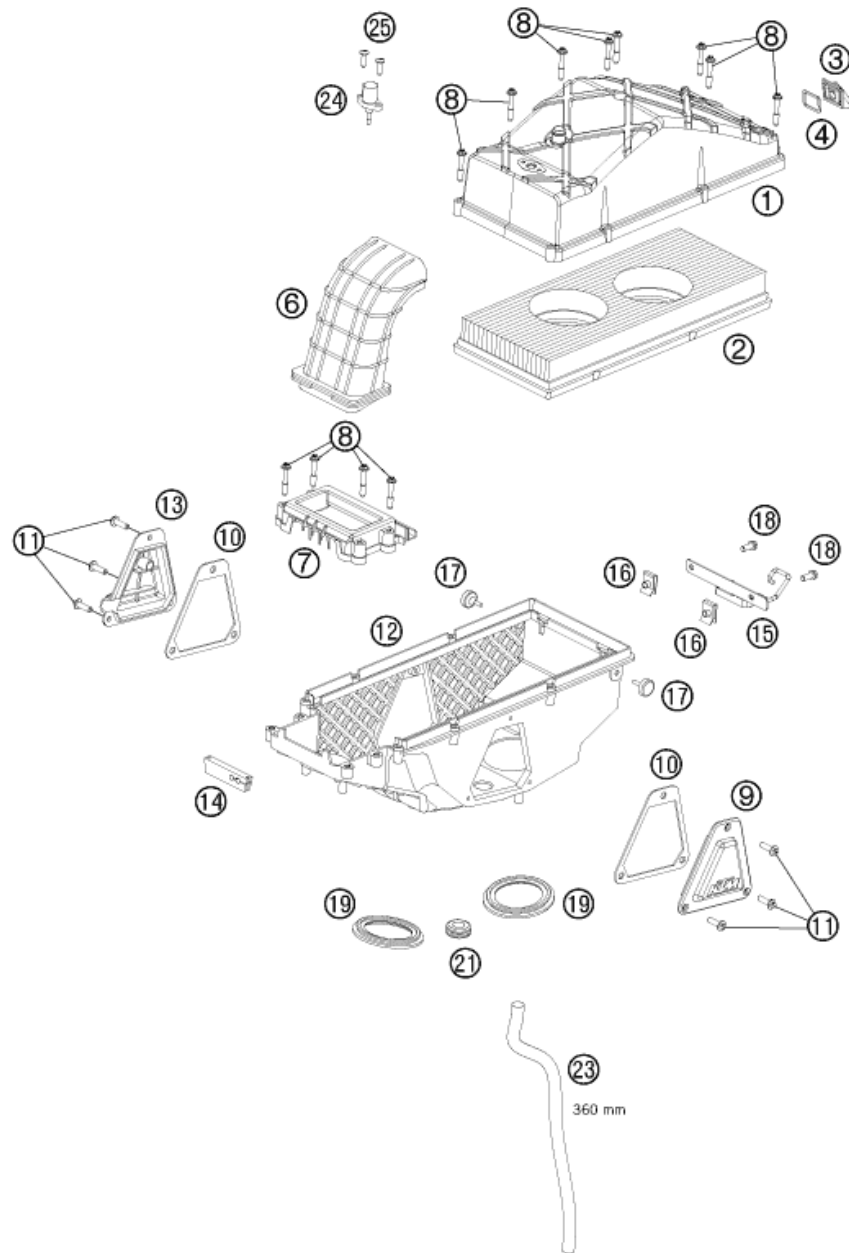

POS	PARTNUMBER	PARTNAME	PIECE
1	61006002000	AIRBOX COVER 990 DUKE 04	1
2	61006015000	AIR FILTER EFI 05	1
3	60006007000	CONNECTOR FOR SAS LC8 03	1
4	60006007050	GASKET SAS CONNECTOR 03	1
6	60006040000	INTAKE SNORKEL 03	1
7	60006004000	AIRBOX FRONT PART LC8 03	1
8	60006006000	SPECIAL SCREW K60X35/15 03	12
9	60006003002	AIRBOX COVER L/S R/S 03	1
10	60006003050	GASKET F. AIRBOX COVER L/S R/S	2
11	0017060203	% EJOT PT SCREW K60X20 WS=6	6
12	61006001000	FILTER BOX LOWER PART 990 05	1
13	61006003002	AIRBOX COVER R/S EFI 05	1
14	61006001030	RUBBER SLEEVE F. THR. CABLE 05	1
15	62106001020	SLS BRACKET PANEL	1
16	54603048100	RANGE CHANGE METAL NUT M6	2
17	60006001021	DISTANCE RUBBER AIRBOX 03	3
18	0025060166	HH COLLAR SCREW M6X16 TX30	2
19	60036045000	RUBBER SLEEVE AIRBOX 03	2
21	60006001041	RUBBER SLEEVE FUEL HOSE 03	1
23	57005020001	HOSE 10X14 PER METER	0
24	61041080000	AMBIENT-AIR TEMPERATURE SENSOR	1
25	0081050181	SCREW FOR PLASTIC K50X18 T20	2

116210610

C126210610

* NEW PART

X ON DEMAND

TANK, SEAT, COVER

990 SUPERMOTO T ORANGE ABS EU 2012

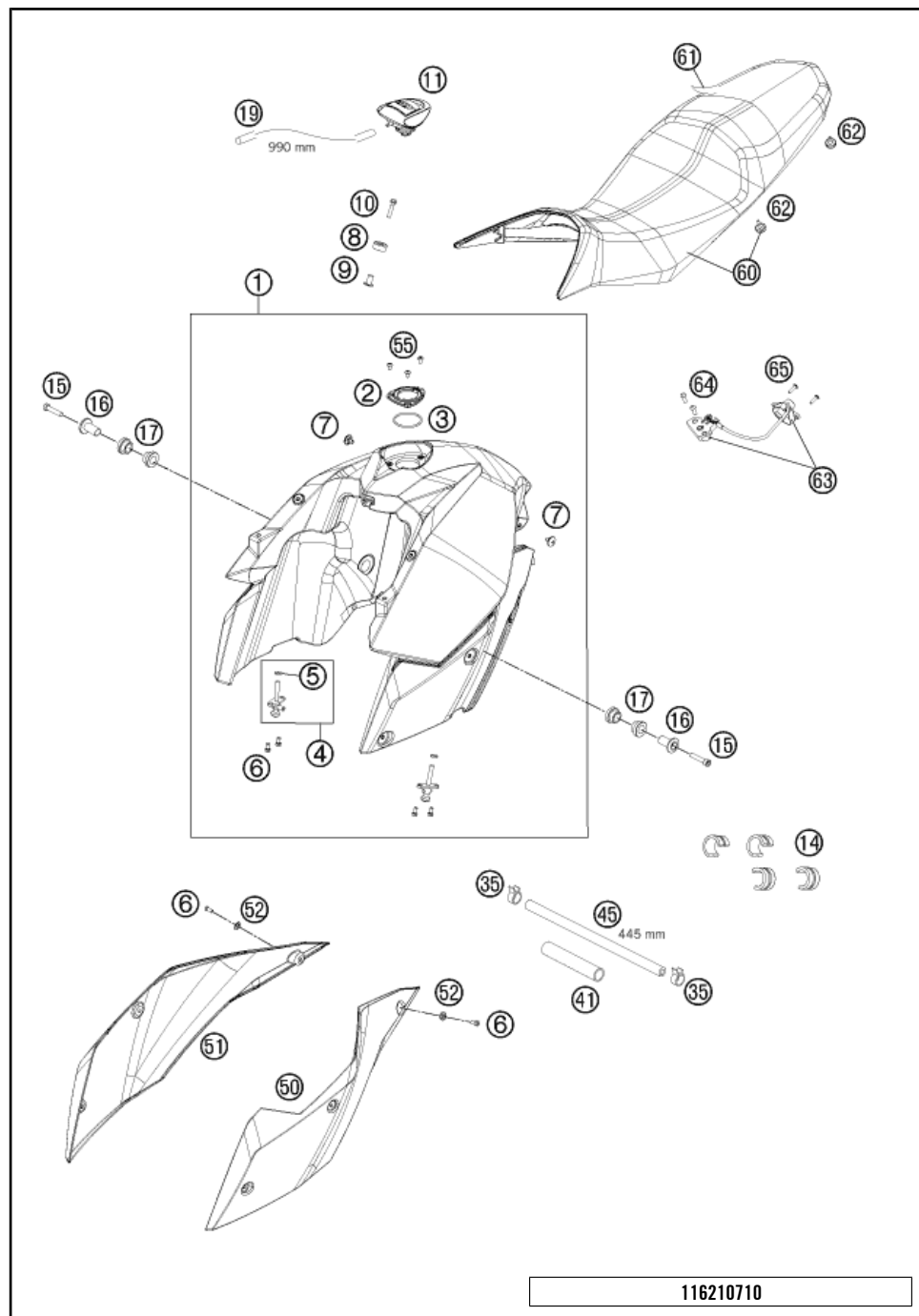

POS	PARTNUMBER	PARTNAME	PIECE
1	6200701304404A	FUEL TANK CPL. ORANGE 2011	1
2	76507008050	% CLOSURE FLANGE	1
3	0770050030	O-RING 50,00X3,00 VITON	1
4	58507003200	FUEL COCK CPL.	2
5	0770020130	O-RING 1,78x10,82x14,38 2-013	2
6	014580060126	CYL. SCREW DIN14580 M 6X12	10
7	58407011100	SCREW FOR SEAT M6X11,5/8	2
8	50307014000	TANK ROLLER 12X26X12 '98	1
9	62503009000	COLLAR BUSHING 9,5X18X19,8X1,5	1
10	0025060306	HH COLLAR SCREW M6X30 TX30	1
11	58407008300	TANK PLUG	1
14	61007014000	SPACER FUEL TANK 05	4
15	0912080403	AH SCREW DIN912 M8X40	2
16	61007060000	BEARING BUSHING OUTSIDE 05	2
17	61007065000	TANK RUBBER BUSHING FRONT 05	4
19	60007026001	% HOSE NBR 5,4X9,4 PER METER	x
35*	62607017000	YDNAC CLAMP 12,5MM	2
41	62507016050	THERMAL PROTECTION L=105MM 05	1
45	60007216445	HOSE 6X13 L=445 MM 08	1
50	6260805000030B	SPOILER L/S BLACK-BRILLANT	1
51	6260805100030B	SPOILER R/S BLACK-BRILLANT	1
52	60008045000	SPECIAL WASHER D=16,5MM 03	6
55	58605083010	% SCREW TORX M5X10 05	3
60	62007040000	SEAT CPL.	1
61	62007040050	SEAT COVER	1
62	60006001021	DISTANCE RUBBER AIRBOX 03	4
63	62607050000	SEAT LOCK	1
64	0738060181	COU.SUNK SCR. AH ISO7380 M6X18	2
65	0081050181	SCREW FOR PLASTIC K50X18 T20	2

116210710

C126210710

* NEW PART

X ON DEMAND

FUEL PUMP

990 SUPERMOTO T ORANGE ABS EU 2012

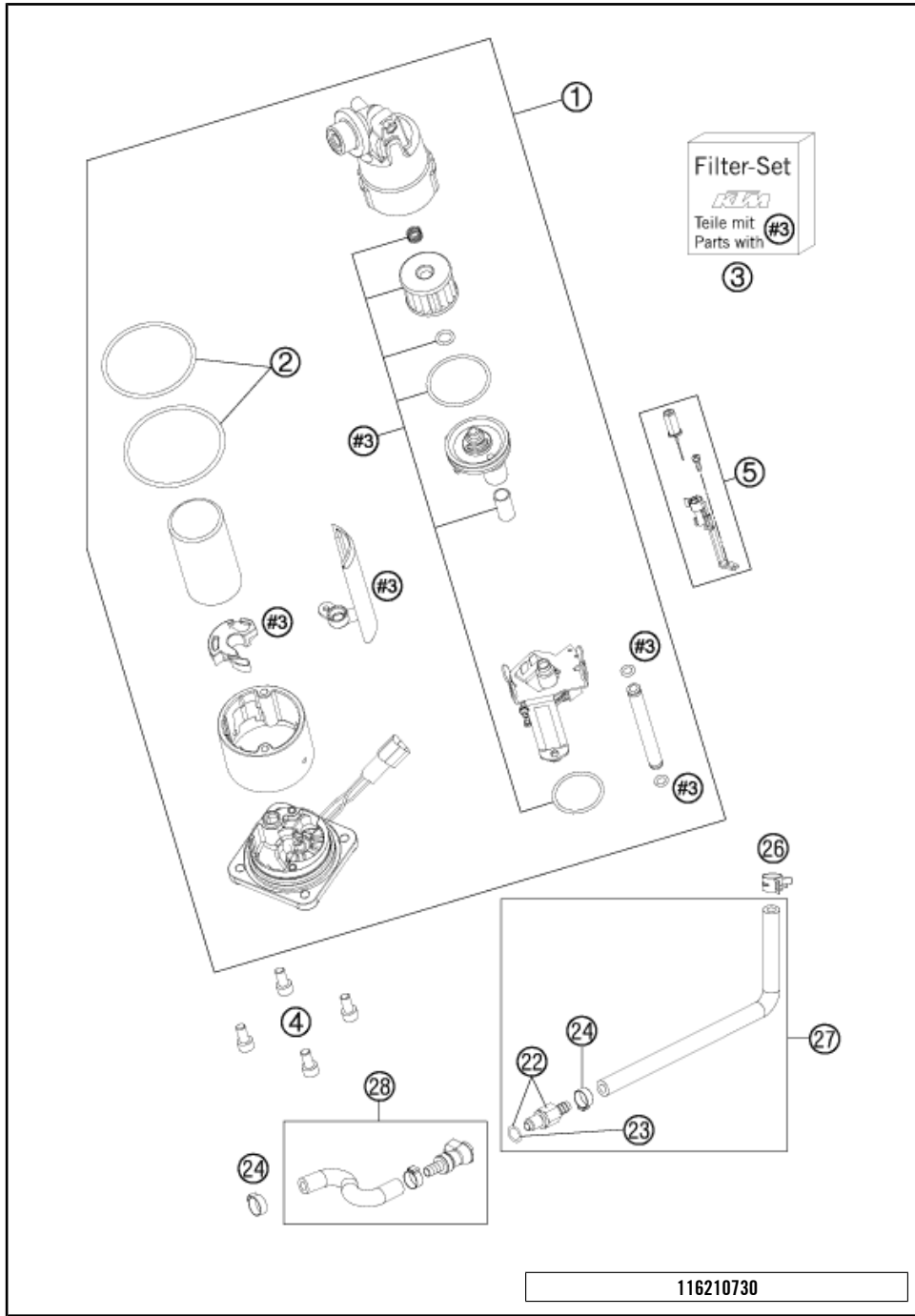

POS	PARTNUMBER	PARTNAME	PIECE
1	61007088200	PUMP WITHOUT RESERVE INDICATOR REQUIRED: ITEM NUMBER 5	1
2	61007089000	O-RING SET FOR FUEL PUMP 05	1
3	61007090100	FILTER-SET FUEL PUMP	1
4	014580060166	CYL. SCREW DIN14580 M 6X16	4
5	62612045000	CONV. KIT FUEL RESERVE INDICAT	1
22	5850701030030	PLUG CPC BLACK 05	1
23	58507012000	O-RING VITON F. PLUG CPC 05	1
24	00050157706	VARIABLE ONE-EAR CLAMP 15,7MM	2
26	00049140121	CLAMP STD DN14	1
27	61007116050	FUEL HOSE 1 CPL.	1
28	62607016044	FUEL HOSE CPL.	1

116210730

C116210730

* NEW PART X ON DEMAND

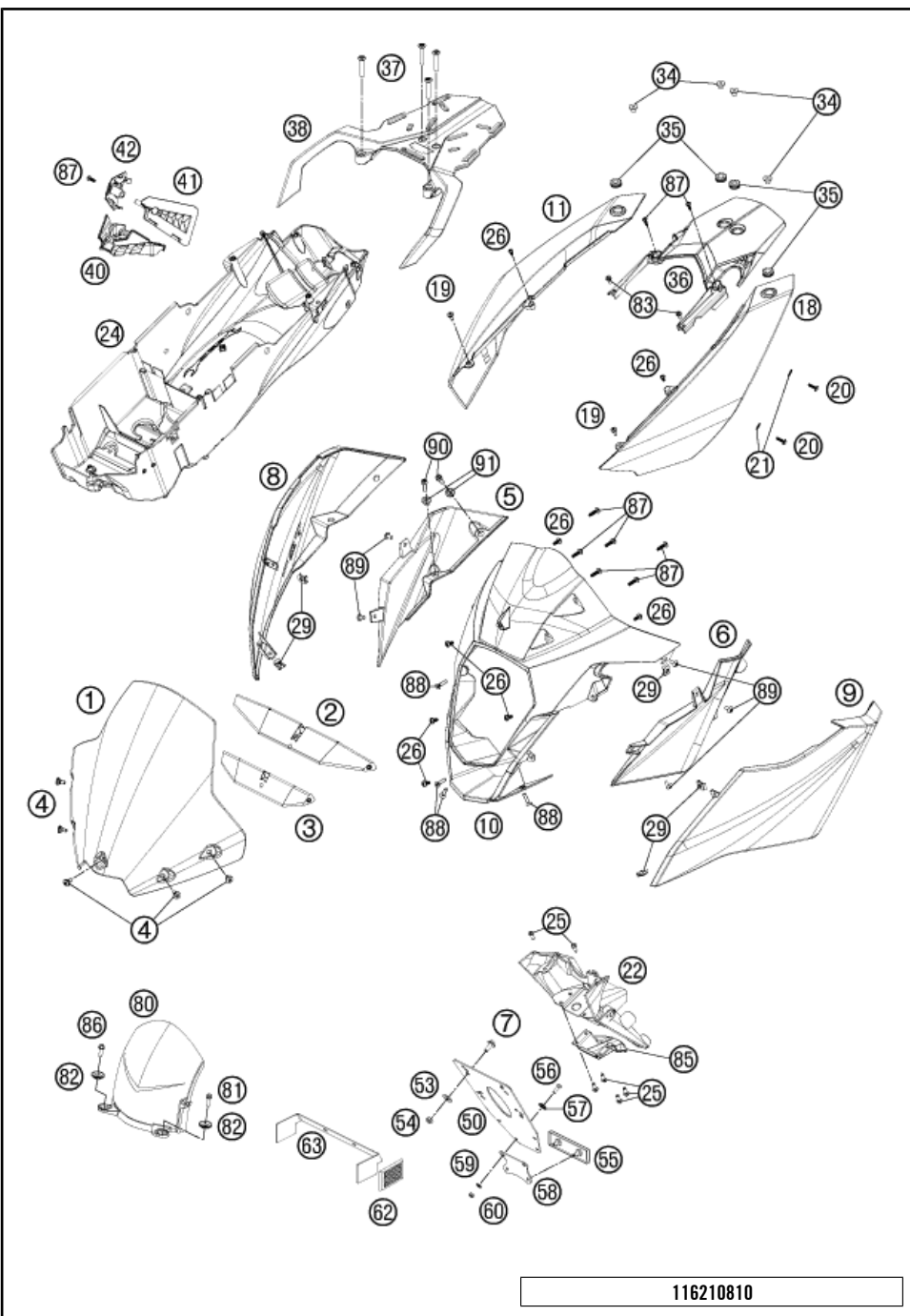

POS	PARTNUMBER	PARTNAME	PIECE
1	62008108000	WIND SHIELD USA	1
2	62008008050	WIND SHIELD SUPPORT UPPER	1
3	62008008060	WIND SHIELD SUPPORT LOWER	1
4	69008021160	SPECIAL SCREW M5X12	5
5	62008003050	MASKSPOILER INNER PART R/S 09	1
6	62008002050	MASKSPOILER INNER PART L/S 09	1
7	0024060156	HH COLLAR SCREW M6X15 TX30	4
8	6200800300004A	MASK SPOILER R/S	1
9	6200800200004A	MASK SPOILER L/S	1
10	6200800100030	HEADLIGHT MASK	1
11	6260804210030B	SIDE COV. R/S REAR BLACK-BRILL	1
18	6260804110030B	SIDE COV. L/S REAR BLACK/BRILL	1
19	69008021060	SPECIAL SCREW M5X17	2
20	62008043000	EJOT ALTRACS SCHR.WN5151 50X16	4
21	75008023000	WASHER REAR-UT D=14MM	4
22	62508015000	NUMB.Plate CARRIER 05	1
23	0024060136	HH COLLAR SCREW M6X13 TX30	2
24	62108019000	REAR END LOWER PART 11	1
25	0017060203	% EJOT PT SCREW K60X20 WS=6	6
26	0081050121	SCREW FOR PLASTIC K50X12 T20	8
29	69008021080	RANGE CHANGE METAL NUT M5	6
34	60012008002	COLLAR BUSHING 8,2X12X20X9 03	4
35	41001052000	RUBBER SLEEVE D=12MM	4
36	6260801310030	REAR FENDER BLACK 08	1
37	0019080456	COUNTERSUNK SCREW ISA45 M5X45	4
38	62012010033	BAGGAGE CARRIER CPL	1
40	60003087000	SPLASH PROTECTOR FRAME 05	1
41*	62603185000	COVER STEARING HEAD UP.L/S	1
42*	62603186000	COVER STEARING HEAD UP.R/S	1
50	60012081200	LICENCE FITTING 06	1
53	0021060003	WASHER DIN9021-A 6,4	4
54	0985060003	SELF LOCK. NUT DIN0985-M 6	4
55	58412080000	REFLECTOR RED	1
56	0966050163	OVAL HEAD SCREW DIN0966-M 5X16	2
57	40006006000	WASHER 6MM	2
58	58412080050	BRACKET FOR REFLECTOR	1
59	0125050003	WASHER DIN0125-A 5,3	2
60	0985050003	SELF LOCKING NUT DIN0985-M 5	2

116210810

C126210810

* NEW PART X ON DEMAND

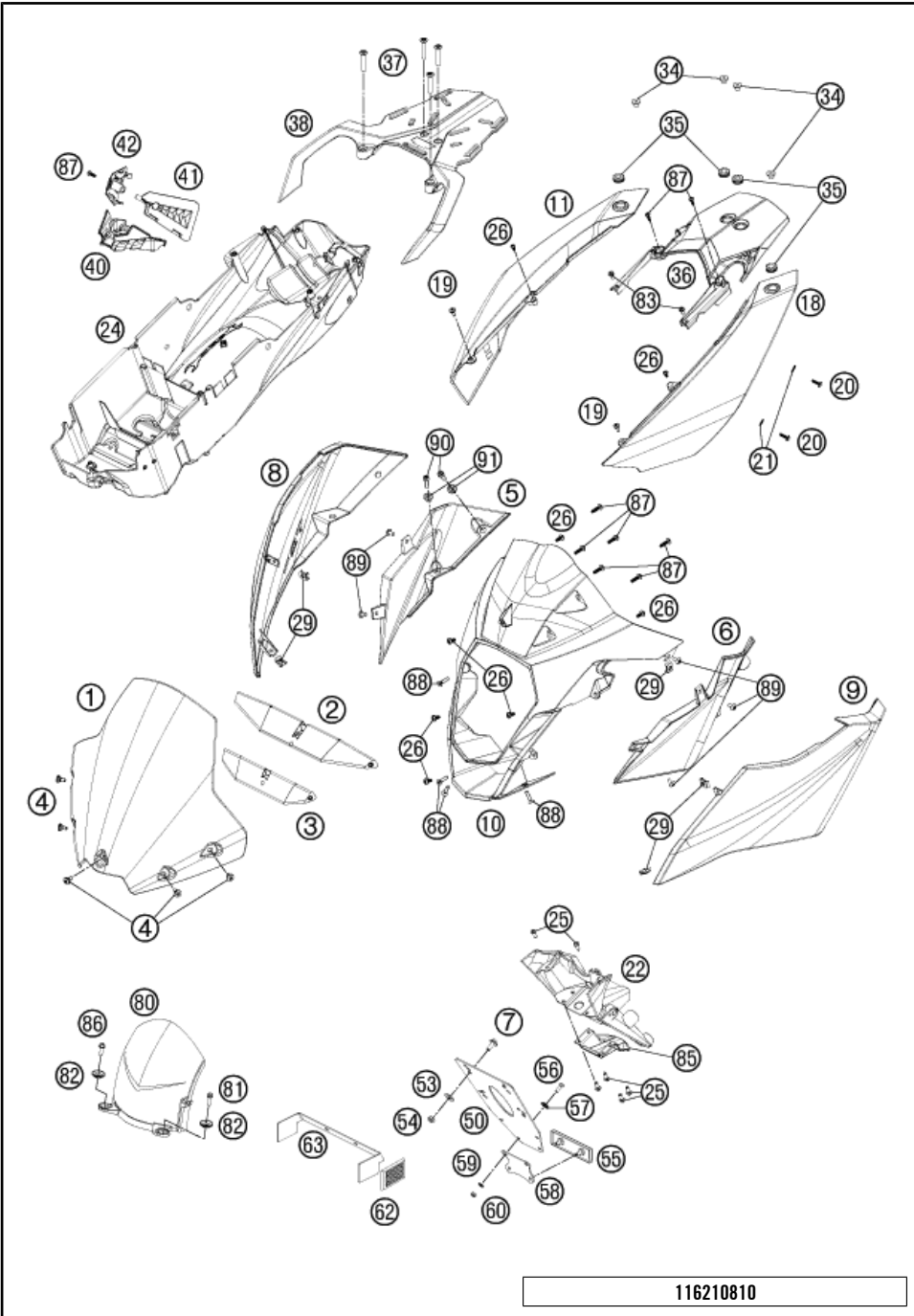

116210810

POS	PARTNUMBER	PARTNAME	PIECE
62	16512180100	SIDE REFLECTOR RED REAR	2
63	62512081000	BRACKET SIDE REFLECTOR 06	1
80	61008014000	SPLASH PROTECT. 05	1
81	59009062016	SPECIAL SCREW M6X16 WS=8 10.9	1
82	72210079000	BUCKET	2
83	0025050126	HH COLLAR SCREW M5X12 TX30	2
85	62608015001	COVER NUMB. PLATE CARRIER	1
86	59009062013	SPECIAL SCREW M6X13 WS=8 10.9	1
87	0081050181	SCREW FOR PLASTIC K50X18 T20	10
88	0019050201	COUNTERSUNK SCREW ISA25 M5X20	4
89	58605083010	% SCREW TORX M5X10 05	6
90	014580060166	CYL. SCREW DIN14580 M 6X16	4
91	75001094010	BUSHING MUD FLAP 07	4

C126210810

* NEW PART

X ON DEMAND

DECAL

990 SUPERMOTO T ORANGE ABS EU 2012

POS	PARTNUMBER	PARTNAME	PIECE
1	6210809500030	STICKER FUEL TANK "KTM'3D"	1
2	62108099000	DECALSET 990 SUPERMOTO T 11	1

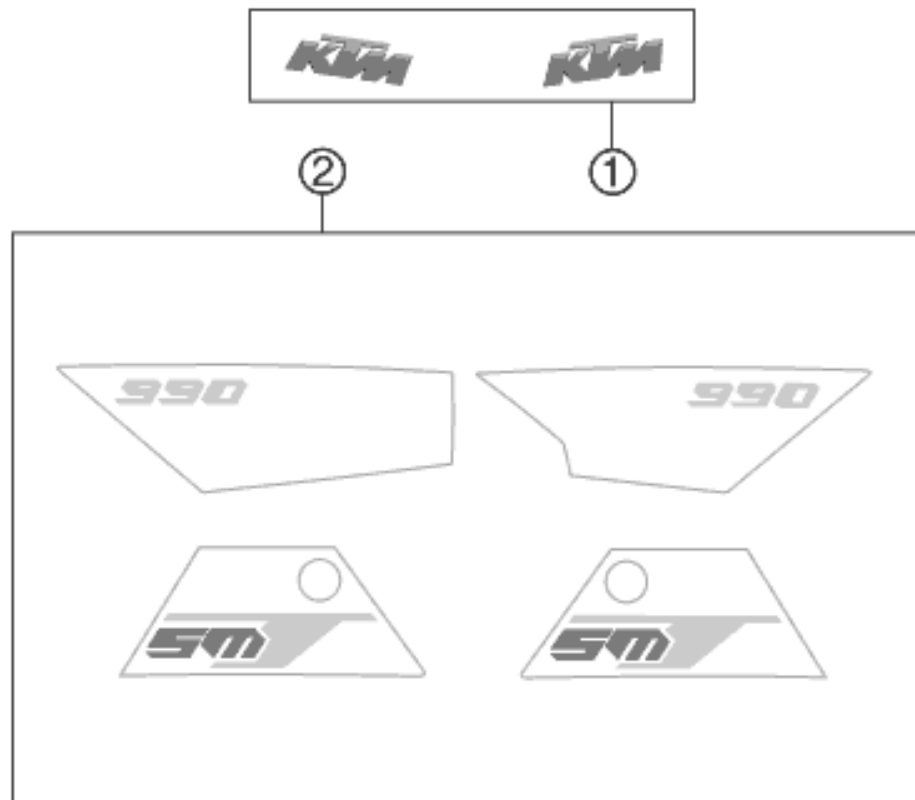

116210830

C126210830

* NEW PART

X ON DEMAND

FRONT WHEEL

990 SUPERMOTO T ORANGE ABS EU 2012

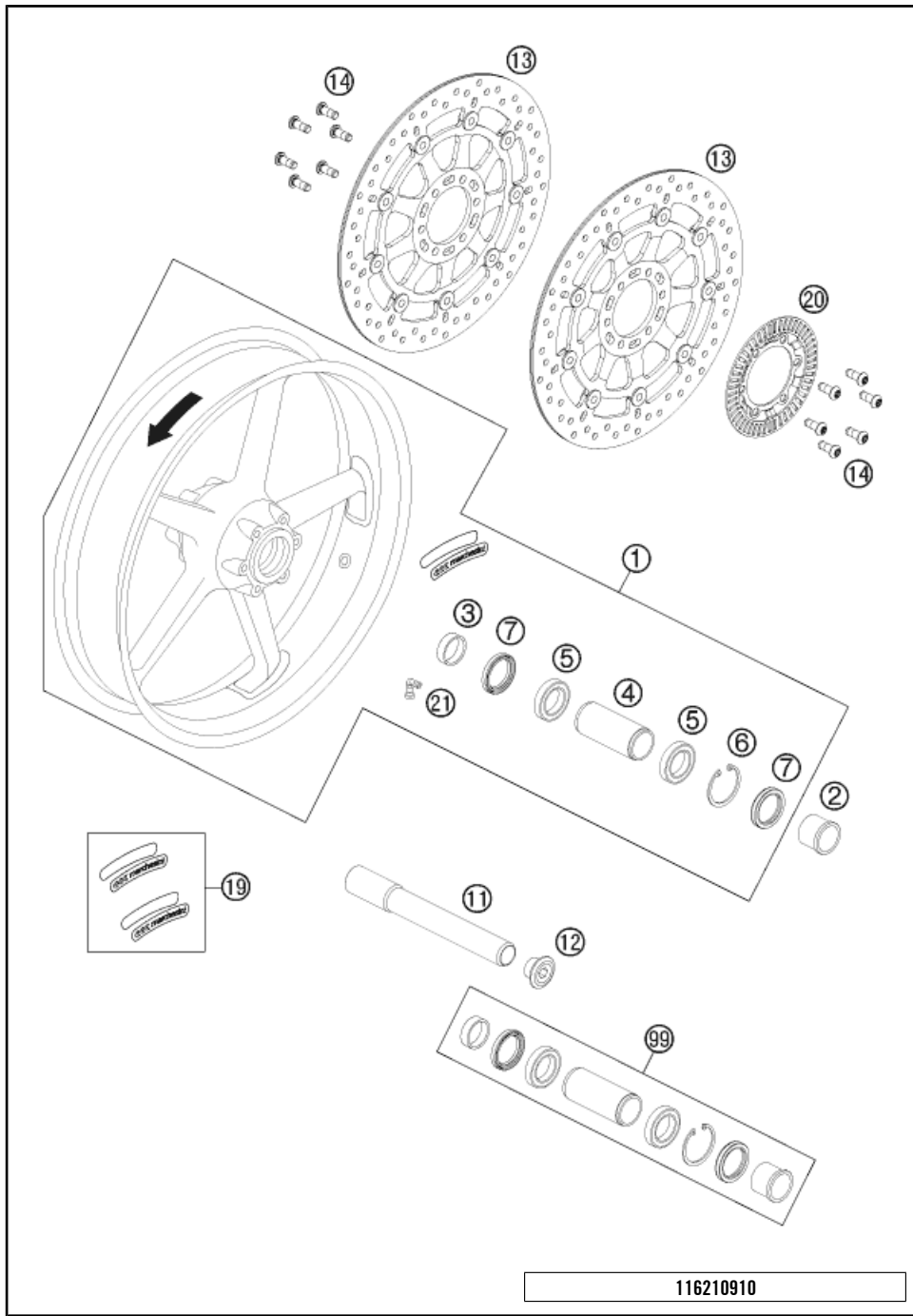

POS	PARTNUMBER	PARTNAME	PIECE
1	6100900114430	FRONT WHEEL CPL. BLACK 10	1
2	61009012000	SPACER BUSH. FR. WHEEL L/S 05	1
3	60009013000	SPACER BUSH. FR. WHEEL R/S 03	1
4	61009011000	BEARING SPACER TUBE FRONT 05	1
5	0625069068	GR.BALL BEAR.6906 DDU2CG23S6NM	2
6	0472048175	LOCK RING DIN0472-48X1,75	1
7	0760354771	SHAFT SEAL RING 35X47X7 TC	2
11	61009081000	WHEEL SPINDEL FRONT 05	1
12	61009082000	AH SCREW M25X1,5 WS=12 05	1
13	6210906000030	BRAKE DISC D=305MM 11	2
14	76009062000	SPECIAL SCREW M8X25 SS TX40	12
19	00050000120	STICKER MARCH. 2L/S+2R/S WHITE	1
20	62142020000	SENSORGEAR FRONT	1
21	61009076000	VALVE ANGLED 90° 05	1
99	61009015000	FRONT WHEEL REP. KIT	x

116210910

C126210910

* NEW PART X ON DEMAND

REAR WHEEL

990 SUPERMOTO T ORANGE ABS EU 2012

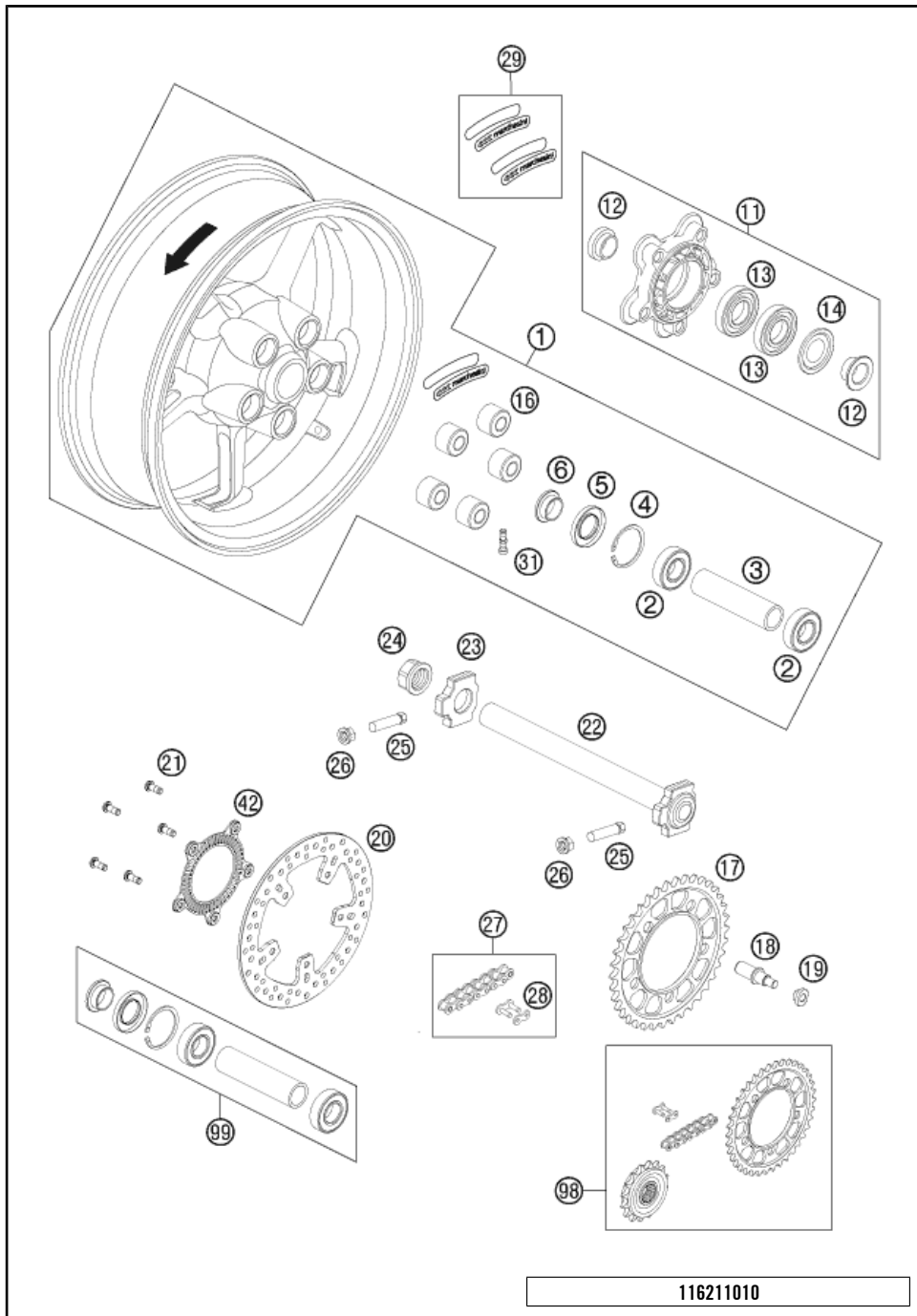

POS	PARTNUMBER	PARTNAME	PIECE
1	6101000114430	REAR WHEEL CPL. BLACK 11	1
2	0625062052	GR.BALL BEAR. 6205-2RSHC3HMTF7	2
3	61010011000	BEARING SPACER TUBE REAR 05	1
4	0472052200	CIRCLIP DIN0472-52X2	1
5	0760305271	SHAFT SEAL RING 30X52X7	1
6	60110013000	SPACER BUSH. REAR WHEEL R/S 06	1
11	6901005004430	SPROCKET SUPPORT CPL. BLACK	1
12	69010012000	SPACER CHAIN WHEEL SUPPORT	2
13	0625060060	BALL BEARING 6006 DDU2CG23S6NM	2
14	60110016000	NILOS RING 6006AV	1
16	61010059000	DAMPING RUBBER 05	5
17	61010051138	REAR SPROCKET 38-T STEEL 05	x
17	61010051139	REAR SPROCKET 39-T STEEL 05	x
17	61010051140	REAR SPROCKET 40-T STEEL 05	x
17	61010051141	REAR SPROCKET 41-T STEEL 05	1
17	61010051142	REAR SPROCKET 42-T STEEL 05	x
18	61010056000	BOLT FOR SPROCKET SUPPORT 05	5
19	61010057000	NUT REAR SPROCKET 05	5
20	61010060000	BRAKE DISK REAR D=240MM 05	1
21	76009062000	SPECIAL SCREW M8X25 SS TX40	5
22	60010081144	WHEEL SPINDLE REAR CPL.	1
23	60010084000	CHAIN TENSIONER R/S LC8 03	1
24	61010086000	COLLAR NUT M25X1,5 WS=32 05	1
25	50304040100	SCREW M10X1,25X50 WS=10	2
26	58414030000	HH COLLAR NUT M10X1,25 WS=13	2
27	60010165118	CHAIN 525 WITH MASTER LINK 03 CUT TO 112 CHAIN LINKS	1
28	60010066000	MASTER LINK FOR CHAIN 525 03 NEEDS RIVET TOOL	x
29	00050000120	STICKER MARCH. 2L/S+2R/S WHITE	1
31	58709076000	VALVE CPL. BREMBO DUKE 2003	1
42	62142021044	SENSORGEAR REAR	1
98	00050002012	DRIVETRAIN KIT SM/SMR 17T/41T	x
99	61010015000	REAR WHEEL REP. KIT	x

116211010

C126211010

* NEW PART X ON DEMAND

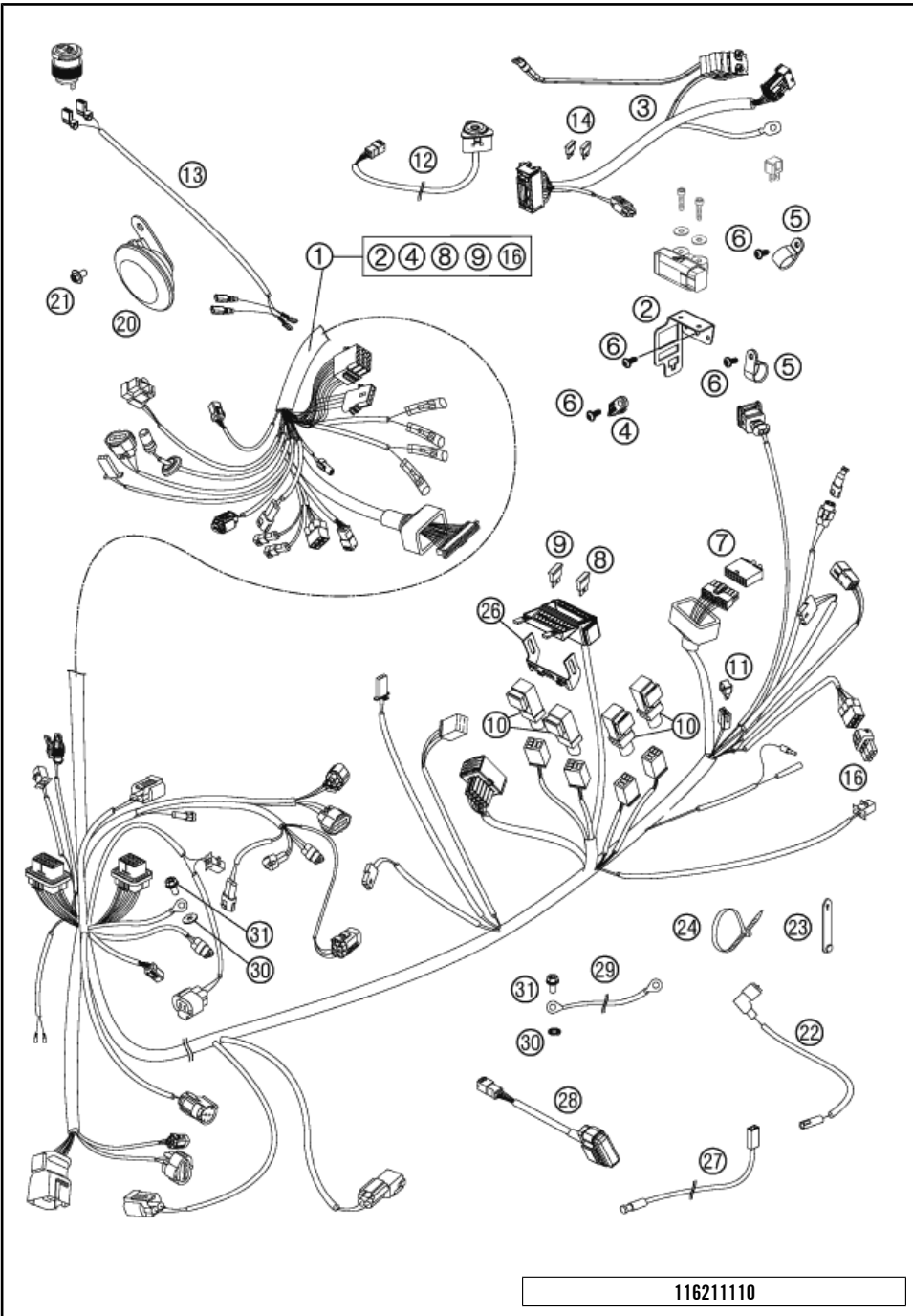

POS	PARTNUMBER	PARTNAME	PIECE
1	62111075000	MAIN WIRING HARNESS	1
2	62011083000	PLUG SUPPORT PANEL	1
3	62111079000	WIRING HARNESS ABS	1
4	62011094000	BRACKET CABELFIXING	1
5	57013070400	PVC CLAMP 17,4MM HEYCO 3381	2
6	0081050121	SCREW FOR PLASTIC K50X12 T20	6
7	61011075020	DUMMY PLUG ALARM SYSTEM 05	1
8	75011088015	FUSE 15A 07	x
9	75011088010	FUSE 10A 07	x
10	61111057000	RELAY CM1A-R-12V-H80 07	4
11	58411096100	DIODE S3H-15 97	1
12	60211022000	HAZARD WARNING BUTTON	1
13	62111042060	CABLE FOR SOCKET SMT	1
14	58011109130	FUSE 30 A	2
16	000700000BH	SPARE CONNECTOR BH 6-PINS	1
20	62511060000	DC HORN 05	1
21	0024060156	HH COLLAR SCREW M6X15 TX30	1
22	60011092000	OIL-PRESSURE SWITCH CABLE 03	1
23	60011093045	RUBBER CABLE TIE 45MM 03	x
23	60011093075	RUBBER CABLE TIE 75MM 03	x
24	44011076140	CABLE TIE 140/2,5MM BLACK	x
24	44011076200	CABLE TIE 200/3,6MM BLACK	x
26	62111087060	BRACKET FUSE BOX	1
27	61111018000	TEMPERATURE SENSOR 07	1
28	61111020000	STARTER INTERLOCK	1
29	60111097000	GROUND CABLE 100MM 06	1
30	58411098100	CONTACT WASHER M6 VSV-K6	2
31	0025060106	HH COLLAR SCREW M6X10 TX30	2

116211110

C126211110

* NEW PART

X ON DEMAND



POS	PARTNUMBER	PARTNAME	PIECE
1	60011053000	BATTERY 12V/11AH 03	1
2	62111059060	COVER POSITIVE POLE	1
3	58411053050	BATTERY COVER 96	1
4	50303018000	RUBBER L=145MM	2
5	62111059000	STARTER CABLE L=650 MM	1
6	62111059050	BATTERY CABLE L=130MM	1
7	62111097000	GROUND CABLE L= 650 MM	1
8	60040009000	RUBBER CAP STARTER PORT 03	1
9*	60011093060	RUBBER CABLE TIE 60MM 03	2
10	76211058000	STARTER RELAY 07	1
11	58011109130	FUSE 30 A	2
12	0902060083	AH OVAL SCREW ISO 7380 M 6X8	2
14	12011016000	WASHER 6 X 12 X 3	2
15	0025060166	HH COLLAR SCREW M6X16 TX30	2
16	0934060003	HEXAGON NUT DIN0934-M 6	2
17	62111056000	BRACKET - BATTERY	1
18	54308042000	RUBBER BUFFER	1
19	0024060206	HH COLLAR SCREW M6X20 TX30	2
20	60011034100	VOLTAGE REGULATOR	1
21	62111037000	BRACKET - VOLTAGE REGULATOR 11	1
22	0025060256	HH COLLAR SCREW M6X25 TX30	2
23	62108019000	REAR END LOWER PART 11	1
24	0024060156	HH COLLAR SCREW M6X15 TX30	2
25	0025060256	HH COLLAR SCREW M6X25 TX30	1
26	62111057000	SUPPORT F. CONNECTOR	2
27	0985060003	SELF LOCK. NUT DIN0985-M 6	1
28	0081050121	SCREW FOR PLASTIC K50X12 T20	1
29	62508021000	SUPPORT TOOL SET 05	1
30	62108019060	THERMAL PROTECTION FOIL R/S	1
31	62108019050	THERMAL PROTECTION FOIL L/S	1
32	62108019070	THERMAL PROTECTION FOIL FRONT	1
33	62108019010	GROMMETSLEEVE 20MM	1
34	0125060003	WASHER DIN0125-A 6,4	1
35	69014017000	SPECIAL SCREW M6X18 ISA30 08	2
36	31008060000	RUBBER SLEEVE D=8MM OPEN	2
37	59030060050	BUSHING F. SPROCKET COVER RAC.	2
38*	54803013050	BUSHING F.REINFORCING	2

126211130

C126211130

* NEW PART

X ON DEMAND

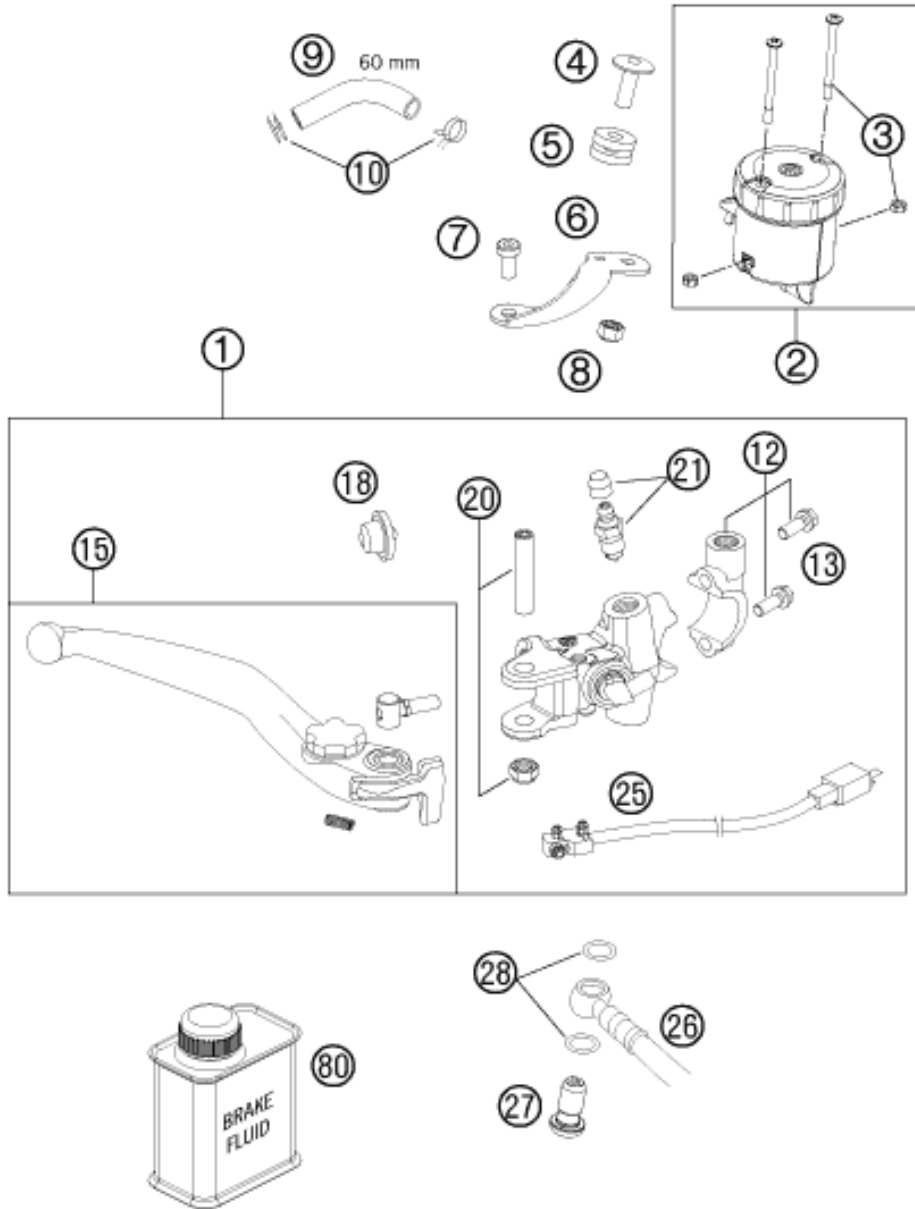

POS	PARTNUMBER	PARTNAME	PIECE
1	62013001100	HANDBRAKECYLINDER CPL.	1
2	61013009102	BRAKE FLUID RESERVOIR CPL.	1
3	61013009103	SCREW + NUT FOR RESERVOIR	2
4	61013013050	SCREW RET.PANEL-RESERVOIR	1
5	61013013000	RUBBER BUSH 05	1
6	61013009001	RET.PANEL FLUID RES. FRONT 05	1
7	61013021000	SCREW RET.PANEL-BRAKE CYLINDER	1
8	61013009004	NUT FOR RESERVOIR	1
9	69013069001	HOSE FOR RESERVOIR 6X1,5	1
10	58007017000	YDNAC CLAMP 10101 (10,4MM)	2
12	61013005000	CLAMP CPL. 05	1
13	0025060256	HH COLLAR SCREW M6X25 TX30	2
15	62513002144	HAND BRAKE LEVER CPL. 07	1
18	61013008000	RUBBER CUP 05	1
20	61013006000	LEVER SCREW CPL. 05	1
21	62513020000	BLEEDER SCREW CPL. 05	1
25	62011050000	BREAK LIGHT SWITCH FRONT	1
26	62142003000	BRAKE HOSE HAND BREAK CYLINDER	1
27*	62113020000	HOLL. SCREW BLACK M10X1X19.5	1
28	0603100141	COPPER GASKET DIN7603-10X14X1	2
80	00062030000	BRAKE FLUID DOT5.1 0,25L	1

126211310

C126211310

* NEW PART

X ON DEMAND

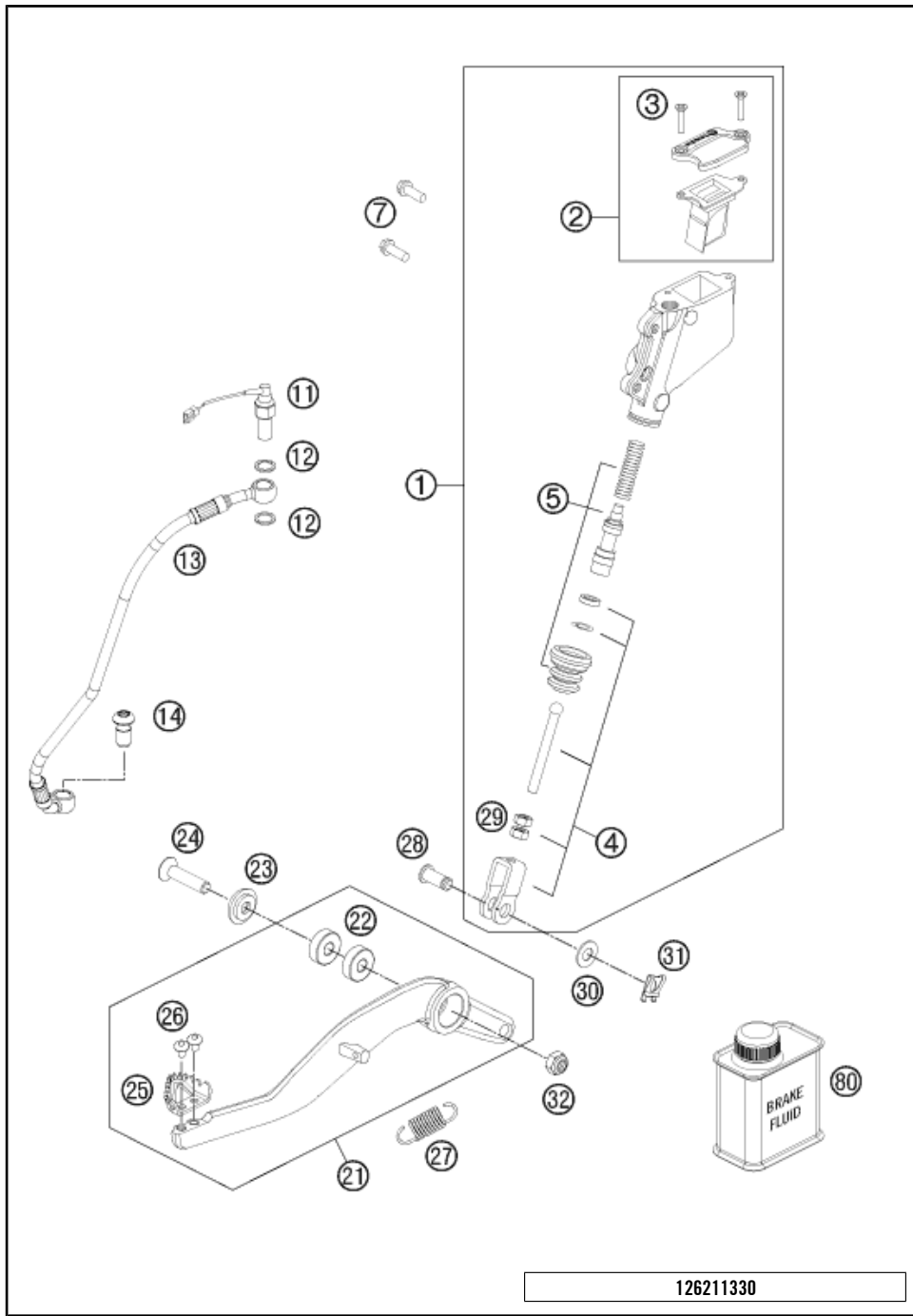

POS	PARTNUMBER	PARTNAME	PIECE
1	60013060200	MAIN BRAKE CYLINDER CPL. 07	1
2	60013059100	COVER MAIN BRAKE CYLINDER CPL.	1
3	0965040161	FLAT HEAD SCREW DIN0965-M 4X16	2
4	60013056044	PUSH ROD CPL. '03	1
5	60013061000	REPAIR KIT PISTON 03	1
7	59009062016	SPECIAL SCREW M6X16 WS=8 10.9	2
11	62111051000	BRAKE LIGHT SWITCH REAR	1
12	0603100141	COPPER GASKET DIN7603-10X14X1	2
13	62142001000	BREAK HOSE CPL.	1
14*	62113020000	HOLL. SCREW BLACK M10X19.5	1
21	6251305004401S	FOOT BRAKE LEVER CPL. 07	1
22	0625006087	GROOVED BALL BEAR. 608 2RS C3	2
23	62603062000	SPECIAL WASHER 8X24 ALU H=2,6	1
24	0019080356	COUNTERSUNK SCREW ISA45 M8X35	1
25	54813051100	STEP PLATE FOR BRAKE LEVER	1
26	58605083010	% SCREW TORX M5X10 05	2
27	54603062000	% RETURN SPRING FOR BRAKELEVER	1
28	60013057000	BOLT F. LINK FORK 8X20X16,5	1
29	0934060003	HEXAGON NUT DIN0934-M 6	2
30	0125080003	WASHER DIN0125-A 8,4	1
31	60013058000	SECURING CLIP D=8MM 03	1
32	0985080003	SELF LOCKING NUT DIN0985-M 8	1
80	00062030000	BRAKE FLUID DOT5.1 0,25L	1

126211330

C126211330

* NEW PART

X ON DEMAND

BRAKE CALIPER FRONT

990 SUPERMOTO T ORANGE ABS EU 2012

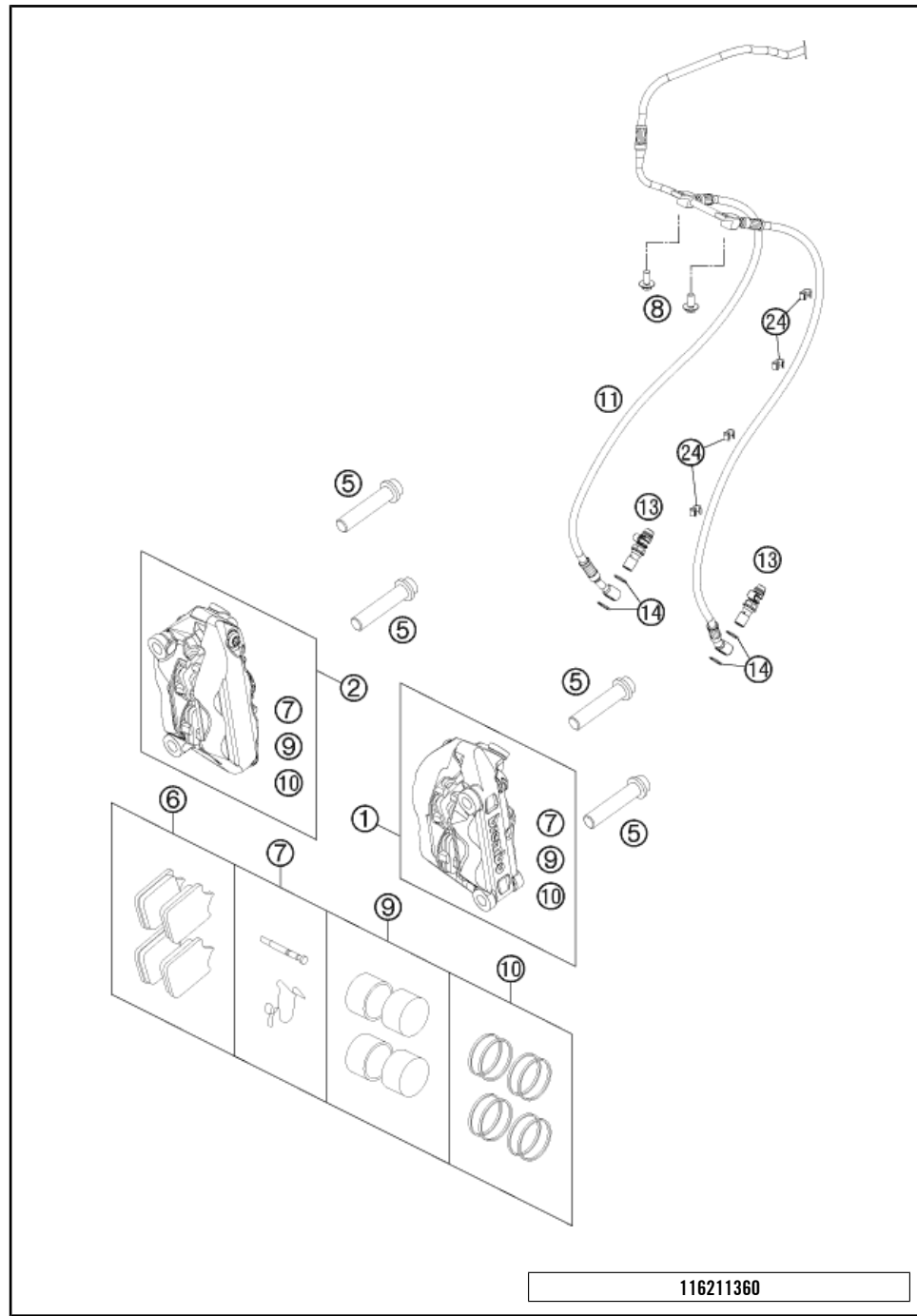

POS	PARTNUMBER	PARTNAME	PIECE
1	6251301510130	CALIPER L/S BLACK-WITHOUT PADS	1
2	6251301610130	CALIPER R/S BLACK-WITHOUT PADS	1
5	0035100559	% AH-COLLAR SCREW M10X1,25X55	4
6	61013030000	BRAKE PAD FR. TOSHIBA TT2172HH	2
7	61013018000	PINS + SPRINGS F. BRAKECALIPER	2
8	0024060136	HH COLLAR SCREW M6X13 TX30	2
9	61013019000	BRAKE PISTONS 4X	2
10	61013019100	REP.KIT SEALING RINGS 4X	2
11	62142004000	BRAKE HOSE BRAKECALIPER FRONT	1
13	62513020000	BLEEDER SCREW CPL. 05	2
14	0603100141	COPPER GASKET DIN7603-10X14X1	4
24	60111094000	CLIP 5/7 MM 06	4

116211360

C126211360

* NEW PART

X ON DEMAND

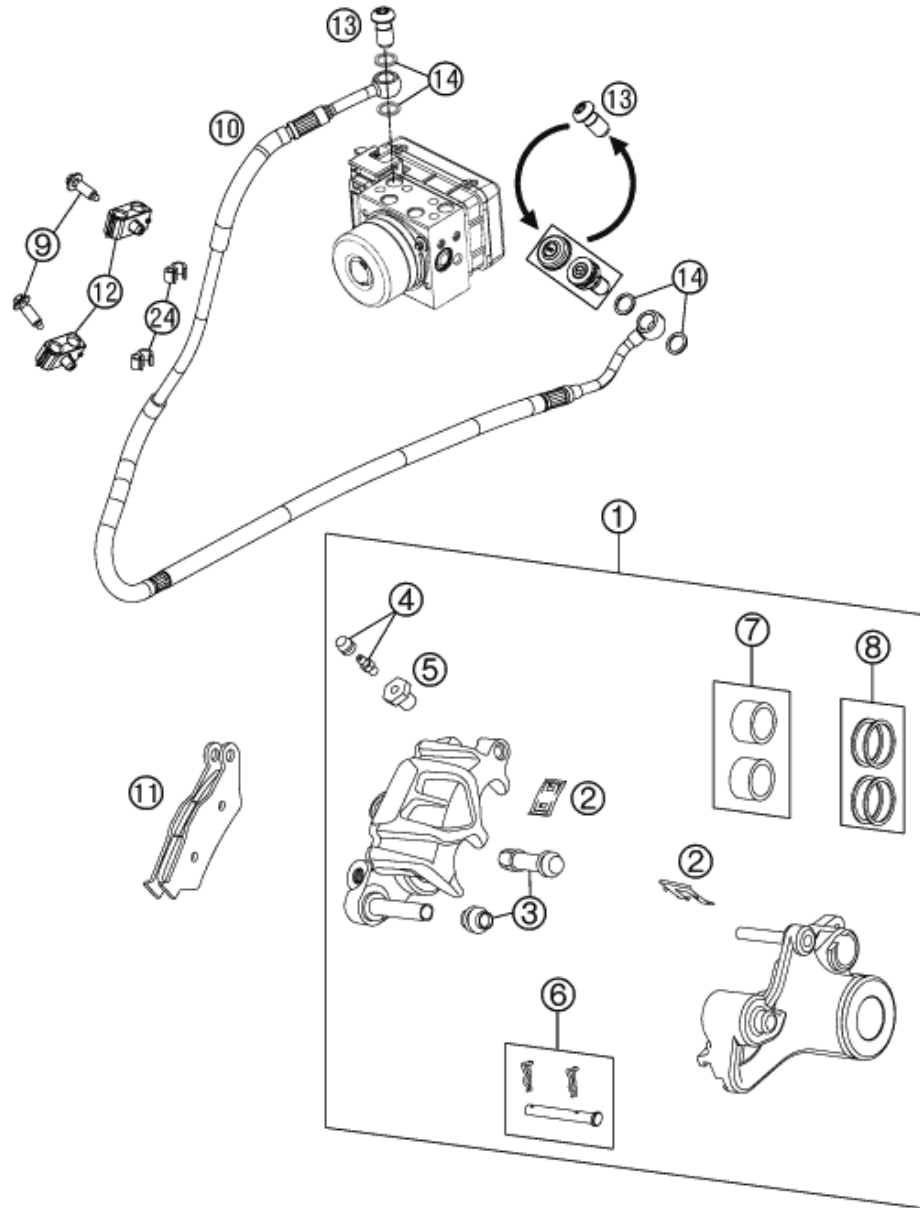

POS	PARTNUMBER	PARTNAME	PIECE
1	6011308000130	BRAKE CALIPER REAR	1
2	60013018100	RETAINING PLATE SET REAR 03	1
3	54613218000	CUP SET SHORT	1
4	60013020200	BLEEDER SCREW WITH CAP M6	1
5	60013020100	ADAPTER SCREW	1
6	77013017000	BOLT CPL. 09	1
7	60013083200	BRAKE PISTONS 05	1
8	60013081000	REP.KIT SEALING RINGS	1
9	0017060203	% EJOT PT SCREW K60X20 WS=6	2
10	62142002000	BRAKE HOSE BRAKECALIPER	1
11	50313030200	BRAKEP.SET FR.TOSHIBA TT2701HH	1
11	59013930000	% BRAKE PAD SET FRONT ORGANIC	x
12	60113046000	SUPPORT FOR BRAKE HOSE 06	2
13*	62113020000	HOLL. SCREW BLACK M10X1X19.5	2
14	0603100141	COPPER GASKET DIN7603-10X14X1	4
24	60111094000	CLIP 5/7 MM 06	2

126211390

C126211390

* NEW PART

X ON DEMAND

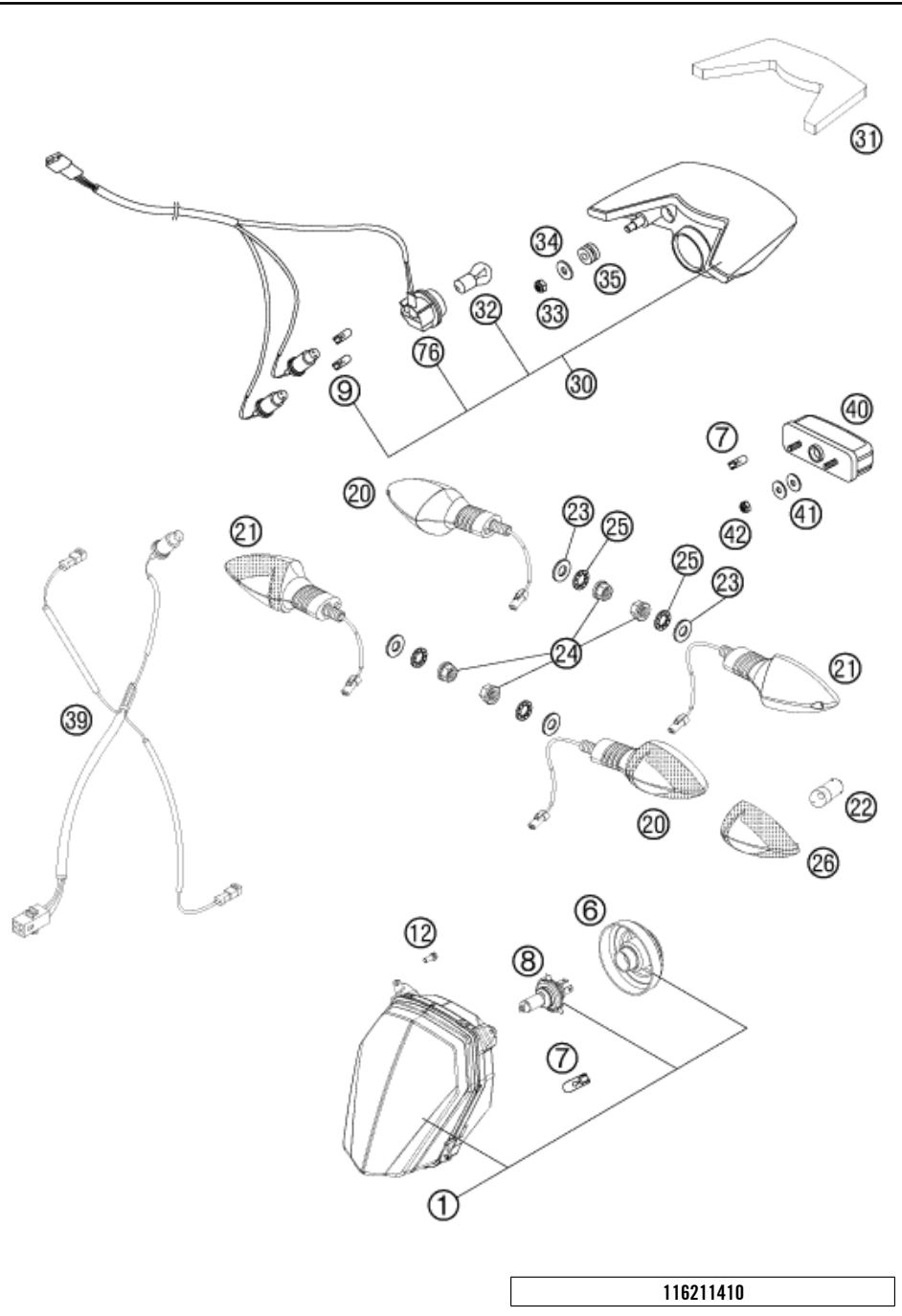

POS	PARTNUMBER	PARTNAME	PIECE
1	62614001000	HEAD LIGHT RIGHT TR. 08	1
6	76514001050	RUBBER CAP FOR HEAD LIGHT	1
7	49011435100	BULB 12V 5W (W2,1X9,5D) PHIL.	2
8	57111038000	BULB H4 12V 60/55W (P43T)	1
9	49011435200	BULB RED WR5W 12V	2
12	0025050126	HH COLLAR SCREW M5X12 TX30	4
20	60114025000	FLASHER CPL.FRONT L/S REAR R/S	2
21	60114026000	FLASHER CPL.FRONT R/S REAR L/S	2
22	60114027000	BULB 12V ORANGE (RY10W)	4
23	0433100003	WASHER 18x10,5x1,6	4
24	58414030000	HH COLLAR NUT M10X1,25 WS=13	4
25	0797100003	LOCK WASHER DIN6797-J10,5 ZI	4
26	60114028000	FLASHER LENS L/S R/S TRANSP.06	4
30	58614140044	REAR LIGHT CPL.SMOKED GLASS 07	1
31	62614040050	METAMOLL FOR REARLIGHT 08	1
32	60014048100	BULB RED PR21W 12V	1
33	0985060003	SELF LOCK. NUT DIN0985-M 6	2
34	0021060003	WASHER DIN9021-A 6,4	2
35	58214069051	RUBBER GROMMET 16X10,8X3 02	2
39	62611076000	WIRING HARNESS REAR 08	1
40	58414047000	LICENSE-PLATE ILLUMINATION '98	1
41	0021050003	WASHER DIN9021-A 5,3	4
42	0985050003	SELF LOCKING NUT DIN0985-M 5	2
76	58611176100	CABLE HARNESS REAR PART 07	1

116211410

C116211410

* NEW PART X ON DEMAND

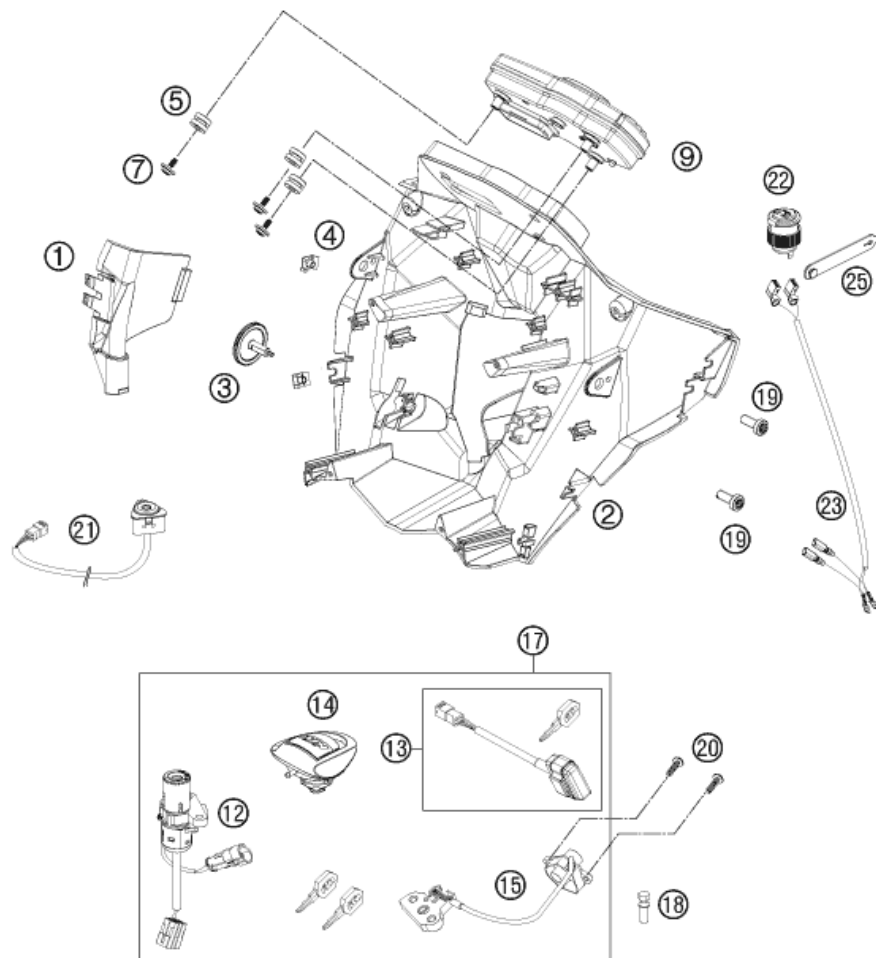

POS	PARTNUMBER	PARTNAME	PIECE
1	62014010050	COVER COCKPIT SUPPORT	1
2	62014010100	COCKPIT SUPPORT	1
3	62014010060	ADJUSTING KNURL COCKP. SUPPORT	1
4	69008021080	RANGE CHANGE METAL NUT M5	6
5	58214069051	RUBBER GROMMET 16X10,8X3 02	3
7*	0081645121	EJOT DELTA PT SCREW 45X12-Z	3
9	62114069000	% SPEEDOMETER KM/H	1
9	62114069100	SPEEDOMETER ONLY FOR JAPAN	x
12	62011066000	IGNITION LOCK	1
13	62611021000	IMMOBILIZER 990SM W. MASTERKEY	1
14	58407008300	TANK PLUG	1
15	62607050000	SEAT LOCK	1
17	62011066044	LOCK SET	1
18	60011064000	TAMPERPROOF SCREW F. IGN. LOCK	2
19	0035080206S	AH-COLLAR SCREW M8X20 ISA45	4
20	0081050181	SCREW FOR PLASTIC K50X18 T20	2
21	60211022000	HAZARD WARNING BUTTON	1
22	60111042100	SOCKET	1
23	62111042060	CABLE FOR SOCKET SMT	1
25	60011093075	RUBBER CABLE TIE 75MM 03	1

13

<p>ACHTUNG !!!</p> <p>Zum Anlernen des EWS-Steuergeräts sind zwei schwarze Zündschlüssel erforderlich.</p>	<p>CAUTION !!!</p> <p>To program the ICU control unit, the two black ignition keys are required.</p>
---	---

126211430

C126211430

* NEW PART

X ON DEMAND

ACCESSORIES KIT

990 SUPERMOTO T ORANGE ABS EU 2012

①
OHNE ABBILDUNG
WITHOUT ILLUSTRATION

①
TECHNISCHE DOKUMENTATION
TECHNICAL DOCUMENTATION
DOCUMENTACION TECNICA
DOCUMENTATION TECHNIQUE
NOTE TECNICHE

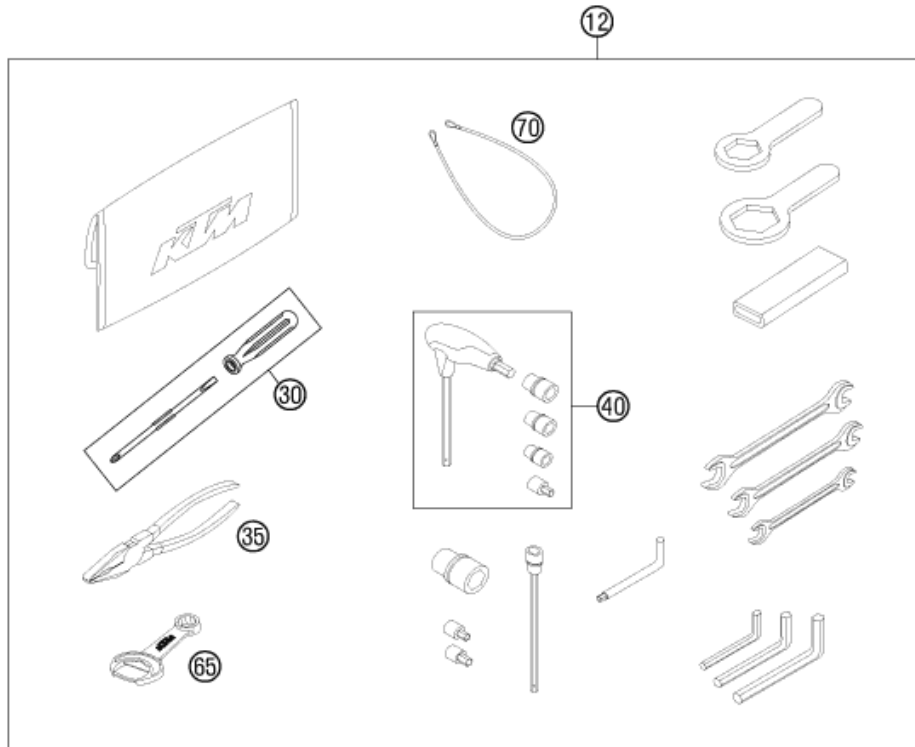

116212000

POS	PARTNUMBER	PARTNAME	PIECE
0	62008108000	WIND SHIELD USA	1
0	0024060156	HH COLLAR SCREW M6X15 TX30	4
0	40006006000	WASHER 6MM	2
0	58412040050	SUPPORT FOR MIRROR LC4 '98	2
0	61112040000	REVIEW MIRROR L/S 07	1
0	61112041000	REVIEW MIRROR R/S 07	1
0	58412080000	REFLECTOR RED	1
0	60012081200	LICENCE FITTING 06	1
0	0024060156	HH COLLAR SCREW M6X15 TX30	4
0	0021060003	WASHER DIN9021-A 6,4	4
0	0985060003	SELF LOCK. NUT DIN0985-M 6	4
0	58412080050	BRACKET FOR REFLECTOR	1
0	40006006000	WASHER 6MM	2
0	0966050163	OVAL HEAD SCREW DIN0966-M 5X16	2
0	0125050003	WASHER DIN0125-A 5,3	2
0	0985050003	SELF LOCKING NUT DIN0985-M 5	2
0	3210040	CUSTOMER WELCOME LETTER	1
0	3212365GB	POWER WEAR TEASER 2012	1
0	312313	KTM BALLPOINT PEN ORANGE	1
0	00063004202	PRINT LABEL 60X51 MM	1
0	312305	DOCUMENTS BAG 2006	1
1	3211783EN	OWN. MANUAL SUPERMOTO T 2012	1
12	61129099000	% TOOL SET 08	1
30	53012024100	SCREW DRIVER L=105MM	1
35	53012028200	GRIP ORANGE B&F	1
40	60029070200	% T-WRENCH WS=6/8/10 TX=45 B&F	1
65	50329071100	WRENCH WS=13 B&F + OPENER	1
70	60012015000	HELMET LOCK 04	1

C126212000

* NEW PART

X ON DEMAND

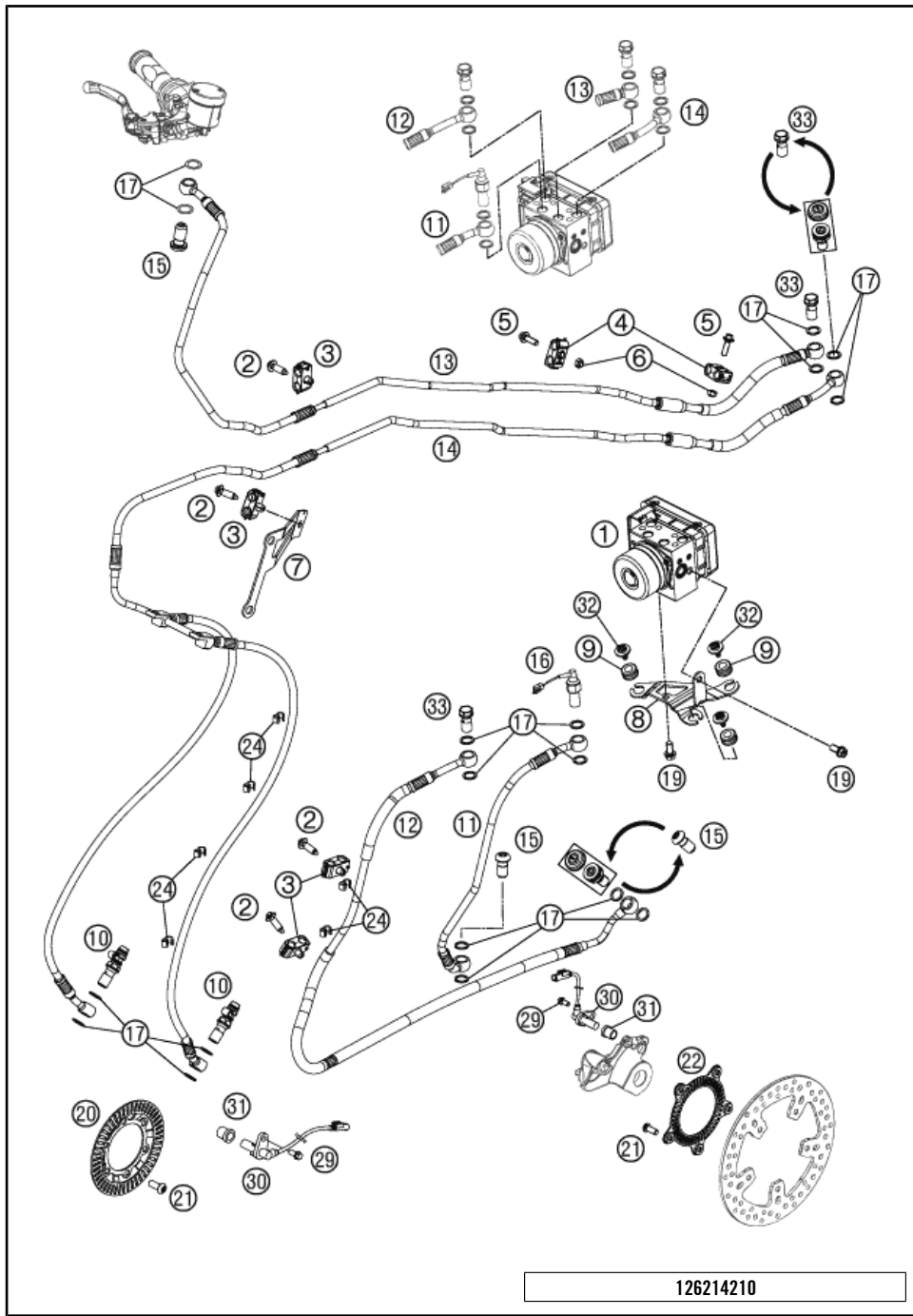

POS	PARTNUMBER	PARTNAME	PIECE
1	62142031044	ABS MODULE FILLED	1
2	0017060203	% EJOT PT SCREW K60X20 WS=6	4
3	60113046000	SUPPORT FOR BRAKE HOSE 06	4
4	60113146000	SUPPORT FOR BRAKE HOSE M5	2
5	0014050163	HH COLLAR SCREW M 5X16 WS=6	2
6	0985050003	SELF LOCKING NUT DIN0985-M 5	2
7	62142025000	SUPPORT BRAKE HOSE FRONT	1
8	62142040000	SUPPORT ABS-MODULE	1
9	62142041000	DAMP. COMPONENT ABS MODUL	3
10	62513020000	BLEEDER SCREW CPL. 05	2
11	62142001000	BREAK HOSE CPL.	1
12	62142002000	BRAKE HOSE BRAKECALIPER	1
13	62142003000	BRAKE HOSE HAND BREAK CYLINDER	1
14	62142004000	BRAKE HOSE BRAKECALIPER FRONT	1
15*	62113020000	HOLL. SCREW BLACK M10X1X19.5	3
16	62111051000	BRAKE LIGHT SWITCH REAR	1
17	0603100141	COPPER GASKET DIN7603-10X14X1	18
19	0025060126	HH COLLAR SCREW M6X12 TX30	2
20	62142020000	SENSORGEAR FRONT	1
21	76009062000	SPECIAL SCREW M8X25 SS TX40	11
22	62142021044	SENSORGEAR REAR	1
24	60111094000	CLIP 5/7 MM 06	6
29	0024060156	HH COLLAR SCREW M6X15 TX30	2
30	60142025000	ABS-SENSOR 06	2
31	60142024050	SLEEVE SENSOR HOLDER ABS	2
32	0081650121	EJOT PT SCREW K50X12 WN5452	3
33*	54813020100	HOLLOW SCREW BLACK M10X1X19	3

126214210

C126214210

* NEW PART X ON DEMAND

A large, empty rectangular box with a thin black border, occupying the majority of the page. It is intended for handwritten or typed notes.

A large, empty rectangular box with a thin black border, occupying the majority of the page below the headers. It is intended for handwritten or typed notes.

WWW.KTM.COM



KTM Sportmotorcycle GmbH
5230 Mattighofen, Austria
www.ktm.com



KTM_POWERPARTS

KTM_POWERWEAR

KTM_ORIGINAL SPARE PARTS



3CF 9803L2EN

Art. Nr.: 3CF 9803L2EN 2. Jul 2015