

125 EXC EU 2013

SPARE PARTS MANUAL: CHASSIS

ART.NO.: 3CFF7103M6EN

ENGLISH



FRONT FORK DISASSEMBLED

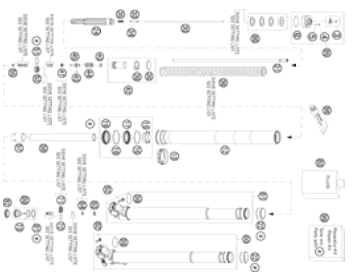

4

FRONT FORK, TRIPLE CLAMP

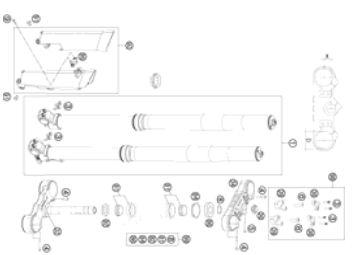

6

HANDLEBAR, CONTROLS

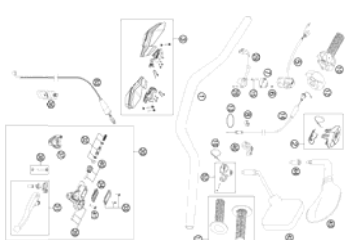

7

SIDE / CENTER STAND

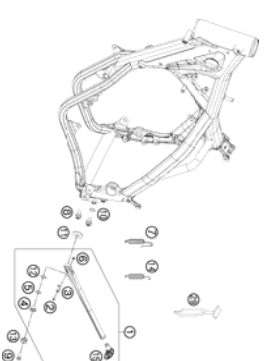

8

FRAME

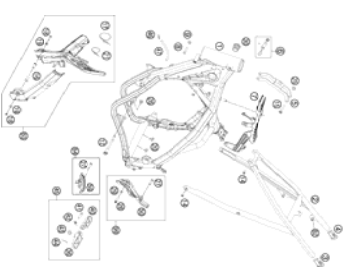

9

SHOCK ABSORBER DISASSEMBLED

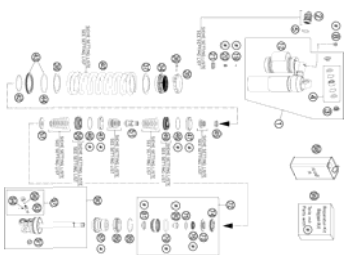

11

SWING ARM

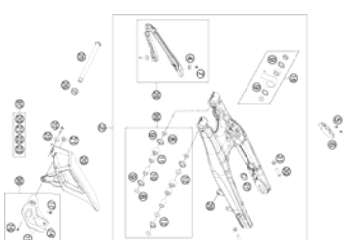

13

SHOCK ABSORBER

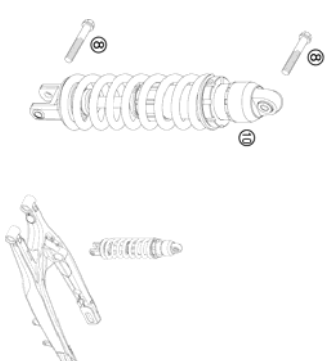

14

EXHAUST SYSTEM

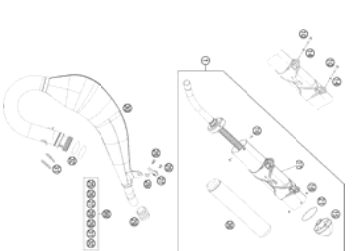

15

AIR FILTER

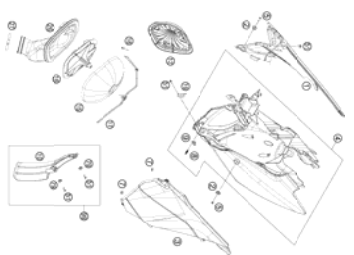

16

TANK, SEAT, COVER

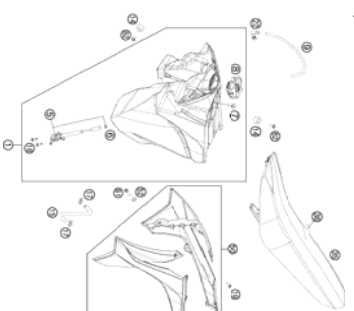

17

MASK, FENDERS

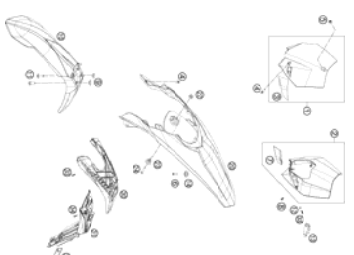

18

DECAL



19

FRONT WHEEL

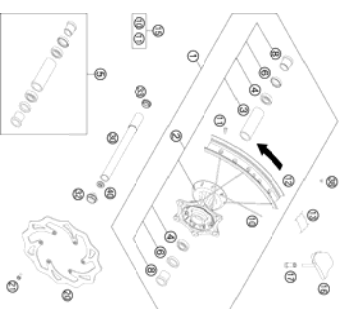

20

REAR WHEEL

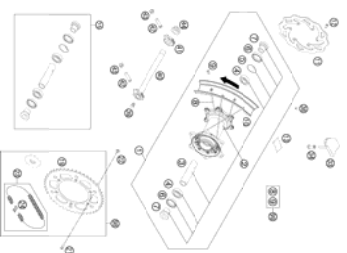

21

WIRING HARNESS

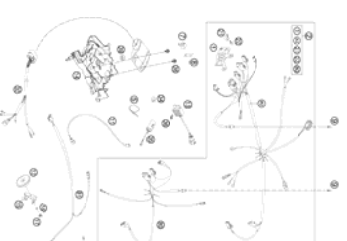

23

BRAKE CALIPER REAR



24

BRAKE CALIPER FRONT

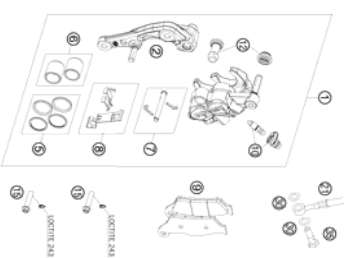

25

HAND BRAKE CYLINDER

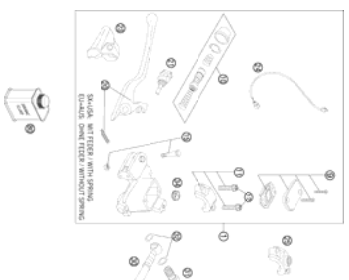

26

REAR BRAKE CONTROL



27

LIGHTING SYSTEM

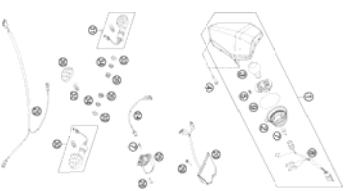

28

INSTRUMENTS / LOCK SYSTEM



29

ACCESSORIES KIT

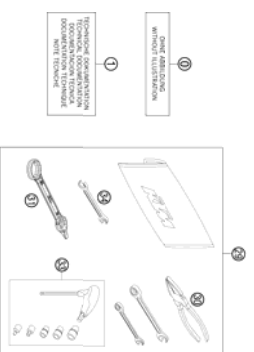

30

All information contained is without obligation. KTM-Sportmotorcycle AG particularly reserves the right to modify any equipment, technical specifications, prices, colors, shapes, materials, services, service work, constructions, equipment and the like so as to adapt them to local conditions or to cancel any of the above items, all without previous announcement and without giving reasons. KTM may stop manufacturing certain models without previous notice. KTM shall not be held liable for any deviations of availability and/or ability to deliver, illustrations, descriptions, printing and/or other errors. The illustrated models partly contain extra equipment, which is not applied to standard models.
© by KTM-SPORTMOTORCYCLE AG, Mattighofen AUSTRIA; All rights reserved; Reprint, also in extracts, with written allowance of KTM-SPORTMOTORCYCLE AG, Mattighofen only.

FRONT FORK DISASSEMBLED

125 EXC EU 2013

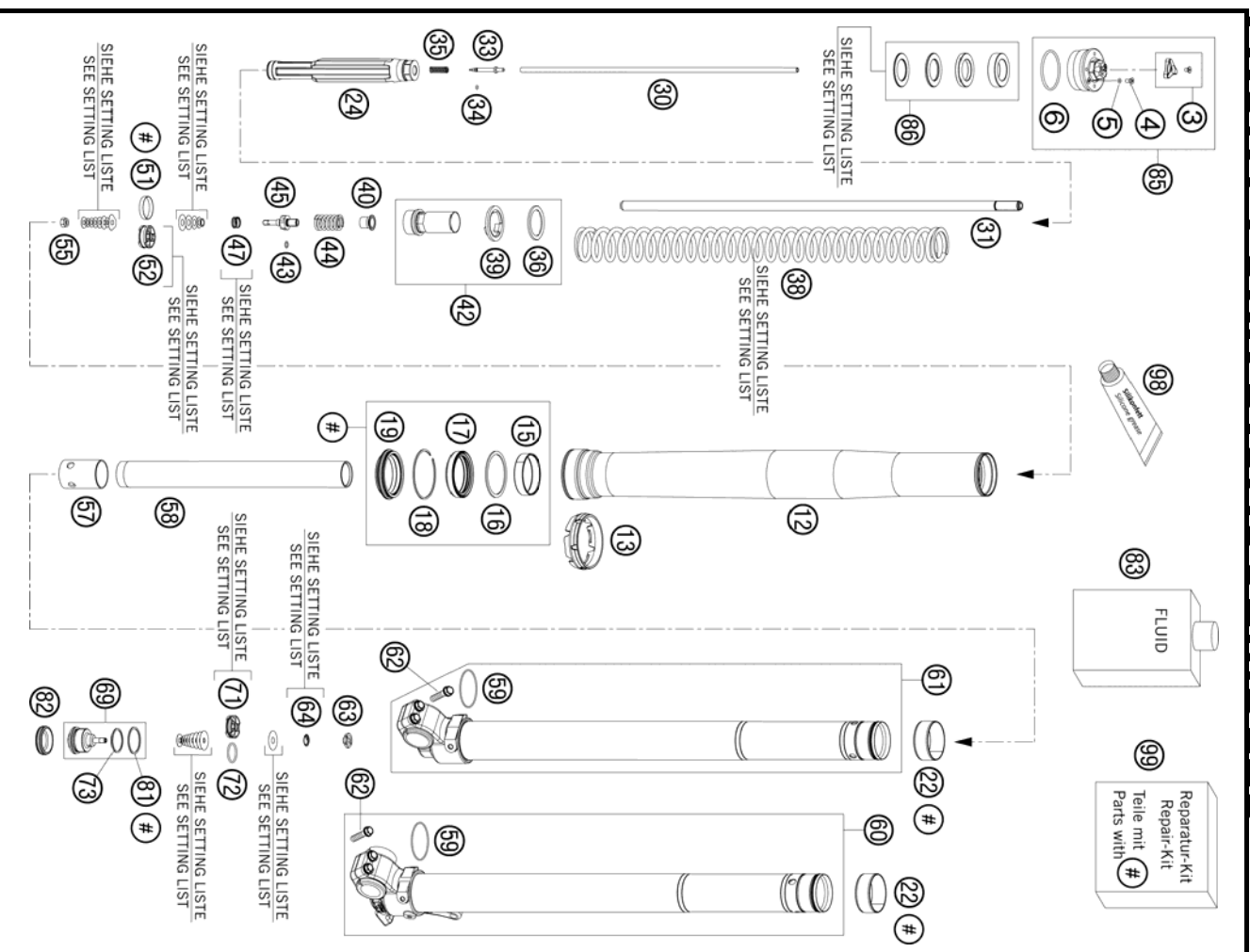

FIG	PART NUMBER	DESCRIPTION	QTY
3	48600812S	ADJUSTING KNOB + SCREW	2
4	48600481	VENT SCREW M4X8	2
5	48600046	O-RING NBR 3X1,5	2
6	46810340	O-RING NBR 45X2	1
12	48600736	OUTER TUBE L=577 D=54/60MM 2L	2
13	48600698	FORK PROTECTION RING 08	2
15	48601009	GUIDING BUSH 48X52X12 R11	2
16	48600013	SUPPORT RING 50 X 57,6 X 1,5	2
17	48600969	OIL SEAL RING D48 SKF	2
18	48600070	LOCK WASHER SB58	2
19	48600968	DUST SEAL DL D48 SKF	2
22	48601008	GUIDING BUSH 47X49X20 R11	2
24	48600557S	HYDR.STOP L=200 D=31,9 CPL. 07	2
30	48600559	ADJUSTING TUBE L=520 07	2
31	48600568	PISTON ROD D=12 L=554 ALU	2
33	48600277	ADJUSTER NEEDLE 07	2
34	48600298	O-RING 2X1,5 NBR	2
35	48600444	REBOUND SPRING C=4N/MM	2
36	48600113	WASHER 32X42X2,5	2
38	91410012S	SPRING 3,8N/MM SET D=4,9MM	x
38	91410013S	SPRING 4,0N/MM SET D=5,0MM	x
38	91410014S	SPRING 4,2N/MM SET D=5,0MM	x
38	91410015S	SPRING 4,4N/MM SET D=5,1MM	x
39	91410016S	SPRING 4,6N/MM SET	x
40	48600525	INTERM. RING 26,2 X 43 X 3	2
42	48600830S	GUIDING BUSH REBOUND SPRING	2
43	48600299	SCREW SLEEVE M27X0,8	2
44	48600511	O-RING 6X1,2 NBR	2
45	48600576	REBOUND SPRING L=32 C=17	2
47	48600382	PISTON ROD REBOUND	2
51	48600455	SHUTTLE VALVE SPRING C=0,4	2
52	48600575	PISTON RING 5X1X68	2
55	40540486	PISTON REBOUND SX 2007	2
57	48600764	NUT M6X0,5 REBOUND	2
		ADAPTER SLEEVE D23/D28	2

105230130 / C127740130

* NEW PART

X AS REQUIRED

FRONT FORK DISASSEMBLED

125 EXC EU 2013

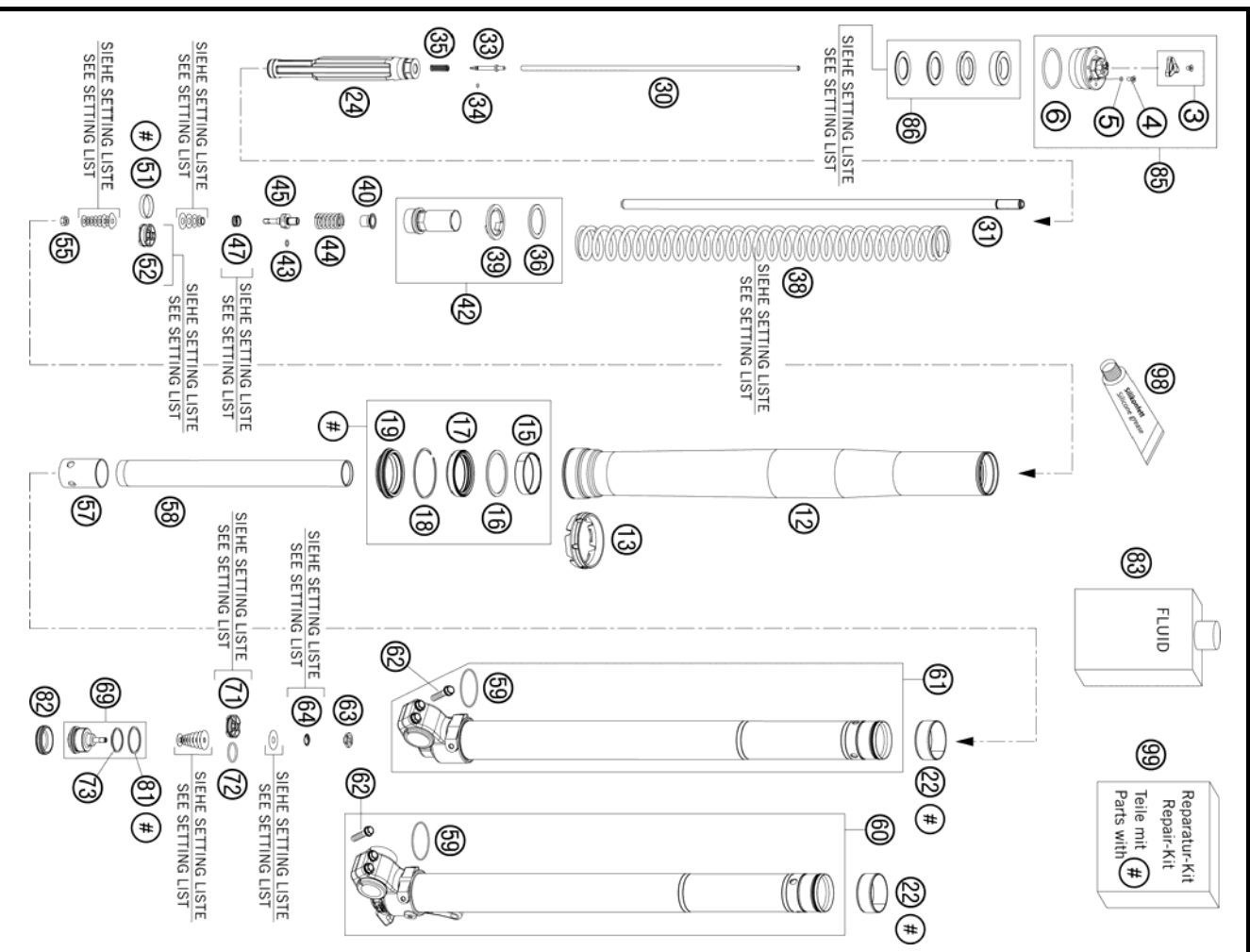

FIG	PART NUMBER	DESCRIPTION	QTY
58	48600763	PIPE D23/1350	2
59	48600048	O-RING NBR 46 X 2	2
60	48600860SA	AXLE CLAMP L/S + TUBE CPL.	1
61	48600861S1	AXLE CLAMP R/S + TUBE CPL. 09	1
62	0025080256	HH COLLAR SCREW M8X25 TX40	4
63	48600163	CHECK VALVE NUT M6X0,5 D=2	2
64	48600202	SPRING CHECK VALVE D=0,7	2
69	48600586S	TAP COMPRESSION CPL. 07	2
71	48600047	PISTON COMPRESSION D=27,9	2
72	46811499	O-RING NBR 21X2	2
73	35480320	O-RING NBR 24X2	2
81	48600004	COPPER WASHER 29,5X33,5X1	2
82	48600141	RUBBER CAP D=35MM	2
83	48600765S1	FORK OIL SAE5 5L 2008	1
85	48600431S2	PRE-LOAD ADJ. M51X1,5 09	2
86	48600036	SPACER 42X26,5X2,5	x
86	48600037	SPACER 42X26,5X5	x
86	48600038	SPACER 42X26,5X10	x
86	48600053	SPACER 42X26,5X1,5	x
98	T511	SILICONE GREASE F. DUST STRI	1
99	R14020	SXS SERVICE KIT	1

105230130 / C127740130

* NEW PART

X AS REQUIRED

FRONT FORK, TRIPLE CLAMP

125 EXC EU 2013

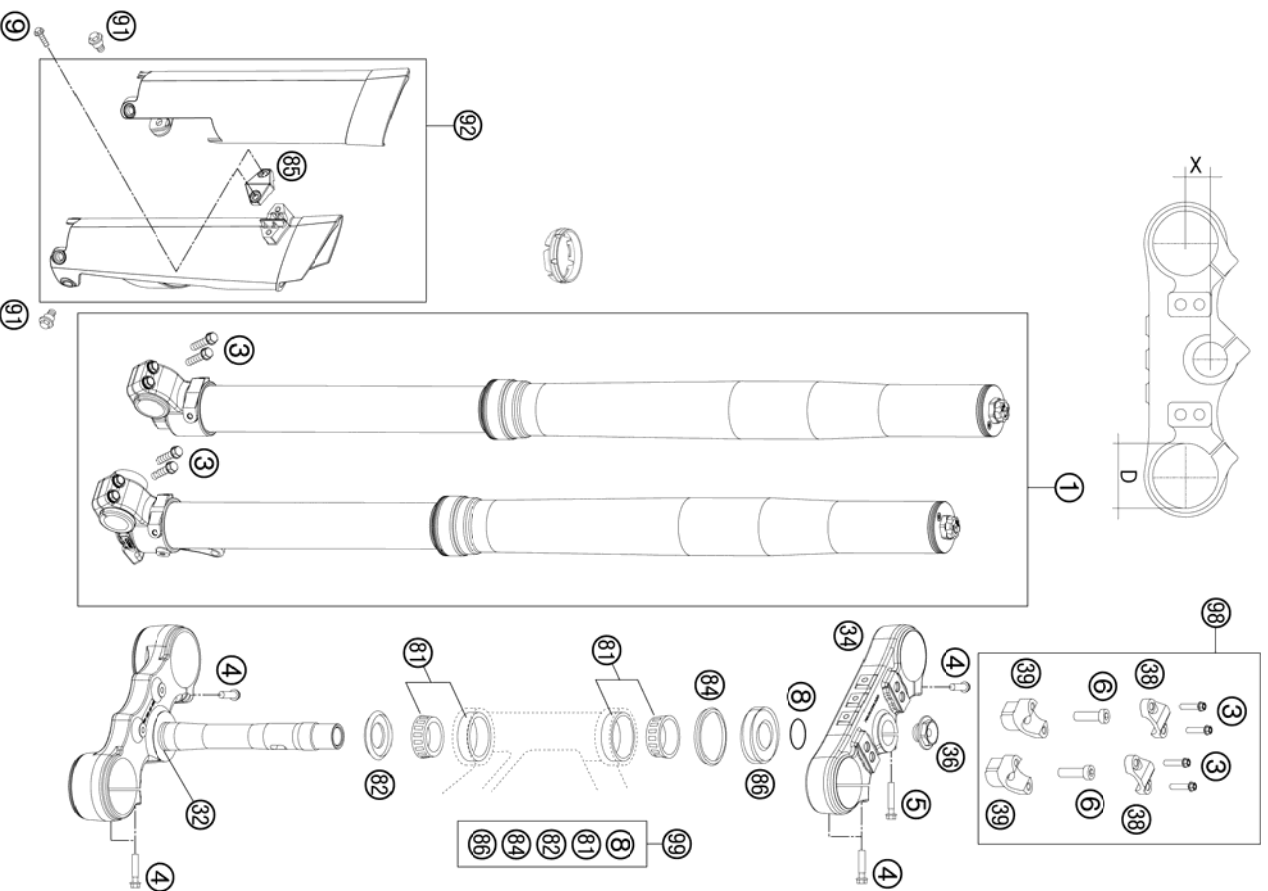

FIG	PART NUMBER	DESCRIPTION	QTY
1	1418716101	GABEL WP 125/200 EXC 2012	1
3	0025080256	HH COLLAR SCREW M8X25 TX40	8
4	0025080306	HH COLLAR SCREW M8X30 TX40	8
5	0025080356	HH COLLAR SCREW M8X35 TX40	1
6	0032100356S	AH-COLLAR SCREW M10X35 IS445	2
8	0770025035	O-RING 25X3,55 NBR70 05	1
9	0017060204	EJOT PT SCREW K60X20 ALU WS=6	2
32	78101032022	BOTT. TRIPLE CLAMP CPL. X=22MM	1
34	78101034022	TOP TRIPLE CLAMP X=22MM	1
36	54801036000	STEER HEAD SCREW M20X1,5 WS=27	1
38	77201038000	HANDLEBAR CLAMP 28MM	2
39	59401039032	HANDLEB.SUPP. D=28MM H=32MM 05	x
39	59401039037	HANDLEB.SUPP. D=28MM H=37MM 05	2
39	59401039042	HANDLEB.SUPP. D=28MM H=42MM 05	x
81	54201081100	TAPERED ROLLER BEARING CPL. 06	2
82	54601084100	O-RING SUPPORT W. SEALING LIP	1
84	54601184000	STEERING HEAD GASKET TOP	1
85	7800108500028	CLAMP F. SPEED. CABLE D=6MM 08	1
86	78101086000	STEERING HEAD COVER	1
91	59001092050	SPECIAL SCREW M6X12,5 WS=8	6
92	7800109410028	FORK PROTECT. L/S+R/S WHITE 09	1
98	00050000921	HANDLEBAR SUPPORT KIT D28/H37	x
99	00050000930	STEERING HEAD REP. KIT	x

125030111 / C135030110

* NEW PART

X AS REQUIRED

HANDLEBAR, CONTROLS

125 EXC EU 2013

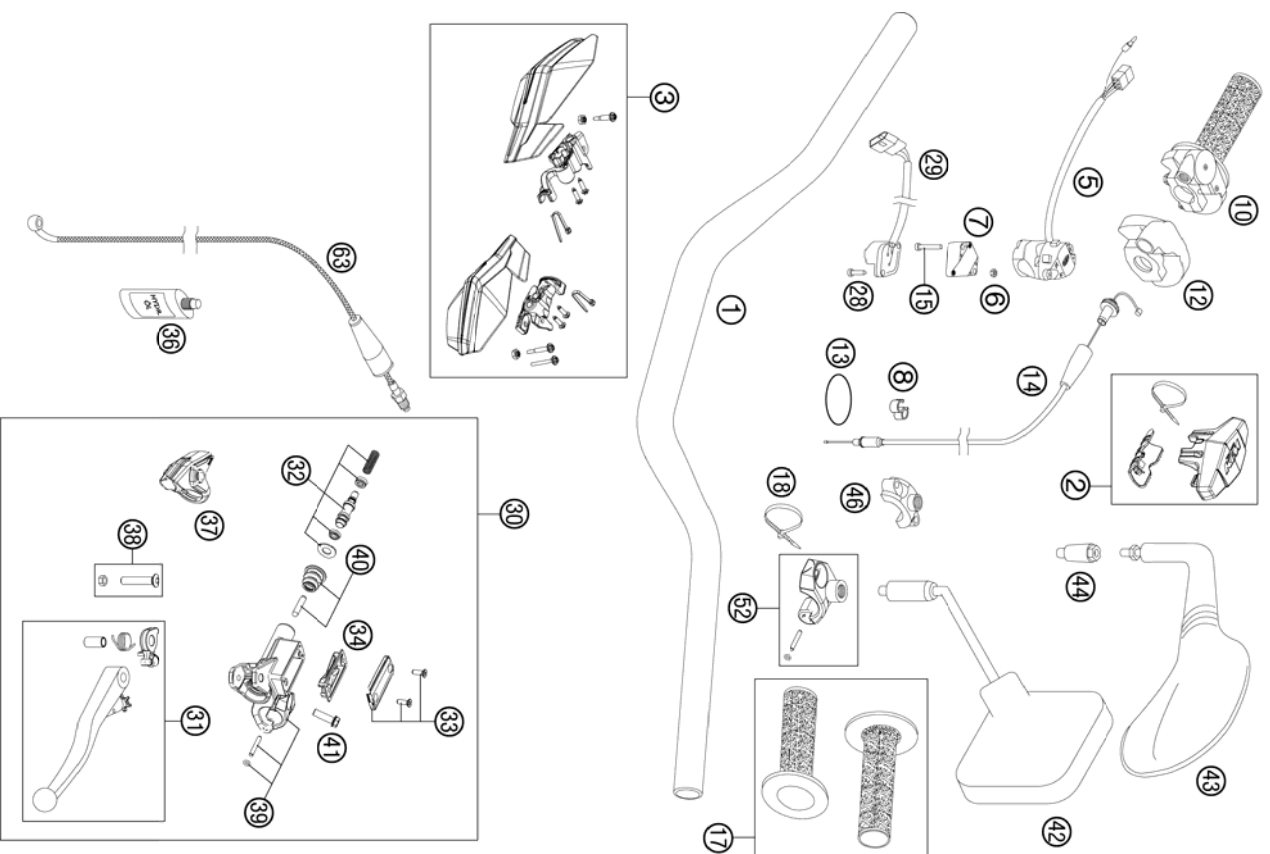

FIG	PART NUMBER	DESCRIPTION	QTY
1	7800200100017	HANDLEBAR D=28MM	1
2	77202002144	BAR PAD CPL.	1
3	7810297900004	HANDGUARDS CPL.LE+RI ORANGE 12	1
5	50311070000	H.LIGHT SWITCH CEV 2/4TAKT '98	1
6	0934040003	HEXAGON NUT DIN0934-M 4	2
7	13011070060	ADAPTER FOR FLASHER SWITCH '98	1
8	60111094000	CLAMP 5/7 MM	2
10*	51502010100	THRITTLE GRIP CPL.	1
12	50302020000	PROTECTION COVER '97	1
13*	0770021300	O-RING 40,94X2,62 NBR70	1
14*	51502091100	THRITTLE CABLE 2T.DOM/KEH. 13	1
15	0084040223	CYL.HEAD SCREW DIN0084-M 4X22A	2
17*	78102021000	GRIP SET	1
18	44011076200	CABLE TIE 200/3,6MM BLACK	1
28	0985040203	FLAT HEAD SCREW DIN7985-M 4X20	2
29	50311029000	FLASHER SWITCH CEV '98	1
30	50302030300	MASTER CYLINDER CPL. 9,5MM 09	1
31	50302031300	CLUTCH LEVER CPL. 2009	1
32	50302032100	REP.KIT PISTON 9,5MM 09	1
33	50302033200	COVER HYDR. CLUTCH CPL. 09	1
34	50302034100	RUBBER FOR RESERVOIR 09	1
36	50302036200	OIL FOR HYD. CLUTCH 75ML	1
37	50302037100	MUD CAP 09	1
38	50302038200	LEVER SCREW SHORT CPL. 09	1
39	83013005000	CLAMP, CYL. PIN. O-RING	1
40	50302046000	PUSH ROD CPL. 09	1
41	0025060166	HH COLLAR SCREW M6X16 TX30	1
42	58012040000	REAR MIRROR L/S	1
42	58012140000	REAR MIRROR R/S	1
43	58412040000	MIRROR L/S 98	1
43	58412041000	MIRROR R/S 98	1
44	58412040050	SUPPORT FOR MIRROR LC4 '98	2
46	58012040150	CLAMP FOR MIRROR '94	1
52	50302044000	CLAMP FOR MIRROR CPL. 09	1
63	50332063200	CLUTCH PIPE L=970MM 04	1

135030210 / C135030210

* NEW PART

X AS REQUIRED

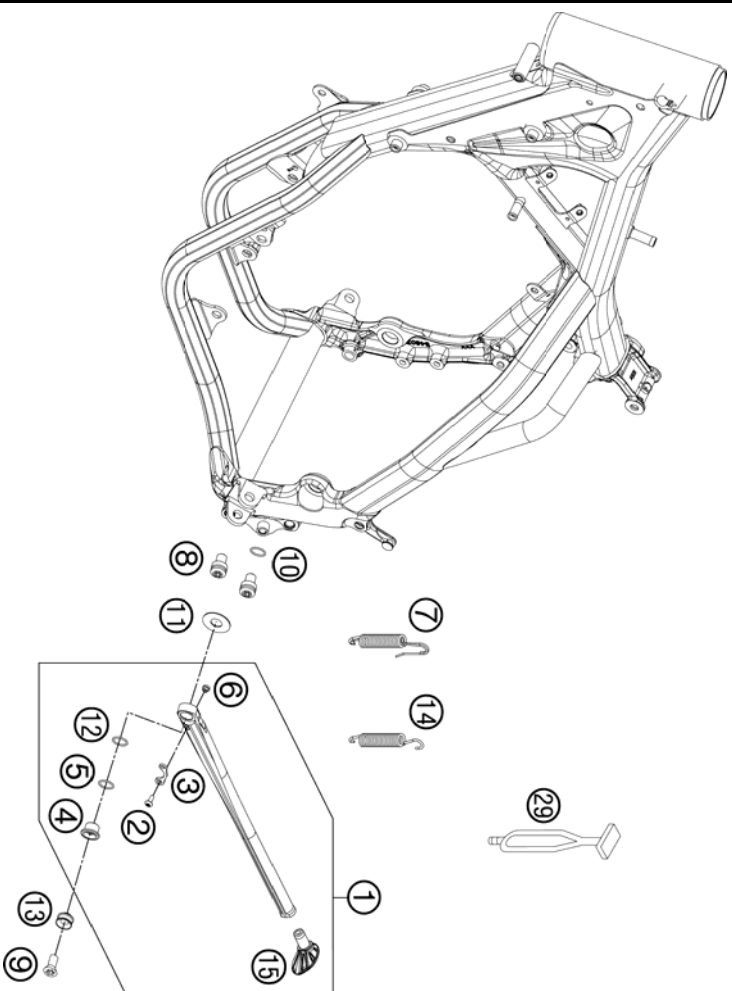

FIG	PART NUMBER	DESCRIPTION	QTY
1	78003023044	SIDE STAND CPL. 08	1
2	58605083014	SCREW M5X14 TORX 25 07	1
3	78003023090	SPRING BRACKET F. SIDE ST. 08	1
4	78003023080	SIDE STAND BUSHING EXC USA 08	1
5	0770180020	O-RING 18,00X2,00 NBR 70	1
6	78003023070	SPACER BUSH. SPRING BRACKET	1
7	81203024000	SIDE STAND SPRING EYE MOVEABLE ONLY FOR EXC	1
8	78003023182	SIDE STAND STOP SCREW M10X12	2
9	0019080206S	FLAT HEAD SCREW M. ISA45 M8X20	1
9	0019080266S	COUNTER-SUNK SCREW ISA45 M8X26 ONLY FOR 78003023081	1
10	0770120020	O-RING 12,00X2,00 NBR 70	1
11	78003023083	WASHER F. SIDE STAND 12,2X29,5	1
12	0770125015	O-RING 12,5X1,5 NBR	1
13	78003023081	SIDE STAND BUSHING EXC-EU 08	1
14	78003024100	SIDE STAND SPRING ONLY FOR XC	1
15	78003023055	STAND BASE	1
29	50303018000	RUBBER L=145MM	1

125030360 / C125030360

* NEW PART

X AS REQUIRED

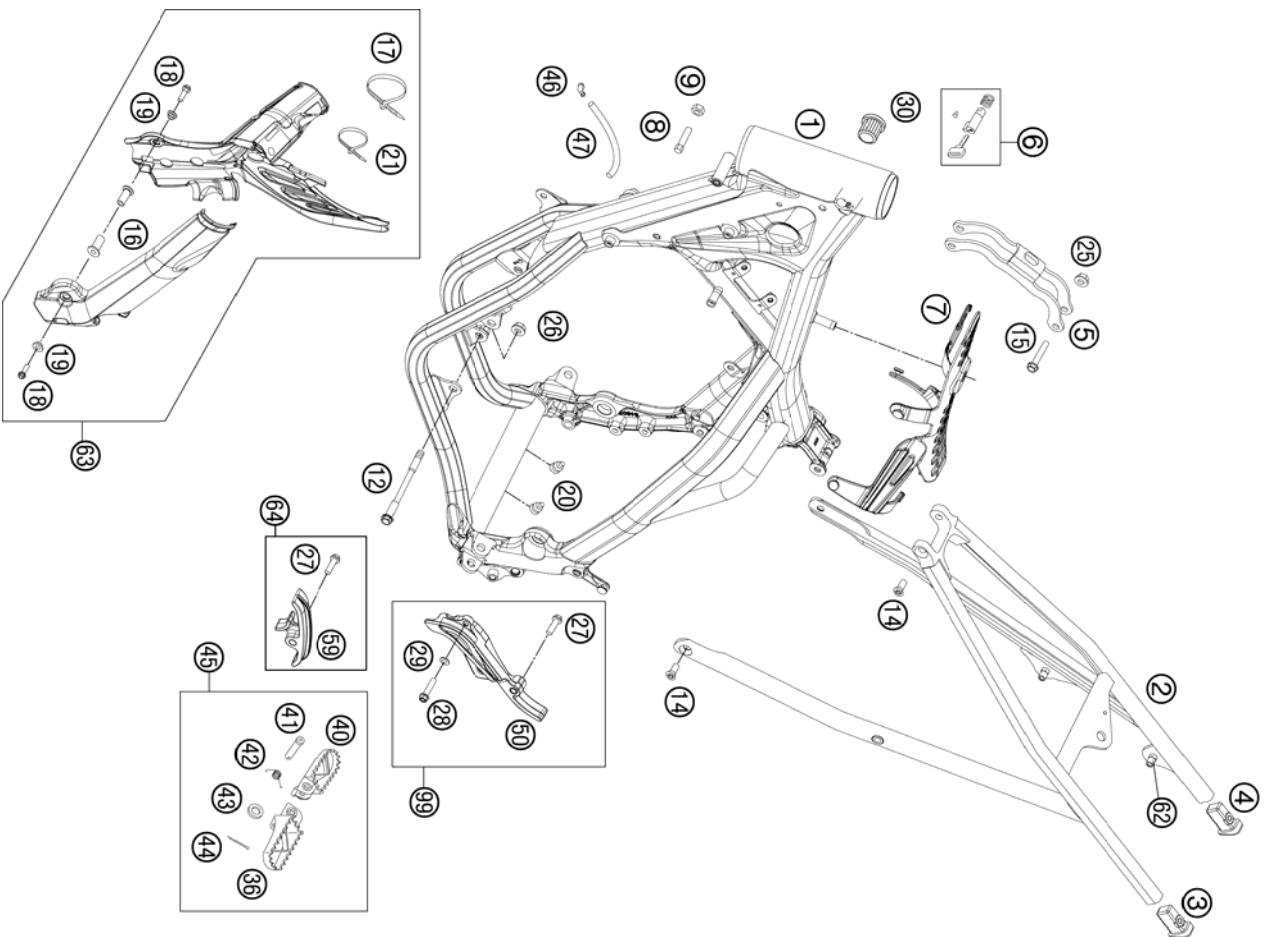

FIG	PART NUMBER	DESCRIPTION	QTY
1	5150300120033	FRAME BLACK MATT "515L1"	1
2	77203002000	SUB FRAME SX	1
3	78003002010	SUB FRAME APPLICATION LEFT	1
4	78003002020	SUB FRAME APPLICATION RIGHT	1
5	51503013000	REINFORCING B. 125 SX 2011	2
6	78003035000	STEERING HEAD LOCK	1
7	77207012000	TANK REST RUBBER	1
8	59001037000	SPECIAL SCREW M8X26 WS=10	2
9	0934080003	HEXAGON NUT DIN0934-M 8	2
12	54603013000	ENGINE BRAC. SCR. M10X105 WS=13	2
14	0019080206S	FLAT HEAD SCREW M. ISA45 M8X20	4
15	56530079000	HH COLLAR SCREW M 8X44 WS13	2
16	54803092050	BLIND PLUG-IN NUT M5 WN 22A 03	2
17	44011076305	CABLE TIE 300/4,8MM BLACK	3
18	0738050250	COU. SUNK SCR. AH ISO7380 M5X25	2
19	54803092060	BUSH F. FRAME PROTECTION	2
20	54403135000	PLASTIC CAP SF110	2
21	44011076140	CABLE TIE 140/2,5MM BLACK	x
25	54310086200	SELF LOCKING NUT M8	10 9
26	54310086100	SELF LOCKING NUT M10 CU WS=14	2
27	0025080306	HH COLLAR SCREW M8X30 TX40	2
28	0025060406	HH COLLAR SCREW M6X40 TX30	1
29	0125060003	WASHER DIN0125-A 6,4	1
30	42007049000	PLASTIC CAP	x
36	78003040050	FOOTREST L/S	1
40	78003041050	FOOTREST R/S	1
41	54803044000	BOLT FOR FOOT PED	2
42	54603041000	FOOTREST SPRING L/S & R/S	2
43	0125100003	WASHER DIN0125-A10,5	2
44	0094032253	PIN DIN0094-3,2X25 STEEL	2
45	78003040033	FOOTREST L/S + R/S CPL.	1
46	50303089000	ANGLE PIECE '97	1
47	55007016001	PVC-HOSE 7X10 PER METER	x
50	54803096000	SPROCKET COVER 250 SX	1
59	77203053000	CHAIN SLIDING PIECE BELOW	1

125030311 / C135030310

* NEW PART

X AS REQUIRED

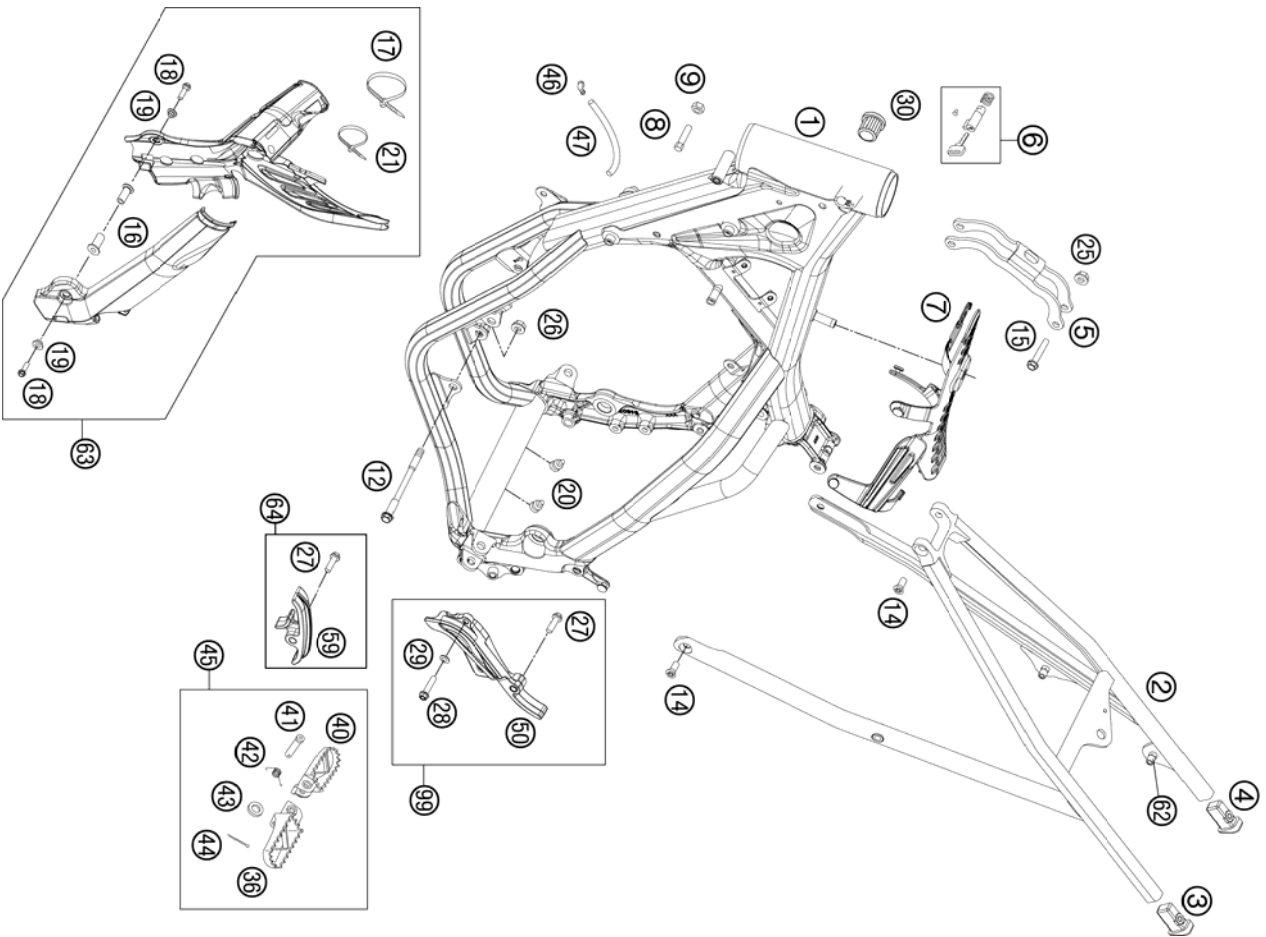

FIG	PART NUMBER	DESCRIPTION	QTY
62	77303139000	BLIND RIVET NUT EM6-60LF/HX	4
63	77203094000	PLASTIC FRAME PROTECTION SET	1
64	77203053010	CHAIN SLIDING KIT BELOW CPL.11	1
99	54803096010	SPROCKET COVER KIT	1

125030311 / C135030310

* NEW PART

X AS REQUIRED

SHOCK ABSORBER DISASSEMBLED

125 EXC EU 2013

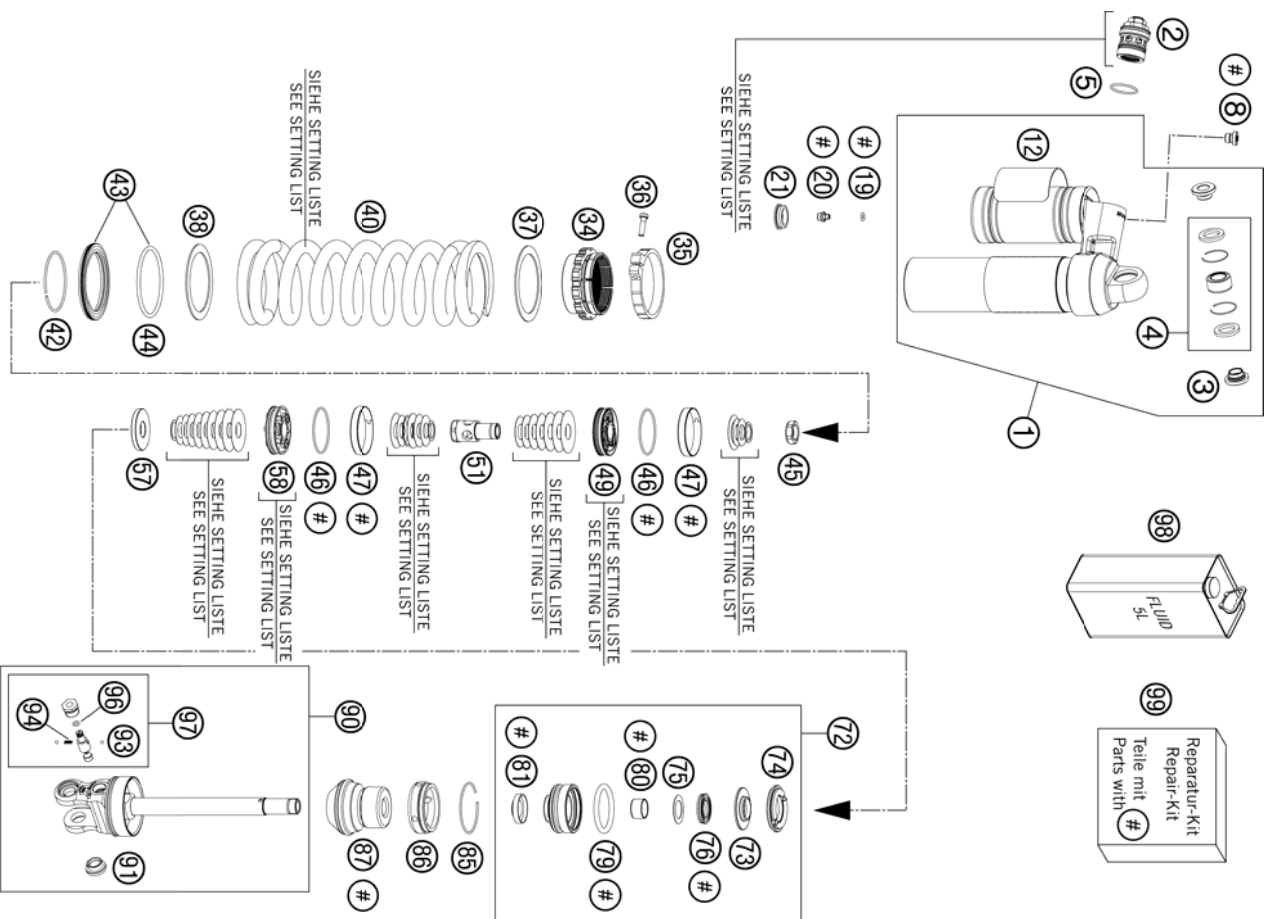

FIG	PART NUMBER	DESCRIPTION	QTY
1	50180833SA2	MONOSHOCK UPPER PART CPL.	1
2	50180213S10	DGC-COMPR.DAMP.CONTROL CPL. 07	1
3	46180007	ADAPTOR BUSH KGW 12X24	2
4	R12012	REP. KIT BEAR./SEAL UP. 07	1
5	50180217	O-RING 27X1,5 VITON	1
8	50180095	BLEED PLUG R 1/8	1
12	52000085	WP CAUTION (PDS KTM)	1
19	46810893	O-RING NBR 5,28X1,78	1
20	36120151	SCREW PLUG M5X6	1
21	46811208	RUBBER CAP "DO NOT OPEN"	1
34	50180938	ADJUSTING NUT PLASTIC	1
35	50180937	TENSIONING RING D64 H10	1
36	14460042	ALLENHEAD SCREW M5 L=20 STAINL	1
37	50180965	SPACER RING SPRING 61,3X78X3	1
38	50180114	SPACER RING FOR SPRING	1
40	91210053S	SPRING 250 63N/MM ORANGE	X
40	91210054S	SPRING 250 66N/MM ORANGE	X
40	91210068S	SPRING 250 69N/MM ORANGE	X
40	91210069S	SPRING 250 72N/MM ORANGE	X
42	50180273	SPRING 250 76N/MM	X
43	50180463S	CIRCLIP 58,2X2	1
44	50180352	SPRING RET. D=80 W. O-RING 05	1
45	50180627	O-RING VITON 66,27X3,53	1
46	50180099	PISTON ROD NUT M20X1	1
47	50180135	O-RING VITON 44,17X1,78	2
49	50180675	PISTON RING 50-8	2
51	50180973	PISTON D=20	1
57	50180970	SUPPORT D20 M20X1 L51,3 PDS	1
58	50180197	REBOUND DISC D43	1
72	50180603S	PISTON 6+6X7/4,5	1
73	50180113	ADAPTOR CPL. D=50 H=28 08	1
74	50180107	STEEL DISC 18X,5X43,7X6	1
75	50180604	REBOUND RUBBER	1
76	50180605S	SHIM D29,75 X D19 X T0,4 08	1
		SEAL D18X30X5 08	1

125480430 / C127740430

* NEW PART

X AS REQUIRED

SHOCK ABSORBER DISASSEMBLED

125 EXC EU 2013

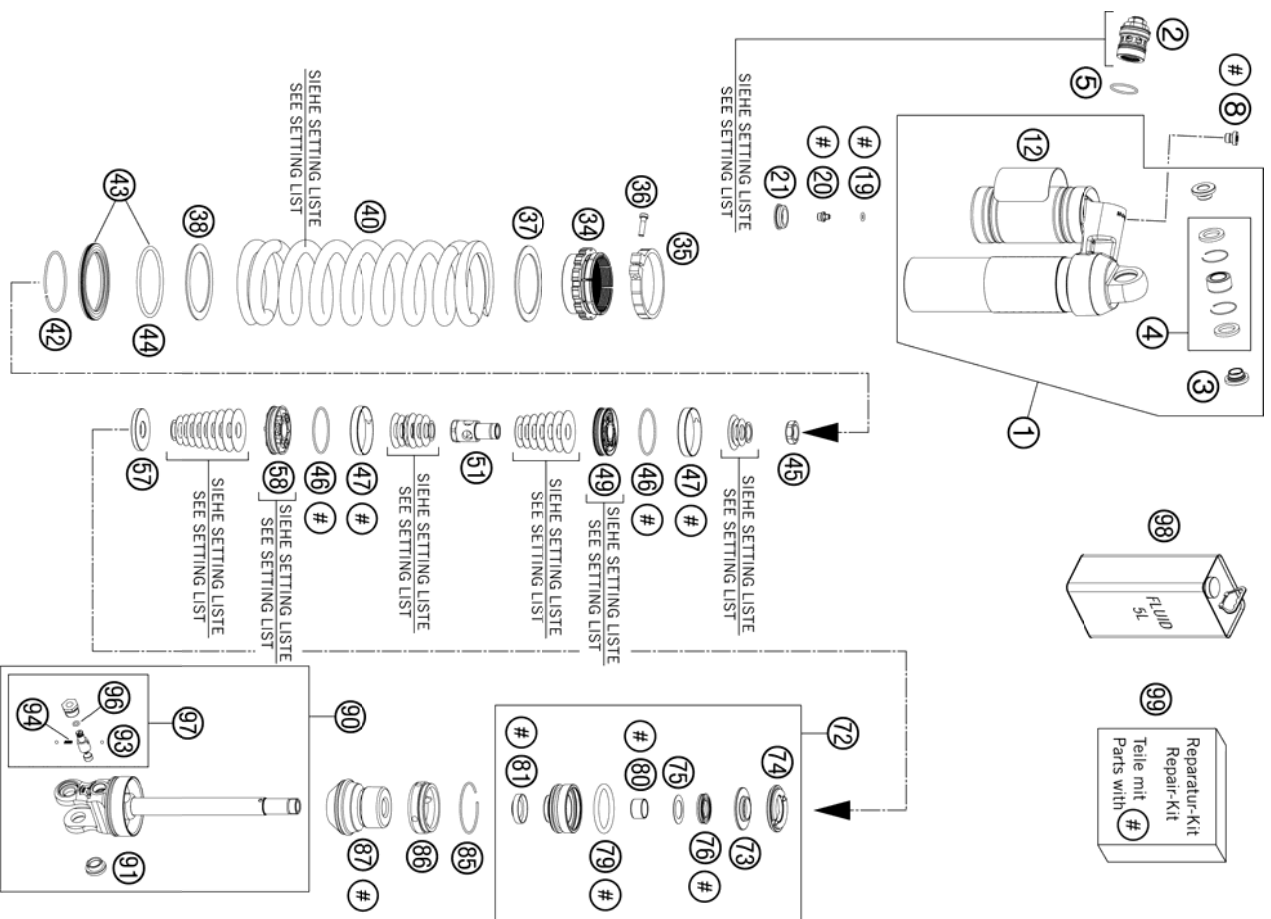

FIG	PART NUMBER	DESCRIPTION	QTY
79	50180103	O-RING 41X5	1
80	46180119	DU-BUSH 18X20X12	1
81	50180606	DUST SEAL 1828	1
85	50180126	CIRCLIP 53X1,75	1
86	50180626	RESERVOIR CAP D=50 H=10	1
87	50180600	BUMP RUBBER D58 D17 H59	1
90	50180512S44	SHOCK ABS. LOWER PART CPL. 12	1
91	50180105	THREADED BUSH M12 PDS	1
93	40540603	STEEL BALL D=3MM	2
94	48600028	SPRING D=2,9 L=7,9	1
96	50180222	O-RING NBR 4X1,5	1
97	50180434S	ADJUSTING SCREW REBOUND TRAVEL	1
98	50180751S1	SHOCK ABSORBER FLUID 5 LT	1
99	R12015	REPAIR KIT 5018 PDS	1

125480430 / C127740430

* NEW PART

X AS REQUIRED

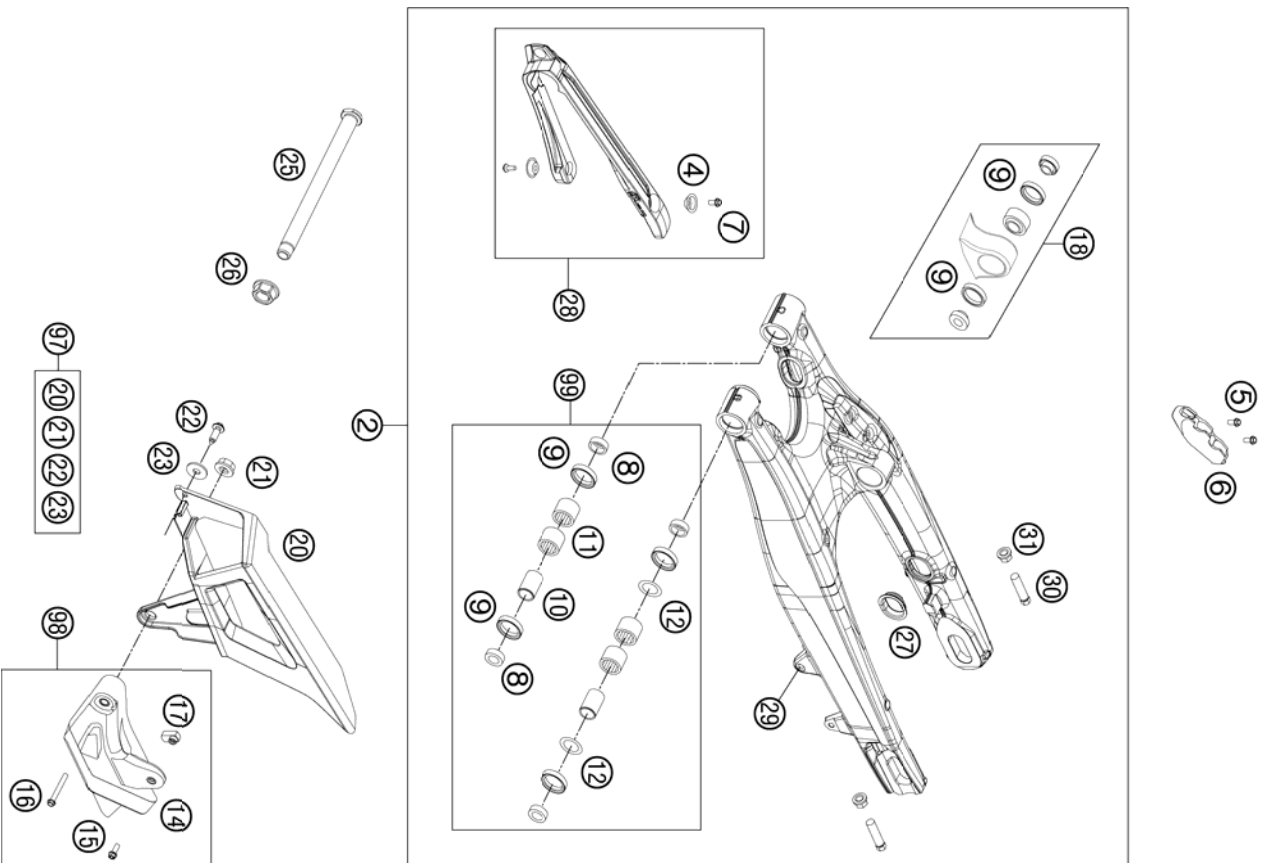

FIG	PART NUMBER	DESCRIPTION	QTY
2	51504030044	SWING ARM CPL. PDS 2011	1
4	77304066050	BUSHING F. CHAIN SLIDING PR.07	2
5	0009050106	EJOT SPIRAL SCREW SF M5X10-K	2
6	77313047000	BRAKE HOSE GUIDE LOWER 07	1
7	59009062013	SPECIAL SCREW M6X13 WS=8 10.9	2
8	54804034000	BUCKET F. SHAFT SEAL RING 03	4
9	0760253270	SHAFT SEAL RING 25X32X7	6
10	54804032000	BUSHING SLEEVE F. SWING ARM 03	2
11	58033097000	NEEDLE BEARING HK 2216	4
12	54603036000	STOP DISK 22,2X31,7X1	2
14	78004070100	CHAIN GUIDE CPL.	1
15	59009062019	SPECIAL SCREW M6X19 WS=8 10.9	1
16	0025060506	HH COLLAR SCREW M6X50 TX30	1
17	77304070030	INSERTION NUT F. CHAIN GUIDE	1
18	50304090144	PIVOT BEARING+BUSH. PDS '11	1
20	78104060000	CHAIN GUARD	1
21	56509064100	SELF LOCKING NUT M6 10.9	1
22	0017060203	EJOT PT SCREW K60X20 WS=6	1
23	0021060003	WASHER DIN9021-A 6,4	1
25	77304037000	SWINGARM BOLT M16X1,5 07	1
26	54804038000	SELF LOCK NUT M16X1,5 WS=19.03	1
27	77204041000	CLOSING COVER	4
28	51504066044	CHAIN SLIDING GUARD KIT 11-12	1
29	54603055051	PRESS IN NUT M6 STEEL ZINC	1
30	50304040100	SCREW M10X1,25X50 WS=10	2
31	58414030000	HH COLLAR NUT M10X1,25 WS=13	2
97	78104060010	CHAIN PROTECTION KIT EXC 12	X
98	77304070310	CHAIN GUIDE KIT REAR 08-12	X
99	54804230210	SWINGARM REPAIR KIT 05-12	X

127750490 / C127750490

* NEW PART

X AS REQUIRED

SHOCK ABSORBER

125 EXC EU 2013

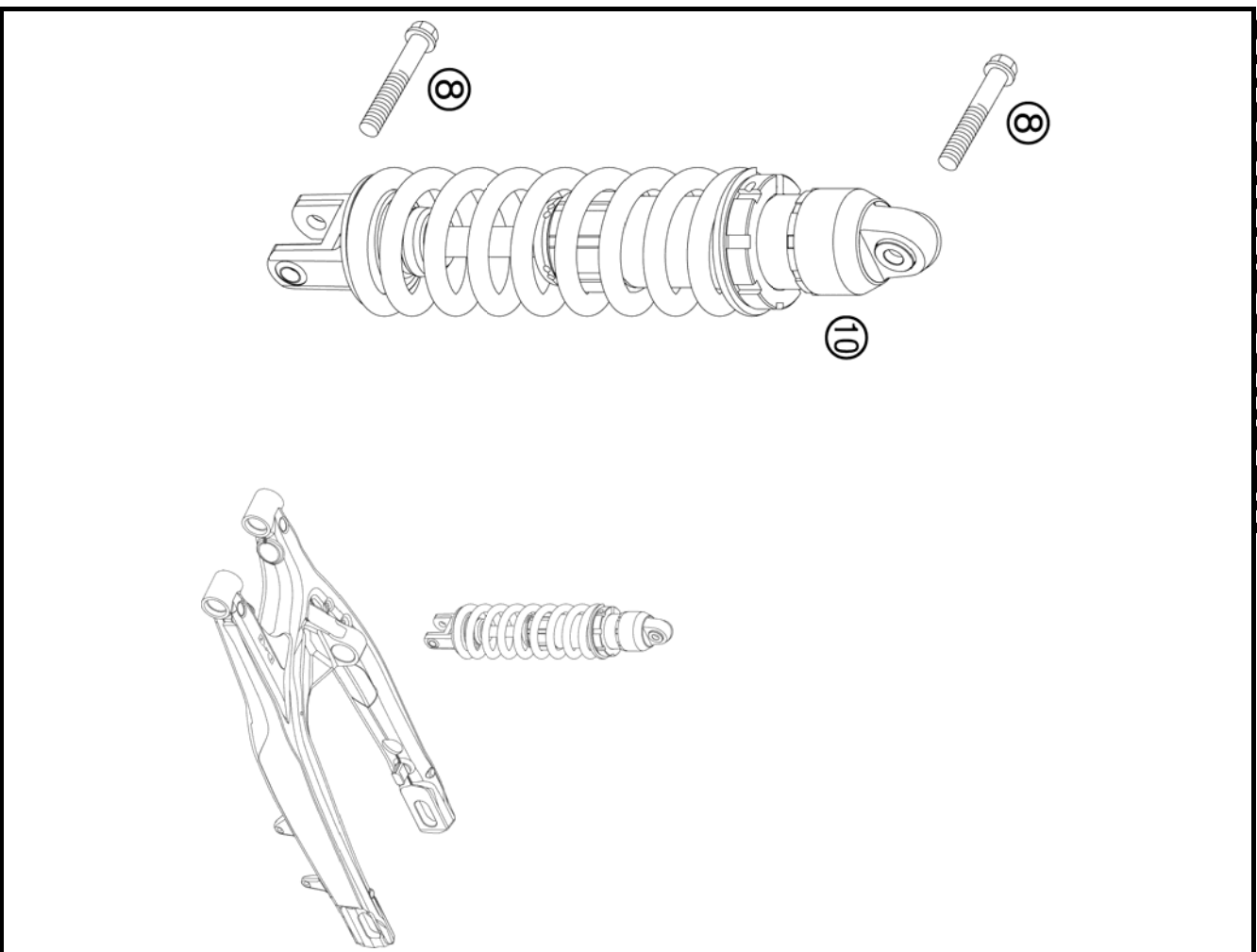

FIG	PART NUMBER	DESCRIPTION	QTY
8	0025120506S	HH COLLAR SCREW M12X50 TX45	2
10	12187L6101	MONOSHOCK 5018 PDS 125/200 EXC	1

085030410 / C135030410

* NEW PART

X AS REQUIRED

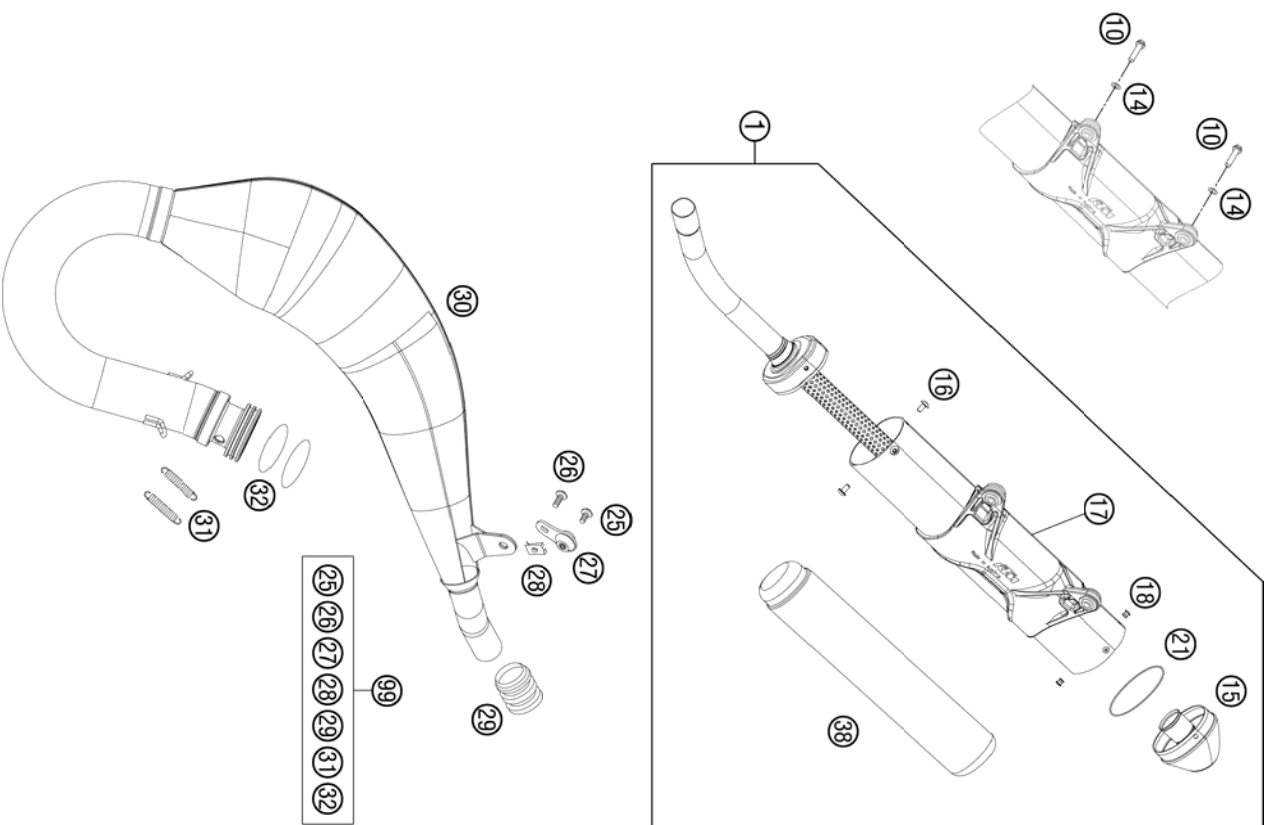

FIG	PART NUMBER	DESCRIPTION	QTY
1	50305083200	SILENCER 125 EXC	1
10	0025060306	HH COLLAR SCREW M6X30 TX30	2
14	0137060003	SPRING WASHER DIN0137-B 6	2
15	50305083260	END CAP CPL	1
16	58605083010	SCREW TORX M5X10 05	4
17	50305183085	SILENCER HOUS. CPL. W. HANGING	1
18	0011480800	DUMMY RIVET 4, 8X 8 NIRO	4
21	0770740015	O-RING 74,00X1,50 FKM 75SH	2
25	0024060106	HH COLLAR SCREW M6X10 TX30	1
26	0024060156	HH COLLAR SCREW M6X15 TX30	1
27	50305012000	SWINGELEMENT FOR EXHAUST PIPE	1
28	54603048100	RANGE CHANGE METAL NUT M6	1
29	54605057000	RUBBER SLEEVE D=21MM/23MM '93	1
30	50305107000	EXHAUST MANIFOLD	x
30	50305109000	EXHAUST PIPE 125EXC DW CPL 12	1
31	50305016000	TEN.SPRING L=62MM EY.MOVEABLE	2
32	0770440030	O-RING 44,00X3,00 VITON	2
38	54805078255	ROCK WOOL 265G	1
99	00050000810	EXHAUST HARDWARE KIT 05-12	x

125030510 / C135030511

* NEW PART

X AS REQUIRED

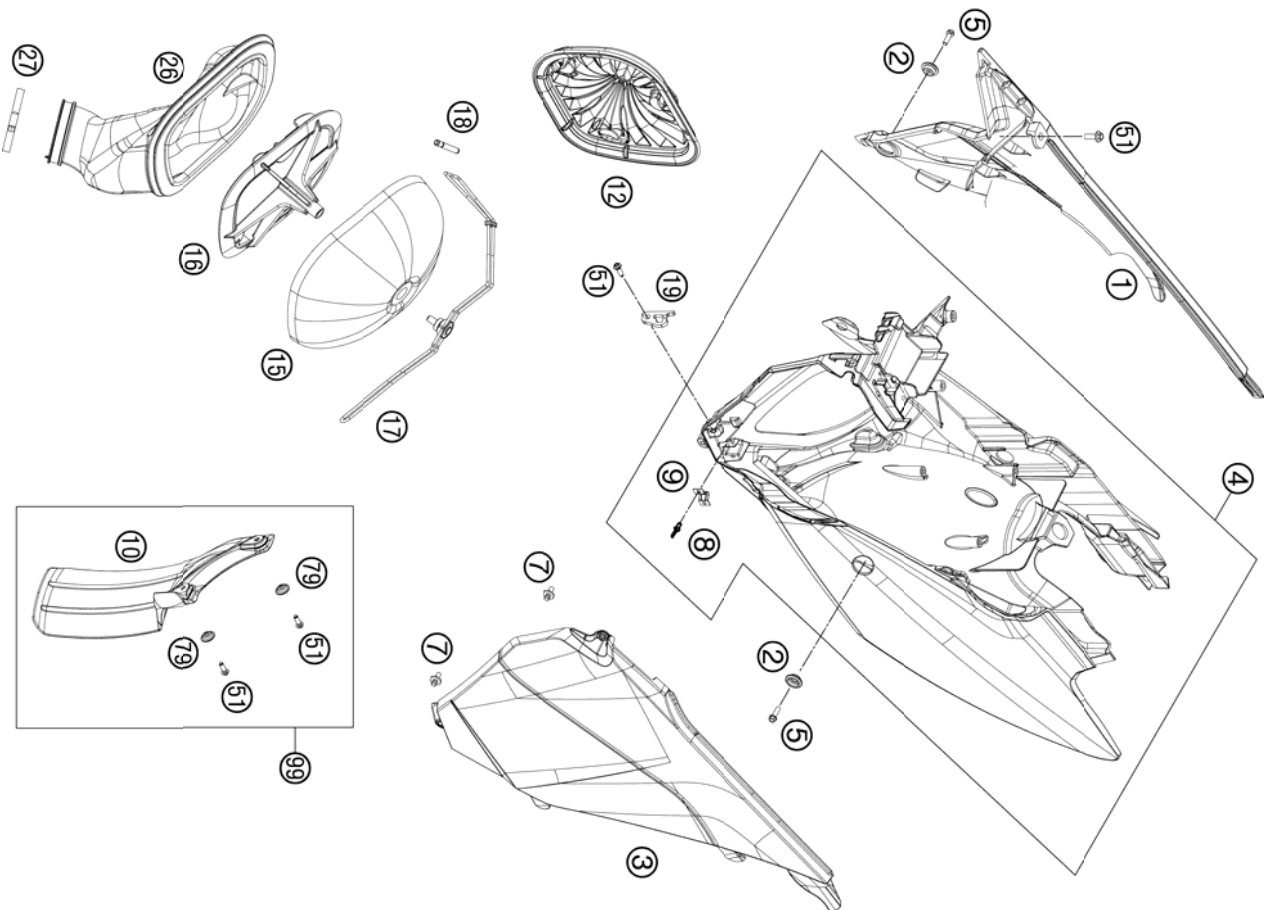

FIG	PART NUMBER	DESCRIPTION	QTY
1*	7720600410004C	AIRFIL.BOX COV. R/S PDS EXC 13	1
2	77308013010	COLLAR BUSH. F.REAR FENDER 07	2
3*	7720600300004G	AIRFILTERBOX COVER L/S EXC 13	1
4*	7770600104428	FILTER BOX CPL. WHITE 13	1
5	0025060206	HH COLLAR SCREW M6X20 TX30	2
7	54806008051	QUICK RELEASE-NIPPLE 03	2
8	54806108052	BLIND RIVET 3,3X9,7 GROOVED 04	4
9	54806008050	QUICK RELEASE-SPRING HANGER	2
10	77306010000	FENDER FOR FILTER BOX	1
12	78106012000	TROTTLER VALVE	1
15	77206015000	AIR FILTER	1
16	54806516000	FILTER CARRIER	1
17	77206017000	FILTER SUPPORT CPL. 11	1
18	77306018000	FILTER SUPPORT BUSH 07	1
19	77206019000	FASTEN. DEVICE FILTER S. SX 11	1
26	51506026000	CABURETOR CONNECTING	1
27	51006027000	HOSE CLAMP 50-70MM	1
51	0017060204	EJOT PT SCREW K60X20 ALU WS=6	4
79	77304066050	BUSHING. F. CHAIN SLIDING. PR.07	2
99	77306010010	SPLASH PROTECTOR KIT SX/EXC	x

135030610 / C135030610

* NEW PART

X AS REQUIRED

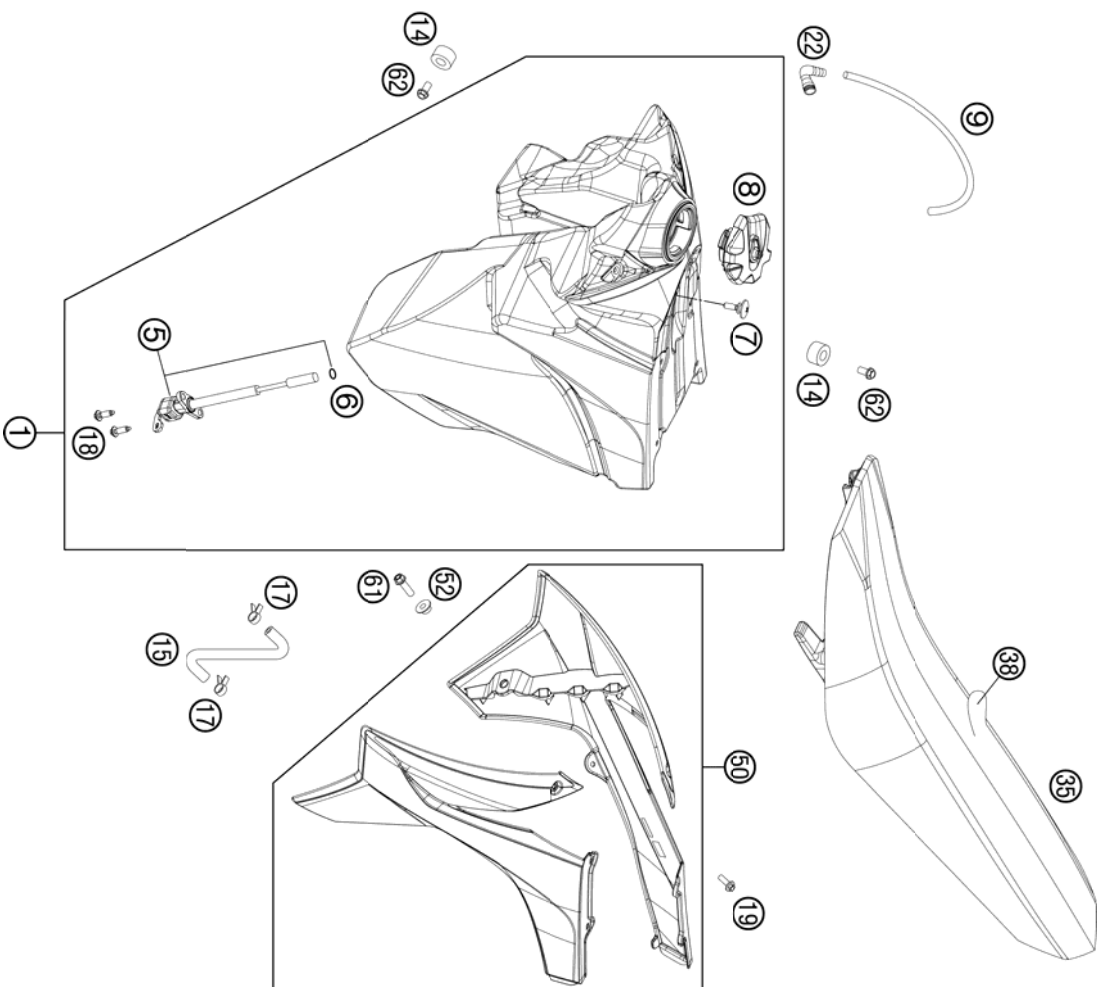

FIG	PART NUMBER	DESCRIPTION	QTY
1	5480761303399	FUEL TANK CPL. 9,5 L EXC 2T 12	1
5	54807004000	GAS COCK ON/OFF/RES 03	1
6	0770110021	O-RING 11X2 VITON	1
7	50307011000	SCREW SEAT FASTENING D=6X23/18	1
8	78007008044X4	TANK PLUG ORANGE/BLACK	1
9	78007000270	PVC-HOSE 5,6X10X270MM	1
14	50307014000	TANK ROLLER 12X26X12 '98	3
15	54807016100	FUEL HOSE 2ST EXC 08	1
17	58031005000	CLAMP YDNAC 10128 12MM	2
18	0017060203	EJOT PT SCREW K60X20 WS=6	2
19	0017060204	EJOT PT SCREW K60X20 ALU WS=6	8
22	51030022000	ANGLE PIECE 90 DEGREE M10X1	1
35	77207040000	SEAT CPL.	1
38	77207040050	SEAT COVER	1
50*	7720805400004G	SPOILER KIT EXC/XC-W 2013	1
52	50308052000	WITH DECAL	1
61	0025060206	BUSH FOR SPOILER 6X11X16X5 MM	2
62	0026060136	HH COLLAR SCREW M6X20 TX30	2
		COLLAR SCREW M6X13 ISA30	3

125030710 / C135030710

* NEW PART

X AS REQUIRED

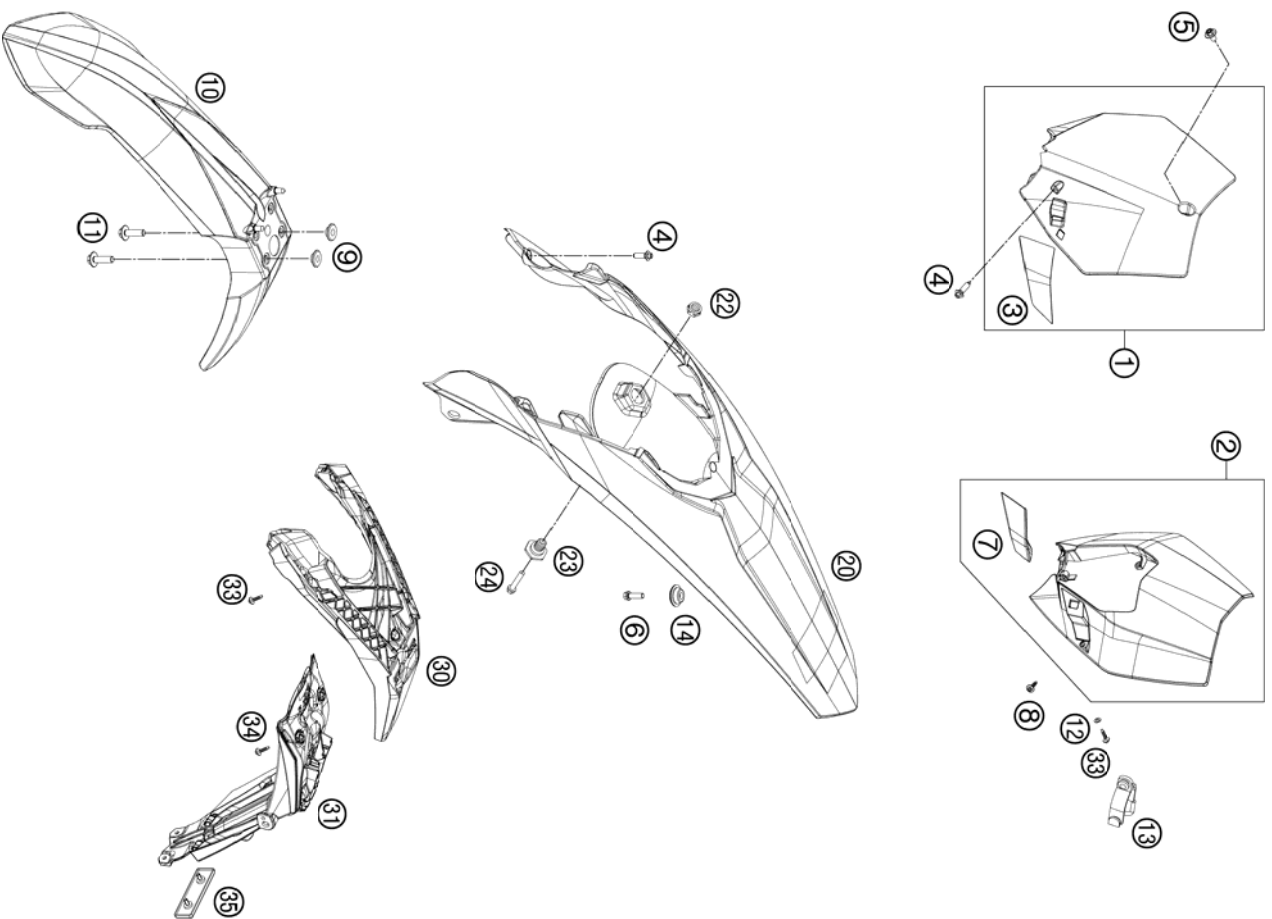

FIG	PART NUMBER	DESCRIPTION	QTY
1	7730800704428	START NUMBER PLATE CPL. WHITE	1
2	7800800100028	HEAD LIGHT MASK WHITE 2011	1
3	7730802200030	BRAKE HOSE GUIDE BLACK 08	1
4	0017060204	EJOT PT SCREW K60X20 ALU WS=6	2
5	0024060106	HH COLLAR SCREW M6X10 TX30	1
6	0025050206	HH COLLAR SCREW M5X20 TX30	2
7	7800802200028	BRAKE HOSE GUIDE WHITE	1
8	0081050181	SCREW FOR PLASTIC K50X18 T20	3
9	54808020000	SPACER BUSHING 03	4
10	7730801000004	FRONT FENDER 07	1
11	0024060206	HH COLLAR SCREW M6X20 TX30	4
12	0125060003	WASHER DINO125-A 6,4	1
13	50211086000	MASK RUBBER UFO WP '95	2
14	77308013010	COLLAR BUSH. F.REAR FENDER 07	2
20	7810801300004	REAR PART ORANGE	1
22	50314057050	COLLAR NUT M12X1/MS17 H=5MM	1
23	54807048000	BUSHING FOR SEAT FASTENING 03	1
24	0025060256	HH COLLAR SCREW M6X25 TX30	1
30	78108016000	NUMBER PLATE CARRIER TOP	1
31	78108016050	NUMB. PLATE CARRIER BOTTOM	1
33	0017060203	EJOT PT SCREW K60X20 WS=6	3
34	0017060303	SPECIAL SCREW T60 6X30 WS=6	2
35	58412080000	REFLECTOR RED LC4 '98	1

127750810 / C127750810

* NEW PART

X AS REQUIRED

FIG	PART NUMBER	DESCRIPTION	QTY
1	77308198100	DECAL HEADLIGHT MASK EXC	12
2*	50308598500	DECAL REAR PART 125 EXC	2013

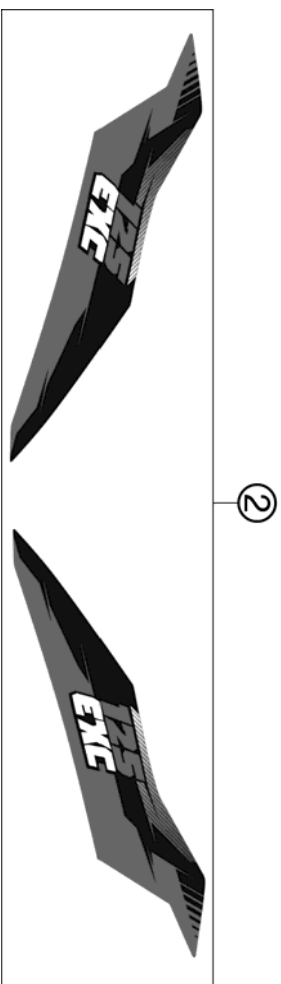
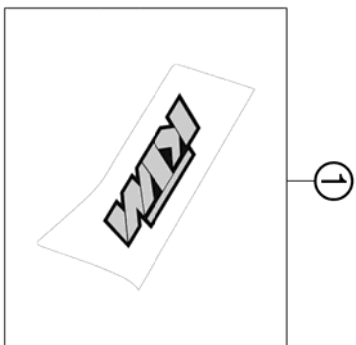

135030831 / C135030831

* NEW PART

X AS REQUIRED

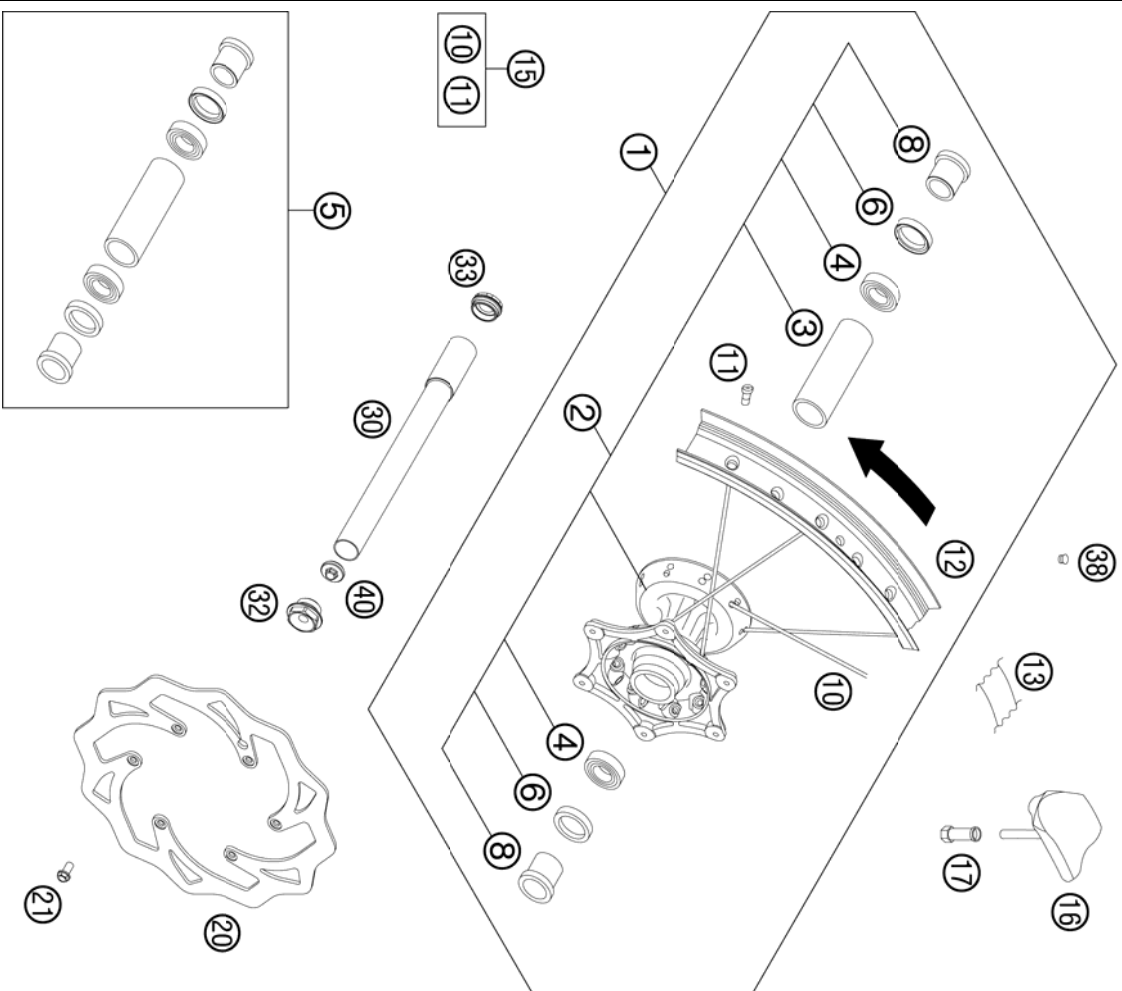

FIG	PART NUMBER	DESCRIPTION	QTY
1*	51509001344	FRONT WHEEL CPL.1.6X21EXCEL 13	1
2	78009010144	FRONT WHEEL HUB CPL.	1
3	54809011000	BEA.SPACERTUBE 35X2 L=79,4 03	1
4	0625069068	GR.BALL BEAR.6906 DDU2CG23S6NM	2
5	78009015000	FRONT WHEEL REP. KIT	1
6	0760354771	SHAFT SEAL RING 35X47X7 TC	2
8	78009012000	SPACER BUSHING F. FR. WHEEL 08	2
10*	7710907122630	SPOKE M4,5X226- 21" BLACK 12	36
11	77109072000	SPOKE NIPPLE M4,5 AL 11	36
12	51509070000	RIM FRONT 1,6"X21" EXCEL AL7	1
13	50309073000	RIM BAND 21"	1
15	00050000954	SPOKE KIT FRONT "21" BLACK	x
16*	78109090000	RIM LOCK 1,60"	1
17*	77110090050	NUT FOR WHEEL HOLDER	1
20	77309060000	BRAKE DISC FRONT 260	1
21	59009062013	SPECIAL SCREW M6X13 WS=8 10,9	6
30	77309081000	WHEEL SPIN.FR. D=26 M24X1,5 07	1
32	54809082000	SPINDLE SCREW M24X1,5 WS=27 03	1
33	54809081050	PLUG BUSHING WS=27 03	1
38	55003135000	PLUG FOR RIM	x
40	54809081070	AUXILIARY SCREW FRONT 06	1

117710910 / C135030910

* NEW PART

X AS REQUIRED

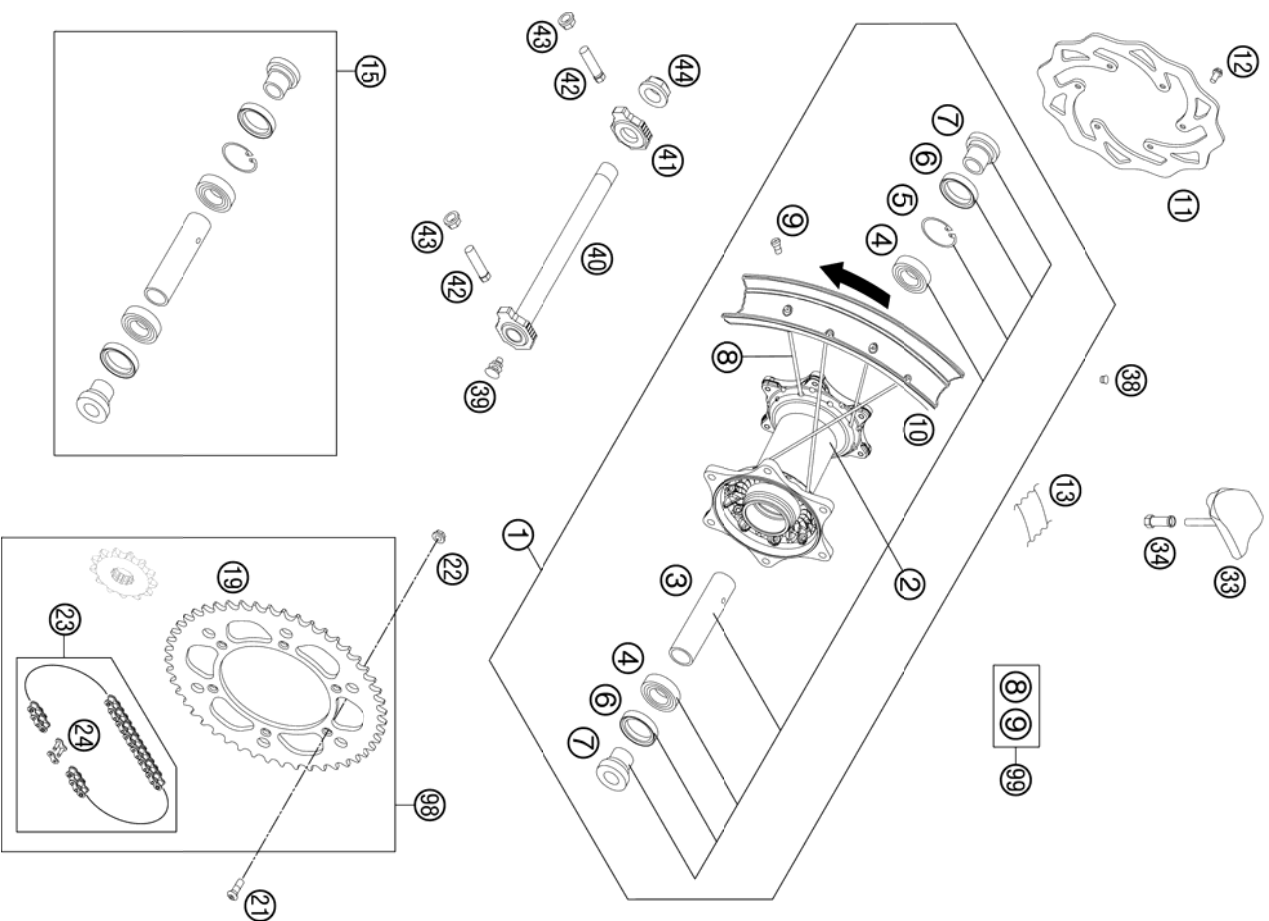

FIG	PART NUMBER	DESCRIPTION	QTY
1*	51510001344	REAR WHEEL CPL. 2.15X18"EXC 13	1
2	78010010144	REAR WHEEL HUB CPL.	1
3	59010011000	BUSHING SPACER TUBE 121,5MM 01	1
4	0625060058	GR BALL BEAR.6005 DDU2CG23S6NM	2
5	0472047175	CIRCLIP DIN0472-47X1,75	1
6	0760324771	SHAFT SEAL RING 32X47X7 BSL	2
7	78010016000	BUSHING FOR HUB 08	2
8*	7711007119330	SPOKE M4,5X193- 18" BLACK 12	36
9	77109072000	SPOKE NIPPLE M4,5 AL 11	36
10	51510070000	REAR RIM 2,15"X18"EX. AL7	1
11	77310060000	BRAKE DISC REAR 220	1
12	59009062013	SPECIAL SCREW M6X13 WS=8 10.9	6
13	50310073200	RIM BAND 18" AND 19"	1
15	78010015000	REAR WHEEL REP. KIT	1
19	58310051038	REAR SPROCKET 38-T	X
19	58310051042	REAR SPROCKET 42-T	X
19	58310151040	REAR SPROCKET 40-T	X
19	58310151045	REAR SPROCKET 45-T	X
19	58310151048	REAR SPROCKET 48-T	X
19	58310151049	REAR SPROCKET 49-T	X
19	58310151050	REAR SPROCKET 50-T	X
19	58310151051	REAR SPROCKET 51-T	1
19	58310151052	REAR SPROCKET 52-T	X
21	00190802665	COUNTER-SUNK SCREW ISA45 M8X26	6
22	06923080003	HEXAGON NUT DIN EN1661 M8 SW13	6
23	78010167118	CHAIN DID 118 ROLLS	1
24	78010166000	CONNECTING LINK F. 78010167118	1
33*	78110090000	RIM LOCK 2,15"	1
34	77110090050	NUT FOR WHEEL HOLDER	1
38	55003135000	PLUG FOR RIM	X
39	50210086000	COVERING CAP SFL16	X
40	77310085044	WHEEL SPINDLE RE. CPL.265MM 07	1
41	50310084000	CHAIN TENSIONER R/S 2000	1
42	50304040100	SCREW M10X1,25X50 WS=10	2
43	58414030000	HH COLLAR NUT M10X1,25 WS=13	2

125481010 / C135031011

* NEW PART

X AS REQUIRED

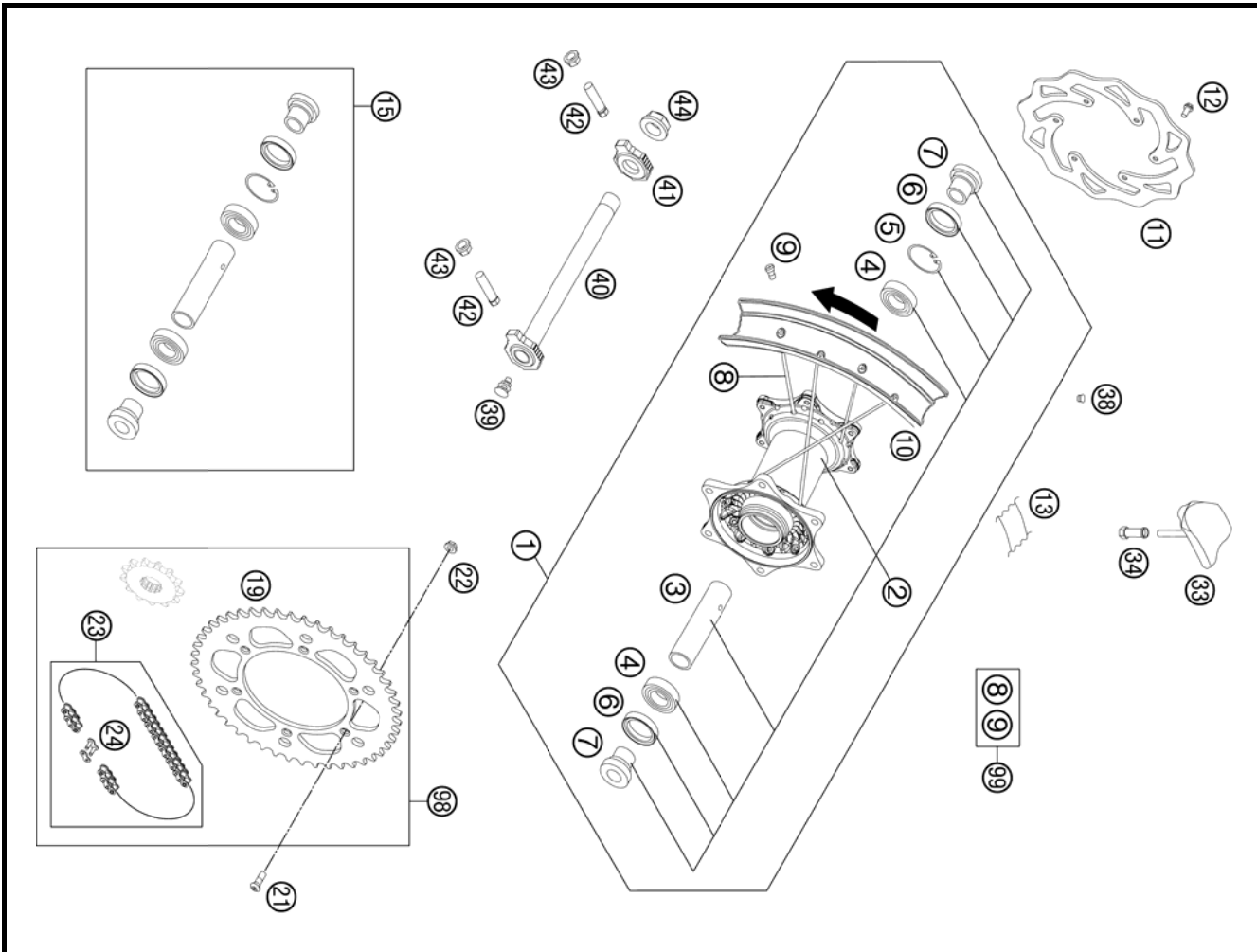

FIG	PART NUMBER	DESCRIPTION	QTY
44	50310099000	HEXAGON NUT M20X1,5 '98	1
98	00050002008	DRIVETRAIN KIT EXC/XC 14T/50T	X
99	00050000958	SPOKE KIT REAR 18" BLACK	X

125481010 / C135031011

* NEW PART

X AS REQUIRED

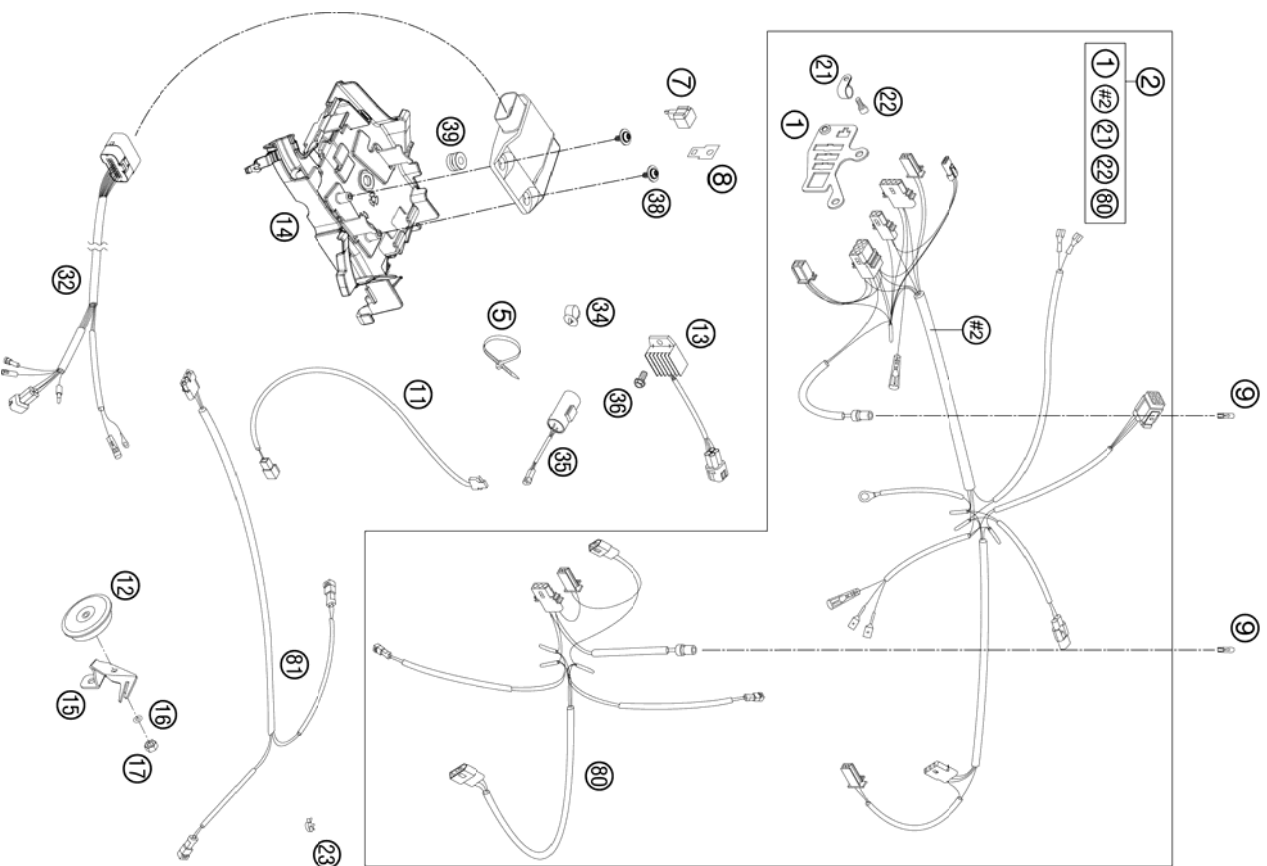

FIG	PART NUMBER	DESCRIPTION	QTY
1	54811083100	SUPPORT BRACKET EXC 2005	1
2	50311075900	WIRING HARNESS 125/200EXC CP12	1
5	44011076140	CABLE TIE 140/2,5MM BLACK	X
5	44011076200	CABLE TIE 200/3,6MM BLACK	X
5	44011076305	CABLE TIE 300/4,8MM BLACK	1
7	44611207200	FLASHER UNIT 97	1
8	58211031100	BRACKET FOR FLASHER RELAY	1
9	49111425200	BULB 12V 2,3W (W2X4,6D)	2
11	50311050100	BRAKE LIGHT SWITCH FRONT 2002	1
12	50311060200	DC HORN 12V 07	1
13	80011034000	VOLTAGE REGULATOR 04	1
14*	51511094100	ELECTRIC CASE	1
15	78011061000	HORN BRACKET EXC 08	1
16	0125050003	WASHER DINO125-A 5,3	1
17	0934050003	HEXAGON NUT DINO934-M 5	1
21	57013070000	PVC-CLAMP 7/16" HEYCO 3377	1
22	0912050083	AH SCREW DIN 912 M 5X8	1
23	57013072000	WIRING HOLDER 12MM	X
23	57013072100	WIRING HOLDER 16MM	X
23	57013072100	WIRING HARNESS FOR CDI 2-ST.07	1
32	54839032200	CABLE SUPPORT KHS NR.150-4/7610	1
34	58111076000	CONDENSATOR 2200MF ADP-48 2000	1
35	50311035000	COLLAR SCREW M6X12 TX	1
36	0023060123	EJOT DELTA PT SCREW 45X12-Z	2
38*	0081645121	RUBBER GROMMET 16X10,8X3 02	1
39	58214069051	FLASH. WIRINGHARNESS FRONT 06	1
80	59011080100	REAR FLASHER WIR. HARNESS 12	1
81	77411081000		1

125031110 / C135031110

* NEW PART

X AS REQUIRED

BRAKE CALIPPER REAR

125 EXC EU 2013

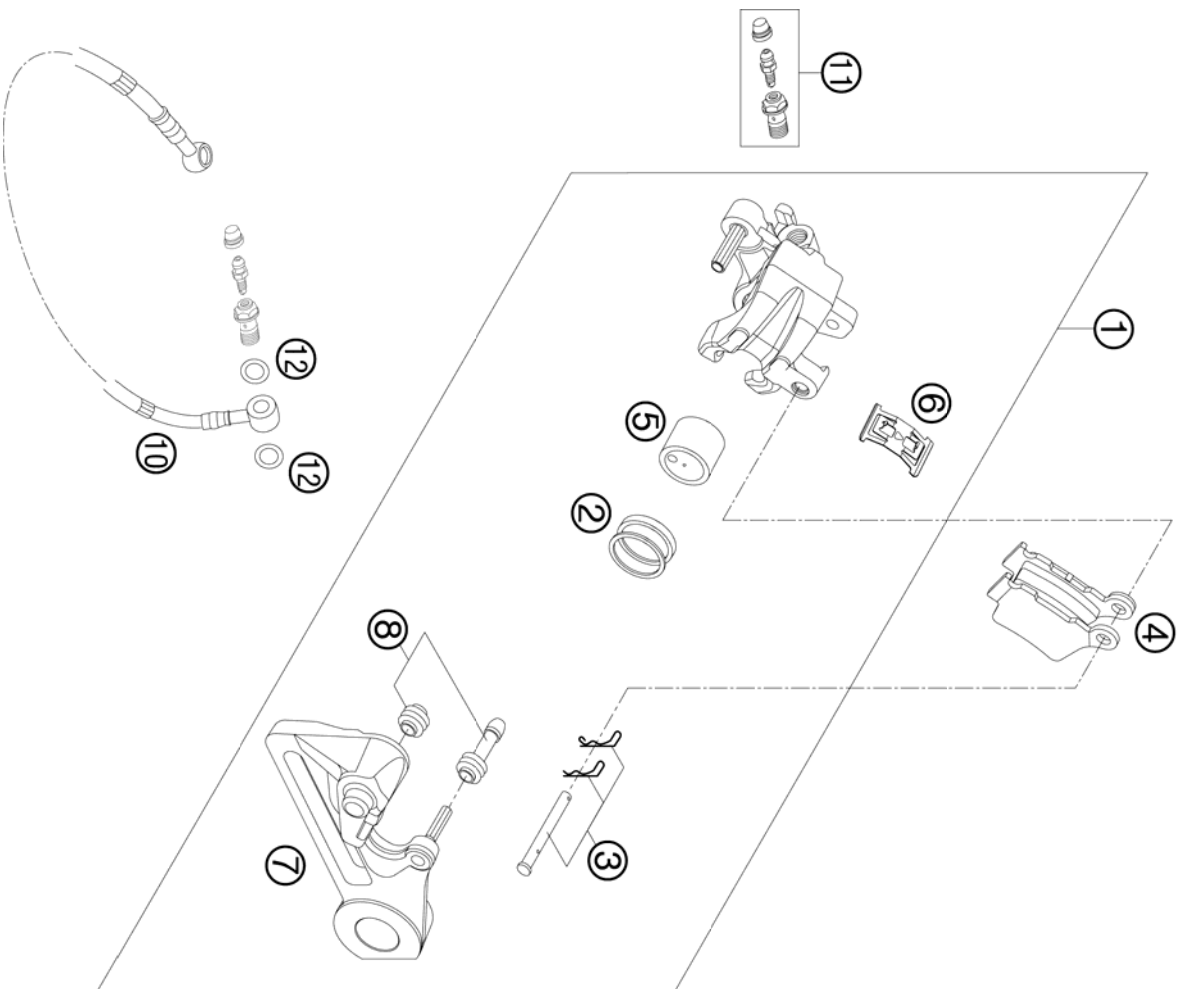

FIG	PART NUMBER	DESCRIPTION	QTY
1	54813080101	BRAKE CAL. RE. - WITHOUT PADS	1
2	50313081200	REPAIR KIT SEALING RINGS 26MM	1
3	54813082000	BOLT SET FOR BRAKE CALIPER 03	1
4	54813090300	BRAKE PAD SET REAR TOYO	1
5	54813083000	BRAKE PISTON 26MM 2003	1
6	54813018000	RETAINING SPRING SET 2003	1
7	54813075000	BRAKE CALIPER SUPPORT REAR	1
8	54613218000	CUP SET SHORT	1
10	54813070000	BRAKE HOSE REAR 655MM 03	1
11	62513020000	BLEEDER SCREW CPL. 05	1
12	0603100141	COPPER GASKET DIN7603-10X14X1	2

095031390 / C105031390

* NEW PART

X AS REQUIRED

BRAKE CALIPPER FRONT

125 EXC EU 2013

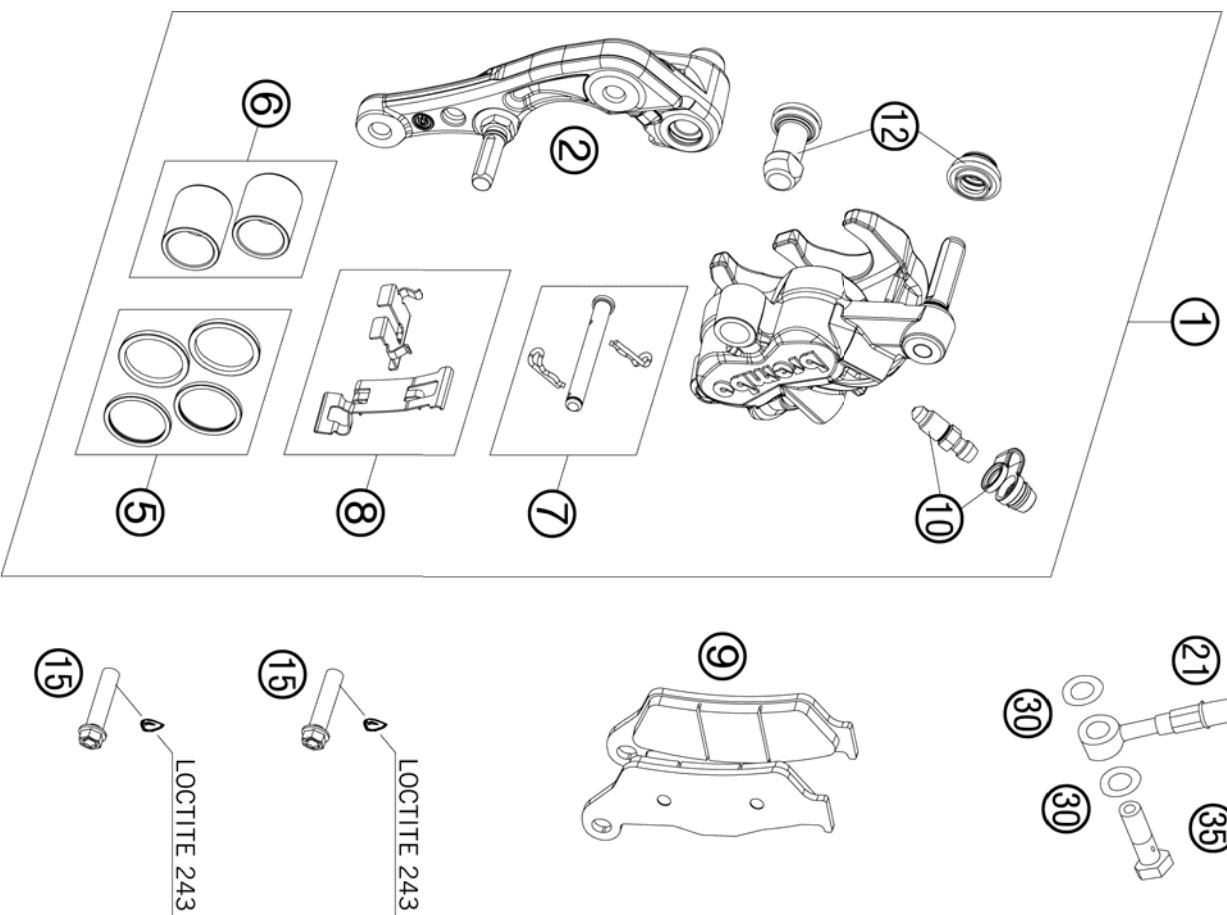
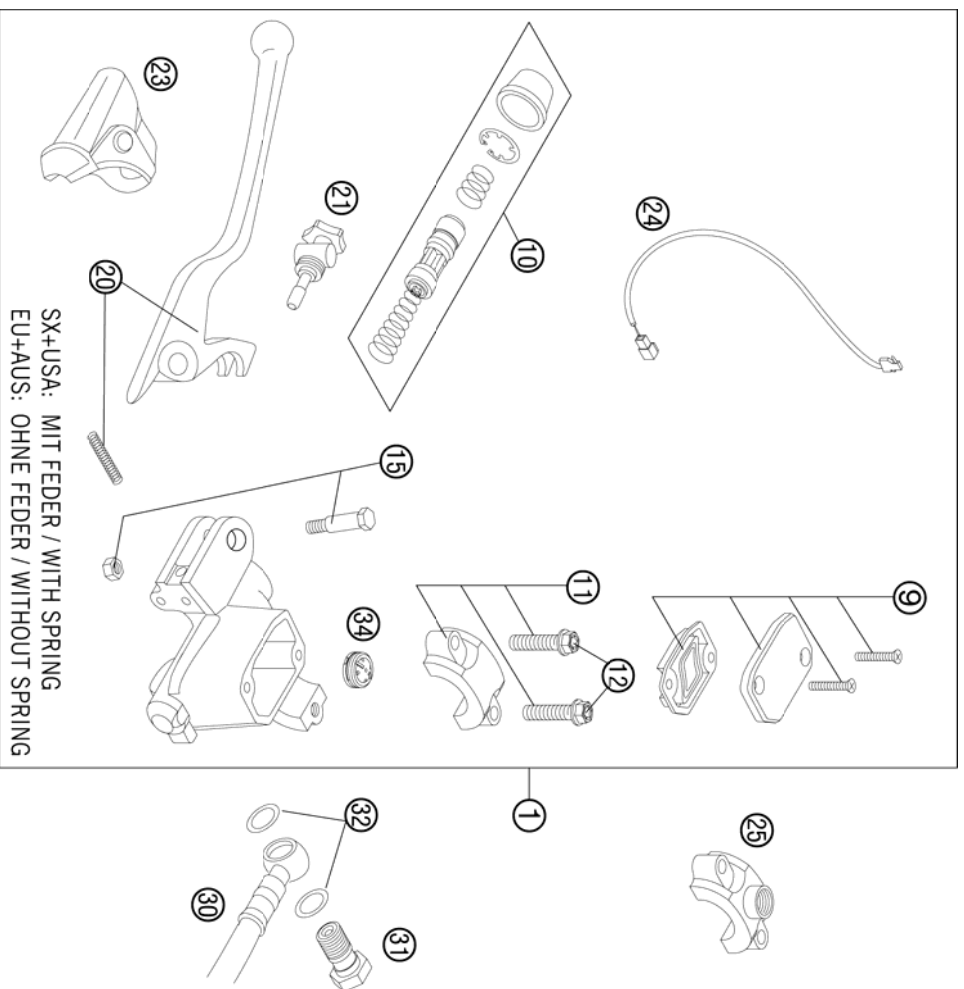

FIG	PART NUMBER	DESCRIPTION	QTY
1	7701301500101	CALIPPER MAT. WITHOUT PADS	1
2	77013014000	BRAKE CALIPPER SUPPORT FRONT 09	1
5	77013021000	REP. KIT SEALS 24MM	1
6	77013019000	REP. KIT PISTON 24MM	1
7	77013017000	BOLT CPL. 09	1
8	77013018000	RETAINING PLATE SET BREMBO	1
9	77013020000	BRAKE PADS TOYO B153	1
10	61013020100	BLEEDER SCREW WITH CAP	1
12	54613218000	CUP SET SHORT	1
15	0025080356S	HH COLLAR SCREW M8X35 TX40	2
21	59013011000	BRAKEHO. FRONT 1300MM 2000	1
30	0603100141	COPPER GASKET DIN7603-10X14X1	2
35	50213025000	HOLLOW SCREW M10X1X19	1

097701361 / C107801361

* NEW PART

X AS REQUIRED



SX+USA: MIT FEDER / WITH SPRING
EU+AUS: OHNE FEDER / WITHOUT SPRING

FIG	PART NUMBER	DESCRIPTION	QTY
1	77013001144	HAND BRAKE CYLINDER CPL EXC 09	1
9	50313003000	HANDBRAKE CYL COVER CPL NATURE	1
10	54813008300	REP SET PISTON D=9MM 2009	1
11	50313005000	CLAMP CPL NATURE	1
12	0025060256	HH COLLAR SCREW M6X25 TX30	2
15	50313006100	LEVER SCREW CPL 2001	1
20	54813002200	HAND BRAKE LEVER + SPRING 2009	1
21	54813007300	ADJUSTING SCREW CPL SX 2009	1
23	50313004000	PROTECTION CAP HAND BRAKE CYL.	1
24	50311050100	BRAKE LIGHT SWITCH FRONT 2002	1
25	58012040150	CLAMP FOR MIRROR '94	1
30	59013011000	BRAKEHO. FRONT 1300MM 2000	1
31	54813020100	HOLLOW SCREW BLACK M10X1X19	1
32	0603100141	COPPER GASKET DIN7603-10X14X1 VALVE	2
34	54802051000	BRAKE FLUID DOT5.1 0.25L	1
80	00062030000		1

127811311 / C127811311

* NEW PART

X AS REQUIRED

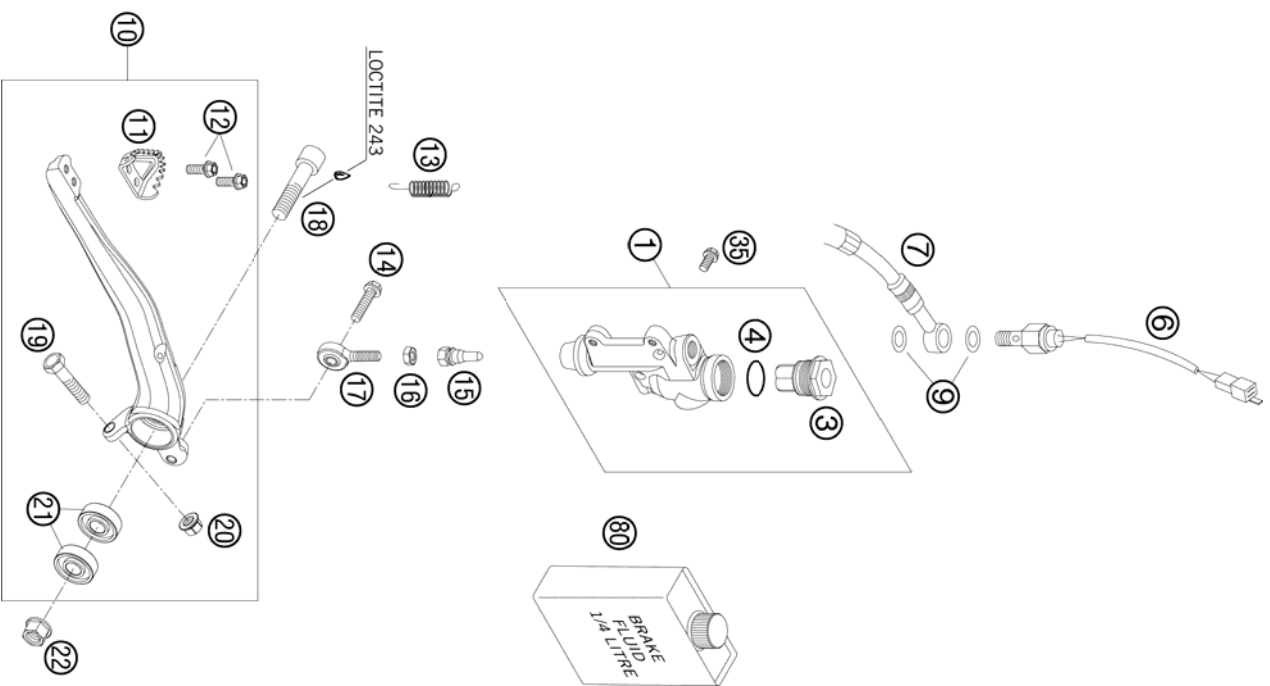

FIG	PART NUMBER	DESCRIPTION	QTY
1*	77013060044	REAR BRAKE CYLINDER CPL.SX 09	1
3	54813062100	REAR BRAKE CYL. COVER CPL. 04	1
4	54813063000	FOOT-BRAKE CYL. GASKET SX 03	1
6	50311051100	BRAKE LIGHT SWITCH REAR '98	1
7	54813070000	BRAKE HOSE REAR 655MM 03	1
9	0603100141	COPPER GASKET DIN7603-10X14X1	2
10	77213050044	FOOT BRAKE LEVER CPL.	1
11	54813051000	STEP PLATE FOR BRAKE LEVER	1
12	0025050126	HH COLLAR SCREW M6X12 TX30	2
13	54603062000	RETURN SPRING FOR BRAKE LEVER	1
14	0025060206	HH COLLAR SCREW M6X20 TX30	1
15	54813056000	PUSH ROD L=28MM 03	1
16	0985060003	SELF LOCK. NUT DIN0985-M6	1
17	54813055000	SWIVEL HEAD KA6 03	1
18*	0032100406S	AH-COLLAR SCREW M10X40 ISAA5	1
19	59001037000	SPECIAL SCREW M8X26 WS=10	1
20	46030045000	COLLAR NUT M8 WS=10	1
21	0625060002	BALL BEARING SKF 6000-2RS1	2
22	54630044000	COLLAR NUT M10 WS=13	1
35	0025060126	HH COLLAR SCREW M6X12 TX30	2
80	00062030000	BRAKE FLUID DOT5.1 0,25L	1

097 801 330 / C135031330

* NEW PART

X AS REQUIRED

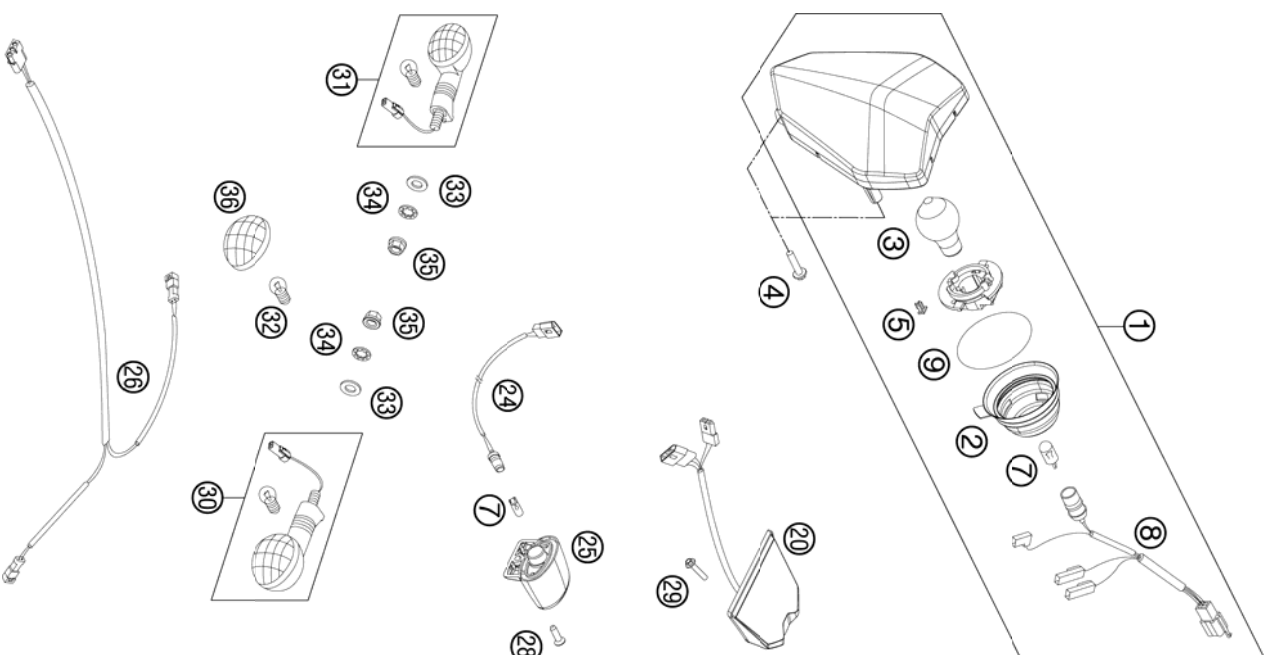
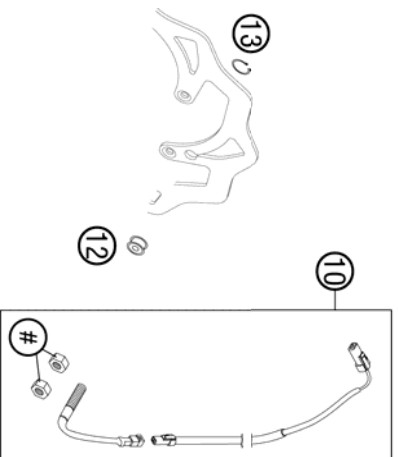
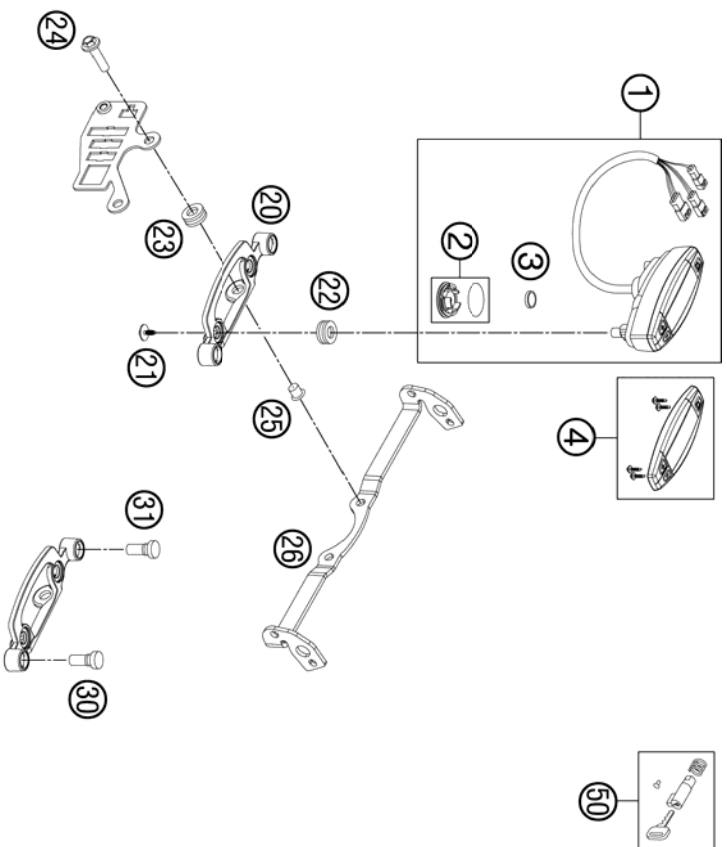

FIG	PART NUMBER	DESCRIPTION	QTY
1	78014001000	HEAD LIGHT CPL. EXC-EU 08	1
2	54814001050	RUBBER CAP FOR HEAD LIGHT 05	1
3	44111038000	BILUX-BULB 12V 35/35W BA20D	1
4	0081050181	SCREW FOR PLASTIC K50X18 T20	3
5	78014009000	DRAIN HOLE COVER	1
7	49011435100	BULB 12V 5W (W2,1X9,5D) PHIL.	2
8	54811001050	CABLE FOR HEAD LIGHT 2005	1
9	0770350032	O-RING 35,00X32,00 NBR	1
20	76514040000	REAR LIGHT	1
24	76511078000	WIRING HARN. LIC. PLATE ILLUM.	1
25	75014047000	LICENSE PLATE ILLUMINATION 07	1
26	77411081000	REAR FLASHER WIR. HARNESS 12	1
28	0081250181	SCREW FOR PLASTIC 50X18 T20	1
29	0017060253	EJOT PT SCREW K60X25-Z SW=6	2
30	54814025200	FLASHER CPL. FR./S RE./S 09	2
31	54814026200	FLASHER CPL. FR./S RE./S 09	2
32	44111015100	BULB 12V 10W (BA15S)	4
33	0125100003	WASHER DIN0125-A10,5	4
34	0797100003	LOCK WASHER DIN6797-110,5 ZI	4
35	58414030000	HH COLLAR NUT M10X1,25 WS=13	4
36	54814028000	FLASHER LENS L/S R/S 05	4

127751410 / C127751410

* NEW PART

X AS REQUIRED



ACHTUNG !!!
Einbau von (10)
ohne Muttern.

CAUTION !!!
Mounting of (10)
without nuts.

FIG	PART NUMBER	DESCRIPTION	QTY
1	54814069000	SPEEDOMETER KM/H F. 21" 2005 REPROGRAMMABLE: KM/H - MPH	1
2	54814069010	BATTERY COVER F. SPEEDOM. 2005	1
3	58314068000	BATTERY F. SPEEDOM. M.A.E. 02	1
4	54814069020	SPEEDOMETER TOP PART 05	1
10	54814068100	CABLE FOR DIGITAL SPEEDOM. 06	1
11	55011022100	CLAMP D=6/8MM, BLACK	3
12	54814069050	MAGNET FOR DIGITAL SPEEDOM. 03	1
13	0471009104	CIRCLIP DIN0471 - 9X1 INOX	1
20	54814060000	SPEEDOMETER BRACKET 05	1
21*	0081645121	ELOT DELTA PT SCREW 45X12-Z	2
22	58214069051	RUBBER GROMMET 16X10,8X3 02	2
23	31008060000	RUBBER SLEEVE D=8MM OPEN	2
24	0024060256	HH COLLAR SCREW M6X25 TX30	2
25	58314060050	SPACER BUSH. F. SPEEDOMET. BRA.	2
26	78014033000	FLASHER BRACKET EXC. 08	1
30	58011021300	H-BEAM INDICATOR LIGHT BLUE'98	1
31	58011024300	FLASHER INDICAT. LIGHT GREEN'98	1
42	54813026000	CABLE SUPPORT 10/6MM 06	2
50	78003035000	STEERING HEAD LOCK 08	1

135031430 / C135031430

* NEW PART

X AS REQUIRED

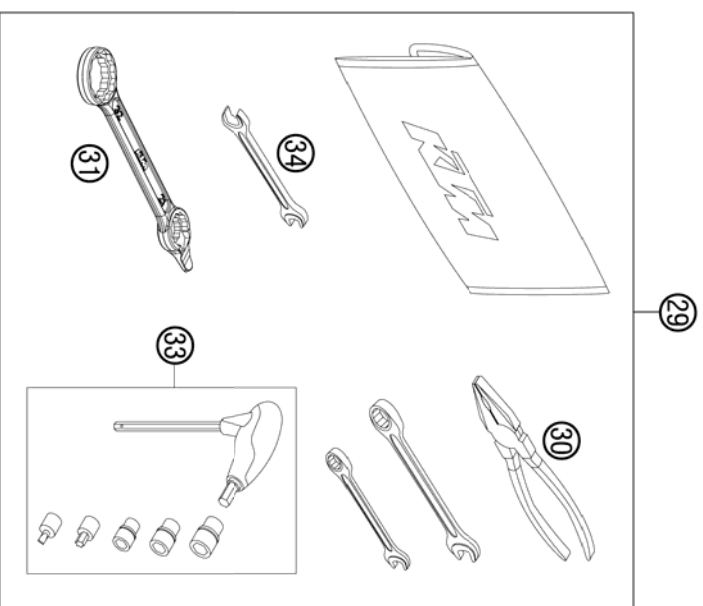

OHNE ABBILDUNG
WITHOUT ILLUSTRATION

TECHNISCHE DOKUMENTATION
TECHNICAL DOCUMENTATION
DOCUMENTACION TECNICA
DOCUMENTATION TECHNIQUE
NOTE TECHNICHE

FIG	PART NUMBER	DESCRIPTION	QTY
0	00062030019	AIR FILTER OIL 100ML	1
0	00063004202	PRINT LABEL 60X51 MM	2
0	0017060303	SPECIAL SCREW T60 6X30 WS=6	2
0	0019080206S	FLAT HEAD SCREW M. ISA45 M8X20	1
0	0024060106	HH COLLAR SCREW M6X10 TX30	1
0	0024060156	HH COLLAR SCREW M6X15 TX30	1
0	0081250181	SCREW FOR PLASTIC 50X18 T20	1
0	0084040223	CYL.HEAD SCREW DIN0084-M 4X22A	2
0	0125100003	WASHER DIN0125-A10,5	4
0	0797100003	LOCK WASHER DIN6797-110,5 ZI	4
0	0934040003	HEXAGON NUT DIN0934-M 4	2
0	13011070060	ADAPTER FOR FLASHER SWITCH '98	1
0	312305	DOCUMENTS BAG 2006	1
0	312313	KTM BALLPOINT PEN ORANGE	1
0	3210039	* CUSTOMER WELCOME LETTER	1
0	3212361DE/GB	PP OFFROAD FOLDER 2012	1
0	3212365GB	POWER WEAR TEASER 2012	1
0	49011435100	BULB 12V 5W (W2,1X9,5D) PHIL.	1
0	50033029013	FRONT SPROCKET 13-T	1
0	50302044000	CLAMP FOR MIRROR CPL. '09	1
0	50305012000	SWINGELEMENT FOR EXHAUST PIPE	1
0	50305107000	EXHAUST MANIFOLD	1
0	50311029000	FLASHER SWITCH CEV '98	1
0	58012140000	REAR MIRROR R/S	1
0	58412080000	REFLECTOR RED LCA '98	1
0	58414030000	HH COLLAR NUT M10X1,25 WS=13	4
0	75014047000	LICENSE PLATE ILLUMINATION 07	1
0	76511078000	WIRING HARN. LIC. PLATE ILLUM.	1
0	77202002144	BAR PAD CPL.	1
0	77203094000	PLASTIC FRAME PROTECTION SET	1
0	77411081000	REAR FLASHER WIR. HARNESS 12	1
0	78003040033	FOOTREST L/S + R/S CPL. 09	1
0	78014033000	FLASHER BRACKET EXC 08	1
0	7810297900004	HANDGUARDS CPL.LE+RI ORANGE 12	1
0	78108016050	NUMB.PLATE CARRIER BOTTOM	1

125482000 / C135032000

* NEW PART

X AS REQUIRED

FIG	PART NUMBER	DESCRIPTION	QTY
0	54603048100	RANGE CHANGE METAL NUT M6	1
0	54814025200	FLASHER CPL. FR./L/S RE./R/S	2
0	54814026200	FLASHER CPL. FR./R/S RE./L/S	2
0	58012040000	REAR MIRROR L/S	1
0	58012040150	CLAMP FOR MIRROR '94	1
1	3211861EN	OWNERS MAN.125-300 EXC/C-W 13	1
29	54829099100	TOOL KIT 2012	1
30	53012028200	GRIP ORANGE B&F	1
31	50329080100	WRENCH SW=17/21/27/32 B&F	1
33	60029070300	T-WRENCH WS=6/8/10/TX45/SK4X1	1
34	50329072000	SPOKE-SPANNER WS 7/10	1

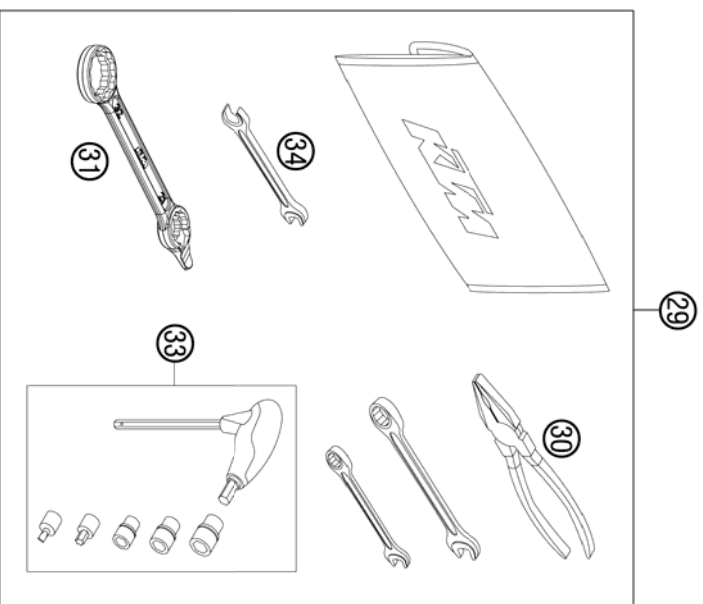

①
OHNE ABBILDUNG
WITHOUT ILLUSTRATION

①
TECHNISCHE DOKUMENTATION
TECHNICAL DOCUMENTATION
DOCUMENTACION TECNICA
DOCUMENTATION TECHNIQUE
NOTE TECHNICHE

125482000 / C135032000

* NEW PART

X AS REQUIRED

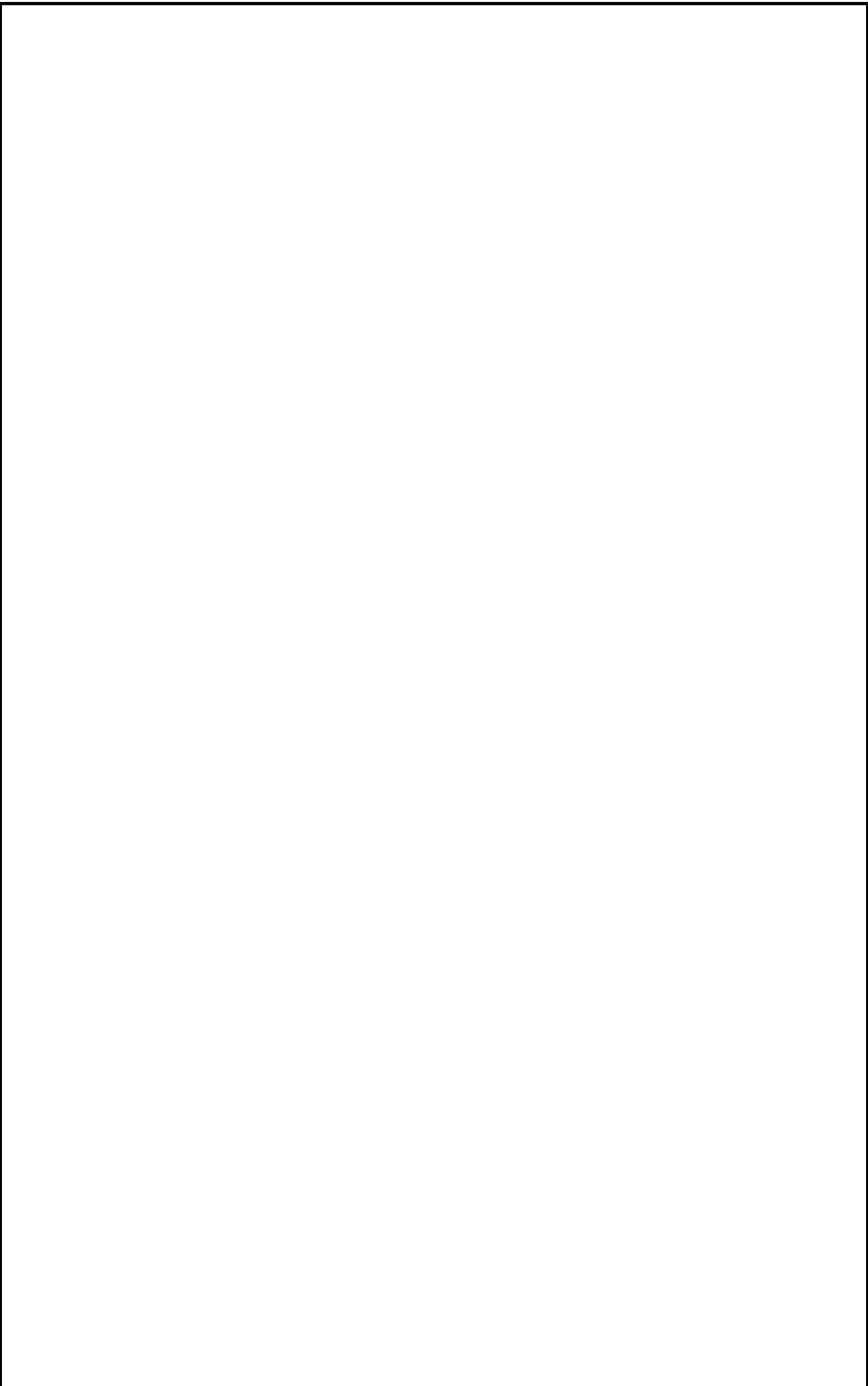



KTM-Sportmotorcycle AG
A-5230 Mattighofen
www.ktm.at

KTM Group Partner



3CFF7103M6EN



Art.Nr.: 3CFF7103M6EN 5/2012