

250 SX-F ADAMO EDITION 2025 2025

ART.-NR.: F8101Y6EN







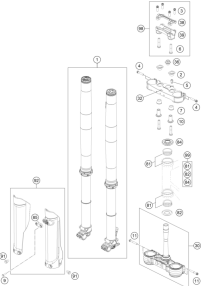
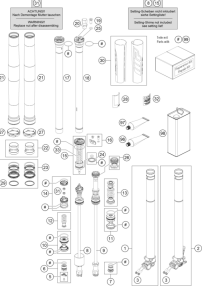
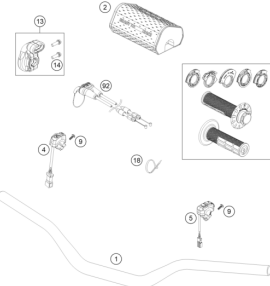
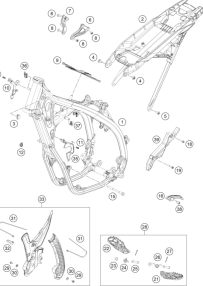
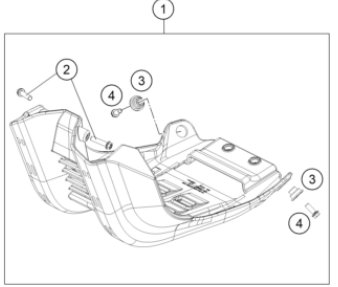
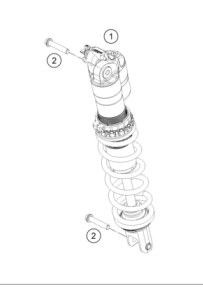
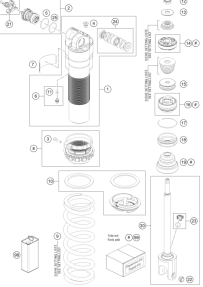
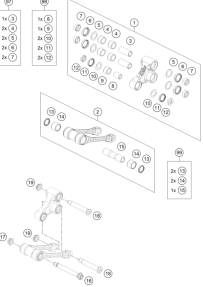
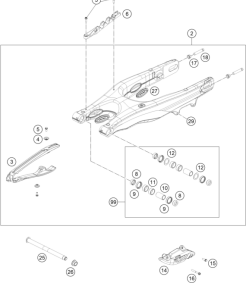
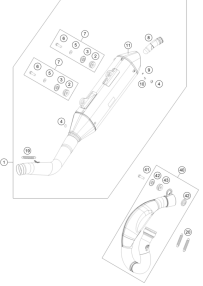
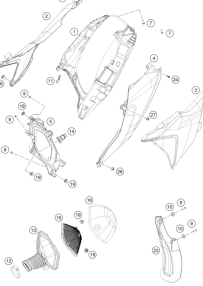
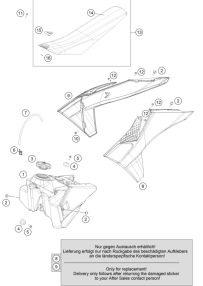

All information contained is without obligation. KTM Sportmotorcycle GmbH particularly reserves the right to modify any equipment, technical specifications, prices, colors, shapes, materials, services, service work, constructions, equipment and the like so as to adapt them to local conditions or to cancel any of the above items, all without previous announcement and without giving reasons. KTM may stop manufacturing certain models without previous notice. KTM shall not be held liable for any deviations of availability and/or ability to deliver, illustrations, descriptions, printing and/or other errors. The illustrated models partly contain extra equipment, which is not applied to standard models.

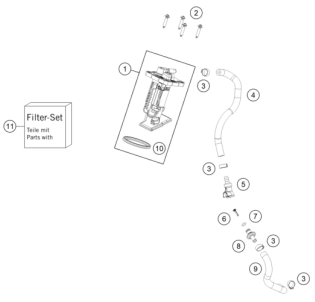
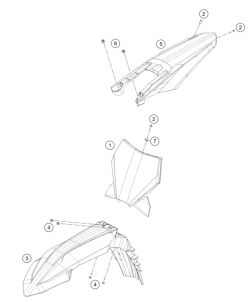
© by KTM Sportmotorcycle GmbH, Mattighofen AUSTRIA; All rights reserved; Reprint, also in extracts, with written allowance of KTM Sportmotorcycle GmbH, Mattighofen only.

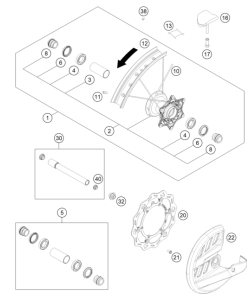
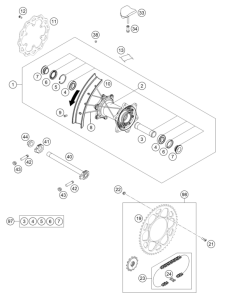
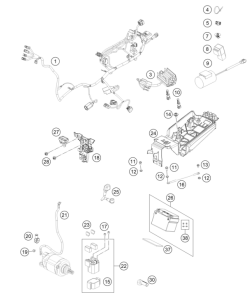
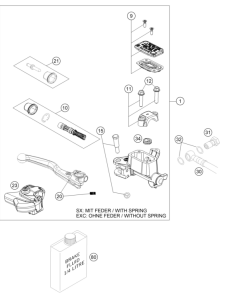
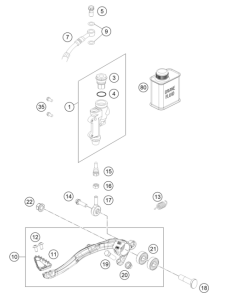
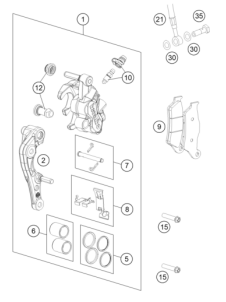
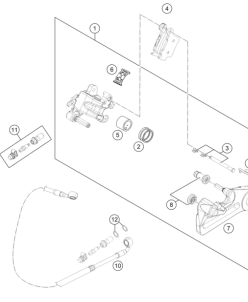
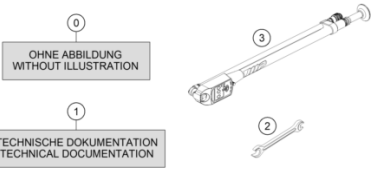
<p>FRONT FORK, TRIPLE CLAMP</p>  <p>3</p>	<p>FRONT FORK DISASSEMBLED</p>  <p>4</p>	<p>HANDLEBAR, CONTROLS</p>  <p>6</p>	<p>FRAME</p>  <p>7</p>
<p>ENGINE GUARD</p>  <p>8</p>	<p>SHOCK ABSORBER</p>  <p>9</p>	<p>SHOCK ABSORBER DISASSEMBLED</p>  <p>10</p>	<p>PRO LEVER LINKING</p>  <p>11</p>
<p>SWING ARM</p>  <p>12</p>	<p>EXHAUST SYSTEM</p>  <p>13</p>	<p>AIR FILTER</p>  <p>14</p>	<p>TANK, SEAT</p>  <p>15</p>

<p>FUEL PUMP</p>  <p>16</p>	<p>MASK, FENDERS</p>  <p>17</p>	<p>DECAL</p>  <p>18</p>	<p>FRONT WHEEL</p>  <p>19</p>
<p>REAR WHEEL</p>  <p>20</p>	<p>WIRING HARNESS</p>  <p>21</p>	<p>FRONT BRAKE CONTROL</p>  <p>22</p>	<p>REAR BRAKE CONTROL</p>  <p>23</p>
<p>FRONT BRAKE CALIPER</p>  <p>24</p>	<p>REAR BRAKE CALIPER</p>  <p>25</p>	<p>SEPERATE ENCLOSURE</p>  <p>26</p>	<p>WP SHIMS FOR SETTING</p>  <p>27</p>

FRONT FORK, TRIPLE CLAMP

250 SX-F ADAMO EDITION 2025 2025

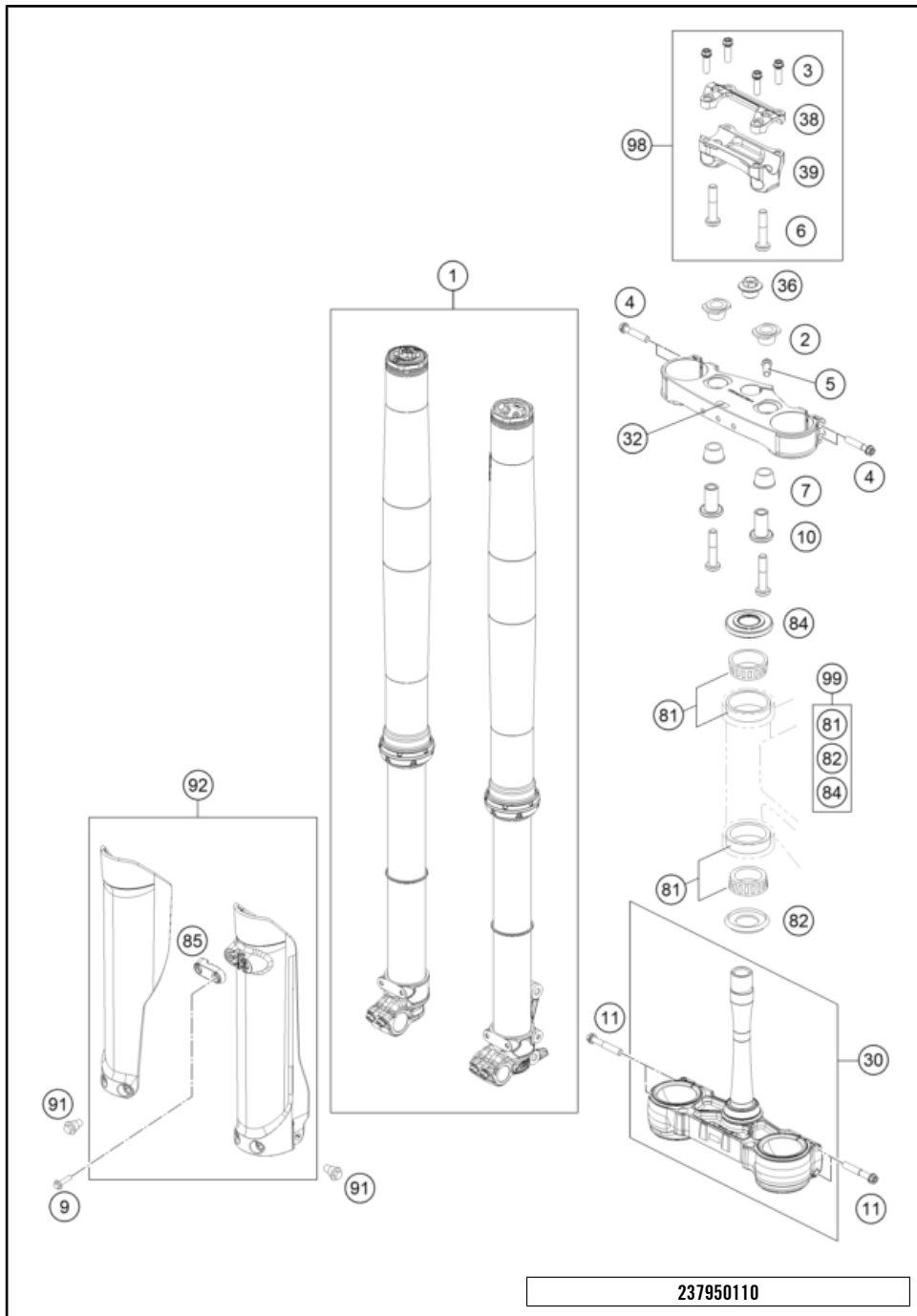

POS	PARTNUMBER		PIECE
1	SPNO	Nicht bestellbarer Artikel A460C155Y406000	1
2	A46001035001	Rubber bushing	2
3	0025080256	HH collar screw M8x25	4
4	0025080406	HH COLLAR SCREW M8X40 TX40	4
5	0015080256S	HH COLLAR SCREW M8X25 WS=10	1
6	0035100509S	AH-COLLAR SCREW M10X50 ISA45	2
7	83001040000	RUBBER BUSH	2
9	0017060206	SCREW F. PLASTIC K60X20AL SW6	2
10	A46001039034	HANDLEBAR SUPPORT LOWER PART	2
11	0025080506	HH collar screw M8x50 TX40	4
30	A46001132022C1	Bottom triple clamp, cmpl. X=22mm	1
32	A46001134022C1	Triple clamp top X=22mm	1
36	A46009082000	Collar screw M20x1.5 SW17 Al	1
38	79001038000	HANDLEBAR CLAMP 28MM	1
39	A48001039036	Handlebar mount D28 mm-H36 mm	1
81	54201081100	TAPERED ROLLER BEARING CPL. 06	2
82	77701084000	O-RING SUPPORT W. SEALING LIP	1
84	A46001086000	Steering head seal	1
85	77701085100EB	CLAMP FOR BRAKEHOSE	1
91	59001092050	SPECIAL SCREW M6X12,5 WS=8	6
92	A46001094000EBK	Fork protection kit Adamo Edition MY 25 with decal	1
98	A48001039010	handlebar mount kit D28mm-H36mm	x
99	A46001081044	Repair Kit steering head bearing	x

237950110

70574

* NEW PART X ON DEMAND

FRONT FORK DISASSEMBLED

250 SX-F ADAMO EDITION 2025 2025

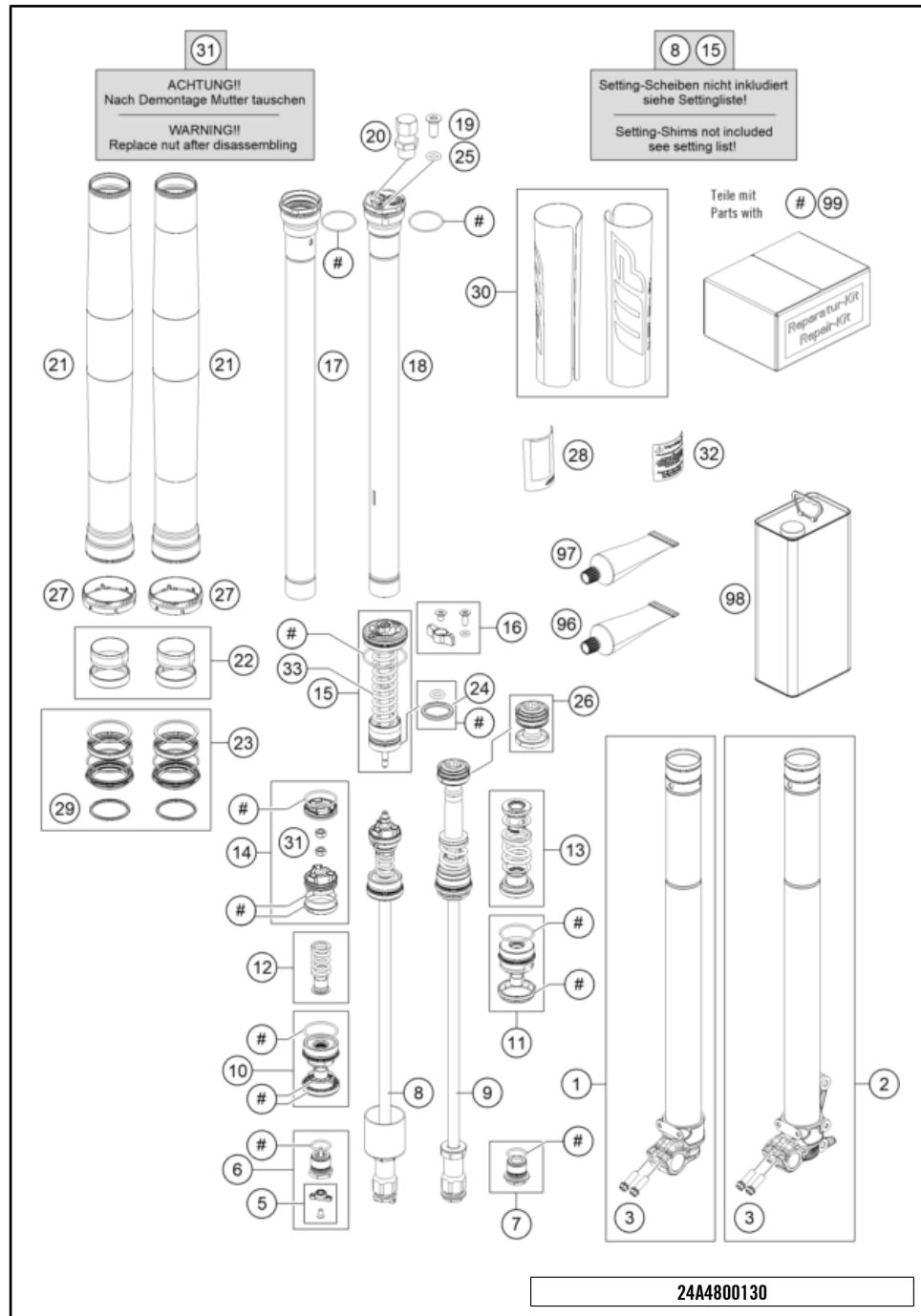

POS	PARTNUMBER	PIECE	
1	48602046S2	Axle clamp ri. with inner tube cpl.	1
2	48602045S2	Axle clamp le. with inner tube cpl.	1
3	0025080256	HH collar screw M8x25	4
5	RP10033T	Repair kit adjuster rebound red	x
6	48602052S	adjuster housing M20x1 cpl.	1
7	48601533S	HH collar screw M20x1x18 cpl.	1
8	S501200016S0000	Kolbenstange D12 M9x1 L385 kpl.	1
9	48601501S2	piston rod 12x470 cpl.	1
10	48601462S2	Screw sleeve M35,5 x 0.8 cpl.	1
11	48602138S2	Screw sleeve M35,5x0,8 cpl.	1
12	48600578S	Spring (13,9) 37-32 rebound cpl.	1
13	48601820S	Spring (22) 60-30 rebound cpl.	1
14	RP10035T	Repair kit piston air fork	x
15	48602049S5	Basevalve cpl.	1
16	RP10029T	adjuster kit screw cap compression	x
17	S409100014S0000	Schraubdeckel M51x1,5 kpl.	1
18	S409100015S0000	Schraubdeckel M51x1,5 kpl.	1
19	00700007	ISA countersunk head screw M4x8 acc draw	1
20	48601494S	VALVE M8X1 INCL. SCREW CAP	1
21	48602096	fork outer tube 49.13x577 dt54 db60	2
22	R14047T	Guide bushing set fork 48mm	x
23	RP10012T	"Seal kit 48mm SKF black"	x
24	04100002	X-ring 26,57x3,53 FKM80	1
25	50180222	O-ring 4x1,5 NBR70	1
26	48602135S	Piston 33,6x35,4 cpl.	1
27	S639200001000FA	Fork protection ring 59,8mm	2
28	52000361	Model sticker	1
29	48602007	Stroke indicator 48mm red	2
30	52000235SET	Sticker set XACT 5 AER CC 182.5x238	1
31	48602128	Nut M6 h5,4 SW10	2
32	52000328	Sticker warning 40x40	1
33	48601727	Spring (19,5) 8-114 optional part	x
33	48601588	Spring (19,5) 12-114 optional part	x
33	48602157	Spring (19,5) 14-114 optional part	x
33	48601258	Spring (19,5) 16-114	1
33	48601851	Spring (19,5) 18-114 reservoir	x

24A4800130

69023

* NEW PART

X ON DEMAND

FRONT FORK DISASSEMBLED

250 SX-F ADAMO EDITION 2025 2025

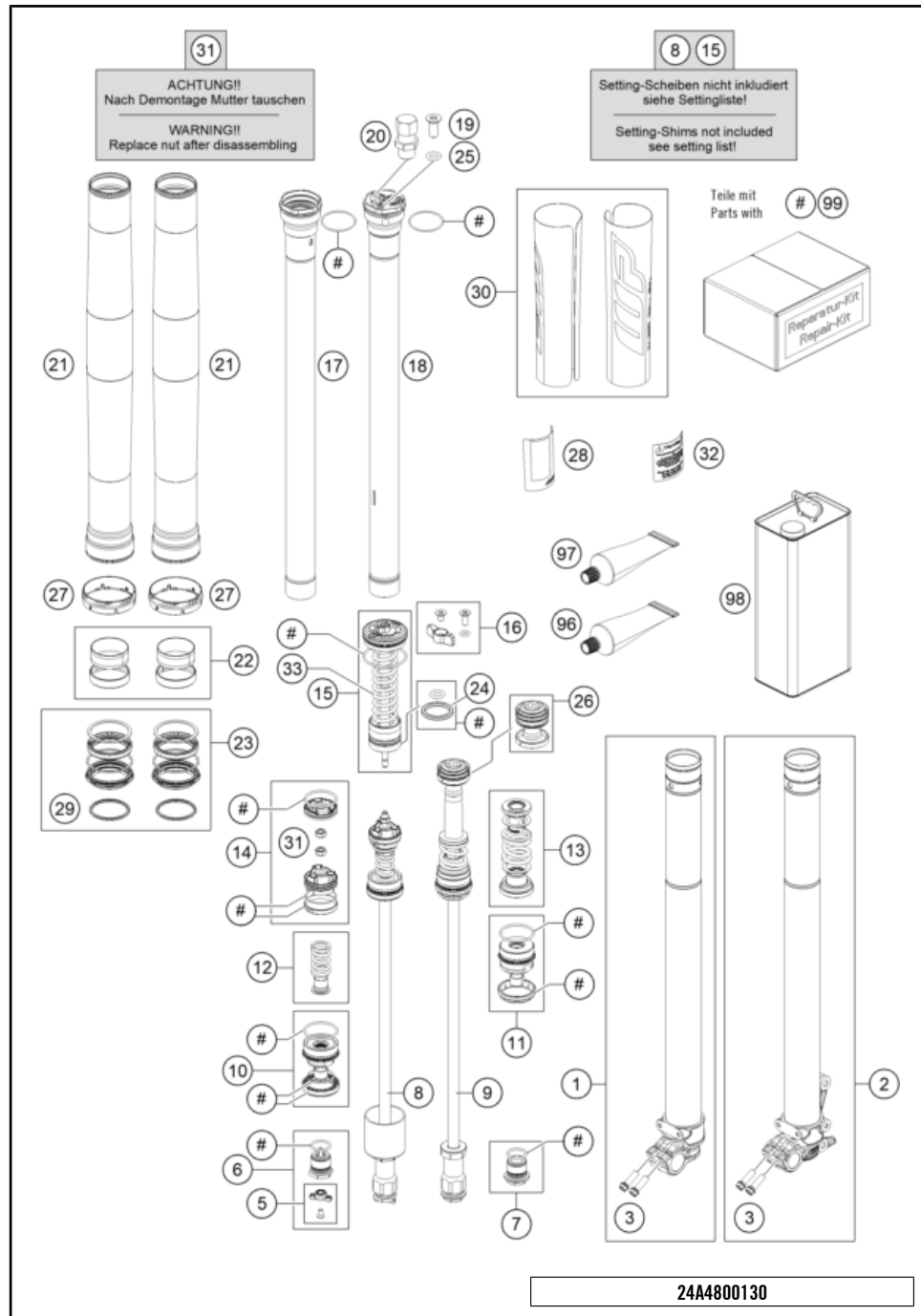

POS	PARTNUMBER	optional part	PIECE
33	48601749	Spring (19,5) 20-114 optional part	X
96	T14034	Fuchs grease IPR (250g)	X
97	00062010053	special grease AER Fork 400g	X
98	48601166S1	Fork Fluid Viscosity 4.0 5L	X
99	RP10042T	Gasket kit air fork	X

69023

* NEW PART

X ON DEMAND

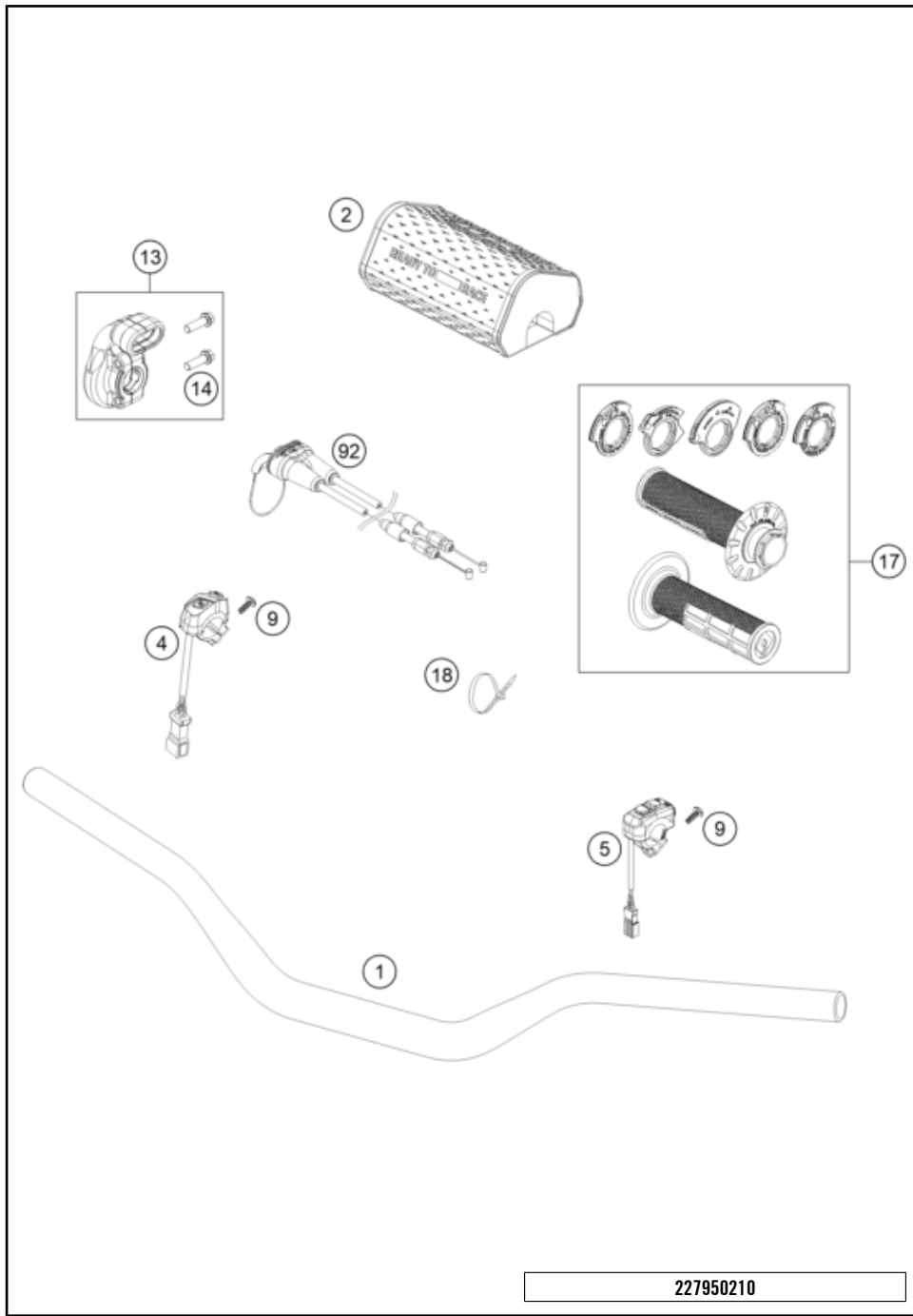

POS	PARTNUMBER		PIECE
1	7900200100030	HANDLEBAR D=28MM	1
2	A46002002044C1A	Handlebar pad compl.	1
4	A46011074000	Start/stop button	1
5	A46039074000	Combination switch	1
9	0081050181	SCREW FOR PLASTIC K50X18 T20	2
13	A46002010025	Housing throttle twist grip cpl.	1
14	0025060206	HH collar screw M6x20 TX30	2
17	A46002921000BJ	Lock-on grip set	1
18	44011076200	CABLE TIE 200/3,6MM BLACK	x
18	44011076140	CABLE TIE 140/2,5MM BLACK	x
92	A46002091000	Throttle cable complete 4 stroke	1

227950210

58206

* NEW PART

X ON DEMAND

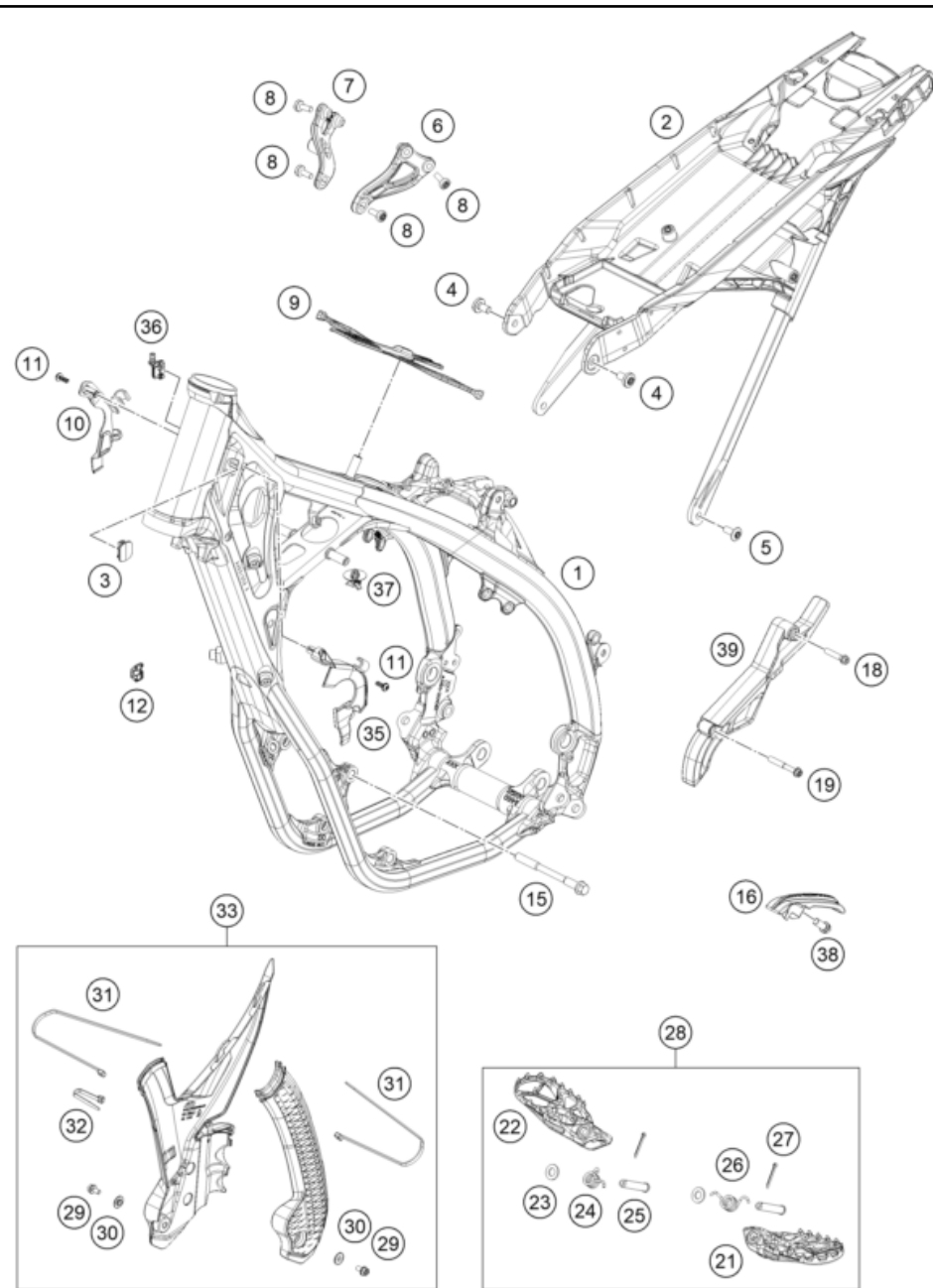

POS	PARTNUMBER	PIECE
1	A46003001200EB	Frame
2	A46003002000	Subframe
3	79111013010	Cover control head sheet
4	09000008016U0	Special screw M8x16 ISA45 self-locking
5	79003003000	SPECIAL SCREW M8X18 TORX45 SS
6	A46003013100C1	Engine brace left
7	A46003014100C1	Engine brace right
8	0035080206S	SHCS M8x20 TX45
9	A46007012100	Fuel tank rubber
10	A46003099020	Cable bracket/throttle cable guide
11	0081050141	EJOT PT screw K50x14
12	A49003099030	Cable protection
15	59003013000	ENGINEBRAC.SCREW M10X123 WS=13
16	A46003053000	Chain slider below
18	0025080206	HH collar screw M8x20
19	0025060456	HH COLLAR SCREW M6X45 TX30
21	A46003040000	Foot grid left
22	A46003041000	Foot peg right
23	0125100003	washer DIN 125 A 10.5
24	A46003045000	Footrest spring right
25	54803044000	PIN FOR FOOT PED 51.5X9.8 MM
26	A46003044000	Footrest spring left
27	0094032253	PIN DIN0094-3,2X25 STEEL
28	A46003037033	Footpeg set
29	0025050106	HH collar screw M5x10 TX30
30	54803092060	BUSH F. FRAME PROTECTION 03
31	44011076305	CABLE TIE 300/4,8MM BLACK
32	44011176140	cable tie 140/ 3,5 mm Schwarz
33	A46003994000EB1	Factory Racing frame protection set
35	A46003099010	Cable bracket
36	79107013010	wire holder / fuel ventilation
37	79711013010	Cable bracket d8
38	0025080206	HH collar screw M8x20
39	A46003096000	Front sprocket cover

24A4600310

69018

* NEW PART X ON DEMAND

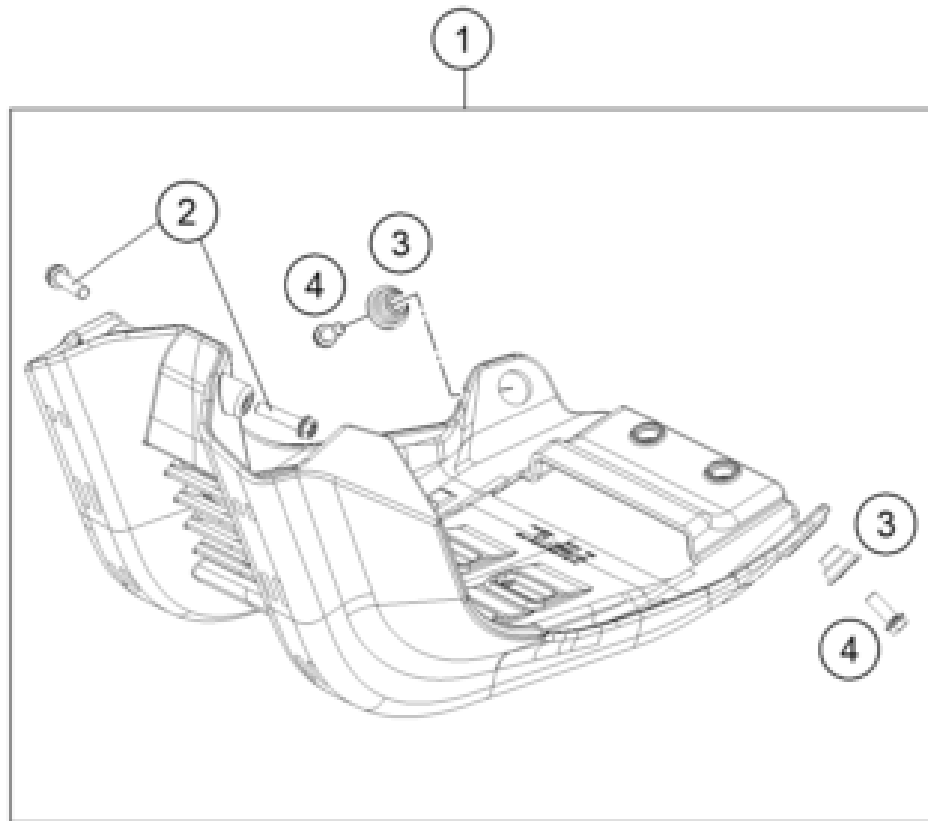

POS	PARTNUMBER		PIECE
1	A46003990044	Factory skid plate	1
2	0025060256	HH collar screw M6x25 TX30	2
3	A46003090030	bushing skid plate	2
4	0025060166	HH collar screw M6x16 TX30	2

227950330

62224

* NEW PART

X ON DEMAND

SHOCK ABSORBER

250 SX-F ADAMO EDITION 2025 2025

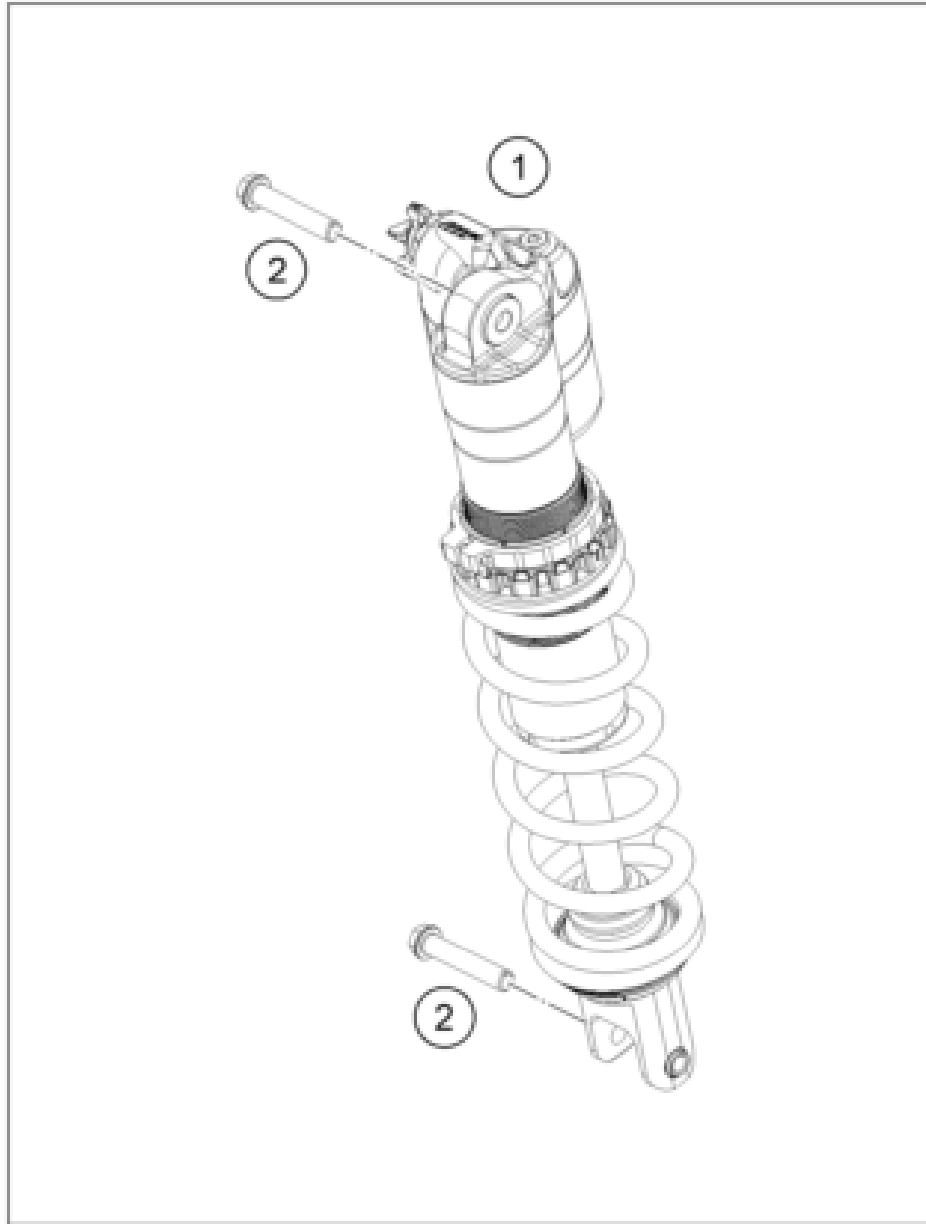

POS	PARTNUMBER		PIECE
1	SPNO	Nicht bestellbarer Artikel A460C455Y408000	1
2	77204089000	HH COLLAR SCREW M10X52 SW13	2

25A4600410

69048

* NEW PART

X ON DEMAND

SHOCK ABSORBER DISASSEMBLED

250 SX-F ADAMO EDITION 2025 2025

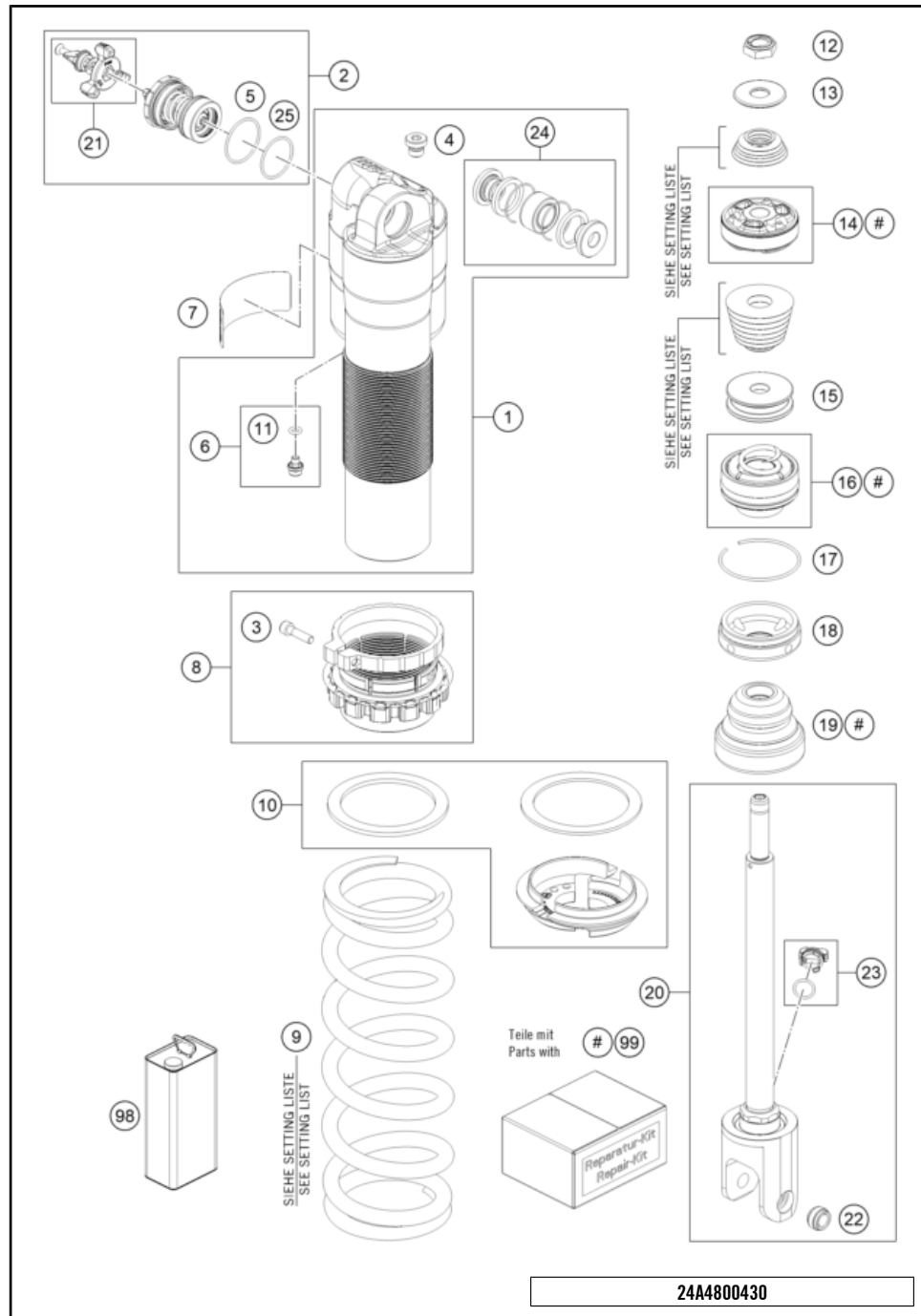

POS	PARTNUMBER	PIECE
1	S455000003S0100	Monoshock case M51x1 h19 with pipe cpl. 1
2	S012900000S2100	Druckstufe kpl. 1
3	14460042	HS cylinder-head screw M5x20 DIN 912 1
4	50180095	HS cylinder-head screw R1/8 I8 1
5	50180217	O-ring 27x1,5 Viton70 green ISO 3601-3S 1
6	36120151S1	screw fill M5x6 cpl. 1
7	52000312	Sticker XACT LDS 80x29 1
8	S938100001S0000	SPRING SUPPORT 1
9	91210130	mainspring (62/65) 36-240 muffle white x
9	91210131	mainspring (62/65) 39-240 muffle white x
9	91210132	mainspring (62/65) 42-240 muffle white x
9	91210133	mainspring (62/65) 45-240 muffle white x
9	91210134	mainspring (62/65) 48-240 muffle white x
9	91210135	mainspring (62/65) 51-245 muffle white x
9	91210136	Mainspring (62) 54-250.0 shock white x
10	S828800000S01BQ	Spring seat 26,5x76,5x22,3 cpl. 1
11	S208600003000FB	O-ring 5,28x1,78 HNBR70 red 1
12	50181207	Locking nut M12x1 h9 WAF19 1
13	50181344	Rebound disc 12x34x3,5 h0 1
14	S625000000S0000	Piston 12x49,4x18 cpl 1
15	50181091	Rebound disc 12x43x12,5 h8 1
16	50180603S7	Dichtungsträger 50x28 cpl. 1
17	50180126	Round-wire snap ring 53x1,75 1
18	50181349	Cap 50,12x16 h6 1
19	50181100	Rubber pad 18x58x46 black 1
20	S421800010S0100	Mounting fork with piston rod cpl. Link 1
21	RP10044T	Repair kit adjuster DCC 2023 x
22	46811205	Bush M10x12/15/13x9,5 1
23	S918100006S0000	adjuster rebound red cpl. 1
24	R15006	REPAIR KIT BEARINGS 07 x
25	50180218	O-ring 25x1,5 Viton70 1
98	50180751S1	SHOCK ABSORBER FLUID 5 LT x
99	RP10043T	shock absorber rebuild kit x

24A4800430

68985

* NEW PART

X ON DEMAND

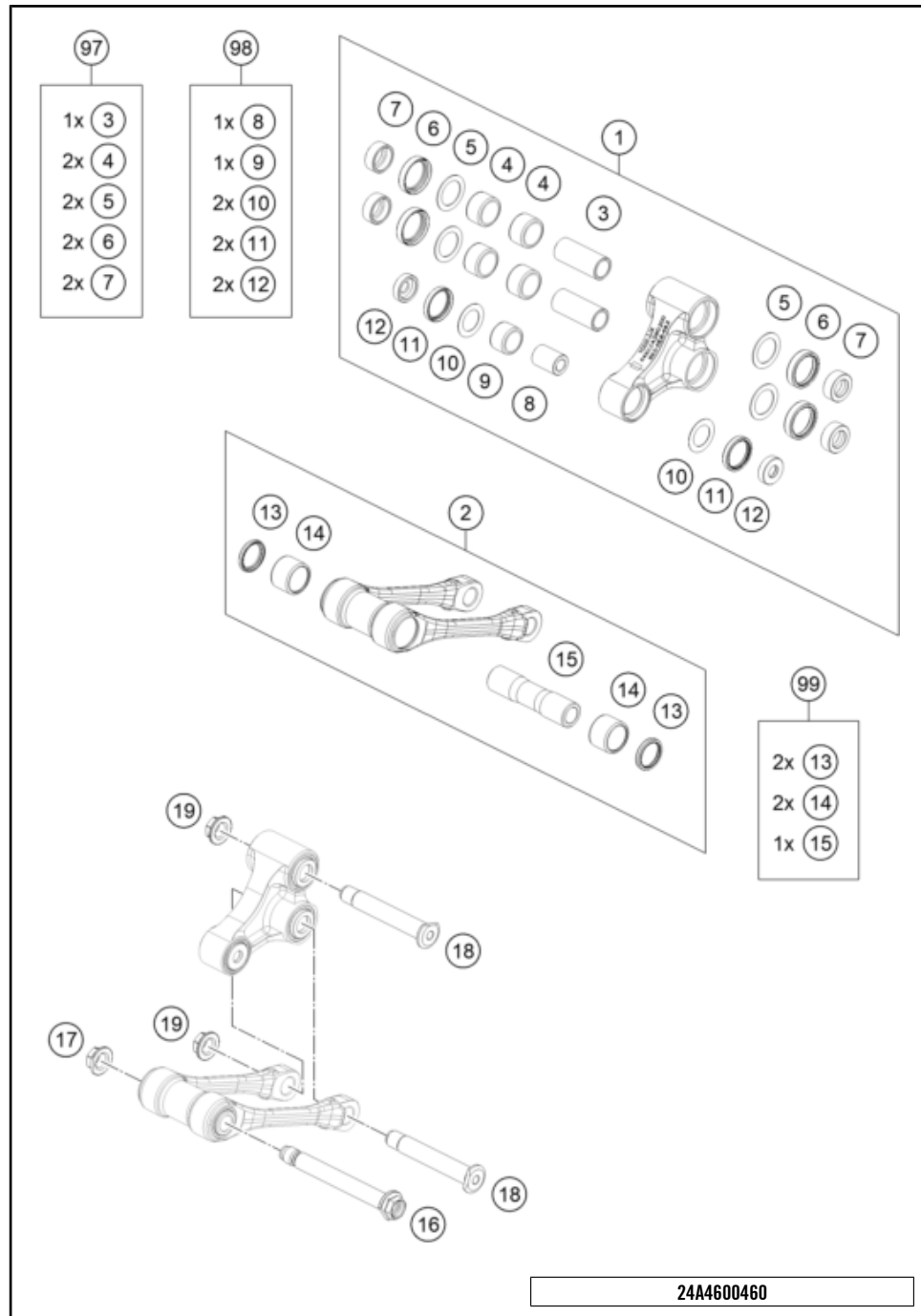

POS	PARTNUMBER		PIECE
1	A46004080244	Triangle cantilever compl.	1
2	A46004083244	Pull rod compl.	1
3	54603081000	BUSHING SLEEVE 15 X 20 X 48	2
4	54603097000	NEEDLE BUSH HK 2016	4
5	54603036000	STOP DISK 22,2X31,7X1	4
6	0760253271	Radial shaft seal 25x32x7	4
7	77204080130	BUCKET SHAFT SEAL RING 25X11	4
8	77204080010	BEARING SLEEVE 10X18X25,5	1
9	0618182416	NEEDLE BUSH HN1816 RS 18/24/16	1
10	50180604	Shim 29,75x19x0,4	2
11	0760243051	Radial shaft seal 24x30x5	2
12	77204080020	BUCKET FOR SHAFT SEAL RING	2
13	0760222842	Rotary shaft seal G22x28x4	2
14	0618222820	NEEDLE BEARING HK2220 22X28X20	2
15	79004084010	BEARING SLEEVE F. TIE-ROD 16	1
16	A48004084000	Pin pull rod M16x1.5	1
17	77404084120	HEX NUT M14X1.5 SW17	1
18	A48004085000	Triangle cantilever pin M14x1.5	2
19	77204087000	hex nut M14x1.5 WS17	2
97	A46004180020	Repair kit triangle lever	x
98	A46004180010	Repair kit triangle lever	x
99	A46004183010	Repair kit pull rod	x

24A4600460

69015

* NEW PART

X ON DEMAND

SWING ARM

250 SX-F ADAMO EDITION 2025 2025

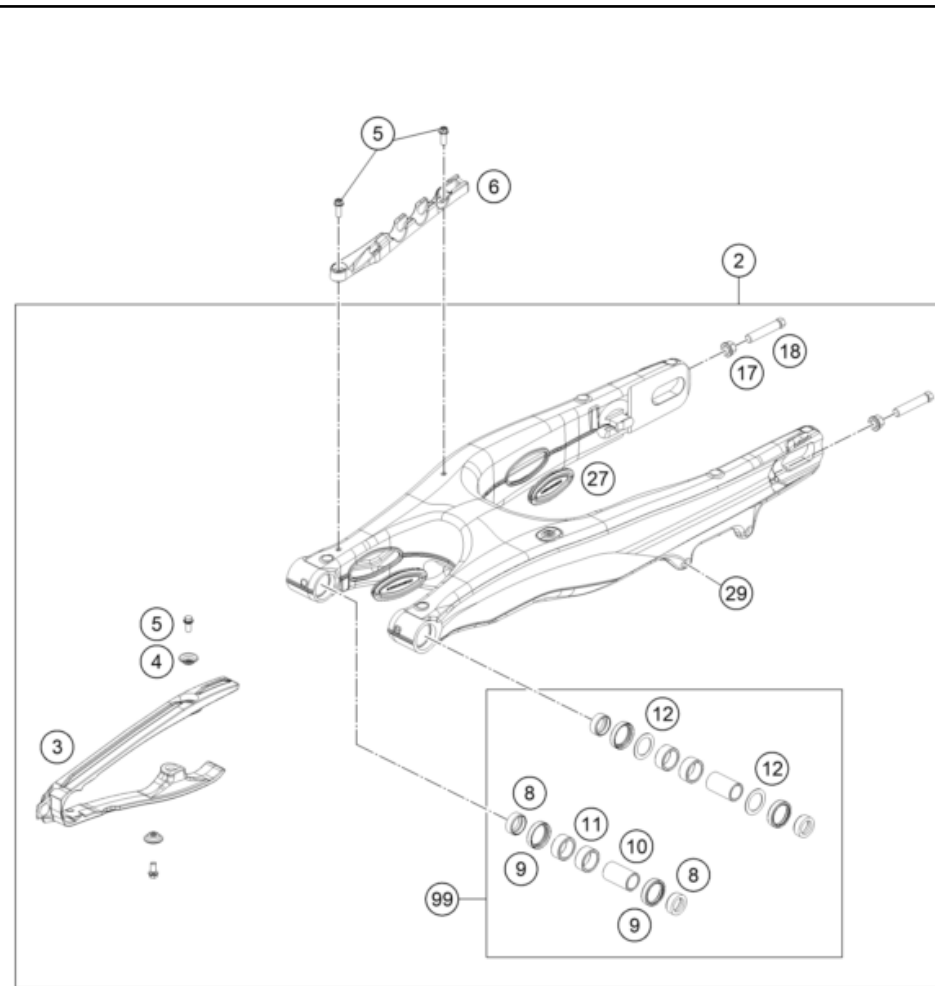

POS	PARTNUMBER		PIECE
2	A46004230144	Swingarm cpl	1
3	A46004066100	Chain slider	1
4	77304066150	Chain slider bushing	2
5	0025060166S	HH collar screw M6x16 TX30 SL	4
6	A46004042000	Brake line guide	1
8	77704034000	SUPPORT F. SHAFT SEAL RING 16	4
9	0760253270	radial shaft seal 25x32x7	4
10	59404032000	BEARING SLEEVE 17X22X38,7 03	2
11	0618222812	NEEDLEBEAR HK2212V 22/28/12 MB	4
12	54603036000	STOP DISK 22,2X31,7X1	2
14	A46004070000	Chainguide SX	1
15	59009062016	SPECIAL SCREW M6X16 WS=8 10.9	1
16	0025060456	HH COLLAR SCREW M6X45 TX30	1
17	58414030000	HH COLLAR NUT M10X1,25 WS=13	2
18	50304040100	screw M10x1.25x50 WS10	2
25	A46004037000	Swingarm pivot	1
26	54804038000	Nut with flange M16X1,5 WS=19 03	1
27	A46004041000	Locking cap swingarm	4
29	54603055051	PRESS IN NUT M6 STEEL ZINC	1
99	79004030110	Repair kit swingarm bearing	x

232620490

69011

* NEW PART

X ON DEMAND

EXHAUST SYSTEM

250 SX-F ADAMO EDITION 2025 2025

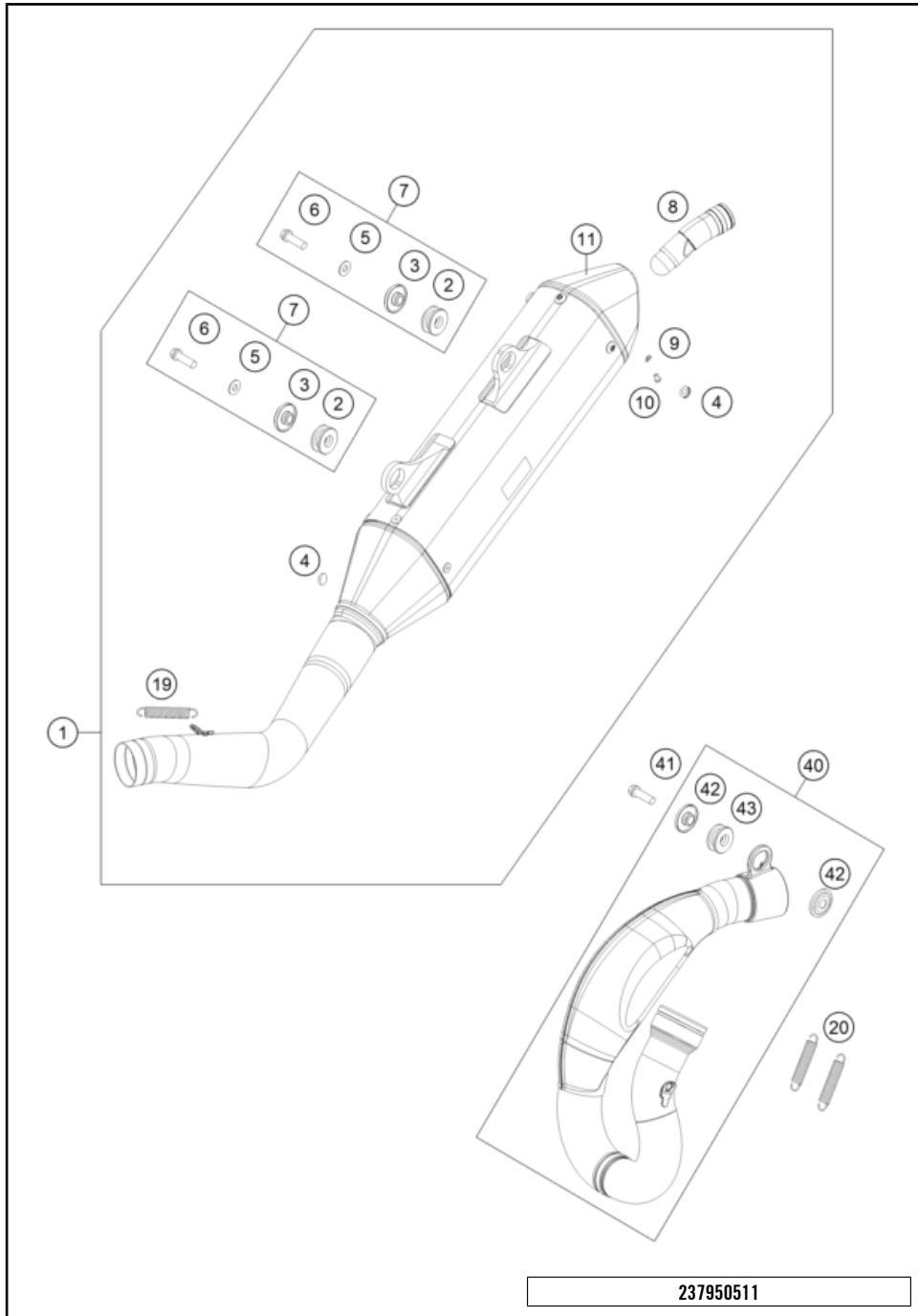

POS	PARTNUMBER		PIECE
1	A46005979000	Akrapovic Slip-on Line	1
2	77205068000	DAMP. COMPON. BLACK	2
3	77205169000	BUSHING 7.5x12x28x8.3 11	2
4	76505099050	RUBBER CAP	2
5	50233041000	PAIR OF WASHERS M 6 NORDLOCK	2
6	0025060306	HH collar screw M6x30 TX30	2
7	A48005979060	Manifold assembly kit	2
8	A48005989030	Noise reduction insert	1
9	79405062030	WASHER	1
10	79405062020	BOLT	1
11	A48005979050	Silencer cap	1
19	57305989100	Exhaust spring	1
20	50305016200	Tension spring L=65 mm	2
40	A46005007033	Header KTM 250 SXF	1
41	0025080256	HH collar screw M8x25	1
42	77805069000	BUSHING 8.5x12x28x8.3	2
43	79105068000	Damper gray	1

237950511

62278

* NEW PART

X ON DEMAND

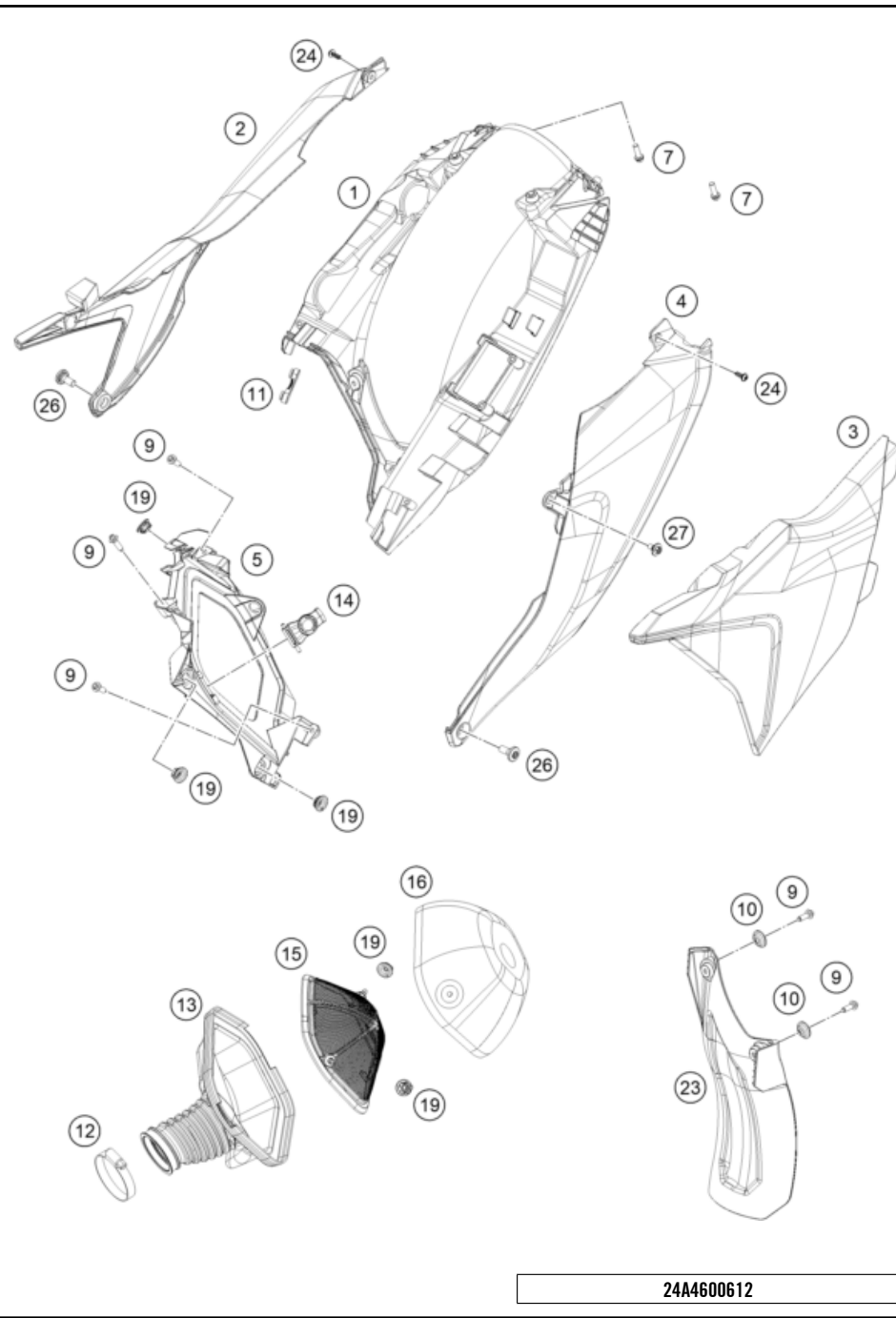

POS	PARTNUMBER		PIECE
1	A46006001000EB	Lower section of the air filter	1
2	A46006004000ABD	Air filter box lid right with decal	1
3	A46006003000ABF	Air filter box cover with decal	1
4	A46006005000ABD	Air filter box lid left with decal	1
5	A46006001010EB	Air filter box front part	1
7	0025060206	HH collar screw M6x20 TX30	2
9	0017060206	SCREW F. PLASTIC K60X20AL SW6	5
10	77304066150	Chain slider bushing	2
11	79105098000	exhaust spacer	1
12	78006027000	HOSE CLAMP 45-65MM	1
13	A46006026100	Air boot	1
14	A46006017000	Air filter holding bracket	1
15	A46006016000	Air filter support	1
16	A46006015000	Air filter	1
19	47106003160	quick release rubber grommet	5
23	A46004050000	Splash protection	1
24	0081050141	EJOT PT screw K50x14	2
26	79003003000	SPECIAL SCREW M8X18 TORX45 SS	2
27	83008000012	special screw M6x12x3	1

24A4600612

70580

* NEW PART

X ON DEMAND

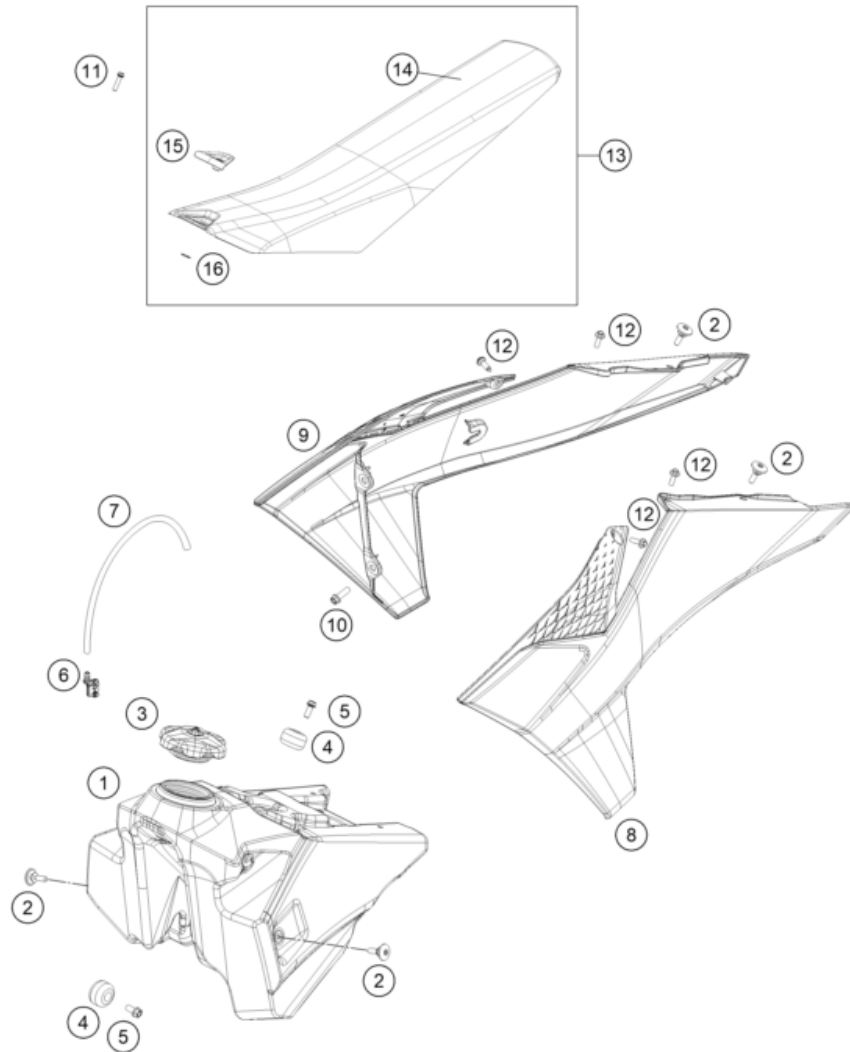

8 Nur gegen Austausch erhältlich!
 Lieferung erfolgt nur nach Rückgabe des beschädigten Aufklebers
 an die länderspezifische Kontaktperson!

9 Only for replacement!
 Delivery only follows after returning the damaged sticker
 to your After Sales contact person!

POS	PARTNUMBER		PIECE
1	A46007113000	Fuel tank	1
2	79107011000	Seat holder screw	4
3	77707008144C1	Fuel tank cap	1
4	A46007014000	Fuel tank role	3
5	0026060136	COLLAR SCREW M6X13 ISA30	3
6	79107013010	wire holder / fuel ventilation	1
7	78007000270	PVC-HOSE 5,6X10X270MM	1
8	A46008050100EBC	Spoiler left with decal	1
9	A46008051100EBC	Spoiler right with decal	1
10	0025060126	HH collar screw M6x12 TX30	4
11	0025060256	HH collar screw M6x25 TX30	1
12	0017060205	SCREW FOR PLASTIC K60X20 SW6	4
13	A46007040000EBA	Factory seat	1
14	A46007040050EBA	Seat cover	1
15	A46007046000	Seat installation	1
16	0004711200100	Lock ring DIN471 12x1	1

227950710

70581

* NEW PART

X ON DEMAND

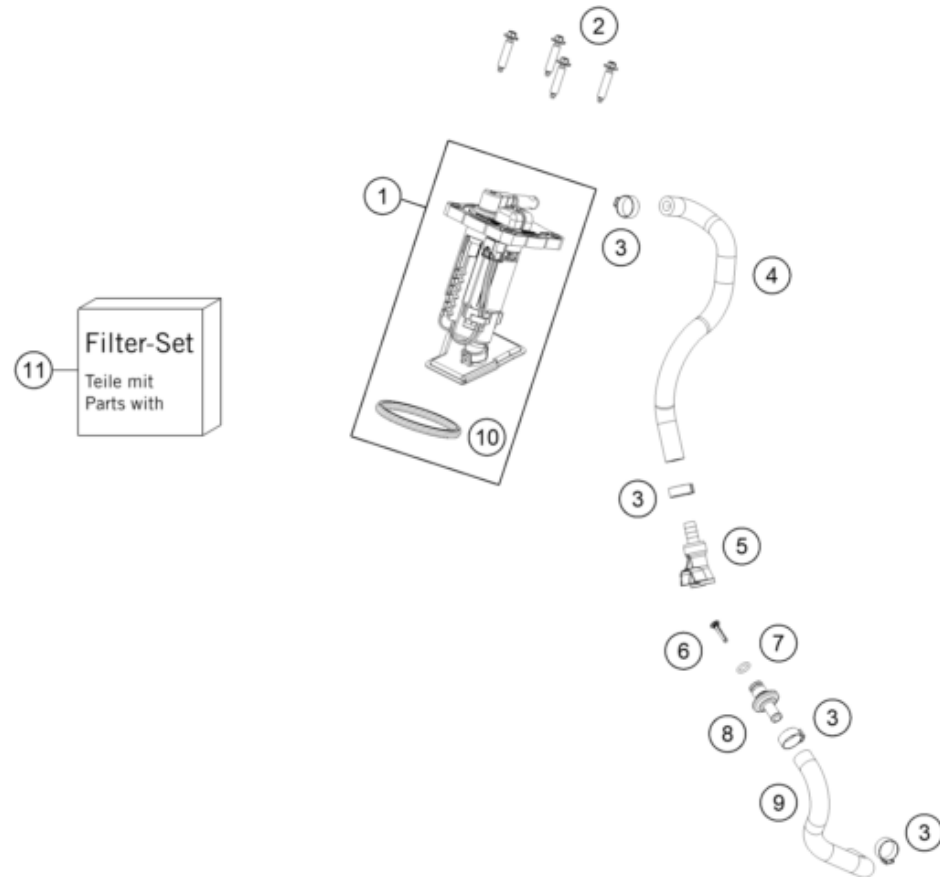

POS	PARTNUMBER		PIECE
1	A46007088200	Fuel pump	1
2	0017060305	SPECIAL SCREW K60X30 WS=6	4
3	00050157706	VARIABLE ONE-EAR CLAMP 15,7MM	4
4	A46007016000	Fuel hose DKK	1
5	5850701050030	CLUTCH CPC BLACK 05	1
6	78141013190	FUEL FILTER	1
7	58507012000	O-RING VITON F. PLUG CPC 05	1
8	77707010000	CONNECTOR FUEL PUMP	1
9	A46007017000	Fuel hose	1
10	A46007088050	Fuel pump seal	1
11	A46007018044	Fuel pump filter kit	1

227950730

62219

* NEW PART

X ON DEMAND

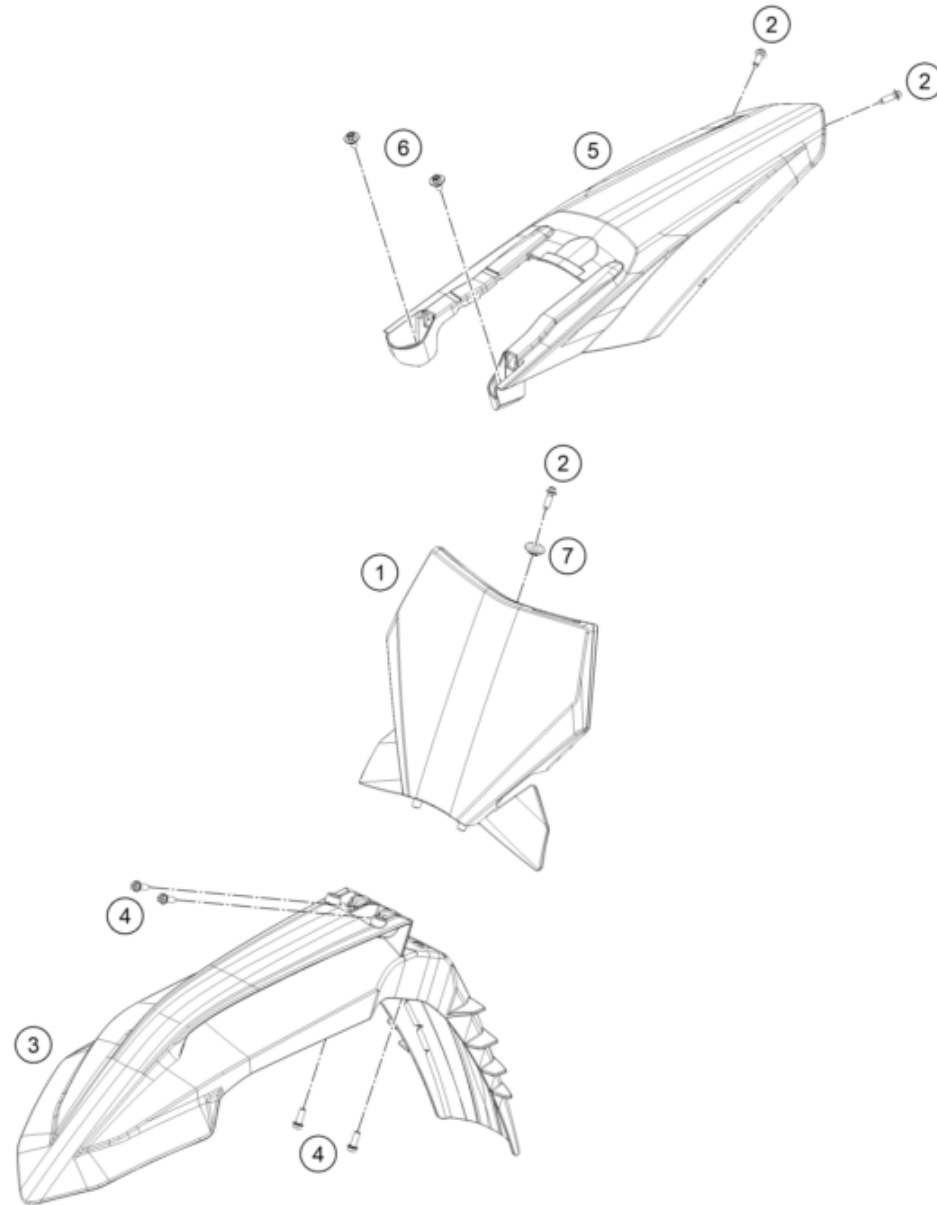

POS	PARTNUMBER		PIECE
1	A46008007000EBG	Number plate	1
2	0017060206	SCREW F. PLASTIC K60X20AL SW6	3
3	A46008010100EB	Front fender	1
4	0025060166	HH collar screw M6x16 TX30	4
5	A46008013000EBF	rear fender with decal	1
6	83008000012	special screw M6x12x3	2
7	79608052000	BUSH 6X11X16X5 MM	1

237950810

70578

* NEW PART

X ON DEMAND

1



2



Nur gegen Austausch erhältlich!
 Lieferung erfolgt nur nach Rückgabe des beschädigten Aufklebers
 an die länderspezifische Kontaktperson!

Only for replacement!
 Delivery only follows after returning the damaged sticker
 to your After Sales contact person!

POS	PARTNUMBER		PIECE
1	A46008092900	Accessory pack 250	1
2	A46008093100	Decal	1

25A4600831

70583

* NEW PART

X ON DEMAND

FRONT WHEEL

250 SX-F ADAMO EDITION 2025 2025

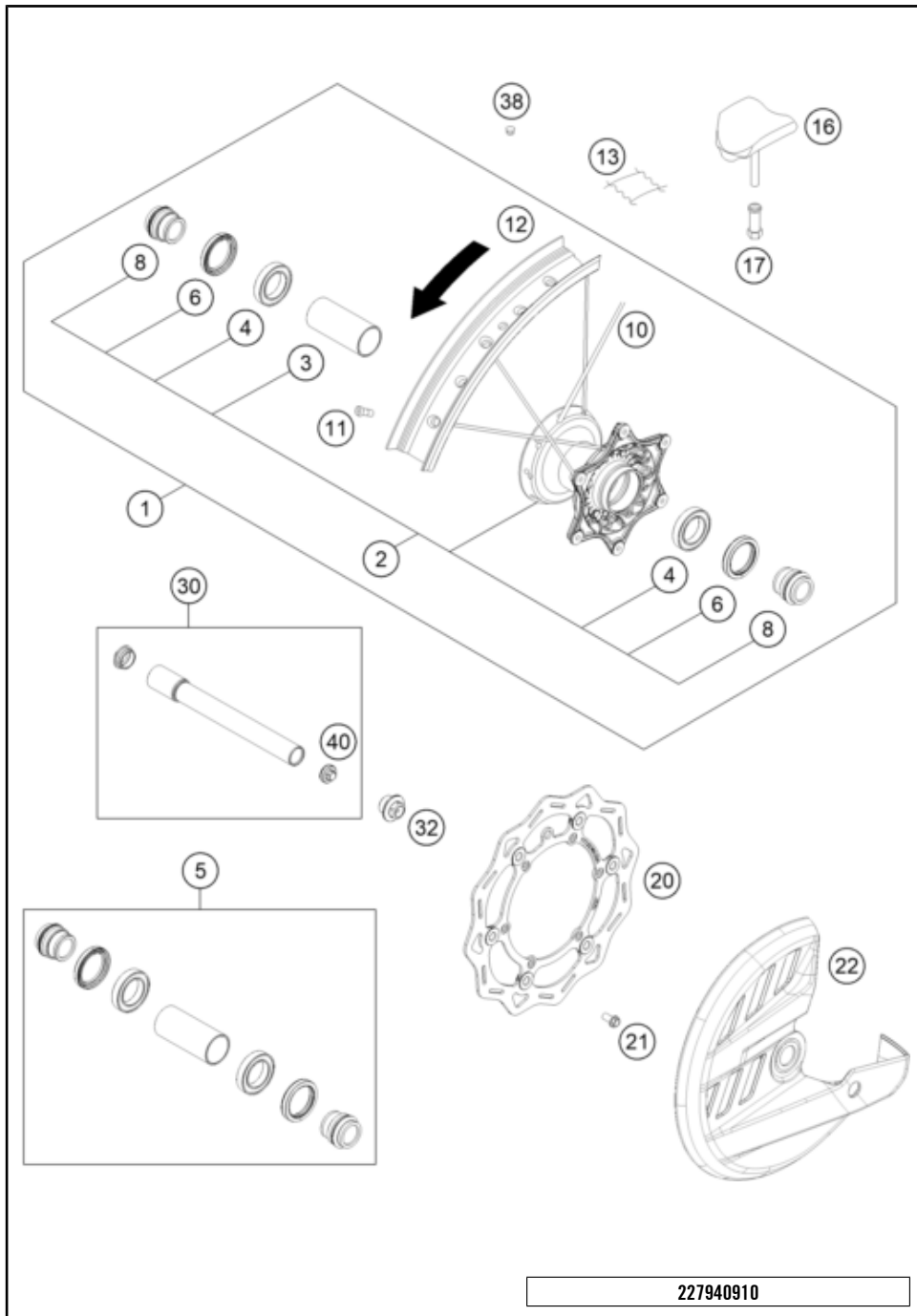

POS	PARTNUMBER		PIECE
1	A4600990104404	Factory front wheel 1.6x21"	1
2	7900991004404	Front wheel hub cpl.	1
3	54809011000	BEA.SPACERTUBE 35X2 L=79,4 03	1
4	0625069068	GR.BALL BEAR.6906 DDU2CG23S6NM	2
5	77709015000	wheel bearing repair kit	1
6	0760354771	SHAFT SEAL RING 35X47X7 TC	2
8	77709012000	SPACER BUSHING F. FR. WHEEL	2
10	7900907124030	Front spoke	36
11	7710907200004S	Spoke nipple	36
12	8120907010030A	"front rim 1,60x21"" DID"	1
13	50309073000	RIM BAND 21"	1
16	78109090200	Tyre locker 1,60"	1
17	77110090050	NUT FOR WHEEL HOLDER	1
20	77709160000	BRAKE DISC FRONT D=260MM	1
21	59009062013	SPECIAL SCREW M6X13 WS=8 10.9	6
22	79109961100	Factory Racing brake disc guard	1
30	79109081033	Wheel spindle front cmpl, 2019	1
32	A46009082000	Collar screw M20x1.5 SW17 Al	1
38	55003135000	PLUG FOR RIM	x
40	7770908107055	AUXILIARY SCREW FRONT	1

227940910

62221

* NEW PART X ON DEMAND

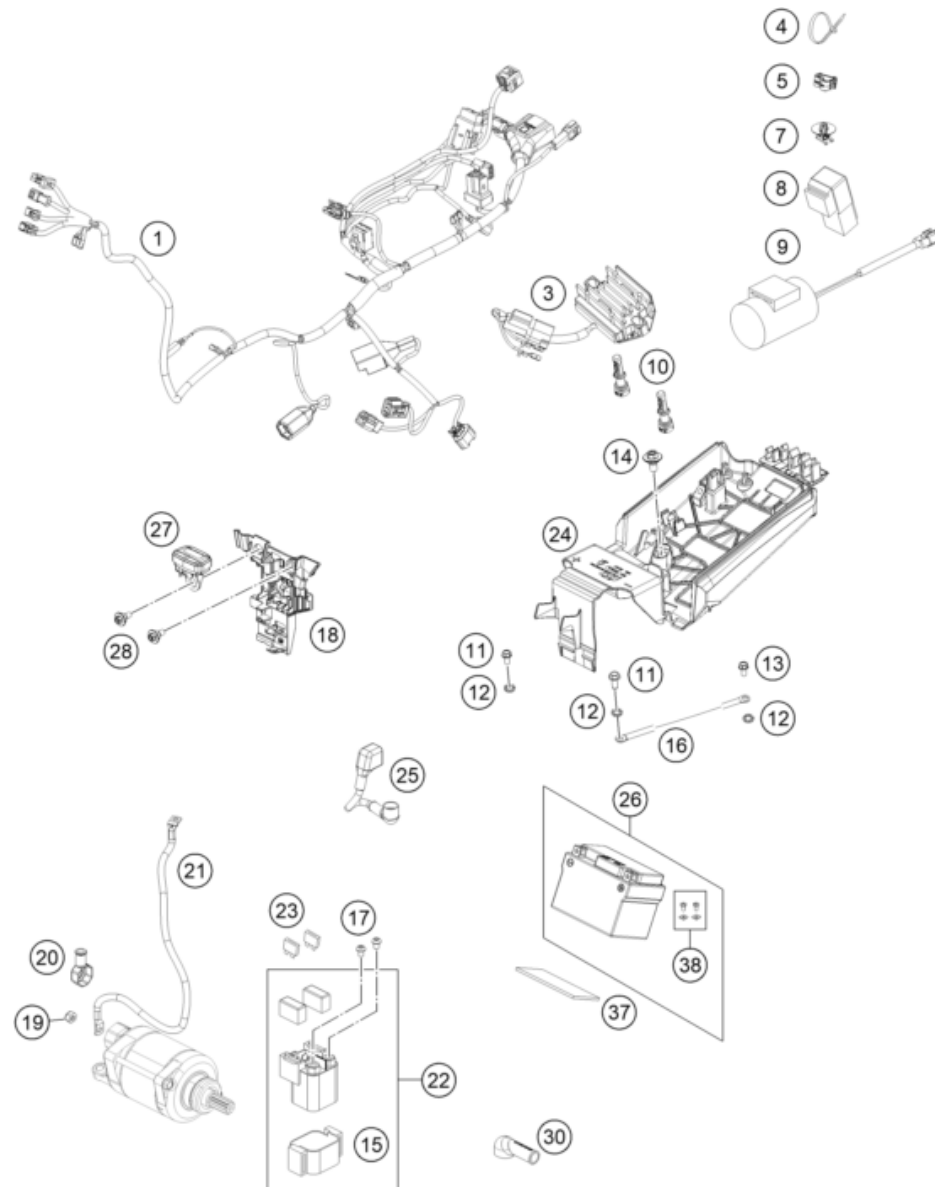

POS	PARTNUMBER		PIECE
1	A46011075100	Main harness	1
3	77211034000	VOLTAGE REGULATOR 09	1
4	44011076140	CABLE TIE 140/2,5MM BLACK	x
4	44011076200	CABLE TIE 200/3,6MM BLACK	x
4	44011076305	CABLE TIE 300/4,8MM BLACK	x
5	83013026000	CABLE GUIDE	2
7	79711013010	Cable bracket d8	1
8	61111057000	RELAY CM1A-R-12V-H80 07	1
9	77711035000	CONDENSATOR	1
10	55641030000	Holder control unit	2
11	0025050126	HH collar screw M5x12 TX30	2
12	58411098100	CONTACT WASHER M6 VSV-K6	3
13	0900000601202	Roundhead screw w/ Tx M6x12 mm	1
14	83008000012	special screw M6x12x3	1
15	58211058050	BRACKET RUBBER F.STARTRELAY 07	1
16	75011097100	Ground wire	1
17	0902060083	AH OVAL SCREW ISO 7380 M 6X8	2
18	A46011083000	Connector support	1
19	0985060003	SELF LOCK. NUT DIN0985-M 6	1
20	77240099000	PROTECTION CAP F. STARTER ENG.	1
21	A46011059000	Starter cable	1
22	58211058000	STARTER RELAY 12V '99	1
23	58011109110	FUSE 10 A 2000	2
24	A46011055100	Battery holding bracket	1
25	A46011059050	Battery cable compl.	1
26	79111053000	battery 12V/24Wh	1
27	A46014069000	Dashboard	1
28	83008100015	SPECIAL SCREW M6X15X5,5	2
30	25140097000	Starter relay cap short	1
37	59003001099	METAMOLL 90X45X3MM 03	1
38	79111053010	screw kit only for 79111053000	1

25A4601111

70592

* NEW PART

X ON DEMAND

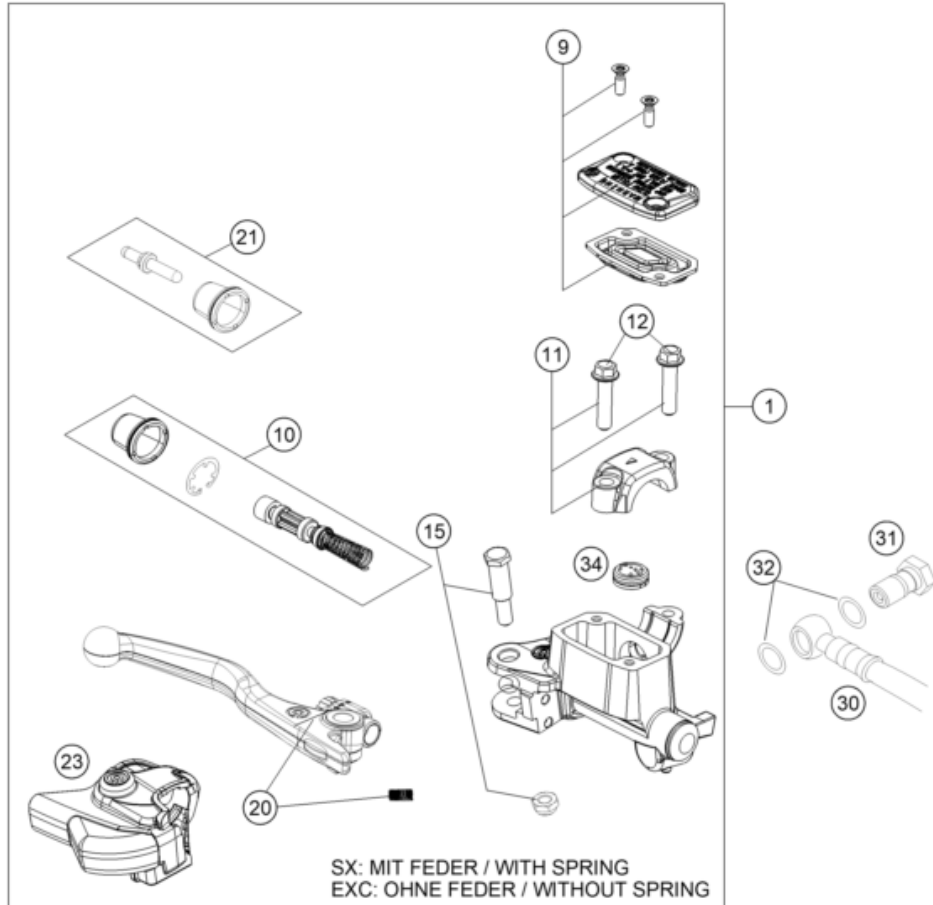

POS	PARTNUMBER		PIECE
1	77713001044	HAND BRAKE CYLIND. CPL. SX 2014	1
9	77713003000	HAND BRAKE CYL. COVER	1
10	77713008000	REPAIR KIT PISTON SX 2014	1
11	54802005100	CLAMP CPL. 06	1
12	0025060256	HH collar screw M6x25 TX30	2
15	77713006000	LEVER SCREW	1
20	77713002000	HAND BRAKE LEVER +SPRING SX 14 SX WITH SPRING, EXC WITHOUT SP	1
21	77713007000	PUSH ROD CPL. SX 2014	1
23	77713004000	PROTECTION CAP HAND BRAKE CYL.	1
30	59013010000	BRAKEHO. FRONT 1235MM 2000	1
31	54813020100	banjo bolt M10x1x19 black	1
32	0603100141	sealing ring DIN 7603 10x14x1	2
34	54802051000	VALVE	1
80	00062030000	BRAKE FLUID DOT5.1 0,25L	1



147781310

15055

* NEW PART

X ON DEMAND

REAR BRAKE CONTROL

250 SX-F ADAMO EDITION 2025 2025

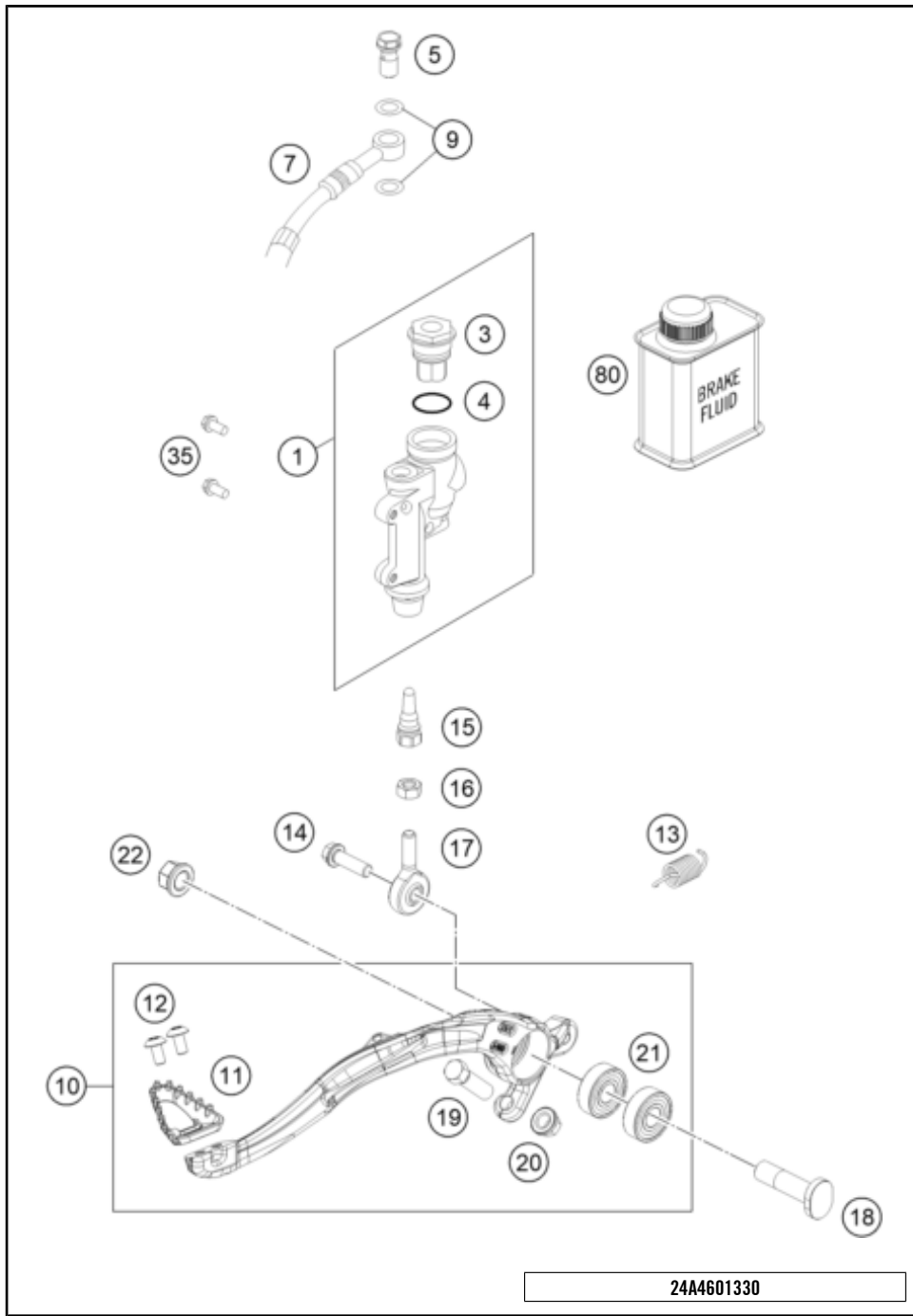

POS	PARTNUMBER		PIECE
1	77013060044	REAR BRAKE CYLINDER CPL.SX 09	1
3	54813062100	REAR BRAKE CYL. COVER CPL. 04	1
4	54813063000	FOOT-BRAKE CYL. GASKET SX 03	1
5	54813020100	banjo bolt M10x1x19 black	1
7	77213070300	Rear Brakehose	1
9	0603100141	sealing ring DIN 7603 10x14x1	2
10	A48013050044	Brake pedal cmpl.	1
11	A48013051000	Step brake lever	1
12	58605083010	SCREW TORX M5X10 05	2
13	A46003062000	Retracting spring	1
14	0025060206S	HH collar screw M6x20 TX30	1
15	54813056000	PUSH ROD L=28MM 03	1
16	0934060003	hex nut DIN 934 M6	1
17	54813055100	Joint head CMP6	1
18	47213054000	Screw foot brake lever	1
19	59001037000	SPECIAL SCREW M8X26 WS=10	1
20	46030045000	flanged nut M8 WS10	1
21	0625060002	deep groove ball bearing SKF 6000-2RS1	2
22	54630044000	COLLAR NUT M10 WS=13	1
35	0025060126	HH collar screw M6x12 TX30	2
80	00062030000	BRAKE FLUID DOT5.1 0,25L	1

24A4601330

69022

* NEW PART

X ON DEMAND

FRONT BRAKE CALIPER

250 SX-F ADAMO EDITION 2025 2025

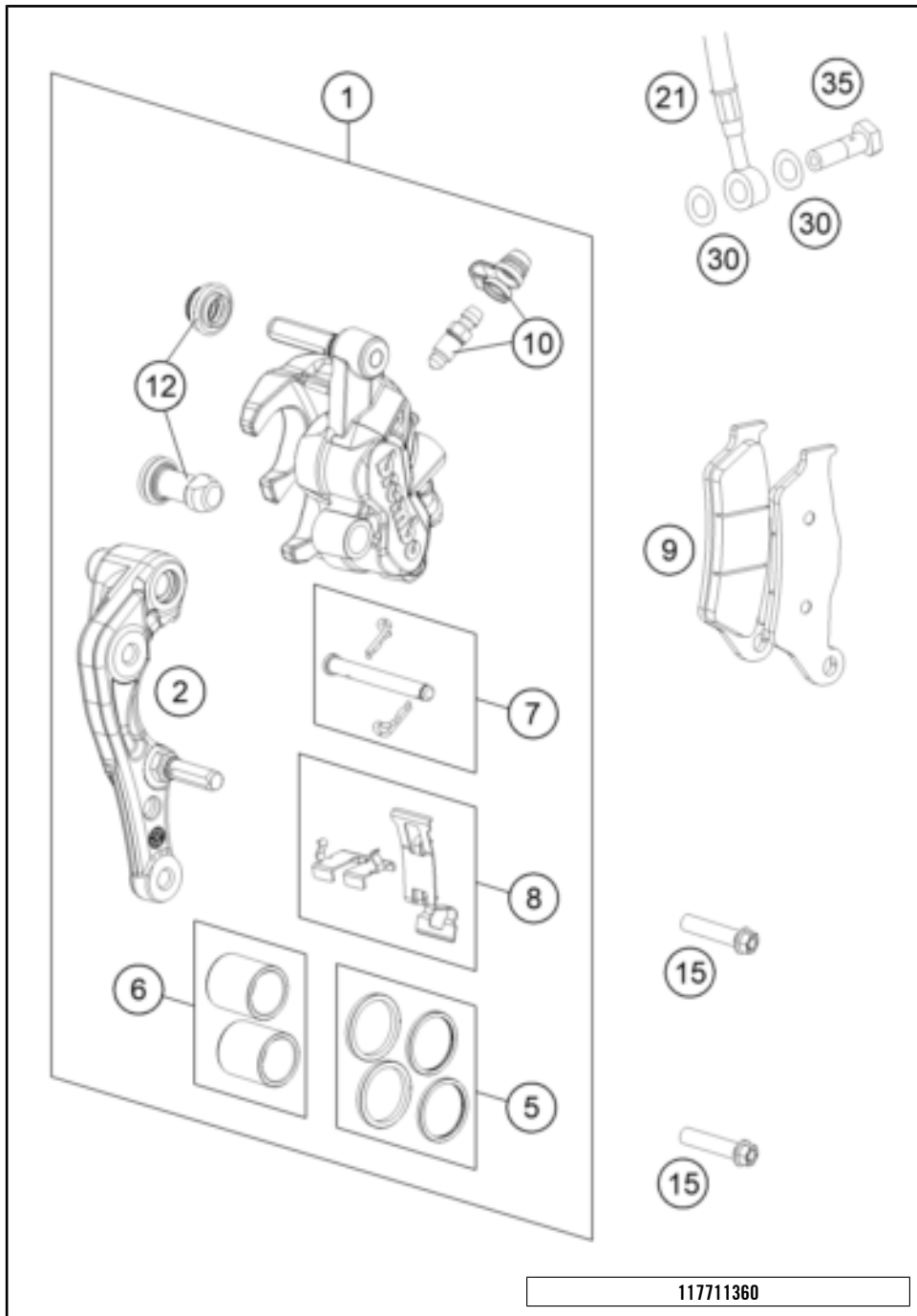

POS	PARTNUMBER		PIECE
1	7701301500101	CALIPER NAT. WITHOUT PADS	1
2	77013014000	BRAKE CALIPER SUPPORT FRONT 09	1
5	77013021000	REP. KIT SEALS 24MM	1
6	77013019000	REP. KIT PISTON 24MM	1
7	77013017000	BOLT CPL. 09	1
8	77013018000	RETAINING PLATE SET BREMBO	1
9	77713030000	BRAKE PADS FRONT	1
10	61013020100	BLEEDER SCREW WITH CAP	1
12	54613218000	CUP SET SHORT	1
15	0025080306S	HH COLLAR SCREW M8X30 TX40	2
21	59013010000	BRAKEHO. FRONT 1235MM 2000	1
30	0603100141	sealing ring DIN 7603 10x14x1	2
35	50213025000	HOLLOW SCREW M10X1X19	1

117711360

10680

* NEW PART X ON DEMAND

REAR BRAKE CALIPER

250 SX-F ADAMO EDITION 2025 2025

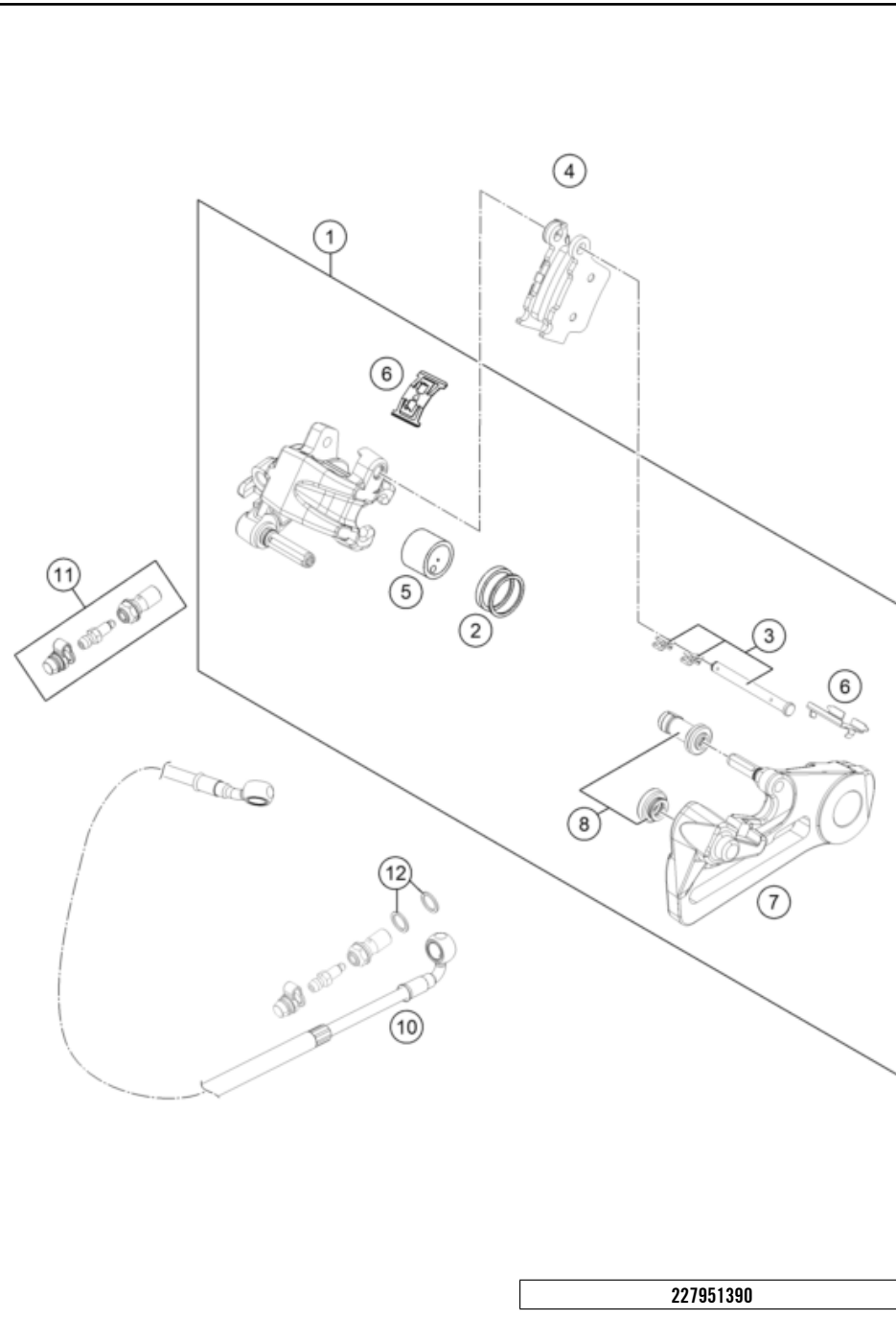

POS	PARTNUMBER		PIECE
1	A46013080001	Rear brake caliper PF 26 b cml.	1
2	50313081200	REPAIR KIT SEALING RINGS 26MM	1
3	54813082000	BOLT SET FOR BRAKE CALIPER 03	1
4	54813090300	BRAKE PAD SET REAR TOYO	x
4	79013090000	BRAKE PAD REAR TOYO B204	1
5	77713083000	BRAKE PISTON 26MM 2013	1
6	54813018000	RETAINING SPRING SET 2003	1
7	A46013075000	Brake caliper support	1
8	54613218100	CUP SET SHORT	1
10	77213070300	Rear Brakehose	1
11	62513020000	BLEEDER SCREW CPL. 05	1
12	0603100141	sealing ring DIN 7603 10x14x1	2

227951390

58280

* NEW PART

X ON DEMAND

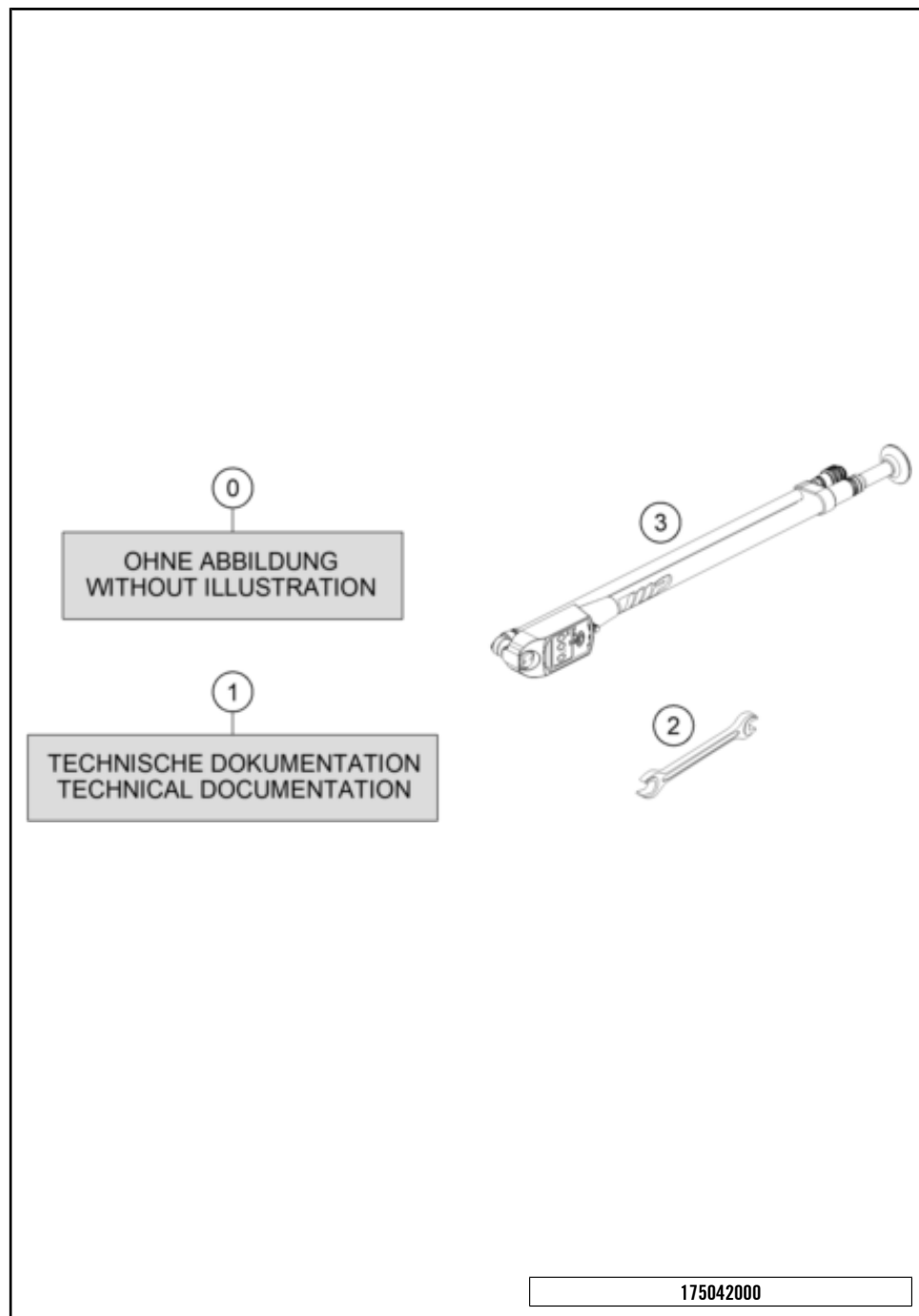

POS	PARTNUMBER		PIECE
0	A46001038010	Rigid handlebar clamp bushing	2
0	A46014086010	KTM CUOffroad	1
0	A46008010120C1	Connectivity Unit bracket	1
0	0081050181	SCREW FOR PLASTIC K50X18 T20	1
0	A46014087020	KTM CUOffroad-GPS	1
0	A46014086030	Rubber band	1
0	A46039075000	Sticker map select switch	1
0	A46003137033	Footpeg set	1
0	81212016100	WASH CAP SET	1
0	A48002014000	Cam 4T 36 mm	1
0	79109961100	Factory Racing brake disc guard	1
0	A54001996000FAA	Factory start device	1
0	A46003990044	Factory skid plate	1
0	A46008092900	Accessory pack 250	1
0	A46002002044C1A	Handlebar pad compl.	1
0	A46006903000AB	Air filter cover	1
0	A46003994000EB1	Factory Racing frame protection set	1
0	0025050126	HH collar screw M5x12 TX30	2
0	58411098100	CONTACT WASHER M6 VSV-K6	2
0	78141013190	FUEL FILTER	3
0	44011176140	cablE tie 140/ 3,5 mm Schwarz	3
0	44011176305	* CABLE TIE 305MM	2
0	00063004202	PRINT LABEL 60X51 MM	1
0	77229072100	Spark plug wrench, WS=14	1
0	A46008007000EBG	Number plate	1
0	00063004012	HEADLIGHT MASK BOX	1
0	52000235SET	Sticker set XACT 5 AER CC 182.5x238	1
0	A46008097000	Warning sticker MX	1
0	A46029094000	Stand/fork support	1
1	3240043EN	Bed.- Anl. 250 SX-F 2025	1
2	50329072000	SPOKE-SPANNER WS 7/10	1
3	79412966100	Fork pump	1

70590 * NEW PART X ON DEMAND



- 5 Ø 5 mm
- 6 Ø 6 mm
- 8 Ø 8 mm
- 10 Ø 10 mm
- 12 Ø 12 mm
- 14 Ø 14-14,5 mm
- 16 Ø 16 mm
- 20 Ø 20 mm
- 21 Ø 21 mm
- 22 Ø 22 mm
- 23 Ø 23 mm
- 24 Ø 24,5 mm
- 28 Ø 28,25-28,5 mm
- 32 Ø 32 mm
- 52 Ø 52 mm

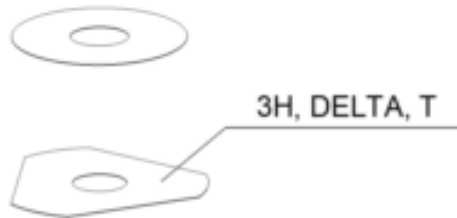

POS	PARTNUMBER		PIECE
1	48600611	Spring (10,2) l5 check valve	X
5	44906890	WASHER 5X15X2	X
6	40540400	Shim 6x12x0,10	X
6	40540401	Shim 6x14x0,10	X
6	40540402	Shim 6x16x0,10	X
6	40540403	Shim 6x18x0,10	X
6	40540404	Shim 6x12x0,15	X
6	40540405	Shim 6x14x0,15	X
6	40540406	Shim 6x16x0,15	X
6	40540407	SHIM 6X18X0,15	X
6	40540408	Shim 6x12x0,20	X
6	40540409	Shim 6x14x0,20	X
6	40540410	Shim 6x16x0,20	X
6	40540411	Shim 6x18x0,20	X
6	48600095	SHIM 6X20X0,20	X
6	40540412	Shim 6x12x0,25	X
6	40540413	Shim 6x14x0,25	X
6	40540414	Shim 6x16x0,25	X
6	40540415	Shim 6x18x0,25	X
6	40540417	SHIM 6X8,5X0,10	X
6	40540418	SHIM 6X9X0,10	X
6	40540419	SHIM 6X9,5X0,10	X
6	40540423	SHIM 6X9,5X0,15	X
6	40540425	SHIM 6X8,5X0,20	X
6	40540426	SHIM 6X9X0,20	X
6	40540427	SHIM 6X9,5X0,20	X
6	40540447	Shim 6x10x0,30	X
6	40540449	Shim 6x9x0,30	X
6	40540450	Shim 6x9,5x0,30	X
6	40540494	Shim 6x18x0,40	X
6	40540774	Shim 6x18x0,10 delta	X
6	40541383	Shim 6X11X0,10	X
6	40541391	Shim 6x11x0,30	X
6	40541402	Shim 6x11x0,20	X
6	40541403	SHIM 6X10X0,20	X
6	40541404	Shim 6x10x0,10	X
6	40541405	Shim 6x10x0,15	X
6	40541406	SHIM 6X11X0,15	X

080000190

4668

* NEW PART

X ON DEMAND



- 5 Ø 5 mm
- 6 Ø 6 mm
- 8 Ø 8 mm
- 10 Ø 10 mm
- 12 Ø 12 mm
- 14 Ø 14-14,5 mm
- 16 Ø 16 mm
- 20 Ø 20 mm
- 21 Ø 21 mm
- 22 Ø 22 mm
- 23 Ø 23 mm
- 24 Ø 24,5 mm
- 28 Ø 28,25-28,5 mm
- 32 Ø 32 mm
- 52 Ø 52 mm



POS	PARTNUMBER		PIECE
6	40541408	SHIM 6X8,0X0,30	X
6	40541414	Shim 6x8x0,1	X
6	40541416	SHIM 6X8X0,3	X
6	40541417	SHIM 6X11X0,25	X
6	48600102	SHIM 6X24X0,25	X
6	48600063	Shim 6x24x0,10	X
6	48600064	Shim 6x22x0,10	X
6	48600065	Shim 6x20x0,10	X
6	48600069	Shim 6x20x0,15	X
6	48600100	Shim 6x24x0,15	X
6	48600116	Shim 6x24x0,10 delta	X
6	48600139	Shim 6x22x0,1 delta	X
6	48600217	Shim 6x10x0,25	X
6	48600325	Shim 6x13x0,10	X
6	48600327	SHIM 6X15X0,1	X
6	48600329	Shim 6x17x0,10	X
6	48600331	Shim 6x19x0,10	X
6	48600096	Shim 6x20x0,25	X
6	48600097	Shim 6x22x0,15	X
6	48600099	Shim 6x22x0,25	X
6	40540448	Shim 6x8,5x0,30	X
6	48600479	Shim 6x20x0,10 DELTA	X
6	48600332	SHIM 6X21X0,1	X
6	48600333	SHIM 6X23X0,1	X
6	40541393	Shim 6x12x0,30	X
6	48600330	SHIM 6X17X0,15	X
6	48600988	Shim 6x28x0,10	X
6	48600989	Shim 6x26x0,10	X
6	48601091	Shim 6x28x0,15	X
6	48601093	Shim 6x26x0,15	X
6	48600328	Shim 6x15x0,15	X
6	48600326	Shim 6x13x0,15	X
6	48601548	Shim 6x17x1,5	X
6	48601693	Washer 6x18x3	X
6	48600098	Shim 6x22x0,20	X
6	48601300	Washer 6x25x1,5	X
6	48601692	Shim 6x30x0,15	X
6	48601550	Shim 6x30x0,10	X

080000190

4668

* NEW PART

X ON DEMAND



- 5 Ø 5 mm
- 6 Ø 6 mm
- 8 Ø 8 mm
- 10 Ø 10 mm
- 12 Ø 12 mm
- 14 Ø 14-14,5 mm
- 16 Ø 16 mm
- 20 Ø 20 mm
- 21 Ø 21 mm
- 22 Ø 22 mm
- 23 Ø 23 mm
- 24 Ø 24,5 mm
- 28 Ø 28,25-28,5 mm
- 32 Ø 32 mm
- 52 Ø 52 mm



POS	PARTNUMBER		PIECE
6	40541392	Shim 6x8x0,2	X
6	48601917	Washer 6x25x4	X
6	48601916	Washer 6x18x4	X
6	40540399	Shim 6x16x0,30	X
6	48601584	Shim 6x30x0,4 spring shim	X
6	48601459	Washer check valve 6x31x0,4	X
6	48601849	Check valve plate 2,5mm hub	X
6	48600101	SHIM 6X24X0,20	X
6	48601094	Shim 6x26x0,20	X
6	40540422	Shim 6X9X0,15	X
6	48601841	Washer check valve 6x31x0,4	X
6	48601850	Shim 6x30x0,4 spring shim	X
6	48601092	Shim 6x28x0,20	X
6	48601264	Shim 6x25x0,10	X
6	48600967	Shim 6x20x0,2 DELTA	X
6	48601847	Washer 6x25x1,5	X
6	48601707	Sinus shim plate 6X30	X
6	S64060000400000	Shim 6x14x0.3	X
6	S64060000500000	Shim 6x13x0.25	X
6	S64060000600000	Shim 6x17x0,2	X
6	40540421	Shim 6x8.5x0.15	X
6	48601262	Washer 6x18x1,5	X
6	S64060001500000	Shim 6x8x0.15	X
8	40540477	Shim 8x18x0,40	X
8	43570120	Shim 8x18x0,10	X
8	44916098	WASHER 8,4X16X0,8	X
8	44916130	WASHER 8,2X15X1	X
8	44916180	WASHER 8,2X11X1	X
8	48600214	Shim 8x16x0,10	X
8	48600385	SHIM 8x14x0.25	X
8	48600346	Shim 8x11x0,20	X
8	48600215	Shim 8x20x0,10	X
8	48600485	SHIM 8X10X0,10	X
8	48601402	SHIM 8X13X0,10	X
8	48600350	Shim 8x16x0,15	X
8	48600061	Shim 8x24x0,40	X
8	48600062	CHECK VALVE 8X24X0,1	X
8	48600216	Shim 8x22x0,10	X

080000190

4668

* NEW PART

X ON DEMAND



- 5 Ø 5 mm
- 6 Ø 6 mm
- 8 Ø 8 mm
- 10 Ø 10 mm
- 12 Ø 12 mm
- 14 Ø 14-14,5 mm
- 16 Ø 16 mm
- 20 Ø 20 mm
- 21 Ø 21 mm
- 22 Ø 22 mm
- 23 Ø 23 mm
- 24 Ø 24,5 mm
- 28 Ø 28,25-28,5 mm
- 32 Ø 32 mm
- 52 Ø 52 mm

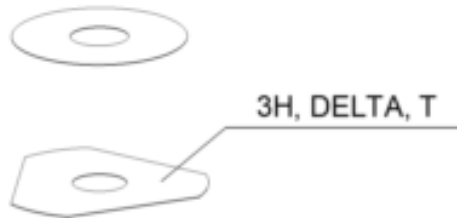

POS	PARTNUMBER		PIECE
8	48600480	Shim 8x10x0,20	X
8	48600555	SHIM 8X16X0,20	X
8	48600213	SHIM 8X14X0,10	X
8	48600357	Shim 8x11x0,10	X
8	48600351	Shim 8x12x0,10	X
8	48600607	Shim 8x20x0,40	X
8	48601095	Shim 8x17x0,10	X
8	48600352	CHECK VALVE 8X11X0,4	X
8	48601860	Washer 8x11x0,15	X
8	48601266	Shim 8x26x0,40	X
8	46180640	Shim 8x16x0,3	X
8	43578166	Washer 8x20x1	X
8	48601113	Shim 8x15x0,1	X
8	48600218	Shim 8X11X0,40	X
8	48600964	Shim 8x20x0,15	X
8	89080008	Shim 8x30x0,10	X
8	48601859	Shim 8x10x0,15	X
8	48601863	Shim 8x14x0,15	X
8	89080001	Shim 8x18x0,15	X
8	89080002	Shim 8x22x0,15	X
8	89080003	Shim 8x24x0,15	X
8	89080005	Shim 8x26x0,15	X
8	89080007	Shim 8x28x0,15	X
8	89080009	Shim 8x30x0,15	X
8	48600386	Shim 8X12X0,25	X
8	48601862	Shim 8x13x0,15	X
8	89080004	Shim 8x26x0,10	X
8	89080006	Shim 8x28x0,10	X
8	S64080000000000	Shim 8x24x0,2	X
8	48601864	Shim 8x15x0,15	X
8	48600965	SHIM 8X20X0,2	X
8	S64080000300000	Shim 8x18x0,2	X
8	S64080000100000	Shim 8x12x0,2	X
8	S64080000900000	shim 8x14x0,2	X
8	S64080000100000	Shim 8x12x0,2	X
8	S64080000400000	Shim 8x22x0,2	X
8	48600384	Shim 8x22x0,30	X
10	36120284	SHIM 10X16X0,10	X

080000190

4668

* NEW PART

X ON DEMAND



5 Ø 5 mm

6 Ø 6 mm

8 Ø 8 mm

10 Ø 10 mm

12 Ø 12 mm

14 Ø 14-14,5 mm

16 Ø 16 mm

20 Ø 20 mm

21 Ø 21 mm

22 Ø 22 mm

23 Ø 23 mm

24 Ø 24,5 mm

28 Ø 28,25-28,5 mm

32 Ø 32 mm

52 Ø 52 mm

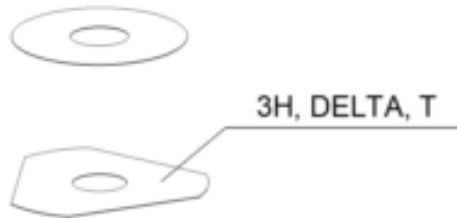

POS	PARTNUMBER		PIECE
10	36120298	SHIM 10X16X0,2	X
10	36120312	SHIM 10X16X0,30	X
10	36120314	SHIM 10X18X0,30	X
10	36120325	SHIM 10X19X0,15	X
10	36120327	SHIM 10X23X0,15	X
10	36120328	SHIM 10X25X0,15	X
10	36120329	SHIM 10X27X0,15	X
10	36120330	SHIM 10X29X0,15	X
10	36120331	SHIM 10X31X0,15	X
10	36120332	SHIM 10X33X0,15	X
10	36120334	SHIM 10X21X0,20	X
10	36120335	SHIM 10X23X0,20	X
10	36120336	SHIM 10X25X0,20	X
10	36120337	SHIM 10X27X0,20	X
10	36120338	SHIM 10X29X0,20	X
10	36120339	SHIM 10X31X0,20	X
10	36120340	SHIM 10X33X0,20	X
10	36120342	SHIM 10X21X0,25	X
10	36120343	SHIM 10X23X0,25	X
10	36120344	SHIM 10X25X0,25	X
10	36120345	SHIM 10X27X0,25	X
10	36120349	SHIM 10X19X0,30	X
10	36120350	SHIM 10X21X0,30	X
10	36120313	SHIM 10X17X0,30	X
10	36120354	SHIM 10X29X0,30	X
10	40140275	WASHER 10X35X0,15	X
10	48601708	Shim 10x30x0,40	X
10	36120346	SHIM 10X29X0,25	X
10	36120355	SHIM 10X31X0,30	X
10	36120348	SHIM 10X33X0,25	X
10	36120311	SHIM 10X15X0,30	X
10	36120292	SHIM 10X17X0,15	X
10	36120326	SHIM 10X21X0,15	X
10	36120286	SHIM 10X18X0,10	X
10	36120347	SHIM 10X31X0,25	X
10	36120333	SHIM 10X19X0,20	X
10	36120351	SHIM 10X23X0,30	X
10	36120352	SHIM 10X25X0,30	X

080000190

4668

* NEW PART

X ON DEMAND



5 Ø 5 mm

6 Ø 6 mm

8 Ø 8 mm

10 Ø 10 mm

12 Ø 12 mm

14 Ø 14-14,5 mm

16 Ø 16 mm

20 Ø 20 mm

21 Ø 21 mm

22 Ø 22 mm

23 Ø 23 mm

24 Ø 24,5 mm

28 Ø 28,25-28,5 mm

32 Ø 32 mm

52 Ø 52 mm

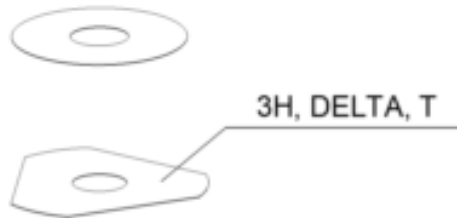

3H, DELTA, T

POS	PARTNUMBER		PIECE
10	36120353	SHIM 10X27X0,30	X
10	36120356	SHIM 10X33X0,30	X
10	50180395	Washer 10x16x1	X
10	36120291	SHIM 10X16X0,15	X
10	36120308	Shim 10x13x0,30	X
10	36120604	Washer 10x22x2,5	X
10	36120299	SHIM 10X17X0,20	X
12	46810605	SHIM 12X21X0,10	X
12	46810490	SHIM 12X24X0,20	X
12	46810491	Shim 12x26x0,20	X
12	46810492	Shim 12x28x0,20	X
12	46810493	SHIM 12X30X0,20	X
12	46810494	Shim 12x32x0,20	X
12	46810495	Shim 12x34x0,20	X
12	46810496	SHIM 12X36X0,20	X
12	46810497	SHIM 12X38X0,20	X
12	46810498	Shim 12x40x0,20	X
12	46810499	Shim 12x24x0,25	X
12	46810500	SHIM 12X26X0,25	X
12	46810501	SHIM 12X28X0,25	X
12	46810502	Shim 12x30x0,25	X
12	46810504	SHIM 12X34X0,25	X
12	46810505	SHIM 12X36X0,25	X
12	46810507	Shim 12x40x0,25	X
12	46810508	SHIM 12X24X0,30	X
12	46810509	SHIM 12X26X0,30	X
12	46810510	SHIM 12X28X0,30	X
12	46810512	SHIM 12X32X0,30	X
12	46810513	SHIM 12X34X0,30	X
12	46810518	SHIM 12X26X0,15	X
12	46810519	SHIM 12X28X0,15	X
12	46810520	SHIM 12X30X0,15	X
12	46810521	SHIM 12X32X0,15	X
12	46810522	SHIM 12X34X0,15	X
12	46810523	SHIM 12X36X0,15	X
12	46810524	SHIM 12X38X0,15	X
12	46810525	SHIM 12X40X0,15	X
12	46810604	SHIM 12X20X0,10	X

080000190

4668

* NEW PART

X ON DEMAND



- 5 Ø 5 mm
- 6 Ø 6 mm
- 8 Ø 8 mm
- 10 Ø 10 mm
- 12 Ø 12 mm
- 14 Ø 14-14,5 mm
- 16 Ø 16 mm
- 20 Ø 20 mm
- 21 Ø 21 mm
- 22 Ø 22 mm
- 23 Ø 23 mm
- 24 Ø 24,5 mm
- 28 Ø 28,25-28,5 mm
- 32 Ø 32 mm
- 52 Ø 52 mm

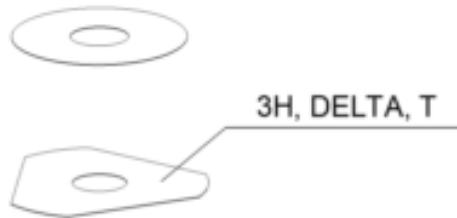

POS	PARTNUMBER		PIECE
12	46810606	SHIM 12X22X0,10	X
12	46810607	SHIM 12X23X0,10	X
12	46810608	SHIM 12X24X0,10	X
12	46810610	Shim 12x17x0,15	X
12	46810611	SHIM 12X18X0,15	X
12	46810612	SHIM 12X19X0,15	X
12	46810615	SHIM 12X22X0,15	X
12	46810636	BACKPLATE 12X16X0,30	X
12	46810637	Shim 12x17x0,30	X
12	46810638	Shim 12x18x0,30	X
12	46810639	SHIM 12X19X0,30	X
12	46810641	Shim 12X21X0,30	X
12	46811582	Shim 12x30x0,10	X
12	46810631	SHIM 12X20X0,25	X
12	46810633	SHIM 12X22X0,25	X
12	46811580	Shim 12x32x0,10	X
12	46810503	SHIM 12X32X0,25	X
12	46810517	SHIM 12X24X0,15	X
12	46810856	Shim 12x20x0,30	X
12	46811258	Washer 12x24x2,5	X
12	46812018	Shim 12x42x0,25	X
12	46812015	Shim 12x44x0,20	X
12	46810613	SHIM 12X20X0,15	X
12	46810623	SHIM 12X21X0,20	X
12	46810624	SHIM 12X22X0,20	X
12	46810642	SHIM 12X22X0,30	X
12	46810643	SHIM 12X23X0,30	X
12	46811629	Shim 12x28x0,10	X
12	46810511	SHIM 12X30X0,30	X
12	46810514	SHIM 12X36X0,30	X
12	46810506	SHIM 12X38X0,25	X
12	46810515	SHIM 12X38X0,30	X
12	46812017	Shim 12x42x0,20	X
12	46812016	Shim 12x44x0,25	X
12	46810622	SHIM 12X20X0,20	X
12	46811635	Shim 12x26x0,10	X
12	50181296	Shim 12x45x0,20	X
12	46810620	Shim 12x18x0,2	X

080000190

4668

* NEW PART

X ON DEMAND



5 Ø 5 mm

6 Ø 6 mm

8 Ø 8 mm

10 Ø 10 mm

12 Ø 12 mm

14 Ø 14-14,5 mm

16 Ø 16 mm

20 Ø 20 mm

21 Ø 21 mm

22 Ø 22 mm

23 Ø 23 mm

24 Ø 24,5 mm

28 Ø 28,25-28,5 mm

32 Ø 32 mm

52 Ø 52 mm

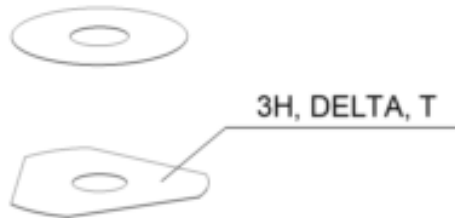

POS	PARTNUMBER		PIECE
12	46810616	Shim 12x23x0,15	X
12	46810625	SHIM 12X23X0,20	X
12	50181297	Adjustment 12x45x0,25	X
12	46810603	SHIM 12X19X0,10	X
12	46180712	SHIM 12X36X0,10	X
12	46810614	SHIM 12X21X0,15	X
12	46810628	SHIM 12X17X0,25	X
12	46810634	SHIM 12X23X0,25	X
12	S64120000000000	Shim 12x25x0,15	X
12	46810516	SHIM 12X40X0,30	X
12	S64120000800000	Shim 12x34x0,1	X
12	46810627	SHIM 12X16X0,25	X
12	46810632	SHIM 12X21X0,25	X
12	46810602	SHIM 12X18X0,10	X
14	35480479	Shim 14x26x0,40	X
14	46811046	Washer 14,5x35,4x1,25	X
16	50180023	SHIM 16X23X0,20	X
16	50180030	Shim 16x23x0,25	X
16	50180006	Shim 16x20x0,10	X
16	50180007	SHIM 16X21X0,10	X
16	50180028	SHIM 16X21X0,25	X
16	50180210	Washer 16x21x1	X
16	50180008	SHIM 16X22X0,10	X
16	50180022	Shim 16x22x0,20	X
16	50180037	SHIM 16X23X0,30	X
16	50180038	SHIM 16X24X0,30	X
16	50180032	Shim 16x25x0,25	X
16	50180039	SHIM 16X25X0,30	X
16	50180012	SHIM 16X26X0,10	X
16	50180019	SHIM 16X26X0,15	X
16	50180026	SHIM 16X26X0,20	X
16	50180040	SHIM 16X26X0,30	X
16	50180041	SHIM 16X28X0,10	X
16	50180045	Shim 16x28x0,15	X
16	50180054	Shim 16x28x0,2	X
16	50180063	SHIM 16X28X0,25	X
16	50180072	SHIM 16X28X0,30	X
16	50180046	SHIM 16X30X0,15	X

080000190

4668

* NEW PART

X ON DEMAND



- ⑤ Ø 5 mm
- ⑥ Ø 6 mm
- ⑧ Ø 8 mm
- ⑩ Ø 10 mm
- ⑫ Ø 12 mm
- ⑭ Ø 14-14,5 mm
- ⑯ Ø 16 mm
- ⑳ Ø 20 mm
- ㉑ Ø 21 mm
- ㉒ Ø 22 mm
- ㉓ Ø 23 mm
- ㉔ Ø 24,5 mm
- ㉘ Ø 28,25-28,5 mm
- ㉚ Ø 32 mm
- ㉜ Ø 52 mm



POS	PARTNUMBER		PIECE
16	50180055	SHIM 16X30X0,20	X
16	50180064	Shim 16x30x0,25	X
16	50180073	SHIM 16X30X0,30	X
16	50180047	Shim 16X32X0,15	X
16	50180056	Shim 16x32x0,2	X
16	50180065	SHIM 16X32X0,25	X
16	50180074	SHIM 16X32X0,30	X
16	50180044	SHIM 16X34X0,10	X
16	50180048	SHIM 16X34X0,15	X
16	50180057	Shim 16x34x0,2 y5	X
16	50180066	SHIM 16X34X0,25	X
16	50180075	SHIM 16X34X0,30	X
16	50180049	Shim 16x36x0,15	X
16	50180058	Shim 16x36x0,20	X
16	50180067	SHIM 16X36X0,25	X
16	50180076	SHIM 16X36X0,30	X
16	50180050	SHIM 16X38X0,15	X
16	50180059	SHIM 16X38X0,20	X
16	50180068	SHIM 16X38X0,25	X
16	50180077	SHIM 16X38X0,30	X
16	50180051	Shim 16x40x0,15	X
16	50180060	Shim 16x40x0,2	X
16	50180069	SHIM 16X40X0,25	X
16	50180078	SHIM 16X40X0,30	X
16	50180052	SHIM 16X42X0,15	X
16	50180061	Shim 16x42x0,2	X
16	50180070	SHIM 16X42X0,25	X
16	50180079	SHIM 16X42X0,30	X
16	50180053	SHIM 16X44X0,15	X
16	50180062	Shim 16X44X0,20	X
16	50180071	SHIM 16X44X0,25	X
16	50180080	SHIM 16X44X0,30	X
16	50180177	Springwasher 8,2x16x0,6	X
16	50180033	Shim 16x26x0,25	X
16	50180034	Shim 16x20x0,30	X
16	50180035	Shim 16x21x0,30	X
16	50180036	Shim 16x22x0,30	X
16	50180043	SHIM 16X32X0,10	X

080000190

4668

* NEW PART

X ON DEMAND



5 Ø 5 mm

6 Ø 6 mm

8 Ø 8 mm

10 Ø 10 mm

12 Ø 12 mm

14 Ø 14-14,5 mm

16 Ø 16 mm

20 Ø 20 mm

21 Ø 21 mm

22 Ø 22 mm

23 Ø 23 mm

24 Ø 24,5 mm

28 Ø 28,25-28,5 mm

32 Ø 32 mm

52 Ø 52 mm

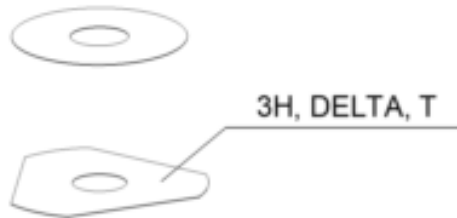

POS	PARTNUMBER		PIECE
16	50180024	Shim 16x24x0,20	X
16	50180027	SHIM 16X20X0,25	X
16	50180031	Shim 16x24x0,25	X
16	50180029	SHIM	X
16	50180010	SHIM 16X24X0,10	X
16	50180021	SHIM 16X21X0,20	X
16	50180025	SHIM 16X25X0,20	X
16	50180383	Washer 16x19x0,3	X
16	50180014	SHIM	X
16	50180013	SHIM 16X20X0,15	X
16	50180015	DISTANCER PLATE 16X22X0,15	X
16	50180017	Shim 16x24x0,15	X
16	50180009	DISTANCER PLATE 16X23X0,10	X
16	50180016	SHIM 16X23X0,15	X
16	50180020	SHIM 16X20X0,20	X
20	48600212	PRESSURE-RING 20X16,25X0,20	X
20	50180666	SHIM 20X24X0,30	X
20	50180654	SHIM 20X36X0,20	X
20	50180655	SHIM 20X38X0,20	X
20	50180656	SHIM 20X40X0,20	X
20	50180665	SHIM 20X40X0,25	X
20	50180662	SHIM 20X34X0,25	X
20	50180657	SHIM 20X24X0,25	X
20	50180653	SHIM 20X34X0,20	X
20	50180634	RING 20X22,9X1	X
20	50180650	SHIM 20,2X28X0,20	X
20	50180663	SHIM 20X36X0,25	X
20	50180664	SHIM 20X38X0,25	X
20	50180659	SHIM 20,2X28X0,25	X
21	50180209	Shim 21x36x0,25	X
22	50180330	Shim 18x22x0,3	X
23	50180635	SHUTTLE VALVE 23X38X0,25	X
23	50180578	SHIM D23XD16X2	X
24	40541061	WASHER 24,5X34X2	X
28	36120469	SHIM 28,5X14X2	X
28	36120471	SHIM 28,5X14X5	X
28	89000001	Shim 28,25x34x0,30	X
28	46811636	Shim 28,25x32x0,30	X

080000190

4668

* NEW PART

X ON DEMAND



- 5 Ø 5 mm
- 6 Ø 6 mm
- 8 Ø 8 mm
- 10 Ø 10 mm
- 12 Ø 12 mm
- 14 Ø 14-14,5 mm
- 16 Ø 16 mm
- 20 Ø 20 mm
- 21 Ø 21 mm
- 22 Ø 22 mm
- 23 Ø 23 mm
- 24 Ø 24,5 mm
- 28 Ø 28,25-28,5 mm
- 32 Ø 32 mm
- 52 Ø 52 mm



POS	PARTNUMBER		PIECE
32	48600460	WASHER 32X42X2,5	X
32	50600065	SHIM 32X45X2	X
32	46811637	Shim 32,25x36x0,30	X
52	50600002	Washer 52x59x2,2	X

080000190

4668

* NEW PART

X ON DEMAND

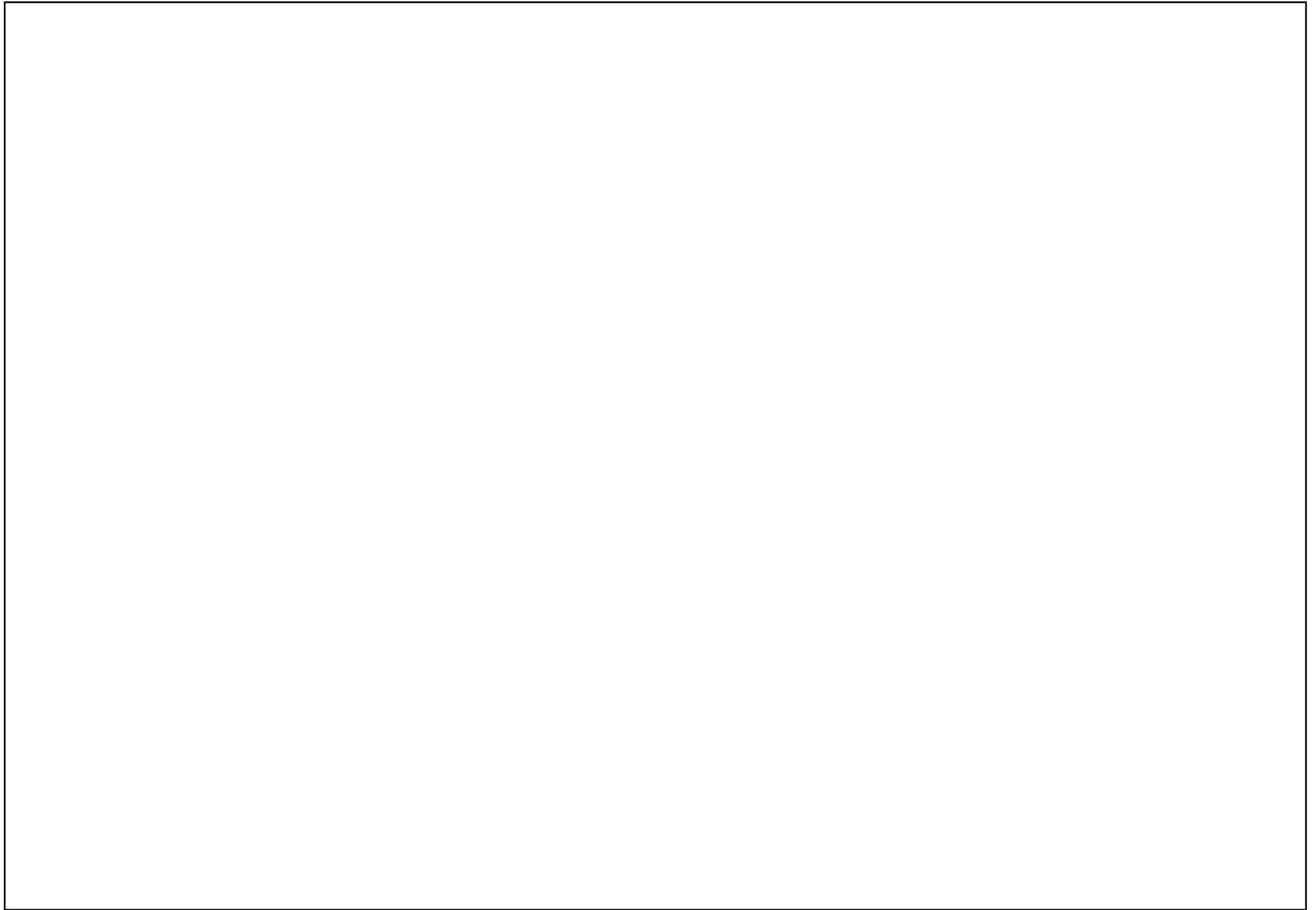

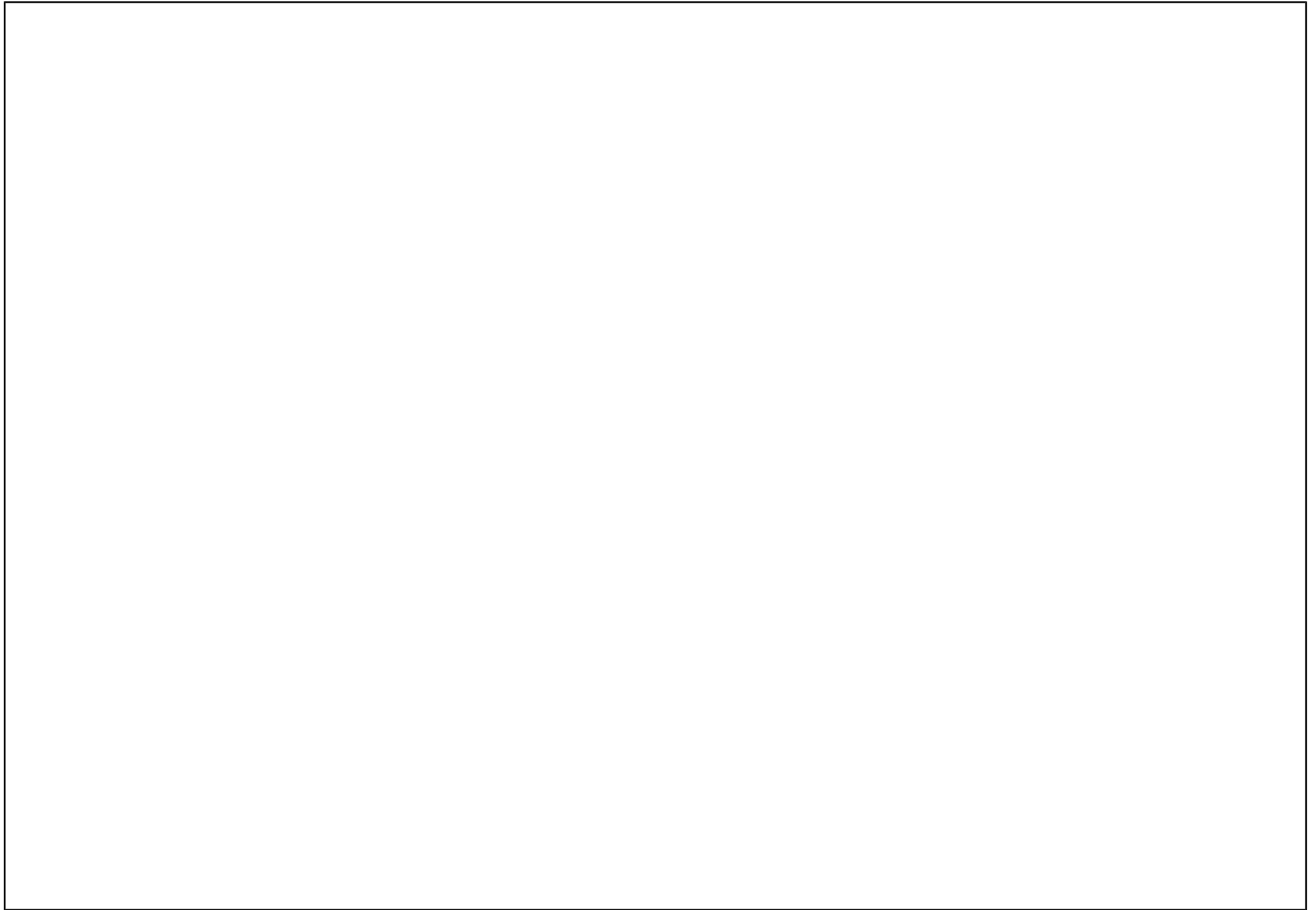

A large, empty rectangular box with a thin black border, occupying the majority of the page. It is intended for the user to write notes.

KTM.COM



F8101Y6EN

KTM Sportmotorcycle GmbH
5230 Mattighofen, Austria
www.ktm.com

KTM POWERPARTS

KTM POWERWEAR

KTM ORIGINAL SPARE PARTS



Art. Nr.: F8101Y6EN 6. Feb 2024