

# 450 RALLY 2014

ART.-NR.: 3CM089280NEN

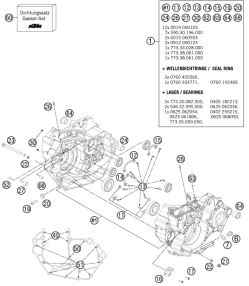

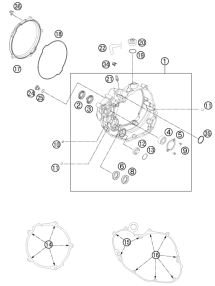
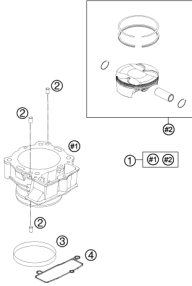
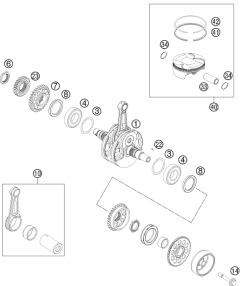
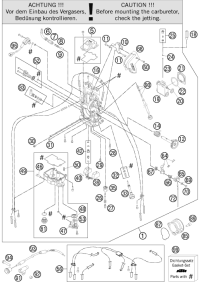
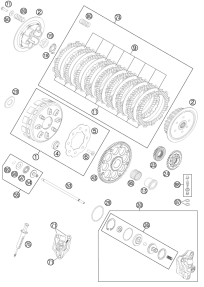
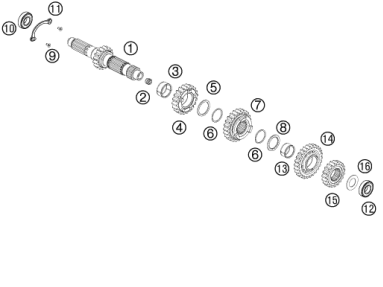
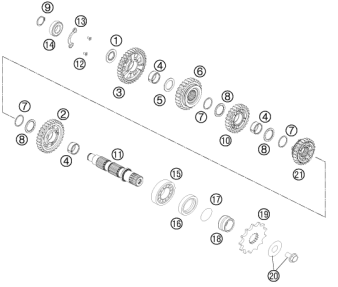
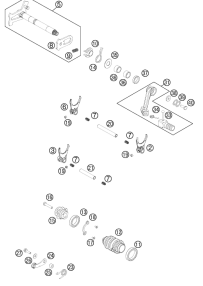
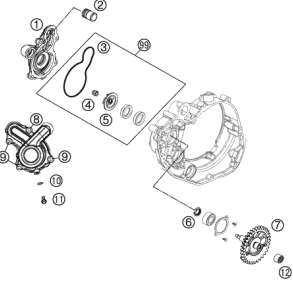
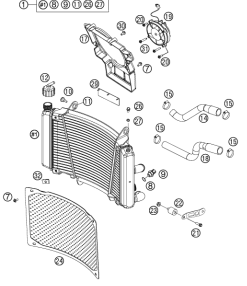
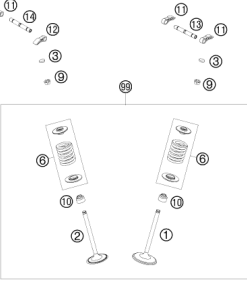

<p><b>ENGINE CASE</b></p>  <p><b>3</b></p>	<p><b>CLUTCH COVER</b></p>  <p><b>4</b></p>	<p><b>CYLINDER</b></p>  <p><b>5</b></p>	<p><b>CRANKSHAFT, PISTON</b></p>  <p><b>6</b></p>
<p><b>CARBURETOR</b></p>  <p><b>7</b></p>	<p><b>CLUTCH</b></p>  <p><b>10</b></p>	<p><b>TRANSMISSION I - MAIN SHAFT</b></p>  <p><b>11</b></p>	<p><b>TRANSMISSION II - COUNTERSHAFT</b></p>  <p><b>12</b></p>
<p><b>SHIFTING MECHANISM</b></p>  <p><b>13</b></p>	<p><b>WATER PUMP</b></p>  <p><b>14</b></p>	<p><b>COOLING SYSTEM</b></p>  <p><b>15</b></p>	<p><b>VALVE DRIVE</b></p>  <p><b>16</b></p>

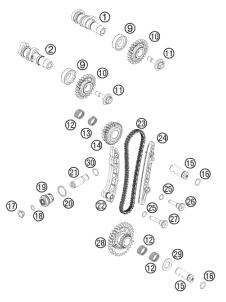
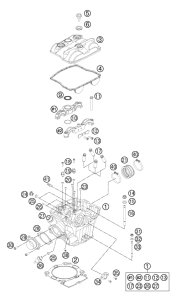
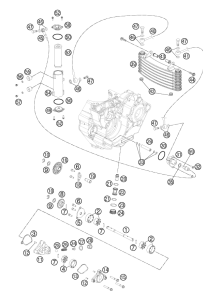
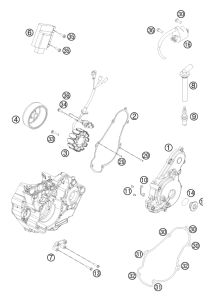
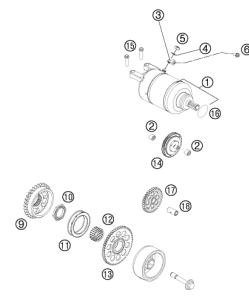
<p><b>TIMING DRIVE</b></p>  <p style="text-align: right;"><b>17</b></p>	<p><b>CYLINDER HEAD</b></p>  <p style="text-align: right;"><b>18</b></p>	<p><b>LUBRICATING SYSTEM</b></p>  <p style="text-align: right;"><b>19</b></p>	<p><b>IGNITION SYSTEM</b></p>  <p style="text-align: right;"><b>21</b></p>
<p><b>ELECTRIC STARTER</b></p>  <p style="text-align: right;"><b>22</b></p>	<div style="display: flex; align-items: center;"> <div style="background-color: #cccccc; width: 50px; height: 50px; display: flex; align-items: center; justify-content: center; margin-right: 10px;"> <span style="font-size: 2em; font-weight: bold;">!</span> </div> <div> <p>All information contained is without obligation. KTM-Sportmotorcycle AG particularly reserves the right to modify any equipment, technical specifications, prices, colors, shapes, materials, services, service work, constructions, equipment and the like so as to adapt them to local conditions or to cancel any of the above items, all without previous announcement and without giving reasons. KTM may stop manufacturing certain models without previous notice. KTM shall not be held liable for any deviations of availability and/or ability to deliver, illustrations, descriptions, printing and/or other errors. The illustrated models partly contain extra equipment, which is not applied to standard models.</p> <p>© by KTM-SPORTMOTORCYCLE AG, Mattighofen AUSTRIA; All rights reserved; Reprint, also in extracts, with written allowance of KTMSPORTMOTORCYCLE AG, Mattighofen only.</p> </div> </div>		



#1	11	12	13	14	15	19	20
24	26	27	30	52	63	64	68
12x 0019 050103 7x 590.30.196.000 2x 0015 060553 2x 0912 050123 1x 773.34.028.000 1x 773.38.061.000 1x 773.38.061.050							
<b>+ WELLENDICHTRINGE / SEAL RING</b> 2x 0760 405560, 1x 0760 354771,      0760 142460							
<b>+ LAGER / BEARINGS</b> 2x 773.30.082.000,      0405 182213, 2x 546.32.095.000,      0625 062036, 1x 0625 062054,      0402 255215, 0625 061806,      0625 068050, 773.35.050.050.							

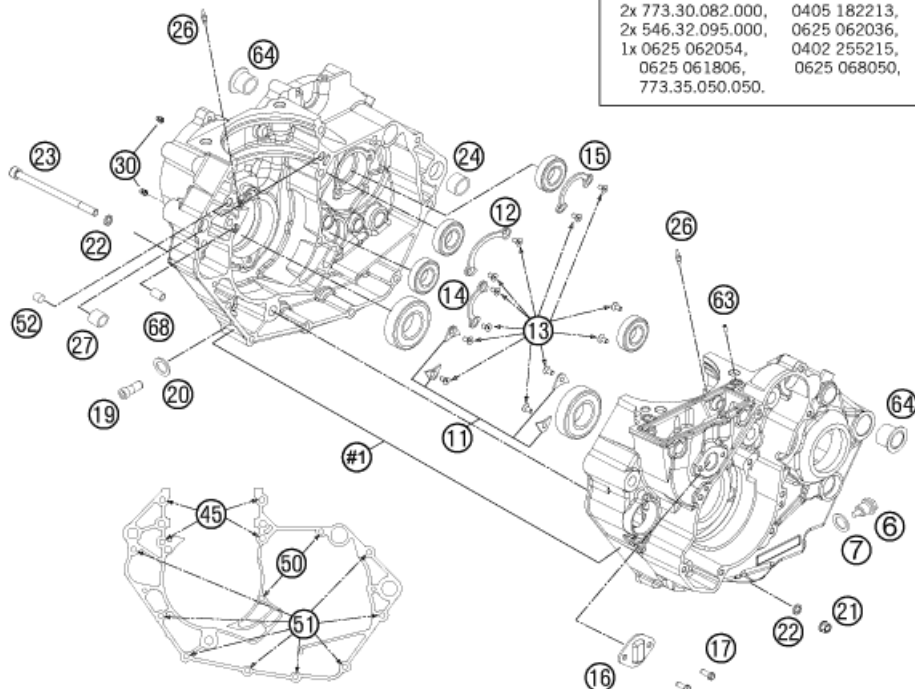

POS	PARTNUMBER	PARTNAME	PIECE
1	76330000044	ENGINE CASE CPL. W.TR.BEAR. 11	1
6	58030021000	OILDRAIN PLUG W.MAG. M 12X1,5	1
7	58038022000	CU-SEAL RING DIN7603-12X18X1,5	1
11	77330085000	BUSHING RETAINING PLATE	4
12	77333022100	BUSHING RETAINING PLATE	1
13	0019050106	INT. TORX FLAT HEAD M5X10 10.9	12
14	77334090000	BUSHING RETAINING PLATE	1
15	77333024100	BUSHING RETAINING PLATE	1
16	SXS07450245	SXS FACTORY RETAINING PLATE	1
17	0025050106	COLLAR SCREW M5X12 ISA30	2
19	0012080203	AH SCREW DIN6912-M 8X20	1
20	0603082121	SEAL RING CU DIN7603- 8X12X1	1
21	54630044000	COLLAR NUT M10 WS=13	1
22	50233041100	PAIR OF WASHERS M10 NORDLOCK	2
23	77203014000	ENGINE BRAC.SCR. M10X115	1
24	59030024000	DOWEL 17 X 19 X 12	1
26	60030064070	OIL JET 70 M6X0,75 WS8 03	2
27	54630027000	DOWEL BUSHING 13,8X11X12	1
30	59030058000	JET 100 BING(44-031/180) M4	2
45	77330067170	SCREW M7-1,0X70	4
50	0025060706	HH COLLAR SCREW M6X70 TX30	2
51	0025060556	HH COLLAR SCREW M6X55 TX30	8
52	0402080120	CYLINDER ROLLER ZRO. 8,0X12 M4	2
60	77330099000	GASKET SET 450/505 SX-F	1
63	77338029052	THROTTLE M5X10X1	1
64	76330010000	CASE BUSH	2
68	59030023000	DOWEL 6X8X11,5	1

117633010

C117633010

\* NEW PART      X ON DEMAND

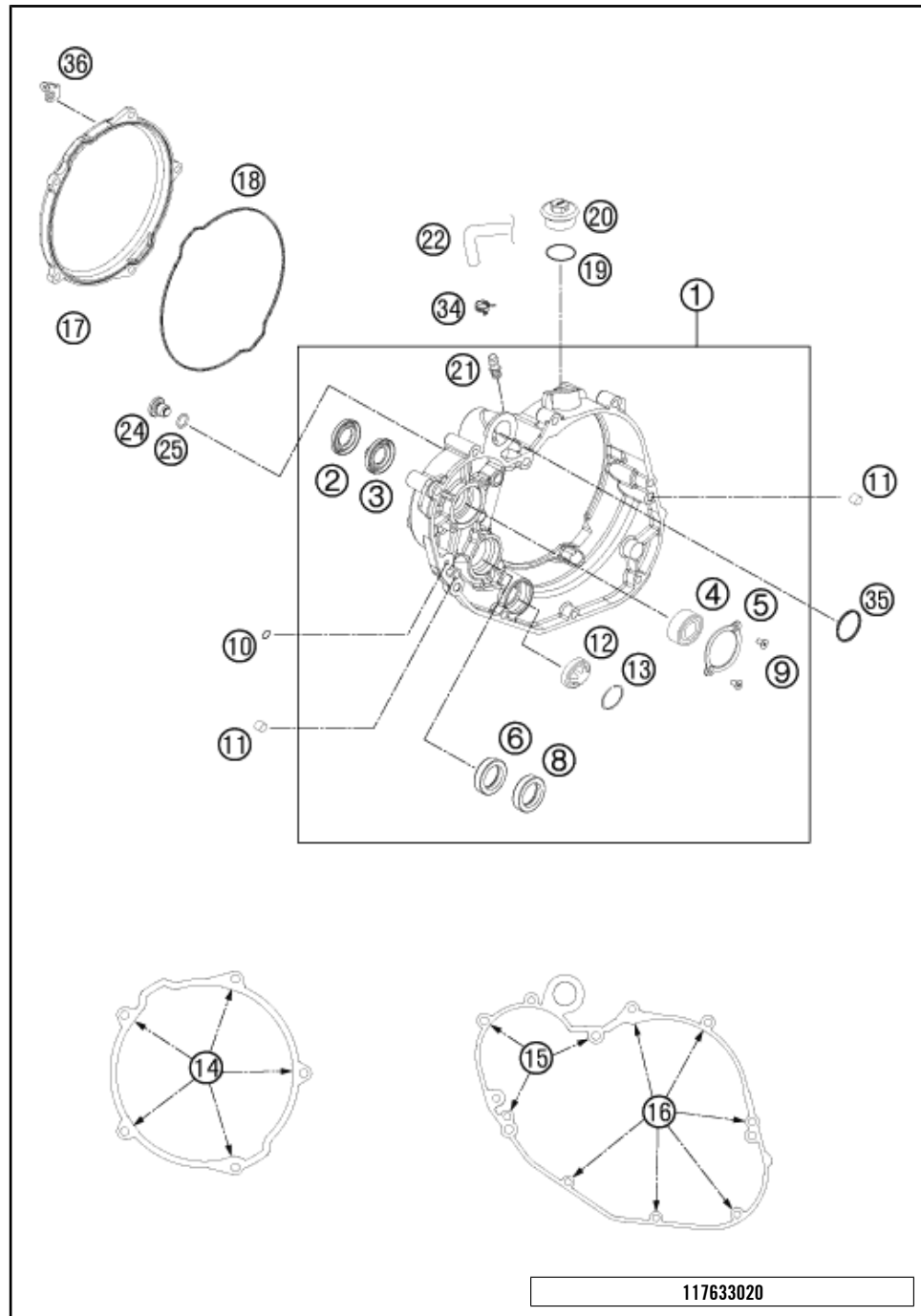

POS	PARTNUMBER	PARTNAME	PIECE
1	7633000104415	CLUTCH COVER GREY CPL.	1
2	77335057000	SHAFT SEAL RING 12x24x4	1
3	77335056000	SHAFT SEAL RING 12x24x4/5,5	1
4	0625062021	BALL BEARING 6202 C0 2RSH	1
5	77335064100	RETAINING PLATE FOR WAPUSTOCK	1
6	0760203071	SHAFT SEAL RING 20X30X7	1
8	0760253574	SHAFT SEAL RING 25x35x7 BSL VI	1
9	0019050106	INT. TORX FLAT HEAD M5X10 10.9	2
10	0770080015	O-RING 8,00X1,5 NBR 70	1
11	0402080120	CYLINDER ROLLER ZRO. 8,0X12 M4	2
12	59030019100	OIL LEVEL GLASS	1
13	61030019050	CIRCLIP OIL LEVEL GLASS 03	1
14	0025060206	HH COLLAR SCREW M6X20 TX30	5
15	77330067145	SCREW M7-1,0X45	3
16	0025060306	HH COLLAR SCREW M6X30 TX30	6
17	SXS09450235	CLUTCH COVER	1
18	77330027000	CLUTCH CASE GASKET	1
19	0770191015	O-RING 19,00X3,00 NBR	1
20	SXS05450200	SXS OIL PLUG	1
21	59030022100	BLEEDER FLANGE M12X1,5 WS=13	1
22	77330086100	ENGINE BREATHER TUBE	1
24	77336056095	SCREW PLUG	1
25	07700900151	O-RING 9x1,5 V75 SH DIN 3771	1
34	58431082100	YDNAC-CLAMP 10173 (16MM) '98	1
35	77335005000	QUAD-RING 28,3X1,78 VITON	1
36	77303026054	SPRING BRACKET	1

\* NEW PART X ON DEMAND

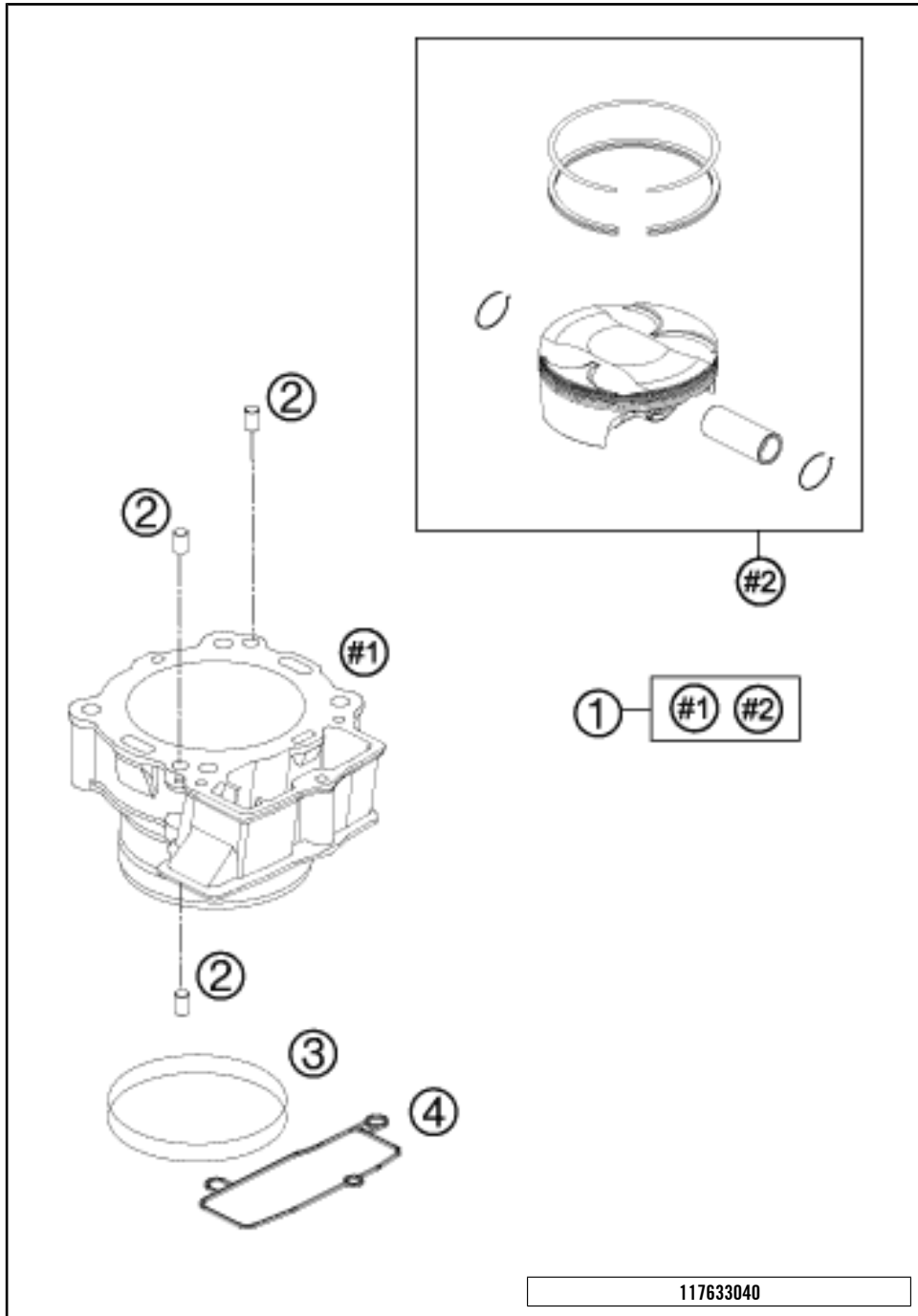

POS	PARTNUMBER	PARTNAME	PIECE
1	77330038000M06	CYLINDER + PISTON CPL.	1
2	0402080120	CYLINDER ROLLER ZRO. 8,0X12 M4	3
3	0770108018	O-RING 107,67x1,78 VITON	2
4	77330035000	GASKET GEAR CASE	1

117633040

C147633040

\* NEW PART X ON DEMAND

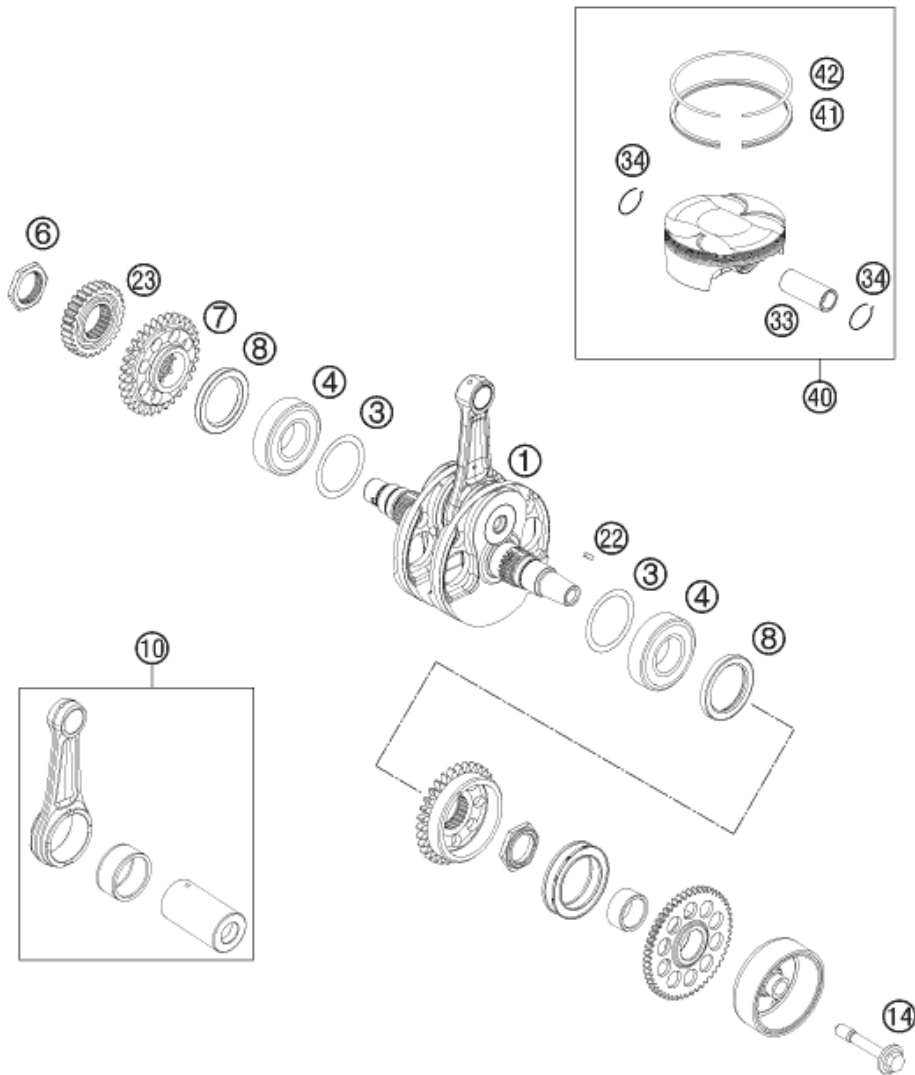

POS	PARTNUMBER	PARTNAME	PIECE
1*	77330018000M03	CRANKSHAFT CPL. 2014	1
3	0988304201	THRUST WASHER 30X42X0,1	x
3	0988304202	THRUST WASHER 30X42X0,2	x
3	0988304203	THRUST WASHER 30X42X0,3	x
4	76330082100	BEARING NJ_206_ECP_HN3C3HVA62	2
6	77330029000	COLLAR NUT M27X1	1
7	77330055110	DRIVE WHEEL AGZR KS Z=32	1
8	0760405560	SHAFT SEAL RING A40x55x6 VITON	2
10*	76330015144	CONNECTING ROD REPAIR SET	x
14	77339010100	FLYWHEEL SCREW	1
22	0888030037	WOODRUFF KEY DIN6888-3X3,7	1
23	77332023129	PRIMARY GEAR	1
33	77330033000M06	PISTON PIN	1
34	77330074000M06	CIRCLIP	2
40	77330007000M06	PISTON CPL. D=97MM	1
41	77330032000M06	OIL SCRAPER RING	1
42	77330030000M06	COMPRESSIONRING 450	1

127633060

C147633060

\* NEW PART

X ON DEMAND



**ACHTUNG !!!** Vor dem Einbau des Vergasers, Bedüsung kontrollieren. **CAUTION !!!** Before mounting the carburetor, check the jetting.

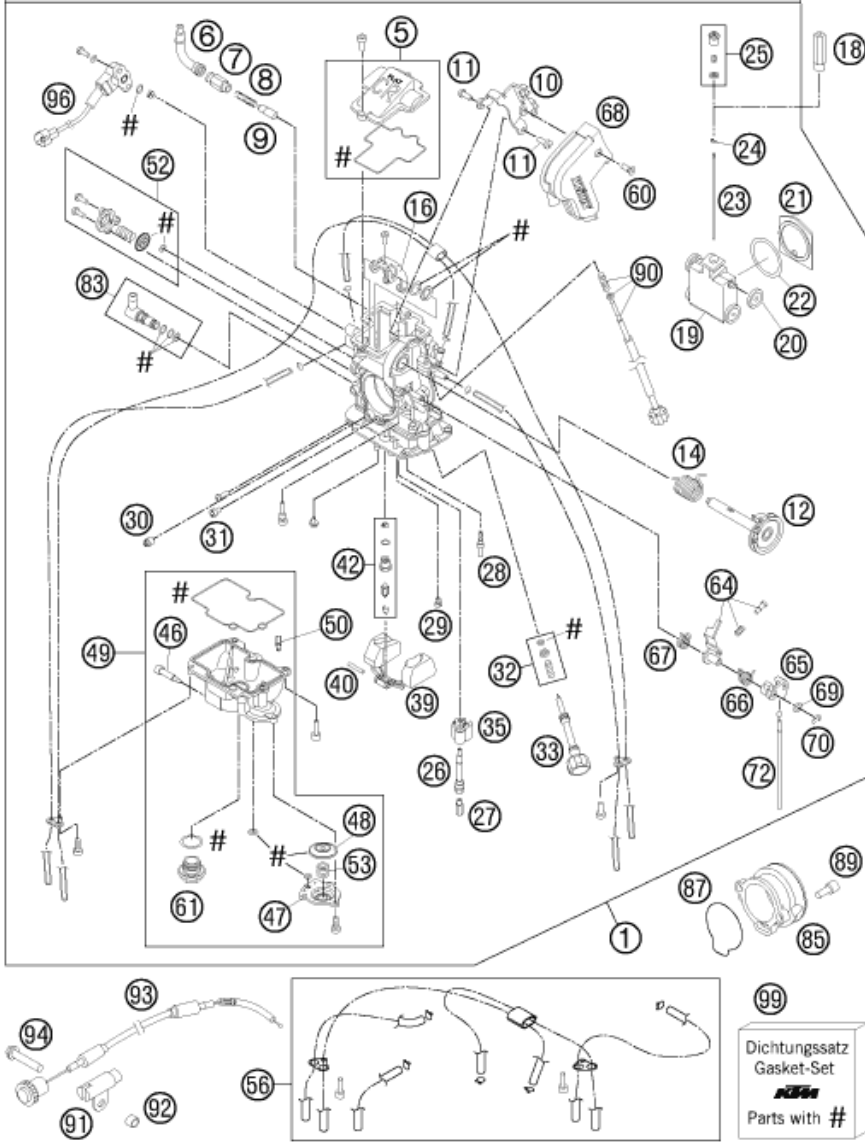

117633100

POS	PARTNUMBER	PARTNAME	PIECE
1	76331001000	CARBURETOR	1
5	57331027044	CARBURETOR COVER WITH GASKET	1
6	76302075000	SLEEVE	1
7	58502096044	CONNECT. COLD START CABLE CPL.	1
8	58502096003	CONNECTION CHOKE-CABLE SPRING	1
9	58502096002	CONNECTION CHOKE-CABLE PISTON	1
10	57331080000	BRACKET PLATE FOR THR. CABLE	1
11	57331055000	SCREW M 5 X 8	2
12	57331046000	THROTTLE SHAFT CPL.	1
14	57331046050	COIL SPRING THROTTLE SHAFT	1
16	57331035051	LINK ARM THROTTLE VALVE CPL.	1
18	59031029010	SLIDE STOP 03	1
19	57331035000	THROTTLE VALVE CPL.	1
20	59031035050	BUSHING THROTTLE VALVE	1
21	57331035153	GASKET PLATE THROTTLE VALVE 04	1
22	59031035052	GASKET WASHER THROTTLE VALVE	1
23	59031023200	JET NEEDLE KEIHIN OBDVT	1
23	59031034000	JET NEEDLE KEIHIN OBDTN	x
23	59031034400	JET NEEDLE KEIHIN OBDTP	x
23	59031034500	JET NEEDLE KEIHIN OBDTQ	x
23	59031034600	JET NEEDLE KEIHIN OBDTR	x
24	59031029000	BAR CLIP	1
25	57331032000	NEEDLE SET SCREW CPL.	1
26	59031121000	NEEDLE JET FCR-MX	1
27	54531623180	MAIN JET 180 KEIHIN	x
27	54531623182	MAIN JET 182 KEIHIN	x
27	54531623185	MAIN JET 185 KEIHIN	x
27	54531623188	MAIN JET 188 KEIHIN	x
27	54531623190	MAIN JET 190 KEIHIN	x
27	54531623192	MAIN JET 192 KEIHIN	x
27	54531623195	MAIN JET 195 KEIHIN	x
28	54531607042	IDLE JET 42 KEIHIN	x
28	54531607045	IDLE JET 45 KEIHIN	x
28	54531607048	IDLE JET 48 KEIHIN	1
29	59031051065	STARTER JET 65	x
29	59031051070	STARTER JET 70	x
29	59031051075	STARTER JET 75	x
29	59031051080	STARTER JET 80	x

C117633100

\* NEW PART X ON DEMAND

**ACHTUNG !!!** Vor dem Einbau des Vergasers, Bedüsung kontrollieren. **CAUTION !!!** Before mounting the carburetor, check the jetting.

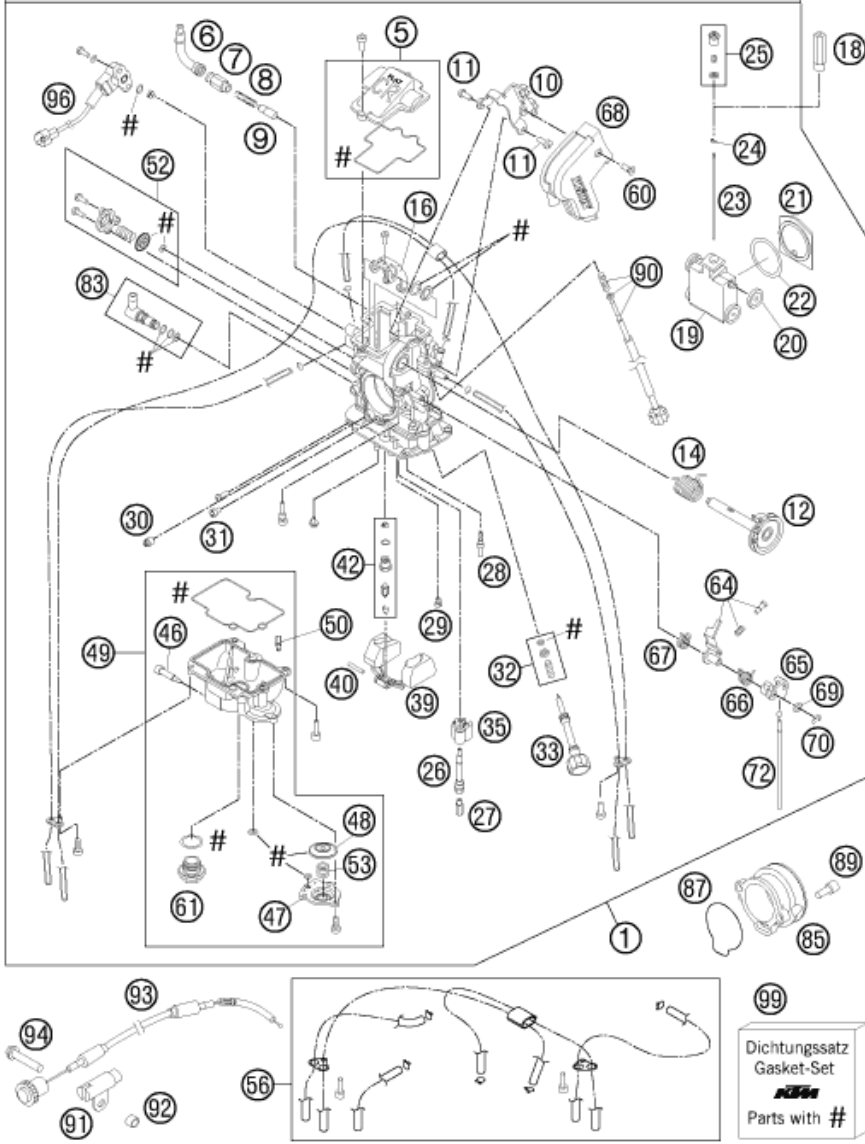

117633100

POS	PARTNUMBER	PARTNAME	PIECE
29	59031051085	STARTER JET 85	1
30	57331007100	IDLE AIR JET 100 KEIHIN	1
31	57331037200	MAIN AIR JET 200 KEIHIN	1
32	59031017100	ADJUST SCREW CPL. FCR-MX	1
33	59031017300	MIXT. CONTROL SCREW FACTORY 09	1
35	57331085000	BUFFER PLATE	1
39	57331009000	FLOAT CPL.	1
40	57331008000	ARM PIN FLOAT	1
42	57331020000	NEEDLE VALVE CPL.	1
46	76231155000	DRAIN SCREW + O-RING	1
47	57331060000	COVER ACCELERATOR PUMP	1
48	57331057100	DIAPHRAGM ACCELERATOR PUMP	1
49	78031011000	FLOAT CHAMBER CPL. 08	1
50	54631085000	JET POWER JET CLOSED KEIHIN	x
50	54631085040	JET POWER JET 40 KEIHIN	x
50	54631085050	JET POWER JET 50 KEIHIN	x
50	54631085060	JET POWER JET 60 KEIHIN	x
50	54631085070	JET POWER JET 70 KEIHIN	x
52	57331090000	AIR CUT VALVE 2002	1
53	59031059000	COIL SPRING	1
56	57331098000	BREATH.HOSE FCR-MX KEIHIN CPL.	1
60	0965050103	FLAT HEAD SCREW DIN0965-M 5X10	1
61	54531699000	PLUG M 18X1	1
64	57331062000	INTERMEDIATE LEVER CPL.	1
65	57331056000	LINK LEVER	1
66	SXS08250030	SXS ACCELERATION PUMP SPRING	1
67	57331159000	SPRING INTERMEDIATE LEVER	1
68	57331038000	CARBURETOR COVER	1
69	57331087000	WASHER LINK LEVER	1
70	57331084000	E-CLIP	1
72	57331061000	ROD ACCELERATOR PUMP	1
83	59031013044	HOSE CONNECTOR CPL.	1
85	76306040000	INTAKE FLANGE	1
87	59031040010	O-RING FOR INTAKE FUNNEL	1
89	0912050103	AH SCREW DIN0912-M 5X10	2
90	76231025000	STOP SCREW CPL.FCR-MX RALLY 07	1
91	58302095251	SLEEVE FOR CHOKE CABLE	1
92	50208020000	SPACER BUSHING 7X10X7,5	1

C117633100

\* NEW PART X ON DEMAND

**ACHTUNG !!!**  
Vor dem Einbau des Vergasers,  
Bedüsung kontrollieren.

**CAUTION !!!**  
Before mounting the carburetor,  
check the jetting.

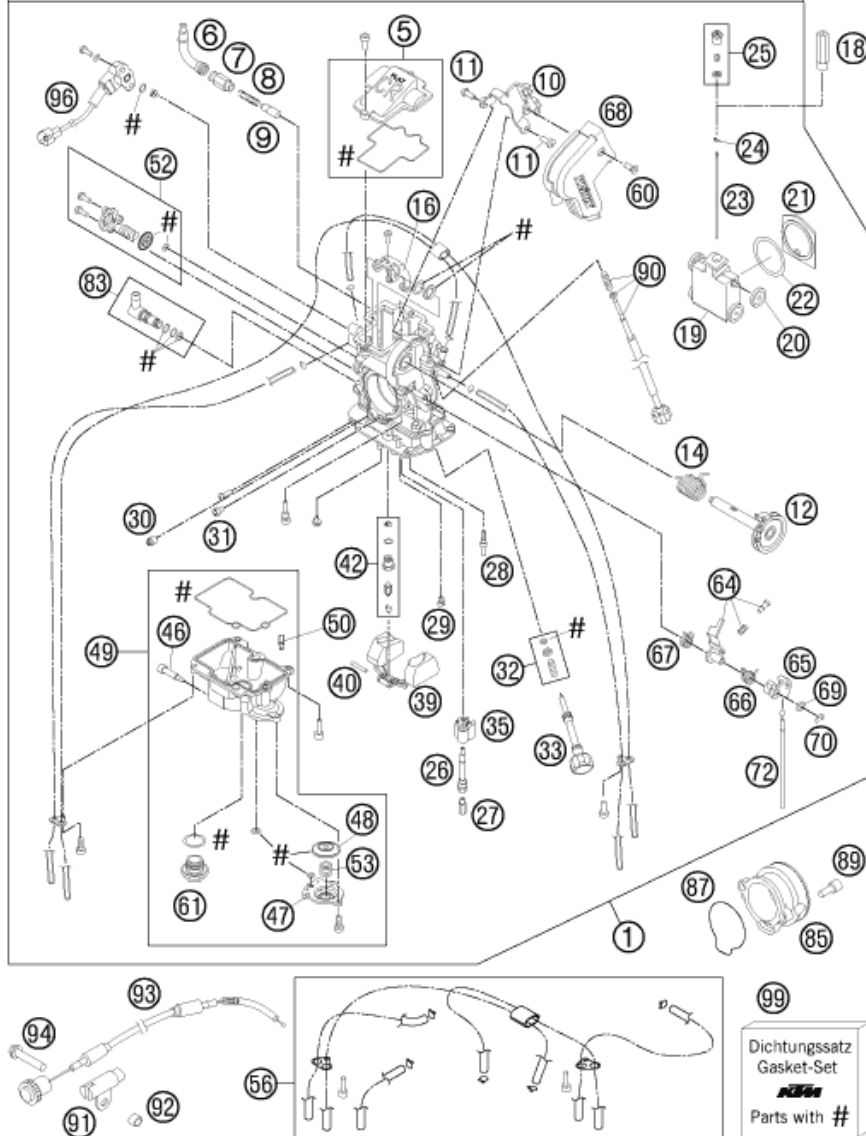

POS	PARTNUMBER	PARTNAME	PIECE
93	76202095000	CHOKE-CABLE l = 235 07	1
94	0025060406	HH COLLAR SCREW M6X40 TX30	1
96	57331077100	TPS-SENSOR FCRMX 320MM 03-04	1
99	57331099000	GASKET SET FCR-MX KEIHIN	1

117633100

C117633100

\* NEW PART

X ON DEMAND

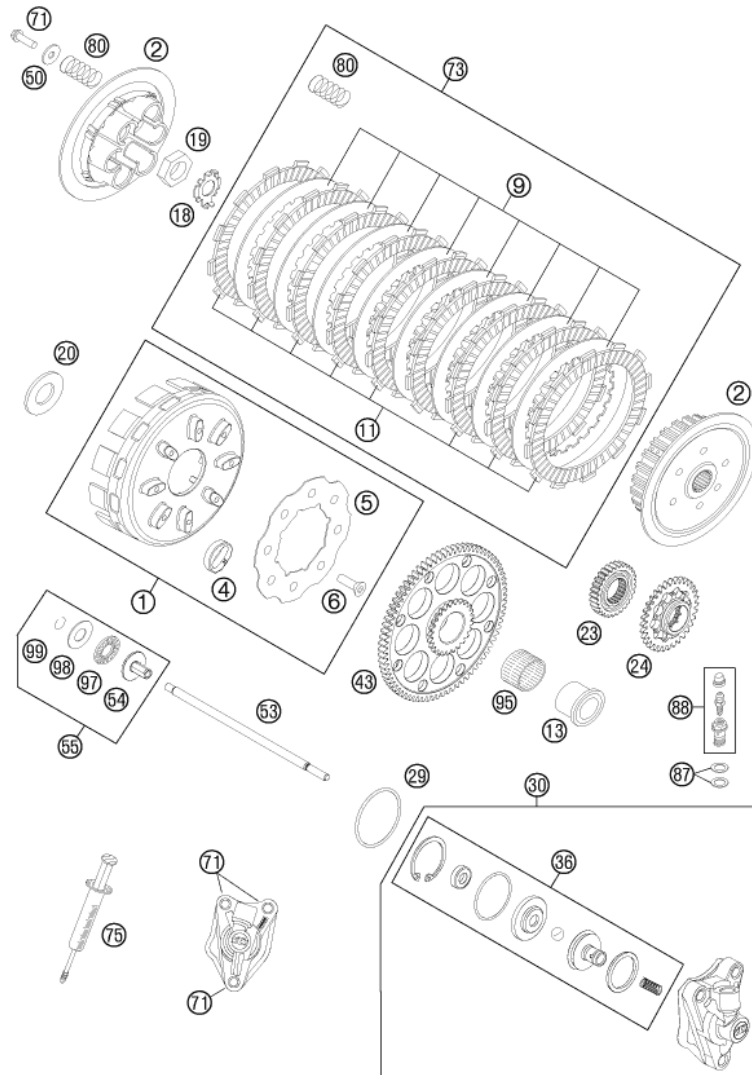

POS	PARTNUMBER	PARTNAME	PIECE
1	SXS08450030	OUTER CLUTCH HUB MILLED HINSON	1
2	SXS09450151	INNER CLUTCH HUB + PRESSURE PL	1
4	SXS08450034	DAMPING RUBBER	8
5	SXS08450032	RETAINING PLATE 08	1
6	SXS08450033	FLAT HEAD SCREW	8
9	77332010000	INTERMEDI. DISC STEEL	8
11	77332011000	LINING DISC 2,7MM	9
13	77332015100	INNER RING	1
18	77332018000	RETAINING PLATE	1
19	0936181505	HEXAGON NUT DIN0936-M18X1,5 R.	1
20	77332017100	WASHER 21,7X38X4 07	1
23	77332023129	PRIMARY GEAR	1
24	77330055110	DRIVE WHEEL AGZR KS Z=32	1
29	0770380020	O-RING 38,00X2,00 NBR 70 SH	1
30	77332061044	OUTPUT CYLINDER CPL.	1
36	77332066000	PISTON CPL.	1
43	77332024074	* CLUTCH WHEEL T=74 07	1
50	50232050000	WASHER 6,2X18X2	6
53	77332054100	PUSH ROD 07	1
54	77332057100	PRESSURE PIECE	1
55	77332057144	PRESSURE PIECE CPL.	1
71	0025060256	HH COLLAR SCREW M6X25 TX30	9
73	77332011010	CLUTCH-KIT 450/505 SX-F 07-13	1
75	50329050000	VENT INJEKTION HYDR. CLUTCH	1
80	77332005000	CLUTCH SPRING	6
87	42013226000	CU-SEAL RING DIN7603-10X16X1	2
88	62513020000	BLEEDER SCREW CPL. 05	1
95	56532095000	NEEDLE BEARING K26X30X22ZW.KSE	1
97	54637097200	AXIAL NEEDLE BEARING AXK 1226	1
98	54637098200	AXIAL WASHER AS1226 12X26X1	1
99	0993012000	CIRCLIP DIN7993-RW12	1

117633210

C117633210

\* NEW PART

X ON DEMAND

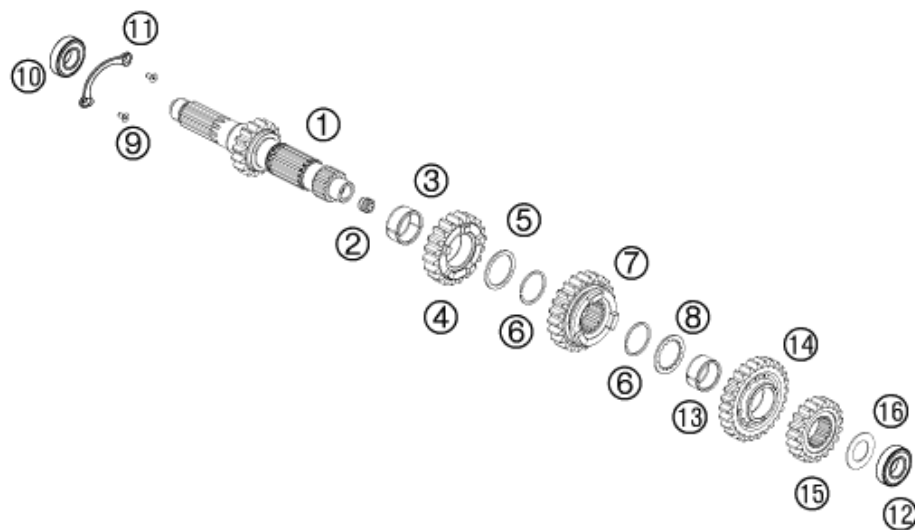

POS	PARTNUMBER	PARTNAME	PIECE
1*	77333301000M01	MAIN SHAFT	1
2	77333001160	GUIDE BUSHING	1
3	0405242813G	NEEDLE BEAR.K 24X28X13 DIVIDED	1
4*	77333303000M01	IDLER GEAR 3 G	1
5	78033031000	STOP DISK 26 X 32 X 1,5	1
6	0417025000	CIRCLIP SW25	2
7*	77333304000M01	SLIDING GEAR 4.G	1
8	78033033000	STOP DISK 23 X 32 X 1,5	1
9	0019050106	INT. TORX FLAT HEAD M5X10 10.9	2
10	0625062054	BALL BEARING 6205 C3 NTN	1
11	77333022100	BUSHING RETAINING PLATE	1
12	0625062036	BALL BEARING 6203 RSH C3	1
13	0405222613	NEEDLE BEAR. K 22X26X13 TN	1
14*	77333305000M01	IDLER GEAR 5G	1
15*	77333302000M01	SOLID GEAR	1
16	56033030000	STOP DISC 17,2X30X1	1

117633330

C147633330

\* NEW PART

X ON DEMAND

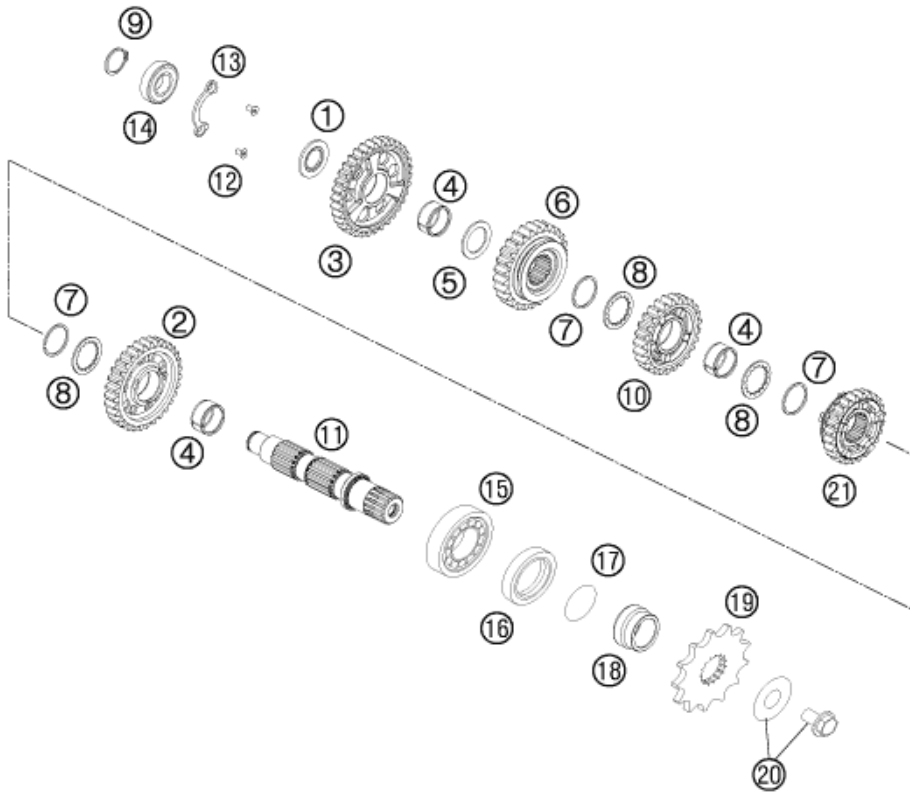

POS	PARTNUMBER	PARTNAME	PIECE
1	77333045000	STOP DISC 17,1X32X2,6	1
2*	77333312000M01	IDLER GEAR 2.G	1
3*	77333311000M01	IDLER GEAR 1.G	1
4	0405222613	NEEDLE BEAR. K 22X26X13 TN	3
5	77333044000	STOP DISC 22,2X32X1,5	1
6*	77333313000M01	SLIDING GEAR 3RD G	1
7	0417025000	CIRCLIP SW25	3
8	78033033000	STOP DISK 23 X 32 X 1,5	3
9	0471170015	CIRCLIP DIN 0471-17X1, 5	1
10*	77333314000M01	IDLER GEAR 4TH. G.	1
11*	83533310000M02	COUNTERSHAFT	1
12	0019050106	INT. TORX FLAT HEAD M5X10 10.9	2
13	77333024100	BUSHING RETAINING PLATE	1
14	0625062036	BALL BEARING 6203 RSH C3	1
15	0402255215	CYL.ROLLER BEARING NUP205E C3	1
16	0760354771	SHAFT SEAL RING 35X47X7 TC	1
17	0770250015	O-RING 25,00X1,50 NBR 70	1
18	83533019000	SPACER BUSHING	1
19	58033029014	ENGINE SPROCKET 14 T	x
19	58033029015	ENGINE SPROCKET 15 T	1
19	58033029016	ENGINE SPROCKET 16 T	x
19	58033029017	ENGINE SPROCKET 17 T	x
20	59033034044	SCREW 10.9+SPRING WASHER	1
21*	77333315000M01	SLIDING GEAR 5TD G	1

117633360

C147633360

\* NEW PART

X ON DEMAND

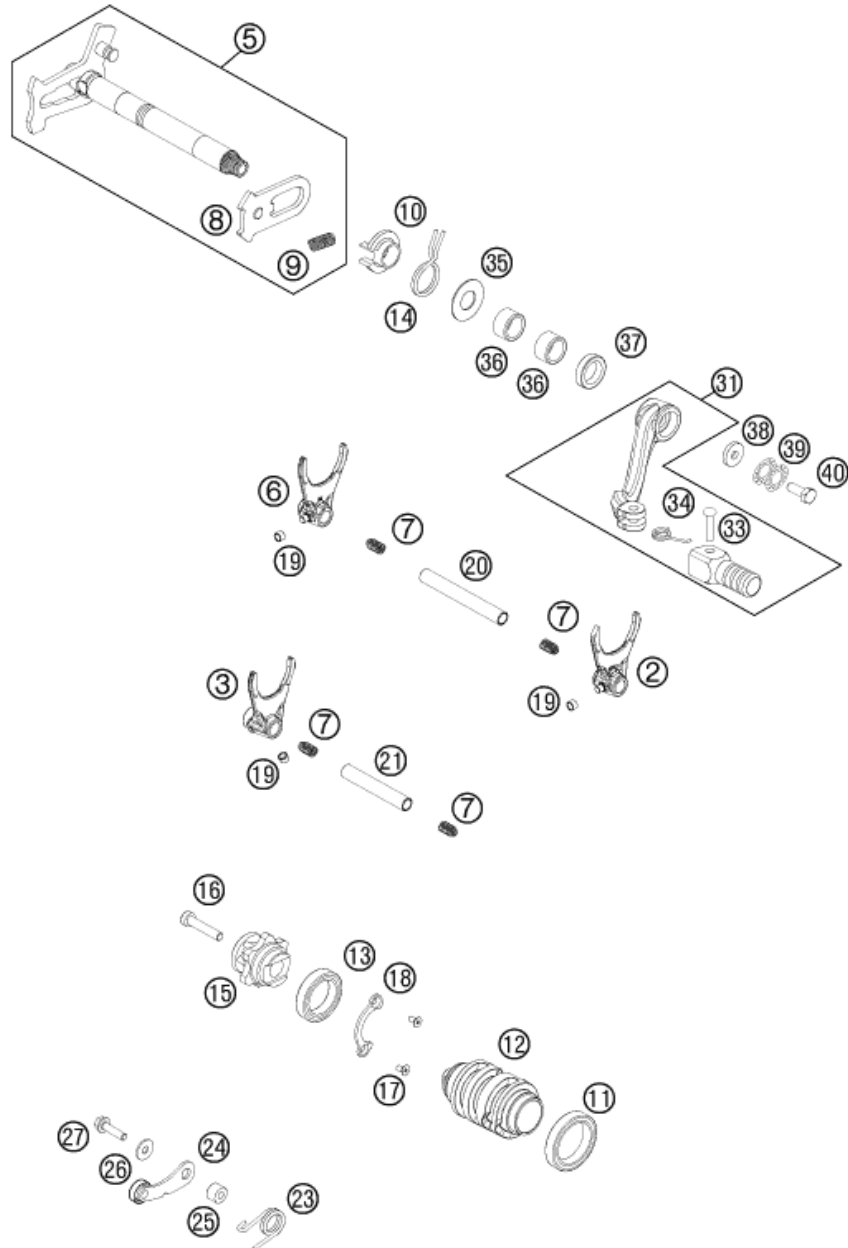

117633410

POS	PARTNUMBER	PARTNAME	PIECE
2	77334002100M01	SHIFTING FORK 2ND/4TH GEAR	1
3	77334003100M01	SHIFTING FORK 3RD/5TH GEAR	1
5	77334005044	SHIFT SHAFT CPL. 07	1
6	77334001100M01	SHIFTING FORK 1ST.GEAR	1
7	58038023200	PRESSURE SPRING 0,9MM	4
8	54634008044	SLIDING PLATE CPL.	1
9	56534013100	TENSIONING SPRING 0,8MM	1
10	54634020000	SPRING GUIDE	1
11	0625061806	BALL BEARING 61806	1
12	77334012100	SHIFT ROLLER 5G 08	1
13	0625618050	BALL BEARING 61805 C3	1
14	54834014000	RETURN SPRING 03	1
15	77334015000	SHIFT LOCATING DRUM CPL.	1
16	0912060303	AH SCREW DIN0912-M 6X30	1
17	0019050106	INT. TORX FLAT HEAD M5X10 10.9	2
18	77334090000	BUSHING RETAINING PLATE	1
19	50334018100	SHIFTING ROLLER 6X8X5,2	3
20	77334020000	SHIFT RAIL	1
21	77334019000	FRONT SHIFT RAIL	1
23*	60034023200	ARRESTING LEVER SPRING	1
24	50334024144	LOCATING LEVER CPL. 08	1
25	54634052300	SLEEVE FOR LOCKING LEVER	1
26	0021050003	WASHER DIN9021-A 5,3	1
27	0025050206	HH COLLAR SCREW M5X20 TX30	1
31	76334031000	SHIFT LEVER CPL. RALLY 11	1
33	54634031050	BOLT 6X25 FOR SHIFT LEVER	1
34	75034032000	SHIFTING LEVER SPRING	1
35	54634050000	STOP DISK 14X30X1	1
36	54632095000	NEEDLE BEAR.HK 1412 14X20X12	2
37	0760142460	SHAFT SEAL RING 14X24X6 B	1
38	50232050001	STEEL WASHER 6,4X17X3	1
39	50233041000	PAIR OF WASHERS M 6 NORDLOCK	1
40	59009062016	SPECIAL SCREW M6X16 WS=8 10.9	1

C147633410

\* NEW PART

X ON DEMAND

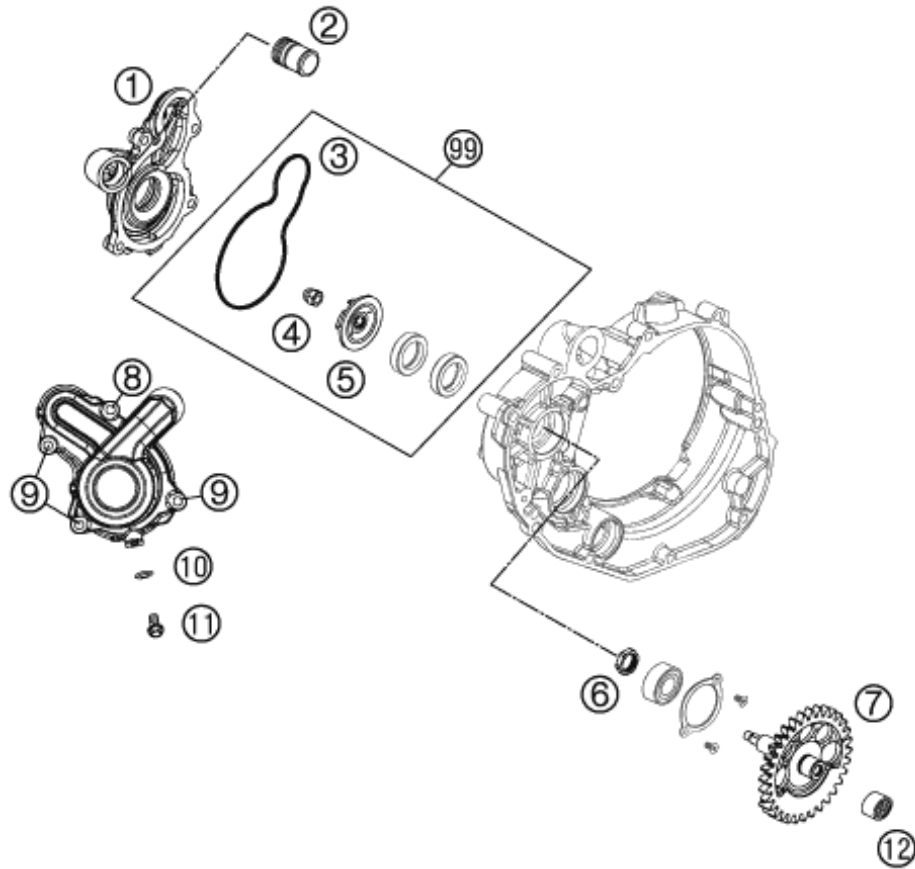

POS	PARTNUMBER	PARTNAME	PIECE
1	8353505200015	WATER-PUMP COVER	1
2	58030010200	SCREW IN NOZZLE M20X1,5	1
3	77335053000	WATER-PUMP GASKET 06	1
4	61230045000	CAP NUT M6 STAINLESS STEEL	1
5	77335055100	WATER-PUMP WHEEL 07	1
6	77330056050	NUT M14 X 1 FOR BALANCER . 06	1
7	77330056200	BALANCER GEAR KS 32-T 07	1
8	0025060556	HH COLLAR SCREW M6X55 TX30	1
9	0025060166	HH COLLAR SCREW M6X16 TX30	3
10	0603061001	CU-SEAL RING DIN7603-6X10X1	1
11	0025060106	HH COLLAR SCREW M6X10 TX30	1
12	77335050050	NEEDLE BEARING RNA 4900	1
99	77335055010	WATER PUMP REP. KIT 07-12	x

117633510

C117633510

\* NEW PART

X ON DEMAND



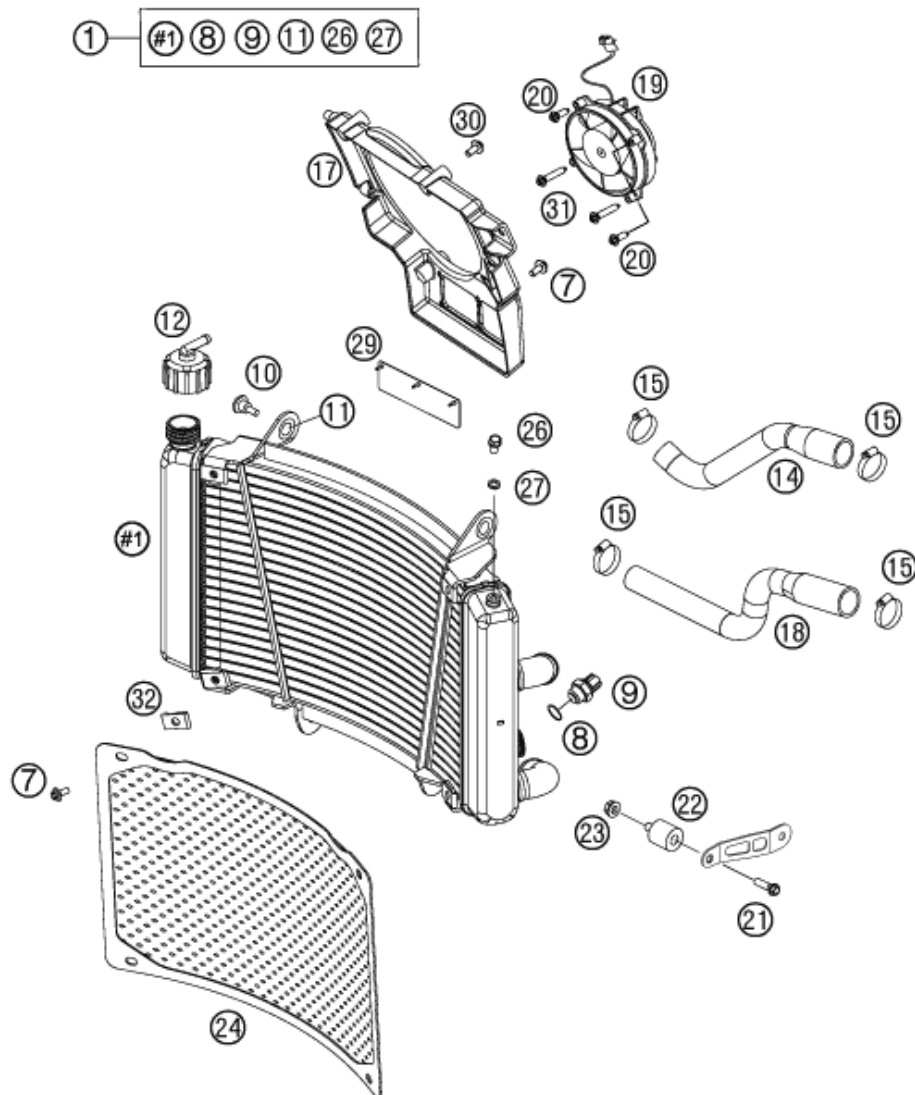

POS	PARTNUMBER	PARTNAME	PIECE
1	76235010000	RADIATOR "VW 1182" 07	1
7	0024060136	HH COLLAR SCREW M6X13 TX30	3
8	0770017015	O-RING 17X1,5 NB75	1
9	58035045000	THERMOSWITCH 80-85 DG	1
10	60035001000	SPECIAL SCREW M6X21 WS=8	2
11	41001052000	RUBBER SLEEVE D=12MM	2
12	62535009000	RADIATOR CAP 1,4 BAR	1
14	76335026000	RADIATOR HOSE 1	1
15	76235028000	HOSE CLAMP GEMI 20-32 MM	4
17	76235044000	FAN COWL 07	1
18	76335026001	RADIATOR HOSE 2	1
19	60035041000	FAN L/S 03	1
20	0017060203	EJOT PT SCREW K60X20 WS=6	2
21	0024060106	HH COLLAR SCREW M6X10 TX30	2
22	43205062100	RUBBER GROMMET 20X15-M6X10 (1)	2
23	0985060003	SELF LOCK. NUT DIN0985-M 6	2
24	76235034044	RADIATOR PROTECTOR 07	1
26	0025060106	HH COLLAR SCREW M6X10 TX30	1
27	60035048000	ALU-GASKET 6X10X1.5	1
29	62635044050	FAN CLACK RUBBER 08	2
30	0024060156	HH COLLAR SCREW M6X15 TX30	1
31	0017060303	SPECIAL SCREW T60 6X30 WS=6	2
32	54603048100	RANGE CHANGE METAL NUT M6	4

117633530

C117633530

\* NEW PART

X ON DEMAND

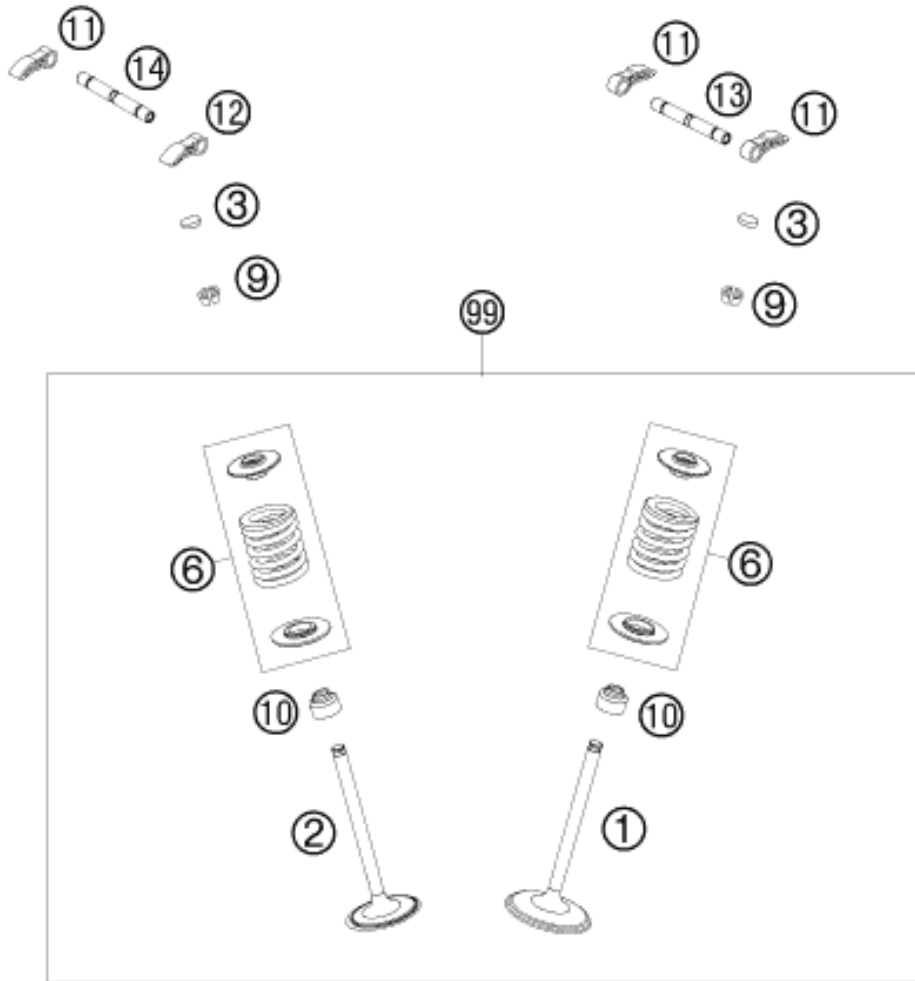

POS	PARTNUMBER	PARTNAME	PIECE
1	77336030300	INTAKE VALVE	2
2	77336031000M03	EXHAUST VALVE	2
3	77036035172	SHIM D=8,9/1,72	X
3	77036035176	SHIM D=8,9/1,76	X
3	77036035180	SHIM D=8,9/1,80	X
3	77036035184	SHIM D=8,9/1,84	X
3	77036035188	SHIM D=8,9/1,88	X
3	77036035192	SHIM D=8,9/1,92	X
3	77036035196	SHIM D=8,9/1,96	X
3	77036035200	SHIM D=8,9/2,00	X
3	77036035204	SHIM D=8,9/2,04	X
3	77036035208	SHIM D=8,9/2,08	X
3	77036035212	SHIM D=8,9/2,12	X
3	77036035216	SHIM D=8,9/2,16	X
3	77036035220	SHIM D=8,9/2,20	X
3	77036035224	SHIM D=8,9/2,24	X
3	77036035228	SHIM D=8,9/2,28	X
3	77036035232	SHIM D=8,9/2,32	X
3	77036035236	SHIM D=8,9/2,36	X
3	77036035240	SHIM D=8,9/2,40	X
3	77036035244	SHIM D=8,9/2,44	X
3	77036035248	SHIM D=8,9/2,48	X
3	77036035252	SHIM D=8,9/2,52	X
3	77036035256	SHIM D=8,9/2,56	X
3	77036035260	SHIM D=8,9/2,60	X
6	77336128044	VALVE SPRING KIT 09	4
9	77336033100	VALVE COLLET 07	8
10	59036027000	VALVE-STEM SEALING RACING	4
11	77336060100	VALVE LEVER	3
12	77336160000	VALVE LEVER	1
13	77336056000	INTAKE VALVE LEVER SHAFT	1
14	77336057000	EXHAUST VALVE LEVER SHAFT	1
99	77336030210	VALVE KIT 450/505 SX-F 09-12	1

107733610

C117633610

\* NEW PART

X ON DEMAND

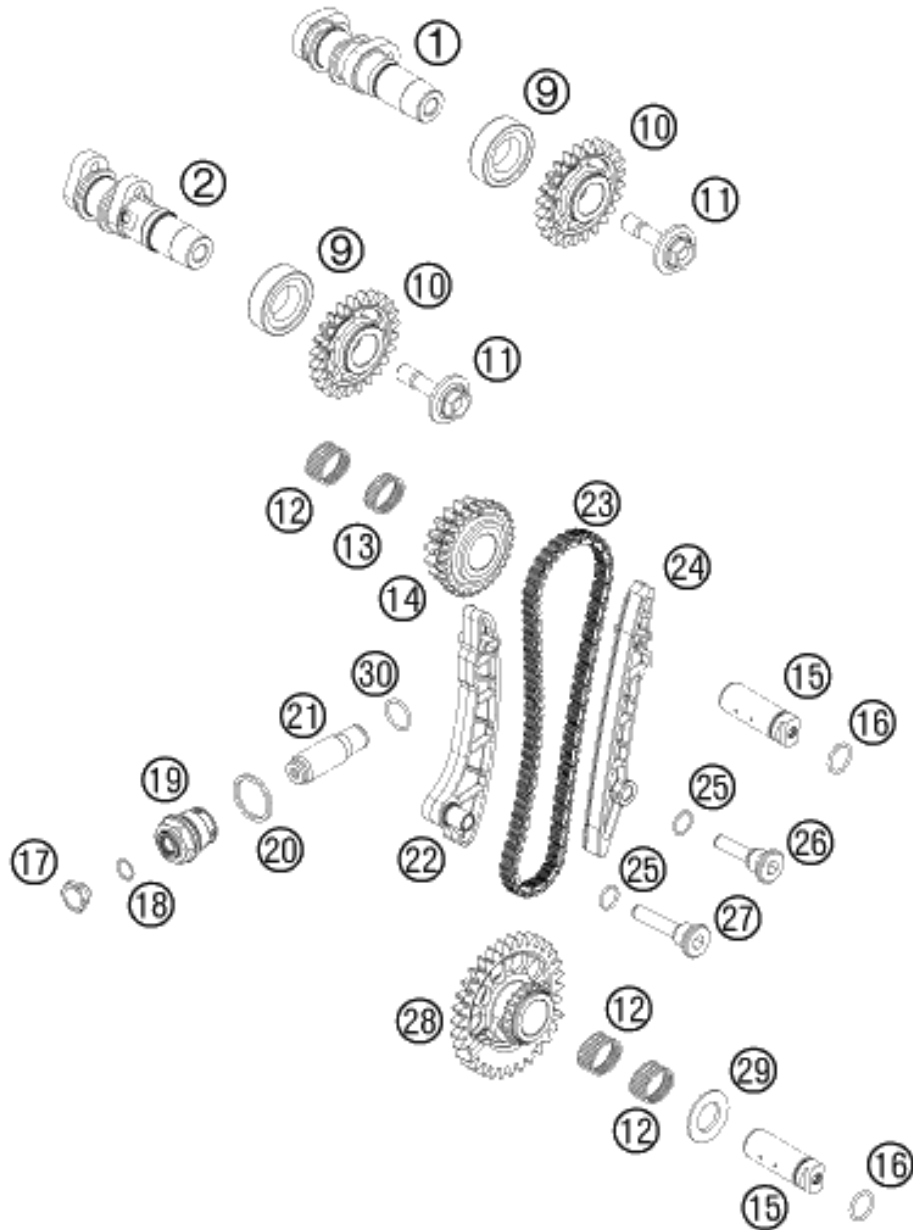

POS	PARTNUMBER	PARTNAME	PIECE
1	77336009300	CAMSHAFT INTAKE	1
2	77336010444	CAMSHAFT EXHAUST CPL.	1
9	0402174012	CYL.ROLL BEARING RNU203ETVP2	2
10	77336011000	CAMSHAFT GEAR 07	2
11	77336076100	SCREW MW M10-1,0X38	2
12	0405182213	NEEDLE BEAR K 18X22X13	3
13	0405182210	NEEDLE BEARING K 18X22X10 02	1
14	77336070177	DOUBLE GEAR W.CPL. Z18/Z30 07	1
15	77336075100	AXLE FOR TIMING VALVE 06	2
16	0770015018	O-RING 15,00X1,80	2
17	77336008010	HOLDING BOLT	1
18	0770010010	O-RING 10,00X1,00 NBR 70 SH	1
19	77336008000	HOLDING BOLT M24X1,5	1
20	0603242920	CU SEAL-RING DIN7603 A24X29X2	1
21	77036003000	CHAIN ADJUSTER HYD. 05	1
22	77336002177	TENSIONER RAIL CPL. 07	1
23	77336013100	TIMING CHAIN 07	1
24	77336001100	GUIDE RAIL 07	1
25	0770012015	O-RING 12,00X1,50 NBR	2
26	77336091000	BUSHING SCREW	1
27	77336091100	BUSHING SCREW	1
28	77330057200	BALANCER GEAR	1
29	77330058000	STOP DISC 18/32/1,4/2,7	1
30	0770180020	O-RING 18,00X2,00 NBR 70	1

117633620

C117633620

\* NEW PART

X ON DEMAND

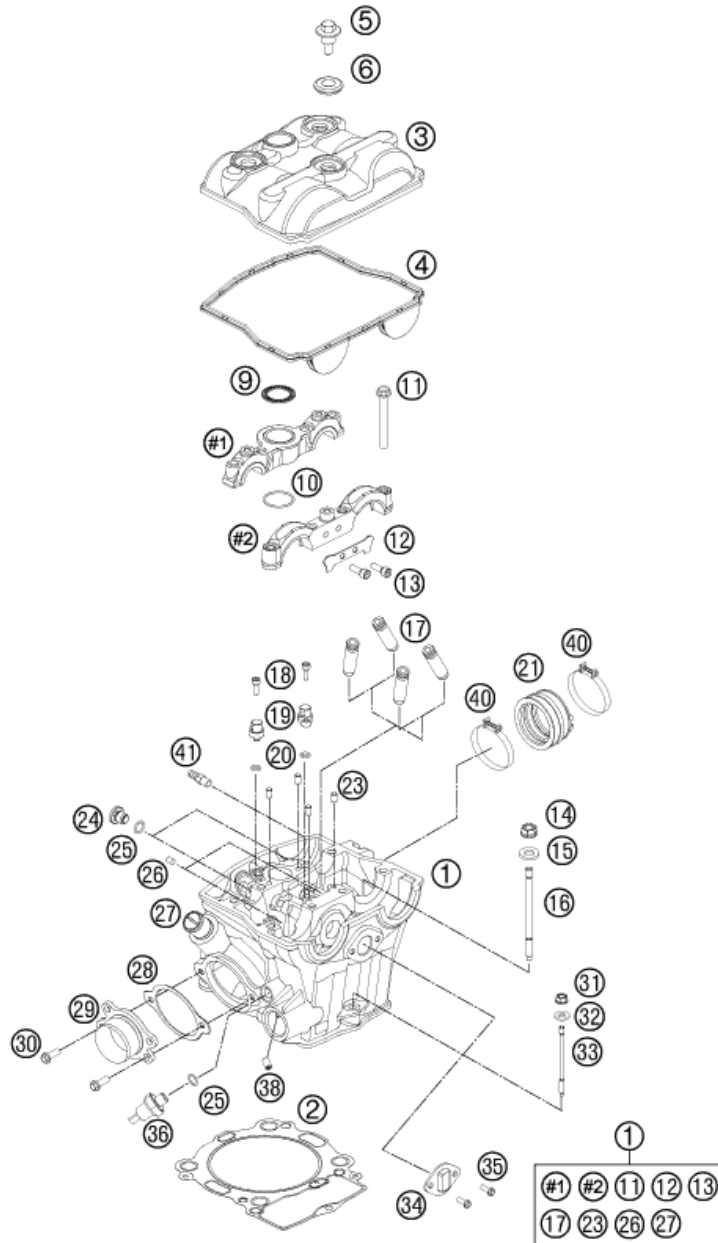

137633630

POS	PARTNUMBER	PARTNAME	PIECE
1	77336020344	CYLINDER HEAD CPL.	1
2	77330036000	CYL. HEAD GASKET S=0,5 06	1
3	77336052100	VALVE COVER	1
4	77336053000	VALVE COVER GASKET	1
5	77336054150	VALVE COVER SCREW	3
6	77036054050	RUBBER GASKET FOR SCREW 05	3
9	77336053050	GASKET SPARK-PLUG SHAFT	1
10	0770250015	O-RING 25,00X1,50 NBR 70	1
11	77330067138	SCRW M7-1,0X38	8
12	77336020040	BUSHING HOLDER	1
13	0912050103	AH SCREW DIN0912-M 5X10	2
14	77336088210	COLLAR NUT M10X1,25 SW13	4
15	77336089010	WASHER 19X10,5X2,5	4
16	77330044100	STUD SCREW M10	4
17	61236026001	VALVE GUIDE EXHAUST 08	4
18	0912040123	AH SCREW DIN0912-M 4X12	2
19	77338046000	OIL JET	2
20	0770060015	O-RING 1,5x6	2
21	76336044000	CONNECTION RUBBER	1
23	0402050080	CYLINDER ROLLER ZRO 5X8	4
24	77336056095	SCREW PLUG	2
25	07700900151	O-RING 9x1,5 V75 SH DIN 3771	3
26	59030196000	PLUG 00	2
27	58030010200	SCREW IN NOZZLE M20X1,5	1
28	77336041000	GASKET EXHAUST FLANGE	1
29	76336039000	EXHAUST FLANGE CPL. RALLY	1
30	0025060166	HH COLLAR SCREW M6X16 TX30	2
31	77336088106	COLLAR NUT M6X1 SW8	1
32	0125060003	WASHER DIN0125-A 6,4	1
33	77330043000	STUD SCREW M6	1
34	SXS07450245	SXS FACTORY RETAINING PLATE	1
35	0025050106	COLLAR SCREW M5X12 ISA30	1
36	60038091100	OIL-PRESSURE SWITCH LC8 04	1
38	77338029012	THROTTLE M6X10X0,6	1
40	78006027000	HOSE CLAMP 45-65MM	2
41	58336020090	VACUUM CONNECTION M 6X1	1

C147633630

\* NEW PART

X ON DEMAND

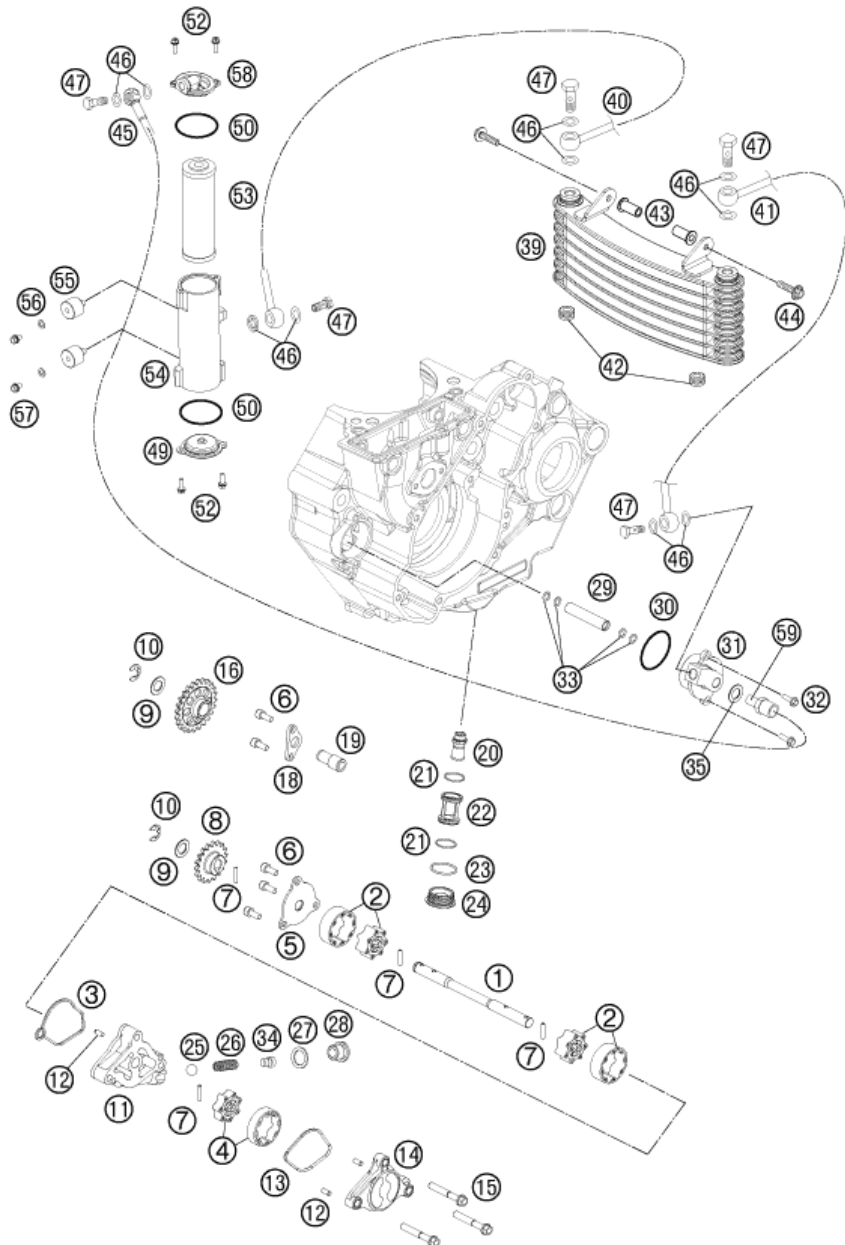

127633810

POS	PARTNUMBER	PARTNAME	PIECE
1	77338002100	OIL PUMP SHAFT	1
2	77338107100	SUCTION PUMP CPL.	2
3	77338012000	GASKET PRESSURE PUMP CASE	1
4	77338207100M01	PRESSURE PUMP PEEK D=9MM	1
5	77338004100	PUMP COVER 07	1
6	0912050123	AH SCREW DIN0912-M 5X12	5
7	0402031580	NEEDLE ROLLER DIN5402 3X15,8	4
8	77338001100	OIL PUMP GEAR 18-T	1
9	77338023000	WASHER 10,2X18X1	2
10	0799080000	TAB WASHER DIN6799 RS8	2
11	77338010100	PRESSURE PUMP CASE	1
12	0402040980	NEEDLE ROL.DIN5402 NRB 4X9,8	3
13	77338112000	GASKET PRESSURE PUMP COVER	1
14	77338013100	PRESSURE PUMP COVER	1
15	0025060406	HH COLLAR SCREW M6X40 TX30	3
16	77338000150	OILPUMP IDLER GEAR 24-T.	1
18	77338061050	LOCK WASHER BEARING BOLT	1
19	77338061000	BEARING BOLT	1
20	77338022000	OIL INTAKE SNORKEL	1
21	0770023015	O-RING 23,00X1,50 NBR 70	2
22	77338016100	OIL SCREEN CPL.	1
23	0770300020	O-RING 30X2,0 FPM	1
24	77338019100	PLUG SCREW	1
25	0401100000	BALL D=10 DIN 5401	1
26	77338026100	COIL SPRING	1
27	0603142016	CU-SEAL RING 14X20X1,5 LC8 02	1
28	60038033050	PLUG SCREW M14X1,5 ALU AH	1
29	76338041010	OIL LINE CONNECTOR	1
30	07703305178	O-RING 33,05X1,78	x
30	0770275025	O-RING 27,5X2,5 NBR	x
31	76338050100	OIL LINE CONNECTOR	1
32	0025060166	HH COLLAR SCREW M6X16 TX30	2
33	0770012021	O-RING 12X2 VITON GREEN	4
34	76338027000	SWIVEL PRESSURE REGULATOR	1
35	0603101420	COPPER GASKET 10,2X14X2 MM 01	1
39	76238000000	OIL COOLER	1
40	76338035000	OIL PIPE RIGHT	1
41	76338034000	OIL PIPE LEFT	1

C147633810

\* NEW PART

X ON DEMAND

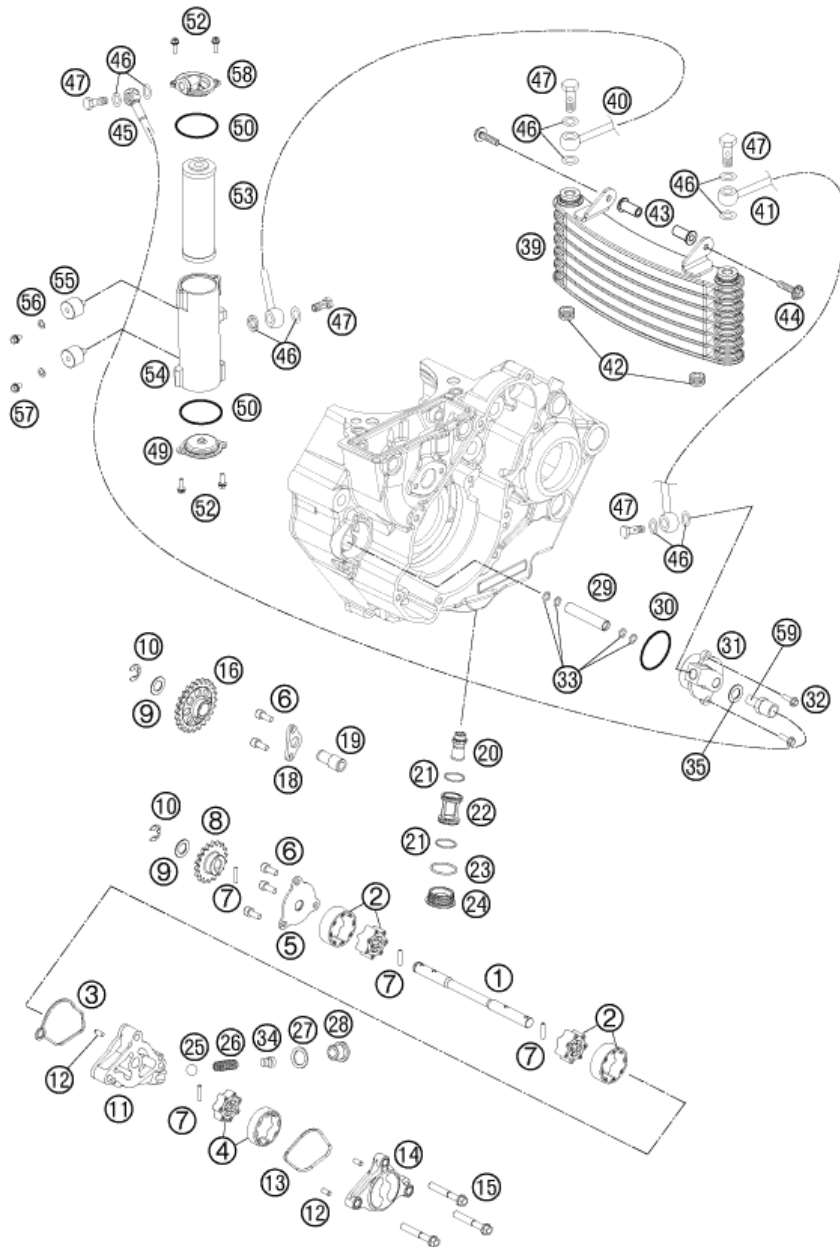

POS	PARTNUMBER	PARTNAME	PIECE
42	31008060000	RUBBER SLEEVE D=8MM OPEN	2
43	76212090070	INSULATED SCREW JOINT M6	2
44	0014060203	HH COLLAR SCREW M 6X20 WS=8	2
45	76338036000	OIL PIPE BELOW	1
46	0603100141	COPPER GASKET DIN7603-10X14X1	10
47	54313025000	HOLLOW SCREW M10 X 1	5
49	59038041000	OIL FILTER COVER RACING	1
50	07700390261	O-RING 39,34X2,62	2
52	0025050166	HH COLLAR SCREW M5X16 TX30	4
53	83538005000	OIL FILTER	1
54	76338043000	OIL FILTER CASE	1
55	76303004000	SILENTBLOCK 20X10 M6X10	2
56	50233041000	PAIR OF WASHERS M 6 NORDLOCK	2
57	0015060083	HH COLLAR SCREW M 6X8 WS=8	2
58	76338141000	OILFILTER CAP	1
59	76338037000	ADAPTER ALU METRIC	1

127633810

C147633810

\* NEW PART

X ON DEMAND

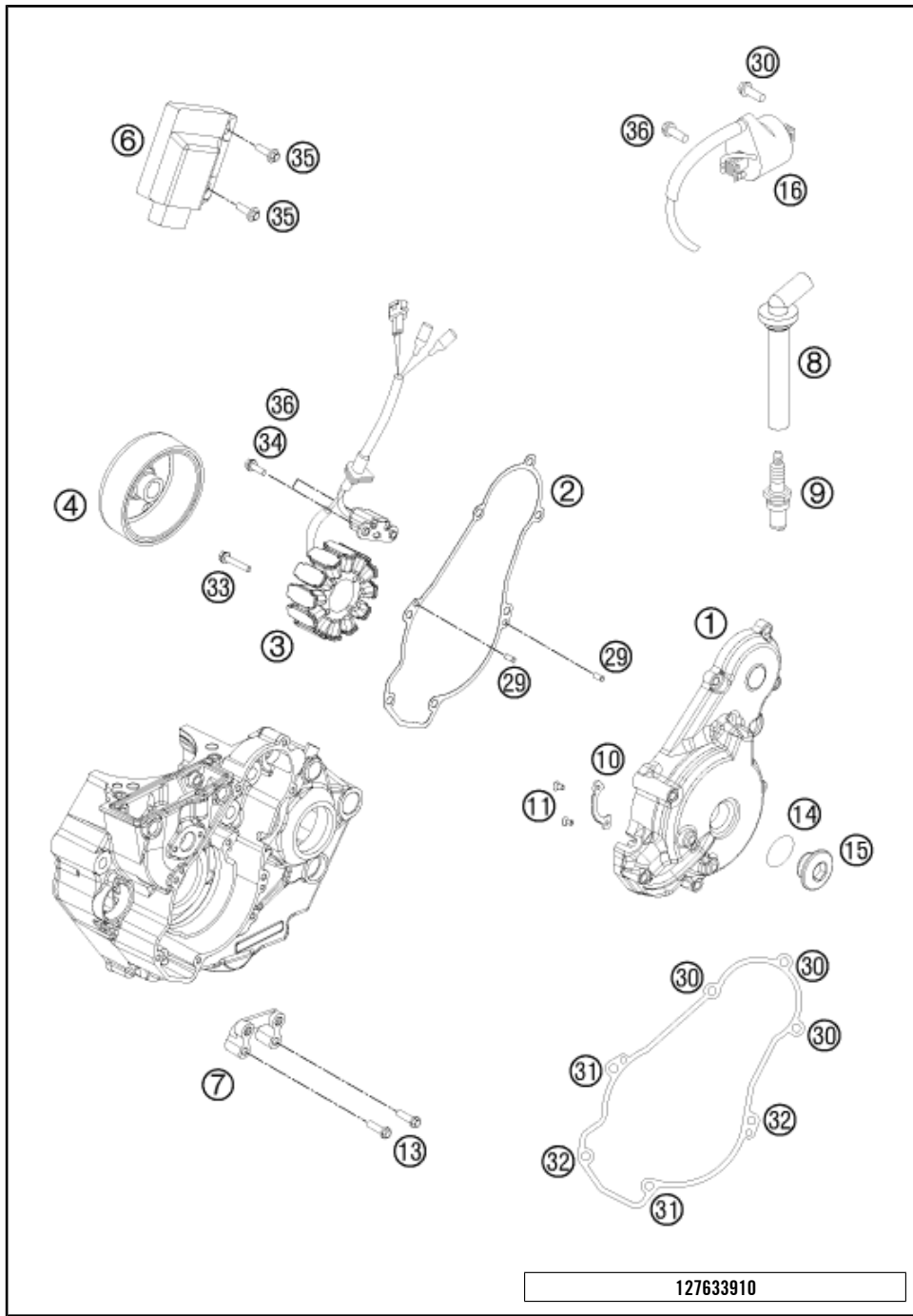

POS	PARTNUMBER	PARTNAME	PIECE
1	76330002000	IGNITION COVER	1
2	77330040100	IGNITION COVER GASKET	1
3	76339004000	STATOR	1
4	83039005000	ROTOR	1
6	76339031000	CDI UNIT KOKUSAN 450 RALLY 11	1
7	77339035100M01	ADAPTER PULSER COIL	1
8	77339090000	SPARK PLUG NGK-XD05EMGK	1
9	77039093000	SPARK PLUG NGK CR9EKB '05	1
10	77334090000	BUSHING RETAINING PLATE	1
11	0019050106	INT. TORX FLAT HEAD M5X10 10.9	2
13	0025050256	HH COLLAR SCREW M5X25 ISA30	2
14	07700240251	O-RING 24X2,5 VITON	1
15	7723000206004	FACTORY IGNITION COVER PLUG OR	1
16	59039006000	IGNITIONCOIL "IG5128"	1
29	0402040980	NEEDLE ROL.DIN5402 NRB 4X9,8	2
30	0025060206	HH COLLAR SCREW M6X20 TX30	5
31	0025060556	HH COLLAR SCREW M6X55 TX30	2
32	0025060456	HH COLLAR SCREW M6X45 TX30	2
33	0025050306	HH COLLAR SCREW M5X30 TX30	3
34	0025050166	HH COLLAR SCREW M5X16 TX30	x
35	0023060123	COLLAR SCREW M6X12 TX	2
36	0025060166	HH COLLAR SCREW M6X16 TX30	x

127633910

C137633910

\* NEW PART X ON DEMAND

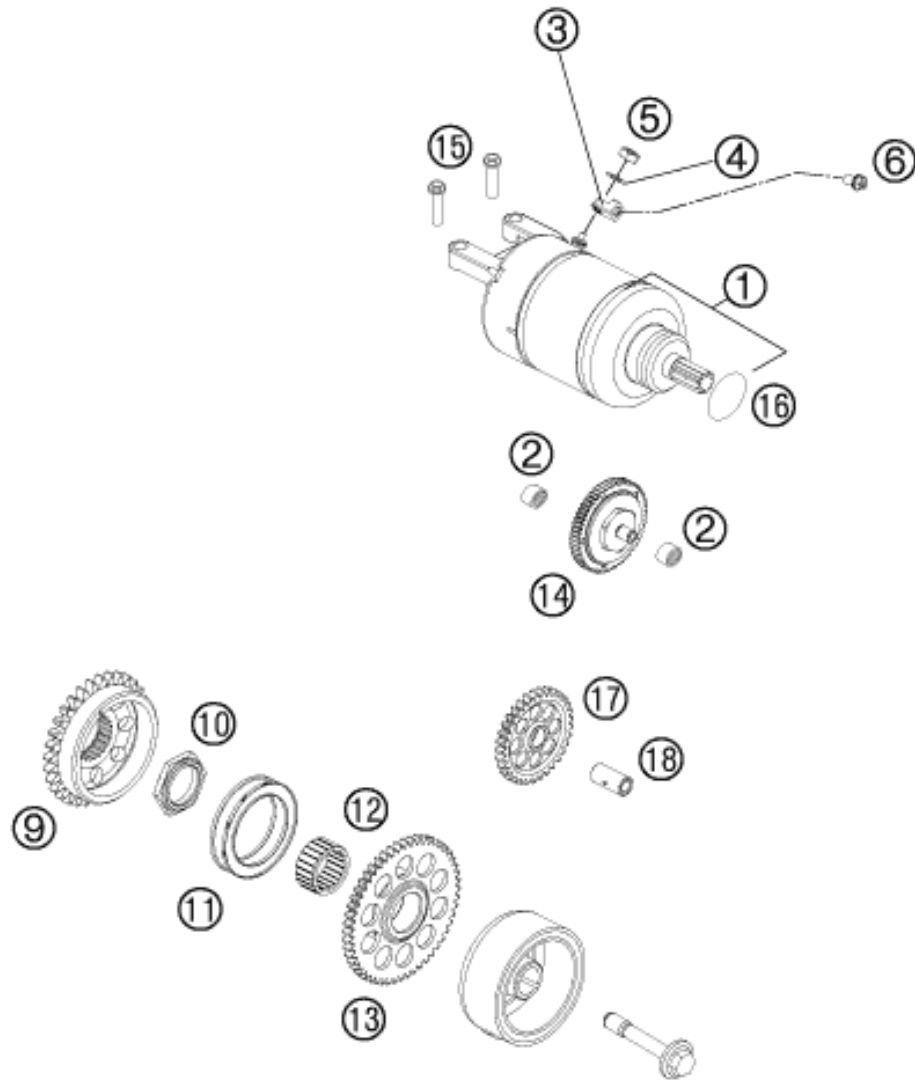

POS	PARTNUMBER	PARTNAME	PIECE
1	77340001000	E-STARTER ENGINE CPL. 07	1
2	0618081210	NEEDLE BUSH HK 0810 DIN 618	2
3	76211059010	STARTER CABLE LUG	1
4	0125060003	WASHER DIN0125-A 6,4	1
5	0985060003	SELF LOCK. NUT DIN0985-M 6	1
6	0025060106	HH COLLAR SCREW M6X10 TX30	1
9	77330055160	% DRIVE WHEEL AGZR KS Z=32	1
10	77330029000	COLLAR NUT M27X1	1
11	H25015301	FREE WHEEL CLUTCH MECHANISM 97	1
12	0405253216	NEEDLE BEAR. K25X32X16	1
13	77340015100	STARTING GEAR Z=52	1
14	77340016100	TORQUE LIMITER CPL.	1
15	0015060203	HH COLLAR SCREW M 6X20 WS=8	2
16	0770250030	O-RING 25,00X3,00 NBR 70	1
17	77340022100	INTERMEDIATE STARTING GEAR	1
18	77340028000	BEARING BOLT	1

117634010

C117634010

\* NEW PART

X ON DEMAND



A large, empty rectangular box with a thin black border, occupying the majority of the page. It is intended for the user to write their notes for the '450 RALLY 2014' event.

A large, empty rectangular box with a thin black border, occupying the majority of the page. It is intended for handwritten notes.



WWW.KTM.COM



KTM-Sportmotorcycle AG  
5230 Mattighofen, Austria  
[www.ktm.com](http://www.ktm.com)



**KTM**\_POWERPARTS

**KTM**\_POWERWEAR

**KTM**\_ORIGINAL SPARE PARTS



3CM089280NEN

Art. Nr.: 3CM089280NEN 19. Jun 2013