

OWNER'S MANUAL 2010

1190 RC8 EU/UK

1190 RC8 AUS

1190 RC8 FR

1190 RC8 JP

Art. no. 3211523en



KTM

DEAR KTM CUSTOMER

Congratulations on your decision to purchase a KTM motorcycle. You are now the owner of a state-of-the-art sports motorcycle that will give you a great deal of pleasure during your ownership if you service and maintain it accordingly.

We wish you a lot of enjoyment in riding this vehicle.

Please enter the serial numbers of your vehicle below.

Vehicle identification number/type label (☛ p. 16)	Dealer's stamp
Engine number (☛ p. 17)	
Key number (☛ p. 16)	

The owner's manual contained the latest information for this model at the time of going to print. However, it is never possible to exclude small deviations arising from further development in design and construction.

All specifications are non-binding. KTM Sportmotorcycle AG specifically reserves the right to modify or delete technical specifications, prices, colors, forms, materials, services, designs, equipment, etc., without prior notice and without specifying reasons, to adapt these to local conditions, as well as to stop production of a particular model without prior notice. KTM accepts no liability for delivery options, deviations from illustrations and descriptions, as well as misprints and other errors. The models portrayed partly contain special equipment that does not form part of the regular scope of delivery.

© 2009 KTM-Sportmotorcycle AG, Mattighofen Austria

All rights reserved

Reproduction, even in part, as well as copying of all kinds, is permitted only with the express written permission of the copyright owner.



ISO 9001(12 100 6061)



According to the international quality management standard ISO 9001, KTM uses quality assurance processes that lead to the maximum possible quality of the products.













Issued by: TÜV Management Service



REG.NO. 12 100 6061

KTM-Sportmotorcycle AG
5230 Mattighofen, Austria

MEANS OF REPRESENTATION	7	Notes/warnings on the combination instrument.....	30
IMPORTANT INFORMATION	8	Overview of ROAD mode.....	34
VIEW OF VEHICLE.....	12	Odometer menu ODO/Trip 1	35
View of vehicle, front left side.....	12	Odometer menu ODO/Trip 2	36
View of vehicle, rear right side	14	FUELDISTANCE menu	37
LOCATION OF SERIAL NUMBERS	16	FUEL RANGE menu.....	38
Vehicle identification number/type label	16	DISTANCE TO Next Service menu	39
Key number	16	Overview of RACE mode	40
Engine number.....	17	LAPSTOGO menu	41
Fork part number.....	17	TOPSPEED menu	42
Shock absorber part number	18	LAP/BESTLAP/LastLap menu.....	43
Steering damper part number	18	LAP/BESTLAP/TopSpeed menu.....	44
CONTROLS	19	Total distance menu in Race mode RACEODO.....	45
Clutch lever	19	Overview of SET-UP mode.....	46
Hand brake lever	19	SET-UP menu	48
Light switch	20	CHANGE MODE menu	49
Headlight flasher switch.....	20	SET CLOCK menu	50
Turn signal switch	21	SETTINGS menu	51
Horn button	21	SHIFT RPMS menu	52
Ignition/steering lock	22	LAP menu, LAP BLANK T button	53
Emergency OFF switch.....	22	SET NUM LAPS menu	54
Electric starter button	23	TRIP F RESET menu	55
immobilizer.....	23	UNITS menu.....	56
Combination instrument - overview.....	24	SET KM/MILES menu	57
Combination instrument - function buttons on handlebar	25	SET °C/°F menu	58
Combination instrument - activation and test	26	OPTIONS menu.....	59
Display	27	TPMS menu.....	60
Info display.....	28	OUTERTEMP menu	61
Indicator lamps.....	29	Displaying lap times	66

Displaying maximum speed	67	Braking	93
Setting ROAD or RACE mode.....	68	Stopping, parking.....	94
Setting the clock with SET CLOCK	68	Refueling.....	95
Adjusting shift speed RPM1/2	69	SERVICE SCHEDULE.....	97
Setting the blank time of the LAP button LAP BLANK T.....	70	Service schedule	97
Setting the number of laps SET NUM LAPS	72	MAINTENANCE WORK ON FRAME AND ENGINE.....	100
Setting the fuel reserve display TRIPF RESET	73	Jacking up motorcycle front.....	100
Setting the kilometers/miles SET KM/MILES	74	Taking front of motorcycle off work stand.....	100
Setting the temperature unit SET °C/°F	75	Jacking up motorcycle at the rear.....	101
Switching the external temperature display on/off.....	75	Taking the rear from the workstand	101
Opening the filler cap	77	Fork/shock absorber.....	102
Closing the filler cap.....	78	Adjusting the compression damping of the fork	102
Supporting strap.....	78	Adjusting the rebound damping of the fork.....	103
Seat lock	79	Adjusting the spring preload of the fork	104
Tool set	79	Bleeding fork legs.....	105
Helmet lock	80	Compression damping of the shock absorber	106
Passenger footrests.....	80	Adjusting the low-speed compression damping of the shock absorber	106
Shift lever.....	81	Adjusting the high-speed compression damping of the shock absorber	107
Foot brake lever.....	82	Adjusting the rebound damping of the shock absorber.....	108
Side stand	82	Adjusting the spring preload of the shock absorber 	109
TIPS ON PUTTING INTO OPERATION	83	Steering damper.....	111
Advice on first use.....	83	Adjusting the steering damper	111
Running the engine in.....	84	Vehicle level	113
Loading the vehicle	85	Adjusting front vehicle level 	114
RIDING INSTRUCTIONS	87	Adjusting the vehicle level at the rear	116
checks to be made before putting into operation.....	87	Footrest position.....	117
Starting	88	Adjusting footrest position.....	117
Starting up	89		
Shifting, riding.....	90		

Adjusting shift lever stub.....	120	Removing the passenger seat.....	154
Adjusting shift lever.....	120	Mounting the passenger seat.....	154
Adjusting the foot brake lever stub.....	124	Mounting the helmet lock on the vehicle.....	155
Adjusting the foot brake lever.....	125	Removing the battery 	155
Checking free travel of foot brake lever.....	125	Installing the battery 	157
Checking for chain dirt.....	126	Recharging the battery 	159
Cleaning the chain.....	126	Changing the main fuse.....	161
Checking the chain tension.....	128	Changing the fuses of individual power consumers.....	163
Adjusting the chain tension.....	129	Changing the low beam bulb.....	165
Checking the chain, rear sprocket and engine sprocket.....	131	Changing the high beam bulb.....	168
Checking the front brake discs.....	133	Changing the parking light bulb.....	171
Checking the rear brake disc.....	134	Checking the headlight setting.....	174
Adjusting the basic position of the hand brake lever.....	135	Adjusting the headlamp range.....	174
Checking the front brake fluid level.....	135	Activating/deactivating ignition key.....	175
Topping up brake fluid of front brake 	136	Cooling system.....	179
Brake linings.....	137	Checking the coolant level.....	179
Checking the front brake linings.....	138	Filling the cooling system compensating tank.....	180
Checking the rear brake fluid level.....	139	Adjusting basic position of clutch lever.....	182
Adding rear brake fluid 	139	Checking fluid level of hydraulic clutch.....	182
Checking the rear brake linings.....	141	Correcting fluid level of hydraulic clutch.....	183
Removing the front wheel 	142	Checking the play in the throttle cable.....	184
Installing the front wheel 	144	Adjusting the play in the throttle cable 	185
Removing the rear wheel 	146	Handlebar height.....	185
Installing the rear wheel 	147	Adjusting the handlebar height.....	186
Checking rear hub cush drive 	150	Rear frame position.....	188
Checking the tire condition.....	150	Adjusting the rear frame position.....	189
Checking the tire pressure.....	152	Checking the engine oil level.....	193
Removing the seat.....	153	Changing engine oil and filter, cleaning oil screen 	194
Fitting the seat.....	153	Draining engine oil, cleaning oil screens 	194

Removing the oil filter 	197
Installing the oil filter 	199
Filling up with engine oil 	199
Adding engine oil	201
TROUBLESHOOTING	203
IMMOBILIZER BLINK CODE	206
ENGINE CONTROL BLINK CODE	208
CLEANING	214
Cleaning motorcycle	214
CONSERVATION FOR WINTER OPERATION	216
Conservation for winter operation	216
STORAGE	217
Storage	217
Putting into operation after storage	218
TECHNICAL DATA - ENGINE	219
Capacity - engine oil	220
Capacity - coolant	220
TECHNICAL DATA - ENGINE TIGHTENING TORQUES	221
TECHNICAL DATA - CHASSIS	224
Lighting equipment	225
Tires	226
Capacity - fuel	226
TECHNICAL DATA - FORK	227
TECHNICAL DATA - SHOCK ABSORBER	228
TECHNICAL DATA - CHASSIS TIGHTENING TORQUES	230
SUBSTANCES	233
AUXILIARY SUBSTANCES	237
STANDARDS	239
INDEX	240

Symbols used

The following explains the meaning of specific symbols.



Identifies an expected reaction (e.g. of an operation or a function).



Identifies an unexpected reaction (e.g. of an operation or a function).



All jobs marked with this symbol require specialist knowledge and technical understanding. In the interests of your own safety, have these jobs done in an authorized KTM-RC8 workshop! There, your motorcycle will be handled optimally by specially trained experts with the necessary special tools.



Identifies a page reference (more information is provided on the specified page).

Formats used

The type formats used are explained here.

Specific name

Identifies a name.

Name®

Identifies a protected name.

Brand™

Identifies a trademark.

Use definition

KTM sport motorcycles are designed and constructed to meet the normal demands of regular road and race track operation, but not for use on dirt roads.



Info

The motorcycle is authorized for public road traffic in the homologous version only.

Maintenance

A prerequisite for fault-free operation and avoiding premature wear is compliance with the maintenance, care and adjustments to the engine and chassis described in the owner's manual. Poor adjustment and tuning of the engine and suspension can lead to damage and breakage of components.

Using the motorcycle in extreme conditions such as racing can lead to above-average wear to components such as the power train or brakes. For this reason, it may be necessary to service or replace worn parts before the limit specified in the service schedule is reached. Pay careful attention to the prescribed running-in period and inspection and maintenance intervals. Close adherence to these periods will significantly lengthen the service life of your motorcycle.

Warranty

The work described in the service schedule must be carried out exclusively in an authorized KTM-RC8 workshop and confirmed in the service record, since otherwise any warranty claim is meaningless. No warranty claim can be met for damage resulting from manipulation and/or other changes to the vehicle.

Materials

The fuels and lubricants named in the owner's manual must be used according to specifications.

Spare parts, accessories

In the interests of your own safety, use only spare parts and accessories approved and/or recommended by KTM, and have these fitted in an authorized KTM-RC8 workshop. KTM accepts no liability for other products and any resulting damage.

Some of the spare parts and accessory products are specified in parentheses under the respective descriptions. Your KTM dealer will be glad to advise you.

You will find the current **KTM PowerParts** for your vehicle on the KTM website.

International KTM Website: <http://www.ktm.com>

Work rules

Special tools are necessary for some of the work. These are not included with the vehicle and can be ordered under the number in parentheses. Ex: valve spring mounter (59029019000)

During assembly, non-reusable parts (e.g. self-locking screws and nuts, seals and seal rings, O-rings, pins, lock washers) must be replaced by new parts.

If thread lock (e.g. **Loctite**[®]) is used for screw connections, be sure to comply with the manufacturer's specific instructions on its usage. Parts that you want to reuse following repairs and servicing should be cleaned and checked for damage and wear. Change damaged or worn parts.

Following repairs or servicing, the vehicle must be checked for roadworthiness.

Transport

Note

Danger of damage The parked vehicle may roll away or fall over.

- Always place the vehicle on a firm and even surface.

Note

Fire hazard Some vehicle components become very hot when the vehicle is operated.

- Do not park the vehicle near flammable or explosive substances. Do not place objects on the vehicle while it is still warm from being run. Always let the vehicle cool first.

-
- Switch off the engine and remove the ignition key.
 - Secure the motorcycle against falling over or running away using straps or other suitable devices.

Environment

Motorcycling is a wonderful sport and we naturally hope that you can enjoy it to the full. However, it can also lead to problems with the environment and conflict with other persons. Responsible behavior in handling the motorcycle can help to avoid such problems and conflicts. To ensure the future of motorcycle sport, make sure you use the motorcycle legally, demonstrate a consciousness for the environment, and respect the rights of others.

Notes/warnings

Pay close attention to the notes/warnings.



Info

Various information and warning labels are affixed to the vehicle. Do not remove information/warning labels. If they are missing, you or others may not recognize potential hazards and may therefore be injured.

Grades of risks



Danger

Identifies a danger that will immediately and invariably lead to fatal or serious permanent injury if the appropriate measures are not taken.



Warning

Identifies a danger that is likely to lead to fatal or serious injury if the appropriate measures are not taken.



Caution

Identifies a danger that may lead to minor injuries if the appropriate measures are not taken.

Note

Identifies a danger that will lead to considerable machine and material damage if the appropriate measures are not taken.



Warning

Identifies a danger that will lead to environmental damage if the appropriate measures are not taken.

Owner's manual

- Be sure to read this owner's manual carefully and completely before taking your first ride. It contains useful information and tips to help you operate and handle your motorcycle. Only then will you find out how to best customize the motorcycle for your own use and how you can protect yourself from injury. The owner's manual also contains important information on servicing the motorcycle.
- The owner's manual is an important component of the motorcycle and should be handed over to the new owner if the vehicle is sold.

View of vehicle, front left side

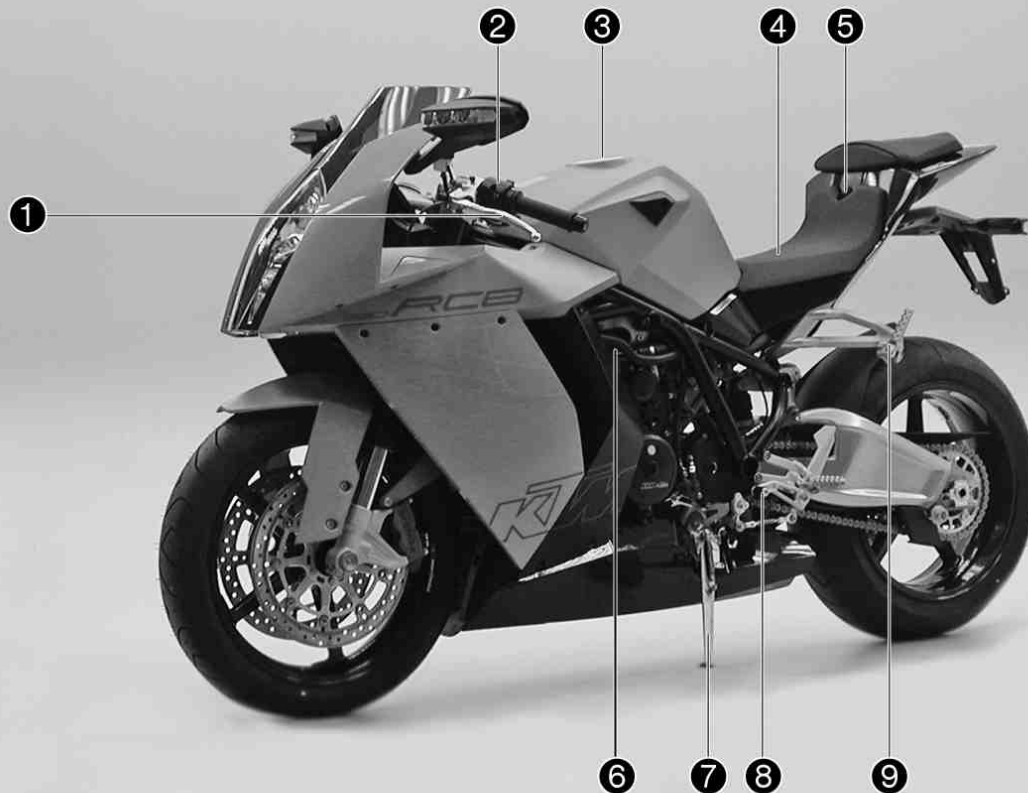

1	Clutch lever
2	Light switch, headlight flasher switch, indicator switch, horn button
3	Filler cap
4	Seat
5	Seat lock
6	Oil dipstick
7	Side stand
8	Shift lever
9	Passenger footrests

View of vehicle, rear right side

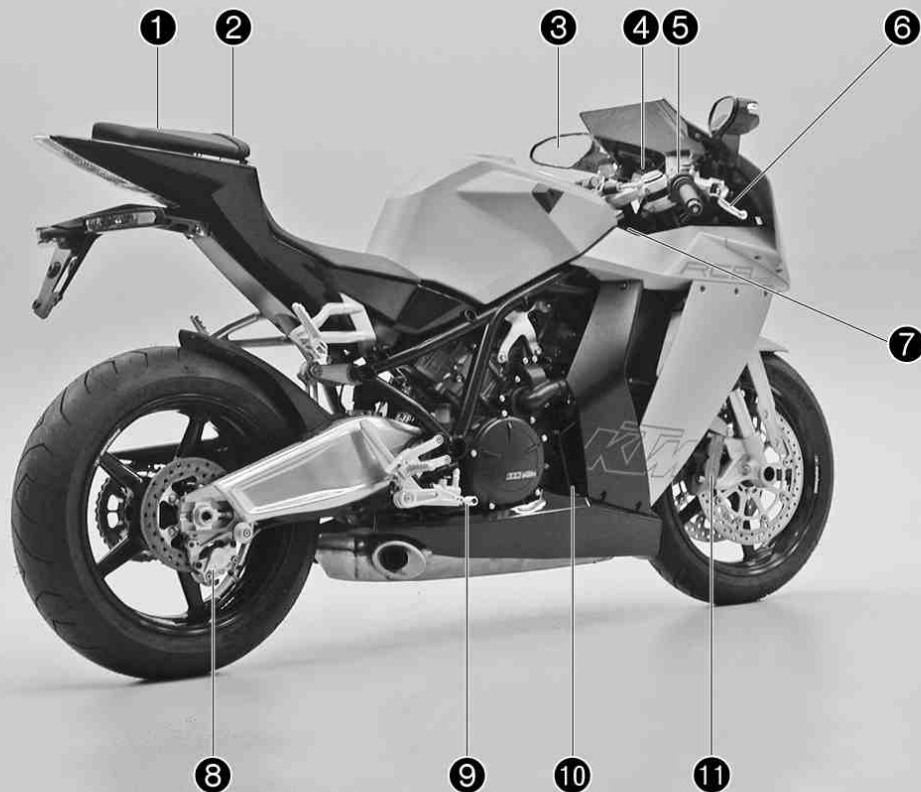

1	Passenger seat
2	Supporting strap
3	Rear mirror
4	Combination instrument
5	Emergency OFF switch, electric starter button
6	Hand brake lever
7	Chassis number, type label
8	Rear brake caliper
9	Foot brake lever
10	Engine number
11	Brake calipers, front

Vehicle identification number/type label

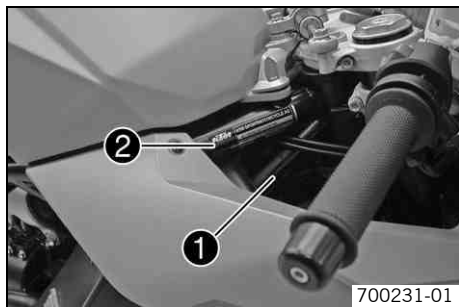

The vehicle identification number ❶ is stamped on the frame behind the steering head on the right.

The type label ❷ is on the frame above the vehicle identification number.

Key number

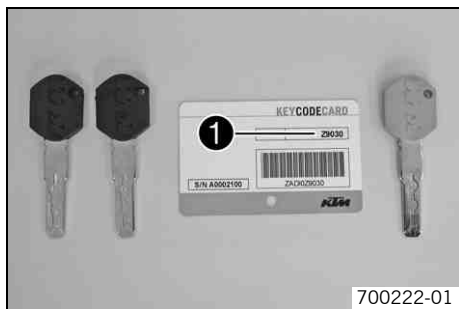

The key number **Code number** ❶ can be found on the **KEYCODECARD**.



Info

You need the key number to order a spare key. Keep the **KEYCODECARD** in a safe place.

Use the orange programming key to activate and deactivate the black ignition key. Keep the orange programming key in a safe place: it must only be used for learning and programming functions.

Engine number

The engine number ❶ is stamped on the right side of the engine.

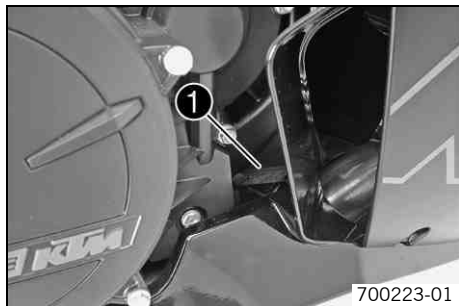

Fork part number

The fork part number ❶ is stamped on the inner side of the fork stub.

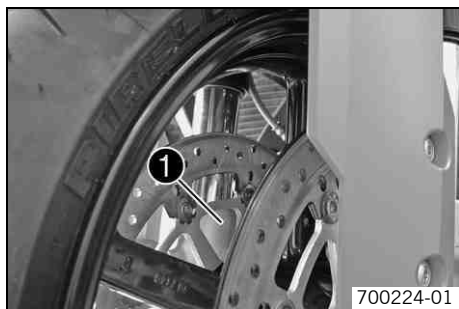

Shock absorber part number



The shock absorber part number ❶ is stamped on the upper part of the shock absorber above the adjusting ring towards the rear.

Steering damper part number

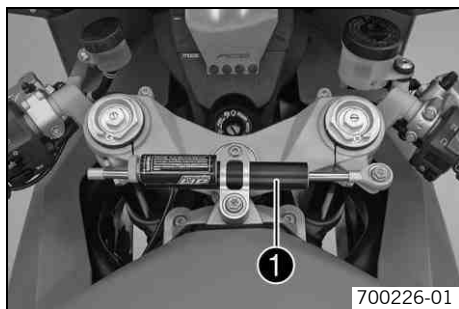

The steering damper part number ❶ is stamped on the top of the steering damper.

Clutch lever

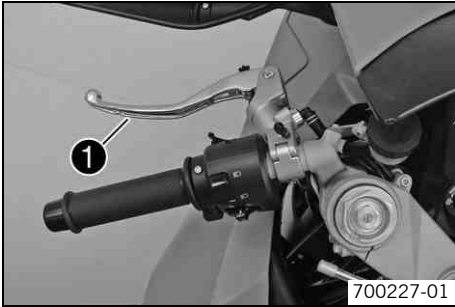

The clutch lever ❶ is fitted on the left side of the handlebar.
The clutch is hydraulic and self-adjusting.

Hand brake lever



The hand brake lever ❶ is fitted on the right side of the handlebar.
The hand brake lever operates the front brake.

Light switch

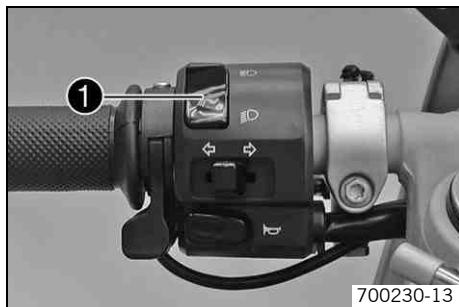

The light switch ❶ is fitted on the left side of the handlebar.

Possible states

	<p>Low beam on – The light switch is in the lower position. In this position, the low beam and tail light are switched on.</p>
	<p>High beam on – The light switch is in the upper position. In this position, the low beam, the high beam and the tail light are switched on.</p>

Headlight flasher switch



The headlight flasher switch ❶ is fitted on the left side of the handlebar.

Possible states



- Headlight flasher switch in neutral position
- Headlight flasher switch pressed – The headlight flasher switch (high beam) is operated in this position.

Turn signal switch



The turn signal switch ❶ is fitted on the left side of the handlebar.

Possible states

	Turn signal off
	Left turn signal on – The turn signal switch is pressed to the left. The turn signal switch automatically returns to the central position after use.
	Right turn signal on – The turn signal switch is pressed to the right. The turn signal switch automatically returns to the central position after use.



To switch off the turn signal, press the turn signal switch towards the switch housing.

Horn button



The horn button ❶ is fitted on the left side of the handlebar.

Possible states

- Horn button  in neutral position
- Horn button  pressed – The horn is operated in this position.

Ignition/steering lock

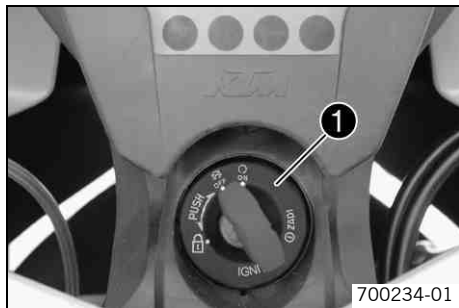

The ignition/steering lock ❶ is located in front of the upper triple clamp.

i Info

The ignition may only be switched on using a black ignition key.
Use the orange programming key to activate and deactivate the black ignition key.

Possible states

	Ignition OFF – In this position, the ignition circuit is interrupted, a running engine stops, and a non-running engine will not start. The black ignition key can be removed.
	Ignition ON – In this position, the ignition circuit is closed and the engine can be started.
	Steering locked – In this position, the ignition circuit is interrupted and the steering locked. The black ignition key can be removed.

Emergency OFF switch



The emergency OFF switch ❶ is installed on the right side of the handlebar.

Possible states

	Emergency OFF switch on – This position is necessary for operation; the ignition circuit is closed.
	Emergency OFF switch off – In this position, the ignition circuit is interrupted, a running engine stops, and a non-running engine cannot be started.

Electric starter button



The electric starter button ❶ is fitted on the right side of the handlebar.

Possible states

- Electric starter button ❸ in neutral position
- Electric starter button ❸ pressed – In this position, the electric starter is operated.

immobilizer



The electronic immobilizer secures the vehicle against unauthorized use.

The immobilizer is activated automatically and the engine electronics are locked when the ignition key is withdrawn.

The red warning lamp ❶ flashes at 15 second intervals after one minute.

The red warning lamp can also indicate errors by flashing.

Info

The ignition key contains electronic components. Never attach multiple ignition keys to a single key ring; this may cause mutual interference and lead to problems.

A lost black ignition key must be deactivated to prevent unauthorized persons from operating the vehicle.

The second black ignition key is activated when the vehicle is shipped.

Two additional spare ignition keys (key number on the **KEYCODECARD**) can be ordered from an authorized KTM RC8 workshop, but they must be activated before use.

Combination instrument - overview

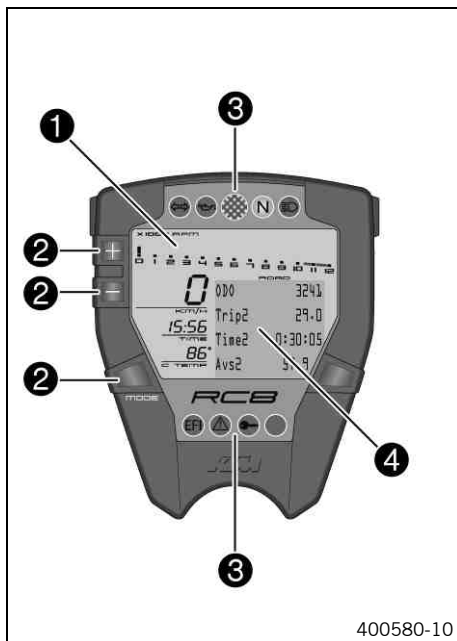

- 1 Display (☛ p. 27)
- 2 Function buttons
- 3 Indicator lamps (☛ p. 29)
- 4 Info display (☛ p. 28)

Combination instrument - function buttons on handlebar

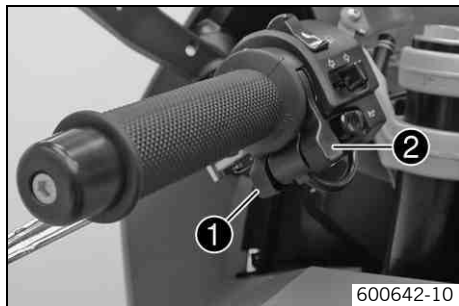

The **MODE** button ❶ is fitted on the handlebar, front left.

The **LAP** button ❷ is fitted on the handlebar, rear left.

MODE button

Changes to the next item on the info display in **ROAD** mode and in **RACE** mode.

LAP button

Changes to the next item in the info display in **ROAD** mode. Clocks the lap times in **RACE** mode.

Combination instrument - activation and test



Activation

The combination instrument is activated when the ignition is switched on.

Test

The segments of the tachometer light up in and switch off in sequence.

The speed display counts from 0 to 300 and back.

The remaining display segments outside the info display light up briefly.

The **KTM** logo appears in the info display.

In **ROAD** mode, the info display switches to **ODO**, **Trip 1**, **Time 1**, **Avs 1** mode.

In **RACE** mode, the info display switches to **LAPSTOGO**, **LastLap**, **±Last**, **±Best** mode.

Display

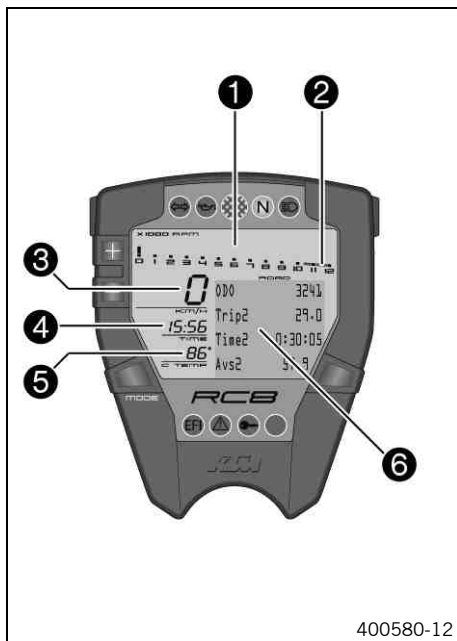

The tachometer ❶ displays the engine speed in revolutions per minute (RPM).
The red marking ❷ marks the over-rev (excessive speed) range of the engine.
The speed ❸ is displayed in kilometers per hour **km/h** or in miles per hour **Mph**.
The time appears in segment ❹.



Info

After reconnecting the battery or changing the fuse, the time must be reset.

The coolant temperature is shown in degrees Celsius or Fahrenheit in segment ❺.
The info display ❻ shows additional information.

Info display

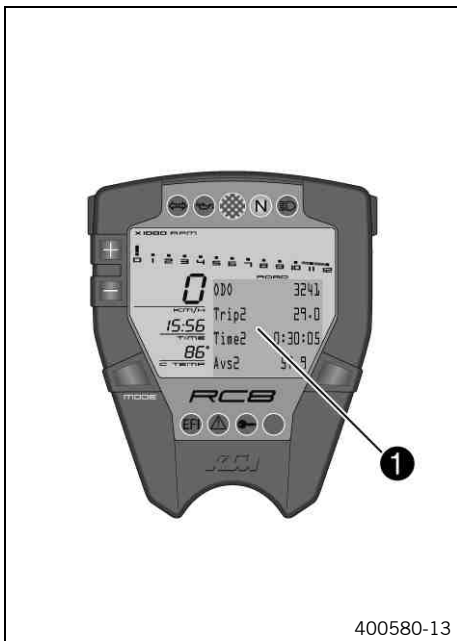

The info display ❶ has two menus.

Menu 1 is **ROAD** mode (standard) for riding on public roads.

Menu 2 is **RACE** mode for riding on race tracks. It allows riders to time laps themselves.

If the general warning lamp  lights up, the corresponding message is shown periodically in the info display.

Information repeat	45 s
--------------------	------

The information shown in the info display can be controlled with the function buttons.

Indicator lamps

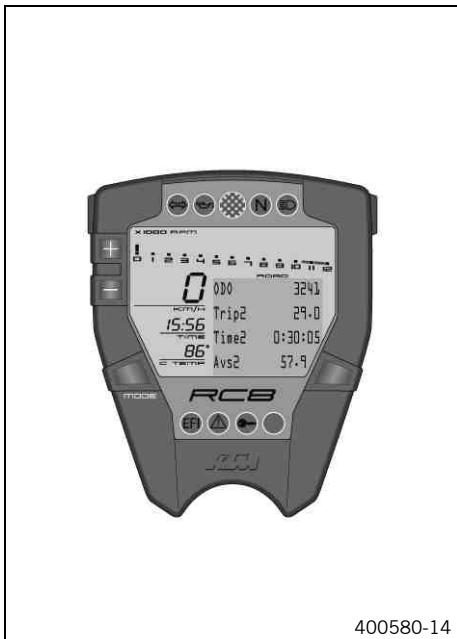

Possible states

	The turn signal indicator lamp flashes green simultaneously with the turn signal – The turn signal is switched on.
	The oil indicator lamp lights up red – The oil pressure is too low.
	The shift warning lights up/flashes red – The set shift speed has been reached.
	The idle speed indicator lamp lights up green – The transmission is shifted to idle.
	The high beam indicator lamp lights up blue – The high beam is switched on.
	EFI warning lamp (MIL) lights up / flashes red – The OBD has detected an emission- or safety-critical fault.
	The general warning lights up yellow – An operating safety (warning) message was detected. This is also shown periodically in the info display.
	The immobilizer indicator lamp lights up or flashes red – Status or error message for immobilizer/alarm system.

Notes/warnings on the combination instrument

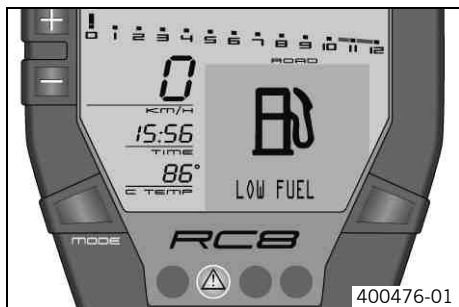

LOW FUEL appears on the info display if the minimum range falls below the specified value.

Distance	20 km (12.4 mi)
----------	-----------------

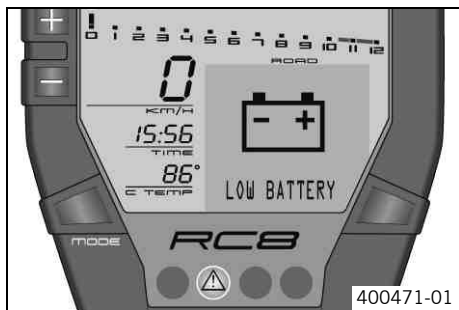

LOW BATTERY appears on the info display if the battery voltage falls below the specified value.

Battery voltage	10.80 V
-----------------	---------

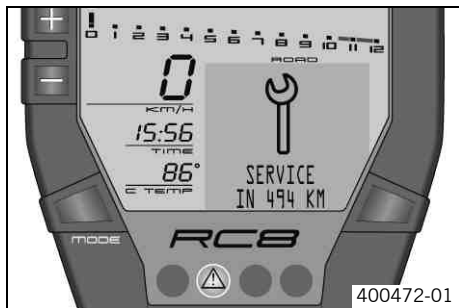

SERVICE IN xxx KM(MPH) appears on the info display if the distance to the next service falls below the specified value.

Distance	500 km (310.7 mi)
----------	-------------------

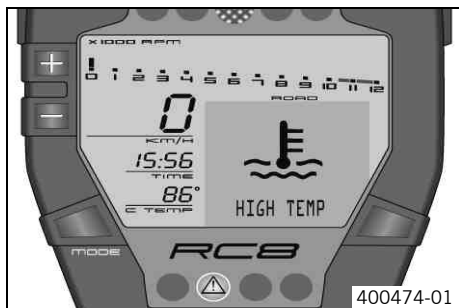

HIGH TEMP appears on the info display if the coolant temperature rises above the specified value.

Coolant temperature	120 °C (248 °F)
---------------------	-----------------

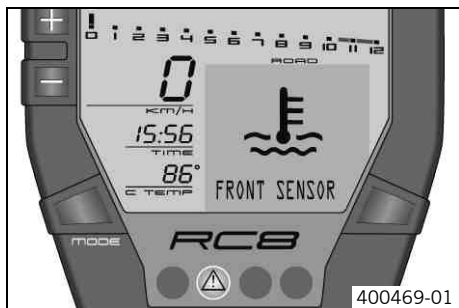

FRONT SENSOR appears on the info display if the front cylinder coolant temperature sensor is faulty.

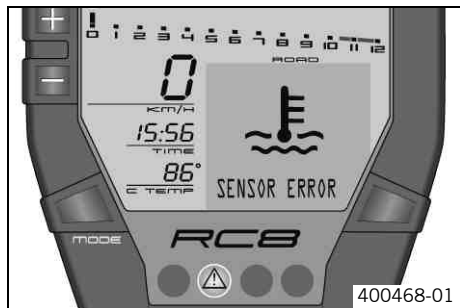

SENSOR ERROR appears on the info display if the discrepancy between the front and rear cylinder coolant temperature sensor values differs by more than the specified value.

Coolant temperature	10 °C (50 °F)
---------------------	---------------

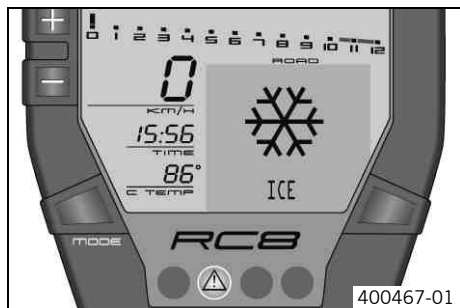

ICE appears on the info display if the external temperature falls below the specified value.

Temperature	3 °C (37 °F)
-------------	--------------

ICE disappears if the external temperature rises above the specified value.

Temperature	4 °C (39 °F)
-------------	--------------

Overview of ROAD mode

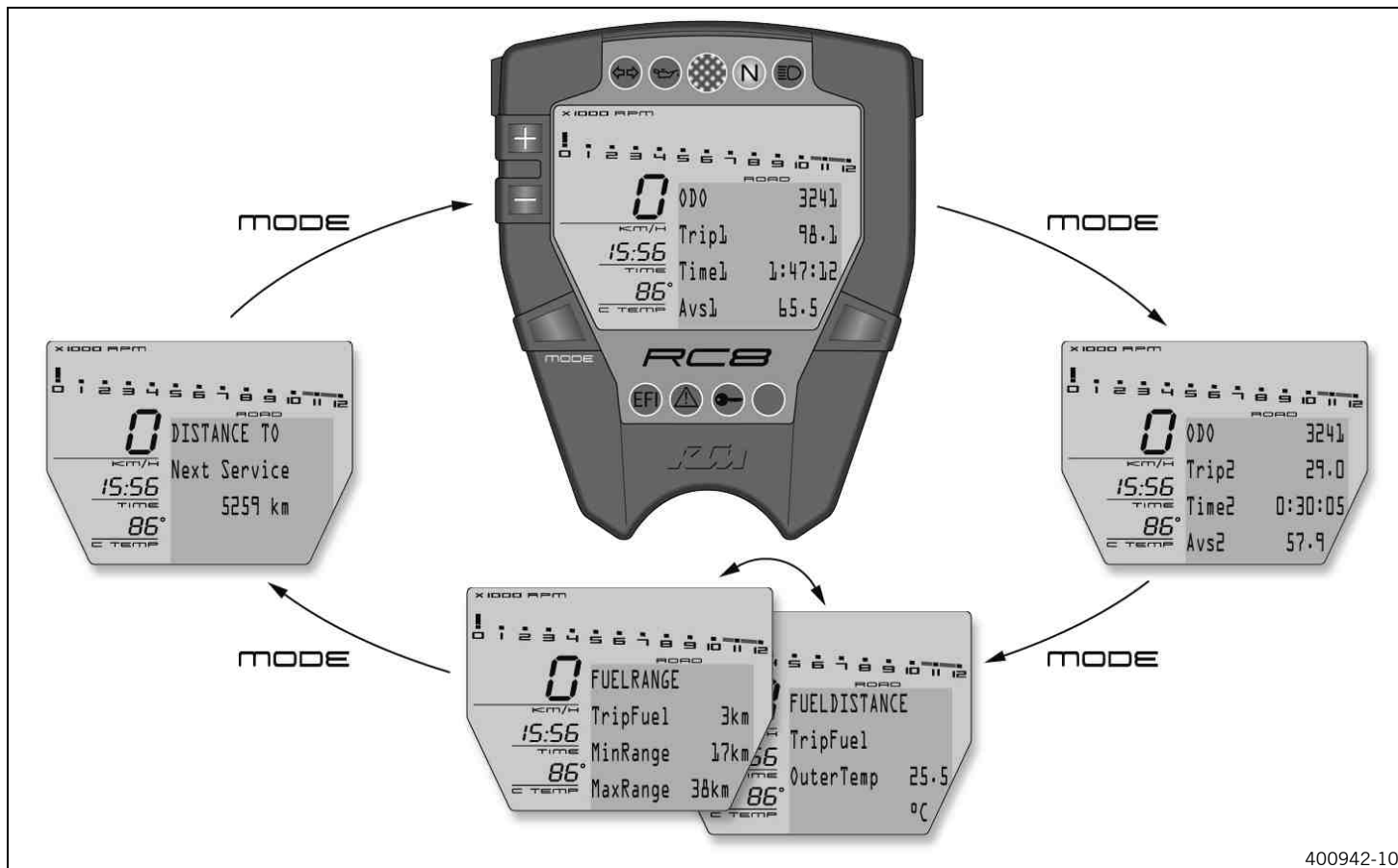

Functions in ROAD mode

Odometer menu **ODO/Trip 1**

Odometer menu **ODO/Trip 2**

FUELDISTANCE menu

FUEL RANGE menu

DISTANCE TO Next Service menu

Odometer menu ODO/Trip 1

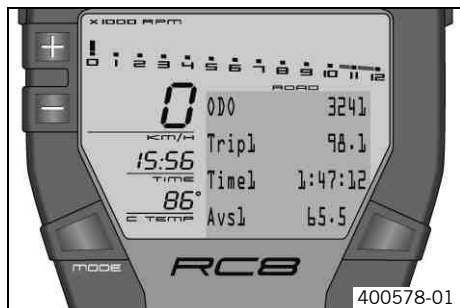

Condition

- The ignition is on.
- **ROAD** Mode
- Press the **MODE** button briefly and repeatedly until **ODO** appears at the top left of the info display.





ODO shows the total distance covered.

Trip 1 shows the distance covered since the last reset. For example, between two refueling stops. **Trip 1** is always running and counts up to **9999.9**.

Time 1 shows the journey time on the basis of **Trip 1** and resumes running as soon as a speed signal is received.

The calculation of this value starts with the first speed signal and ends 3 seconds after the last speed signal.

Avs 1 (average speed) is coupled with **Trip 1** and **Time 1**.

Press the button  .	No function
Press the button  .	No function
Press the button  and the button  for 3 - 5 seconds.	The display changes to the SET-UP menu

Press the MODE button for 3 - 5 seconds.	The display of Trip 1 , Time 1 and Avs 1 is reset
Press the MODE button briefly.	Next display mode

Odometer menu ODO/Trip 2

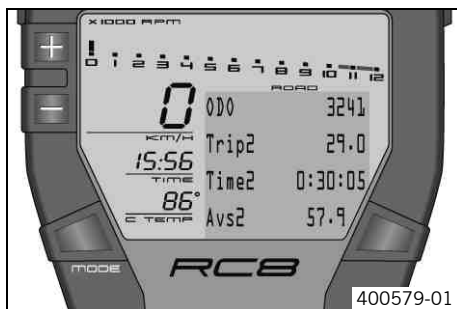

Condition

- The ignition is on.
- **ROAD** Mode
- Press the **MODE** button briefly and repeatedly until **ODO** appears at the top left of the info display.





ODO shows the total distance covered.

Trip 2 shows the distance covered since the last reset. For example, between two refueling stops. **Trip 2** is always running and counts up to **9999.9**.

Time 2 shows the journey time on the basis of **Trip 2** and resumes running as soon as a speed signal is received.

The calculation of this value starts with the first speed signal and ends 3 seconds after the last speed signal.

Avs 2 (average speed) is coupled with **Trip 2** and **Time 2**.

Press the button  .	No function
Press the button  .	No function
Press the button  and the button  for 3 - 5 seconds.	The display changes to the SET-UP menu
Press the MODE button for 3 - 5 seconds.	The display of Trip 2 , Time 2 and Avs 2 is reset

Press the MODE button briefly.	Next display mode
---------------------------------------	-------------------

FUELDISTANCE menu

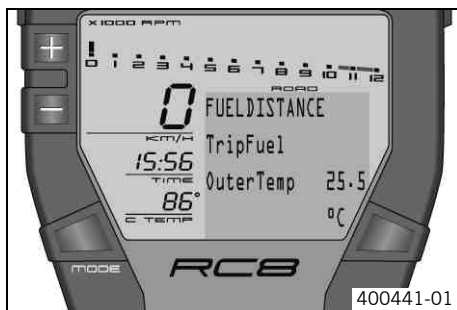

Condition

- The ignition is on.
- **ROAD** Mode
- Press the **MODE** button briefly and repeatedly until **FUELDISTANCE** appears at the top of the info display.

TripFuel shows the distance covered since the fuel reserve level was reached.







Info

This is displayed only after you reach the fuel reserve level.

OuterTemp shows the external temperature.

The external temperature can be switched on and off in the **SET-UP** menu.

Press the button  .	no function
Press the  button  .	no function
Press the button  and the button  for 3 - 5 seconds.	The display changes to the SET-UP menu
Press the MODE button for 3 - 5 seconds.	no function
Press the MODE button briefly.	Next display mode

FUEL RANGE menu

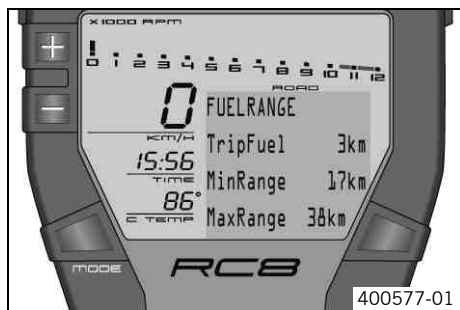

Condition

- The ignition is on.
- **ROAD** Mode
- Press the **MODE** button briefly and repeatedly until **FUEL RANGE** appears at the top of the info display.

TripFuel shows the distance covered since the fuel reserve level was reached.







Info

This is displayed only after you reach the fuel reserve level.

MinRange shows the minimum range you can cover with the fuel reserve.

MaxRange shows the maximum range you can cover with the fuel reserve.

The possible range of the fuel reserve depends on your riding style.

Press the button  .	No function
Press the button  .	No function
Press the button  and the button  for 3 - 5 seconds.	The display changes to the SET-UP menu
Press the MODE button for 3 - 5 seconds.	No function
Press the MODE button briefly.	Next display mode



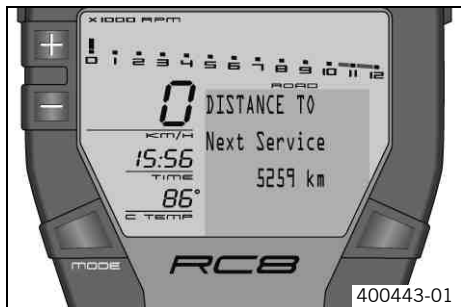

DISTANCE TO Next Service menu



Condition

- The ignition is on.
 - The motorcycle is stationary.
 - **ROAD** Mode
- Press the **MODE** button briefly and repeatedly until **DISTANCE TO Next Service** appears in the info display.

DISTANCE TO Next Service shows the distance before the next service is necessary.

Press the button  .	No function
Press the button  .	No function
Press the button  and the button  for 3 - 5 seconds.	The display changes to the SET-UP menu
Press the MODE button for 3 - 5 seconds.	No function
Press the MODE button briefly.	Next display mode

Overview of RACE mode

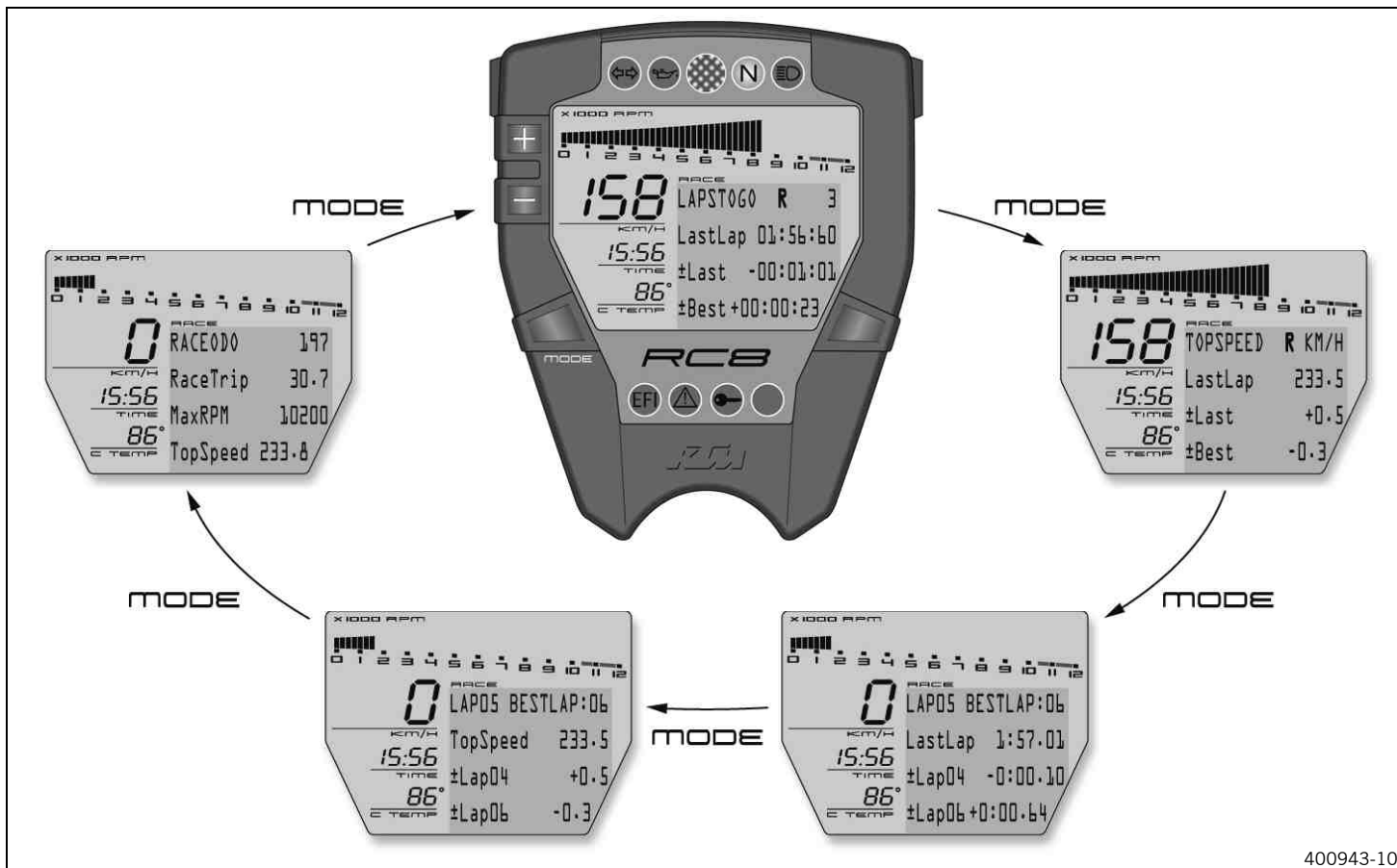

Functions in RACE mode

LAPSTOGO menu

TOPSPEED menu

Lap time LAP/BESTLAP/LastLap menu

Top speed LAP/BESTLAP/TopSpeed menu

Total distance in Race Mode RACEODO menu

LAPSTOGO menu

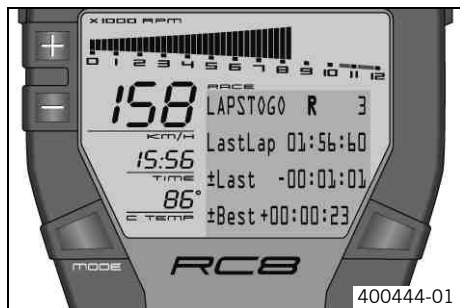

Condition

- The ignition is on.
- **RACE** Mode
- Press the **MODE** button briefly and repeatedly until **LAPSTOGO** appears at the top left of the info display.

LAPSTOGO shows the number of remaining laps.

If an **R** appears after **LAPSTOGO**, the stopwatch is running in the background.

If a **P** appears after **LAPSTOGO**, the stopwatch in the background is active but waiting for a speed signal. The time is not running.





This function is controlled by the button "**LAP**".

LastLap shows the lap time of the last lap.

±Last shows the difference between the last lap and the lap before last.

±Best shows the difference between the last lap and the best lap.

If the last lap was the fastest, you see behind **±Best**: the **Best!** symbol in the info display.

Press the button  .	No function
Press the button  .	No function
Press the button  and the button  for 3 - 5 seconds.	The display changes to the SET-UP menu

Press the MODE button for 3 - 5 seconds.	All values in RACE mode are reset (except RACEODO)
Press the MODE button briefly.	Next display mode

TOPSPEED menu

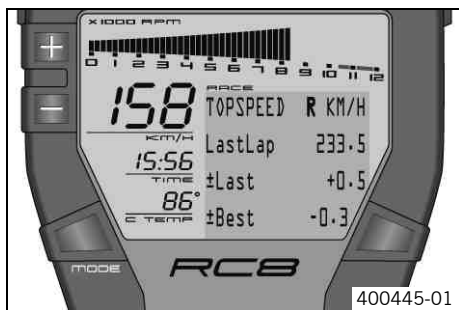

Condition

- The ignition is on.
- **RACE** Mode
- Press the **MODE** button briefly and repeatedly until **TOPSPEED** appears at the top left of the info display.

If an **R** appears after **TOPSPEED**, the stopwatch is running in the background.

If a **P** appears after **TOPSPEED**, the stopwatch is not running in the background.

This function is controlled by the button "**LAP**".

TOPSPEED shows the highest lap speed.





LastLap shows the maximum speed of the last lap.

±Last shows the maximum speed difference between the last lap and the lap before.

±Best shows the maximum speed difference between the last lap and the highest maximum speed.

If the last lap was the lap with the highest maximum speed, the info display shows **±Best:**

Best!

Press the button  .	No function
Press the button  .	No function
Press the button  and the button  for 3 - 5 seconds.	The display changes to the SET-UP menu

Press the MODE button for 3 - 5 seconds.	The display of LastLap , ±Last and ±Best are set to 0
Press the MODE button briefly.	Next display mode

LAP/BESTLAP/LastLap menu

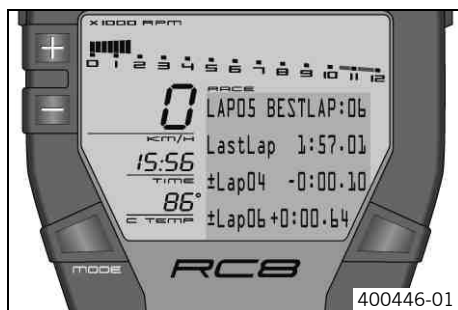

Condition

- The ignition is on.
- The motorcycle is stationary.
- **RACE** Mode
 - Press the **MODE** button briefly and repeatedly until **LAP/BESTLAP/LastLap** appears in the info display.





LAP shows the selected lap.

BESTLAP shows the number of the lap with the best lap time.

LastLap shows the time of the lap behind **LAP**.

±Lap shows the difference to the lap before.

±Lap shows the difference to the lap after.

Press the button  .	The next lap is displayed
Press the button  .	The previous lap is displayed
Press the button  and the button  for 3 - 5 seconds.	The display changes to the SET-UP menu
Press the MODE button for 3 - 5 seconds.	All values in RACE mode are reset (except RACE000)

Press the MODE button briefly.	Next display mode
---------------------------------------	-------------------

LAP/BESTLAP/TopSpeed menu

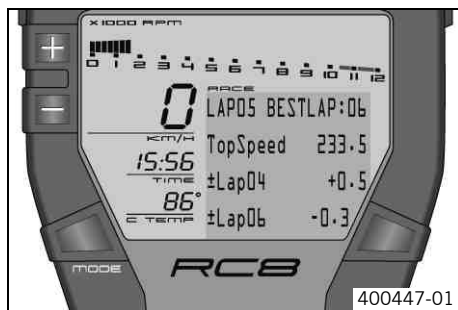

Condition

- The ignition is on.
- The motorcycle is stationary.
- **RACE** Mode
- Press the **MODE** button briefly and repeatedly until **LAP/BESTLAP/TopSpeed** appears in the info display.





LAP shows the selected lap.

BESTLAP shows the lap in which the highest maximum speed was reached.

TopSpeed shows maximum speed of the lap behind **LAP**.

±Lap shows the difference to the lap before.

±Lap shows the difference to the lap after.

Press the button  .	The next lap is displayed
Press the button  .	The previous lap is displayed
Press the button  and the button  for 3 - 5 seconds.	The display changes to the SET-UP menu
Press the MODE button for 3 - 5 seconds.	All values in RACE mode are reset (except RACE000)
Press the MODE button briefly.	Next display mode

Total distance menu in Race mode RACEODO

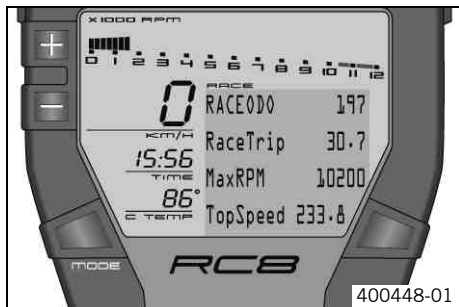

Condition





- The ignition is on.
- The motorcycle is stationary.
- **RACE** Mode
- Press the **MODE** button briefly and repeatedly until **RACEODO** appears at the top of the info display.

RACEODO shows the total distance covered in **RACE** mode.

RaceTrip shows the distance covered since the last reset. For example, between two refueling stops. **RaceTrip** is always running and counts up to **999.9**.

MaxRPM shows the highest engine speed reached during the **RaceTrip**.

TopSpeed shows the highest speed reached during the **RaceTrip**.

Press the button  .	No function
Press the button  .	No function
Press the button  and the button  for 3 - 5 seconds.	The display changes to the SET-UP menu
Press the MODE button for 3 - 5 seconds.	All values in RACE mode are reset (except RACEODO)
Press the MODE button briefly.	Next display mode

Overview of SET-UP mode

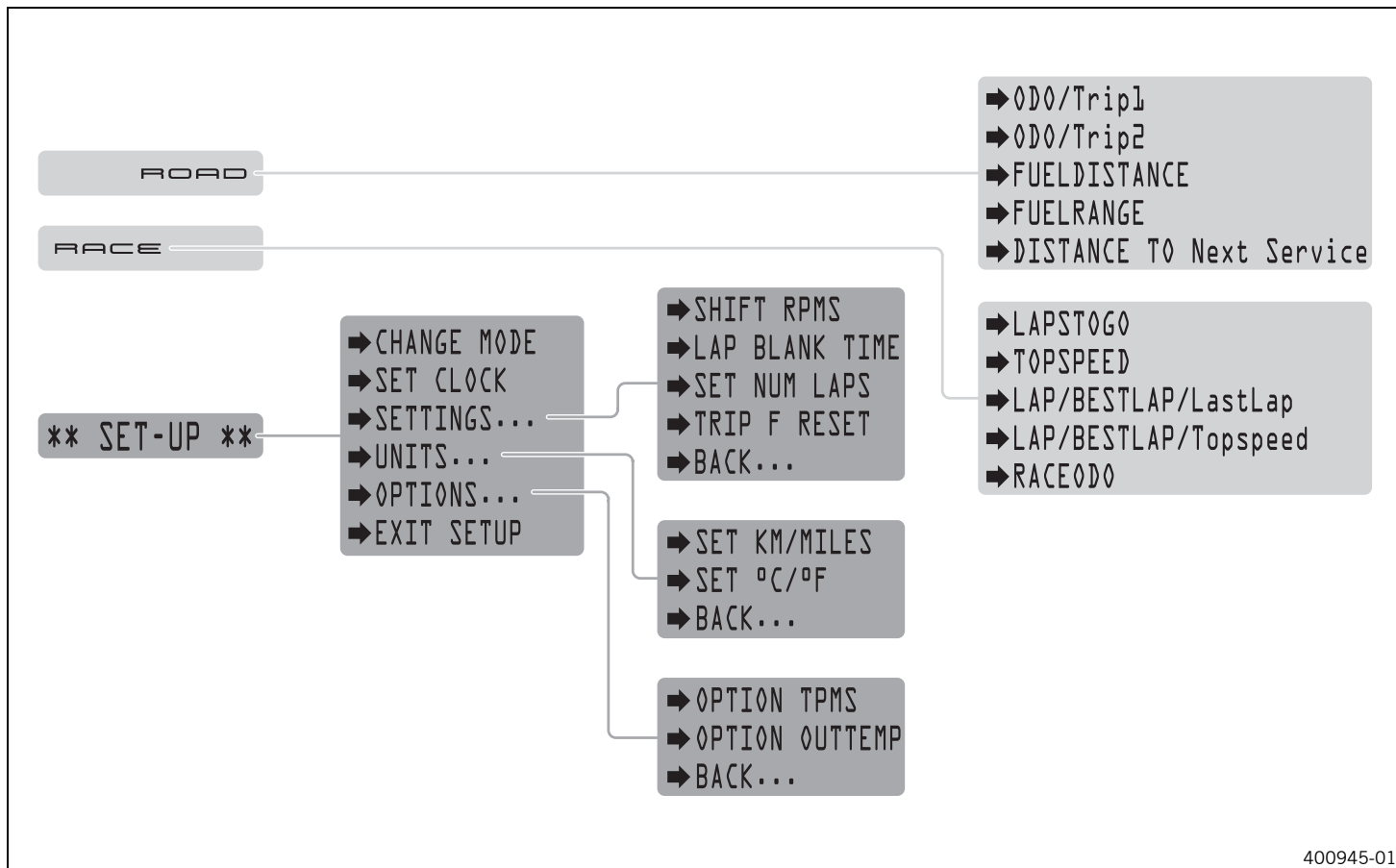

Settings in SET-UP mode

CHANGE MODE menu

SET CLOCK menu

SETTINGS menu

UNITS menu



OPTIONS menu

EXIT SETUP menu

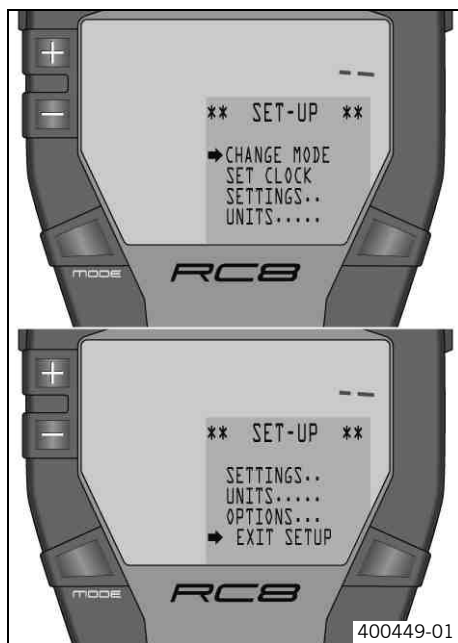
SET-UP menu



Condition

- The ignition is on.
- The motorcycle is stationary.
- Press the button  and the button  for 3 - 5 seconds.

On the **CHANGE MODE** menu, you can select between **ROAD** and **RACE** mode.

You can set the clock on the **SET CLOCK** menu.





On the **SETTINGS** menu, you can set the shift warning light, the lap blank time of the **LAP** button, the number of laps, and the reset time of the fuel reserve display.

On the **UNITS** menu, you can set the units for measuring speed, distance, and temperature.

On the **OPTIONS** menu, you can switch the tire pressure check and external temperature display on/off (available as an accessory).

Select **EXIT SETUP** to close the **SET-UP** menu.



The symbol  shows which menu you can activate with the button "**MODE**".

Press the button  .	The arrow moves up
Press the button  .	The arrow moves down
Press the button  and the button  for 3 - 5 seconds.	No function
Press the MODE button for 3 - 5 seconds.	The menu in front of the arrow is selected
Press the MODE button briefly.	The menu in front of the arrow is selected

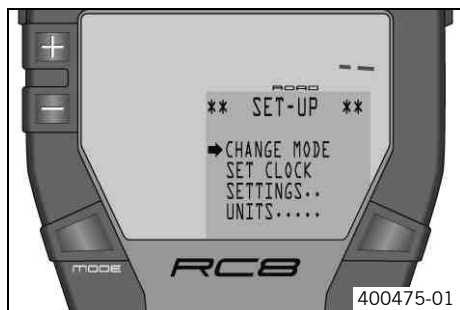



CHANGE MODE menu



Condition

- The ignition is on.
- The motorcycle is stationary.
- Press the button  and the button  for 3 - 5 seconds.
- Press the **MODE** button briefly.



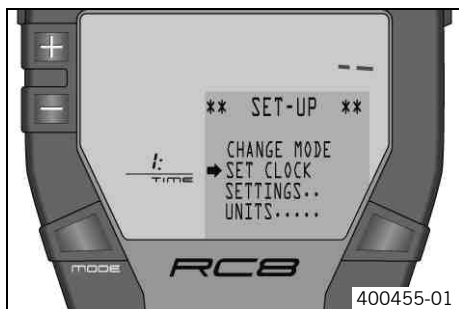

On the **CHANGE MODE** menu, you can select between **ROAD** and **RACE** mode.

Press the button  .	Changes the menu
Press the button  .	Changes the menu
Press the button  and the button  for 3 - 5 seconds.	No function
Press the MODE button for 3 - 5 seconds.	Open and exit CHANGE MODE
Press the MODE button briefly.	Open and exit CHANGE MODE





SET CLOCK menu



Condition

- The ignition is on.
- The motorcycle is stationary.
- Press the button  and the button  for 3 - 5 seconds.
- Press the button  once until the symbol  shows **SET CLOCK** in the info display.
- Press the **MODE** button briefly.



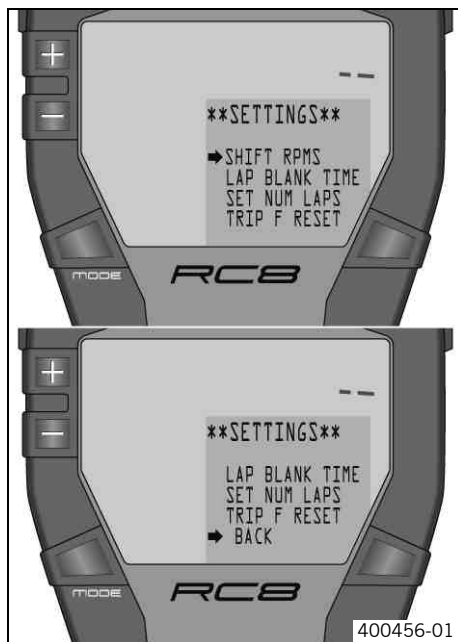

You can set the clock on the **SET CLOCK** menu.

Press the button  .	Increases the value
Press the button  .	Decreases the value
Press the button  and the button  for 3 - 5 seconds.	No function
Press the MODE button for 3 - 5 seconds.	Open and exit SET CLOCK or change to next value
Press the MODE button briefly.	Open and exit SET CLOCK or change to next value

SETTINGS menu



Condition

- The ignition is on.
- The motorcycle is stationary.
- Press the button  and the button  for 3 - 5 seconds.
- Press the button  twice until the symbol  appears in front of **SETTINGS** in the info display.
- Press the **MODE** button briefly.

On the **SHIFT RPMS** menu, you can activate the shift warning light.





On the **LAP BLANK TIME** menu, you can set the lap blank time of the **LAP** button.

On the **SET NUM LAPS** menu, you set the number of laps to cover in **RACE** mode.

On the **TRIP F RESET** menu, you can set the reaction time of the fuel reserve display to changes of the fuel level.

On the **BACK...** menu, you can switch back to the **SET-UP** menu.



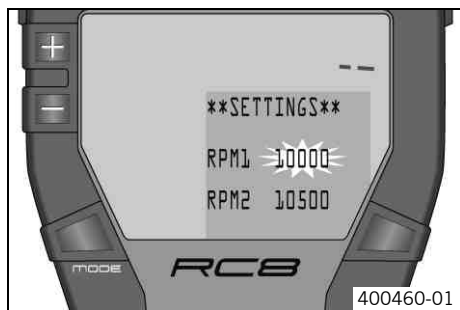

The symbol  shows which menu you can activate with the button "**MODE**".

Press the button  .	The arrow moves up
Press the button  .	The arrow moves down
Press the button  and the button  for 3 - 5 seconds.	No function
Press the MODE button for 3 - 5 seconds.	The menu in front of the arrow is selected
Press the MODE button briefly.	The menu in front of the arrow is selected





SHIFT RPMS menu



Condition

- The ignition is on.
- The motorcycle is stationary.
- Press the button  and the button  for 3 - 5 seconds.
- Press the button  twice until the symbol  appears in front of **SETTINGS** in the info display.
- Press the **MODE** button briefly.
- Press the **MODE** button briefly.





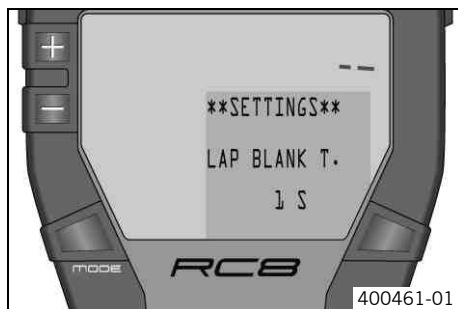

On the **SHIFT RPMS** menu, you can activate the shift warning light.

Press the button  .	Increases the value
Press the button  .	Decreases the value
Press the button  and the button  for 3 - 5 seconds.	No function
Press the MODE button for 3 - 5 seconds.	Open and exit SHIFT RPMS or change to the next value
Press the MODE button briefly.	Open and exit SHIFT RPMS or change to the next value





LAP menu, LAP BLANK T button



Condition

- The ignition is on.
- The motorcycle is stationary.
- Press the button  and the button  for 3 - 5 seconds.
- Press the button  twice until the symbol  appears in front of **SETTINGS** in the info display.
- Press the **MODE** button briefly.
- Press the button  once until the symbol  shows **LAP BLANK T** in the info display.
- Press the **MODE** button briefly.







On the **LAP BLANK T** menu, you set the lap blank time of the **LAP** button.

Press the button  .	Increases the value
Press the button  .	Decreases the value
Press the button  and the button  for 3 - 5 seconds.	No function
Press the MODE button for 3 - 5 seconds.	Open and exit LAP BLANK T
Press the MODE button briefly.	Open and exit LAP BLANK T





SET NUM LAPS menu



Condition

- The ignition is on.
- The motorcycle is stationary.
- Press the button  and the button  for 3 - 5 seconds.
- Press the button  twice until the symbol  appears in front of **SETTINGS** in the info display.
- Press the **MODE** button briefly.
- Press the button  twice until the symbol  is on **SET NUM LAPS** in the info display.
- Press the **MODE** button briefly.





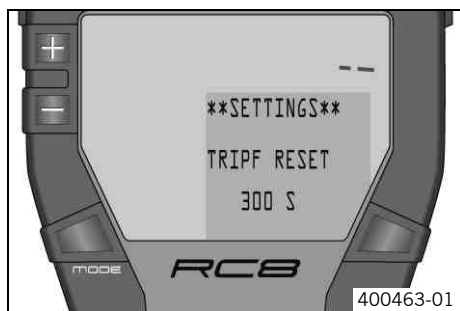

On the **SET NUM LAPS** menu, you set the number of laps to cover in **RACE** mode.

Press the button  .	Increases the value
Press the button  .	Decreases the value
Press the button  and the button  for 3 - 5 seconds.	No function
Press the MODE button for 3 - 5 seconds.	Open and exit SET NUM LAPS
Press the MODE button briefly.	Open and exit SET NUM LAPS





TRIP F RESET menu



Condition

- The ignition is on.
- The motorcycle is stationary.
- Press the button  and the button  for 3 - 5 seconds.
- Press the button  twice until the symbol  appears in front of **SETTINGS** in the info display.
- Press the **MODE** button briefly.
- Press the button  three times until the symbol  shows **TRIP F RESET** in the info display.
- Press the **MODE** button briefly.



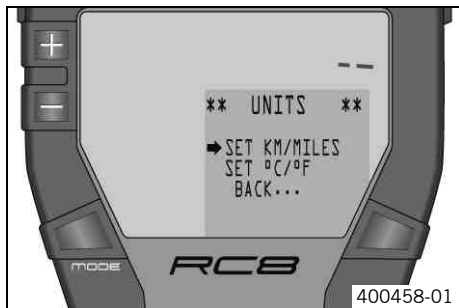

On the **TRIP F RESET** menu, you can set the reaction time of the fuel reserve display to changes of the fuel level.

Press the button  .	Increases the value
Press the button  .	Decreases the value
Press the button  and the button  for 3 - 5 seconds.	No function
Press the MODE button for 3 - 5 seconds.	Open and exit TRIP F RESET
Press the MODE button briefly.	Open and exit TRIP F RESET

UNITS menu



Condition





- The ignition is on.
- The motorcycle is stationary.
- Press the button  and the button  for 3 - 5 seconds.
- Press the button  three times until the symbol  shows **UNITS** in the info display.
- Press the **MODE** button briefly.

On the **SET KM/MILES** menu, you can set the units for measuring speed and distance.

On the **SET °C/°F** menu, you can set the unit for the temperature display.

On the **BACK...** menu, you can switch back to the **SET-UP** menu.



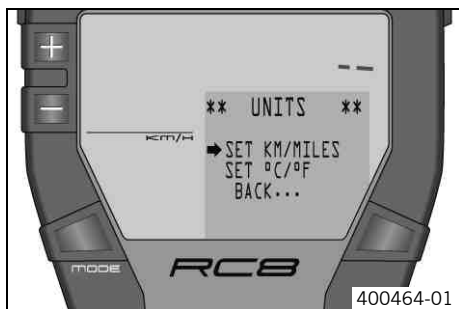

The symbol  shows which menu you can activate with the button "**MODE**".

Press the button  .	The arrow moves up
Press the button  .	The arrow moves down
Press the button  and the button  for 3 - 5 seconds.	No function
Press the MODE button for 3 - 5 seconds.	The menu in front of the arrow is selected
Press the MODE button briefly.	The menu in front of the arrow is selected





SET KM/MILES menu



Condition

- The ignition is on.
- The motorcycle is stationary.
- Press the button  and the button  for 3 - 5 seconds.
- Press the button  three times until the symbol  shows **UNITS** in the info display.
- Press the **MODE** button briefly.
- Press the **MODE** button briefly.



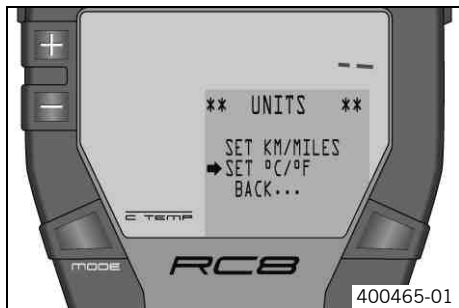

On the **SET KM/MILES** menu, you can set the units for measuring speed and distance.

Press the button  .	Changes the unit
Press the button  .	Changes the unit
Press the button  and the button  for 3 - 5 seconds.	No function
Press the MODE button for 3 - 5 seconds.	Open and exit SET KM/MILES
Press the MODE button briefly.	Open and exit SET KM/MILES





SET °C/°F menu



Condition

- The ignition is on.
- The motorcycle is stationary.
- Press the button  and the button  for 3 - 5 seconds.
- Press the button  three times until the symbol ➔ shows **UNITS** in the info display.
- Press the **MODE** button briefly.
- Press the button  once until the symbol ➔ shows **SET °C/°F** in the info display.
- Press the **MODE** button briefly.



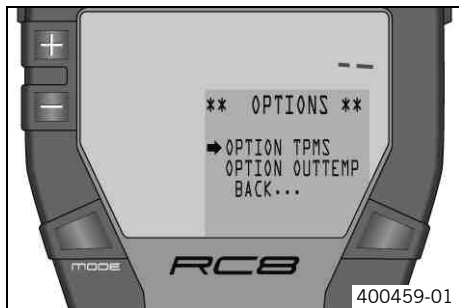

On the **SET °C/°F** menu, you can set the unit for the temperature display.

Press the button  .	Changes the unit
Press the button  .	Changes the unit
Press the button  and the button  for 3 - 5 seconds.	No function
Press the MODE button for 3 - 5 seconds.	Open and exit SET °C/°F
Press the MODE button briefly.	Open and exit SET °C/°F

OPTIONS menu



Condition





- The ignition is on.
- The motorcycle is stationary.
- Press the button  and the button  for 3 - 5 seconds.
- Press the button  four times until the symbol  shows **OPTIONS** in the info display.
- Press the **MODE** button briefly.

On the **OPTION TPMS** menu, you can switch the tire pressure check on/off (available as an accessory).

On the **OPTION OUTTEMP** menu, you can switch the external temperature display on/off.

On the **BACK...** menu, you can switch back to the **SET-UP** menu.



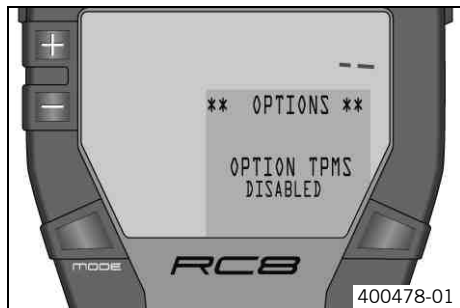

The symbol  shows which menu you can activate with the button "**MODE**".

Press the button  .	The arrow moves up
Press the button  .	The arrow moves down
Press the button  and the button  for 3 - 5 seconds.	No function
Press the MODE button for 3 - 5 seconds.	The menu in front of the arrow is selected
Press the MODE button briefly.	The menu in front of the arrow is selected





TPMS menu



Condition

- The ignition is on.
- The motorcycle is stationary.
- Press the button  and the button  for 3 - 5 seconds.
- Press the button  four times until the symbol  shows **OPTIONS** in the info display.
- Press the **MODE** button briefly.
- Press the **MODE** button briefly.





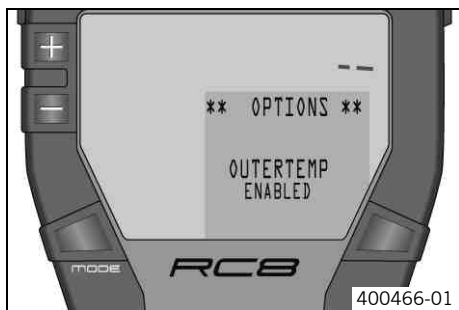

On the **OPTION TPMS** menu, you can switch the tire pressure check on/off (available as an accessory).

Press the button  .	Switches the tire pressure display on/off
Press the button  .	Switches the tire pressure display on/off
Press the button  and the button  for 3 - 5 seconds.	No function
Press the MODE button for 3 - 5 seconds.	Open and exit OPTION TPMS
Press the MODE button briefly.	Open and exit OPTION TPMS

OUTERTEMP menu



Condition

- The ignition is on.
- The motorcycle is stationary.
- Press the button  and the button  for 3 - 5 seconds.
- Press the button  four times until the symbol  shows **OPTIONS** in the info display.
- Press the **MODE** button briefly.
- Press the button  once until the symbol  shows **OPTION OUTERTEMP** in the info display.
- Press the **MODE** button briefly.

On the **OPTION OUTERTEMP** menu, you can switch the external temperature display on/off.





Press the button  .	Switches the external temperature display on/off
Press the button  .	Switches the external temperature display on/off
Press the button  and the button  for 3 - 5 seconds.	No function
Press the MODE button for 3 - 5 seconds.	Open and exit OPTION OUTERTEMP
Press the MODE button briefly.	Open and exit OPTION OUTERTEMP





Table of functions					
Display	Press the button  .	Press the button  .	Press the button  and the button  for 3 - 5 seconds.	Press the MODE button for 3 - 5 seconds.	Press the MODE button briefly.
Odometer menu ODO/Trip 1	No function	No function	The display changes to the SET-UP menu	The display of Trip 1, Time 1 and Avs 1 is reset	Next display mode
Odometer menu ODO/Trip 2	No function	No function	The display changes to the SET-UP menu	The display of Trip 2, Time 2 and Avs 2 is reset	Next display mode
FUELDISTANCE menu	no function	no function	The display changes to the SET-UP menu	no function	Next display mode
FUELRANGE menu	No function	No function	The display changes to the SET-UP menu	No function	Next display mode
DISTANCE TO Next Service menu	No function	No function	The display changes to the SET-UP menu	No function	Next display mode
LAPSTOGO menu	No function	No function	The display changes to the SET-UP menu	All values in RACE mode are reset (except RACEODO)	Next display mode
TOPSPEED menu	No function	No function	The display changes to the SET-UP menu	The display of LastLap, ±Last and ±Best are set to 0	Next display mode
LAP/BESTLAP/ LastLap menu	The next lap is displayed	The previous lap is displayed	The display changes to the SET-UP menu	All values in RACE mode are reset (except RACEODO)	Next display mode





Table of functions					
Display	Press the button  .	Press the button  .	Press the button  and the button  for 3 - 5 seconds.	Press the MODE button for 3 - 5 seconds.	Press the MODE button briefly.
LAP/BESTLAP/TopSpeed menu	The next lap is displayed	The previous lap is displayed	The display changes to the SET-UP menu	All values in RACE mode are reset (except RACEODO)	Next display mode
Total distance menu in Race RACEODO	No function	No function	The display changes to the SET-UP menu	All values in RACE mode are reset (except RACEODO)	Next display mode
SET-UP menu	The arrow moves up	The arrow moves down	No function	The menu in front of the arrow is selected	The menu in front of the arrow is selected
CHANGE MODE menu	Changes the menu	Changes the menu	No function	Open and exit CHANGE MODE	Open and exit CHANGE MODE
SET CLOCK menu	Increases the value	Decreases the value	No function	Open and exit SET CLOCK or change to next value	Open and exit SET CLOCK or change to next value
SETTINGS menu	The arrow moves up	The arrow moves down	No function	The menu in front of the arrow is selected	The menu in front of the arrow is selected
SHIFT RPMS menu	Increases the value	Decreases the value	No function	Open and exit SHIFT RPMS or change to the next value	Open and exit SHIFT RPMS or change to the next value
LAP menu, LAP BLANK T button	Increases the value	Decreases the value	No function	Open and exit LAP BLANK T	Open and exit LAP BLANK T





Table of functions					
Display	Press the button  .	Press the button  .	Press the button  and the button  for 3 - 5 seconds.	Press the MODE button for 3 - 5 seconds.	Press the MODE button briefly.
SET NUM LAPS menu	Increases the value	Decreases the value	No function	Open and exit SET NUM LAPS	Open and exit SET NUM LAPS
TRIP F RESET menu	Increases the value	Decreases the value	No function	Open and exit TRIP F RESET	Open and exit TRIP F RESET
UNITS menu	The arrow moves up	The arrow moves down	No function	The menu in front of the arrow is selected	The menu in front of the arrow is selected
SET KM/MILES menu	Changes the unit	Changes the unit	No function	Open and exit SET KM/MILES	Open and exit SET KM/MILES
SET °C/°F menu	Changes the unit	Changes the unit	No function	Open and exit SET °C/°F	Open and exit SET °C/°F
OPTIONS menu	The arrow moves up	The arrow moves down	No function	The menu in front of the arrow is selected	The menu in front of the arrow is selected
TPMS menu	Switches the tire pressure display on/off	Switches the tire pressure display on/off	No function	Open and exit OPTION TPMS	Open and exit OPTION TPMS
OUTERTEMP menu	Switches the external temperature display on/off	Switches the external temperature display on/off	No function	Open and exit OPTION OUTERTEMP	Open and exit OPTION OUTERTEMP

Table of conditions and menu activation						
Display	<ul style="list-style-type: none"> The ignition is on. ROAD Mode 	<ul style="list-style-type: none"> The ignition is on. The motorcycle is stationary. ROAD Mode 	<ul style="list-style-type: none"> The ignition is on. RACE Mode 	<ul style="list-style-type: none"> The ignition is on. The motorcycle is stationary. RACE Mode 	<ul style="list-style-type: none"> The ignition is on. The motorcycle is stationary. 	Menu can be activated
Odometer menu ODO/Trip 1	•					
Odometer menu ODO/Trip 2	•					
FUELDISTANCE menu	•					
FUELRANGE menu	•					
DISTANCE TO Next Service menu		•				
LAPSTOGO menu			•			
TOPSPEED menu			•			
LAP/BESTLAP/LastLap menu				•		
LAP/BESTLAP/TopSpeed menu				•		
Total distance menu in Race mode RACEODO				•		
SET-UP menu					•	
CHANGE MODE menu					•	•
SET CLOCK menu					•	
SETTINGS menu					•	
SHIFT RPMS menu					•	
LAP menu, LAP BLANK T button					•	
SET NUM LAPS menu					•	

Table of conditions and menu activation						
Display	<ul style="list-style-type: none"> The ignition is on. ROAD Mode 	<ul style="list-style-type: none"> The ignition is on. The motorcycle is stationary. ROAD Mode 	<ul style="list-style-type: none"> The ignition is on. RACE Mode 	<ul style="list-style-type: none"> The ignition is on. The motorcycle is stationary. RACE Mode 	<ul style="list-style-type: none"> The ignition is on. The motorcycle is stationary. 	Menu can be activated
TRIP F RESET menu					•	
UNITS menu					•	
SET KM/MILES menu					•	
SET °C/°F menu					•	
OPTIONS menu					•	
TPMS menu					•	•
OUTERTEMP menu					•	•

Displaying lap times

Condition

The ignition is on.

The motorcycle is stationary.

RACE Mode

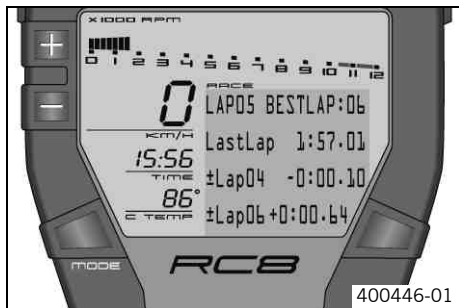

- Press the **MODE** button briefly and repeatedly until **LAP/BESTLAP/LastLap** appears in the info display.
 - ✓ **LAP01** appears on the left of the info display.
- Press the button .
 - ✓ The next lap is displayed.
- Press the button .
 - ✓ The previous lap is displayed.
- Press the **MODE** button briefly.
 - ✓ Next display mode

Displaying maximum speed

Condition

The ignition is on.

The motorcycle is stationary.

RACE Mode



- Press the **MODE** button briefly and repeatedly until **LAP/BESTLAP/TopSpeed** appears in the info display.
 - ✓ **LAP01** appears on the left of the info display.
- Press the button .
 - ✓ The next lap is displayed.
- Press the button .
 - ✓ The previous lap is displayed.
- Press the **MODE** button briefly.
 - ✓ Next display mode

Setting ROAD or RACE mode

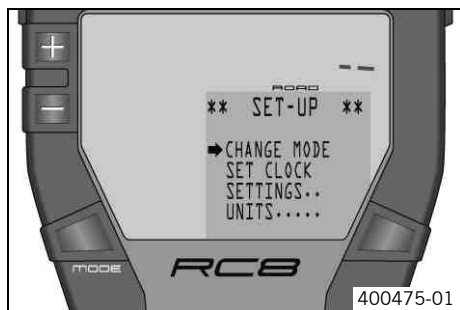

Condition

The ignition is on.

The motorcycle is stationary.

- Press the button and the button for 3 - 5 seconds.
- Press the **MODE** button briefly.
 - ✓ The mode set is shown in the info display.
- Select **ROAD** mode or **RACE** mode with the button or the button.
- Press the **MODE** button briefly.
 - ✓ The settings are stored and the display changes to the **SET-UP** menu.
- Press the button briefly and repeatedly until the symbol shows **EXIT SETUP** in the info display.
- Press the **MODE** button briefly.

Setting the clock with SET CLOCK

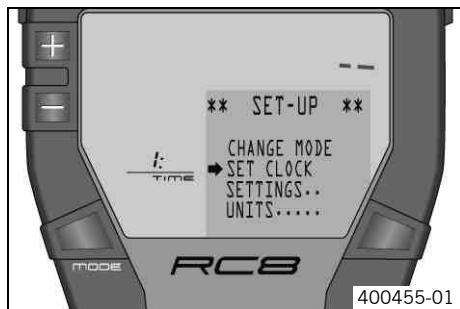



Condition

The ignition is on.

The motorcycle is stationary.

- Press the button and the button for 3 - 5 seconds.
- Press the button once until the symbol shows **SET CLOCK** in the info display.
- Press the **MODE** button briefly.
 - ✓ The hour is shown.
- Set the hour with the button or the button.
- Press the **MODE** button briefly.
 - ✓ The minutes are shown.
- Set the minutes with the button or the button.





- Press the **MODE** button briefly.
 - ✓ The settings are stored and the display changes to the **SET-UP** menu.
- Press the button  briefly and repeatedly until the symbol  shows **EXIT SETUP** in the info display.
- Press the **MODE** button briefly.

Adjusting shift speed RPM1/2

Condition

The ignition is on.

The motorcycle is stationary.



- Press the button  and the button  for 3 - 5 seconds.
- Press the button  twice until the symbol  appears in front of **SETTINGS** in the info display.
- Press the **MODE** button briefly.
- Press the **MODE** button briefly.
 - ✓ **RPM1** and **RPM2** appear in the info display.
 - ✓ The engine speed after **RPM1** flashes.



Info

The engine speed can be set at intervals of 50.



RPM1 is the engine speed above which the shift warning light starts to flash.

- Set the engine speed with the button  or the button .
- Press the **MODE** button briefly.
 - ✓ The engine speed after **RPM2** flashes.







**Info**

RPM2 is the engine speed above which the shift warning light lights up constantly. If **RPM1 = RPM2**, the shift warning light lights up constantly when you reach the engine speed set.

- Set the engine speed with the button  or the button .
 - Press the **MODE** button briefly.
 - ✓ The settings are stored and the display changes to the **SETTING** menu.
-

**Info**

At delivery, **RPM1** is set to 10000 and **RPM2** to 10500.

- Press the button  briefly and repeatedly until the symbol  shows **BACK...** in the info display.
- Press the **MODE** button briefly.
- Press the button  briefly and repeatedly until the symbol  shows **EXIT SETUP** in the info display.
- Press the **MODE** button briefly.





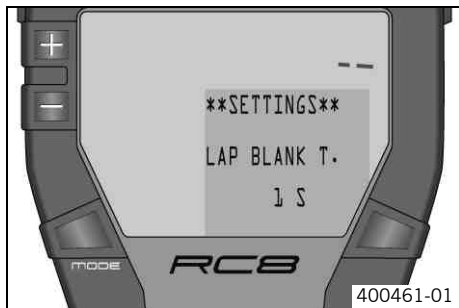

Setting the blank time of the LAP button LAP BLANK T

Condition

The ignition is on.

The motorcycle is stationary.



- Press the button  and the button  for 3 - 5 seconds.
 - Press the button  twice until the symbol  appears in front of **SETTINGS** in the info display.
 - Press the **MODE** button briefly.
 - Press the button  once until the symbol  shows **LAP BLANK T** in the info display.
 - Press the **MODE** button briefly.
- ✓ **LAP BLANK T.** appears in the info display.

 **Info**

At delivery, **LAP BLANK T.** is set to **1** second.





 **Tip**

With **LAP BLANK T.**, you can prevent the lap from being timed too short. This may happen if you accidentally press the **LAP** button twice in a row.

- Set the blank time of the **LAP** button with the  button or the  button.

 **Info**

LAP BLANK T. can be set between **1** and **200**.

- Press the **MODE** button briefly.
- ✓ The settings are stored and the display changes to the **SETTINGS** menu.
- Press the button  briefly and repeatedly until the symbol  shows **BACK...** in the info display.
- Press the **MODE** button briefly.
- Press the button  briefly and repeatedly until the symbol  shows **EXIT SETUP** in the info display.
- Press the **MODE** button briefly.



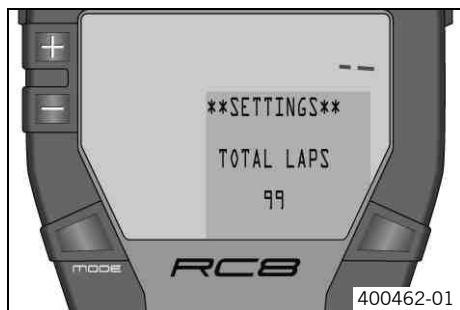



Setting the number of laps SET NUM LAPS



Condition

The ignition is on.

The motorcycle is stationary.

- Press the button  and the button  for 3 - 5 seconds.
- Press the button  twice until the symbol  appears in front of **SETTINGS** in the info display.
- Press the **MODE** button briefly.
- Press the button  twice until the symbol  is on **SET NUM LAPS** in the info display.
- Press the **MODE** button briefly.
- ✓ **TOTAL LAPS** appears in the info display with the number of laps.



Info





When delivered, the number of **TOTAL LAPS** is set to 99 laps.

- Set the number of laps with the  button or the  button.



Info

You can set **TOTAL LAPS** to between 1 and 99 laps.

- Press the **MODE** button briefly.
- ✓ The settings are stored and the display changes to the **SETTINGS** menu.
- Press the button  briefly and repeatedly until the symbol  shows **BACK...** in the info display.
- Press the **MODE** button briefly.
- Press the button  briefly and repeatedly until the symbol  shows **EXIT SETUP** in the info display.
- Press the **MODE** button briefly.



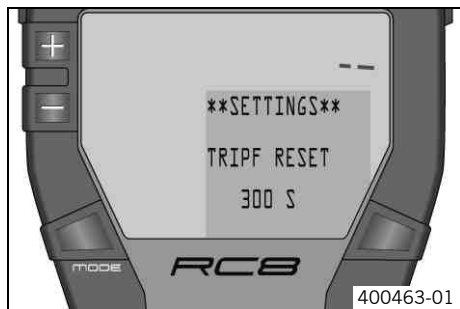



Setting the fuel reserve display TRIPF RESET



Condition

The ignition is on.



The motorcycle is stationary.

- Press the button  and the button  for 3 - 5 seconds.
- Press the button  twice until the symbol  appears in front of **SETTINGS** in the info display.
- Press the **MODE** button briefly.
- Press the button  three times until the symbol  shows **TRIP F RESET** in the info display.
- Press the **MODE** button briefly.
- ✓ **TRIPF RESET** appears in the info display with the reaction time.



Info





At delivery, **TRIPF RESET** is set to 300 seconds.

- Set the reaction time of the fuel reserve display with the  button or the  button.



Info

You can set the **TRIPF RESET** to between 10 and 1000 seconds in steps of 10.

- Press the **MODE** button briefly.
- ✓ The settings are stored and the display changes to the **SETTINGS** menu.
- Press the button  briefly and repeatedly until the symbol  shows **BACK...** in the info display.
- Press the **MODE** button briefly.
- Press the button  briefly and repeatedly until the symbol  shows **EXIT SETUP** in the info display.

- Press the **MODE** button briefly.

Setting the kilometers/miles SET KM/MILES



Info



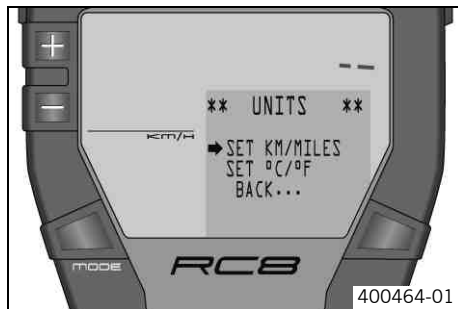







Making a country-specific setting.



Condition

The ignition is on.

The motorcycle is stationary.

- Press the button  and the button  for 3 - 5 seconds.
- Press the button  three times until the symbol  shows **UNITS** in the info display.
- Press the **MODE** button briefly.
- Press the **MODE** button briefly.
- ✓ The selected unit appears on the left of the display.
- Select the unit with the  button or the  button.
- Press the **MODE** button briefly.
- ✓ The settings are stored and the display changes to the **UNITS** menu.
- Press the button  briefly and repeatedly until the symbol  shows **BACK...** in the info display.
- Press the **MODE** button briefly.
- Press the button  briefly and repeatedly until the symbol  shows **EXIT SETUP** in the info display.
- Press the **MODE** button briefly.

Setting the temperature unit SET °C/°F

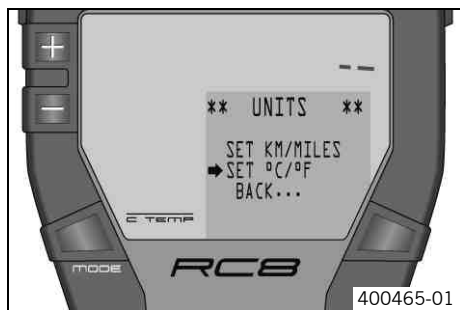

Condition

The ignition is on.

The motorcycle is stationary.

- Press the button and the button for 3 - 5 seconds.
- Press the button three times until the symbol shows **UNITS** in the info display.
- Press the **MODE** button briefly.
- Press the button once until the symbol shows **SET °C/°F** in the info display.
- Press the **MODE** button briefly.
- ✓ The selected unit appears on the left of the display.
- Select the unit with the button or the button.
- Press the **MODE** button briefly.
- ✓ The settings are stored and the display changes to the **UNITS** menu.
- Press the button briefly and repeatedly until the symbol shows **BACK...** in the info display.
- Press the **MODE** button briefly.
- Press the button briefly and repeatedly until the symbol shows **EXIT SETUP** in the info display.
- Press the **MODE** button briefly.









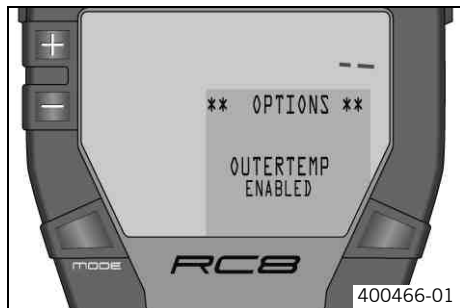



Switching the external temperature display on/off

Condition

The ignition is on.

The motorcycle is stationary.



- Press the button  and the button  for 3 - 5 seconds.
- Press the button  four times until the symbol  shows **OPTIONS** in the info display.
- Press the **MODE** button briefly.
- Press the button  once until the symbol  shows **OPTION OUTTEMP** in the info display.
- Press the **MODE** button briefly.
 - ✓ You see **ENABLED** or **DISABLED** in the info display.
- You can switch the external temperature display on/off with the  button or the  button.
- Press the **MODE** button briefly.
 - ✓ The settings are stored and the display changes to the **OPTIONS** menu.
- Press the button  briefly and repeatedly until the symbol  shows **BACK...** in the info display.
- Press the **MODE** button briefly.
- Press the button  briefly and repeatedly until the symbol  shows **EXIT SETUP** in the info display.
- Press the **MODE** button briefly.

Opening the filler cap

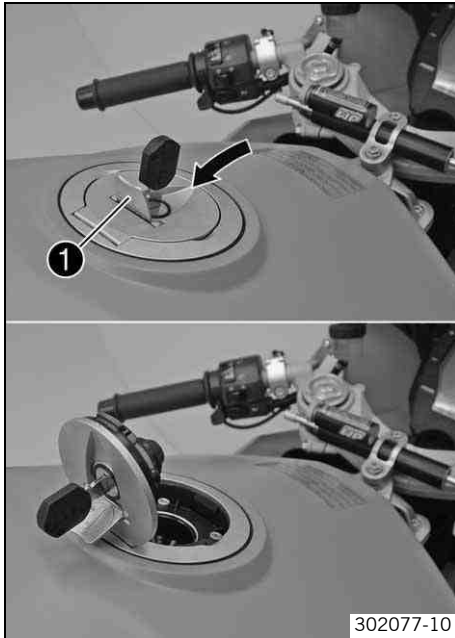

- Lift the cover ❶ of the filler cap and insert the ignition key in the lock.

Note

Danger of damage Ignition key breakage.

- To take pressure off of the ignition key, push down on the filler cap. Damaged ignition keys must be replaced.
-
- Turn the ignition key 90° clockwise.
 - Open the filler cap.

Closing the filler cap

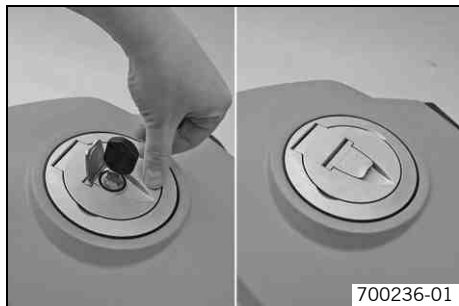

Warning

Fire hazard Fuel is highly flammable, poisonous and harmful to your health.

- When closing the filler cap, ensure that it is closed correctly. Change clothing that came into contact with fuel. Immediately clean skin that came into contact with fuel using soap and water.
-
- Close the filler cap. Push down the filler cap slightly until the lock closes.
 - Remove the ignition key and close the cover.

Supporting strap

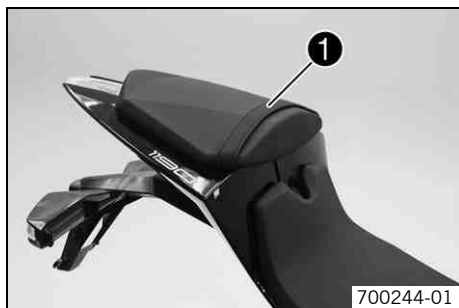

The supporting strap ❶ is provided for the passenger to hold on to.

Seat lock

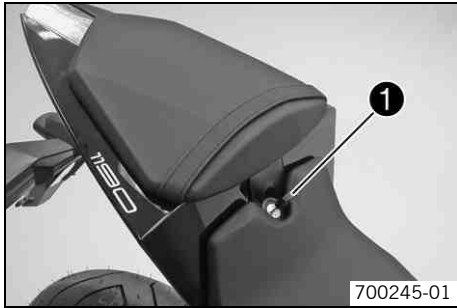

The seat lock ❶ is behind the seat.
It can be locked with the ignition key.

Tool set

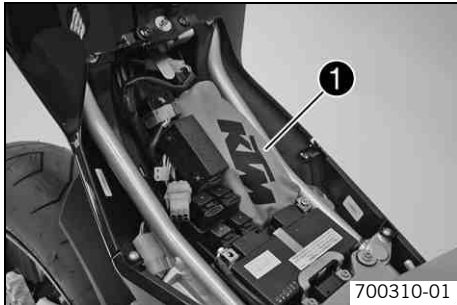

The tool set ❶ is in the storage compartment under the seat.

Helmet lock

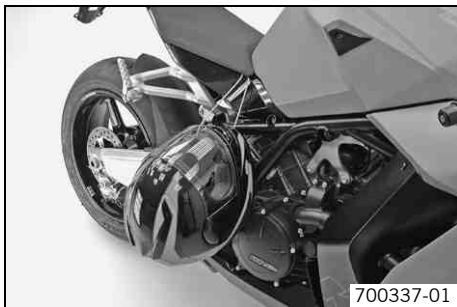

The steel cable in the tool set can be used to lock a helmet to the vehicle to prevent it from being stolen.



Warning

Danger of accidents Impairment of ride behavior and vehicle operation if a helmet or helmet lock is attached to the vehicle.

- Do not use the helmet lock for holding a helmet or other objects during the journey. Always remove the helmet lock before starting out.

Passenger footrests

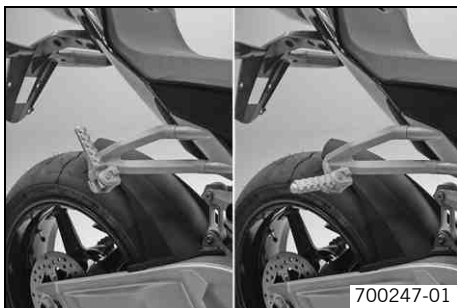

The passenger footrests can be folded up and down.

Possible states

- Passenger footrests folded up – For operation without a passenger.
- Passenger footrests folded down – For operation with a passenger.

Shift lever

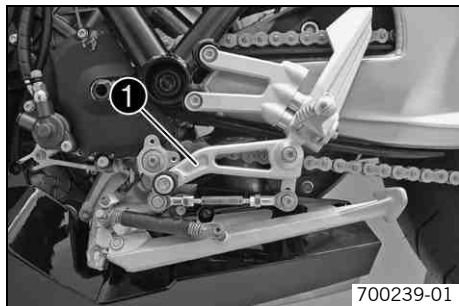

The shift lever ❶ is mounted on the left of the engine.

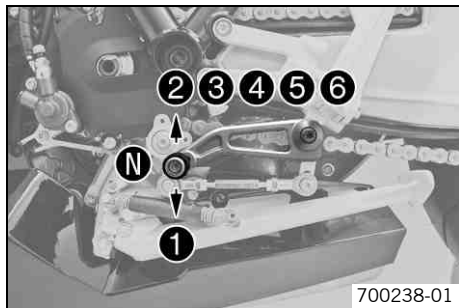

The gear positions can be seen in the picture.

The neutral or idle position ❷ is between the first and second gear.

Foot brake lever

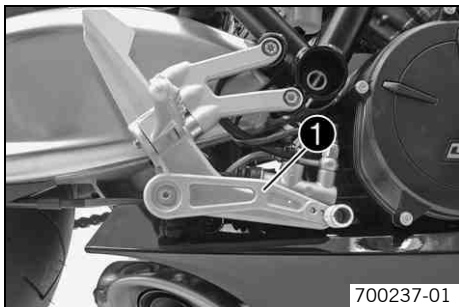

The foot brake lever ❶ is in front of the right footrest.
The foot brake lever operates the rear brake.

Side stand

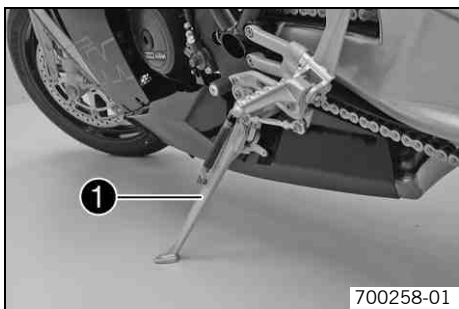

The side stand ❶ is coupled with the safety start system; see the riding instructions.

Possible states

- Side stand folded out – The vehicle can be leaned on the side stand. The safety start system is active.
- Side stand folded in – This position is mandatory for all journeys. The safety start system is inactive.

Advice on first use



Danger

Danger of accidents Danger arising from the rider's judgement being impaired.

- Do not use the vehicle if you are inexperienced or if you have consumed alcohol or drugs.



Warning

Risk of injury Missing or poor protective clothing present an increased safety risk.

- Wear protective clothing (helmet, boots, gloves, pants and jacket with protectors) every time you ride the vehicle. Always wear protective clothing, which must be undamaged and meet legal requirements.



Warning

Danger of crashing Poor vehicle handling due to different tire tread patterns on front and rear wheels.

- The front and rear wheels must be fitted with tires with similar tread patterns to prevent loss of control over the vehicle.



Warning

Danger of accidents Uncontrollable handling characteristic due to non-approved and/or non-recommended tires/wheels.

- Only tires/wheels approved by KTM and with the corresponding speed index should be used.



Warning

Danger of accidents Reduced road grip with new tires.

- New tires have a smooth rolling surface and therefore cannot provide full road grip. The entire rolling surface must be roughened in the first 200 kilometers (124.3 miles) by moderate riding at alternating angles. The full grip levels are not achieved until the tires have been run in.



Info

When using your vehicle, remember that others may feel disturbed by excessive noise.

- Make sure that the pre-delivery inspection work has been carried out exclusively by an authorized KTM-RC8 workshop.
 - ✓ You receive a delivery certificate and the service record at vehicle handover.
- Before your first trip, read the entire operating instructions carefully.
- Get to know the controls.
- Adjust the basic position of clutch lever. (☛ p. 182)
- Adjust the basic position of hand brake lever. (☛ p. 135)
- Adjust the foot brake lever. (☛ p. 125)
- Adjust the shift lever. (☛ p. 120)
- Get used to handling the vehicle on suitable terrain before making a longer trip. Try also to ride as slowly as possible to get a better feeling for the motorcycle.
- Hold the handlebars firmly with both hands and keep your feet on the footrests when riding.
- Run the engine in. (☛ p. 84)

Running the engine in

- Do not exceed the specified engine speed and load during the running-in period.

Guideline

Maximum engine speed	
During the first: 1,000 km (621.4 mi)	7,500 rpm
After the first: 1,000 km (621.4 mi)	10,500 rpm

- Avoid full-throttle operation!

Loading the vehicle



Warning

Danger of accidents Unstable handling characteristics.

- Do not exceed the maximum permitted weight and axle loads. The overall weight consists of: motorcycle operational and with a full tank, driver and passenger with protective clothing and helmet, baggage.



Warning

Danger of accidents Unstable handling characteristics due to incorrect mounting of suitcase and/or tank rucksack.

- Mount and secure suitcase and tank rucksack according to the manufacturer's instructions.



Warning

Danger of accidents Unstable handling characteristics at high speed.

- Adapt your speed according to your payload. If the motorcycle is loaded with luggage, ride more slowly.
Maximum speed with luggage 130 km/h (80.8 mph)



Warning

Danger of accidents Destruction of luggage carrier system.

- If the motorcycle is fitted with luggage cases, note the manufacturer's specifications concerning the maximum payload.



Warning

Danger of accidents Poor visibility for other road users due to slipped baggage.

- If the tail light is covered, you are less visible to traffic behind you, especially in the dark. Check that your baggage is fixed properly at regular intervals.



Warning

Danger of accidents Changed handling characteristics and longer stopping distance with excessive payload.

- Adapt your speed according to your payload.



Warning

Danger of accidents Unstable handling characteristics due to slipped baggage.

- Check the way your baggage is fixed regularly.
-

- If you carry any baggage, make sure it is fixed firmly as close as possible to the center of the vehicle and ensure even weight distribution between the front and rear wheels.
- Do not exceed the overall maximum permitted weight and the axle loads.

Guideline

Maximum permissible total weight	380 kg (838 lb.)
Maximum permissible front axle load	150 kg (331 lb.)
Maximum permissible rear axle load	240 kg (529 lb.)

checks to be made before putting into operation



Info

During operation, the motorcycle must be in a technically perfect condition.

In the interest of riding safety, you should get into the habit of making a general check of the motorcycle before every journey.

- Check the engine oil level. (☛ p. 193)
- Check the engine for oil leaks.
- Check the fuel level.
- Check the chain tension. (☛ p. 128)
- Clean the chain. (☛ p. 126)
- Check the tire condition. (☛ p. 150)
- Check the tire pressure. (☛ p. 152)
- Check the front brake fluid level. (☛ p. 135)
- Check the rear brake fluid level. (☛ p. 139)
- Check the front brake linings. (☛ p. 138)
- Check the rear brake linings. (☛ p. 141)
- Check the brake system.
- Check the coolant level. (☛ p. 179)
- Check the adjustment and smooth operation of all controls.
- Check that the electrical equipment is functioning properly.
- Check that any luggage is fastened correctly.
- Sit on the motorcycle and check the setting of the rear mirror.

Starting



Danger

Danger of poisoning Exhaust gases are poisonous and inhaling them may result in unconsciousness and/or death.

- When running the engine, always make sure there is sufficient ventilation, and do not start or run the engine in an enclosed space without an effective exhaust extraction system.



Caution

Danger of accidents If the vehicle is operated with a discharged battery or without a battery, electronic components and safety equipment may be damaged.

- Never operate the vehicle with a discharged battery or without a battery.

Note

Engine failure High engine speeds in cold engines have a negative effect on the service life of the engine.

- Always warm up the engine at low engine speeds.
-



- Press the emergency OFF switch into the position ○.
- Switch on the ignition by turning the black programming key to the position **ON** ○.
- ✓ After you switch on the ignition, you can hear the fuel pump working for about two seconds. The function test of the combination instrument is run at the same time.
- Shift into neutral.
- ✓ The green idling speed indicator lamp **N** ❶ lights up.
- Press the electric starter button ❷.

i Info

Do not press the electric starter button until the function test of the combination instrument is finished.

When starting the engine, **DO NOT** apply the throttle. If you apply the throttle during the starting procedure, the engine management shuts off the injectors and the engine will not start.

Press the starter for a maximum of 5 seconds. Wait for a least 5 seconds before trying again.

This motorcycle is equipped with a safety start system. You can only start the engine if the transmission is in neutral or if the clutch is pulled when a gear is engaged. If the side stand is folded down and you shift into gear and release the clutch, the engine stops.

- Take the weight off the side stand and swing it upwards with your foot as far as it will go.

Starting up

- Pull the clutch lever, shift into first gear, release the clutch slowly and at the same time open the throttle.

Shifting, riding



Warning

Danger of accidents Abrupt load alterations can cause the vehicle to get out of control.

- Avoid abrupt load alterations and sudden braking actions, and adapt your speed to the road conditions.



Warning

Danger of accidents If you change down at high engine speed, the rear wheel can lock up.

- Do not change into a low gear at high engine speed. The engine races and the rear wheel can lock up.



Warning

Danger of accidents Malfunctions caused by incorrect ignition key position.

- Do not change the ignition key position during a journey.



Warning

Danger of accidents Distraction from traffic activity by adjustments to the vehicle.

- Make all adjustments when the vehicle is at a standstill.



Warning

Risk of injury The passenger must be able to sit securely on the passenger seat.

- The passenger must hold on to the rider or supporting strap firmly and place his/her feet on the passenger footrests. Observe the regulations concerning the minimum age for passengers in your country.



Warning

Danger of accidents Danger of accidents caused by dangerous driving.

- Observe the traffic regulations and ride defensively and with foresight in order to recognize danger as early as possible.



Warning

Danger of accidents Reduced road grip with cold tires.

- On every journey, take the first miles carefully at moderate speed until the tires reach operating temperature and optimal road grip is ensured.



Warning

Danger of accidents Reduced road grip with new tires.

- New tires have a smooth rolling surface and therefore cannot provide full road grip. The entire rolling surface must be roughened in the first 200 kilometers (124.3 miles) by moderate riding at alternating angles. The full grip levels are not achieved until the tires have been run in.



Warning

Danger of accidents Unstable handling characteristics.

- Do not exceed the maximum permitted weight and axle loads. The overall weight consists of: motorcycle operational and with a full tank, driver and passenger with protective clothing and helmet, baggage.



Warning

Danger of accidents Unstable handling characteristics due to slipped baggage.

- Check the way your baggage is fixed regularly.



Warning

Danger of accidents Lack of roadworthiness.

- After a fall, check the vehicle as usual before putting it into operation.

Note

Engine failure Unfiltered intake air has a negative effect on the service life of the engine.

- Never ride the vehicle without an air filter since dust and dirt can get into the engine and result in increased wear.

Note

Engine damage Engine overheating.

- If the coolant temperature warning lamp lights up, stop the vehicle and switch off the engine. Let the engine cool down, and then check the coolant level in the radiator and top up if necessary. If you continue your journey with the coolant temperature warning lamp on, this may cause engine failure.



Info

If you hear unusual noises while riding, stop immediately, switch off the engine and contact an authorized KTM-RC8 workshop.

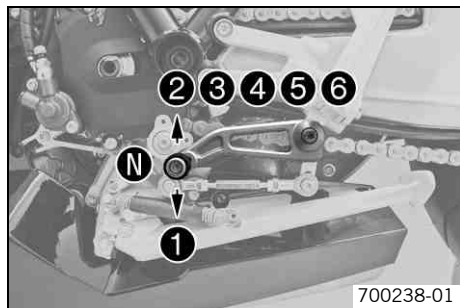

- When conditions allow (incline, road situation, etc.), you can shift into a higher gear.
- Release the throttle while simultaneously pulling the clutch lever, shift into the next gear, release the clutch and open the throttle.



Info

You can see the positions of the six forward gears in the figure. The neutral or idle position is between the first and second gears. First gear is used for starting off or for steep inclines.

- After reaching maximum speed by fully opening the throttle, turn the throttle back so it is $\frac{3}{4}$ open. This will barely reduce the speed but fuel consumption will be considerably lower.
- Accelerate only up to a speed suitable for the road surface and weather conditions. When traveling in bends, do not shift, and accelerate very carefully.
- To shift down, brake if necessary and close the throttle at the same time.
- Pull the clutch lever and shift into a lower gear, release the clutch lever slowly and open the throttle or shift again.
- If the engine stalls (e.g. at a crossroads), pull the clutch lever only and press the starter button. You do not have to shift into neutral.

- Switch off the engine if you expect to be standing for a long time.
- If the **EFI** warning lamp (**MIL**) starts to light up during the journey, stop immediately. If you shift to neutral, the **EFI** warning lamp (**MIL**) begins to blink.



Info

From the flashing rhythm, you can derive a two-digit number, the so-called blink code. The flashing code tells you which component has a fault.

Braking



Warning

Danger of accidents If you brake too hard, the wheels can lock.

- Adapt your braking to the traffic situation and the road conditions.



Warning

Danger of accidents Reduced braking efficiency due to wet or dirty brakes.

- Clean or dry dirty or wet brakes by riding and braking gently.



Warning

Danger of accidents Reduced braking effect caused by spongy pressure point of front or rear brake.

- Have the brake system checked in an authorized KTM-RC8 workshop before continuing your journey.



Warning

Danger of accidents Failure of brake system.

- If the foot brake lever is not released, the brake linings drag permanently. The rear brake can fail due to overheating. Take your foot off the foot brake lever if you do not want to brake.



Warning

Danger of accidents Longer stopping distance due to higher overall weight.

- Take the longer stopping distance into account when carrying a passenger and baggage.



Warning

Danger of accidents Delayed brake action on salted roads.

- There may be salt deposits on the brake discs. In order to restore the normal braking efficiency, you will need to remove the deposits from the discs by carefully applying the brakes.

-
- When braking, first throttle back and then apply the front and rear brakes at the same time.
 - On wet or slippery surfaces, mainly use the rear brake.
 - Braking should always be completed before you enter a bend. Shift down to a lower gear that is appropriate to the vehicle speed.
 - On long downhill stretches, use the braking effect of the engine. Do this by changing down two gears, but do not race the engine. You will require less braking force and the brakes will not overheat.

Stopping, parking



Warning

Risk of misappropriation Usage by unauthorized persons.

- Never leave the vehicle while the engine is running. Secure the vehicle against use by unauthorized persons. If you leave the vehicle, lock the steering and remove the ignition key.



Warning

Danger of burns Some vehicle components get very hot when the vehicle is in use.

- Do not touch hot components such as exhaust system, radiator, engine, shock absorber and brakes. Allow these components to cool down before starting work on them.

Note

Danger of damage The parked vehicle may roll away or fall over.

- Always place the vehicle on a firm and even surface.

Note

Fire hazard Some vehicle components become very hot when the vehicle is operated.

- Do not park the vehicle near flammable or explosive substances. Do not place objects on the vehicle while it is still warm from being run. Always let the vehicle cool first.

Note

Material damage Damage and destruction of components by excessive load.

- The side stand is designed for the weight of the motorcycle only. Do not sit on the motorcycle when it is supported by the side stand only. The side stand and/or the frame could be damaged and the motorcycle could fall over.

-
- Apply the brakes.
 - Shift into neutral.
 - Switch off the ignition by turning the black programming key to the position **OFF** ☒.



Info

If you switch off the engine with the emergency OFF switch but the ignition remains switched on at the ignition lock, power continues to flow to most power consumers and the battery is soon discharged. Therefore, always switch off the engine with the ignition key, the emergency OFF switch is provided for emergency situations only.

-
- Park the motorcycle on firm ground.
 - Swing the side stand to the front with your foot as far as it will go, and lean the vehicle onto it.
 - Lock the steering, by turning it to the left, press black ignition key down to position **OFF** ☒ and turn to position ☒. In order to ease steering lock engagement, move the handlebars gently back and forth. Remove the black ignition key.

Refueling



Danger

Fire hazard Fuel is highly flammable.

- Never refuel the vehicle near open flames or burning cigarettes, and always switch off the engine first. Be careful that no fuel is spilt, especially on hot vehicle components. Clean up spilt fuel immediately.
- Fuel in the fuel tank expands when warm and can escape if the tank is overfilled. See the notes on refueling.



Warning

Danger of poisoning Fuel is poisonous and a health hazard.

- Avoid contact of the fuel with skin, eyes and clothing. Do not inhale fuel vapors. If fuel gets into your eyes, rinse immediately with water and contact a doctor. Wash affected skin areas immediately with soap and water. If fuel is swallowed, contact a doctor immediately. Change clothing that has come into contact with fuel.



Warning

Environmental hazard Improper handling of fuel is a danger to the environment.

- Do not allow fuel to get into the ground water, the ground, or the sewage system.



Info

This motorcycle is equipped with a regulated catalytic converter. Leaded fuel will destroy the catalytic converter. You should therefore use unleaded fuel only.

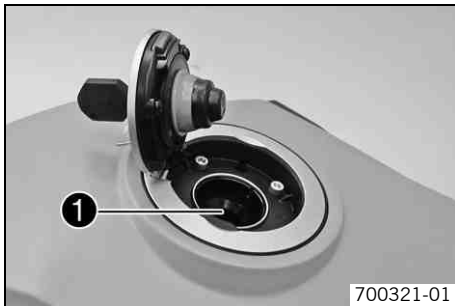

- Switch off the engine.
- Open the filler cap. (☛ p. 77)
- Fill the fuel tank with fuel up to the lower edge ❶ of the fuel filler.

Total fuel tank capacity, approx.	16.5 l (4.36 US gal)	Super unleaded (ROZ 95 / RON 95 / PON 91) (☛ p. 236)
-----------------------------------	-------------------------	--

- Close the filler cap. (☛ p. 78)

Service schedule

	K10N	K100A	K200A	K400A
Check that the electrical equipment is functioning properly.	•	•	•	•
Read out the trouble code memory using the KTM diagnostics tool. 🛠️	•	•	•	•
Change the engine oil and filter, clean the oil screen. 🛠️ (📖 p. 194)	•	•	•	•
Check the oil jet for the clutch lubrication. 🛠️	•		•	•
Check the front brake linings. (📖 p. 138)	•	•	•	•
Check the front brake discs. (📖 p. 133)	•	•	•	•
Check the rear brake linings. (📖 p. 141)	•	•	•	•
Check the rear brake disc. (📖 p. 134)	•	•	•	•
Check that brake lines are undamaged and free of leaks.	•	•	•	•
Check the rear brake fluid level. (📖 p. 139)	•	•	•	•
Check the free travel of the foot brake lever. (📖 p. 125)	•	•	•	•
Check that the shock absorber and fork are leak tight. If necessary and depending on use, service the fork and shock absorber.	•	•	•	•
Check the swingarm bearings. 🛠️		•	•	•
Check wheel bearings for play. 🛠️		•	•	•
Check the tire condition. (📖 p. 150)	•	•	•	•
Check the tire pressure. (📖 p. 152)	•	•	•	•
Check the chain, rear sprocket and engine sprocket. (📖 p. 131)		•	•	•
Check the chain tension. (📖 p. 128)	•	•	•	•
Grease all moving parts (e.g. side stand, hand lever, chain, ...) and check for smooth operation. 🛠️	•	•	•	•
Clean the dust boots of the fork legs.		•	•	•
Check the front brake fluid level. (📖 p. 135)	•	•	•	•

	K10N	K100A	K200A	K400A
Bleed fork legs. (☞ p. 105)		•	•	•
Check the steering head bearing play.	•	•	•	•
Change the spark plugs. 🛠️			•	•
Check the valve clearance. 🛠️			•	•
Check all hoses (e.g. fuel, cooling, bleeder, drainage, etc.) and bellows for cracking, leaks, and correct routing. 🛠️			•	•
Drain the drainage hose of the air filter box. 🛠️		•	•	•
Check the antifreeze and coolant level.	•	•	•	•
Check the wiring harness of the throttle valve body for damage and correct routing. 🛠️			•	•
Check cables for damage and kink-free routing. 🛠️		•	•	•
Check that the cables are undamaged, routed without sharp bends and set correctly.	•	•	•	•
Check the play in the throttle cable. (☞ p. 184)	•	•	•	•
Change the air filter. Clean the air filter box. 🛠️		•	•	•
Check the fluid level of the hydraulic clutch. (☞ p. 182)		•	•	•
Check the screws and nuts for tightness. 🛠️	•	•	•	•
Change the coolant. 🛠️				•
Change the front brake fluid. 🛠️			•	•
Change the rear brake fluid. 🛠️			•	•
Check the clutch. 🛠️			•	•

	K10N	K100A	K200A	K400A
Check the headlight setting. (☛ p. 174)	•	•	•	•
Check that the radiator fan is functioning properly. ☛	•	•	•	•
Final check: Check the vehicle for roadworthiness and take a test ride.	•	•	•	•
Read out the fault memory using the KTM diagnostics tool after a test ride. ☛	•	•	•	•
Make the service entry in KTM DEALER.NET and in the service record. ☛	•	•	•	•

K10N: Once after 1,000 km (621.4 mi)

K100A: Every 10,000 km (6,214 mi) or annually

K200A: Every 20,000 km (12,428 mi) or every 2 years or after every sporting use

K400A: Every 40,000 km (24,855 mi) or every 4 years

Jacking up motorcycle front

Note

Danger of damage The parked vehicle may roll away or fall over.

- Always place the vehicle on a firm and even surface.

- Jack up the motorcycle at the rear. (☛ p. 101)
- Move the handlebar to the straight-ahead position. Align the work stand at the front with the adapters to the fork legs.

Front work stand (61029055300)



Info

Always jack up the rear of the motorcycle first.

- Jack up the motorcycle at the front.



Taking front of motorcycle off work stand

Note

Danger of damage The parked vehicle may roll away or fall over.

- Always place the vehicle on a firm and even surface.

- Secure the motorcycle against falling over.
- Remove the work stand from the front.

Jacking up motorcycle at the rear

Note

Danger of damage The parked vehicle may roll away or fall over.

- Always place the vehicle on a firm and even surface.



- Insert the work stand adapter in the rear of the work stand.

Work stand adapter (61029055120)

Work stand rear (61029055100)

- Stand the motorcycle upright, align the work stand to the link fork and the adapters, and jack up the motorcycle.

Taking the rear from the workstand

Note

Danger of damage The parked vehicle may roll away or fall over.

- Always place the vehicle on a firm and even surface.
- Secure the motorcycle against falling over.
- Remove the work stand from the rear and lean the vehicle on the side stand.

Fork/shock absorber

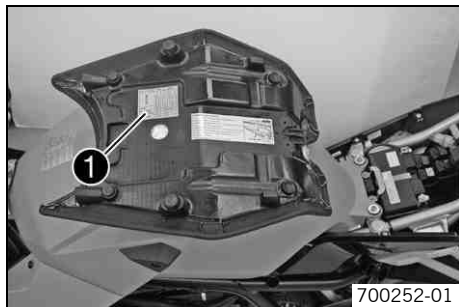

The fork and the shock absorber offer many options of adapting the chassis to your riding style and the payload.



Info

To help you adapt the vehicle, we have summarized our findings in Table ❶. You will find the table on the underside of the seat. In all settings except for the spring preload of the shock absorber, the value is adjusted by first turning the screw all the way in and then setting the value. Do not tighten the adjusting screw up against the stop with force, set the last discernible click as the last position.

These adjustments should be understood as a guideline and should always be the basis of your own personal chassis adaptation. Do not change the adjustments at random or by more than $\pm 40\%$, since otherwise the riding characteristics could deteriorate, particularly at high speeds.

Adjusting the compression damping of the fork



Info

The hydraulic compression damping determines the fork suspension behavior. An optimally adjusted compression damping ensures that the fork does not compress too far and fast when you brake hard or when the load shifts very fast. It gives the rider good feedback about the road conditions.

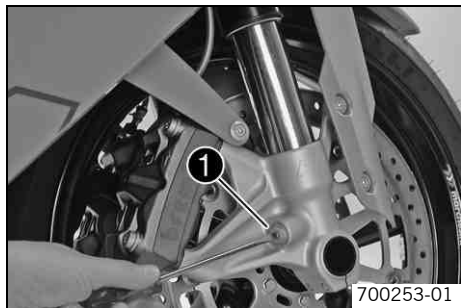

- Turn adjusting screws ❶ clockwise until they stop.

i **Info**

The adjusting screws are located at the bottom end of the fork legs. Make the same adjustment on both fork legs.

- Turn back counterclockwise by the number of clicks corresponding to the fork type.

Guideline

Compression damping	
Comfort	15 clicks
Standard	10 clicks
Sport	5 clicks
Full payload	5 clicks

i **Info**

Turn clockwise to increase damping, turn counterclockwise to reduce suspension damping.

Adjusting the rebound damping of the fork

i **Info**

The hydraulic rebound damping determines the fork suspension behavior. An optimally adjusted rebound damping brakes the springing energy and enables a fast, vibration-free resetting of the fork to the zero position.

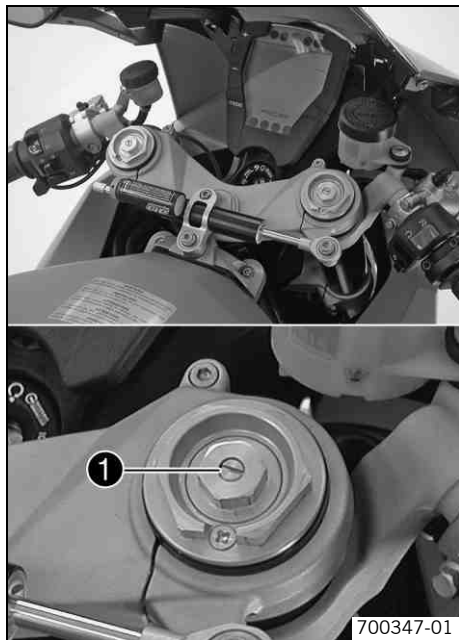

- Turn adjusting screws ❶ clockwise until they stop.



Info

The adjusting screws are located at the top end of the fork legs. Make the same adjustment on both fork legs.

- Turn back counterclockwise by the number of clicks corresponding to the fork type.

Guideline

Rebound damping	
Comfort	15 clicks
Standard	10 clicks
Sport	5 clicks
Full payload	5 clicks



Info

Turn clockwise to increase damping, turn counterclockwise to reduce suspension damping.

Adjusting the spring preload of the fork



Info

The spring preload defines the initial situation of the spring process of the fork.

The best spring preload setting is achieved when it is set for the weight of the rider and that of any baggage and a passenger, thus ensuring an ideal compromise between maneuverability and stability.

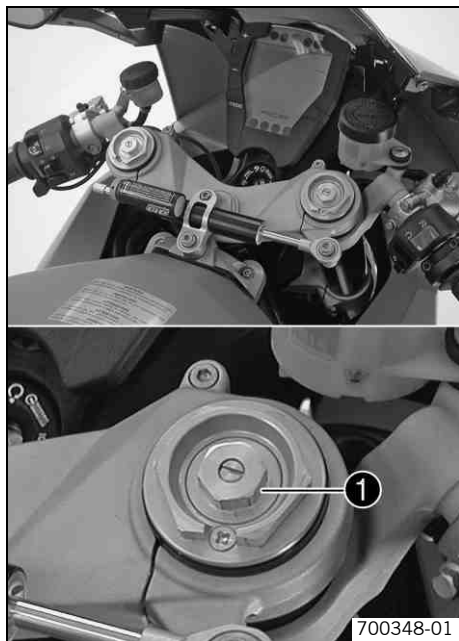

- Turn adjusting screws ❶ clockwise until they are resting against the stop.



Info

The adjustment screws are located at the top end of the fork legs. Make the same adjustment on both fork legs.

- Turn back counterclockwise by the number of turns corresponding to the fork type.

Guideline

Spring preload - Preload Adjuster	
Comfort	5 turns
Standard	5 turns
Sport	3 turns
Full payload	3 turns



Info

Turn clockwise to increase preload, turn counterclockwise to reduce spring preload. Changing the spring preload has no influence on the rebound damping although the adjusting screws turn during the adjustment work. However, you should also adjust the rebound damping when you alter the spring preload.

Bleeding fork legs

- Lean the motorcycle on the side stand.

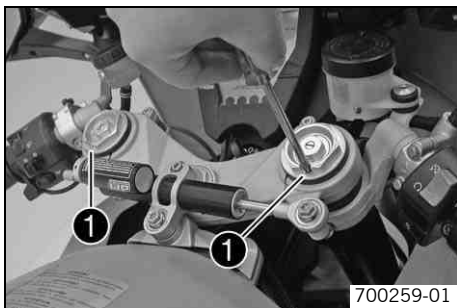

- Remove bleeder screws ❶ briefly.
- ✓ Any excess pressure escapes from the interior of the fork.
- Mount and tighten bleeder screws.



Info

Perform this action on both fork legs.

Compression damping of the shock absorber



The shock absorber can regulate compression damping separately in the low-speed and high-speed ranges (Dual Compression Control). The terms low-speed and high-speed refer to the movement of the shock absorber during compression and not the riding speed of the motorcycle. Changes in the low-speed range settings have an impact on the high-speed range and vice versa.

Adjusting the low-speed compression damping of the shock absorber



Danger

Danger of accidents Disassembly of pressurized parts can lead to injury.

- The shock absorber is filled with high density nitrogen. Adhere to the description provided. (Your authorized KTM RC8 workshop will be pleased to help.)

i Info
The low-speed setting can be seen during the slow to normal compression of the shock absorber.

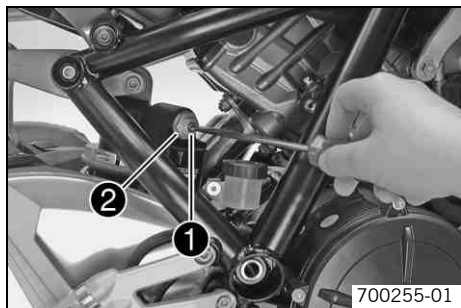

- Turn adjusting screw **1** clockwise with a screwdriver up to the last perceptible click.

i Info
Do not loosen nut **2**!

- Turn back counterclockwise by the number of clicks corresponding to the shock absorber type.

Guideline

Compression damping, low-speed	
Comfort	20 clicks
Standard	15 clicks
Sport	10 clicks
Full payload	10 clicks

i Info
Turn clockwise to increase damping; turn counterclockwise to reduce damping.

Adjusting the high-speed compression damping of the shock absorber

! Danger
Danger of accidents Disassembly of pressurized parts can lead to injury.

- The shock absorber is filled with high density nitrogen. Adhere to the description provided. (Your authorized KTM RC8 workshop will be pleased to help.)

i Info
The high-speed setting can be seen during the fast compression of the shock absorber.

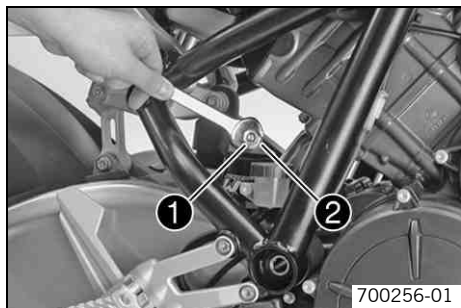

- Turn adjusting screw **1** clockwise with an open-ended spanner until it stops.

i Info
Do not loosen nut **2**!

- Turn back counterclockwise the number of turns corresponding to the shock absorber type.

Guideline

Compression damping, high-speed	
Comfort	3 turns
Standard	2.5 turns
Sport	1.5 turns
Full payload	1.5 turns

i Info
Turn clockwise to increase damping; turn counterclockwise to reduce damping.

Adjusting the rebound damping of the shock absorber

! Danger
Danger of accidents Disassembly of pressurized parts can lead to injury.

- The shock absorber is filled with high density nitrogen. Adhere to the description provided. (Your authorized KTM RC8 workshop will be pleased to help.)

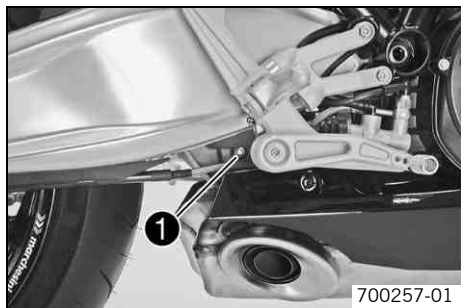

- Turn adjusting screw ❶ clockwise up to the last perceptible click.
- Turn back counterclockwise by the number of clicks corresponding to the shock absorber type.

Guideline

Rebound damping	
Comfort	15 clicks
Standard	10 clicks
Sport	5 clicks
Full payload	10 clicks

i Info
 Turn clockwise to increase suspension damping; turn counterclockwise to reduce damping.

Adjusting the spring preload of the shock absorber ↩

⚠ Warning
Danger of accidents Modifications to the suspension settings can seriously alter the vehicle's ride behavior.

- Following modifications, ride slowly at first to get the feel of the new ride behavior.

i Info
 The spring preload defines the initial situation of the spring process on the shock absorber. The best spring preload setting is achieved when it is set for the weight of the rider and that of any baggage and a passenger, thus ensuring an ideal compromise between maneuverability and stability.

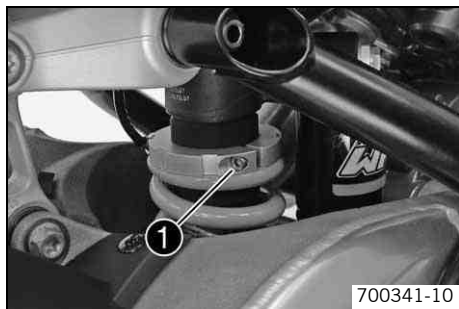

- Take the weight off the rear wheel and swingarm.



Info

The spring preload can be adjusted correctly only if the rear wheel and the swingarm are fully relieved of weight.

- Loosen screw ❶ two turns, but do not remove.

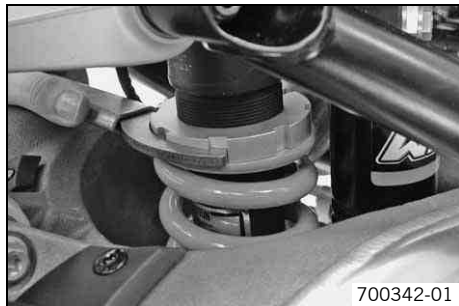

- Turn the adjusting ring counterclockwise with the toolset wrench until the spring is completely relaxed.

Hook wrench (69012022000)
Extension (60012060000)

- Turn the adjusting ring clockwise and tension it to the specified value.

Guideline

Spring preload	
Comfort	6 mm (0.24 in)
Standard	6 mm (0.24 in)
Sport	8 mm (0.31 in)
Full payload	8 mm (0.31 in)



Info

Turn clockwise to increase preload, turn counterclockwise to reduce spring preload.

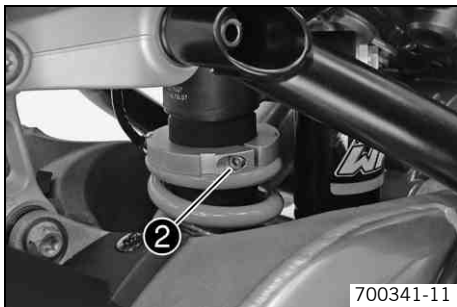

- Tighten screw ②.

Guideline

Remaining frame bolts	M5	5 Nm (3.7 lbf ft)
-----------------------	----	-------------------

Steering damper



The steering damper suppresses shocks to the steering arising from acceleration on uneven ground at high speed or when the load is temporarily taken from the front wheel. The steering damper is adjusted to suit the manner of riding style and the road conditions. For high speeds, an adjustment with high damping can be chosen in order to use the steering damping function optimally. In slow, tight bends, intensive damping can negatively affect handling and steering precision, so the damping should be set to low.

Adjusting the steering damper



Info

The hydraulic steering damper stabilizes the steering if the front wheel is raised off the ground or carries no load. In contrast to other damping elements, the steering damper is adjusted with the damping element open.

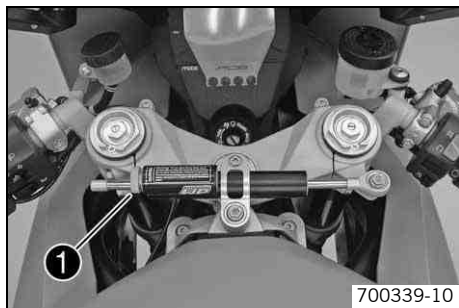

- Turn the adjusting screw ❶ counterclockwise towards "-" as far as the last perceptible click.
- Adjust the steering damper according to your riding style and the road conditions by turning the adjust screw clockwise towards "+".

Guideline

Steering damper adjustment range	1... 32 clicks
Recommended range for use	1... 20 clicks
Standard	1 click

i Info

Do not change the adjustment of the steering damper during the journey!
After adjusting the steering damper, check the steering for smooth operation, making sure that the handlebar can be moved from extreme left to extreme right without a tendency to lock.

Vehicle level

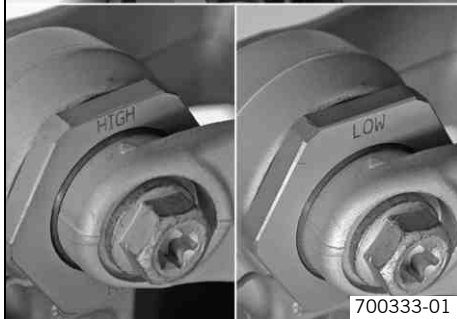

Warning

Danger of accidents Modifications to the suspension settings can seriously alter the vehicle's ride behavior.

- Following modifications, ride slowly at first to get the feel of the new ride behavior.

The vehicle level can be adjusted at the front by means of the fork leg clamp and at the rear by the eccentric shaft.

The fork legs can be clamped at three positions in the triple clamps.

Upper triple clamp flush with upper edge of fork legs	0 mm (0 in)
Upper triple clamp flush with 1st ring of fork legs	2.5 mm (0.098 in)
Upper triple clamp flush with 2nd ring of fork legs (standard)	5 mm (0.2 in)

The chassis height can be adjusted steplessly by turning the eccentric shaft.

Chassis height difference HIGH - LOW	7 mm (0.28 in)
Maximum adjustment range between HIGH - LOW	180°

Adjusting front vehicle level

-  **Warning**
Danger of accidents Modifications to the suspension settings can seriously alter the vehicle's ride behavior.
- Following modifications, ride slowly at first to get the feel of the new ride behavior.

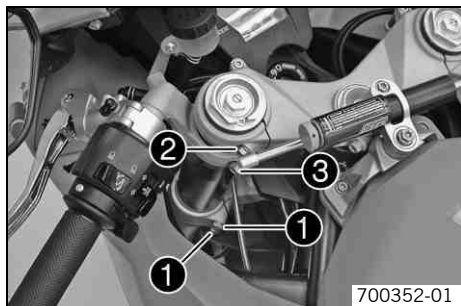

- Loosen screws ❶ on the lower triple clamp.
- Loosen screw ❷ on the upper triple clamp.
- Loosen screw ❸ of the handlebar stub.

 **Info**
 Loosen the screws far enough to prevent damage to the lacquer when the fork legs are moved.
 Make the adjustments first on one fork leg and then on the other. When the screws of both fork legs are loosened, the vehicle sags toward the front.

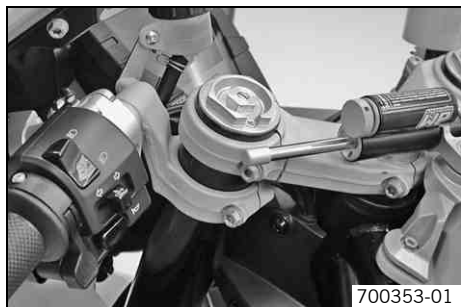

- Align the fork leg in the desired position by means of the fork rings.

Guideline

Upper triple clamp flush with upper edge of fork legs	0 mm (0 in)
Upper triple clamp flush with 1st ring of fork legs	2.5 mm (0.098 in)
Upper triple clamp flush with 2nd ring of fork legs (standard)	5 mm (0.2 in)

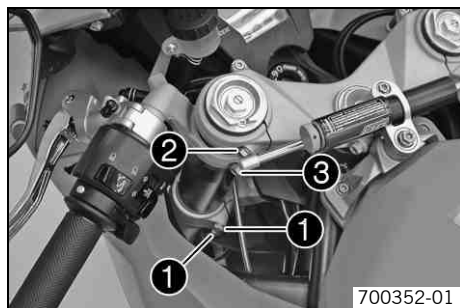

i **Info**

The standard adjustment is the setting that provides the best vehicle handling. When the fork is compressed, the suspension setting changes, causing the vehicle to become more stable but also more difficult to handle.

- Tighten screw ②.

Guideline

Screw, top triple clamp	M8	17 Nm (12.5 lbf ft)
-------------------------	----	------------------------

- Tighten screws ①.

Guideline

Screw, bottom triple clamp	M8	15 Nm (11.1 lbf ft)
----------------------------	----	------------------------

- Tighten screw ③.

Guideline

Screw, handlebar stub	M8	20 Nm (14.8 lbf ft)
-----------------------	----	------------------------

- Repeat the adjustment on the other fork leg.

i **Info**

The vehicle level setting on both fork legs must be identical.

Adjusting the vehicle level at the rear

- Warning**
Danger of accidents Modifications to the suspension settings can seriously alter the vehicle's ride behavior.
- Following modifications, ride slowly at first to get the feel of the new ride behavior.

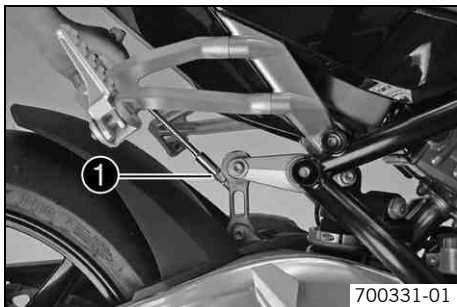

- Loosen screw ❶ but do not remove it.

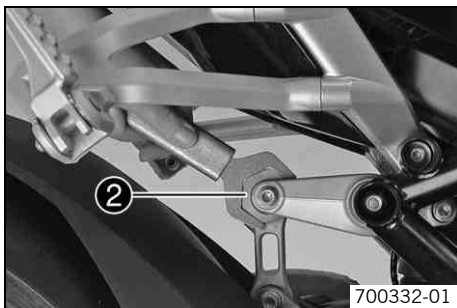

- Turn eccentric shaft ❷ to the desired position using the tool from the tool set.

Guideline

Standard	LOW
Maximum adjustment range between HIGH - LOW	180°

Open end wrench SW 38 (69012021000)



Info

The chassis height can be adjusted in both directions.

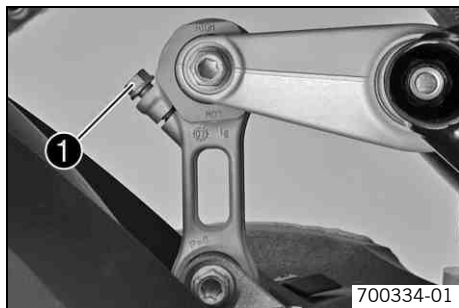

- Tighten screw ❶.

Guideline

Screw, clamp, eccentric shaft of deflector	M8	18 Nm (13.3 lbf ft)
--	----	------------------------

Footrest position

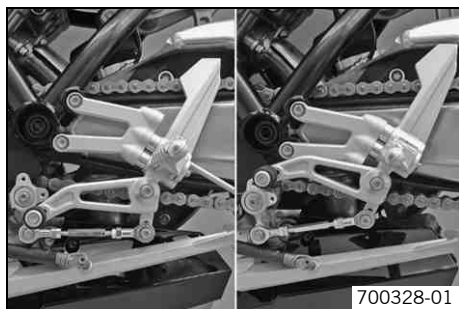

The adjustable footrest system enables an individual setting of the footrest height and an individual adjustment of the controls.
The lower footrest position enables a more comfortable knee angle, the upper footrest position a sporting sitting position and more forward-leaning freedom for use in racing.

Adjusting footrest position



Info

The footrest position must be identical on the left and the right.

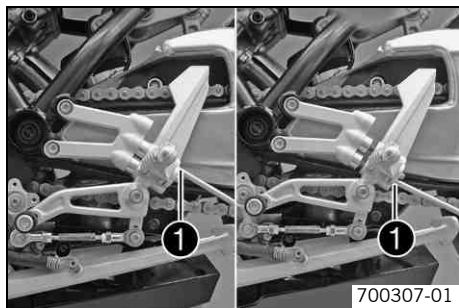

- Remove screws ❶.

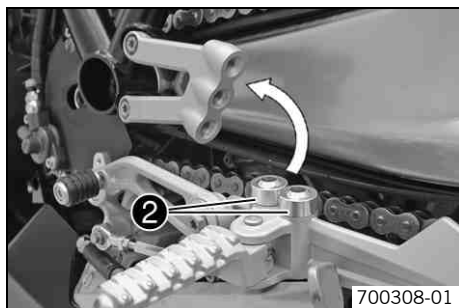

- Position the footrest bracket with spacers ❷ and screws.

Guideline

Standard	Lower position
----------	----------------

i Info

The adjustable footrest bracket enables a more comfortable lower footrest position or a sporting upper footrest position.

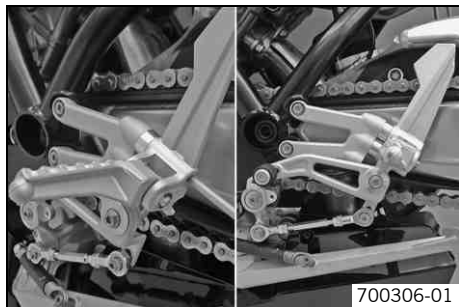

- Mount and tighten screws.

Guideline

Screw, front footrest bracket	M8	25 Nm (18.4 lbf ft)	Loctite® 243™
-------------------------------	----	------------------------	---------------

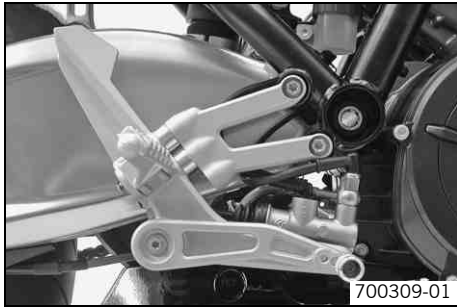

- Repeat adjustment work on the footrest bracket on the other side.
- Adjust the shift lever. (☛ p. 120)
- Adjust the foot brake lever. (☛ p. 125)

Adjusting shift lever stub

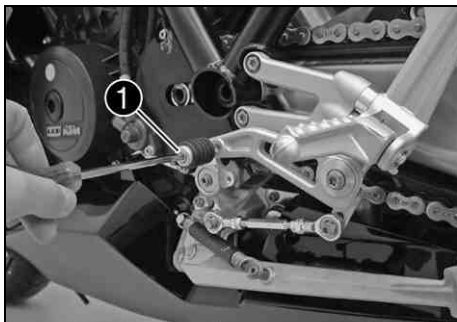

- Remove the screw ❶ with the shift lever stub.
- Position the shift lever stub with the screw in one of the holes ❷ according to the desired lever length.

Guideline

Standard	Central hole
----------	--------------

- Tighten screw.

Guideline

Screw, shift lever stub	M6	10 Nm (7.4 lbf ft)	Loctite® 243™
-------------------------	----	-----------------------	---------------

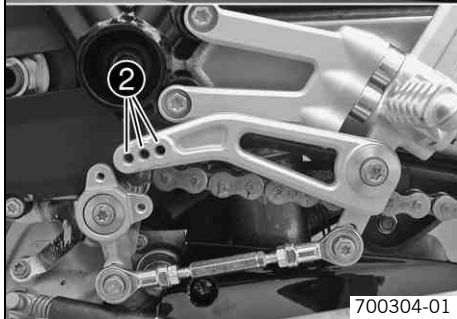

Adjusting shift lever

- i Info** The footrest system offers many ways of adjusting the shift lever to your riding style and requirements.

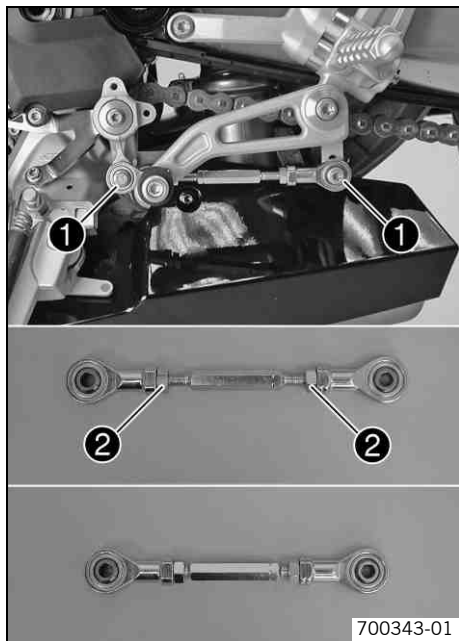

- Remove screws ❶ and take off the shift rod.
- The length of the shift rod can be adjusted by means of the screw thread.

Guideline

Shift rod	115... 130 mm (4.53... 5.12 in)
-----------	---------------------------------

- Loosen the counter nuts ❷.
- Adjust the shift shaft.

i Info

Make the same adjustments on both sides.
 After the counter nuts have been tightened, the bearings of the shift shaft must be central and aligned identically to each other in order to ensure freedom of movement in the bearing shells.
 At least 5 screw threads must be screwed into the seating.

- Tighten the counter nuts.

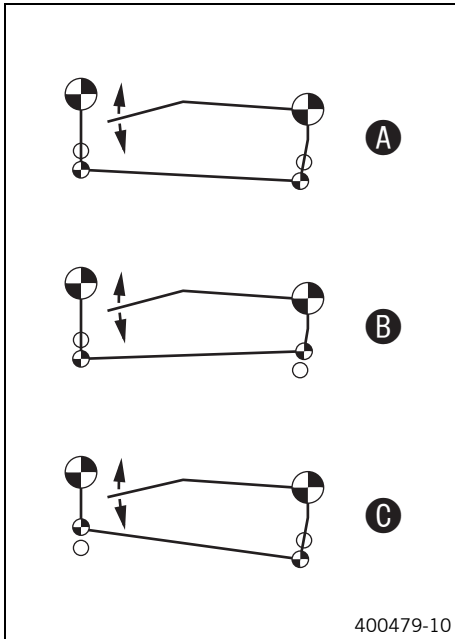

- The shift rod can be mounted both on the shift lever variably at an upper or lower position, and on the reverse gear change of the shift shaft in two different positions.

Guideline

Standard A	Shift lever: lower drill hole, shift shaft: lower drill hole
Shift power low, long shift travel B	Shift lever: lower drill hole, shift shaft: upper drill hole
Shift power high, short shift travel C	Shift lever: upper drill hole, shift shaft: lower drill hole

- Position the shift rod.
- Tighten the screws.

Guideline

Screw, shift rod	M6	12 Nm (8.9 lbf ft)	Loctite® 243™
------------------	----	-----------------------	----------------------

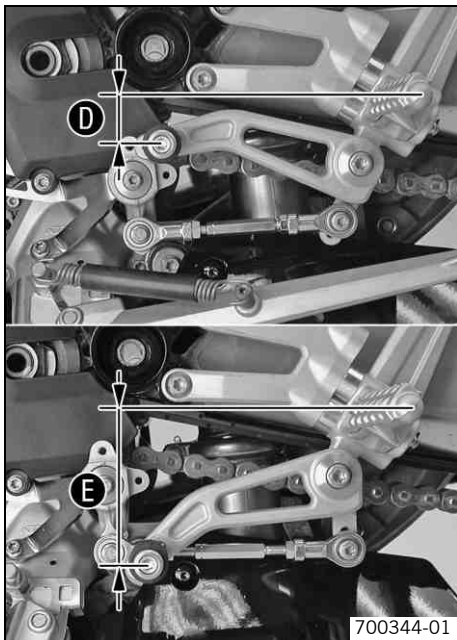

- The position of the shift lever can be greatly varied, depending on the length of the shift rod and the drill holes selected. As seen from the footrest, there is either a high position of the shift lever **D** or a low position of the shift lever **E**.

i **Info**

If you turn the reverse shift shaft 2 teeth on the serration of the shift shaft, you can adjust the footrest system optimally for the upper footrest position.

- After adjusting the shift lever, check its operation. There must be a minimum distance between the moving parts of the shift lever and other parts of the vehicle.

Guideline

Minimum clearance	5 mm (0.2 in)
-------------------	---------------

Adjusting the foot brake lever stub

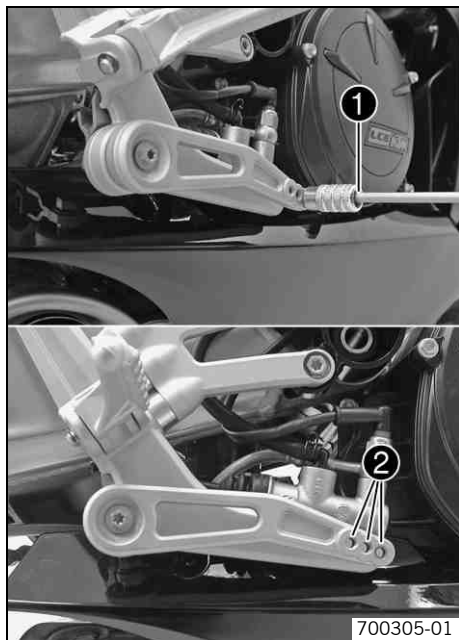

- Remove the screw ❶ with the foot brake lever stub.
- Position the foot brake lever stub with the screw in one of the holes ❷ according to the desired lever length.

Guideline

Standard	Central hole
----------	--------------

- Tighten the screw.

Guideline

Bolt, foot brake lever stub	M6	10 Nm (7.4 lbf ft)	Loctite® 243™
-----------------------------	----	-----------------------	---------------

Adjusting the foot brake lever

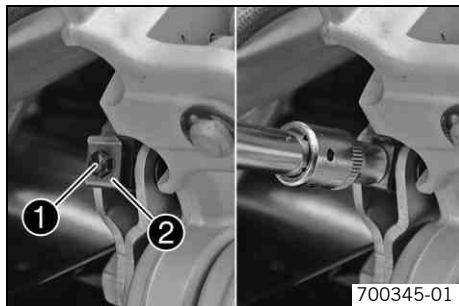

- Use the tool to press in the anti-rotation lock ②, then turn the piston rod ①.

i Info
The range of adjustment is limited.

- Remove the tool.
✓ The spring tension on the anti-rotation lock is released and the hex nut is locked.

- Check the foot brake lever setting.

i Info
Position ④ of the foot brake lever may vary considerably, depending on the setting.

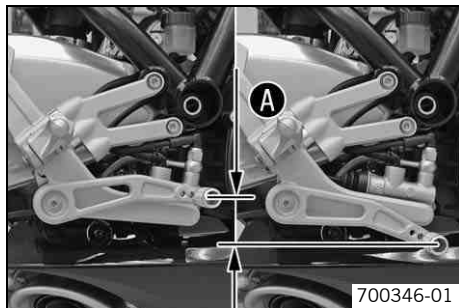

Checking free travel of foot brake lever

⚠ Warning
Danger of accidents Brake system failure.

- If there is no free travel on the foot brake lever, pressure builds up on the rear brake circuit. The rear brake can fail due to overheating. Adjust free travel on foot brake lever according to specifications.

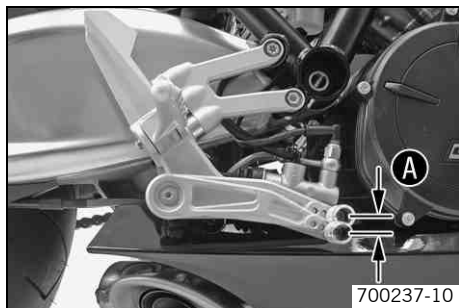

- Move the foot brake lever back and forth between the end stop and the contact to the foot brake cylinder piston and check free travel **A**.

Guideline

Free travel at foot brake lever	3... 5 mm (0.12... 0.2 in)
---------------------------------	----------------------------

i Info

The piston rod should not move in the process.

- » If the free travel does not meet specifications:
 - Adjust the free travel.

Checking for chain dirt

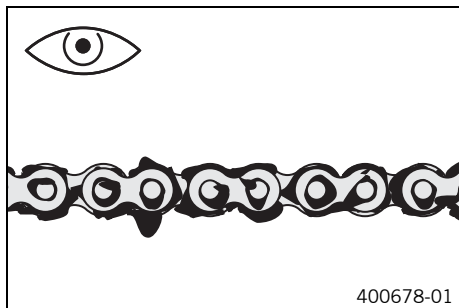

- Check the chain for loose dirt.
 - » If the chain is very dirty:
 - Clean the chain. (🔧 p. 126)

Cleaning the chain



Warning

Danger of accidents Oil or grease on the tires reduces their grip.

- Remove oil and grease with a suitable cleaning material.



Warning

Danger of accidents Reduced braking efficiency due to oil or grease on the brake discs.

- Always keep the brake discs free of oil and grease, and clean them with brake cleaner when necessary.



Warning

Environmental hazard Hazardous substances cause environmental damage.

- Oil, grease, filters, fuel, cleaners, brake fluid, etc., should be disposed of as stipulated in applicable regulations.



Info

The service life of the chain depends largely on its maintenance.

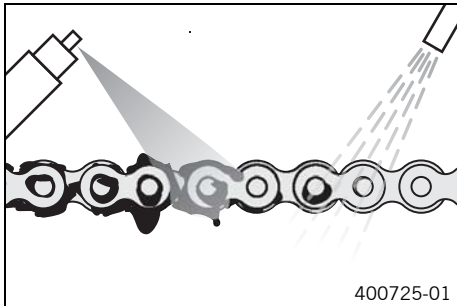

- Clean the chain regularly.
- Rinse off loose dirt with a soft jet of water.
- Remove old grease remains with chain cleaner.

Chain cleaner (☛ p. 237)

- After drying, apply chain spray.

Chain lube for road use (☛ p. 237)

Checking the chain tension



Warning

Danger of accidents Danger caused by incorrect chain tension.

- If the chain tension is too high, the components of the secondary power train (chain, engine sprocket, rear sprocket, bearings in transmission and rear wheel) are under additional load. Apart from premature wear, in extreme cases the chain can rupture or the countershaft of the transmission can break. On the other hand, if the chain is loose, it can fall off the engine sprocket or the rear sprocket and block the rear wheel or damage the engine. Check the chain tension and correct if necessary.

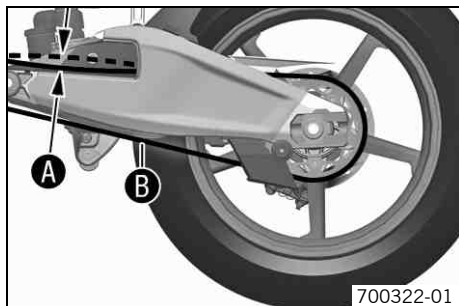

- Lean the motorcycle on the side stand.
- Shift into neutral.
- In the area in front of where the chain passes through the link fork, push the chain upward and measure chain tension **A**.



Info

The lower chain section **B** must be taut.

Chain wear is not always even, so you should repeat this measurement at different chain positions.

Chain tension	15... 20 mm (0.59... 0.79 in)
---------------	-------------------------------

- » If the chain tension does not meet specifications:
 - Adjust the chain tension. (🔧 p. 129)

Adjusting the chain tension



Warning

Danger of accidents Danger caused by incorrect chain tension.

- If the chain tension is too high, the components of the secondary power train (chain, engine sprocket, rear sprocket, bearings in transmission and rear wheel) are under additional load. Apart from premature wear, in extreme cases the chain can rupture or the countershaft of the transmission can break. On the other hand, if the chain is loose, it can fall off the engine sprocket or the rear sprocket and block the rear wheel or damage the engine. Check the chain tension and correct if necessary.

- Check the chain tension. (👉 p. 128)

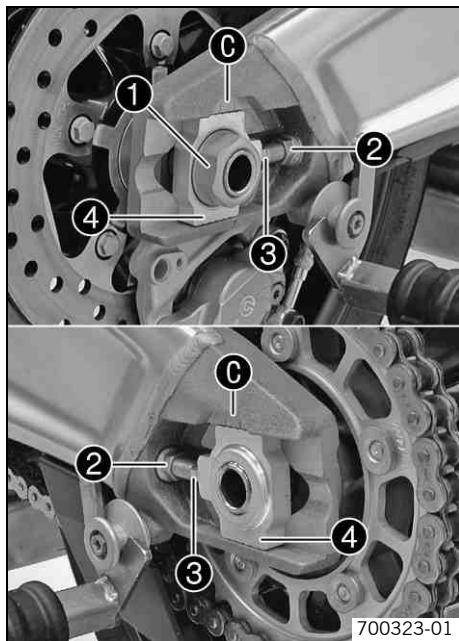

- Loosen nut ❶.
- Loosen nuts ❷.
- Adjust chain tension by turning the adjustment screws ❸ on the left and right.

Guideline

Chain tension	15... 20 mm (0.59... 0.79 in)
Turn the adjusting screws ❸ on the left and right so that the markings on the left and right chain adjuster ❹ are in the same position in relation to the reference marks ❷. The rear wheel is then correctly aligned.	

i Info

The lower chain section must be taut.

Chain wear is not always even, so you should check the setting at different chain positions.

- Tighten nuts ❷.
- Make sure that the chain adjusters ❹ are on the adjusting screws ❸.
- Tighten nut ❶.

Guideline

Nut, rear wheel spindle	M25x1.5	90 Nm (66.4 lbf ft)	Thread greased
-------------------------	---------	------------------------	----------------

i Info

The wide adjustment range of the chain adjuster (35mm / 1.38") allows different secondary transmission ratios to be used with the same chain length.

The chain adjusters ❹ can be turned through 180°.

Checking the chain, rear sprocket and engine sprocket

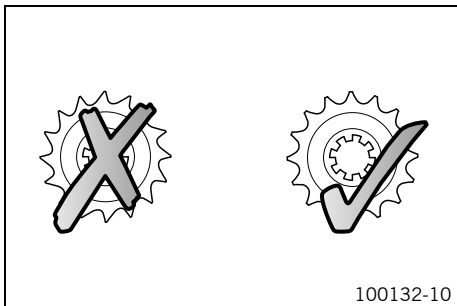

- Check the rear sprocket and engine sprocket for wear.
 - » If the rear sprocket and engine sprocket are worn:
 - Replace the rear sprocket or engine sprocket. 🛠️



Info

The engine sprocket, rear sprocket and chain should always be replaced together.

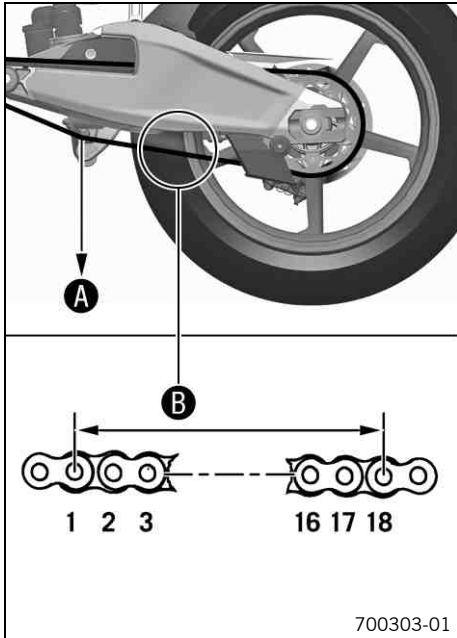

- Shift into neutral, and pull the lower chain section with the specified weight **A**.

Guideline

Weight, chain wear measurement	15 kg (33 lb.)
--------------------------------	----------------

- Measure the distance **B** of 18 chain links in the lower chain section.

i Info

Chain wear is not always even, so you should repeat this measurement at different chain positions.

Maximum distance B at the longest chain section	272 mm (10.71 in)
--	-------------------

- » If distance **B** is greater than the specified measurement:

- Replace the chain. 🛠️

i Info

When the chain is replaced, the rear sprocket and engine sprocket should also be changed.

A new chain wears out faster on old, worn sprockets.
For safety reasons, the chain has no chain joint.

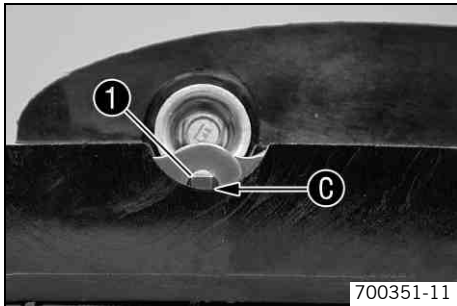

- Check the chain sliding guard for wear at the opening.
 - » If the rivets **1** of the chain are no longer visible at the lower edge **C** of the opening of the chain sliding guard:
 - Change the chain sliding guard. 🛠️
- Check that the chain sliding guard is firmly seated.
 - » If the chain sliding guard is loose:
 - Tighten the chain sliding guard.

Guideline

Remaining chassis screws	M6	10 Nm (7.4 lbf ft)
--------------------------	----	-----------------------

Checking the front brake discs

- Warning**
Danger of accidents Reduced braking efficiency due to worn brake disc(s).
- Change the worn brake disc(s) without delay. (Your authorized KTM RC8 workshop will be pleased to help.)

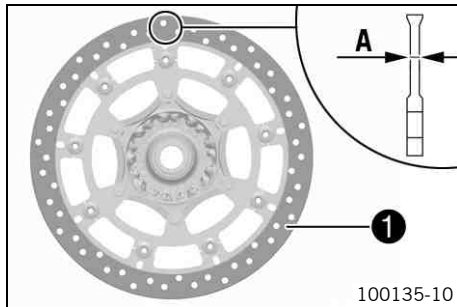

- Check the thickness of the brake disc in several places to see if it is within the specified wear tolerance **A**.

i Info
 Wear reduces the thickness of the brake discs in area **1** of the brake discs.

Brake discs - wear limit	
Front	4.0 mm (0.157 in)

- » If the brake disc thickness is less than the specified value:
 - Change the brake discs. 🛠️
- Check the brake discs for damage, cracking and deformation.
 - » If the brake discs exhibit damage, cracking or deformation:
 - Change the brake discs. 🛠️

Checking the rear brake disc

- Warning**
Danger of accidents Reduced braking efficiency due to worn brake disc(s).
- Change the worn brake disc(s) without delay. (Your authorized KTM RC8 workshop will be pleased to help.)

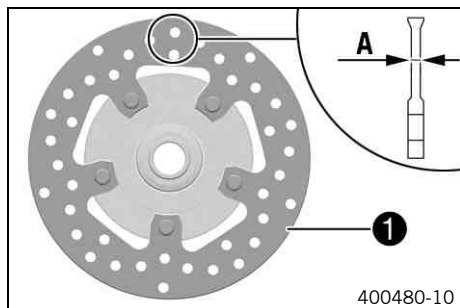

- Check the thickness of the brake disc in several places to see if it conforms to measurement **A**.

i Info
 Wear reduces the thickness of the brake disc in area **1** of the brake disc.

Brake disc - wear limit	
Rear	4.5 mm (0.177 in)

- » If the brake disc thickness is less than the specified value:
 - Change the brake disc. 🛠️
- Check the brake disc for damage, cracking and deformation.
 - » If damage, cracks or deformation are visible on the brake disc:
 - Change the brake disc. 🛠️

Adjusting the basic position of the hand brake lever

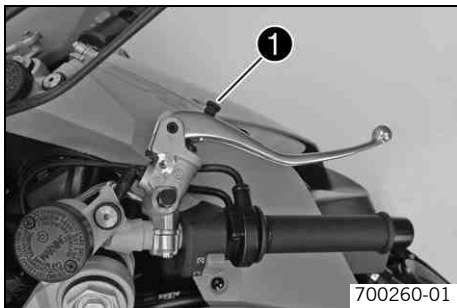

- Pull the brake lever forwards.
- Adjust the basic setting of the hand brake lever to your hand size by turning adjusting wheel ❶.



Info

Do not make any adjustments while riding!

Checking the front brake fluid level



Warning

Danger of accidents Failure of the brake system.

- If the brake fluid level falls below the **MIN** mark, this indicates a leakage in the brake system or worn-out brake linings. Check the brake system and do not continue riding. (Your authorized KTM RC8 workshop will be pleased to help.)



Warning

Danger of accidents Reduced braking effect caused by old brake fluid.

- Change the brake fluid of the front and rear brakes according to the service schedule. (Your authorized KTM RC8 workshop will be pleased to help.)

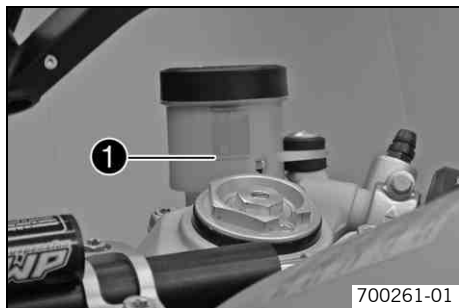

- Move the brake fluid reservoir mounted on the handlebar to a horizontal position.
- Check the brake fluid level in the brake fluid reservoir ❶.
 - » If the brake fluid is below the **MIN** marking:
 - Top up the brake fluid of the front brake. 🛠️ (👉 p. 136)

Topping up brake fluid of front brake 🛠️



Warning

Danger of accidents Failure of the brake system.

- If the brake fluid level falls below the **MIN** mark, this indicates a leakage in the brake system or worn-out brake linings. Check the brake system and do not continue riding. (Your authorized KTM RC8 workshop will be pleased to help.)



Warning

Skin irritation Brake fluid can cause skin irritation on contact.

- Avoid contact with skin and eyes, and keep out of the reach of children.
- Wear suitable protective clothing and goggles.
- If brake fluid gets into your eyes, rinse thoroughly with water and contact a doctor immediately.



Warning

Danger of accidents Reduced braking effect caused by old brake fluid.

- Change the brake fluid of the front and rear brakes according to the service schedule. (Your authorized KTM RC8 workshop will be pleased to help.)



Warning

Environmental hazard Hazardous substances cause environmental damage.

- Oil, grease, filters, fuel, cleaners, brake fluid, etc., should be disposed of as stipulated in applicable regulations.



Info

Never use DOT 5 brake fluid! It is silicone-based and purple in color. Oil seals and brake lines are not designed for DOT 5 brake fluid.

Avoid contact between brake fluid and painted parts. Brake fluid is corrosive and will damage painted surfaces.

Use only clean brake fluid from a sealed container!

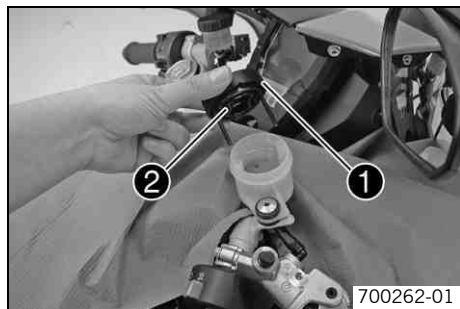

- Move the brake fluid reservoir mounted on the handlebar to a horizontal position.
- Loosen screw.
- Remove cap ❶ with membrane ❷.
- Add brake fluid to the **MAX** level.

Brake fluid DOT 4 / DOT 5.1 (☞ p. 233)

- Position the cap with the membrane. Mount and tighten the screws.



Info

Clean up overflowed or spilt brake fluid immediately with water.

Brake linings

The brake linings fitted by KTM have been tested over long periods and guarantee optimal braking characteristics. The type names of the brake linings are entered in the homologation documents.

Info

Brake linings available from accessory suppliers are often not tested and approved for use on KTM vehicles. The construction and friction factor of the brake linings and therefore the brake power can differ considerably from the original KTM brake linings. If brake linings are used that differ from the originals, there is no guarantee that they comply with the original license. The vehicle no longer corresponds to the condition at delivery, and the warranty is no longer valid.

Checking the front brake linings



Warning

Danger of accidents Reduced braking efficiency caused by worn brake linings.

- Change worn brake linings immediately. (Your authorized KTM RC8 workshop will be pleased to help.)

Note

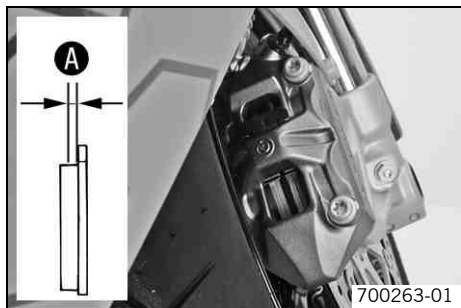

Danger of accidents Reduced braking efficiency caused by damaged brake discs.

- If the brake linings are not changed in time, the steel brake lining carriers grind on the brake disc. The braking effect is greatly reduced and the brake discs are rendered unserviceable. Check the brake linings regularly.



- Check all brake linings on both brake calipers to ensure they have minimum thickness **A**.

Minimum thickness A	$\geq 1 \text{ mm } (\geq 0.04 \text{ in})$
----------------------------	---

- » If the minimum thickness is less than specified:
 - Change the front brake linings. 
- Check all brake linings on both brake calipers for damage and cracking.
 - » If damage or wear is encountered:
 - Change the front brake linings. 

Checking the rear brake fluid level



Warning

Danger of accidents Failure of the brake system.

- If the brake fluid level falls below the **MIN** mark, this indicates a leakage in the brake system or worn-out brake linings. Check the brake system and do not continue riding. (Your authorized KTM RC8 workshop will be pleased to help.)



Warning

Danger of accidents Reduced braking effect caused by old brake fluid.

- Change the brake fluid of the front and rear brakes according to the service schedule. (Your authorized KTM RC8 workshop will be pleased to help.)

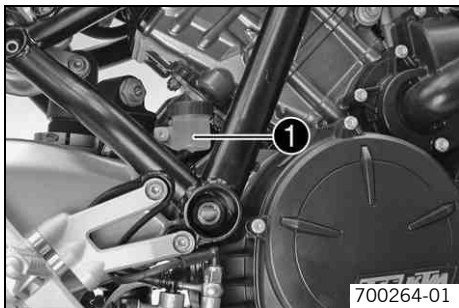

- Stand the vehicle upright.
- Check the brake fluid level of the brake fluid reservoir.
 - » If the fluid level reaches the **MIN** mark ❶:
 - Add rear brake fluid. 🛠️ (📖 p. 139)

Adding rear brake fluid 🛠️



Warning

Danger of accidents Failure of the brake system.

- If the brake fluid level falls below the **MIN** mark, this indicates a leakage in the brake system or worn-out brake linings. Check the brake system and do not continue riding. (Your authorized KTM RC8 workshop will be pleased to help.)



Warning

Skin irritation Brake fluid can cause skin irritation on contact.

- Avoid contact with skin and eyes, and keep out of the reach of children.
- Wear suitable protective clothing and goggles.
- If brake fluid gets into your eyes, rinse thoroughly with water and contact a doctor immediately.



Warning

Danger of accidents Reduced braking effect caused by old brake fluid.

- Change the brake fluid of the front and rear brakes according to the service schedule. (Your authorized KTM RC8 workshop will be pleased to help.)



Warning

Environmental hazard Hazardous substances cause environmental damage.

- Oil, grease, filters, fuel, cleaners, brake fluid, etc., should be disposed of as stipulated in applicable regulations.



Info

Never use DOT 5 brake fluid! It is silicone-based and purple in color. Oil seals and brake lines are not designed for DOT 5 brake fluid.

Avoid contact between brake fluid and painted parts. Brake fluid is corrosive and will damage painted surfaces.

Use only clean brake fluid from a sealed container!

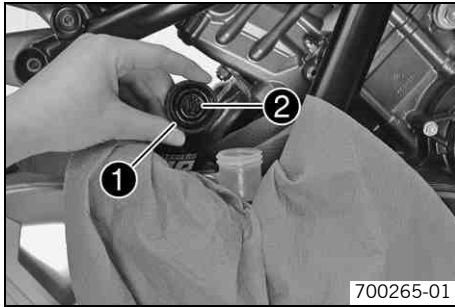

- Stand the vehicle upright.
- Remove screw cap ❶ with membrane ❷.
- Add brake fluid to the **MAX** level.

Brake fluid DOT 4 / DOT 5.1 (☞ p. 233)

- Refit screw with membrane.



Info

Clean up overflowed or spilt brake fluid immediately with water.

Checking the rear brake linings



Warning

Danger of accidents Reduced braking efficiency caused by worn brake linings.

- Change worn brake linings immediately. (Your authorized KTM RC8 workshop will be pleased to help.)

Note

Danger of accidents Reduced braking efficiency caused by damaged brake discs.

- If the brake linings are not changed in time, the steel brake lining carriers grind on the brake disc. The braking effect is greatly reduced and the brake discs are rendered unserviceable. Check the brake linings regularly.

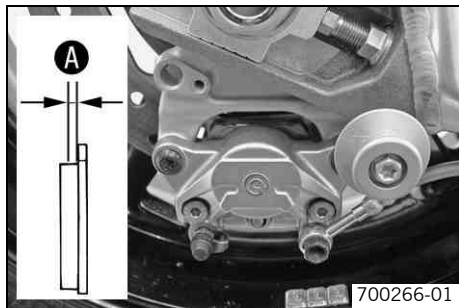

- Check the brake linings for minimum thickness **A**.

Minimum thickness A	$\geq 1 \text{ mm } (\geq 0.04 \text{ in})$
----------------------------	---

- » If the minimum thickness is less than specified:
 - Change the rear brake linings. 🛠️
- Check the brake linings for damage and cracking.
 - » If damage or wear is encountered:
 - Change the rear brake linings. 🛠️

Removing the front wheel 🛠️

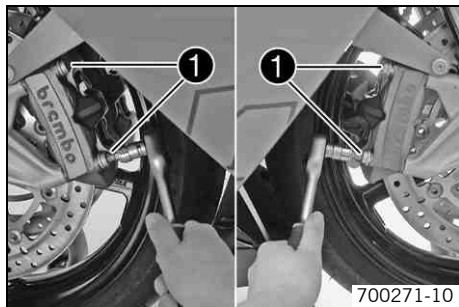

- Jack up the motorcycle at the rear. (🛠️ p. 101)
- Jack up the motorcycle at the front. (🛠️ p. 100)
- Remove the screws **1** from both brake calipers.
- Press back the brake linings with a light lateral tilting of the brake calipers on the brake disc. Pull the brake calipers carefully back from the brake discs and hang them to one side.

i Info

Do not pull the hand brake lever when the brake calipers are removed.

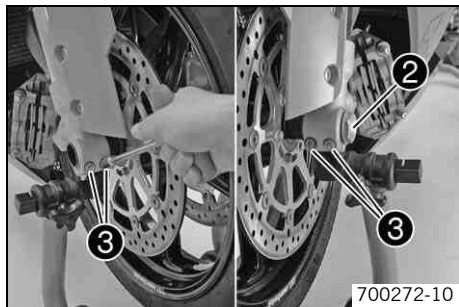

- Loosen screws ② and ③.
- Unscrew screw ② about six turns and press your hand on the screw to push the wheel spindle out of the axle clamp. Remove screw ②.



Warning

Danger of accidents Reduced braking efficiency caused by damaged brake discs.

- Always lay the wheel down in such a way that the brake discs are not damaged.
-
- Holding the front wheel, withdraw the wheel spindle. Take the front wheel out of the fork.
 - Remove spacers ④.

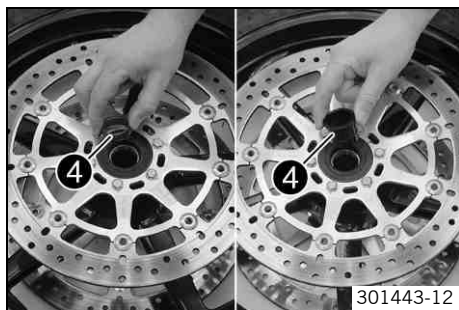

Installing the front wheel

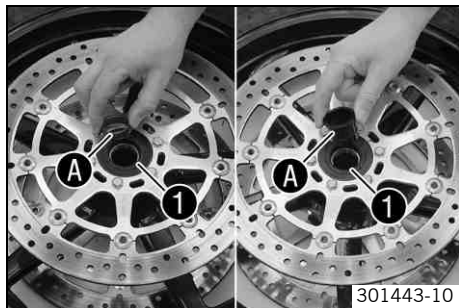

- Check the wheel bearing for damage and wear.
 - » If the wheel bearing is damaged or worn:
 - Replace the wheel bearing. 
- Clean and grease the shaft seal rings **1** and mating surfaces **A** of the spacers.

Long-life grease ( p. 237)

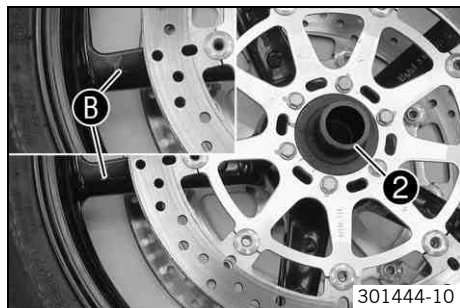

- Insert the wide spacer on the left-hand side **2** (when looking in the direction of travel).



Info

The arrow **B** indicates the direction of rotation of the front wheel.

- Insert the narrow spacer on the right-hand side (when viewed in the direction of travel).

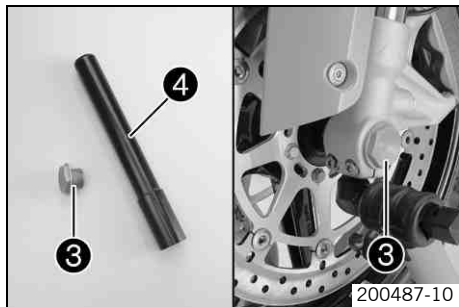

Warning

Danger of accidents Reduced braking efficiency due to oil or grease on the brake discs.

- Always keep the brake discs free of oil and grease, and clean them with brake cleaner when necessary.

- Clean screw ③ and axle ④.
- Lift the front wheel into the fork, position it, and insert the wheel spindle.
- Mount and tighten screw ③.

Guideline

Bolt, front axle	M25x1.5	45 Nm (33.2 lbf ft)
------------------	---------	------------------------

- Position the brake calipers and check that the brake linings are seated correctly.
- Mount screws ⑤ on both brake calipers but do not tighten yet.
- Operate the hand brake lever repeatedly until the brake lining presses up against the brake disc and there is a pressure point. Fix the hand brake lever in the activated position.

✓ The brake calipers align themselves.

- Tighten screws ⑤ on both brake calipers.

Guideline

Screw, front brake caliper	M10x1.25	45 Nm (33.2 lbf ft)	Loctite® 243™
----------------------------	----------	------------------------	----------------------

- Release the fixation of the hand brake lever.
- Take the front of the motorcycle off the work stand. (🔧 p. 100)
- Take the rear from the work stand. (🔧 p. 101)

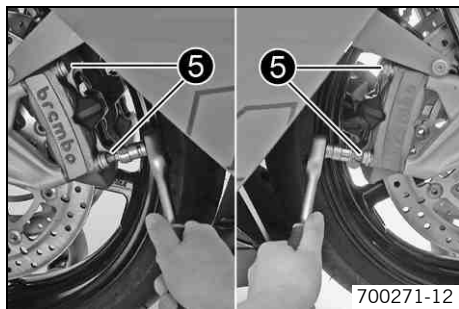

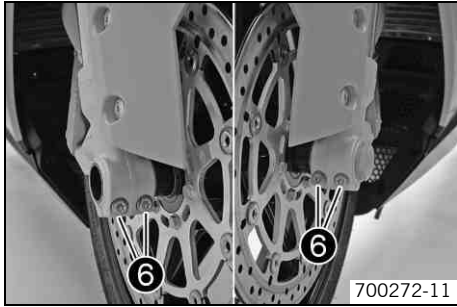

- Pull the front brake and compress the fork powerfully a few times.
- ✓ The fork legs straighten.
- Fully tighten screws ⑥.

Guideline

Fork end pinch bolts	M8	15 Nm (11.1 lbf ft)
----------------------	----	------------------------

Removing the rear wheel 🛠️

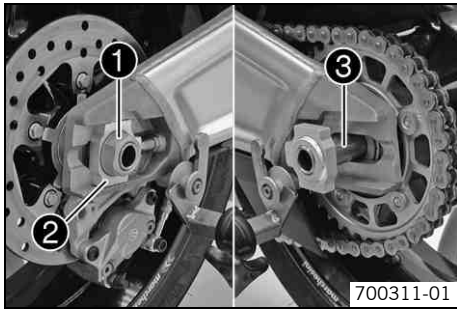

- Jack up the motorcycle at the rear. (🛠️ p. 101)
- Remove nut ①.
- Remove chain adjuster ②.
- Remove the axle ③.

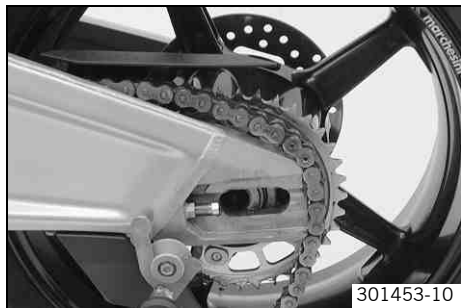

- Push the rear wheel as far forward as possible and then remove the chain from the rear sprocket.



Warning

Danger of accidents Reduced braking efficiency caused by damaged brake discs.

- Always lay the wheel down in such a way that the brake discs are not damaged.
-
- Take the rear wheel out of the swingarm carefully without damaging the rim or brake disc.



Info

Do not operate the foot brake when the rear wheel is removed.

Installing the rear wheel



Warning

Danger of accidents Reduced braking efficiency due to oil or grease on the brake discs.



- Always keep the brake discs free of oil and grease, and clean them with brake cleaner when necessary.



Warning

Danger of accidents No braking effect when operating the rear brake.

- After installing the rear wheel, always operate the foot brake until the pressure point is reached.

-
- Check the rear hub cush drive.  ( p. 150)

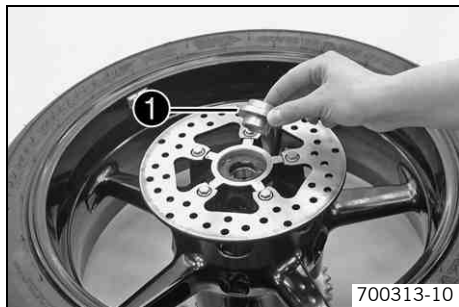

- Remove spacer ❶. Clean and grease the mating surfaces of the spacers and the shaft seal rings.

Long-life grease (☛ p. 237)

- Check the wheel bearing for damage and wear.
 - » If the wheel bearing is damaged or worn:
 - Replace the wheel bearing. ☛
- Install the spacer.
- Clean the thread of the axle and nut.
- Clean the mating surfaces of the brake caliper frame and swingarm.
- Push the brake caliper frame ❷ completely to the rear.
- Position the rear wheel, and place the brake caliper frame between the rim and the brake disc.
- Slide the brake caliper onto the brake disc.
- Position the rear wheel on the mating surfaces in the swingarm.

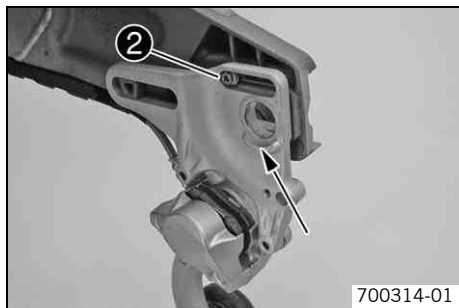

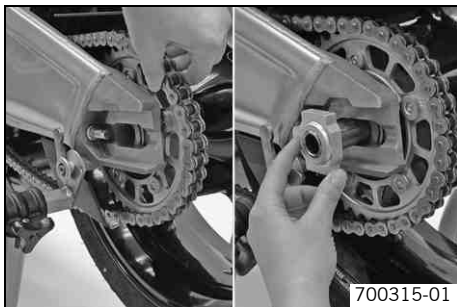

700315-01

- Push the rear wheel as far forward as possible and place the chain on the rear sprocket.
- Pull the rear wheel back and insert the axle.

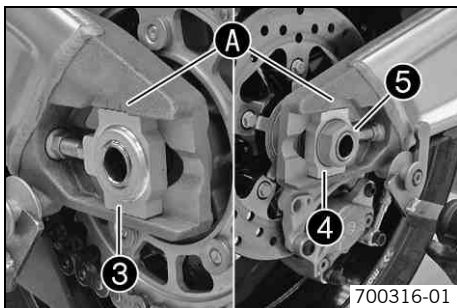

700316-01

- Place the chain adjuster ③ on the tensioning screw.
- Position the chain adjuster ④ and place it on the tensioning screw.
- Tighten nut ⑤.

Guideline

In order for the rear wheel to be correctly aligned, the markings on the left and right chain adjusters must be in the same position relative to the reference marks **A**.

Nut, rear wheel spindle	M25x1.5	90 Nm (66.4 lbf ft)	Thread greased
-------------------------	---------	------------------------	----------------

- Operate the foot brake lever repeatedly until the brake linings press up against the brake disc and there is a pressure point.
- Take the rear from the work stand. (☛ p. 101)
- Check the chain tension. (☛ p. 128)

Checking rear hub cush drive ↩

i Info

The engine power is transmitted by the rear sprocket to the rear wheel through five shock absorbers. They eventually wear out during operation. If the shock absorbers are not changed in time, the rear sprocket carrier and the rear hub are damaged.



- Remove the rear wheel. ↩ (☞ p. 146)
- Remove the rear sprocket carrier.
- Check the rear hub for damage and wear.
 - » If the rear hub cush drive is damaged or worn:
 - Change the shock absorber. ↩
- Position the rear sprocket carrier.

i Info

A set of bolts and shock absorbers should have as little free play as possible to increase the service life of the shock absorbers.

- Install the rear wheel. ↩ (☞ p. 147)

Checking the tire condition



Warning

Danger of accidents Uncontrollable handling characteristic caused by a flat tire.

- For your own safety, have damaged tires changed immediately.



Warning

Danger of crashing Poor vehicle handling due to different tire tread patterns on front and rear wheels.

- The front and rear wheels must be fitted with tires with similar tread patterns to prevent loss of control over the vehicle.



Warning

Danger of accidents Uncontrollable handling characteristic due to non-approved and/or non-recommended tires/wheels.

- Only tires/wheels approved by KTM and with the corresponding speed index should be used.



Warning

Danger of accidents Reduced road grip with new tires.

- New tires have a smooth rolling surface and therefore cannot provide full road grip. The entire rolling surface must be roughened in the first 200 kilometers (124.3 miles) by moderate riding at alternating angles. The full grip levels are not achieved until the tires have been run in.



Info

The type, condition and air pressure of the tires all have a major impact on the handling of the motorcycle. Worn tires have a negative effect on handling characteristics, especially on wet surfaces.

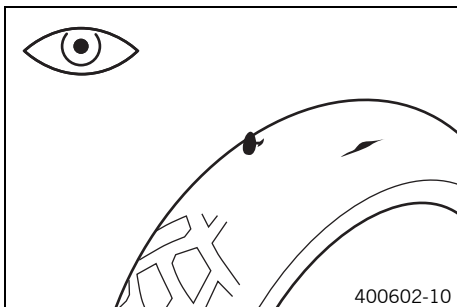

- Check the front and rear tires for cuts, run-in objects and other damage.
 - » If the tires exhibit cuts, run-in objects or other damage:
 - Change the tires.
- Check the depth of the tread.



Info

Note local national regulations concerning the minimum tread depth.

Minimum tread depth	≥ 2 mm (≥ 0.08 in)
---------------------	--------------------

- » If the tread depth is less than the minimum permissible depth:
 - Change the tires.
- Check the age of the tires.

i **Info**

The tire's date of manufacture is usually part of the tire markings and is indicated by the last four digits of the **DOT** marking. The first two digits refer to the week of manufacture and last two digits refer to the year of manufacture. KTM recommends that the tires are changed regardless of the actual wear, at the latest after five years.

- » If a tire is more than five years old:
 - Change the tires.

Checking the tire pressure

i **Info**

Low tire pressure leads to abnormal wear and overheating of the tire. Correct tire pressure tool kit comfort and maximum tire service life.

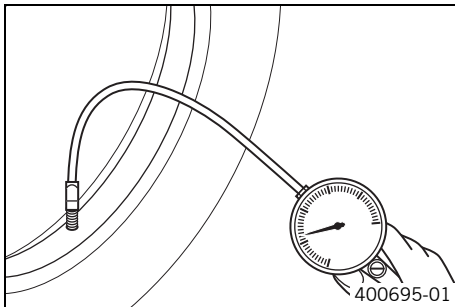

- Remove the dust cap.
- Check the tire pressure when the tires are cold.

Tire air pressure, solo	
Front	2.5 bar (36 psi)
Rear	2.5 bar (36 psi)

Tire air pressure with passenger / full payload	
Front	2.5 bar (36 psi)
Rear	2.9 bar (42 psi)

- » If the tire pressure does not meet specifications:
 - Correct the tire pressure.

- Mount the dust cap.



Info

The rubber seal in the dust cap prevents air leaking out of the tire if the valve is defective.

Removing the seat



- Insert the ignition key in the seat lock ❶ and turn it clockwise.
- Raise the rear of the seat, push it towards the rear, and remove it upwards.

Fitting the seat

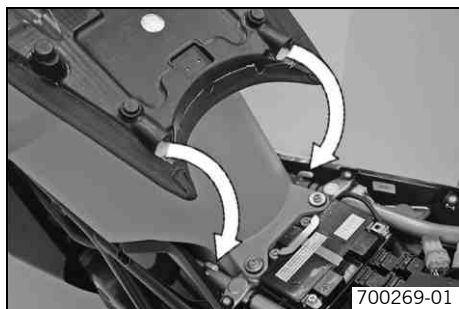

- Position the recesses of the seat to the lugs on the frame, lower the rear end and simultaneously push it forward.
- Lock the seat by turning the ignition key in the seat lock.
- Remove the ignition key from the seat lock.
- Finally, check that the seat is correctly mounted.

Removing the passenger seat

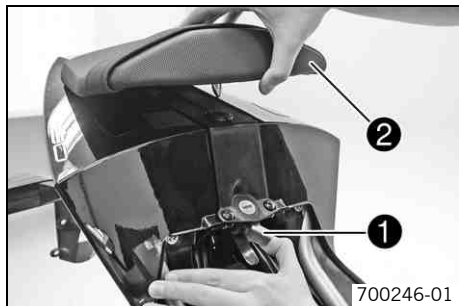

- Remove the seat. (☛ p. 153)
- Activate the release lever ❶.
- Take off the passenger seat ❷ toward the top.

Mounting the passenger seat



Warning

Danger of accidents The passenger seat can come loose from the anchoring if it is not mounted correctly.

- After mounting the passenger seat, check that it is locked correctly by pulling up on the supporting strap. There should be no play in the unlocking lever.
-
- Position the passenger seat in the space provided.
 - Press down the passenger seat until it clicks into place.
 - Finally, check that the passenger seat is correctly mounted.

Mounting the helmet lock on the vehicle



Warning

Danger of accidents Impairment of ride behavior and vehicle operation if a helmet or helmet lock is attached to the vehicle.

- Do not use the helmet lock for holding a helmet or other objects during the journey. Always remove the helmet lock before starting out.

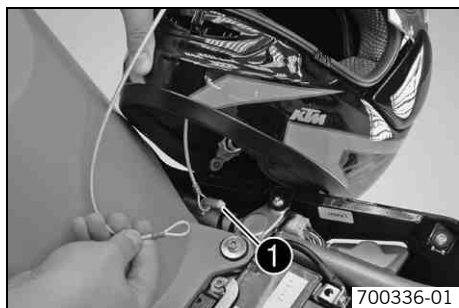

- Remove the seat. (☛ p. 153)
- Position the steel cable from the tool kit with one loop on the lug ❶.

Steel cable (60012015000)

- Guide the steel cable through the helmet opening.
- Then position the free loop of the steel cable on the lug.
- Position the helmet carefully on the side of the vehicle.
- Fit the seat. (☛ p. 153)

Removing the battery 🛠



Warning

Risk of injury Battery acid and battery gases cause serious cauterization.

- Keep batteries out of the reach of children.
- Wear suitable protective clothing and goggles.
- Avoid contact with battery acid and battery gases.
- Keep the battery away from sparks or open fire. Charge only in well ventilated rooms.
- In the event of skin contact, rinse with large amounts of water. If battery acid gets in the eyes, rinse with water for at least 15 minutes and contact a doctor.



Caution

Danger of accidents If the vehicle is operated with a discharged battery or without a battery, electronic components and safety equipment may be damaged.

- Never operate the vehicle with a discharged battery or without a battery.

- Switch off all power consumers and the engine.
- Remove the seat. (🔗 p. 153)
- Disconnect negative (minus) cable **1** of the battery.

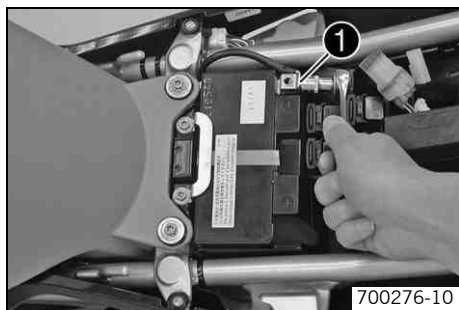

- Remove the cover of the positive terminal.
- Disconnect the positive (plus) cable **2** of the battery.

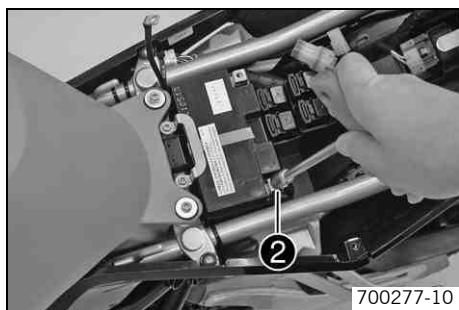

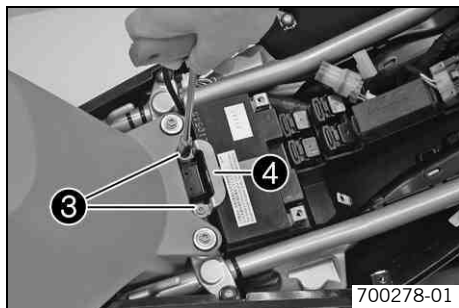

- Remove screws ③.
- Removing the securing bracket ④.
- Pull the battery up and out of the battery rack.

Installing the battery 🛠️

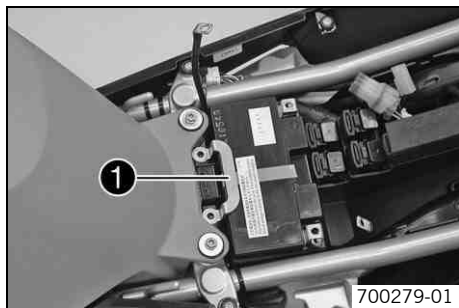

- Position the battery in the battery rack.



Info

The terminals of the battery must face the rear of the vehicle.

- Position the bracket ①.

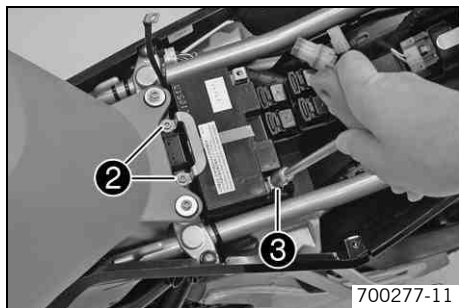

- Mount and tighten screws ②.

Guideline

Remaining chassis screws	M6	10 Nm (7.4 lbf ft)
--------------------------	----	--------------------

- Reconnect the positive (plus) ③ cable of the battery.
- Position cover of the positive terminal.

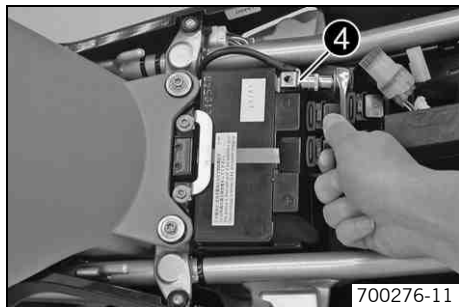

- Reconnect the negative (minus) cable ④ of the battery.
- Fit the seat. (☛ p. 153)
- Set the clock with **SET CLOCK**. (☛ p. 68)

Recharging the battery



Warning

Risk of injury Battery acid and battery gases cause serious cauterization.

- Keep batteries out of the reach of children.
- Wear suitable protective clothing and goggles.
- Avoid contact with battery acid and battery gases.
- Keep the battery away from sparks or open fire. Charge only in well ventilated rooms.
- In the event of skin contact, rinse with large amounts of water. If battery acid gets in the eyes, rinse with water for at least 15 minutes and contact a doctor.



Warning

Environmental hazard Battery parts and acid are harmful to the environment.

- Do not discard batteries with the household trash. Dispose of a defective battery in an environmentally compatible manner. Give the battery to your KTM dealer or to a recycling center that accepts used batteries.



Warning

Environmental hazard Hazardous substances cause environmental damage.

- Oil, grease, filters, fuel, cleaners, brake fluid, etc., should be disposed of as stipulated in applicable regulations.



Info

Even when there is no load on the battery, it discharges steadily.

The charge state and the type of charge are very important for the service life of the battery.

Rapid recharging with a high charging current shortens the battery's service life.

If the charging current, charging voltage and charging time are exceeded, electrolyte escapes through the safety valves. This reduces the battery capacity.

If the battery is depleted from starting the vehicle repeatedly, the battery must be charged immediately.

If the battery is left in a discharged state for an extended period, it will become over-discharged and sulfate, destroying the battery.

The battery is maintenance-free, i.e., the acid level does not have to be checked.

-
- Switch off all power-consuming components and switch off the engine.
 - Remove the seat. (👉 p. 153)
 - Disconnect the negative (minus) cable of the battery to avoid damage to the motorcycle's electronics.

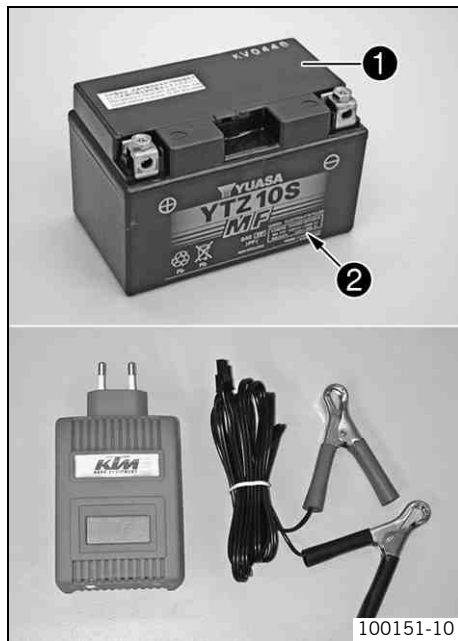

- Connect the battery charger to the battery. Switch on the battery charger.

Battery charger (58429074000)

You can also use the battery charger to test the rest potential and start potential of the battery, and to test the alternator. With this device, you cannot overcharge the battery.



Info

Never remove lid ①.

Charge the battery at no more than 10% of the capacity specified on the battery housing ②.

- Switch off the charger after charging. Disconnect the battery.

Guideline

The charge current, charge voltage and charge time must not be exceeded.	
--	--

Charge the battery regularly when the motorcycle is not in use	3 months
--	----------

- Fit the seat. (☛ p. 153)
- Set the clock with **SET CLOCK**. (☛ p. 68)

Changing the main fuse



Warning

Fire hazard The electrical system can be overloaded by the use of incorrect fuses.

- Use only fuses with the prescribed amperage. Never by-pass or repair fuses.



Info

The main fuse protects all power consumers of the vehicle. The main fuse is under the seat.

- Switch off all power consumers and the engine.
- Remove the seat. (☞ p. 153)
- Remove protection covers ❶.
- Remove the faulty main fuse ❷.



Info

A reserve fuse ❸ is located in the starter relay.

- Install a new main fuse.

Fuse (58011109130) (☞ p. 225)



Tip

Place the spare fuse in the starter relay so that it is available if needed.

- Attach the protection covers ❶.
- Fit the seat. (☞ p. 153)
- Set the clock with **SET CLOCK**. (☞ p. 68)

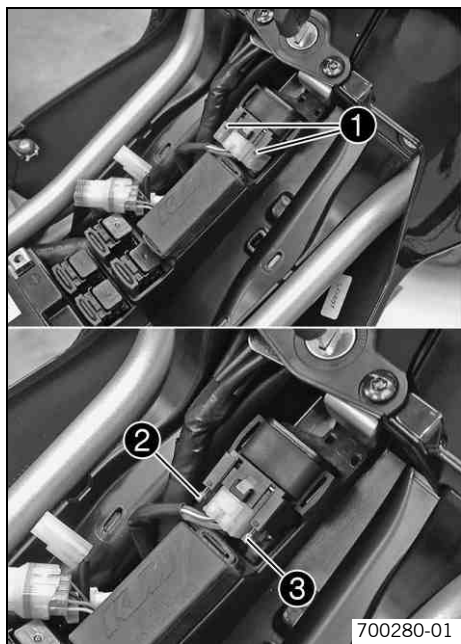

Changing the fuses of individual power consumers



Warning

Fire hazard The electrical system can be overloaded by the use of incorrect fuses.

- Use only fuses with the prescribed amperage. Never by-pass or repair fuses.



Info

The fuse box containing the fuses of individual power consumers is located under the seat.

- Switch off all power consumers and the engine.
- Remove the seat. (🔧 p. 153)
- Open fuse box cover ❶.

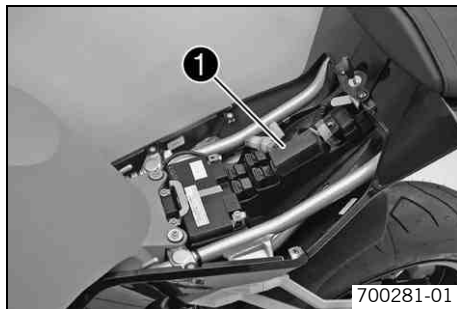

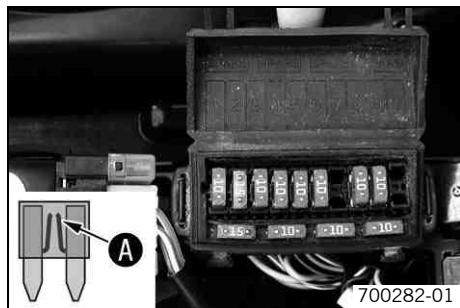

- Check the fuses.

i Info

A defective fuse can be identified by the burned-out fuse wire **A**.

- Remove the faulty fuse.

Guideline

Fuse 1 - 10A - ignition, combination instrument, immobilizer, alarm system (optional)
Fuse 2 - 15A - high beam, low beam, parking light, tail light, license plate lamp
Fuse 3 - 10A - horn, brake light
Fuse 4 - 10A - radiator fan
Fuse 5 - 10A - fuel pump
Fuse 6 - 10A - ignition/fuel injection
Fuse 7 - not used
Fuse 8 - 10A - for supplementary equipment (standard accessories)
Fuse 9 - 10A - for supplementary equipment (accessories connected to the ignition switch)
Fuse 10 - not used
Fuse SPARE - 10A/15A - spare fuses

- Use spare fuses with the correct rating only.

Fuse (75011088010) (☛ p. 225)

Fuse (75011088015) (☛ p. 225)

i Tip

Replace the spare fuse in the fuse box so that it is available if needed.

- Close the fuse box cover.
- Fit the seat. (☛ p. 153)

Changing the low beam bulb

Note

Damage to reflector Reduced luminance.

- Grease on the lamp will evaporate due to the heat and be deposited on the reflector. Clean the lamp and keep it free of grease before mounting.

- Switch off all power consumers and the engine.
- Fold up the combination instrument. Pull the lug ❶ out of the rubber retainer ❷.
- Remove the rubber retainer.

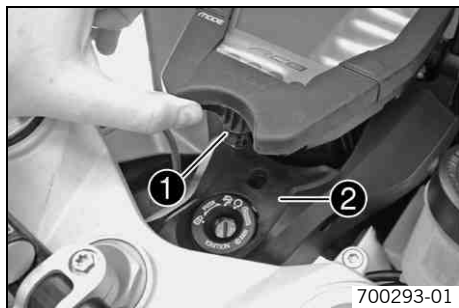

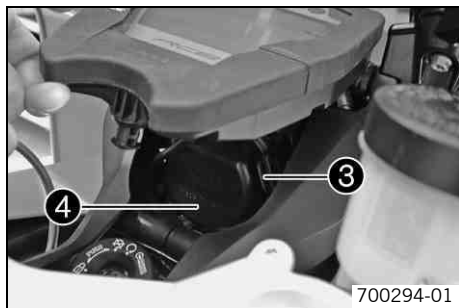

- Release the latch ③.
- Remove the lamp cover ④.

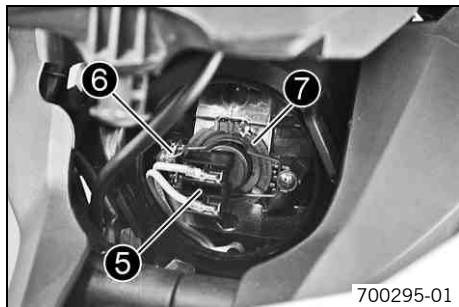

- Disconnect plug-in connector ⑤.
- Push off the retaining clamp ⑥ on both sides, squeeze and fold to the side.
- Remove headlight bulb ⑦.

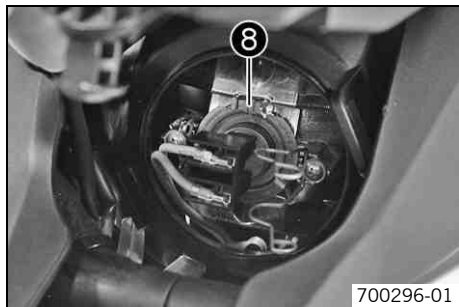

- Position the new headlight bulb in the headlight housing.

Low beam / high beam (H7 / base PX26d) (☛ p. 225)



Info

Insert the headlight bulb so that the lug ⑧ is positioned in the cut-out.

- Position the retaining clamp.
- Position the plug-in connector.

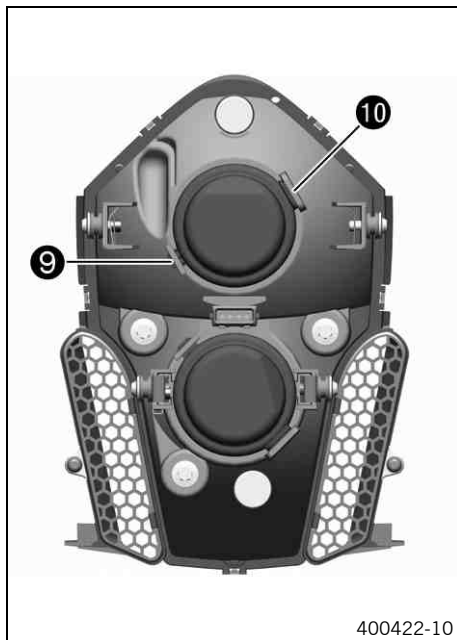

- Position the lug 9 of the lamp cover in the notch. Engage the latch 10.
- Check that the lighting is functioning properly.

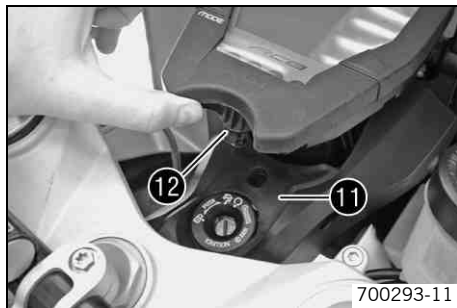

- Position the rubber holder 11.
- Fold down the combination instrument. Position the lug 12 in the rubber retainer.

Changing the high beam bulb

Note

Damage to reflector Reduced luminance.

- Grease on the lamp will evaporate due to the heat and be deposited on the reflector. Clean the lamp and keep it free of grease before mounting.

- Switch off all power consumers and the engine.
- Remove screws ❶. Remove the cover.

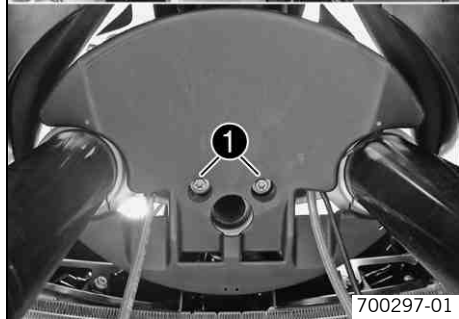

700297-01

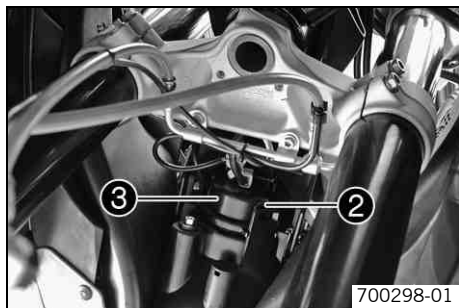

- Release the latch ②.
- Remove the lamp cover ③.

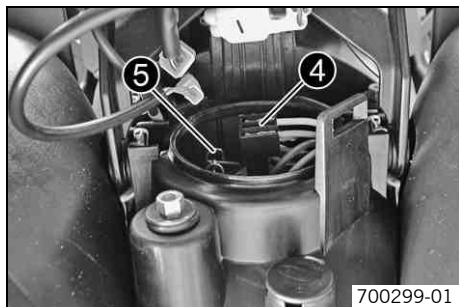

- Disconnect plug-in connector ④.
- Push off the retaining clamp ⑤ on both sides, squeeze and fold to the side.
- Remove headlight bulb.
- Position the new headlight bulb in the headlight housing.

Low beam / high beam (H7 / base PX26d) (☛ p. 225)



Info

Insert the headlight bulb so that the lug is positioned in the cut-out.

- Position the retaining clamp.
- Position the plug-in connector.

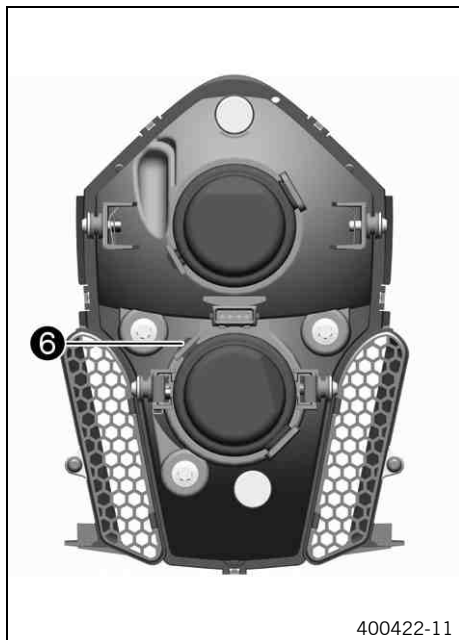

- Position the lug ⑥ of the lamp cover in the notch. Engage the latch.
- Check that the lighting is functioning properly.

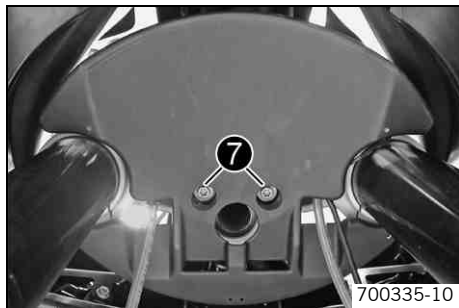

- Position the cover.



Info

Check for correct positioning and freedom of movement of the brake lines.

- Mount and tighten screws ⑦.

Guideline

Remaining chassis screws	M6	10 Nm (7.4 lbf ft)
--------------------------	----	--------------------

Changing the parking light bulb

Note

Damage to reflector Reduced luminance.

- Grease on the lamp will evaporate due to the heat and be deposited on the reflector. Clean the lamp and keep it free of grease before mounting.

- Switch off all power consumers and the engine.
- Remove screws ❶. Remove the cover.



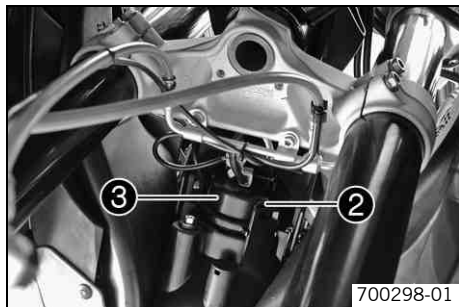

- Release the latch ②.
- Remove the lamp cover ③.

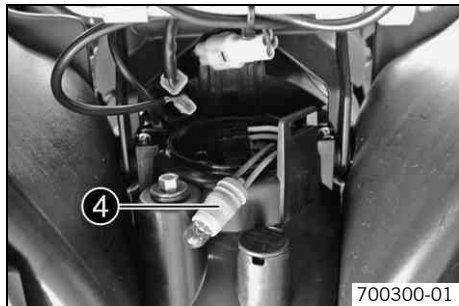

- Pull the parking light ④ carefully out of the holder.
- Remove the light bulb.
- Position a new light bulb in the holder.

Parking light (W5W/ base W2.1x9.5d) (☛ p. 225)

- Carefully position the holder with the bulb in the holder in the headlight.

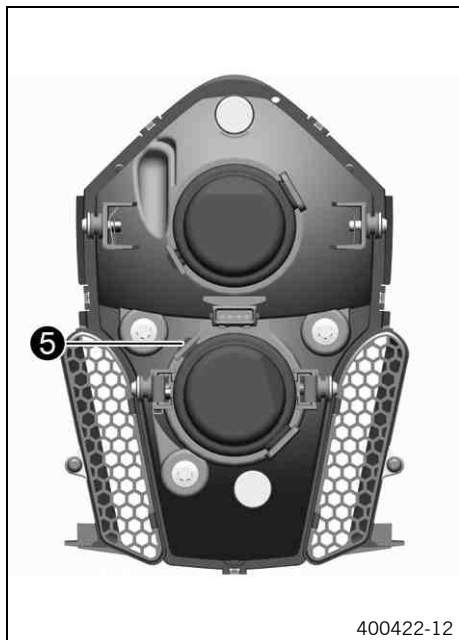

- Position the lug ⑤ of the lamp cover in the notch. Engage the latch.
- Check that the lighting is functioning properly.

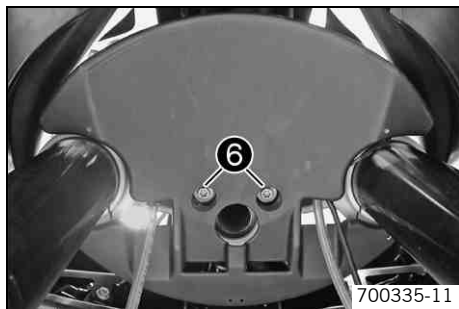

- Position the cover.



Info

Check for correct positioning and freedom of movement of the brake lines.

- Mount and tighten screws ⑥.

Guideline

Remaining chassis screws	M6	10 Nm (7.4 lbf ft)
--------------------------	----	--------------------

Checking the headlight setting

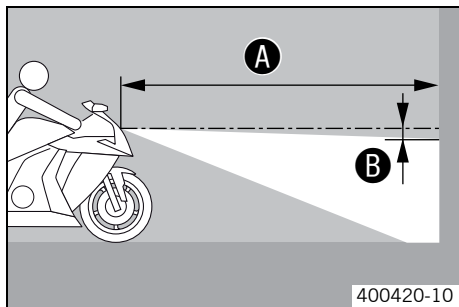

- Stand the vehicle upright on a horizontal surface in front of a light wall and make a mark at the height of the center of the low beam headlight.
- Make another mark at a distance **B** under the first mark.

Guideline

Distance B	5 cm (2 in)
-------------------	-------------

- Position the vehicle vertically at a distance **A** in front of the wall and switch on the low beam.

Guideline

Distance A	5 m (16 ft)
-------------------	-------------

- The rider, with luggage and passenger if applicable, now mounts the motorcycle.
- Check the headlight setting.

The light-dark boundary must lie exactly on the lower mark when the motorcycle is ready to operate with the rider mounted along with any luggage and a passenger if applicable.

- » If the boundary between light and dark does not meet specifications:
 - Adjust the headlamp range. (☛ p. 174)

Adjusting the headlamp range

- Check the headlight setting. (☛ p. 174)



- Turn the screw ❶ to adjust the headlight range.

Guideline

A motorcycle with rider, including the luggage and a passenger (where applicable) the light cut off must be aligned exactly on the lower mark (when checking headlight adjustment).

i Info

Turn clockwise to increase the light range, turn counterclockwise to reduce the light range.

If you have a payload, you may have to correct the headlight range.

Activating/deactivating ignition key

i Info

The orange programming key must only be used for activating and deactivating!

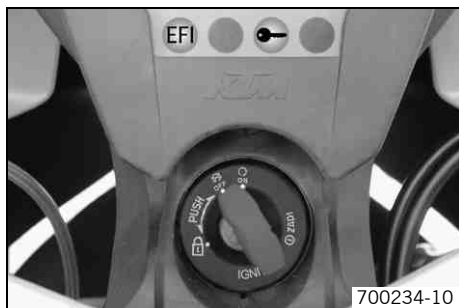





Loss of a black ignition key (second black ignition key available):

If a black ignition key is lost or replaced, the black ignition keys must be individually activated/deactivated using the orange programming key. This will also prevent the vehicle from being operated without authorization with the lost black ignition key.

The following procedure deactivates all activated black ignition keys that are not included in the procedure.







- Press the emergency OFF switch into the position ○.
- Insert the orange programming key in the ignition lock.
- Switch on the ignition by turning the orange programming key to the **ON** position ○.
 - ✓ **EFI** warning lamp (MIL) lights up, switches off, and then starts to flash.
 - ✓ The immobilizer indicator lamp lights up.

- Switch off the ignition by turning the orange programming key to the **OFF** position ☒.
- Pull out the orange programming key.
- Insert the black ignition key in the ignition lock.
- Switch on the ignition by turning the black programming key to the position **ON** ○.
- ✓ **EFI** warning lamp  (**MIL**) lights up, switches off, and then starts to flash.
- ✓ The immobilizer indicator lamp  lights up, switches off briefly, and switches on again.
- Switch off the ignition by turning the black programming key to the position **OFF** ☒.
- Remove the black ignition key.
- Insert the orange programming key in the ignition lock.
- Switch on the ignition by turning the orange programming key to the **ON** position ○.
- ✓ **EFI** warning lamp  (**MIL**) lights up, switches off, and then starts to flash.
- ✓ The immobilizer indicator lamp  lights up, switches off briefly, and flashes according to the number of functioning black ignition keys including the orange programming key. In this case, twice.
- Switch off the ignition by turning the orange programming key to the **OFF** position ☒.
- Pull out the orange programming key.
- ✓ The lost black ignition key is deactivated.
- ✓ The existing black ignition key is reactivated.

Loss of both black ignition keys (no black ignition key available):





This procedure is important to prevent misuse of the lost black ignition key.





- Press the emergency OFF switch into the position ○.
- Insert the orange programming key in the ignition lock.
- Switch on the ignition by turning the orange programming key to the **ON** position ○.
- ✓ **EFI** warning lamp  (**MIL**) lights up, switches off, and then starts to flash.

- ✓ The immobilizer indicator lamp  lights up.
- Switch off the ignition by turning the orange programming key to the **OFF** position .
- Switch on the ignition by turning the orange programming key to the **ON** position .
- ✓ **EFI** warning lamp  (**MIL**) lights up, switches off, and then starts to flash.
- ✓ The immobilizer indicator lamp  lights up, switches off briefly, and flashes according to the number of functioning black ignition keys including the orange programming key. In this case once, since all black ignition keys are deactivated.
- Switch off the ignition by turning the orange programming key to the **OFF** position .
- Pull out the orange programming key.
- ✓ All black ignition keys are deactivated.
- Order a new black ignition key according to the key number on the **KEYCODECARD** and activate it.

Activating ignition key:

You can activate or deactivate up to four black ignition keys. Only the black ignition keys programmed during an activation procedure are valid. All black ignition keys not programmed during the activation procedure are invalid, but can be reprogrammed in a further activation procedure.

- Press the emergency OFF switch into the position .
- Insert the orange programming key in the ignition lock.
- Switch on the ignition by turning the orange programming key to the **ON** position .
- ✓ **EFI** warning lamp  (**MIL**) lights up, switches off, and then starts to flash.
- ✓ The immobilizer indicator lamp  lights up.
- Switch off the ignition by turning the orange programming key to the **OFF** position .
- Pull out the orange programming key.
- Insert the black ignition key in the ignition lock.

- Switch on the ignition by turning the black programming key to the position **ON** ○.
- ✓ **EFI** warning lamp  (**MIL**) lights up, switches off, and then starts to flash.
- ✓ The immobilizer indicator lamp  lights up, switches off briefly, and switches on again.
- Switch off the ignition by turning the black programming key to the position **OFF** ☒.
- Remove the black ignition key.
- To activate further ignition keys, repeat the last 4 steps with the respective ignition key.
- Insert the orange programming key in the ignition lock.
- Switch on the ignition by turning the orange programming key to the **ON** position ○.
- ✓ **EFI** warning lamp  (**MIL**) lights up, switches off, and then starts to flash.
- ✓ The immobilizer indicator lamp  lights up, switches off briefly, and flashes according to the number of functioning black ignition keys including the orange programming key.
- Switch off the ignition by turning the orange programming key to the **OFF** position ☒.
- Pull out the orange programming key.
- ✓ All black ignition keys are activated included in this job sequence are activated.

Cooling system

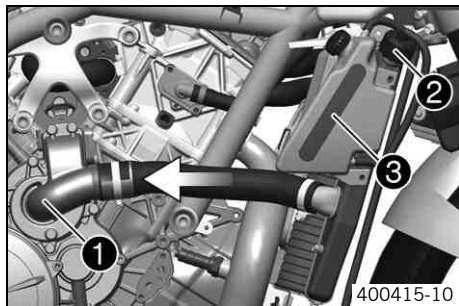

The water pump with a 3D water pump wheel ❶ in the engine ensures forced circulation of the coolant. The heat exchanger enables faster warming of the engine oil at the start of a journey and better heat dissipation for the engine oil during the journey.

The pressure in the cooling system resulting from heat is regulated by a valve in the radiator cap ❷. The heat expansion causes the surplus coolant to flow into the compensating tank ❸. When the temperature falls, this surplus coolant is sucked back into the cooling system.

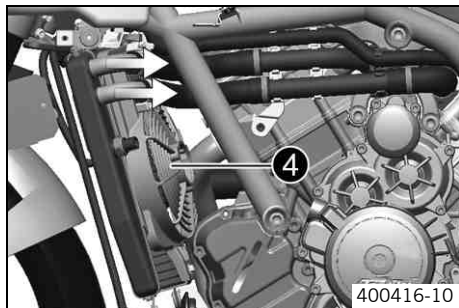

Cooling takes place by means of the air stream and a radiator fan ❹, which is controlled by a thermoswitch.

The lower the speed, the less the cooling effect. Dirty cooling fins also reduce the cooling effect.

Checking the coolant level



Warning

Danger of scalding During motorcycle operation, the coolant gets very hot and is under pressure.

- Do not remove the radiator cap, radiator hoses or other cooling system components when the engine is hot. Allow the engine and cooling system to cool down. In case of scalding, rinse immediately with lukewarm water.

Condition

The engine is cold.

The radiator is completely full.

- Rest the motorcycle on its side stand on a horizontal surface.
- Check the coolant level in the compensating tank.

The coolant level must be between **MIN** and **MAX**.

- » If there is no coolant in the compensating tank:
 - Check the cooling system for leaks. 🛠️



Info

Do not operate the motorcycle!

- Add coolant/bleed the cooling system. 🛠️
- » If the coolant level in the compensating tank does not meet specifications, but the tank is not empty:
 - Check the cooling system for leaks. 🛠️
 - Fill the cooling system compensating tank. (🔧 p. 180)



Filling the cooling system compensating tank



Warning

Danger of scalding During motorcycle operation, the coolant gets very hot and is under pressure.

- Do not remove the radiator cap, radiator hoses or other cooling system components when the engine is hot. Allow the engine and cooling system to cool down. In case of scalding, rinse immediately with lukewarm water.



Warning

Danger of poisoning Coolant is poisonous and a health hazard.

- Avoid contact between coolant and skin, eyes and clothing. If it gets into your eyes, rinse immediately with water and contact a doctor. Wash affected skin areas immediately with soap and water. If coolant is swallowed, contact a doctor immediately. Change clothes that have come into contact with coolants. Keep coolant out of the reach of children.

Note

Engine damage Impaired cooling efficiency due to air trapped in the cooling system.

- After draining coolant and refilling the cooling system, the motorcycle must be raised at the front according to the model type. This is the only way of ensuring that the cooling system is filled without air bubbles. (Your authorized KTM RC8 workshop will be pleased to help.)

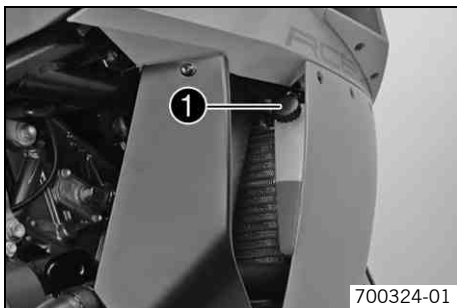

- Check the coolant level. (☞ p. 179)
- Remove the cap ❶ of the compensating tank.
- Top up with coolant until the specified coolant level is reached.

Guideline

The coolant level must be between **MIN** and **MAX**.

Alternative 1

Coolant (☞ p. 233)

Alternative 2

Coolant (mixed ready to use) (☞ p. 233)

- Mount the cap of the compensating tank.

Adjusting basic position of clutch lever

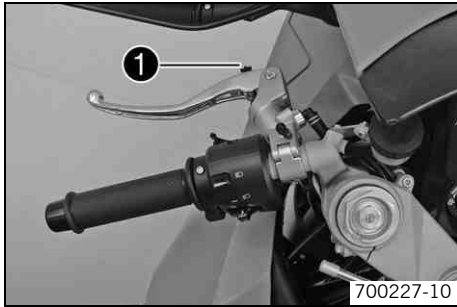

- Adjust the basic setting of the clutch lever to your hand size by turning adjusting screw ❶.

i Info

Turn the adjusting screw clockwise to increase the distance between the clutch lever and the handlebar.

Turn the adjusting screw counterclockwise to decrease the distance between the clutch lever and the handlebar.

The range of adjustment is limited.

Turn the adjusting screw by hand only, and do not apply any force.

Do not make any adjustments while riding!

Checking fluid level of hydraulic clutch

i Info

The fluid level rises with increasing wear of the clutch lining disc.

Do not use brake fluid.

- Move the clutch fluid reservoir mounted on the handlebar to a horizontal position.



- Check the fluid level.

The fluid level must be between the **MIN** and **MAX** markings.

- » If the coolant level does not meet specifications:
 - Correct the fluid level of the hydraulic clutch. (☛ p. 183)

Correcting fluid level of hydraulic clutch



Info

The fluid level rises with increasing wear of the clutch lining disc.
Do not use brake fluid.



- Move the clutch fluid reservoir mounted on the handlebar to a horizontal position.
- Remove screw cap with membrane.
- Correct the fuel level.

Guideline

The fluid level must be between the **MIN** and **MAX** markings.

Hydraulic fluid (15) (☛ p. 235)

- Refit the screw cap with the membrane.

Checking the play in the throttle cable

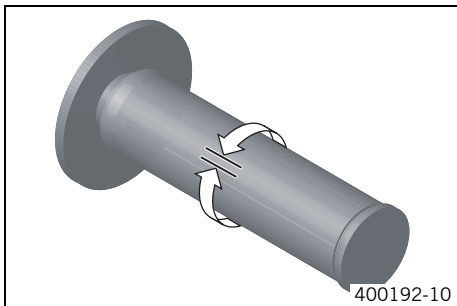

- Move the handlebar to the straight-ahead position. Move the throttle grip backwards and forwards to ascertain the play in the throttle cable.

Throttle cable play	3... 5 mm (0.12... 0.2 in)
---------------------	----------------------------

- » If the throttle cable play does not meet specifications:
 - Adjust the play in the throttle cable. 🛠️ (📖 p. 185)



Danger

Danger of poisoning Exhaust gases are poisonous and inhaling them may result in unconsciousness and/or death.

- When running the engine, always make sure there is sufficient ventilation, and do not start or run the engine in an enclosed space without an effective exhaust extraction system.
-
- Start the engine and let it run idle. Move the handlebar to and fro over the entire steering range.

The idle speed must not change.

- » If the idle speed changes:
 - Adjust the play in the throttle cable. 🛠️ (📖 p. 185)

Adjusting the play in the throttle cable

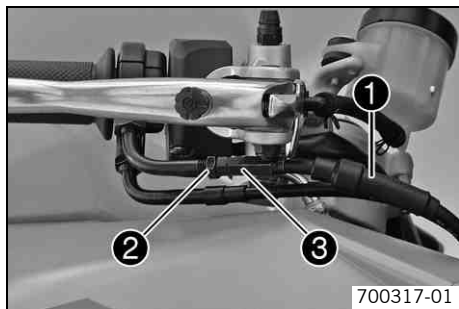

- Move the handlebar to the straight-ahead position.
- Throttle position sensor circuit A - check in zero position. 



Info

It is imperative to use the KTM diagnostics tool for this.

- Push back protective cover ❶.
- Loosen counter nut ❷.
- Set the play in the throttle cable by turning adjusting screw ❸.

Guideline

Throttle cable play	3... 5 mm (0.12... 0.2 in)
---------------------	----------------------------

- Tighten counter nut ❷.
- Mount the protective cover.

Handlebar height

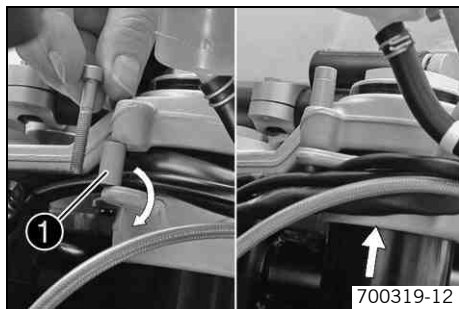

By removing or inserting spacing sleeves ❶, you can set the handlebar height at two different positions.

Length of distance sleeve ❶	15 mm (0.59 in)
-----------------------------	-----------------

With distance sleeves, the handlebar stub is positioned low for sports use. Removing the distance sleeves gives a more upright sitting position.

Standard	Low position with distance sleeve
----------	-----------------------------------

Adjusting the handlebar height

i Info

The handlebar stub position must be identical on the left and right of the vehicle.

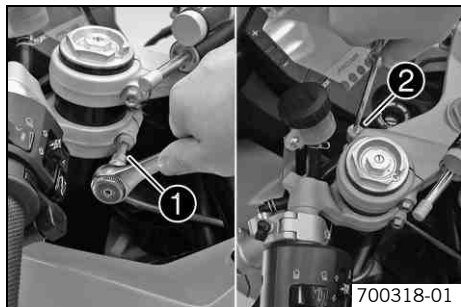

Adjusting the high position of the handlebar stubs:

- Loosen screw ❶.

i Info

Loosen the screw several turns to prevent damage to the fork lacquer when moving the handlebar stub.

- Remove screw ❷.

- Remove distance sleeve ❸.
- All cables routed under the upper triple clamp must now be routed under the handlebar stub.
- Push the handlebar stub carefully up to the upper triple clamp.
- Position the distance sleeve above the triple clamp.
- Mount and tighten screw.

Guideline

Remaining frame bolts	M5	5 Nm (3.7 lbf ft)
-----------------------	----	-------------------

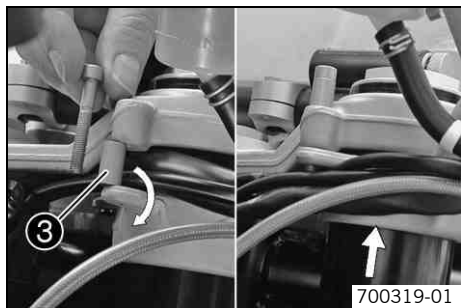



- Tighten the screw.

Guideline

Screw, handlebar stub	M8	20 Nm (14.8 lbf ft)
-----------------------	----	------------------------

- Repeat the adjustments on the other handlebar stub.
- Move the handlebar to and fro over the entire steering range.
 - » If the cables restrict the freedom of movement of the steering:
 - Correct the cable routing.

Adjusting the low position of the handlebar stubs:

- Loosen screw ❶.



i Info

Loosen the screw several turns to prevent damage to the fork lacquer when moving the handlebar stub.

- Remove screw ❷ with distance sleeve ❸.
- Carefully shift the handlebar stub by the length of the distance sleeve.

Guideline

Long distance sleeve	15 mm (0.59 in)
----------------------	-----------------

- Lay all cables between the upper triple clamp and the handlebar stub.
- Position the distance sleeve.
- Mount and tighten screw.

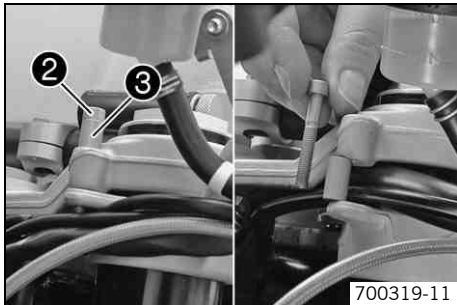



Guideline

Remaining frame bolts	M5	5 Nm (3.7 lbf ft)
-----------------------	----	-------------------

- Tighten the screw.

Guideline

Screw, handlebar stub	M8	20 Nm (14.8 lbf ft)
-----------------------	----	------------------------

- Repeat the adjustments on the other handlebar stub.
- Move the handlebar to and fro over the entire steering range.
 - » If the cables restrict the freedom of movement of the steering:
 - Correct the cable routing.

Rear frame position

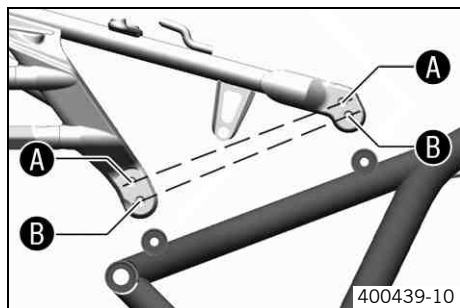

The frame rear height can be set to two different positions, enabling ergonomic adjustment of the seat height.

Seat height A (standard)	805 mm (31.69 in)
Seat height B	825 mm (32.48 in)

Adjusting the rear frame position

-  **Warning**
Danger of accidents Modifications to the suspension settings can seriously alter the vehicle's ride behavior.
- Following modifications, ride slowly at first to get the feel of the new ride behavior.

- Remove the seat. (🔧 p. 153)
- Remove screws ❶ with the bushings.

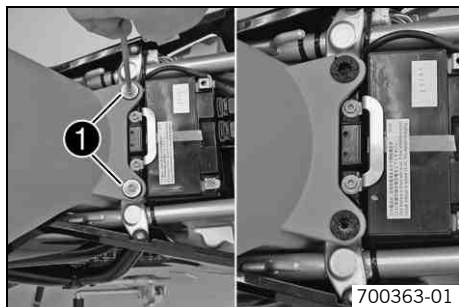

Setting a higher seat position:

- Remove screw ❷ with washer on the left and right sides of the vehicle.
- Push the rear end down until the drill holes of the frame are level with the lower front drill holes of the rear.

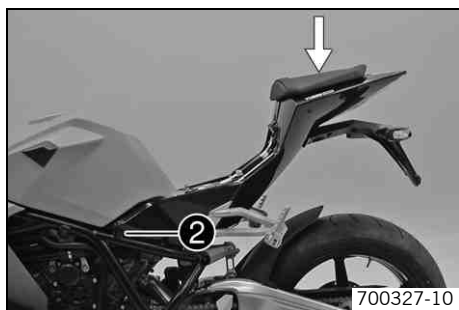



- Mount the screw and washer on the left and right sides of the vehicle, but do not tighten.

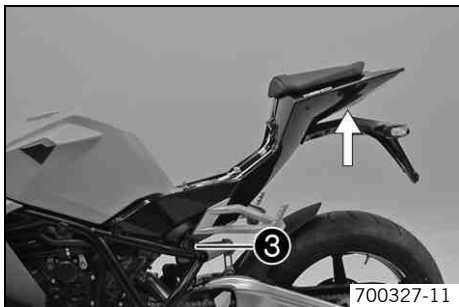

- Remove screw ❸ with washer on the left and right sides of the vehicle.
- Push the rear end up until the drill holes of the frame are level with the lower rear drill holes of the rear.
- Mount the screw and washer on the left and right sides of the vehicle, and tighten.

Guideline

Screw, subframe	M8	20 Nm (14.8 lbf ft)	Loctite® 243™
-----------------	----	------------------------	----------------------

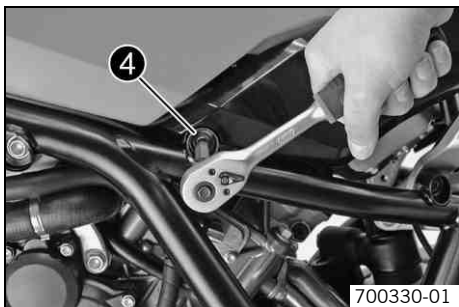

- Tighten screw ❹ on the left and right sides of the vehicle.

Guideline

Screw, subframe	M8	20 Nm (14.8 lbf ft)	Loctite® 243™
-----------------	----	------------------------	----------------------

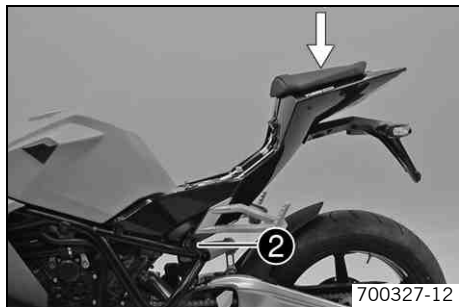

Setting a lower seat position:

- Remove screw ② with washer on the left and right sides of the vehicle.
- Push the rear end down until the drill holes of the frame are level with the upper rear drill holes of the rear.
- Mount the screw and washer on the left and right sides of the vehicle, but do not tighten.

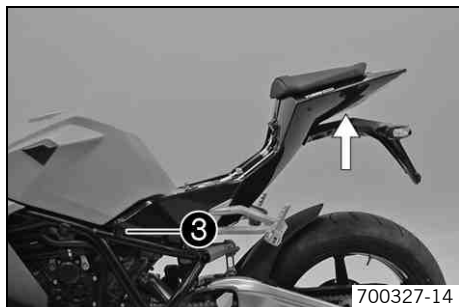

- Remove screw ③ with washer on the left and right sides of the vehicle.
- Push the rear end up until the drill holes of the frame are level with the upper front drill holes of the rear.



- Mount the screw and washer on the left and right sides of the vehicle, and tighten.

Guideline

Screw, subframe	M8	20 Nm (14.8 lbf ft)	Loctite® 243™
-----------------	----	------------------------	----------------------

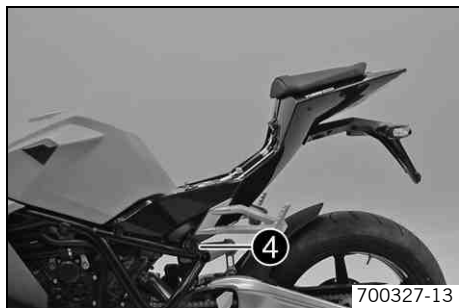

- Tighten screw ④ on the left and right sides of the vehicle.

Guideline

Screw, subframe	M8	20 Nm (14.8 lbf ft)	Loctite® 243™
-----------------	----	------------------------	----------------------

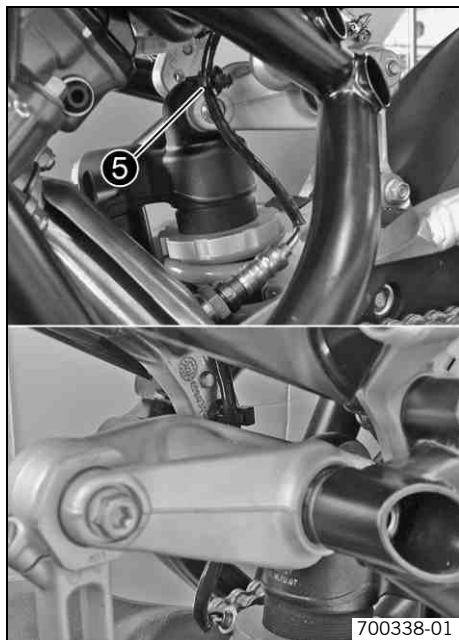

- When you screw in the rear left fixing screw, the plug-in cable binder ⑤ is pushed out of the thread. To reposition the cable of the lambda sensor, fix the plug-in cable binder in the remaining free drill hole.



Info

Check the cable routing. The cable of the lambda sensor should not be taut.

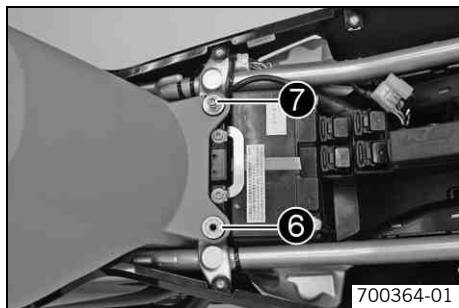

- Position bushings ⑥.
- Mount and tighten screws ⑦.

Guideline

Remaining chassis screws	M6	10 Nm (7.4 lbf ft)
--------------------------	----	--------------------

- Fit the seat. (☛ p. 153)

Checking the engine oil level

i Info

The engine oil level must be checked at normal engine operating temperature.

- Stand the motorcycle upright on a horizontal surface.
- Remove oil dipstick ①. Check the engine oil level in the measurement range.

i Info

After switching off the engine, wait one minute before checking the level.



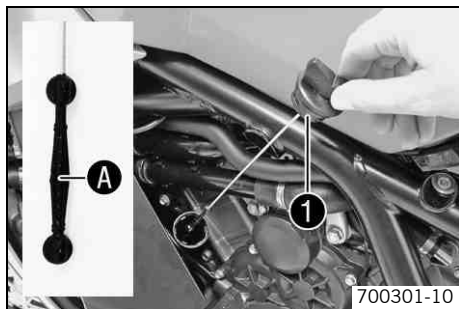

The engine oil level must be in the middle **A** of the measurement range of the oil dipstick.

- » If the engine oil level is not at the specified level:
 - Add engine oil. (☛ p. 201)
- Replace the oil dipstick.



Changing engine oil and filter, cleaning oil screen



- Drain the engine oil and clean the oil screens.  ( p. 194)
- Fill up with engine oil.  ( p. 199)

Draining engine oil, cleaning oil screens



Warning

Danger of scalding Engine oil and gear oil get very hot when the motorcycle is ridden.

- Wear appropriate protective clothing and safety gloves. In case of burns, rinse immediately with lukewarm water.



Warning

Environmental hazard Hazardous substances cause environmental damage.

- Oil, grease, filters, fuel, cleaners, brake fluid, etc., should be disposed of as stipulated in applicable regulations.



Info

Drain the engine oil only when the engine is warm.

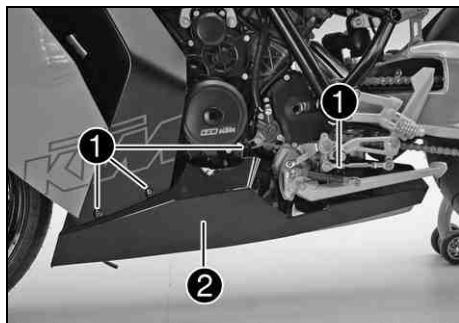

- Remove screws ❶.
- Take off the left exhaust cover ❷.

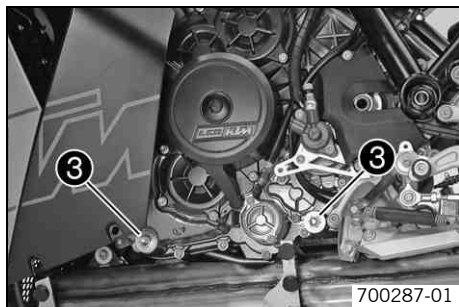
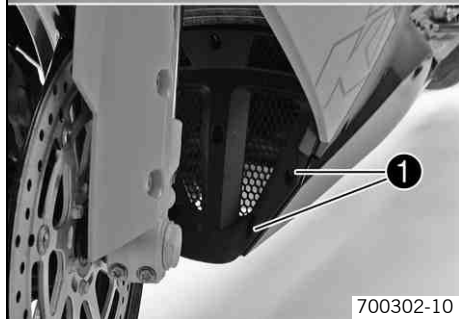

- Stand the motorcycle on its side stand on a horizontal surface.
- Place a suitable container under the engine.
- Remove oil drain plug ❸ with the magnet, O-rings and oil screen.
- Remove the oil filter. 🛠️ (📖 p. 197)
- Completely drain the engine oil.

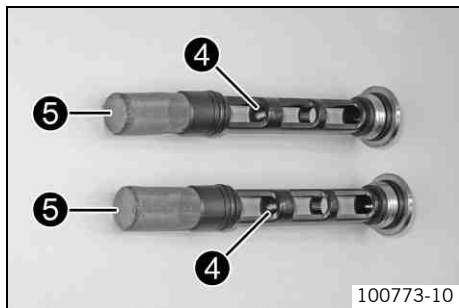

- Thoroughly clean the magnet ④ and oil screen ⑤ of the oil drain plug.

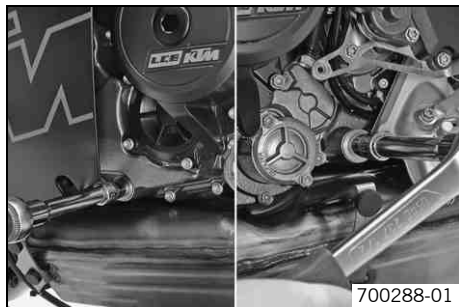

- Mount and tighten the oil drain plugs with the magnet, O-rings and oil screen.

Guideline

Oil drain plug	M20x1.5	20 Nm (14.8 lbf ft)
----------------	---------	------------------------

- Install the oil filter. 🛠️ (📄 p. 199)

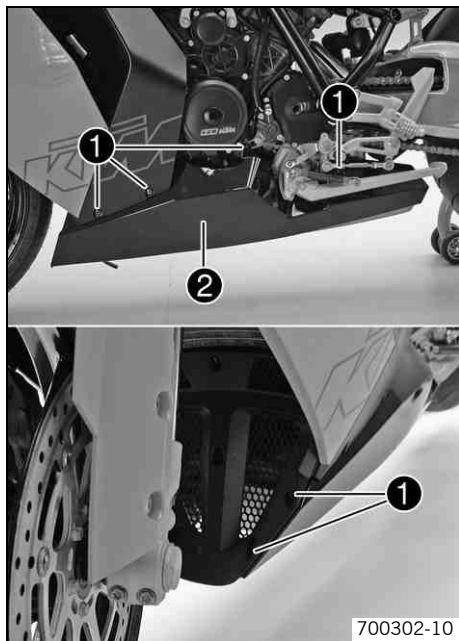

- Position the left exhaust cover ②.
- Mount and tighten screws ①.

Guideline

Screw, trim, painted	M5	3.5 Nm (2.58 lbf ft)
----------------------	----	-------------------------

Removing the oil filter 🛠️



Warning

Danger of scalding Engine oil and gear oil get very hot when the motorcycle is ridden.

- Wear appropriate protective clothing and safety gloves. In case of burns, rinse immediately with lukewarm water.



Warning

Environmental hazard Hazardous substances cause environmental damage.

- Oil, grease, filters, fuel, cleaners, brake fluid, etc., should be disposed of as stipulated in applicable regulations.

- Place a suitable container under the engine.
- Remove screws **1**. Take off oil filter cover **2** with the O-ring.

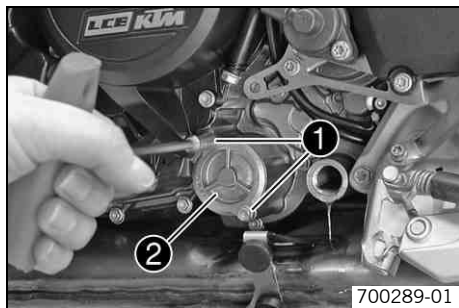

- Pull oil filter **3** out of the oil filter housing.

Circlip pliers reverse (51012011000)

- Completely drain the engine oil.
- Clean the parts and the sealing area thoroughly.

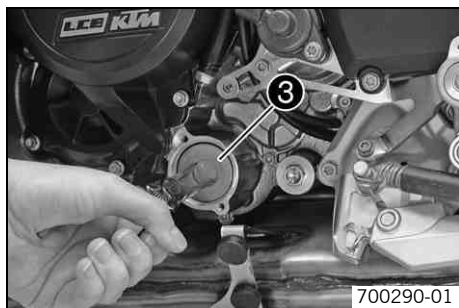

Installing the oil filter

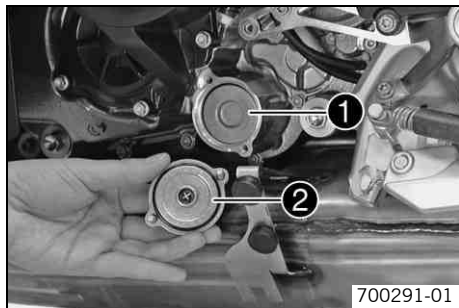

700291-01

- Insert oil filter ❶.
- Lubricate the O-ring of the oil filter cover. Mount oil filter cover ❷.
- Mount and tighten the screws.

Guideline

Remaining engine screws	M5	6 Nm (4.4 lbf ft)
-------------------------	----	-------------------

Filling up with engine oil



Info

Too little engine oil or poor-quality engine oil results in premature wear to the engine.

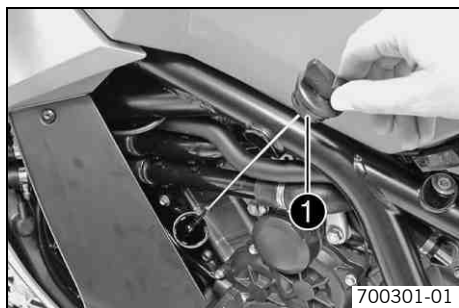

700301-01

- The oil must be topped up in two steps.

Engine oil	3.60 l (3.8 qt.)	External temperature: ≥ 0 °C (≥ 32 °F)	Engine oil (SAE 10W/50) (☛ p. 234)
		External temperature: < 0 °C (< 32 °F)	Engine oil (SAE 5W/40) (☛ p. 234)

- Remove the dipstick ❶ and top up the engine oil.

Engine oil (1st quantity)	3.00 l (3.17 qt.)	External temperature: ≥ 0 °C (≥ 32 °F)	Engine oil (SAE 10W/50) (☛ p. 234)
---------------------------	-------------------	---	---------------------------------------

Engine oil (1st quantity)	3.00 l (3.17 qt.)	External temperature: < 0 °C (< 32 °F)	Engine oil (SAE 5W/40) (☛ p. 234)
---------------------------	-------------------	---	-----------------------------------

- Replace the oil dipstick ❶.



Danger

Danger of poisoning Exhaust gases are poisonous and inhaling them may result in unconsciousness and/or death.

- When running the engine, always make sure there is sufficient ventilation, and do not start or run the engine in an enclosed space without an effective exhaust extraction system.
-
- Start the engine and check that it is oil-tight.
 - Remove the dipstick ❶ and pour in the remaining engine oil.

Engine oil (2nd quantity)	0.60 l (0.63 qt.)	External temperature: ≥ 0 °C (≥ 32 °F)	Engine oil (SAE 10W/50) (☛ p. 234)
		External temperature: < 0 °C (< 32 °F)	Engine oil (SAE 5W/40) (☛ p. 234)

- Replace the oil dipstick ❶.



Danger

Danger of poisoning Exhaust gases are poisonous and inhaling them may result in unconsciousness and/or death.

- When running the engine, always make sure there is sufficient ventilation, and do not start or run the engine in an enclosed space without an effective exhaust extraction system.

- Start the engine and check that it is oil-tight.
- Check the engine oil level. (🔧 p. 193)

Adding engine oil

- i** **Info**
Too little engine oil or poor-quality engine oil results in premature wear to the engine.

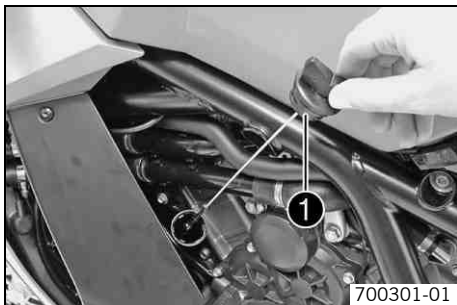

- Check the engine oil level. (🔧 p. 193)
- Remove the dipstick ❶ and add engine oil.

Condition

External temperature: ≥ 0 °C (≥ 32 °F)

Engine oil (SAE 10W/50) (🔧 p. 234)

Condition

External temperature: < 0 °C (< 32 °F)

Engine oil (SAE 5W/40) (🔧 p. 234)

- i** **Info**
For optimal performance of the engine oil, do not mix different types of engine oil.
If appropriate, change the engine oil.

- Replace oil dipstick ❶.

**Danger**





Danger of poisoning Exhaust gases are poisonous and inhaling them may result in unconsciousness and/or death.





- When running the engine, always make sure there is sufficient ventilation, and do not start or run the engine in an enclosed space without an effective exhaust extraction system.
-
- Start the engine and check that it is oil-tight.
 - Check the engine oil level. (👉 p. 193)





Faults	Possible cause	Action
Engine doesn't crank when the electric starter button is pressed	Operating error	– Carry out the start procedure. (☞ p. 88)
	Battery discharged	– Recharge the battery. 🛠️ (☞ p. 159) – Check closed-circuit current. 🛠️
	Fuse 1 , or 6 blown	– Change the fuses of individual power consumers. (☞ p. 163)
	Main fuse blown	– Change the main fuse. (☞ p. 161)
	Ignition/steering lock or emergency OFF switch defective	– Check the ignition/steering lock. 🛠️ – Check the emergency OFF switch. 🛠️
	Safety start system defective	– Read out the trouble code memory using the KTM diagnostics tool. 🛠️
	Immobilizer active	– Read the immobilizer blink code.
	EFI control unit not activated	– Encode the EFI control unit. 🛠️
	Malfunction in CAN bus communication	– Read out the trouble code memory using the KTM diagnostics tool. 🛠️
	Combination instrument defective	– Check the combination instrument. 🛠️
Engine cranks only if the clutch lever is pulled	A gear is engaged	– Shift into neutral.
	Safety start system defective	– Read out the trouble code memory using the KTM diagnostics tool. 🛠️
Engine cranks although it is in gear	Safety start system defective	– Read out the trouble code memory using the KTM diagnostics tool. 🛠️
Engine cranks but doesn't start	Fuse 5 blown	– Change the fuses of individual power consumers. (☞ p. 163)
	Coupling of fuel hose connection not joined together	– Join coupling of fuel hose connection together.





Faults	Possible cause	Action
Engine cranks but doesn't start	Plug connector of wiring harness oxidized	– Clean plug connector and treat with contact spray.
	Fault in fuel injection system	– Read out the trouble code memory using the KTM diagnostics tool. 🛠️
	Fuel pump control defective	– Read out the trouble code memory using the KTM diagnostics tool. 🛠️
	Fuel quality insufficient	– Add suitable fuel.
Engine has too little power	Air filter very dirty	– Change the air filter. 🛠️
	Fuel filter very dirty	– Change the fuel filter. 🛠️
	Fault in fuel injection system	– Read out the trouble code memory using the KTM diagnostics tool. 🛠️
Engine overheats HIGH TEMP	Too little coolant in cooling system	– Check the cooling system for leaks. 🛠️ – Check the coolant level. (🔧 p. 179)
	Cooling fins very dirty	– Clean cooling fins.
	Kinked or damaged radiator hose	– Change the coolant hose. 🛠️
	Thermostat defective	– Check the thermostat. 🛠️
	Fuse 4 blown	– Change the fuses of individual power consumers. (🔧 p. 163)
	Defect in radiator fan system	– Check the radiator fan system. 🛠️
	Air in cooling system	– Add coolant/bleed the cooling system. 🛠️
EFI warning lamp (MIL) lights up / flashes	Fault in fuel injection system	– Read out the trouble code memory using the KTM diagnostics tool. 🛠️
Engine dies during the journey	Lack of fuel	– Fill up with fuel. (🔧 p. 95)
	Fuse 1 , 5 or 6 blown	– Change the fuses of individual power consumers. (🔧 p. 163)





Faults	Possible cause	Action
High oil consumption	Engine oil level too high	– Check the engine oil level. (☞ p. 193)
	Engine oil too thin (viscosity)	– Change the engine oil and filter, clean the oil screen. 🛠️ (☞ p. 194)
Headlight and parking light do not work	Fuse 2 blown	– Change the fuses of individual power consumers. (☞ p. 163)
Brake light and horn do not work	Fuse 3 blown	– Change the fuses of individual power consumers. (☞ p. 163)
Battery discharged	Ignition not switched off when vehicle parked	– Recharge the battery. 🛠️ (☞ p. 159)
	Battery is not charged by the alternator	– Check charging voltage. 🛠️
Combination instrument shows nothing in display	Fuse 1 blown	– Change the fuses of individual power consumers. (☞ p. 163)
Speedometer in combination instrument doesn't work	Wiring harness of wheel revolution counter damaged or plug-in connector oxidized	– Check the wheel speed sensor. 🛠️





Blink code of immobilizer indicator lamp	 <p>12 Immobilizer indicator lamp flashes 1x short, 1 second pause, 2x short</p>
Error level condition	All ignition keys inactive
Blink code of immobilizer indicator lamp	 <p>13 Immobilizer indicator lamp flashes 1x short, 1 second pause, 3x short</p>
Error level condition	ICU antenna malfunction
Blink code of immobilizer indicator lamp	 <p>14 Immobilizer indicator lamp flashes 1x short, 1 second pause, 4x short</p>
Error level condition	Malfunction in transponder of black ignition key
Blink code of immobilizer indicator lamp	 <p>15 Immobilizer indicator lamp flashes 1x short, 1 second pause, 5x short</p>
Error level condition	Black ignition key inactive
Blink code of immobilizer indicator lamp	 <p>16 Immobilizer indicator lamp flashes 1x short, 1 second pause, 6x short</p>
Error level condition	Malfunction, encryption, immobilizer control unit to black ignition key





Blink code of immobilizer indicator lamp	 <p>21 Immobilizer indicator lamp flashes 2x short, 1 second pause, 1x short</p>
Error level condition	Immobilizer control unit not activated
Blink code of immobilizer indicator lamp	 <p>31 Immobilizer indicator lamp flashes 3x short, 1 second pause, 1x short</p>
Error level condition	Malfunction, encryption query from EFI control unit to immobilizer control unit
Blink code of immobilizer indicator lamp	 <p>32 Immobilizer indicator lamp flashes 3x short, 1 second pause, 2x short</p>
Error level condition	Malfunction in CAN bus communication
Blink code of immobilizer indicator lamp	 <p>60 Immobilizer indicator lamp flashes 6x short</p>
Error level condition	E²PROM malfunction



Blink code EFI warning lamp (MIL)	
Error level condition	02 EFI warning lamp (MIL) flashes 2x short Ignition pulse generator - circuit fault
Blink code EFI warning lamp (MIL)	
Error level condition	06 EFI warning lamp (MIL) flashes 6x short Throttle position sensor circuit A - input signal too low Throttle position sensor circuit A - input signal too high
Blink code EFI warning lamp (MIL)	
Error level condition	07 EFI warning lamp (MIL) flashes 7x short Throttle position sensor circuit B - input signal too low Throttle position sensor circuit B - input signal too high
Blink code EFI warning lamp (MIL)	
Error level condition	09 EFI warning lamp (MIL) flashes 9x short Manifold absolute pressure sensor cylinder 1 - input signal too low Manifold absolute pressure sensor cylinder 1 - input signal too high
Blink code EFI warning lamp (MIL)	
Error level condition	11 EFI warning lamp (MIL) flashes 1x long, 1x short Manifold absolute pressure sensor cylinder 2 - input signal too low Manifold absolute pressure sensor cylinder 2 - input signal too high

Blink code EFI warning lamp (MIL)	 <p>12 EFI warning lamp (MIL) flashes 1x long, 2x short</p>
Error level condition	Engine coolant temperature sensor - input signal too low
	Engine coolant temperature sensor - input signal too high
Blink code EFI warning lamp (MIL)	 <p>13 EFI warning lamp (MIL) flashes 1x long, 3x short</p>
Error level condition	Intake air temperature sensor - input signal too low
	Intake air temperature sensor - input signal too high
Blink code EFI warning lamp (MIL)	 <p>14 EFI warning lamp (MIL) flashes 1x long, 4x short</p>
Error level condition	Ambient air pressure sensor - input signal too low
	Ambient air pressure sensor - input signal too high
Blink code EFI warning lamp (MIL)	 <p>15 EFI warning lamp (MIL) flashes 1x long, 5x short</p>
Error level condition	Rollover sensor - input signal too low
	Rollover sensor - input signal too high
Blink code EFI warning lamp (MIL)	 <p>17 EFI warning lamp (MIL) flashes 1x long, 7x short</p>
Error level condition	Lambda sensor cylinder 1, sensor 1 - circuit fault

Blink code EFI warning lamp (MIL)	 18 EFI warning lamp (MIL) flashes 1x long, 8x short
Error level condition	Lambda sensor cylinder 2, sensor 1 - circuit fault
Blink code EFI warning lamp (MIL)	 24 EFI warning lamp (MIL) flashes 2x long, 4x short
Error level condition	Power supply - circuit fault
Blink code EFI warning lamp (MIL)	 25 EFI warning lamp (MIL) flashes 2x long, 5x short
Error level condition	Side stand switch - circuit fault
Blink code EFI warning lamp (MIL)	 33 EFI warning lamp (MIL) flashes 3x long, 3x short
Error level condition	Injector cylinder 1 - circuit fault
Blink code EFI warning lamp (MIL)	 34 EFI warning lamp (MIL) flashes 3x long, 4x short
Error level condition	Injector cylinder 2 - circuit fault

Blink code EFI warning lamp (MIL)	 <p>37 EFI warning lamp (MIL) flashes 3x long, 7x short</p>
Error level condition	Ignition coil cylinder 1 - circuit fault
Blink code EFI warning lamp (MIL)	 <p>38 EFI warning lamp (MIL) flashes 3x long, 8x short</p>
Error level condition	Ignition coil cylinder 2 - circuit fault
Blink code EFI warning lamp (MIL)	 <p>41 EFI warning lamp (MIL) flashes 4x long, 1x short</p>
Error level condition	Fuel pump relay - short circuit to ground or open circuit
	Fuel pump controller - input signal too high
Blink code EFI warning lamp (MIL)	 <p>45 EFI warning lamp (MIL) flashes 4x long, 5x short</p>
Error level condition	Lambda sensor heater cylinder 1, sensor 1 - short circuit to ground or open circuit
	Lambda sensor heater cylinder 1, sensor 1 - input signal too high
Blink code EFI warning lamp (MIL)	 <p>46 EFI warning lamp (MIL) flashes 4x long, 6x short</p>
Error level condition	Lambda sensor heater cylinder 2, sensor 1 - short circuit to ground or open circuit
	Lambda sensor heater cylinder 2, sensor 1 - input signal too high

Blink code EFI warning lamp (MIL)	 <p>49 EFI warning lamp (MIL) flashes 4x long, 9x short</p>
Error level condition	Motor drive circuit A - circuit fault
Blink code EFI warning lamp (MIL)	 <p>50 EFI warning lamp (MIL) flashes 5x long</p>
Error level condition	Throttle position sensor actuator circuit B - circuit fault
Blink code EFI warning lamp (MIL)	 <p>54 EFI warning lamp (MIL) flashes 5x long, 4x short</p>
Error level condition	Secondary air valve - short circuit to ground or open circuit
	Secondary air valve - input signal too high
Blink code EFI warning lamp (MIL)	 <p>68 EFI warning lamp (MIL) flashes 6x long, 8x short</p>
Error level condition	Manifold absolute pressure sensor cylinder 1 - connection leaks
Blink code EFI warning lamp (MIL)	 <p>69 EFI warning lamp (MIL) flashes 6x long, 9x short</p>
Error level condition	Manifold absolute pressure sensor cylinder 2 - connection leaks

Blink code EFI warning lamp (MIL)	 81 EFI warning lamp (MIL) flashes 8x long, 1x short
Error level condition	Immobilizer control unit - circuit fault
Blink code EFI warning lamp (MIL)	 91 EFI warning lamp (MIL) flashes 9x long, 1x short
Error level condition	CAN bus communication error

Cleaning motorcycle

Note

Material damage Damage and destruction of components by high-pressure cleaning equipment.

- Never clean the vehicle with high-pressure cleaning equipment or a strong water-jet. The excessive pressure can penetrate electrical components, socket connects, throttle cables, and bearings, etc., and can damage or destroy these parts.



Warning

Environmental hazard Hazardous substances cause environmental damage.

- Oil, grease, filters, fuel, cleaners, brake fluid, etc., should be disposed of as stipulated in applicable regulations.



Info

To maintain the value and appearance of the motorcycle over a long period, clean it regularly.
Avoid direct sunshine when cleaning the motorcycle.

- Before cleaning, seal the exhaust system to prevent water from entering.
- Remove loose dirt first with a soft jet of water.
- Spray very dirty parts with a normal commercial engine cleaner and then brush off with a soft brush.

Motorcycle cleaner (🔍 p. 238)



Info

Use warm water mixed with a normal commercial engine cleaner and a soft sponge.
If the vehicle has been used on salted roads, clean it with cold water. Warm water intensifies the effects of salt.

- After cleaning the motorcycle thoroughly with a soft jet of water, dry it with compressed air and a cloth.



Warning

Danger of accidents Reduced braking efficiency due to wet or dirty brakes.

- Clean or dry dirty or wet brakes by riding and braking gently.

- After cleaning, ride a short distance until operating temperature is reached, and apply the brakes.



Info

The heat causes water to evaporate from inaccessible parts of the engine and brakes.

- After the engine has cooled down, lubricate or grease all moving parts and bearings.
- Clean the chain. (🔧 p. 126)
- Treat bare metal (except for brake discs and the exhaust system) with an anticorrosive.

Cleaning and preserving materials for metal, rubber and plastic (🔧 p. 237)

- Treat all painted parts with a mild lacquer care spray.

Paint cleaner and polish for high-gloss and matte finishes, bare metal and plastic surfaces (🔧 p. 238)

- Oil the ignition/steering lock, tank lock, and seat lock.

Universal oil spray (🔧 p. 238)

Conservation for winter operation

Info

If you use the motorcycle in the winter, you have to expect salt on the roads. You therefore have to take precautions against the aggressive road salt.

If the vehicle has been used on salted roads, clean it with cold water. Warm water intensifies the effects of salt.

- Clean the motorcycle. (🔧 p. 214)
 - Treat the engine, swingarm and all other bare or galvanized parts (except the brake discs) with a wax-based anticorrosive.
-

Info

Avoid getting anticorrosive on the brake discs: this would badly affect the braking.

After riding on salted roads, thoroughly wash the motorcycle with cold water and dry it well.

- Clean the chain. (🔧 p. 126)

Storage

Info

If you want to garage the motorcycle for a longer period, take the following actions.

Before storing the motorcycle, check all parts for function and wear. If service, repairs or replacements are necessary, you should do this during the storage period (less workshop overload). In this way, you can avoid long workshop waiting times at the start of the new season.

- Make sure the tank is as empty as possible so that you can fill up with fresh fuel when you put the motorcycle back into operation.
- Clean the motorcycle. (🔧 p. 214)
- Change the engine oil and filter, clean the oil screen. 🛠️ (🔧 p. 194)
- Check the coolant level. (🔧 p. 179)
- Check the antifreeze. 🛠️
- Check the tire pressure. (🔧 p. 152)
- Remove the battery. 🛠️ (🔧 p. 155)
- Recharge the battery. 🛠️ (🔧 p. 159)

Guideline

Storage temperature of battery without direct sunshine.	0... 35 °C (32... 95 °F)
---	--------------------------

- The storage place should be dry and not subject to large temperature differences.

Info

KTM recommends jacking up the motorcycle.

- Jack up the motorcycle at the rear. (🔧 p. 101)
- Jack up the motorcycle at the front. (🔧 p. 100)
- Cover the motorcycle with a porous sheet or blanket.



Info

Do not use non-porous materials since they prevent humidity from escaping, thus causing corrosion. Avoid running the engine for a short time only. Since the engine cannot warm up properly, the water vapor produced during combustion condenses and causes valves and exhaust system to rust.

Putting into operation after storage

- Take the front of the motorcycle off the work stand. (🔧 p. 100)
- Take the rear from the work stand. (🔧 p. 101)
- Recharge the battery. 🔌 (🔧 p. 159)
- Install the battery. 🔌 (🔧 p. 157)
- Set the clock with **SET CLOCK**. (🔧 p. 68)
- Fill up with fuel. (🔧 p. 95)
- Make checks before putting into operation. (🔧 p. 87)
- Take a test ride.

Design	2-cylinder 4-stroke Otto motor, 75° V arrangement, water-cooled
Displacement	1,150 cm ³ (70.18 cu in)
Stroke	69 mm (2.72 in)
Bore	103 mm (4.06 in)
Compression ratio	12,5:1
Control	DOHC, 4 valves per cylinder, chain-driven
Valve - valve stem diameter	
Intake	42 mm (1.65 in)
Exhaust	34 mm (1.34 in)
Valve clearance	
Exhaust at: 20 °C (68 °F)	0.25... 0.30 mm (0.0098... 0.0118 in)
Intake at: 20 °C (68 °F)	0.10... 0.15 mm (0.0039... 0.0059 in)
Crankshaft bearing	Sleeve bearing
Conrod bearing	Sleeve bearing
Piston pin bearing	No bearing bushes - DLC-coated piston pins
Piston	Forged light alloy
Piston ring	1 L-ring, 1 tapered compression piston ring, 1 oil scraper ring
Engine lubrication	Dry sump lubrication system with three rotor pumps
Primary transmission	40:76
Clutch	Multi-disc clutch in oilbath / hydraulically operated
Transmission	6-speed claw gears
Transmission ratio	
1st gear	14:36
2nd gear	16:30
3rd gear	20:30

4th gear	21:27
5th gear	23:26
6th gear	25:26
Mixture preparation	Electronically controlled fuel injection
Ignition system	Contactless controlled fully electronic ignition with digital ignition adjustment
Alternator	12 V, 390 W
Spark plug	NGK LKAR9BI9
Electrode gap, spark plug	0.8... 0.9 mm (0.031... 0.035 in)
Cooling	Water cooling, permanent circulation of coolant by water pump
Idle speed	1,500... 1,600 rpm
Cold start device	Electric starter

Capacity - engine oil

Engine oil	3.60 l (3.8 qt.)	External temperature: $\geq 0\text{ }^{\circ}\text{C}$ ($\geq 32\text{ }^{\circ}\text{F}$)	Engine oil (SAE 10W/50) (☛ p. 234)
		External temperature: $< 0\text{ }^{\circ}\text{C}$ ($< 32\text{ }^{\circ}\text{F}$)	Engine oil (SAE 5W/40) (☛ p. 234)

Capacity - coolant

Coolant	2.60 l (2.75 qt.)	Coolant (☛ p. 233)
		Coolant (mixed ready to use) (☛ p. 233)

TECHNICAL DATA - ENGINE TIGHTENING TORQUES

Hose clip, intake flange	M4	1.5 Nm (1.11 lbf ft)	–
Remaining engine screws	M5	6 Nm (4.4 lbf ft)	–
Screw, bearing retainer	M5	6 Nm (4.4 lbf ft)	Loctite® 243™
Screw, gear sensor	M5	3 Nm (2.2 lbf ft)	Loctite® 243™
Screw, pulse generator	M5	10 Nm (7.4 lbf ft)	Loctite® 243™
Freewheel ring bolt	M6 – 10.9	15 Nm (11.1 lbf ft)	Loctite® 648™
Nut, cylinder head	M6	9 Nm (6.6 lbf ft)	–
Plug, vacuum connection	M6	5 Nm (3.7 lbf ft)	Loctite® 243™
Remaining engine screws	M6	10 Nm (7.4 lbf ft)	–
Screw, camshaft bearing support	M6 – 10.9	10 Nm (7.4 lbf ft)	–
Screw, clutch cover	M6	10 Nm (7.4 lbf ft)	–
Screw, clutch spring	M6	12 Nm (8.9 lbf ft)	Loctite® 243™
Screw, coolant connection on cylinder head	M6	10 Nm (7.4 lbf ft)	–
Screw, engine case	M6x60	10 Nm (7.4 lbf ft)	–
Screw, engine case	M6x80	10 Nm (7.4 lbf ft)	–
Screw, engine case	M6x90	10 Nm (7.4 lbf ft)	–
Screw, freewheel holder	M6	10 Nm (7.4 lbf ft)	Loctite® 243™
Screw, locking lever	M6	10 Nm (7.4 lbf ft)	Loctite® 243™
Screw, oil pump cover	M6	10 Nm (7.4 lbf ft)	Loctite® 243™
Screw, shift drum locating	M6	10 Nm (7.4 lbf ft)	Loctite® 243™
Screw, shift lever	M6	10 Nm (7.4 lbf ft)	Loctite® 243™
Screw, starter motor	M6	10 Nm (7.4 lbf ft)	–
Screw, stator clamp	M6	10 Nm (7.4 lbf ft)	Loctite® 243™

TECHNICAL DATA - ENGINE TIGHTENING TORQUES

Screw, valve cover	M6	10 Nm (7.4 lbf ft)	–
Screw, water pump cover	M6	10 Nm (7.4 lbf ft)	–
Screw, water pump wheel	M6	10 Nm (7.4 lbf ft)	Loctite® 243™
Stud, chain shaft	M6	8 Nm (5.9 lbf ft)	–
Vacuum connection	M6	5 Nm (3.7 lbf ft)	Loctite® 243™
Oil jet	M6x0.75	4 Nm (3 lbf ft)	Loctite® 243™
Plug, crankshaft retainer	M8	15 Nm (11.1 lbf ft)	–
Screw, camshaft bearing support	M8 – 10.9	Step 1 10 Nm (7.4 lbf ft) Step 2 18 Nm (13.3 lbf ft)	–
Screw, camshaft bearing support	M8 – 10.9	Step 1 8.5 Nm (6.27 lbf ft) Step 2 14.5 Nm (10.7 lbf ft)	Only applies when using: Hex key bit (61229025000)
Screw, engine case	M8	18 Nm (13.3 lbf ft)	–
Screw, engine console	M8	20 Nm (14.8 lbf ft)	Loctite® 243™
Screw, heat exchanger	M8	15 Nm (11.1 lbf ft)	–
Screw, timing chain guide rail	M8	15 Nm (11.1 lbf ft)	Loctite® 243™
Screw, timing chain tensioning rail	M8	15 Nm (11.1 lbf ft)	Loctite® 243™
Stud, exhaust flange	M8	10 Nm (7.4 lbf ft)	–
Oil pressure sensor	M10x1	10 Nm (7.4 lbf ft)	–
Plug, cam lever axis	M10x1	15 Nm (11.1 lbf ft)	–
Plug, clutch lubrication	M10x1	15 Nm (11.1 lbf ft)	–

TECHNICAL DATA - ENGINE TIGHTENING TORQUES

Screw, conrod bearing	M10x1	Step 1 25 Nm (18.4 lbf ft) Step 2 30 Nm (22.1 lbf ft) Step 3 90°	–
Screw, timing chain tensioner release	M10x1	10 Nm (7.4 lbf ft)	–
Cylinder head screw	M11x1.5	Tightening sequence: Using a crisscross pattern Step 1 15 Nm (11.1 lbf ft) Step 2 30 Nm (22.1 lbf ft) Step 3 90° Step 4 90°	Lubricated with engine oil
Coolant temperature sensor	M12x1.5	12 Nm (8.9 lbf ft)	–
Rotor screw	M12x1.5	90 Nm (66.4 lbf ft)	–
Spark plug	M12x1.5	17 Nm (12.5 lbf ft)	–
Nut of engine sprocket	M20x1.5	100 Nm (73.8 lbf ft)	Loctite® 243™
Oil drain plug	M20x1.5	20 Nm (14.8 lbf ft)	–
Nut, inner clutch hub	M22x1.5	130 Nm (95.9 lbf ft)	Loctite® 243™
Plug, timing-chain tensioner	M24x1.5	25 Nm (18.4 lbf ft)	–
Screw in alternator cover	M24x1.5	8 Nm (5.9 lbf ft)	–
Nut, primary gear	M33LHx1.5	130 Nm (95.9 lbf ft)	Loctite® 243™

Frame	Lattice frame made of chromium molybdenum steel tubing, powder-coated
Fork	WP Suspension Up Side Down 4354
Shock absorber	WP Suspension 4014 VP
Suspension travel	
Front	120 mm (4.72 in)
Rear	125 mm (4.92 in)
Brake system	
Front	Twin floating disc with radial mount, 4-piston calipers
Rear	Single non-floating disc with 2 piston brake caliper
Brake discs - diameter	
Front	320 mm (12.6 in)
Rear	220 mm (8.66 in)
Brake discs - wear limit	
Front	4.0 mm (0.157 in)
Brake disc - wear limit	
Rear	4.5 mm (0.177 in)
Tire air pressure, solo	
Front	2.5 bar (36 psi)
Rear	2.5 bar (36 psi)
Tire air pressure with passenger / full payload	
Front	2.5 bar (36 psi)
Rear	2.9 bar (42 psi)
Secondary drive	17:38
Chain	5/8 x 5/16" X-ring

Steering head angle	66.7°
Wheelbase	1,430 mm (56.3 in)
Seat height, unloaded	
Lower frame rear position	805 mm (31.69 in)
Upper frame rear position	825 mm (32.48 in)
Ground clearance, unloaded	110 mm (4.33 in)
Weight without fuel approx.	184 kg (406 lb.)
Maximum permissible front axle load	150 kg (331 lb.)
Maximum permissible rear axle load	240 kg (529 lb.)
Maximum permissible total weight	380 kg (838 lb.)

Battery	YTZ14S	Battery voltage: 12 V Nominal capacity: 11.2 Ah maintenance-free
Fuse	58011109130	30 A
Fuse	75011088015	15 A
Fuse	75011088010	10 A

Lighting equipment

Low beam / high beam	H7 / base PX26d	12 V 55 W
Parking light	W5W/ base W2.1x9.5d	12 V 5 W
Instrument lights and control lamps	LED	
Turn signal	LED	
Brake/tail light	LED	

License plate lamp	W5W/ base W2.1x9.5d	12 V 5 W
--------------------	---------------------	-------------

Tires

Front tire	Rear tire
120/70 ZR 17 M/C 58W TL Pirelli Diabolo Rosso	190/55 ZR 17 M/C 75W TL Pirelli Diabolo Rosso
Additional information is available in the Service section under: http://www.ktm.com	

Capacity - fuel

Total fuel tank capacity, approx.	16.5 l (4.36 US gal)	Super unleaded (ROZ 95 / RON 95 / PON 91) (☛ p. 236)
Fuel reserve, approx.	3.5 l (3.7 qt.)	

Fork part number	05.18.7J.07	
Fork	WP Suspension Up Side Down 4354	
Compression damping		
Comfort	15 clicks	
Standard	10 clicks	
Sport	5 clicks	
Full payload	5 clicks	
Rebound damping		
Comfort	15 clicks	
Standard	10 clicks	
Sport	5 clicks	
Full payload	5 clicks	
Spring preload - Preload Adjuster		
Comfort	5 turns	
Standard	5 turns	
Sport	3 turns	
Full payload	3 turns	
Spring length with preload spacer(s)	405 mm (15.94 in)	
Spring rate		
Medium (standard)	9.5 N/mm (54.2 lb/in)	
Air chamber length	80 ⁺²⁰ ₋₁₀ mm (3.15 ^{+0.79} _{-0.39} in)	
Fork length	735 mm (28.94 in)	
Fork oil per fork leg	520 ml (17.58 fl. oz.)	Fork oil (SAE 5) (☛ p. 235)

TECHNICAL DATA - SHOCK ABSORBER

228

Shock absorber part number	17.18.7E.07
Shock absorber	WP Suspension 4014 VP
Compression damping, high-speed	
Comfort	3 turns
Standard	2.5 turns
Sport	1.5 turns
Full payload	1.5 turns
Compression damping, low-speed	
Comfort	20 clicks
Standard	15 clicks
Sport	10 clicks
Full payload	10 clicks
Rebound damping	
Comfort	15 clicks
Standard	10 clicks
Sport	5 clicks
Full payload	10 clicks
Spring preload	
Comfort	6 mm (0.24 in)
Standard	6 mm (0.24 in)
Sport	8 mm (0.31 in)
Full payload	8 mm (0.31 in)
Spring rate	
Medium (standard)	95 N/mm (542 lb/in)
Spring length	160 mm (6.3 in)

TECHNICAL DATA - SHOCK ABSORBER

Gas pressure	10 bar (145 psi)
Static sag	15 mm (0.59 in)
Riding sag	30 mm (1.18 in)
Inbuilt length	290 mm (11.42 in)
Shock absorber oil (☛ p. 235)	SAE 2,5

TECHNICAL DATA - CHASSIS TIGHTENING TORQUES

Screw, side stand switch	M4	2 Nm (1.5 lbf ft)	Loctite® 243™
Remaining frame bolts	M5	5 Nm (3.7 lbf ft)	–
Screw, brake fluid reservoir of rear brake	M5	5 Nm (3.7 lbf ft)	Loctite® 243™
Screw, brake line holder	M5	5 Nm (3.7 lbf ft)	–
Screw, chain guard	M5	5 Nm (3.7 lbf ft)	–
Screw, chain sliding piece	M5	5 Nm (3.7 lbf ft)	–
Screw, fuel level indicator	M5	3 Nm (2.2 lbf ft)	–
Screw, fuel tank guard	M5x12	3 Nm (2.2 lbf ft)	–
Screw, steering damper fixing bracket	M5	5 Nm (3.7 lbf ft)	Loctite® 243™
Screw, trim, painted	M5	3.5 Nm (2.58 lbf ft)	–
Bolt, foot brake lever stub	M6	10 Nm (7.4 lbf ft)	Loctite® 243™
Remaining chassis nuts	M6	15 Nm (11.1 lbf ft)	–
Remaining chassis screws	M6	10 Nm (7.4 lbf ft)	–
Screw, exhaust clamp	M6	8 Nm (5.9 lbf ft)	–
Screw, exhaust heat shield	M6	15 Nm (11.1 lbf ft)	–
Screw, foot brake cylinder	M6	10 Nm (7.4 lbf ft)	Loctite® 243™
Screw, foot brake lever	M6	15 Nm (11.1 lbf ft)	Loctite® 243™
Screw, fuel pump	M6	6 Nm (4.4 lbf ft)	–
Screw, shift lever stub	M6	10 Nm (7.4 lbf ft)	Loctite® 243™
Screw, shift rod	M6	12 Nm (8.9 lbf ft)	Loctite® 243™
Screw, shift shaft deflector on chain securing guide	M6	10 Nm (7.4 lbf ft)	Loctite® 243™
Screw, shift shaft deflector on shift shaft	M6	18 Nm (13.3 lbf ft)	Loctite® 243™
Fork end pinch bolts	M8	15 Nm (11.1 lbf ft)	–

TECHNICAL DATA - CHASSIS TIGHTENING TORQUES

Nut, forked bracket on foot brake lever	M8	30 Nm (22.1 lbf ft)	Loctite® 243™
Remaining chassis nuts	M8	30 Nm (22.1 lbf ft)	–
Remaining chassis screws	M8	25 Nm (18.4 lbf ft)	–
Screw of rear brake caliper	M8	22 Nm (16.2 lbf ft)	Loctite® 243™
Screw, bottom triple clamp	M8	15 Nm (11.1 lbf ft)	–
Screw, clamp, eccentric shaft of deflector	M8	18 Nm (13.3 lbf ft)	–
Screw, front brake disc	M8	30 Nm (22.1 lbf ft)	Loctite® 243™
Screw, front footrest bracket	M8	25 Nm (18.4 lbf ft)	Loctite® 243™
Screw, handlebar stub	M8	20 Nm (14.8 lbf ft)	–
Screw, ignition lock	M8	25 Nm (18.4 lbf ft)	Loctite® 243™
Screw, rear brake disc	M8	30 Nm (22.1 lbf ft)	Loctite® 243™
Screw, rear footrest bracket	M8	25 Nm (18.4 lbf ft)	–
Screw, shift lever	M8	25 Nm (18.4 lbf ft)	Loctite® 243™
Screw, side stand bracket	M8	25 Nm (18.4 lbf ft)	Loctite® 243™
Screw, spring holder on side stand bracket	M8	15 Nm (11.1 lbf ft)	Loctite® 243™
Screw, steering damper clamp on console	M8	20 Nm (14.8 lbf ft)	Loctite® 243™
Screw, steering damper fixing bracket on triple clamp	M8	10 Nm (7.4 lbf ft)	Loctite® 243™
Screw, steering stem	M8	20 Nm (14.8 lbf ft)	–
Screw, subframe	M8	20 Nm (14.8 lbf ft)	Loctite® 243™
Screw, top triple clamp	M8	17 Nm (12.5 lbf ft)	–
Screw, work stand adapter	M8	18 Nm (13.3 lbf ft)	–

TECHNICAL DATA - CHASSIS TIGHTENING TORQUES

Remaining chassis nuts	M10	50 Nm (36.9 lbf ft)	–
Remaining chassis screws	M10	45 Nm (33.2 lbf ft)	–
Screw, connecting lever, shock absorber deflector	M10	45 Nm (33.2 lbf ft)	Loctite® 243™
Screw, engine bearer	M10	45 Nm (33.2 lbf ft)	–
Screw, shock absorber	M10	45 Nm (33.2 lbf ft)	Loctite® 243™
Screw, side stand	M10	35 Nm (25.8 lbf ft)	Loctite® 243™
Rear sprocket bolt	M10x1.25	50 Nm (36.9 lbf ft)	Loctite® 243™
Screw, front brake caliper	M10x1.25	45 Nm (33.2 lbf ft)	Loctite® 243™
Nut of bell crank on frame	M14x1.5	100 Nm (73.8 lbf ft)	–
Lambda sensor	M18x1.5	45 Nm (33.2 lbf ft)	–
Nut, swingarm pivot	M19x1.5	130 Nm (95.9 lbf ft)	Thread greased
Screw, seat lock	M22x1.5	8 Nm (5.9 lbf ft)	–
Bolt, front axle	M25x1.5	45 Nm (33.2 lbf ft)	–
Nut, rear wheel spindle	M25x1.5	90 Nm (66.4 lbf ft)	Thread greased
Screw, steering head	M25x1.5	18 Nm (13.3 lbf ft)	–

Brake fluid DOT 4 / DOT 5.1

According to

- DOT

Guideline

- Use only brake fluid that complies with the specified standards (see specifications on the container) and that possesses the corresponding properties. KTM recommends **Castrol** and **Motorex®** products.

Supplier

Castrol

- **RESPONSE BRAKE FLUID SUPER DOT 4**

Motorex®

- **Brake Fluid DOT 5.1**

Coolant

Guideline

- Use only suitable coolant (also in countries with high temperatures). Use of low-quality antifreeze can lead to corrosion and foaming. KTM recommends **Motorex®** products.

Mixture ratio

Antifreeze protection: -25... -45 °C (-13... -49 °F)	50 % corrosion inhibitor/antifreeze 50 % distilled water
--	---

Coolant (mixed ready to use)

Antifreeze	-40 °C (-40 °F)
------------	-----------------

Supplier

Motorex®

- **Anti Freeze**

Engine oil (SAE 10W/50)

According to

- JASO T903 MA (☛ p. 239)
- SAE (☛ p. 239) (SAE 10W/50)

Guideline

- Use only engine oils that comply with the specified standards (see specifications on the container) and that possess the corresponding properties. KTM recommends **Motorex®** products.

Fully synthetic engine oil

Supplier

Motorex®

- **Power Synt 4T**

Engine oil (SAE 5W/40)

According to

- JASO T903 MA (☛ p. 239)
- SAE (☛ p. 239) (SAE 5W/40)

Guideline

- Use only engine oils that comply with the specified standards (see specifications on the container) and that possess the corresponding properties. KTM recommends **Motorex®** products.

Synthetic engine oil

Supplier

Motorex®

- **Power Synt 4T**

Fork oil (SAE 5)

According to

- SAE (☛ p. 239) (SAE 5)

Guideline

- Use only oils that comply with the specified standards (see specifications on the container) and that possess the corresponding properties. KTM recommends **Motorex**[®] products.

Supplier

Motorex[®]

- **Racing Fork Oil**

Hydraulic fluid (15)

According to

- ISO VG (15)

Guideline

- Use only hydraulic fluid that complies with the specified standards (see specifications on the container) and that possesses the corresponding properties. KTM recommends **Motorex**[®] products.

Supplier

Motorex[®]

- **Hydraulic Fluid 75**

Shock absorber oil (SAE 2,5) (50180342S1)

According to

- SAE (☛ p. 239) (SAE 2,5)

Guideline

- Use only oils that comply with the specified standards (see specifications on the container) and that possesses the corresponding properties.

Super unleaded (ROZ 95 / RON 95 / PON 91)

According to

- DIN EN 228 (ROZ 95 / RON 95 / PON 91)

Chain cleaner

Guideline

- KTM recommends **Motorex®** products.

Supplier

Motorex®

- **Chain Clean 611**

Chain lube for road use

Guideline

- KTM recommends **Motorex®** products.

Supplier

Motorex®

- **Chain Lube 622 Strong**

Cleaning and preserving materials for metal, rubber and plastic

Guideline

- KTM recommends **Motorex®** products.

Supplier

Motorex®

- **Protect & Shine 645**

Long-life grease

Guideline

- KTM recommends **Motorex®** products.

Supplier

Motorex®

- **Fett 2000**

Motorcycle cleaner

Guideline

- KTM recommends **Motorex®** products.

Supplier

Motorex®

- **Moto Clean 900**

Paint cleaner and polish for high-gloss and matte finishes, bare metal and plastic surfaces

Guideline

- KTM recommends **Motorex®** products.

Supplier

Motorex®

- **Clean & Polish**

Universal oil spray

Guideline

- KTM recommends **Motorex®** products.

Supplier

Motorex®

- **Joker 440 Universal**

JASO T903 MA

Different technical development directions required a new specification for 4-stroke motorcycles – the JASO T903 MA Standard. Earlier, engine oils from the automobile industry were used for 4-stroke motorcycles because there was no separate motorcycle specification. Whereas long service intervals are demanded for automobile engines, high performance at high engine speeds are in the foreground for motorcycle engines. With most motorcycles, the gearbox and the clutch are lubricated with the same oil as the engine. The JASO MA Standard meets these special requirements.

SAE

The SAE viscosity classes were defined by the Society of Automotive Engineers and are used for classifying oils according to their viscosity. The viscosity describes only one property of oil and says nothing about quality.

A

Accessories 8

B

Battery
 installing 157
 recharging 159
 removing 155

Blank time of the LAP button LAP BLANK T
 setting 70

Blink code
 engine control 208-213
 immobilizer 206-207

Brake disc of rear brake
 checking 134

Brake discs, front
 checking 133

Brake fluid
 of rear brake, adding 139
 topping up for front brake 136

Brake fluid level
 front brake, checking 135
 rear brake, checking 139

Brake linings **137**
 front brake, checking 138
 rear brake, checking 141

Brakes 93

Braking 93

C

Chain
 checking 131
 checking for dirt 126
 cleaning 126

Chain tension
 adjusting 129
 checking 128

Cleaning 214-215

Clutch
 fluid level, checking 182
 fluid level, correcting 183

Clutch lever **19**
 adjusting basic position 182

Combination instrument
 activation and test 26
CHANGE MODE menu 49, 63, 65
 display 27
DISTANCE TO Next Service menu 39, 62, 65
FUELDISTANCE menu 37, 62, 65
FUELRANGE menu 38, 62, 65
 function buttons, handlebar 25
 indicator lamps 29
 info display 28
LAP menu, **LAP BLANK T** button 53, 63, 65
LAP/BESTLAP/LastLap menu 43, 62, 65

LAP/BESTLAP/TopSpeed menu	44, 63, 65
LAPSTOGO menu	41, 62, 65
notes/warnings	30
odometer menu ODO/Trip 1	35, 62, 65
odometer menu ODO/Trip 2	36, 62, 65
OPTIONS menu	59, 64, 66
OUTERTEMP menu	61, 64, 66
SET °C/°F menu	58, 64, 66
SET CLOCK menu	50, 63, 65
SET KM/MILES menu	57, 64, 66
SET NUM LAPS menu	54, 64-65
SETTINGS menu	51, 63, 65
SET-UP menu	48, 63, 65
SHIFT RPMS menu	52, 63, 65
TOPSPEED menu	42, 62, 65
total distance menu in Race mode RACEODO	45, 63, 65
TPMS menu	60, 64, 66
TRIP F RESET menu	55, 64, 66
UNITS menu	56, 64, 66
Conservation for winter operation	216
Coolant level	
checking	179
Cooling system	179
filling compensating tank	180
E	
Electric starter button	23
Emergency OFF switch	22

Engine	
running in	84
Engine number	17
Engine oil	
adding	201
changing	194
draining	194
refilling	199
Engine oil level	
checking	193
Engine sprocket	
checking	131
Environment	10
External temperature display	
switching on/off	75
F	
Filler cap	
closing	78
opening	77
Filling up	
fuel	95
Foot brake lever	82
adjusting	125
checking free travel	125
Foot brake lever stub	
adjusting	124

Footrest position	117
adjusting	117
Fork	102
compression damping, adjusting	102
fork legs, bleeding	105
rebound, adjusting	103
spring preload, adjusting	104
Fork part number	17
Front wheel	
installing	144
removing	142
Fuel reserve display TRIP F RESET	
setting	73
Fuse	
individual power consumers, changing	163
H	
Hand brake lever	19
basic position, adjusting	135
Handlebar	
handlebar height	185
handlebar height, adjusting	186
Headlight adjustment	
adjusting	174
checking	174
Headlight flasher switch	20

Helmet lock	80
attaching to vehicle	155
High beam bulb	
changing	168
Horn button	21
I	
Ignition key	
activating/deactivating	175
Ignition lock	22
Immobilizer	23
K	
Key number	16
Kilometers/miles SET KM/MILES	
setting	74
L	
Lap times	
displaying	66
Light switch	20
Loading the vehicle	85
Low beam bulb	
changing	165
Luggage	85

M		P	
Main fuse		Parking	94
changing	161	Parking light bulb	
Maintenance	8	changing	171
Materials	8	Passenger footrests	80
Maximum speed		Passenger seat	
displaying	67	mounting	154
Motorcycle		removing	154
cleaning	214	Play in the throttle cable	
jacking up front	100	checking	184
jacking up rear	101	Putting into operation	
taking front off work stand	100	advice on first use	83
taking rear from work stand	101	after storage	218
		checks to be made before putting into operation	87
N		R	
Number of laps SET NUM LAPS		RACE mode	
setting	72	setting	68
O		Rear frame position	188
Oil filter		adjusting	189
changing	194	Rear hub cush drive	
installing	199	checking	150
removing	197	Rear sprocket	
Oil screen		checking	131
cleaning	194	Rear wheel	
Owner's manual	11	installing	147
		removing	146

Riding	90
starting up	89
ROAD mode	
setting	68
S	
Seat	
fitting	153
removing	153
Seat lock	79
Service schedule	97-99
SET °C/°F temperature unit	
setting	75
SET CLOCK	
setting	68
Shift lever	81
adjusting	120
Shift lever stub	
adjusting	120
Shift speed RPM1/2	
adjusting	69
Shifting	90
Shock absorber	102
compression damping, general	106
compression damping, high-speed, adjusting	107
compression damping, low-speed, adjusting	106
rebound damping, adjusting	108

spring preload, adjusting	109
Shock absorber part number	18
Side stand	82
Spare parts	8
Starting	88
Steering damper	111
adjusting	111
Steering damper part number	18
Steering lock	22
Stopping	94
Storage	217
Supporting strap	78

T

Technical data	
chassis	224-226
chassis tightening torques	230-232
engine	219-220
engine tightening torques	221-223
fork	227
shock absorber	228-229
Throttle cable play	
adjusting	185
Tire air pressure	
checking	152
Tire condition	
checking	150

Tool set	79
Transport	9
Troubleshooting	203-205
Turn signal switch	21
Type label	16
U	
Use definition	8
V	
Vehicle identification number	16
Vehicle level	113
front, adjusting	114
rear, adjusting	116
View of vehicle	
front left	12
rear right side	14
W	
Warranty	8
Work rules	9



3211523en



11/2009 Photo: Mitterbauer



KTM-Sportmotorcycle AG
5230 Mattighofen/Austria
<http://www.ktm.com>