

KTM

125 Sting '98

BEDIENUNGSANLEITUNG
OWNER'S HANDBOOK
MANUEL D'UTILISATION

ART. NR. 320536
11.97



IMPORTANT

WE STRONGLY SUGGEST THAT YOU READ THIS HANDBOOK CAREFULLY AND COMPLETELY BEFORE YOU TAKE YOUR FIRST RIDE. IT CONTAINS INFORMATION AND TIPS THAT WILL ENABLE YOU TO OPERATE AND HANDLE YOUR MOTORCYCLE PROPERLY.

PAY ATTENTION ESPECIALLY TO THE FOLLOWING INSTRUCTIONS:

⚠ WARNING ⚠
IGNORING THESE INSTRUCTIONS CAN ENDANGER YOUR BODY AND YOUR LIFE.

! CAUTION !
IGNORING THESE INSTRUCTIONS COULD CAUSE DAMAGE TO PARTS OF YOUR MOTORCYCLE OR THAT THE MOTORCYCLE IS NOT ROAD-SAFE ANYMORE.

Please insert the series numbers of your motorcycle in the boxes below

Frame number

Engine number

Stamp of dealer

Introduction

We would like to congratulate you on your purchase of a KTM motorcycle.

You are now owner of a sporty and modern motorcycle which you are bound to have a great time with, provided you care for it properly. This manual will furnish you with important information on how to operate and maintain your new KTM motorcycle. At the time of printing, the handbook covered the most up-to-date models in this series. It is, however, possible that we may have made slight modifications in the meantime due to development in our motorcycle design.

Many motorcyclists have a good working knowledge of motorcycle mechanics; if this is true in your case, you will be able to use this manual to carry out most of the maintenance steps yourself. If, on the other hand, you are not very familiar with motorcycles, it might be better to have a professional KTM dealer perform those steps marked * described in the chapter entitled "Maintenance Work on Chassis and Engine" of this manual.

Take special care to follow the recommended run in, inspection, and maintenance intervals. Heeding these guidelines will significantly increase the life of your motorcycle. Have services carried out by a KTM dealer so that your warranty claim remains intact.

We wish you a lot of fun when driving !



KTM Austria's certificate of achievement for its Quality System ISO 9001 is the beginning of an on-going total re-engineering quality plan for a brighter tomorrow.

KTM SPORTMOTORCYCLE AG
5230 MATTIGHOFEN, AUSTRIA

ALL RIGHTS RESERVED TO MAKE ALTERATIONS TO DESIGN AND MODEL.

INDEX

	Page
LOCATING THE SERIAL NUMBERS	4
Frame number	4
Engine number, engine type	4
OPERATION INSTRUMENTS	4
Clutch lever	4
Choke lever	4
Hand brake lever	4
Speedometer, tachometer	5
Indicator lamps	5
Ignition lock, steering lock	5
Combination switch	6
Starter tip switch, emergency OFF switch	6
Filler cap	6
Fuel	6
Fuel tap	7
Oil tank	7
Shift lever	8
Foot brake pedal	8
Passenger handles	8
DRIVING INSTRUCTIONS	9
PERIODIC MAINTENANCE-SCHEDULE	12
MAINTENANCE WORK ON CHASSIS AND ENGINE	13
Tool kit	13
Dismounting and mounting of seat	13
Check and adjust steering head bearing	14
Changing the spring preload of the shock absorber	14
Check chain tension	14
Readjusting chain tension	15
Chain maintenance	15
Chain wear	15
General informations about disc brakes	15
Checking of brake fluid level - front brake	16
Refilling the front brake reservoir	16
Checking the front brake pads	16
Changing the basic position of the brake pedal	17
Checking the rear brake fluid level	17
Refilling the rear brake reservoir	17
Checking the rear brake pads	17
Dismounting and mounting the front wheel	18
Dismounting and mounting the rear wheel	18
Tires, air pressure	19
Checking spoke tension	19
Main fuse	19
Batterie	20
Charging the battery	20
Cooling system	21
Checking the cooling liquid level	21
Adjusting the clutch cable	22
Adjusting the choke cable	22
Adjusting the throttle cable	22
Adjust the idle speed	22
Checking the gear oil level	22
Changing gear oil	23
Bleeding the oil pump	23
Removing the headlight mask	23
Replacing the headlight lamp	24
Replacing the instrument light	24
Replacing the indicator lamps	24
TRUBLE SHOOTING	25
CLEANING	27
CONSERVATION FOR WINTER OPERATION	27
STORAGE	27
Re-initiation after time of storage	27
TECHNICAL SPECIFICATIONS - CHASSIS	28
TECHNICAL SPECIFICATIONS - ENGINE	29
WIRING DIAGRAM	appendix

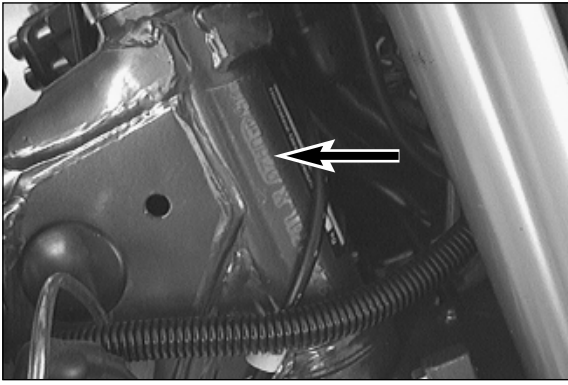

LOCATING THE SERIAL NUMBERS

Frame number

The frame number is stamped on the right side of the steering head tube. Write the number into the box on page 1.

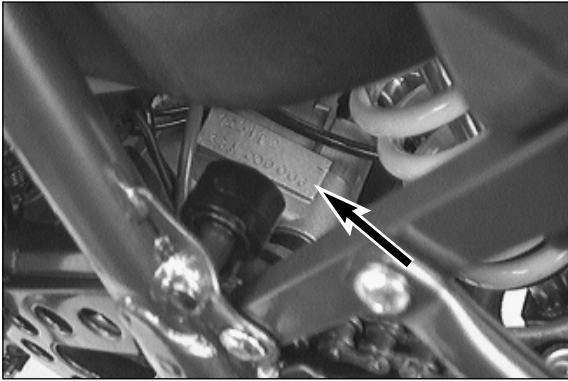

Engine number, engine type

Engine number and engine type are stamped into the engine housing underneath the carburetor. Write this number into the box on page 1.

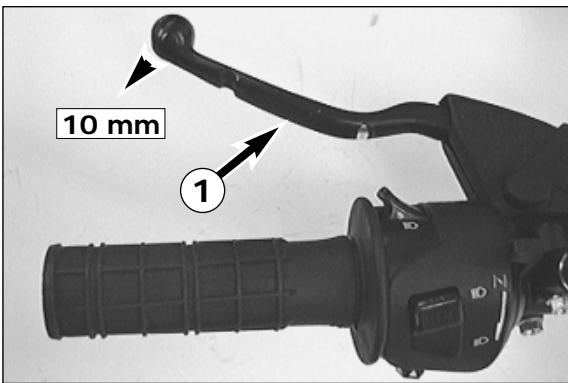

OPERATION INSTRUMENTS

Clutch lever

The clutch lever ① is fitted on the left hand side of the handle bar. When engine is cold, there should be a play of 10 mm (0.4 in) (measured at outer edge).

! CAUTION !

IF THERE IS NO PLAY ON THE CLUTCH LEVER, THE CLUTCH WILL START TO SLIP. THE CLUTCH WILL THEN OVERHEAT, DESTROYING THE CLUTCH LININGS.

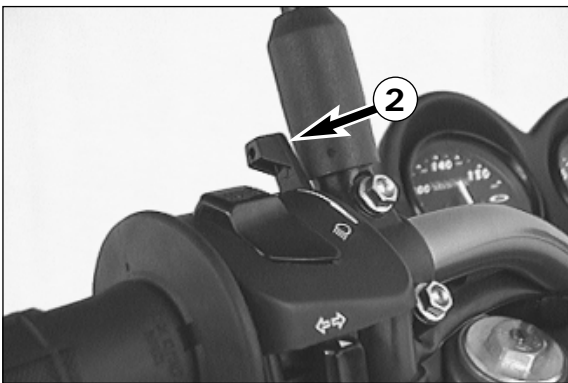

Choke lever

When the choke lever ② is pulled backwards, a bore is opened in the carburetor which enables the engine to draw in additional fuel. This produces a „rich“ fuel/air mixture necessary for cold start. When the choke lever is pushed forward as far as it will go, the bore will be closed again. In this position the choke cable must have a play of approx. 2mm (0.8 in.).

! CAUTION !

IF THERE IS NO PLAY IN THE CHOKE CABLE, THE BORE OF THE COLD STARTER SYSTEM CANNOT BE COMPLETELY CLOSED. THIS RESULTS IN HIGH FUEL CONSUMPTION, THE ENGINE RUNS UNEVENLY WITH EXTREME WEAR OF PISTON AND CYLINDER.

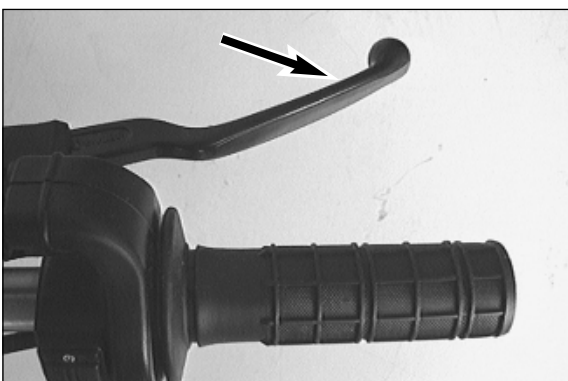

Hand brake lever

The hand brake lever is mounted on the right side of the handlebar.

⚠ WARNING ⚠

IF THE RESISTANCE IN THE HAND BRAKE LEVER OR FOOT BRAKE PEDAL FEELS „SPONGY“ (NOT ENOUGH RESISTANCE), THIS IS AN INDICATION THAT SOMETHING IS WRONG WITH THE BRAKE SYSTEM. DON'T RIDE YOUR MOTORCYCLE ANYMORE WITHOUT FIRST HAVING THE BRAKE SYSTEM LOOKED OVER BY A KTM DEALER.

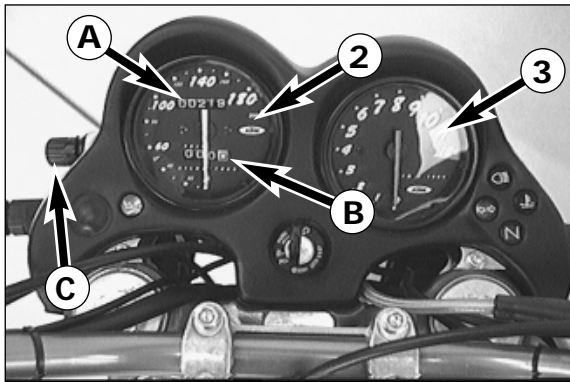

Speedometer, tachometer

The mileage indicator **A** in the speedometer **2** indicates overall mileage. The day mileage indicator **B** can be set to 0 by means of the setting wheel **C**. Turn the setting wheel forward until only zeros can be seen in the display. The tachometer **3** shows the engine speed in revolutions per minute (rpm). Do not push the engine into the orange zone, which begins at 10.500 rpm.

- ! CAUTION !**
- MAXIMUM RECOMMENDED ROTATION RATE IS 10.500 RPM. ROTATION RATES EXCEEDING 10.500 RPM WILL SHORTEN YOUR ENGINE'S LIFE. REFER ALSO TO THE SECTION ON RUNNING IN YOUR MOTORCYCLE TO BE FOUND IN THE "DRIVING INSTRUCTIONS" CHAPTER.
 - SPEEDOMETER AND TACHOMETER ARE NOT SUPPOSED TO GET IN CONTACT WITH FUEL. WIPE OFF SPLASHED FUEL ON THE PLASTIC PARTS IMMEDIATELY, OTHERWISE THE PLASTIC PARTS MIGHT GET DAMAGED.

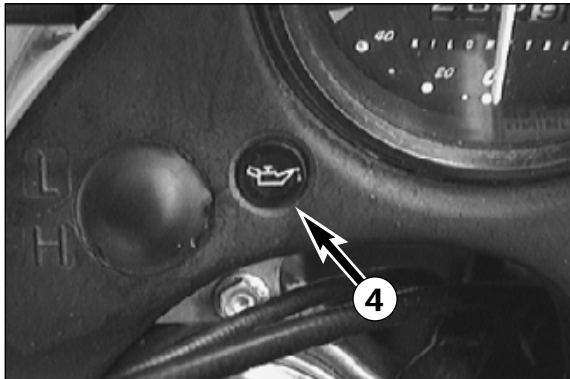

Indicator lamps

- The red oil level warning lamp **4** lights up when the ignition is switched on, indicating that the oil level warning system works properly.
- If the two-stroke oil level in the oil tank is sufficiently high, the oil level warning lamp will go out after approximately two seconds.
- If the oil level has decreased to approximately 300 ccm, the oil level warning lamp will stay on, reminding you that the oil tank must be refilled with two-stroke oil within the next 100 kilometers.

- ! CAUTION !**
- CHECK FUNCTION OF OIL LEVEL WARNING LAMP BEFORE EVERY RIDE
 - ONCE THERE IS NO TWO-STROKE OIL IN THE OIL TANK, THE ENGINE IS BOUND TO BREAK DOWN.
 - OIL PUMP AND OIL LINES MUST BE BLED WHENEVER THE OIL TANK WAS COMPLETELY EMPTIED (SEE BLEEDING THE OIL PUMP). OTHERWISE THE OIL PUMP WILL NOT DELIVER OIL, THUS CAUSING ENGINE DAMAGE.



- The green indicator lamp flashes when the flasher light is working in the same rhythm as the flasher light.
- The green indicator lamp lights up when the gear is switched to idle.
- The blue indicator lamp lights up when the high beam is on.
- The red cooling liquid temperature warning lamp lights up at a cooling liquid temperature of 110° C.

! CAUTION !
PAY ATTENTION TO THE DIRECTIONS IN THE CHAPTER „COOLING SYSTEM“ ON PAGE 21

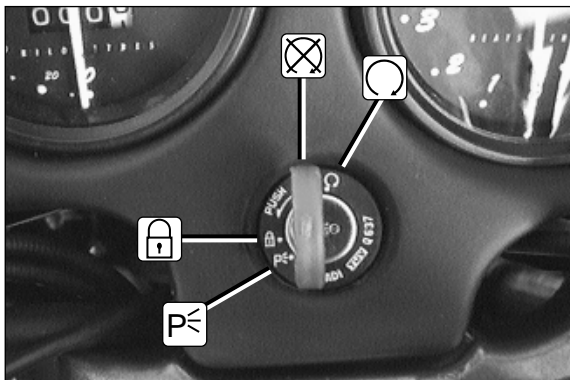

Ignition lock, steering lock

There are four positions to this lock. They are:

- = ignition off, light off
- = ignition on, - engine turned off: just parking light is on
- engine running: parking light and headlight on
- = ignition off, light off, handlebar locked

! CAUTION !

BRIEFLY PRESS THE KEY IN THE POSITION IN ORDER TO TURN THE IGNITION LOCK TO OR . THE HANDLEBAR CAN BE LOCKED BY TURNING IT FIRST INTO THE EXTREME LEFT POSITION AND THEN TURNING THE IGNITION KEY TO THE POSITION.
IMPORTANT: Do not push the ignition key into the keyhole while switching positions.

- = ignition off, parking light on, handlebar locked

! CAUTION !

DO NOT LEAVE THE PARKING LIGHT ON FOR MORE THAN THREE HOURS WITH THE ENGINE OFF. OTHERWISE YOU WILL NOT BE ABLE TO START THE ENGINE WITH THE ELECTRIC STARTER.
ADDITIONALLY, THE BATTERY IS DISCHARGED BELOW THE NORMAL LEVEL AND THEREBY DAMAGED. IN THIS CASE, THE BATTERY SHOULD BE RECHARGED AS SOON AS POSSIBLE.



The ignition key can be removed in the positions , , and .

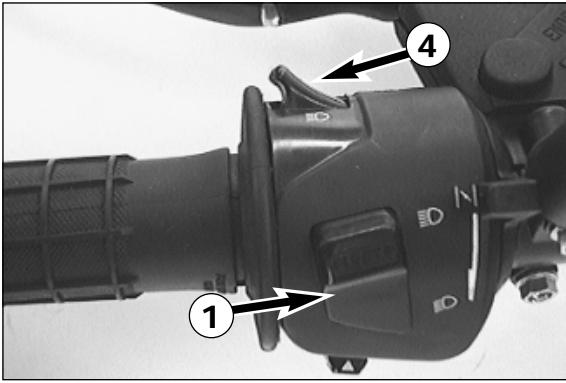

Combination switch

The rocker switch ① actuates the high beam and low beam.

☰☉ = High-beam light

☷☉ = Low-beam light

The switch ② returns to central position after actuation. Press flasher switch towards switch housing to switch off the flasher.

↶ = Flasher left

↷ = Flasher right

📢 = The horn is sounded with button ③.

☰☉ = The light signal (high beam) is actuated with button ④.

NOTE: The engine must be running in order to be able to check that all current consumers are functioning correctly.

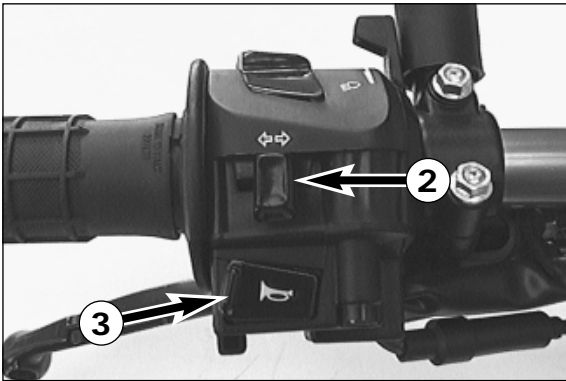

Starter tip switch, emergency OFF switch

⚡ Use the starter tip switch ⑤ to operate the electric starter.

! CAUTION !
 MAXIMUM PERIOD FOR CONTINUOUS STARTING: 5 SECONDS. WAIT AT LEAST 5 SECONDS BEFORE TRYING AGAIN.

The emergency off switch ⑥ is mainly a safety and emergency switch and should normally be on.

⊗ If this symbol is visible on the switch, the engine can be started (i.e. the ignition circuit and the starter circuit are switched on).

⊘ If this symbol is visible on the switch, the engine can not be started (i.e. the ignition circuit and the starter circuit are interrupted).

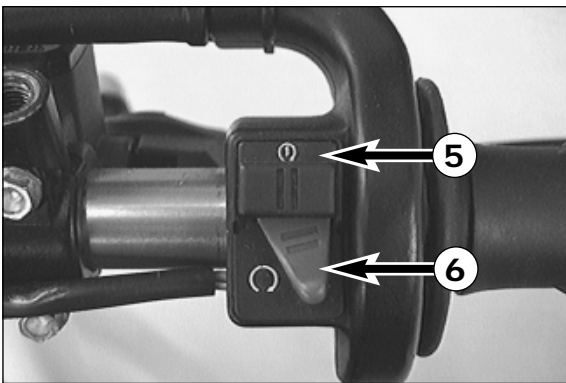

Filler cap

To open filler cap: Turn the filler cap counter-clockwise.

To close filler cap: Screw on the filler cap clockwise. Place the tank venting hose ⑦ in position, avoiding any kinks.

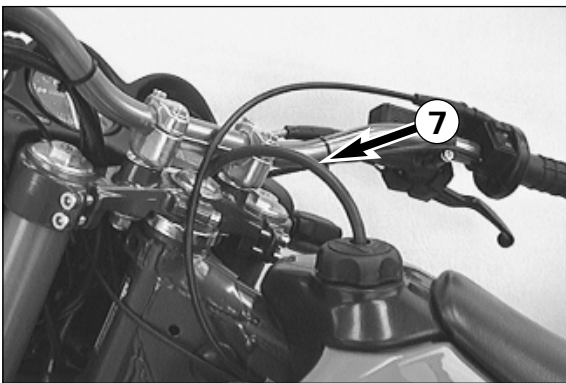

Fuel

This motorcycle is equipped with separate lubrication. This means that the two-stroke oil required for engine lubrication is not admixed to the fuel but contained in a separate oil tank (see page 7). An oil pump is used for controlled admixing of two-stroke oil into the fuel in the carburetor.

Besides, the motorcycle is equipped with a catalytic converter. Therefore, it is absolutely necessary to fill in unleaded fuel.

Fuel:

UNLEADED REGULAR GASOLINE WITH AT LEAST 91 OCTANES (RON)

Fuel expands when its temperature rises. Therefore do not fill the tank to the top (see fig.).

Fuel tank capacity 8.5 liter



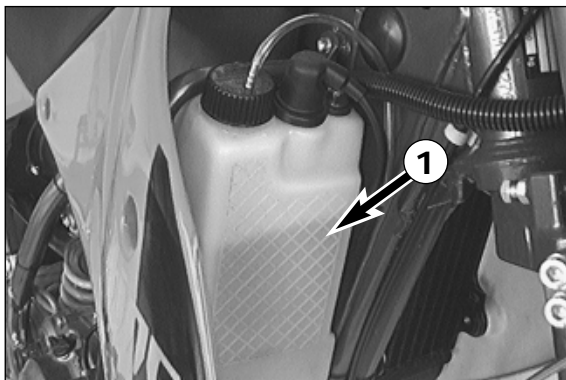
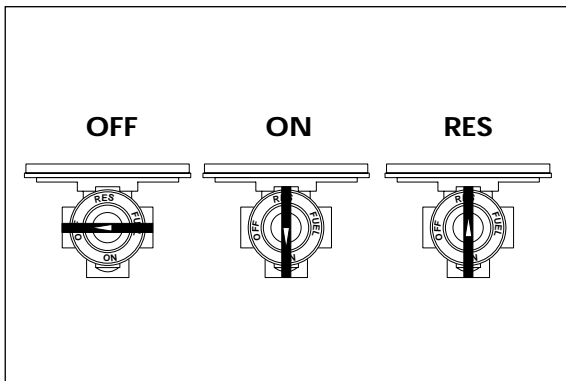
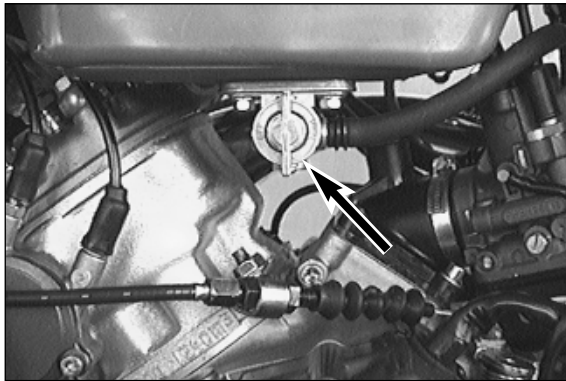
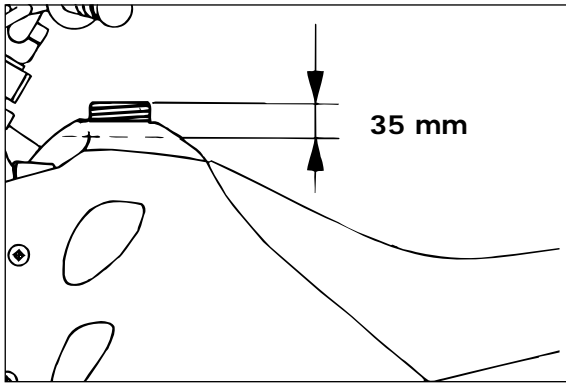

⚠ WARNING ⚠

GASOLINE IS HIGHLY FLAMMABLE AND POISONOUS. EXTREME CAUTION SHOULD BE USED WHEN HANDLING GASOLINE. DO NOT REFUEL THE MOTORCYCLE NEAR OPEN FLAMES OR BURNING CIGARETTES. ALWAYS SWITCH OFF THE ENGINE BEFORE REFUELLING. BE CAREFUL NOT TO SPILL GASOLINE ON THE ENGINE OR EXHAUST PIPE WHILE THE ENGINE IS HOT. WIPE UP SPILLS PROMPTLY. IF GASOLINE IS SWALLOWED OR SPLASHED IN THE EYES, SEEK A DOCTOR'S ADVICE IMMEDIATELY.

! CAUTION !

NEVER FILL IN LEADED FUEL. LEADED FUEL WILL DESTROY THE CATALYTIC CONVERTER.

Fuel tap

- OFF** In this position the fuel tap is closed. No fuel may flow to the carburetor.
- ON** When using the motorcycle, the twist grip must be set to the ON position. Now fuel may flow to carburetor. In this position the tank empties down to the fuel reserve of approx. 3 liters.
- RES** The reserve tank, approximately 3 liters, cannot be tapped until the twist grip is turned to the RES position. Fill the tank as soon as possible and remember to turn the twist grip back to the ON position so that you will have backup fuel next time, too.

! CAUTION !

THE FUEL TAP SHOULD BE LOCKED WHENEVER THE MOTORCYCLE IS PARKED. IF THE TAP IS NOT CLOSED THE CARBURETOR MAY OVERFLOW AND FUEL GET INTO THE ENGINE.

NOTE:

That the fuel tank can completely be emptied this motorcycle has two fuel taps.
Open both fuel taps before each start.
Close both fuel taps after each riding.

Oil tank

The oil tank ❶ is mounted on the right side in front of the fuel tank. Here, the two-stroke oil for separate lubrication of the engine must be filled in. The oil level can easily be checked through the transparent material of the oil tank.

Engine oil:
2-stroke engine oil suitable for a mixing ratio of 1:50
and for separate lubrication
KTM recommends SHELL ADVANCE VSX2

To open it: pull vent hose out of the frame and turn closure cap counter-clockwise.

To close it: apply closure cap and turn it clockwise. Stick vent hose into frame and install it without kinks.

Tank volume: 1.3 liters

! CAUTION !

- ONCE THERE IS NO TWO-STROKE OIL IN THE OIL TANK, THE ENGINE IS BOUND TO BREAK DOWN.
- THE VENT HOSE MUST ALWAYS BE INSTALLED WITHOUT KINKS.
- OIL PUMP AND OIL LINES MUST BE BLED WHENEVER THE OIL TANK WAS COMPLETELY EMPTIED (SEE BLEEDING THE OIL PUMP). OTHERWISE THE OIL PUMP WILL NOT DELIVER OIL, THUS CAUSING ENGINE DAMAGE.

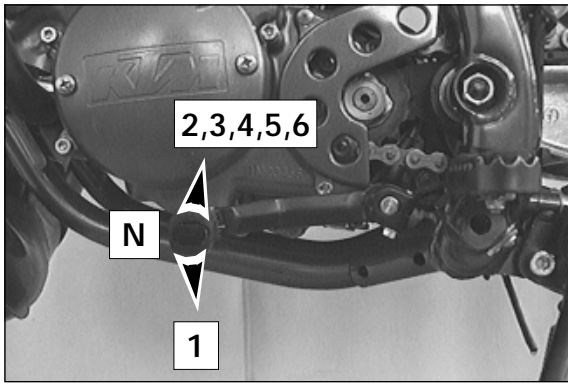

Shift lever

The shift lever is mounted on the left side of the engine. The position of the gears is shown in the illustration. Neutral, or the idle speed, is located between first and second gear.

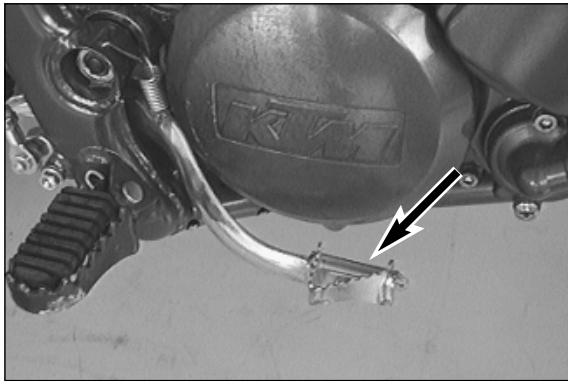

Foot brake pedal

The foot brake pedal is located in front of the right footrest. The basic position can be adjusted to the seat position (see maintenance work).



WARNING



IF THE RESISTANCE IN THE HAND BRAKE LEVER OR FOOT BRAKE PEDAL FEELS "SPONGY" (NOT ENOUGH RESISTANCE), THIS IS AN INDICATION THAT SOMETHING IS WRONG WITH THE BRAKE SYSTEM. DON'T RIDE YOUR MOTORCYCLE ANYMORE WITHOUT FIRST HAVING THE BRAKE SYSTEM LOOKED OVER BY A KTM DEALER.

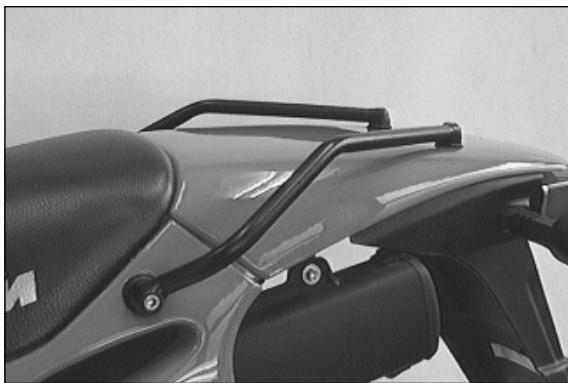

Passenger handles

On the tail of the motorcycle you will find two handles which a passenger can use to hold on to.

Check the following before each start

When you start off, the motorcycle must be in a perfect technical condition. For safety reasons, you should make a habit of performing an overall check of your motorcycle before each start.

The following checks should be performed:

- 1 OIL LEVEL IN OIL TANK
Once there is no two-stroke oil in the oil tank, the engine is bound to break down. The vent hose of the oil tank must be installed without kinks.
- 2 GEAR OIL LEVEL
Insufficient amounts of oil in the transmission will lead to premature wear and subsequently to transmission failure.
- 3 FUEL
Check that there is sufficient fuel in the tank.
- 4 CHAIN
A loose chain can fall off; an extremely worn chain can tear, and insufficient lubrication can result in unnecessary wear to the chain and rear sprockets.
- 5 TIRES
Check for damaged tires. Tires showing cuts or dents must be replaced. The tread depth must comply with the legal regulations. Also check the air pressure. Insufficient tread and incorrect air pressure reduce the driving performance.
- 6 BRAKES
Check correct functioning of the braking system. Check for sufficient brake fluid in the reservoir. If the level of brake fluid falls below the minimum value, this indicates a leak in the braking system or completely worn out brake pads. Arrange for the braking system to be checked by a KTM specialist garage, as complete failure of the braking system can be expected.
Also check the state of the brake hoses and the thickness of the brake linings. Brake linings measured at their thinnest point should not be less than 1 mm since extremely worn linings can lead to brake failure.
- 7 CABLES
Check correct setting and easy running of all control cables.
- 8 COOLING LIQUID
Check the level of cooling liquid when the engine is cold.
- 9 ELECTRICAL SYSTEM
Check correct functioning and adjustment of headlights, parking light, tail-lights, brake lights, flashers, indicator lamps, horn and emergency OFF switch while the engine is running.
- 10 LUGGAGE
If you are taking luggage with you, check that this is securely fastened.



WARNING



- WEAR SUITABLE CLOTHING WHEN DRIVING A MOTORCYCLE. CLEVER KTM DRIVERS ALWAYS WEAR A HELMET, BOOTS, GLOVES AND A JACKET, REGARDLESS OF WHETHER DRIVING ALL DAY OR JUST FOR A SHORT TRIP. THE PROTECTIVE CLOTHING SHOULD BE BRIGHTLY COLOURED SO THAT OTHER USERS OF THE ROADS CAN SEE YOU AS EARLY AS POSSIBLE. YOUR PASSENGER OF COURSE WILL ALSO NEED SUITABLE PROTECTIVE CLOTHING.
- DO NOT DRIVE AFTER HAVING CONSUMED ALCOHOL.
- ONLY USE ACCESSORIES THAT HAVE BEEN RELEASED BY KTM. FOR EXAMPLE, FRONT PANELLING CAN IMPAIR THE DRIVING PROPERTIES OF THE MOTORCYCLE. CASES, EXTRA TANKS ETC. CAN ALTER THE WEIGHT DISTRIBUTION AND THUS ALSO IMPAIR THE VEHICLE'S DRIVING PROPERTIES.
- THE FRONT AND REAR WHEEL ARE ONLY ALLOWED TO BE TIRED WITH TIRES THAT HAVE THE SAME PROFILE TYPE.

Instructions for initial operation





- Read the entire manual carefully before your first drive.
- Familiarize yourself with the operating elements.
- Adjust the foot brake pedal to the most comfortable position for you.
- Get used to handling the motorcycle on an empty car park, before starting on a longer drive. Also try to drive as slowly as possible and in standing position, to improve your feeling for the vehicle.
- Hold the handlebar with both hands and leave your feet on the foot rests while driving.
- Remove your foot from the foot brake pedal when you are not braking. If the foot brake pedal is not released the brake pads rub continuously and the braking system is overheated.
- You may only be accompanied by a passenger if your motorcycle is fitted and registered for such purposes. The passenger must hold tight to the brackets or hold on to the driver during the drive, with his feet on the passenger foot rests.
- Do not make any alterations to the motorcycle and always use ORIGINAL KTM SPARE PARTS. Spare parts from other manufacturers can impair the safety of the motorcycle.
- Motorcycles are sensitive to alterations in the distribution of weight. If you are taking luggage with you, this should be secured as close as possible to the middle of the vehicle; distribute the weight evenly between the front and rear wheel. Never exceed the maximum permissible laden weight and the axle weights. The maximum permissible laden weight is made up of the following components:
 - Motorcycle ready for operation and tank full
 - Luggage
 - Driver and passenger with protective clothing and helmet.
- Pay attention to running in instructions.

Running in

Even finely machined surfaces of engine parts have rougher surfaces than parts that slide on each other for a long time. Therefore, every engine must be run in. For this reason, do not demand maximum performance from the engine for the first 100 kilometers. The vehicle must be run in at low, changing performance level for the first 1.000 KM (620 miles). The maximum number of revolutions per minute must not go exceed 7.500 rpm. Once you have run your engine in for 1.000 km (620 mi), you may push it to its 10.500 rpm limit, i.e. up to the orange zone indicated in the tachometer. Exceeding the above listed rotations as well as pushing high rpm when the engine is cold will have an adverse effect on the life of your engine.



Starting when the engine is cold

- Open the fuel tap
- Turn on the ignition (ignition key position: )
- Switch the gear to NEUTRAL (green lamp N  on).
- Switch on the emergency OFF switch (symbol  must be visible).
- Operate the choke lever .
- Swing up the stand.
- Operate the starter tip switch  without accelerating.
- If the engine starts, push the choke lever back a little bit, as soon as the engine runs unevenly.



WARNING



DO NOT START THE ENGINE AND ALLOW IT TO IDLE IN A CLOSED AREA. EXHAUST FUMES ARE POISONOUS AND CAN CAUSE LOSS OF CONSCIOUSNESS AND DEATH. ALWAYS PROVIDE ADEQUATE VENTILATION WHILE THE ENGINE IS RUNNING.



CAUTION



- MAXIMUM PERIOD FOR CONTINUOUS STARTING: 5 SECONDS. WAIT AT LEAST 5 SECONDS BEFORE TRYING AGAIN.
- DON'T RIDE YOUR MOTORCYCLE WITH FULL LOAD AND DON'T REV ENGINE WHEN COLD. BECAUSE THE PISTON IS WARMING UP FASTER THAN THE WATER COOLED CYLINDER, IT CAN CAUSE ENGINE DAMAGE. ALWAYS KEEP IN MIND THAT THE ENGINE SHOULD BE WARMED UP WITH SMALL LOAD AT MEDIUM R.P.M.

IF THE ENGINE DOES NOT CRANK WHEN YOU ACTUATE THE STARTER TIP SWITCH:

- Check if the transmission is switched to idle
- Check if the ignition is on
- Check if the emergency OFF switch is on
- Check if the parking light and the cockpit lights are on.
 - If this is not the case, the battery is discharged
 - If the lights are on, proceed as described in the „Trouble-shooting“ section or contact a KTM dealer.

IF THE ENGINE CRANKS BUT DOES NOT START, WHEN YOU ACTUATE THE STARTER TIP SWITCH:



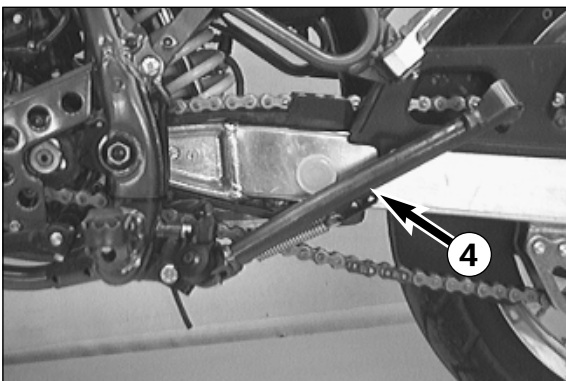
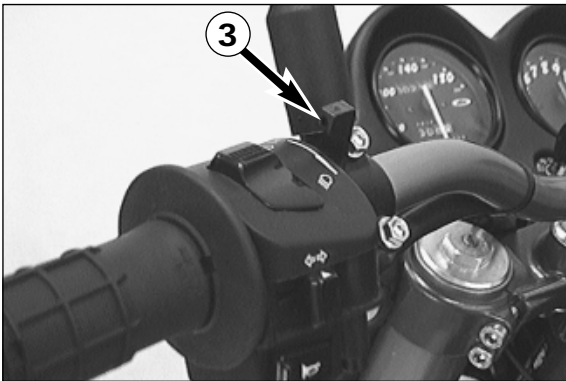
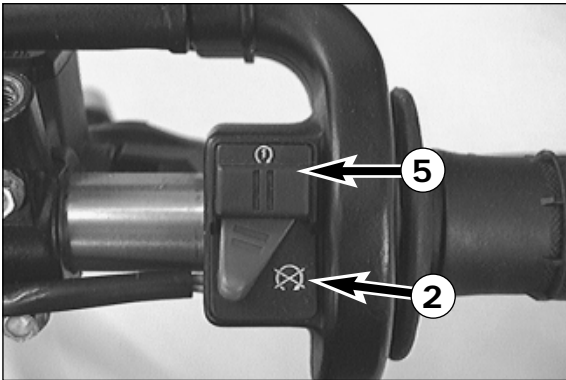
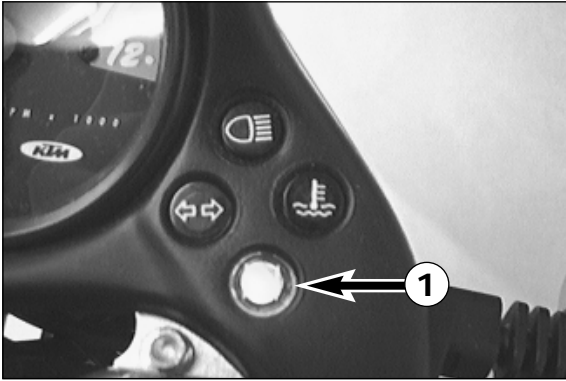

- Check if the fuel tap is open
- Check if the choke lever has been operated
- Check if sufficient fuel is in the tank
 - If this is not the case, refill the tank
 - if sufficient fuel is in the tank, proceed as described in the „Trouble-shooting“ section or contact a KTM dealer.

NOTE:

- When you turn on the ignition, you will hear a brief whirring sound. While you hear this sound, a cleaning cycle of the control roller in the cylinder is executed.
- Check if the oil level warning lamp works properly (see „Control lamps“).



Starting when the engine is warm

- Open the fuel tap
- Turn on the ignition (ignition key position: )
- Switch the gear to NEUTRAL (green lamp N  on).
- Switch on the emergency OFF switch (symbol  must be visible).
- Swing up the stand.
- Turn up the throttle a bit, and actuate starter tip switch .

What to do when the engine is „flooded“

The throttle must be fully opened when starting.

Starting off

Pull the clutch lever. Put the engine into first gear, slowly release the clutch lever and open throttle at the same time.



WARNING



BEFORE YOU START OFF, CHECK THAT THE STAND  HAS BEEN SWUNG RIGHT UP TO THE TOP. IF THE STAND DRAGS ON THE GROUND, THE MOTORCYCLE CAN GO OUT OF CONTROL.

Shifting/Riding

You are now in first gear, referred to as the drive or uphill gear. Depending on the conditions (traffic, road gradient, etc.), you can shift to a higher gear. Close throttle, at the same time pull clutch lever and shift to the next higher gear. Let clutch lever go again and open throttle. If you turned on the choke, make sure you turn it off again as soon as engine is warm.

When you reach full speed through turning the throttle grip all the way, turn throttle back to 3/4; the speed hardly decreases although the engine will use less gas. Never open the throttle wider than the engine can handle. Excessive turning of the throttle grip will increase full consumption.

By shifting down, use the brakes if necessary and close throttle at the same time. Pull clutch lever and shift down to the next gear. Let clutch lever go slowly and open throttle or shift down again.

If the engine is killed f.ex. at a crossing, simply pull the clutch lever and start. It is not necessary to switch the gear to NEUTRAL.

⚠ WARNING ⚠

- OBSERVE THE TRAFFIC REGULATIONS, DRIVE DEFENSIVELY AND TRYING TO LOOK AHEAD AS FAR AS POSSIBLE SO THAT ANY HAZARDS CAN BE RECOGNIZED AS EARLY AS POSSIBLE.
- ADJUST YOUR DRIVING SPEED ACCORDING TO THE CONDITIONS AND YOUR DRIVING SKILLS.
- DRIVE CAREFULLY ON UNKNOWN ROADS
- REPLACE THE HELMET VISOR RESPECTIVELY GOGGLE GLASSES IN PLENTY OF TIME. WHEN LIGHT SHINES DIRECTLY ON SCRATCHED VISOR OR GOGGLES, YOU WILL BE PRACTICALLY BLIND.
- AFTER FALLING WITH THE MOTORCYCLE, CHECK ALL FUNCTIONS THOROUGHLY BEFORE STARTING UP OPERATIONS AGAIN.

! CAUTION !

- HIGH RPM RATES WHEN THE ENGINE IS COLD HAVE AN ADVERSE EFFECT ON THE LIFE OF YOUR ENGINE. WE RECOMMEND YOU RUN THE ENGINE IN A MODERATE RPM RANGE FOR A FEW MILES GIVING IT A CHANCE TO WARM UP. AFTER THAT NO FURTHER PRECAUTIONS IN THIS RESPECT NEED BE TAKEN.
- SHIFT TO THE NEXT HIGHER GEAR BY 10500 RPM AT THE LATEST.
- NEVER HAVE THE THROTTLE WIDE OPEN WHEN CHANGING DOWN TO A LOWER GEAR. THE ENGINE WILL OVERSPEED, DAMAGING THE VALVES. IN ADDITION, THE REAR WHEEL BLOCKS SO THAT THE MOTORCYCLE CAN EASILY GET OUT OF CONTROL.
- IF DURING EXTENDED DOWNHILL RIDES THE ENGINE IS RUNNING ALONG WITHOUT ANY ACTUATION OF THE THROTTLE, YOU HAVE TO TURN UP THE THROTTLE A BIT ONCE IN A WHILE TO MAKE SURE THAT ENOUGH ENGINE OIL IS FED TO THE ENGINE.
- IF THE RED OIL LEVEL WARNING LAMP LIGHT UP, IT WILL BE NECESSARY TO REFILL THE OIL TANK WITH TWO-STROKE ENGINE OIL DURING THE NEXT 100 KILOMETERS (SEE PAGE 7).
- OIL PUMP AND OIL LINES MUST BE BLED WHENEVER THE OIL TANK WAS COMPLETELY EMPTIED (SEE BLEEDING THE OIL PUMP). OTHERWISE THE OIL PUMP WILL NOT DELIVER OIL, THUS CAUSING ENGINE DAMAGE.
- IN THE EVENT THAT, WHILE RIDING ON YOUR MOTORCYCLE, YOU NOTICE ANY UNUSUAL OPERATION-RELATED NOISE, STOP IMMEDIATELY, TURN THE ENGINE OFF, AND CONTACT AN AUTHORIZED KTM DEALER.

NOTE TO THE COOLING SYSTEM

If due to slow traffic in cities or waiting at a traffic light, for example, little or no relative wind is blowing through the radiators, it may happen that the cooling water temperature rises and the red cooling liquid temperature warning lamp lights up (appr. 110°C, 238°F). In this case, you should try to drive on briskly, if possible, for generally the lamp will stop being lit soon if enough relative wind gets into the radiators. However, you should check the cooling liquid level later on after the engine has cooled down again.

! CAUTION !

HOWEVER, IF THE RED COOLING-LIQUID TEMPERATURE WARNING LAMP LIGHTS UP WHILE YOU ARE DRIVING ALONG BRISKLY, THIS WILL INDICATE A DEFECT IN THE COOLING SYSTEM. IN THIS CASE, STOP IMMEDIATELY, SINCE OTHERWISE YOU MAY DAMAGE YOUR ENGINE. LET YOUR ENGINE COOL DOWN, CHECK THE COOLING SYSTEM FOR LEAKS, AND CHECK THE COOLANT LEVEL. CAUTION - SCALDING HAZARD! DO NOT DRIVE ON, UNTIL THERE IS SUFFICIENT LIQUID IN THE COOLING SYSTEM

⚠ WARNING ⚠

IF THE RADIATOR CAP IS REMOVED WHEN THE ENGINE IS HOT, HOT COOLING LIQUID, THAT IS UNDER PRESSURE, CAN SPRAY OUT AND CAUSE SEVERE BURNS. ALLOW YOUR ENGINE TO COOL DOWN AND, IN THE MEANTIME, CHECK THE COOLING SYSTEM FOR LEAKS.

Braking

Close throttle and apply the hand and foot brakes at the same time. When driving on sandy, wet or slippery ground use mainly the rear wheel brake. Always brake with feeling, blocking wheels can cause you to skid or fall. Also change down to lower gears depending on your speed.

⚠ WARNING ⚠

WHEN YOU BRAKE, THE BRAKE DISCS, BRAKE PADS, BRAKE CALIPER AND BRAKE FLUID HEAT UP. THE HOTTER THESE PARTS GET, THE WEAKER THE BRAKING EFFECT. IN EXTREME CASES, THE ENTIRE BRAKING SYSTEM CAN FAIL.

Stopping and parking

Apply the brakes fully and put the engine into neutral. To stop the engine, switch off the ignition. Close fuel tap. Park on solid ground and lock the vehicle.

⚠ WARNING ⚠

- NEVER LEAVE YOUR MOTORCYCLE WITHOUT SUPERVISION AS LONG AS THE ENGINE IS RUNNING.
- MOTORCYCLE ENGINES PRODUCE A GREAT AMOUNT OF HEAT WHILE RUNNING. THE ENGINE, THE RADIATORS, EXHAUST SYSTEM, MUFFLER, BRAKE DISCS, AND SHOCK ABSORBERS CAN BECOME VERY HOT. DO NOT TOUCH ANY OF THESE PARTS AFTER OPERATING THE MOTORCYCLE, AND TAKE CARE TO PARK IT WHERE PEDESTRIANS ARE NOT LIKELY TO TOUCH IT AND GET BURNED.
- NEVER PARK YOUR MOTORCYCLE IN PLACES WHERE THERE EXIST FIRE HAZARDS DUE TO DRY GRASS OR OTHER EASILY FLAMMABLE MATERIALS.

! CAUTION !

- ALWAYS USE THE IGNITION LOCK TO TURN OFF THE ENGINE. IF YOU USE THE EMERGENCY OFF SWITCH TO TURN OFF THE ENGINE WITHOUT SWITCHING OFF THE IGNITION, THE PARKING LIGHT WILL STAY ON, THUS DISCHARGING THE BATTERY SO THAT THE ENGINE CAN'T BE STARTED WITH THE ELECTRIC STARTER ANY LONGER.
- WHEN PARKING YOUR MOTORCYCLE ALWAYS CLOSE THE TWO FUEL TAPS. WITH THE FUEL TAPS OPEN, THE CARBURETOR MIGHT OVERFLOW AND FUEL COULD FLOW INTO THE ENGINE.
- ALWAYS TAKE OUT THE IGNITION KEY WHEN PARKING YOUR MOTORCYCLE SO THAT IT CANNOT BE USED BY UNAUTHORIZED PERSONS.
- PARK YOUR MOTORCYCLE, SO THAT IT RESTS STABLY ON THE STAND (HARD GROUND, LEVEL SURFACE) AND CAN'T TIP OVER.

PERIODIC MAINTENANCE SCHEDULE 125 Sting

LC2, Sting 11.97



KTM rider

KTM dealer

before each start	after washing	1st service, after 1000 km (600 miles)	2nd service at 4000 km (2500 miles)	after 4000 km (2500 miles) or once a year	after 20000 km (12500 miles)
-------------------	---------------	--	-------------------------------------	---	------------------------------

Check oil level in oil tank	●		●	●	●	
Check gear oil level	●		●	●	●	
Change gear oil			●			●
Check exhaust control function				●	●	
Check spark plug, replace it if necessary, adjust electrode distance				●	●	
Check intake manifold for leaks and cracks					●	
Drain and clean carburetor float chamber		●		●	●	
Check idle setting and emission values when engine is warm			●	●	●	
Check vent hoses of oil tank and transmission for kink-free installation			●	●	●	
Clean air filter and air filter box, check carburetor connection boot		●		●	●	
Check sprockets, chain guides and chain	●		●	●	●	
Clean and lubricate chain	●			●	●	
Check chain tension	●		●	●	●	
Check cooling liquid level	●		●	●	●	
Check quality of antifreezer				●	●	
Check cooling system for leaks - visual checking	●		●	●	●	
Change cooling liquid						●
Check exhaust system for leakage			●	●	●	
Check silent blocks of exhaust brackets				●	●	
Check brake fluid level in reservoirs	●		●	●	●	
Change brake fluid						●
Check brake pad thickness	●			●	●	
Check brake discs				●	●	
Check condition and correct installation of brake hoses	●		●	●	●	
Check freeplay and easy operation of hand brake lever and foot brake pedal	●		●	●	●	
Check telescopic fork for function and tightness	●		●	●	●	
Service telescopic fork completely						●
Check steering head bearing clearance			●	●	●	
Clean and grease steering head bearings and it sealing elements						●
Check shock absorber for function and tightness	●		●	●	●	
Disassemble the Pro Lever suspension system linking and lubricate						●
Servicing swingarm pivots						●
Check spoke tension and rim join	●		●	●	●	
Check wheel bearings for clearance	●			●	●	
Check tire condition and air pressure	●		●	●	●	
Check cables for damage and smooth operation	●			●	●	
Oil and adjust cables		●		●	●	
Check the electrical system	●		●	●	●	
Check battery rack and connections				●	●	
Check adjustment of head light				●	●	
Spray ignition lock, emergency OFF switch and light switch with contact spray		●		●	●	
Oil center stand or side stand and check function		●	●	●	●	
Check all screws, nuts and hose clamps for tight fit	●		●	●	●	
Grease or oil all pivot points and sliding components		●	●	●	●	

MAINTENANCE WORK ON CHASSIS AND ENGINE



WARNING



ALL MAINTENANCE AND ADJUSTMENT OPERATIONS THAT ARE MARKED WITH A * REQUIRE SPECIALIST KNOWLEDGE. FOR YOUR OWN SAFETY, LET THESE TASKS BE CARRIED OUT BY A KTM-DEALER !



CAUTION



- WHEN CLEANING THE MOTORCYCLE, DO NOT USE A HIGH PRESSURE CLEANING UNIT IF POSSIBLE, OTHERWISE WATER WILL PENETRATE THE BEARINGS, CARBURETOR, ELECTRIC CONNECTORS ETC.
- LET YOUR MOTORCYCLE COOL DOWN BEFORE BEGINNING ANY MAINTENANCE WORK IN ORDER TO AVOID GETTING BURNED.
- DISPOSE OF OIL, GREASE, FILTERS, FUELS, CLEANING AGENTS ETC. ACCORDING TO YOUR LOCAL REGULATIONS.
- UNDER NO CIRCUMSTANCES MAY USED OIL BE DISPOSED OF IN THE SEWAGE SYSTEM OR IN THE OPEN COUNTRYSIDE. 1 LITER USED OIL CONTAMINATES 1.000.000 LITERS WATER.

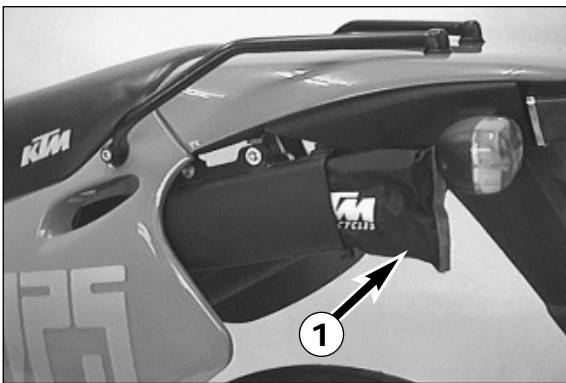

Tool kit

The tool kit ❶ is located in the tool box under the left side cover.

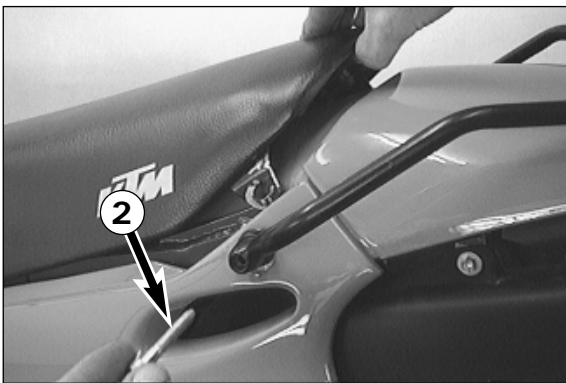

Dismounting and mounting of seat

Remove left and right screws ❷. Lift rear portion of seat, pull it backwards, and disengage it at the oval head screw ❸.

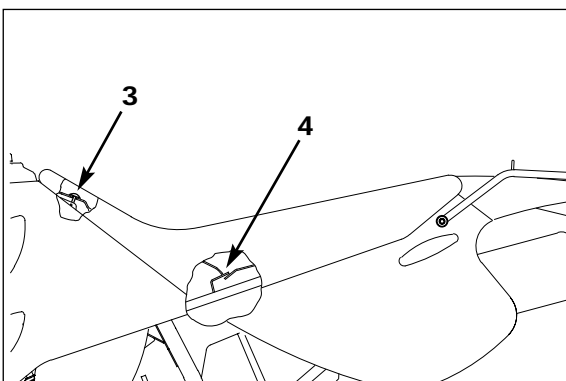

Mounting the seat:

- Hook the seat onto the oval head screw ❸.
- Slide it forward to let the retaining plate ❹ engage in the seat.
- Slide retaining shackles of seat under the side covers and mount screws

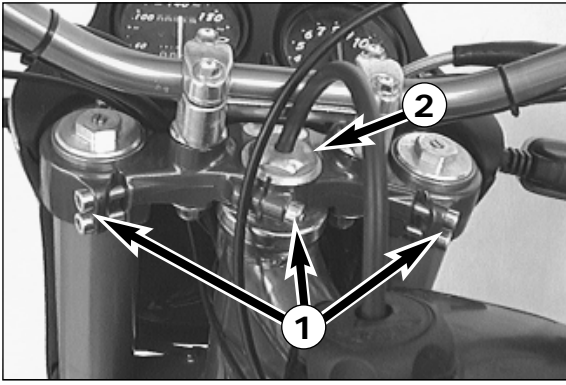

Check and adjust steering head bearing*

Check steering head bearing for play periodically. To check this support the motorcycle so that the front wheel is off the ground. Now try to move the fork forward and backward - no play should be discernable. For readjustment, release the 5 clamp screws **1** of the top triple clamp and turn the top screw **2** with the wrench from the tool set until no play is left at all. Don't tighten the steering stem bolt all the way, otherwise the bearings will be damaged. With a plastic hammer, lightly rap on the top triple clamp to release tension. Re-tight the five clamp screws to 15 Nm (11 ft.lb).

⚠ WARNING ⚠

IF THE STEERING HEAD BEARING IS NOT ADJUSTED TO BE FREE OF PLAY, THE MOTORCYCLE WILL SHOW AN UNSTEADY DRIVING PERFORMANCE AND CAN GET OUT OF CONTROL.

! CAUTION !

IF YOU DRIVE WITH PLAY IN THE STEERING HEAD BEARING FOR LONGER PERIODS, FIRSTLY THE BEARINGS AND THEN THE BEARING SEATS IN THE FRAME WILL BE DESTROYED.

The steering head bearings should be regreased after 2 years at the latest.

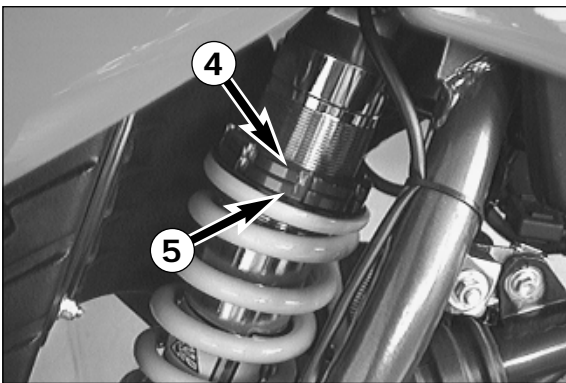
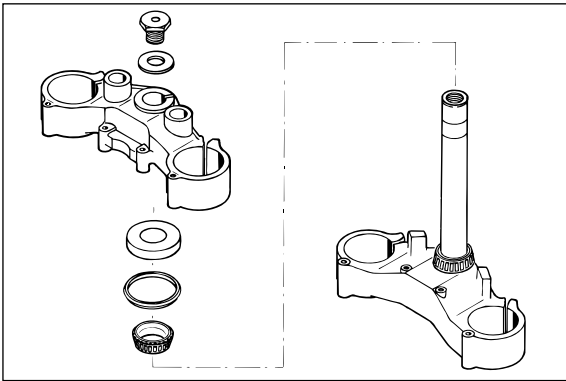

Changing the spring preload of the shock absorber

KTM sets the shock absorber for driver only, weighing approximately 75 kg (165 lb). If you want to take a passenger with you, or if you weigh considerably more or less than 75 kg (165 lb), you should change the spring preload accordingly. This is easily done.

NOTE:

- Before changing the spring preload note down the basic setting, e.g. how many coils are visible above the adjusting ring.
- One rotation of the adjusting ring **5** changes the spring preload by approximately 1.5 mm.

Use the hook wrenches included in the vehicle tool kit to loosen the counter ring **4**. Change spring preload as desired by means of the adjusting ring **5**, and retighten counter ring.

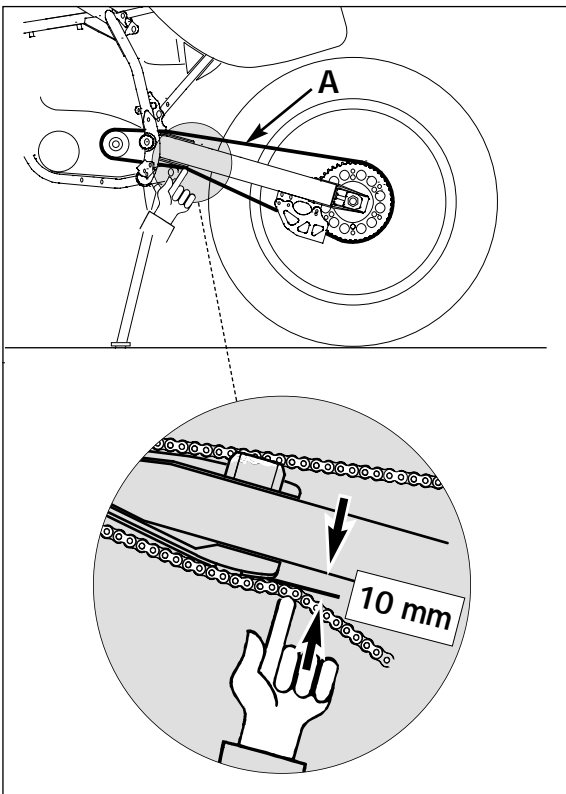

Check chain tension

- To check the chain tension, turn off the motorcycle.
- Press chain upward at the end of the chain sliding component. The distance between chain and swing arm should be approx. 10 mm. In the course of this procedure, the upper chain portion **A** must be tensioned (see drawing).
- If necessary, readjust chain tension.

⚠ WARNING ⚠

IF CHAIN TENSION IS TOO GREAT, PARTS WITHIN THE SECONDARY POWER TRANSMISSION (CHAIN, CHAIN SPROCKETS, TRANSMISSION AND REAR WHEEL BEARINGS) WILL BE SUBJECTED TO UNNECESSARY STRESS, RESULTING IN PREMATURE WEAR AND EVEN CHAIN BREAKAGE.

TOO MUCH SLACK IN THE CHAIN, ON THE OTHER HAND, CAN RESULT IN THE CHAIN JUMPING OFF THE CHAIN WHEELS. IF THIS HAPPENS, THE CHAIN COULD ALSO BLOCK THE REAR WHEEL OR DAMAGE THE ENGINE.

IN EITHER CASE THE OPERATOR IS LIKELY TO LOSE CONTROL OF THE MOTORCYCLE.

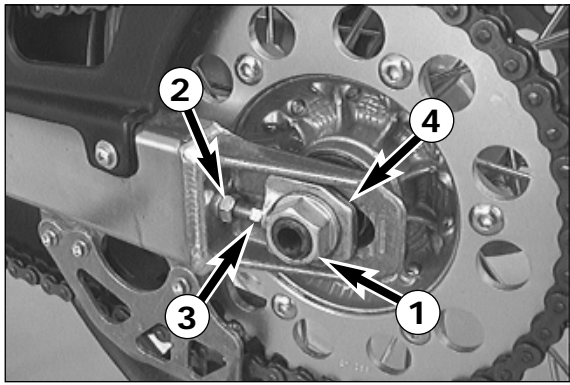

Readjust chain tension

- Loosen collar nut ❶, loosen counter nuts ❷, and turn right and left adjusting screws ❸ equally far. Tighten counter nuts ❷.
- Before tightening the collar nut, verify that the chain tensioners ❹ are sitting close to the adjusting screws and that the rear wheel has been aligned with the front wheel.
- Tighten collar nut ❶ with 80 Nm (59 ft.lb).

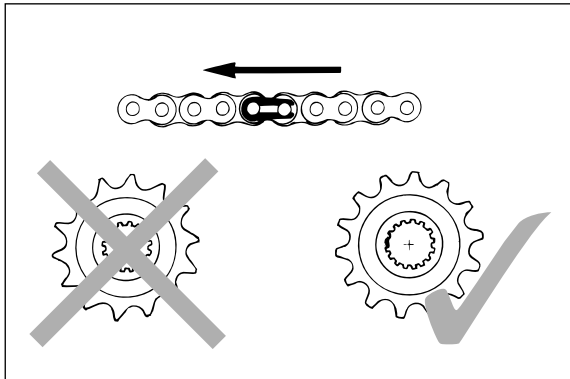

Chain maintenance

O-ring chains require only modest maintenance. The best way is to use lots of water, but never use brushes or solvents. After letting the chain dry, you can use a special O-ring chain spray (Shell Advance Bio Chain).

⚠ **WARNING** ⚠

NO LUBRICATION IS ALLOWED TO REACH THE REAR TIRE OR THE BRAKE DISKS, EITHER-WISE THE ROAD ADHERENCE AND THE REAR WHEEL BRAKING EFFECTS WOULD BE STRONGLY REDUCED AND THE MOTORCYCLE COULD EASILY GET OUT OF CONTROL.

! **CAUTION** !

WHEN MOUNTING THE CHAIN JOINT, THE CLOSED SIDE OF THE SAFETY DEVICE MUST POINT IN RUNNING DIRECTION.

Also check sprockets and chain guides for wear, and replace if necessary.

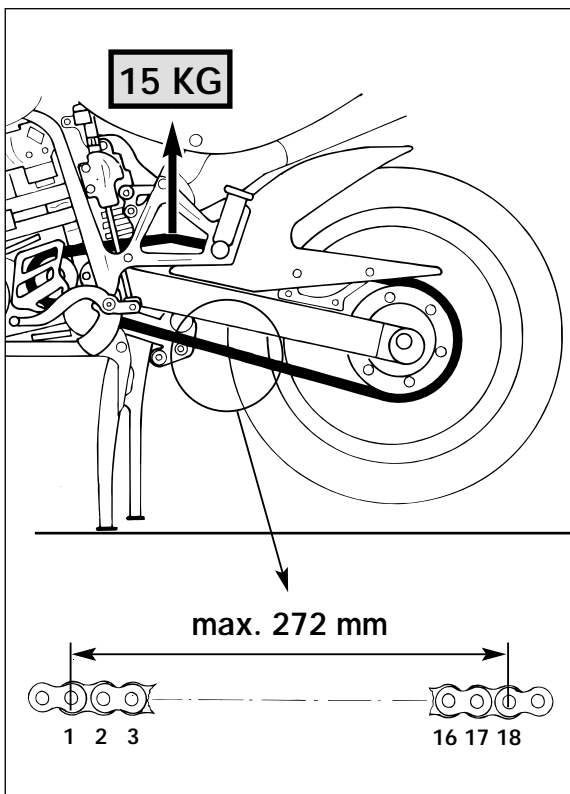

Chain wear

In order to check the chain wear, regard the following instructions: Shift the gear into idling and pull the upper chain strand with approx. 10-15 kilogramm (33 lb) upwards (see figure). Now one can measure a space of 18 chain reels at the lower chain strand. The chain should be replaced at the latest when a space of 272 mm (10,70 in) is measured. Chains do not always wear off evenly, therefore repeat the measurement at different places on the chain.

NOTE:

If you mount a new chain, the sprockets should also be replaced. New chains wear faster if used on old used sprockets.

General informations about KTM disc brakes

BRAKE CALIPERS:

The front wheel brake system has a disc measuring 320 mm in diameter and a four-piston brake caliper which is mounted rigidly on the fork. The rear wheel brake system consists of a 220 mm diameter disc and a "float-mounted" one-piston brake caliper.

BRAKE FLUID RESERVOIRS:

The brake fluid reservoirs on the front and rear wheel brakes have been designed in such a way that even if the brake pads are worn it is not necessary to top up the brake fluid. If the brake fluid level drops below the minimum either the brake system has a leak or the brake pads are completely worn down.

In this case, consult an authorized KTM dealer immediately.

BRAKE FLUID:

KTM fills the brake systems with Shell Advance Brake DOT 5.1 brake fluid, one of the best brake fluids that is currently available. We recommend that you continue to use it. DOT 5.1 brake fluid is based on glycol ether and of an amber color. If you do not have any DOT 5.1 for refilling, you may use DOT 4 brake fluid. However, you should replace it as soon as possible by DOT 5.1.

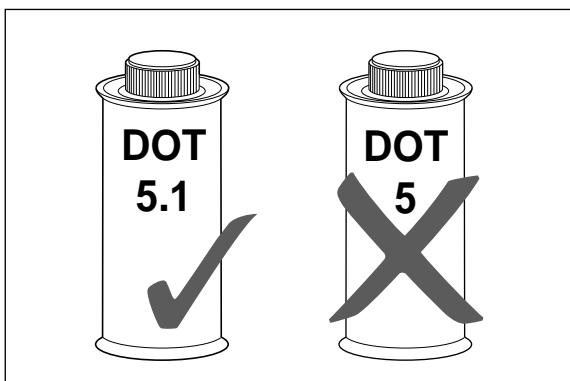

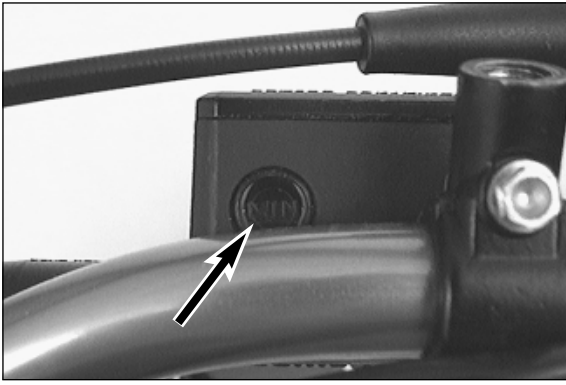

Checking of brake fluid level - front brake

The brake fluid reservoir is linked with the hand brake cylinder at the handlebar and the reservoir is provided with an inspection glass. With the reservoir in a horizontal position, the brake fluid level should not go below middle of the glass.



WARNING



IF THE BRAKE FLUID LEVEL DROPS BELOW THE MINIMUM EITHER THE BRAKE SYSTEM HAS A LEAK OR THE BRAKE PADS ARE COMPLETELY WORN DOWN. IN THIS CASE, CONSULT AN AUTHORIZED KTM DEALER IMMEDIATELY.

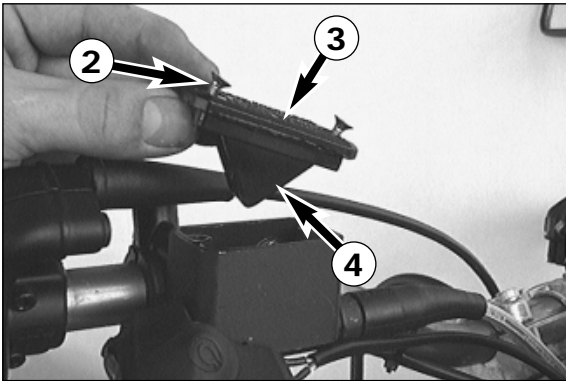

Refilling the front brake reservoir*

Loosen screws ② and remove lid ③ and membrane ④.

Place hand brake cylinder in a horizontal position and fill the brake fluid reservoir to 5 mm (0,2 in) below the rim with brake fluid DOT 5.1 (Shell Advance Brake DOT 5.1). Replace membrane and lid, tighten screws. Rinse off spilled or overflowing brake fluid with water.



WARNING



- NEVER USE DOT 5 BRAKE FLUID! IT IS BASED ON SILICONE OIL AND OF A PURPLE COLOR. SEALS AND BRAKE HOSES MUST BE ESPECIALLY ADAPTED TO IT.
- STORE BRAKE FLUID OUT OF REACH OF CHILDREN.
- BRAKE FLUID CAN CAUSE SKIN IRRITATION. AVOID CONTACT WITH SKIN AND EYES. IF YOU GET BRAKE FLUID IN YOUR EYES, RINSE WITH PLENTY OF WATER AND CONSULT A DOCTOR.



CAUTION



- DON'T LET BRAKE FLUID GET IN CONTACT WITH PAINT, IT IS AN EFFECTIVE PAINT REMOVER.
- USE ONLY CLEAN BRAKE FLUID TAKEN FROM A TIGHTLY SEALED CONTAINER.

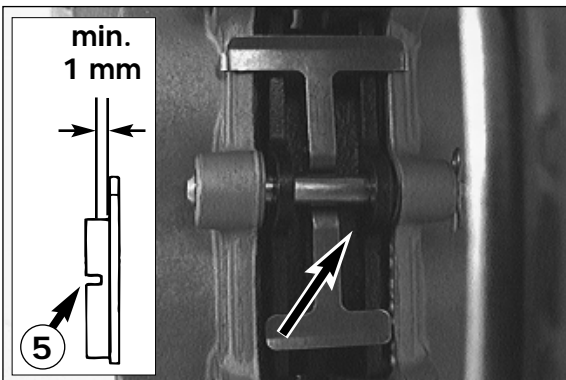
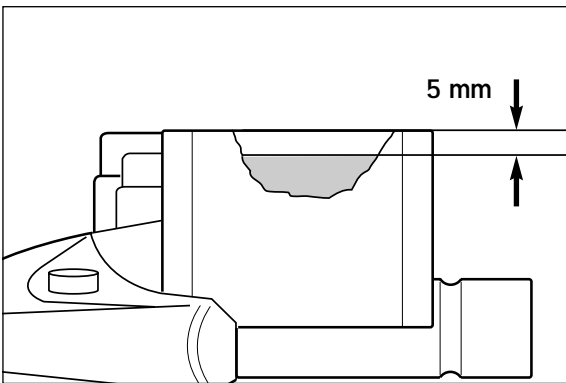

Checking the front brake pads

The brake pads can be inspected from behind. Always inspect the brake pad linings before taking off on your motorcycle. They should not be thinner than 1 mm which is the case when the notch ⑤ is no longer discernable.



WARNING



AT THEIR MOST WORN POINT BRAKE PAD LININGS SHOULD NOT BE THINNER THAN 1 MM, OTHERWISE THEY COULD LEAD TO BRAKE FAILURE. FOR YOUR OWN SAFETY DON'T PUT OFF HAVING YOUR BRAKE PADS CHANGED.



CAUTION



IF THE BRAKE PADS ARE REPLACED TOO LATE SO THAT THE LINING IS PARTLY OR ENTIRELY WORN AWAY, THE STEEL COMPONENTS OF THE BRAKE PAD WILL RUB AGAINST THE BRAKE DISC, SIGNIFICANTLY IMPAIRING THE BRAKING EFFECT AND DESTROYING THE BRAKE DISC.

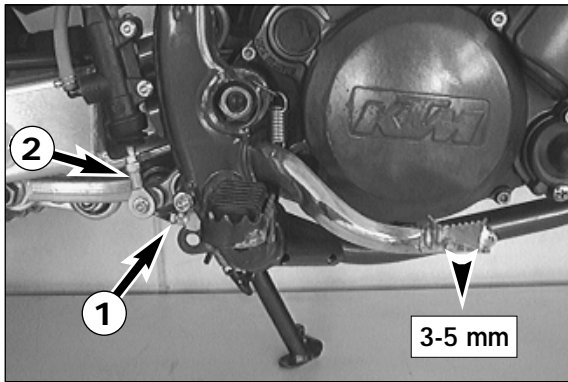

Changing the basic position of the foot brake pedal*

The basic position of the foot brake pedal can be altered by turning the stop screw ①. The free play at the foot brake pedal must then be adjusted by means of the push rod ②.

Measured on the outside, the foot brake pedal must have 3-5 mm (0,12-0,20 in) of free play, before the push rod can move the piston in the brake cylinder (to be recognised from the resistance on the foot brake pedal).

! CAUTION !

IF THIS FREE PLAY IS NOT PRESENT, THEN PRESSURE CAN BUILD UP IN THE BRAKE SYSTEM WHEN DRIVING, CAUSING CONSTANT FRICTION OF THE BRAKE PADS. THE BRAKING SYSTEM OVERHEATS AND CAN FAIL COMPLETELY IN EXTREME CASES.

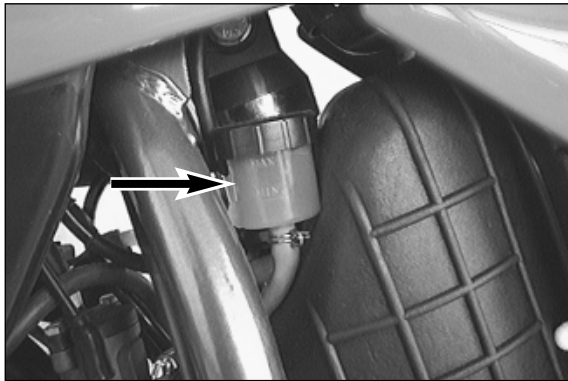

Checking rear brake fluid level

The reservoir for the rear disc brake is located on the left-hand side of the vehicle next to the carburetor connecting boot. The brake fluid level may not drop below the „MIN“ marking when the vehicle is in an upright position.

⚠ WARNING ⚠

IF THE BRAKE FLUID LEVEL DROPS BELOW THE MINIMUM EITHER THE BRAKE SYSTEM HAS A LEAK OR THE BRAKE PADS ARE COMPLETELY WORN DOWN. IN THIS CASE, CONSULT AN AUTHORIZED KTM DEALER IMMEDIATELY.



Refilling the rear brake reservoir*

When the brake fluid level has dropped to the MIN mark, you need to refill the brake fluid reservoir. This is done by first unscrewing the cap ③ and rubber boot ④. Add brake fluid DOT 5.1 (Shell Advance Brake DOT 5.1) until it reaches the MAX mark, then screw rubber boot and cap back on. Rinse off spilled or overflowing brake fluid with water.

⚠ WARNING ⚠

- NEVER USE DOT 5 BRAKE FLUID! IT IS BASED ON SILICONE OIL AND OF A PURPLE COLOR. SEALS AND BRAKE HOSES MUST BE ESPECIALLY ADAPTED TO IT.
- STORE BRAKE FLUID OUT OF REACH OF CHILDREN.
- BRAKE FLUID CAN CAUSE SKIN IRRITATION. AVOID CONTACT WITH SKIN AND EYES. IF YOU GET BRAKE FLUID IN YOUR EYES, RINSE WITH PLENTY OF WATER AND CONSULT A DOCTOR

! CAUTION !

- DON'T LET BRAKE FLUID GET IN CONTACT WITH PAINT, IT IS AN EFFECTIVE PAINT REMOVER.
- USE ONLY CLEAN BRAKE FLUID TAKEN FROM A TIGHTLY SEALED CONTAINER.

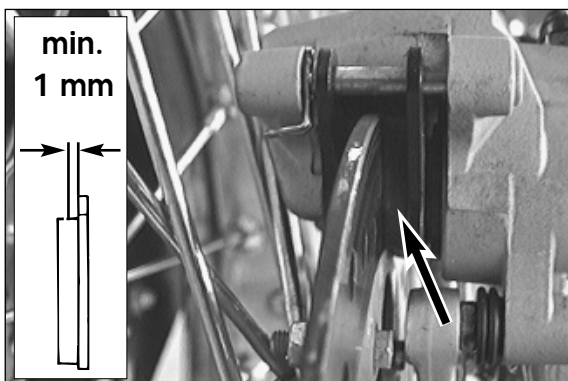
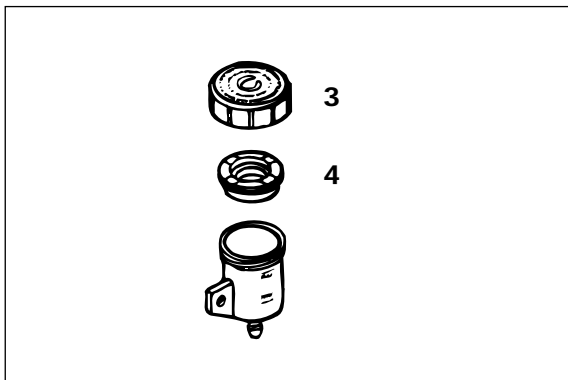

Checking the rear brake pads

The brake pads can be inspected from the rear. The thickness of the linings may not be less than 1 mm (0.04 in).

⚠ WARNING ⚠

AT THEIR MOST WORN POINT BRAKE PAD LININGS SHOULD NOT BE THINNER THAN 1 MM, OTHERWISE THEY COULD LEAD TO BRAKE FAILURE. FOR YOUR OWN SAFETY DON'T PUT OFF HAVING YOUR BRAKE PADS CHANGED.

! CAUTION !

IF THE BRAKE PADS ARE REPLACED TOO LATE SO THAT THE LINING IS PARTLY OR ENTIRELY WORN AWAY, THE STEEL COMPONENTS OF THE BRAKE PAD WILL RUB AGAINST THE BRAKE DISC, IMPAIRING THE BRAKING EFFECT AND DESTROYING THE BRAKE DISC.

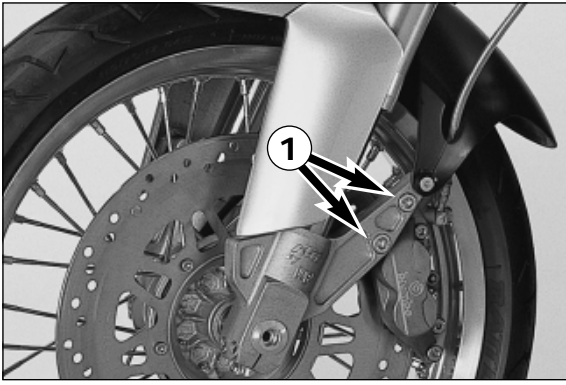

Dismounting and mounting the front wheel*

- To remove the front wheel, jack the motorcycle up by the frame so that the front wheel no longer touches the ground.
- Take out both allen head screws **1** and remove brake caliper from brake disc.

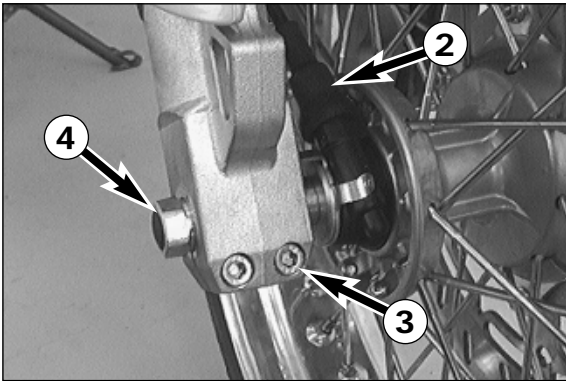

- Screw speedometer cable **2** from speedometer drive
- Loosen the clamp screws **3** on the right fork leg axle passage (leave the clamp screws on the left fork fist tightened).
- Loosen wheel spindle **4**.
- Hold the front wheel, pull the wheel spindle out, remove the front wheel from the fork by pulling it forward.

! **CAUTION** **!**

DO NOT OPERATE THE HAND BRAKE WHEN THE FRONT WHEEL HAS BEEN REMOVED.

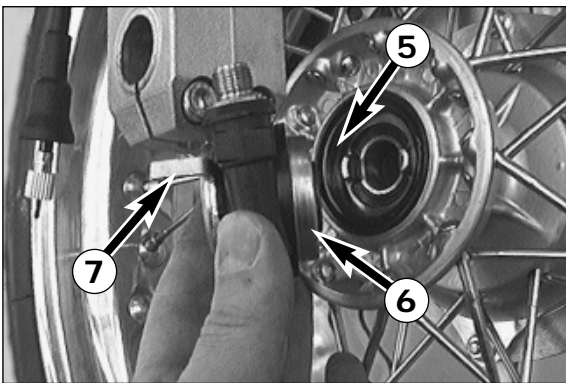

- Prior to mounting the front wheel, clean and grease the shaft seal ring **5** and running surface **6** at the speedometer drive.
- To mount the front wheel insert speedometer drive into the hub.
- Raise the front wheel into the fork, insert the tongue **7** of the retaining bracket into the slot of the right fork leg axle passage.
- Replace the wheel spindle and tighten it with 40 Nm (30 ft.lb).
- Put the brake caliper back in place and tighten the allen head screw with 40 Nm (30 ft.lb)
- Attach speedometer drive cable and replace dust cap.
- Jack the motorcycle back down, work the front brake and bounce the fork hard a few times to align the fork tubes.
- Now you can tighten the clamp screws on the right fork leg axle passage to 7 Nm (5 ft.lb).

⚠ **WARNING** **⚠**

- IF YOU DON'T HAPPEN TO HAVE A TORQUE WRENCH AT HAND, MAKE SURE YOU HAVE THE TIGHTENING TORQUE CORRECTED BY A KTM DEALER AS SOON AS POSSIBLE.
- IT IS VERY IMPORTANT TO KEEP THE BRAKE DISK FREE FROM OIL AND GREASE, OTHERWISE THE BRAKING EFFECTS WOULD BE STRONGLY REDUCED.

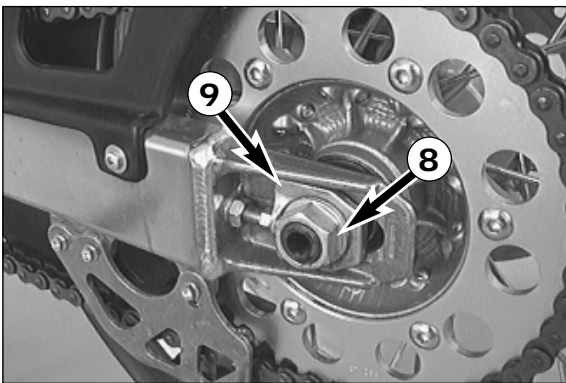

Dismounting and mounting the rear wheel*

Jack the motorcycle up by the frame so that the rear wheel no longer touches the ground. Loosen the collar nut **8**, remove chain tensioner **9**, hold the rear wheel pull out the wheel spindle **10** until the rear wheel is free but the brake caliper support is still held. Push the rear wheel as far forward as possible, take the chain from the chain sprocket and carefully take the rear wheel out of the swing arm.

! **CAUTION** **!**

- DO NOT OPERATE THE FOOT BRAKE WHEN THE REAR WHEEL HAS BEEN DISMOUNTED.
- WHEN THE WHEEL SPINDLE IS DISMOUNTED, CLEAN THE THREADS OF THE WHEEL SPINDLE AND COLLAR NUT THOROUGHLY AND APPLY A NEW COAT OF GREASE TO PREVENT THE THREAD FROM JAMMING.

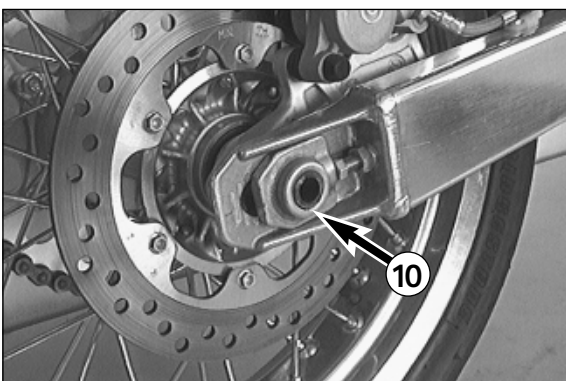

The rear wheel is remounted in reverse order. Before tightening the collar nut with 80 Nm (59 ft.lb), push the rear wheel forwards so that the chain tensioners lie on the tension screws.

⚠ **WARNING** **⚠**

- IF YOU DON'T HAPPEN TO HAVE A TORQUE WRENCH AT HAND, MAKE SURE YOU HAVE THE TIGHTENING TORQUE CORRECTED BY A KTM DEALER AS SOON AS POSSIBLE. A LOOSE WHEEL SPINDLE MAY LEAD TO AN UNSTABLE DRIVING BEHAVIOR OF YOUR MOTORCYCLE.
- AFTER MOUNTING THE REAR WHEEL, KEEP OPERATING THE FOOTBRAKE UNTIL THE PRESSURE POINT RETURNS.
- IT IS VERY IMPORTANT TO KEEP THE BRAKE DISK FREE FROM OIL AND GREASE, OTHERWISE THE BRAKING EFFECT WOULD BE STRONGLY REDUCED.

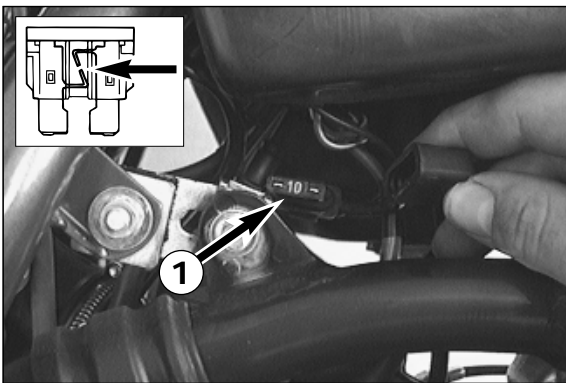
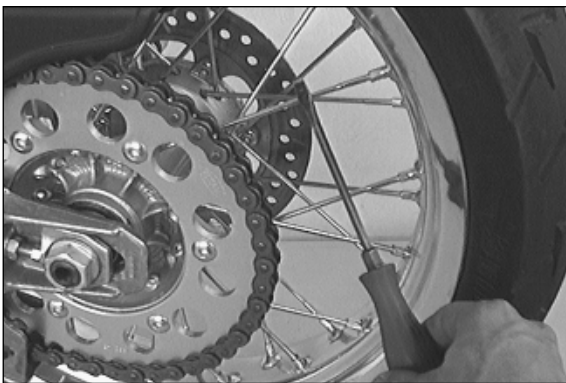
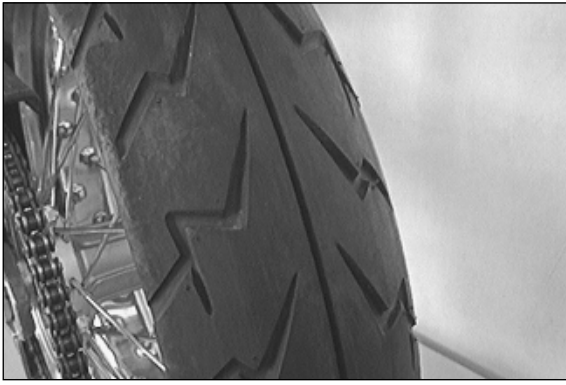

Tires, air pressure

Tire type, tire condition, and how much air pressure the tires have in them affect the way your motorcycle rides, and they must therefore be checked whenever you're getting ready to go anywhere on your motorcycle.

- Tire type and size can be found in the technical specifications and in the homologation certificate
- Tire condition has to be checked every time you want to ride your motorcycle. Before leaving check for punctures and nails or other sharp objects that might have become embedded in the tire. Refer to the specific regulations in your country for minimum tire tread requirements. We recommend replacing tires at the latest when the tread is down to 2 mm.
- Tire pressure should be checked regularly on a "cold" tire. Proper pressure ensures optimum driving comfort and extends the life of your tires.

⚠ **WARNING** ⚠

- DO NOT MOUNT TIRES WHICH HAVE NOT BEEN APPROVED BY KTM. OTHER TIRES COULD HAVE ADVERSE EFFECTS ON THE WAY YOUR MOTORCYCLE RIDES.
- THE FRONT AND REAR WHEEL ARE ONLY ALLOWED TO BE TIED WITH TIRES THAT HAVE THE SAME PROFILE TYPE.
- FOR YOUR OWN SAFETY REPLACE DAMAGED TIRES IMMEDIATELY.
- WORN TIRES CAN HAVE A NEGATIVE EFFECT ON HOW YOUR MOTORCYCLE PERFORMS, ESPECIALLY ON WET SURFACES
- IF AIR PRESSURE IS TOO LOW, ABNORMAL WEAR AND OVERHEATING OF THE TIRE CAN RESULT

	front tyre air pressure	rear tyre air pressure
driver only	1.8 bar (26 psi)	2.1 bar (31 psi)
driver plus passenger	2.0 bar (29 psi)	2.3 bar (34 psi)

Checking spoke tension

The correct spoke tension is very important for the stability of the wheels and thus for riding safety. A loose spoke causes the wheel to become unbalanced and before long other spokes will have come loose. Check spoke tension, especially on a new motorcycle, in regular intervals. For checking, tap on each spoke with the blade of a screw driver (see illustration). A clear tone must be the result. Dull tones indicate loose spokes. If necessary, have the spokes retightened and the wheel centered by a KTM dealer.

Main fuse

The main fuse ❶, which is located above the carburetor, protects the following current consumers:

- Electric starter system
- Parking light
- Flasher lights
- Horn
- Oil level warning lamp
- NEUTRAL lamp

Rated fuse current is 10 amperes

! **CAUTION** !

UNDER NO CIRCUMSTANCES IS A STRONGER FUSE ALLOWED TO BE SET IN OR A FUSE ALLOWED TO BE "REPAIRED". AN INEXPERT TREATMENT COULD DAMAGE THE WHOLE ELECTRICAL INSTALLATION!

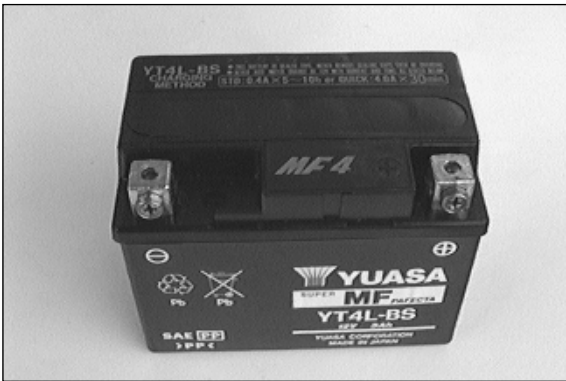
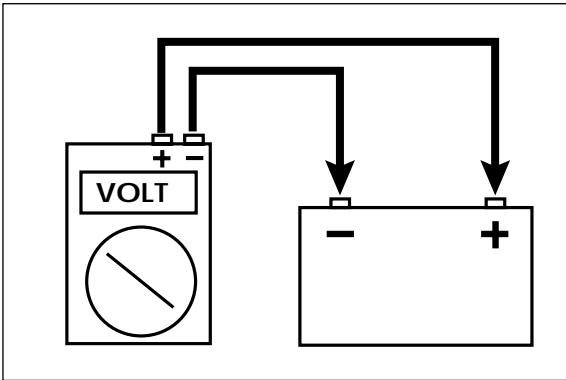
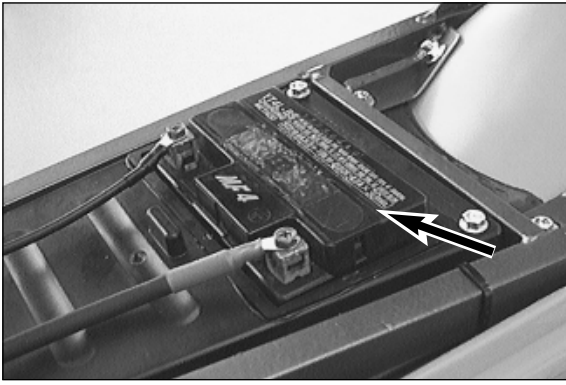

Battery

The battery is mounted under the seat (remove the seat, see page 13)
 The battery has a closed system and therefore requires no maintenance. It is not necessary to check the electrolyte level or to refill water. Simply keep the battery poles clean and slightly grease them with an acid-free grease if necessary.
 When removing the battery turn off all power consumers and then disconnect the negative pole first. When reinstalling the battery the negative pole is connected last.

⚠ WARNING ⚠

- IF ELECTROLYTE (SULPHURIC ACID) LEAKS FROM THE BATTERY, PROCEED WITH GREAT CARE. THE ELECTROLYTE CAN CAUSE SEVERE BURNS.
- IN THE CASE OF SKIN CONTACT RINSE THOROUGHLY WITH WATER.
- IN THE CASE OF CONTACT WITH THE EYES, THOROUGHLY RINSE EYES WITH WATER FOR AT LEAST 15 MINUTES. IMMEDIATELY CONSULT A DOCTOR!
- THE BATTERY IS A CLOSED MODEL BUT CAN NEVERTHELESS EMIT EXPLOSIVE GASES. AVOID SPARKS AND OPEN FIRE NEAR THE BATTERY.
- DEFECT BATTERIES MUST BE STORED OUT OF THE REACH OF CHILDREN. ENSURE PROPER DISPOSAL OF DISCARDED BATTERIES.

! CAUTION !

- DO NOT REMOVE THE SEALING STRIP **6**. THE SEALING STRIP WILL BE DAMAGED IF REMOVED.
- NEVER DISCONNECT THE BATTERY WHILE THE ENGINE IS RUNNING. THIS WILL DESTROY THE RECTIFIER-REGULATOR.

BATTERY STORAGE:

When preparing the motorcycle for a longer period of standstill, remove the battery and recharge it. Storage temperature: 0 - 35° C. Do not expose to direct sun radiation.

Charging the battery

Remove the battery and check the charging level. Use a voltmeter to measure the voltage between the battery poles (off-load voltage). Accurate results can only be obtained if the battery has neither been charged nor discharged during a period of 30 minutes preceding the measuring.

off load voltage Volt	charging level %	charging time 0,3 A	charging voltage
>12.7	100	—	max. 14.4 V
~12.5	75	4 h	
~12.2	50	7 h	
~12.0	25	11 h	
~11.8	0	14 h	

If the battery is empty, it can be recharged for a maximum period of 10 hours at 0.3 A and a maximum of 14.4 V.

! CAUTION !

- DO NOT REMOVE THE SEALING STRIP.
- ALWAYS CONNECT THE BATTERY TO THE CHARGING UNIT BEFORE TURNING THE CHARGING UNIT ON.
- WHEN RECHARGING THE BATTERY IN CLOSED ROOMS ENSURE SUFFICIENT VENTILATION. EXPLOSIVE GASES ARE RELEASED DURING THE BATTERY CHARGING PROCESS.
- CHARGING TIME AND CHARGING VOLTAGE SHOULD NOT EXCEED THE STATED VALUES. OTHERWISE ELECTROLYTE WILL BE RELEASED THROUGH THE SAFETY VALVES.
- AVOID QUICK CHARGING IF POSSIBLE.

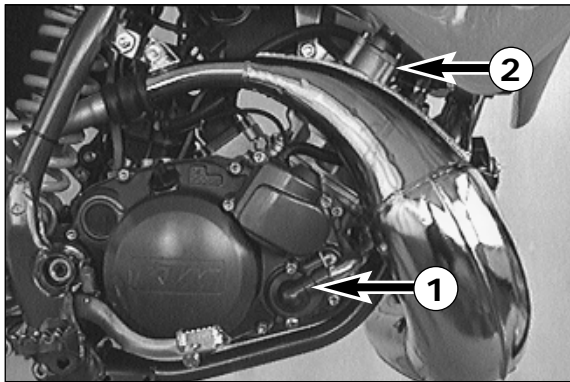

Cooling system

The cooling liquid is circulated by the water pump ① in the engine. When the engine is cold the cooling liquid circulates only through the cylinder and the cylinder head. After the engine has reached its operating temperature (approx. 65° C), the thermostat ② opens and cooling liquid is pumped also through the aluminum radiator.

Air blowing in through the radiators cools the cooling liquid. The slower the speed of the motorcycle, the less the cooling liquid is cooled down. Dirty radiator ribs also reduce the cooling efficiency.

If due to slow traffic in cities or waiting at a traffic light, for example, little or no relative wind is blowing through the radiators, it may happen that the cooling water temperature rises and the red cooling liquid temperature warning lamp ③ lights up (appr. 110° C, 238° F). In this case, you should try to drive on briskly, if possible, for generally the lamp will stop being lit soon if enough relative wind gets into the radiators. However, you should check the cooling liquid level later on after the engine has cooled down again.

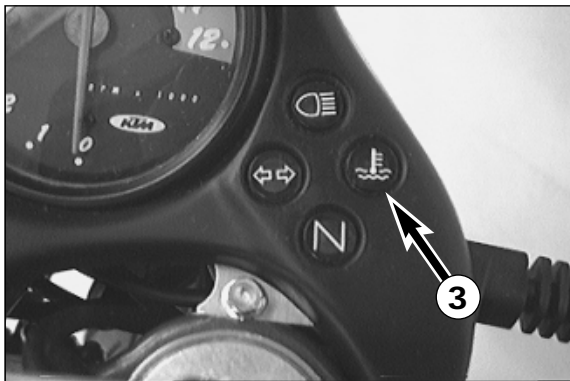

! CAUTION !

HOWEVER, IF THE RED COOLING-LIQUID TEMPERATURE WARNING LAMP LIGHTS UP WHILE YOU ARE DRIVING ALONG BRISKLY, THIS WILL INDICATE A DEFECT IN THE COOLING SYSTEM. IN THIS CASE, STOP IMMEDIATELY, SINCE OTHERWISE YOU MAY DAMAGE YOUR ENGINE. LET YOUR ENGINE COOL DOWN, CHECK THE COOLING SYSTEM FOR LEAKS, AND CHECK THE COOLING LIQUID LEVEL. **CAUTION - SCALDING HAZARD!** DO NOT DRIVE ON, UNTIL THERE IS SUFFICIENT LIQUID IN THE COOLING SYSTEM!

⚠ WARNING ⚠

IF THE RADIATOR CAP IS REMOVED WHEN THE ENGINE IS HOT, HOT COOLANT, THAT IS UNDER PRESSURE, CAN SPRAY OUT AND CAUSE SEVERE BURNS. ALLOW YOUR ENGINE TO COOL DOWN AND, IN THE MEANTIME, CHECK THE COOLING SYSTEM FOR LEAKS.

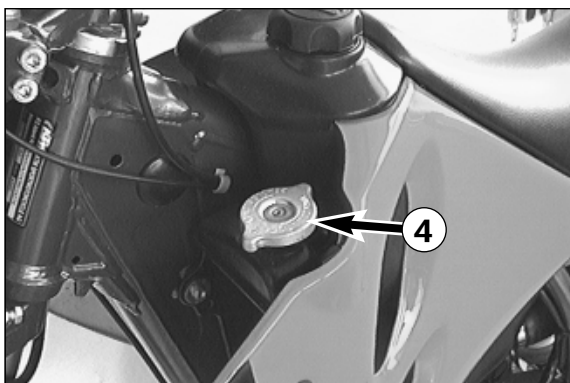

A mixture of 40% antifreezer liquid and 60% water is used as cooling liquid. However, the anti-freeze protection must be at least -25° C (-13° F). Aside from antifreezing protection, this mixture also provides great corrosion protection which is why it must not be replaced by pure water.

! CAUTION !

FOR THE COOLING SYSTEM, USE ONLY HIGH-GRADE ANTIFREEZER (SHELL ADVANCE COOLANT). USING LOWERGRADE ANTIFREEZE AGENTS, CAN CAUSE CORROSION AND COOLANT FOAMING.

Pressure induced by heating of the cooling liquid in the cooling system is controlled by a valve in the radiator cap ④; a water temperature rising up to 120° C (248° F) is admissible, without fear of problems.

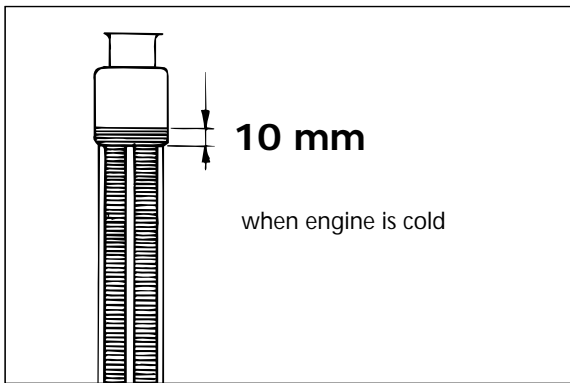

Checking the cooling liquid level

The cooling liquid should be 10 mm (0,4 in) above the cooling elements when the engine is cold (cf. diagram). In the event of the cooling liquid being drained, always fill the system before hand, then top off while the engine is running.

⚠ WARNING ⚠

IF POSSIBLE, ALWAYS CHECK LEVEL OF COOLING LIQUID WHEN ENGINE IS COLD. IF YOU HAVE TO OPEN THE RADIATOR CAP WHEN ENGINE IS HOT, USE A RAG TO COVER THE CAP AND OPEN SLOWLY TO RELEASE PRESSURE.

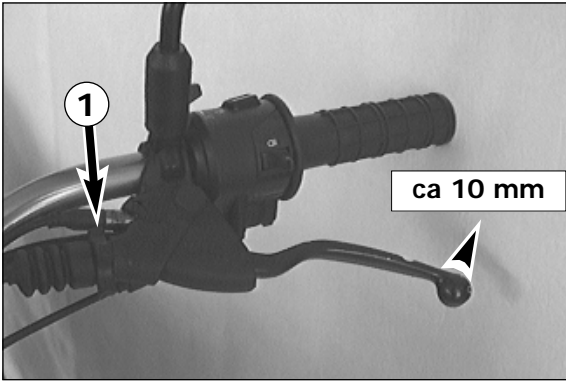

Adjusting the clutch cable

When the engine is cold, the play at the clutch lever should be 10 mm (0.4 in) (measured at the outer edge).

To adjust the clutch cable turn the adjusting nut **1** accordingly.

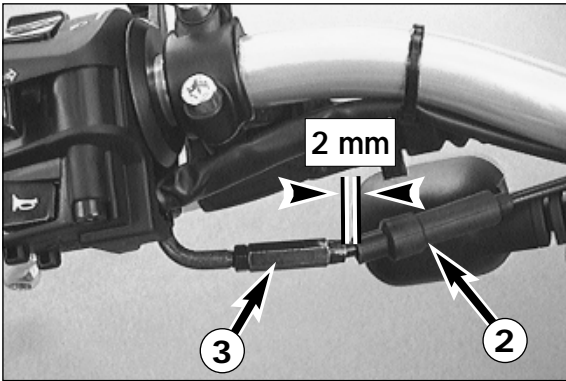

Adjusting the choke cable*

At the choke cable, there must always exist a play of approx. 2 mm (0.1 in). To check this, push choke lever fully forward and pull protective cover **2** from the adjuster piece **3**. Now, it must be possible to lift the outer covering of the cable by approx. 2 mm from the adjuster piece until feeling a resistance. If necessary, loosen counter nut and readjust play by turning the adjuster piece. Tighten counter nut, and slide on protective cover.

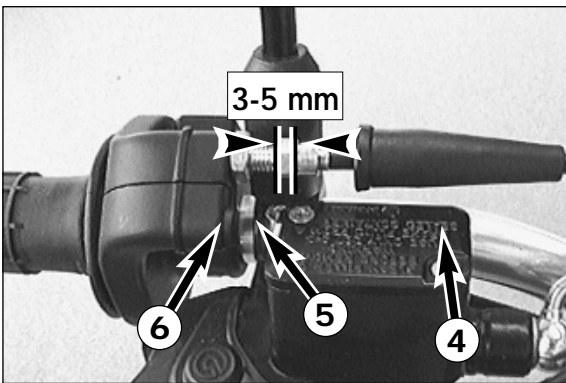

Adjusting the throttle cable*

There must always be a 3-5 mm (0.1-0.2 in) play in the throttle cable. To check this, move back the protective cover **4** on the throttle grip. You must be able to lift the outer covering of the cable 3-5 mm from the adjusting screw **5**, until resistance is felt.

To adjust, loosen the counter nut **6** and turn the adjusting screw accordingly. Finally tighten counter nut and slide the protective cover back on.

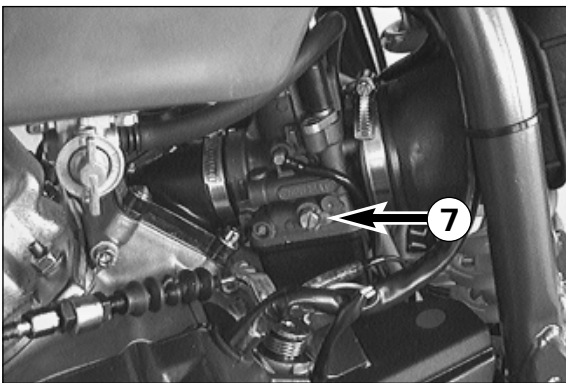

Adjusting the idle speed*

The idle speed can be adjusted with idle screw **7**.

Turning in clockwise direction will increase the idle speed.

Turning in counter-clockwise direction will reduce the idle speed.

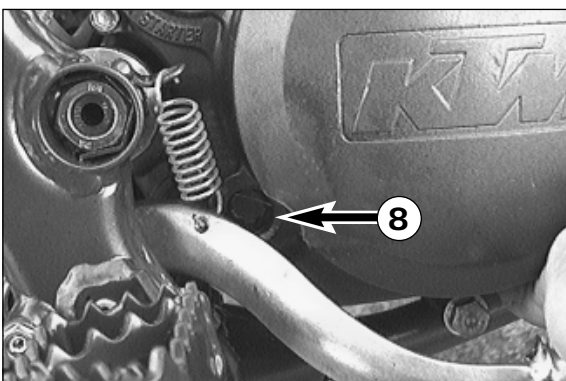

Checking the gear oil level

To make checking the gear oil level easy, an inspection glass **8** is disposed at the right side of the engine.

- Warm up engine, then turn it off and wait for 2 minutes so that the oil may flow back into the transmission case.
- Hold motorcycle in a straight position on a horizontal surface (do not put it on the side stand), and read the oil level.
- The oil level should be in the upper half of the inspection glass.

NOTE: placing the motorcycle in another than a fully upright position will falsify the measuring result.

- If necessary, fill in 10W30 engine oil (Shell Advance Ultra).

! CAUTION !

TOO LITTLE OIL OR A POOR OIL QUALITY WILL CAUSE PREMATURE WEAR OF TRANSMISSION AND CLUTCH. ONLY USE BRANDED OIL (SHELL ADVANCE ULTRA).

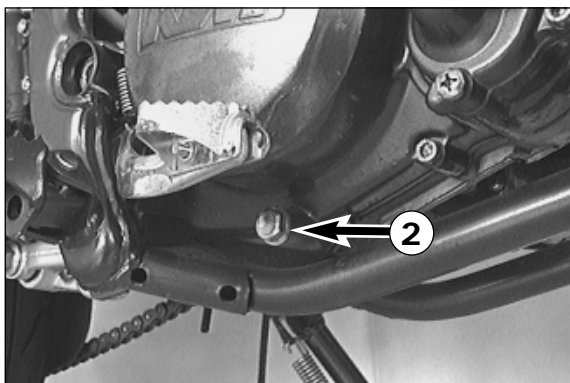

Changing gear oil*

- Warm up engine.
- Remove screw ②, and drain old oil into an appropriate container.
- Tilt your motorcycle to the right to ensure that the entire oil is discharged.
- Mount screw with gasket, and tighten it with 15 Nm (11 ft.lb).
- Unscrew closure cap ③, and fill in 0.75 liters of 10W30 engine oil (Shell Advance Ultra).
- Mount closure cap and check engine for possible oil loss.

! CAUTION !

TOO LITTLE OIL OR A POOR OIL QUALITY WILL CAUSE PREMATURE WEAR OF TRANSMISSION AND CLUTCH. ONLY USE BRANDED OIL (SHELL ADVANCE ULTRA).

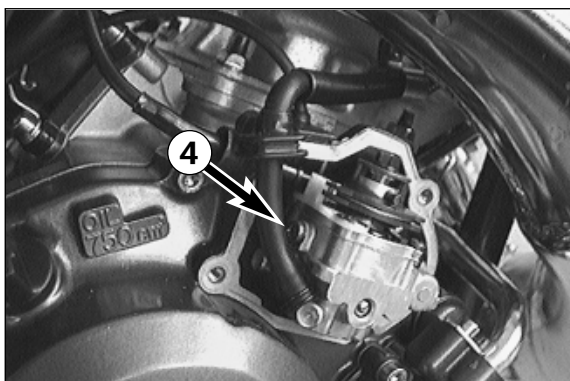
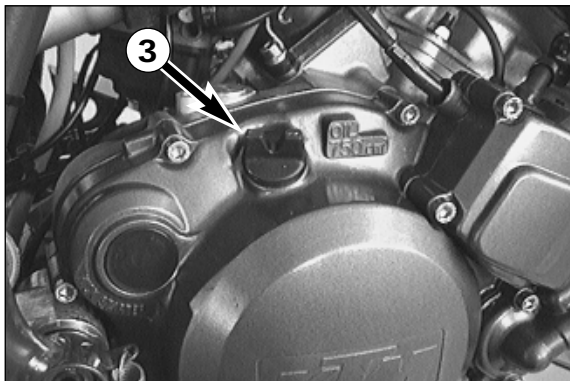

Bleeding the oil pump

OIL PUMP AND OIL LINES MUST BE BLED WHENEVER THE OIL TANK WAS COMPLETELY EMPTIED (SEE BLEEDING THE OIL PUMP). OTHERWISE THE OIL PUMP WILL NOT DELIVER OIL, THUS CAUSING ENGINE DAMAGE.

- Remove cover of oil pump.
- Remove bleeder screw ④. Do not close bleeder screw until oil without air bubbles is discharged.
- Disconnect oil line from oil pump to carburetor and fill it with oil.
- Reconnect oil line.
- Start the engine and set oil pump to maximum capacity by pulling the cable ⑤ out. Let engine run at 2.000 r.p.m. for approx. 2-3 minutes. This is the only way how to fully bleed the lubricating system.
- Stop the engine and mount oil-pump cover together with new gasket.

! CAUTION !

NEVER REV UP THE ENGINE DURING BLEEDING, BECAUSE THE OIL PUMP DOES NOT YET SUPPLY ENOUGH OIL TO ALL LUBRICATING POINTS.

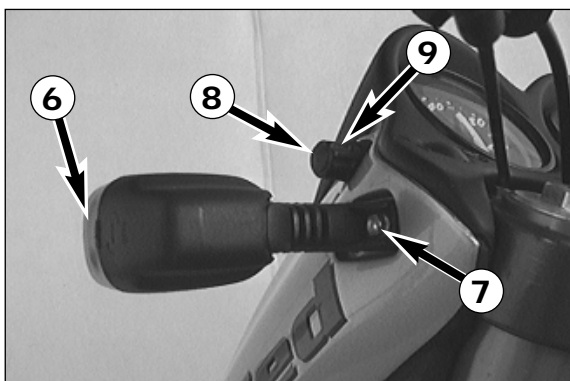
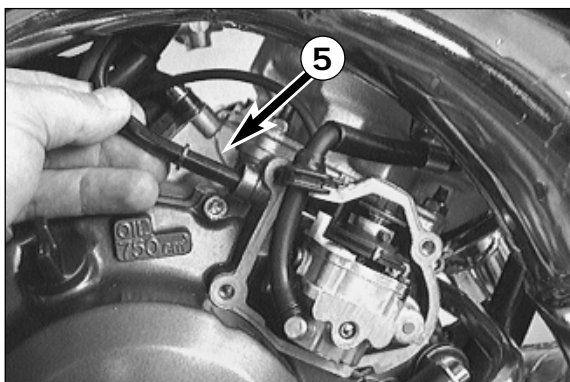

Removing the headlight mask*

The headlight mask must be removed whenever you want to change the headlight or instrument lamps.

- a) Removing the front flashers.
 - Remove the lens ⑥ by inserting a screw driver in the lateral slot to separate the lens from the flasher housing.
 - Remove the reflector from the housing and remove the flasher cables
 - Remove the HH screw ⑦ and remove the flasher housing
- b) Removing the knob of the day mileage indicator.
 - Pop off the cap ⑧ with a small screwdriver
 - use a Phillips screw driver (size 1) to remove the screw inside the knob ⑨, remove the knob and the rubber ring.

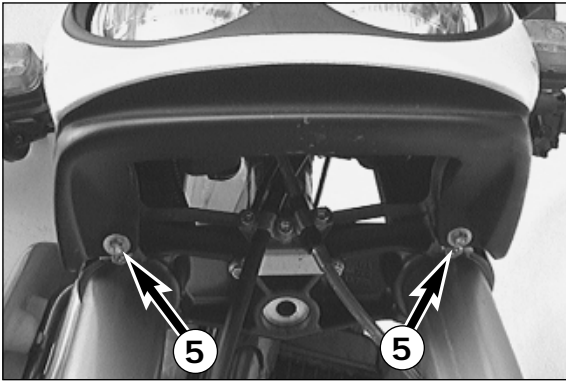

c) Remove the collar screws **5** on the bottom side of the headlight mask.

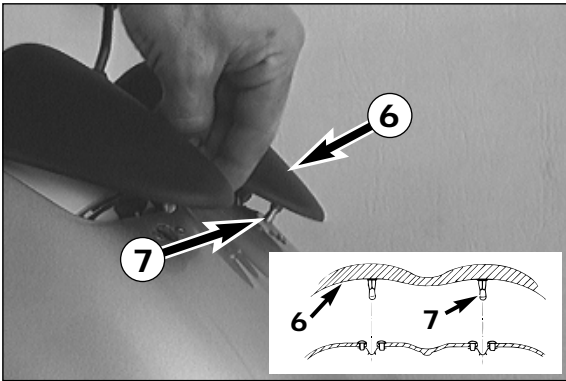

d) Lift the instrument cover **6** up, in order to release the retaining pins **7** at the spring clasps.

e) Remove the headlight mask, pulling it forward.

MOUNTING THE HEADLIGHT MASK

Reverse the above steps.

- Run the flasher cables outside through the corresponding openings before tightening the headlight mask
- the brown flasher cable is ground
- Finally, check the electrical system for proper functioning.

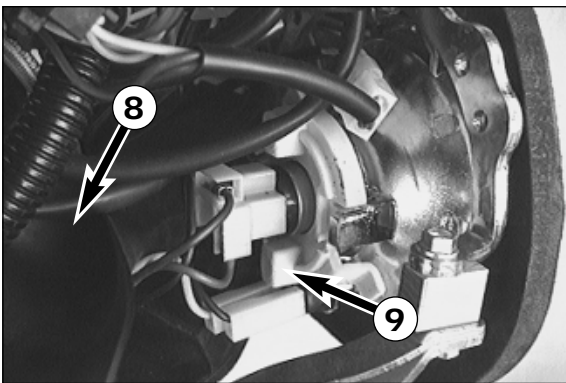

Replacing the headlight bulb*

The headlights are accessible after you have removed the headlight mask.

- Pull the rubber cap **8** back.
- Pull out connector of the lamp, turn retaining ring **9** counterclockwise, remove it, and remove old lamp. Install new lamp such that the bulb pins **A** engage with the socket groove **B**. Mount retaining ring and connector.
- Place the rubber cap in position.

! CAUTION !

THE GLASS OF THE BULB MUST BE FREE OF OIL AND GREASE. THE HEAT CAUSES THE OIL TO VAPORIZE. THE RESULTING VAPOR ON THE REFLECTOR DECREASES THE BRIGHTNESS OF THE HEADLIGHT.

- Start the engine and check the headlight for proper functioning.

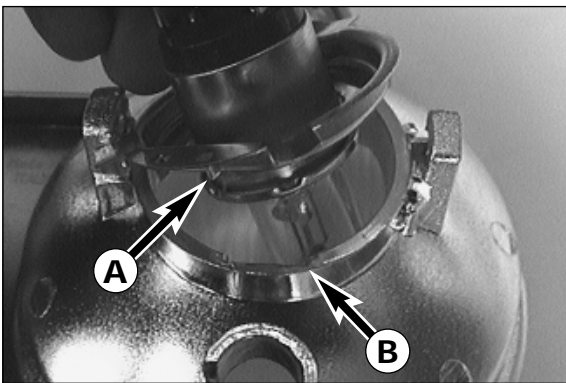

Replacing the instrument lights*

The instruments are accessible after you have removed the headlight mask.

- Simply remove the sockets from the housing, pulling them out by the cables.
- Remove the bulb from the socket.

Replacing the indicator lamps*

The lamps are accessible after you have removed the headlight mask.

- Pull their cables out, and lift the control lamps upwards out of the cockpit cover.



TROUBLE SHOOTING

If you let the specified maintenance work on your motorcycle be carried out, disturbances can hardly be expected. Should an error occur nevertheless, we advise you to use the trouble shooting chart in order to find the cause of error. We would like to point out that many operations cannot be performed by oneself. In case of uncertainty, please contact a KTM-dea-

TROUBLE	CAUSE	REMEDY
Engine doesn't crank.	Operating error Discharged battery. Defect ignition lock or emergency OFF switch	Turn on the ignition, switch the gear to neutral and switch the emergency OFF switch on, swing up side stand. Recharge the battery and investigate the causes for discharging; contact a KTM dealer. Check ignition lock and emergency OFF switch, contact a KTM dealer.
Engine doesn't crank; parking light don't light up.	Blown main fuse Discharged battery.	Replace the main fuse. If fuse blows again contact a KTM dealer Charge battery as indicated in the manual and determine cause of discharge. Contact a KTM dealer.
The engine cranks only with pulled clutch lever	The diode at the connector support is defect (interrupted)	Contact a KTM dealer; the diode must be replaced.
Engine cranks with gear engaged.	Defect safe-starting system.	Contact a KTM dealer.
Engine cranks but doesn't start.	Operating error Fuel supply interrupted Flooded engine Sooty or wet spark plug Electrode gap too large Spark plug connector or spark plug faulty The plug connection of the CDI-unit, the pulse generator or the ignition coil has oxydized Water in carburetor or jets blocked Carburetor does not fit in properly at intake flange	Open fuel tap, tank fuel, you did not use choke. Pay attention to starting off information (see driving instructions). Loosen fuel hose at carburettor, lead into a basin and open fuel tap – if fuel leaks out, the carburetor might need cleaning – if no fuel leaks out, check tank ventilation, i.e. clean fuel tap See driving instructions Clean or replace spark plug Adjust spark plug elektrode gap to 0,7 mm Dismount spark plug, connect ignition cable, hold to ground (blank place on engine) and actuate starter, a strong spark must be produced at the spark plug – If no spark is produced, loosen spark plug cap from ignition cable, hold about 5 mm from ground and actuate kickstarter – If a spark now occurs, replace spark plug cap – If no spark is produced, control ignition system Remove the seat and the fuel tank. Clean the plug connection and treat it with contact spray Dismount and clean carburetor Check if carburetor is fitted in correctly
Engine fails to idle	Glogged idling jet Oncorrect adjustment of adjusting screws on carburetor Defective ignition system	Disassemble carburetor and clean jets Have carburetor adjusted Have ignition system checked

TROUBLE	CAUSE	REMEDY
Engine fails to rev high	<p>fuel level in carburetor is too high – leaking float needle valve – float is not tight – float has no axial play</p> <p>loose carburetor jets</p> <p>electronic ignition timing is faulty</p>	<p>disassemble and clean carburetor, and check it for wear replace float needle valve replace float resurface float</p> <p>tighten jets</p> <p>have ignition system checked</p>
Engine has too little power	<p>fuel supply partially interrupted or dirty carburetor</p> <p>control roller fails to move</p> <p>incorrect adjustment of control roller cables</p> <p>fuel level in carburetor is too high</p> <p>air filters are extremely dirty</p> <p>leaking or deformed exhaust system</p> <p>electronic ignition timing is faulty</p>	<p>clean and check fuel system and carburetor</p> <p>turn on ignition and check whether the cleaning cycle of the control roller is executed. If not, check control roller for smooth running or check servomotor</p> <p>adjust cables</p> <p>disassemble and clean carburetor, and check it for wear</p> <p>clean or replace air filter</p> <p>check exhaust system for damage</p> <p>have ignition system checked</p>
Engine misfires or backfires into carburetor	<p>fuel shortage</p> <p>engine takes in unmetered air</p>	<p>check and clean fuel system and carburetor</p> <p>check intake flange and carburetor for tight fit</p>
Engine overheats	<p>not enough cooling liquid in cooling system</p> <p>radiator fins are extremely dirty</p> <p>foam forms in cooling system</p> <p>bent radiator hose</p> <p>defective thermostat</p>	<p>replenish cooling liquid (see maintenance work), check cooling system for leaks</p> <p>clean radiator fins with water jet</p> <p>replace cooling liquid, use branded antifreeze agent</p> <p>shorten or replace radiator hose</p> <p>dismantle thermostat and have it checked (opening temperature: 65° C) or replace it</p>
All activated lamps are blown out	defective voltage regulator	remove seat and fuel tank, and check connections, check voltage regulator
Battery is discharged	<p>ignition (power consumer) not turned OFF</p> <p>discharge due to residual current</p> <p>no charge</p>	<p>charge battery according to instructions</p> <p>perform electric loss test</p> <p>check connections and components of the charging system</p>

CLEANING

Clean the motorcycle at regular intervals to preserve the outward appearance of the plastic parts. The best manner would be to use warm water that has been mixed with a normal trade washing detergent and a sponge. The hard dirt can be removed before with the help of a soft water jet.

!

CAUTION

!

NEVER CLEAN YOUR MOTORCYCLE WITH A HIGH-PRESSURED CLEANER OR A HIGH-PRESSURED WATER JET. THE WATER COULD OTHERWISE RUN INTO THE ELECTRICAL COMPONENTS, CONNECTORS, SHEATHED CABLES, BEARINGS, CARBURETOR ETC. AND CAUSE DISTURBINGS OR LEAD TO A PREMATURE DESTRUCTION OF THESE PARTS.

- You should use normal trade-mark detergents to clean the engine. Strongly dirtied parts should be cleaned additionally with the help of a paint brush.
- After the motorcycle has been rinsed with a soft water jet, it should be dried by air pressure and a cloth. Then take a short drive until the engine has reached the working temperature and also use the brakes. Due to the heat, the water also evaporates at the unapproachable parts of the engine and the brakes.
- Slide back the protective covers on the handlebar-mounted instruments so that any water that may have seeped into this part of the motorcycle is allowed to evaporate.
- After the motorcycle has cooled down, oil and grease all sliding and pivot points. Treat the chain with a chain spray too.
- To prevent failures in the electric system, you should treat the ignition lock, the emergency OFF switch, light switch and the socket connectors with contact spray.
- Finally all painted parts should be treated with a gentle paint cleaner.

CONSERVATION FOR WINTER OPERATION

In the event that the motorcycle is also used in winter and on roads where one has to expect salt spraying, you will have to take precautions against the aggressive road salt.

- clean motorcycle thoroughly after each riding and let it dry
- treat engine, carburetor, swing arm, and all other bare or galvanized parts (except for brake discs) with a wax-based anti-corrosion agent.

⚠

WARNING

⚠

KEEP ANTI-CORROSION AGENT FROM GETTING INTO CONTACT WITH THE BRAKE DISCS, FOR OTHERWISE THIS WILL SIGNIFICANTLY REDUCE THE BRAKING POWER.

!

CAUTION

!

AFTER RIDES ON SALTED ROADS, CLEAN MOTORCYCLE THOROUGHLY WITH COLD WATER AND LET IT DRY WELL!

STORAGE

Should you desire to make a pause over a longer space of time, please observe the following instructions:

- Clean motorcycle thoroughly (see chapter: CLEANING)
- Check antifreezer and amount of cooling liquid.
- Let the engine warm up again.
- Drain fuel from float chamber of the carburetor. By this means, carburetor jets are prevented from becoming resinous by the old fuel.
- Remove spark plug, and fill approx. 5 ccm engine oil into the cylinder via the spark plug hole. Start for 5 seconds in order to spread the engine oil, and reinstall spark plug.
- Let fuel flow out of tank into an appropriate container.
- Correct tire pressure.
- Lubricate pivot points of the control levers, foot rests, etc. as well as the chain.
- Servicing the shock absorber linkage and swing arm bearings.
- Remove and charge battery (see chapter: BATTERY).
- The storage place should be dry and not subject to excessive temperature fluctuations.
- Cover the motorcycle with an air permeated tarpaulin or blanket. Do not use non air permeable materials as a possible humidity might not be able to escape and could cause corrosion.

!

CAUTION

!

IT IS EXTREMELY BAD TO LET THE ENGINE RUN FOR SHORT PERIODS OF TIME WHEN THE MOTORCYCLE IS KEPT IN STORAGE. SINCE IN THIS CASE THE ENGINE WOULD NOT GET WARM ENOUGH, THE STEAM PRODUCED DURING THE COMBUSTION PROCESS WOULD CONDENSE AND CAUSE RUSTING ON CRANKSHAFT, MAIN BEARING, AND EXHAUST SYSTEM.

RE-INITIATION AFTER TIME OF STORAGE

- Mount the charged battery (watch out for polarity, RED = +)
- Fill up tank with fresh fuel and turn the fuel tap to the ON position.
- Check motorcycle as before each start.
- Take a short, careful test ride first.

TECHNICAL SPECIFICATIONS - CHASSIS KTM 125 Sting '98

Frame	Central chrome-moly-steelframe	
Fork	Type	White Power Ø 41mm (1.6 in)
	Suspension travel	170 mm (6.7 in)
	Spring preload	15 mm (0.6 in)
	Oil capacity per fork leg / viscosity	330 ccm / SAE 5
Rear wheel suspension	Central shock absorber with PRO LEVER linkage to needle-bearing mounted aluminium swingarm	
Shock absorber	Type	Paioli MC56 (l=438 mm / 17.24 in))
	Suspension travel	280 mm (11 in)
	Spring preload	14 mm (± 10 mm) (0.55 in ± 0.4 in)
Front brake	Disk brake with perforated brake disk Ø 320 mm (12,6 in), 4-piston brake caliper	
Rear brake	Disk brake with perforated brake disk Ø 220 mm (8,7 in), brake caliper floated	
Tire front	110/70 - 17 54H	
Air pressure, driver only	1.8 bar (26 psi)	
Air pressure driver plus passenger	2.0 bar (29 psi)	
Tire rear	130/70 - 17 62H	
Air pressure, driver only	2.1 bar (31 psi)	
Air pressure driver plus passenger	2.3 bar (34 psi)	
Fuel tank capacity	8.5 liter (2.2 US gallons), of that 3.0 liter (0.8 US gallons) reserve	
Rear wheel transmission ratio	13:42 / 13:45	
Chain	O-ring ⁵ / ₈ x ¹ / ₄ "	
Battery	12V 3Ah maintenance free	
Lamps	low beam	HS1 12V 35/35W (socket Px43 t)
	high beam	HS1 12V 35/35W (socket Px43 t)
	parking light	12V 4W (socket W 2,1x9.5 d)
	cockpit lights	12V 1.2W (socket W 2x4.6 d)
	stop and tail light	12V 21/5W (socket BaY 15 d)
	flasher	12V 10W (socket Ba 15 s)
Steering head angle	63°	
Wheel base	1420 ±10 mm (55.9 in ±0.4 in)	
Seat high (unloaded)	840 mm (33.1 in)	
Ground clearance (unloaded)	250 mm (98 in)	
Weight with tank filled up	121 kg (268 lbs)	
Max. permissible front axle load	125 kg (278 lbs)	
Max. permissible rear axle load	225 kg (500 lbs)	
Max. permissible laden weight	350 kg (770 lbs)	

TORQUES

Collar screw front wheel spindle	M 10	40 Nm (30 ft.lbs)
Collar nut rear wheel spindle	M 20x1,5	80 Nm (59 ft.lbs)
Hexagon nut swingarm pivot	M 14x1,5	100 Nm (74 ft.lbs)
Clamp screws top triple clamp	M 8	15 Nm (11 ft.lbs)
Clamp screws bottom triple clamp	M 8	15 Nm (11 ft.lbs)
Hexagon nuts fork leg axle passage	M 8	7 Nm (5 ft.lbs)
AH screws front brake caliper	M10	40 Nm (30 ft.lb)
Other screws on chassis	M6	10 Nm (7 ft.lbs)
	M8	25 Nm (19 ft.lbs)
	M10	45 Nm (33 ft.lbs)

TECHNICAL DATA – ENGINE KTM 125 LC2 '98

Design	single-cylinder, two-stroke Otto engine with balancer shaft, liquid-cooled						
Control	membrane inlet into crankcase, exhaust control by means of servomotor and roller						
Displacement	124.8 ccm						
Bore / stroke	56 / 50.7 mm						
Compression ratio	12.5:1						
Fuel	unleaded fuel with a least RON 91						
Engine lubrication	separate lubrication						
Engine oil	Shell Advance VSX 2 or 2-stroke oil for a mix ratio 1:50 and separate lubrication						
Crankshaft bearing	2 ball bearings						
Conrod bearing	needle bearing						
Piston pin bearing	Bushing						
Piston	cast light alloy						
Piston rings	1 half keystone ring, 1 rectangular ring						
Primary drive	helical gears 22:73 Z						
Clutch	multi disk clutch in oil bath						
Transmission	6-speed shift dog operated						
Transmission reduction	<table style="width: 100%; border: none;"> <tr> <td style="width: 50%;">1st gear 34:12</td> <td style="width: 50%;">4th gear 24:21</td> </tr> <tr> <td>2nd gear 30:16</td> <td>5th gear 22:23</td> </tr> <tr> <td>3rd gear 24:17</td> <td>6th gear 18:22</td> </tr> </table>	1st gear 34:12	4th gear 24:21	2nd gear 30:16	5th gear 22:23	3rd gear 24:17	6th gear 18:22
1st gear 34:12	4th gear 24:21						
2nd gear 30:16	5th gear 22:23						
3rd gear 24:17	6th gear 18:22						
Gear oil	0,75 liter (0,2 US gallons) engine oil SAE 10W40 (Shell Advance Ultra 4)						
Ignition system	breakerless CDI ignition system with digital ignition timing						
Generator	12V / 95W						
Spark plug	NGK BR9ES (NGK BR8ES)						
Electrode distance	0.7 mm ± 0.1 mm (0.03 in)						
Cooling system	liquid cooling, permanent circulation of cooling liquid effected by water pump						
Cooling liquide	0.8 Liter (0,2 US gallons), 40% antifreezer, 60% water, at least -25°C (-13°F)						
Carburetor	slide carburetor						
Air filter	wet foam type air filter insert						
Oil tank	tank content: 1,3 liter (0,34 US gallons)						

BASIC CARBURETOR SETTING 125 Sting

	80 kmh with KAT	100 kmh with KAT	100 kmh without KAT
Type	Dell'Orto PHBH 28 VS	Dell'Orto PHBH 28 VS	Dell'Orto PHBH 28 VS
Carburettor setting number	4171	4171	4175
Main jet	132	132	132
Needle jet	GM1 264	GM1 264	GM1 264
Idling jet	50	50	52
Starting jet	70	70	70
Jet needle	83	83	83
Needle position from top	3	3	3
Mixture adjusting screw open	4 turns	4 turns	4 turns
Throttle slide	40	40	30

KTM-SPORTMOTORCYCLE AG

A-5230 Mattighofen • Postfach 91 • Austria

Internet: <http://www.ktm.co.at>

FN 102019 d - Landesgericht Ried im Innkreis



320536