

SETUP INSTRUCTIONS 2011

125 SX

150 SX

250 SX

150 XC USA

250 XC EU/USA

300 XC EU/USA

Art. no. 3211692en



KTM

The work described in these setup instructions must be performed before the vehicle is delivered to the customer.

Read the setup instructions in their entirety before beginning work.

Print out the current **PDI** form found on the **KTM DEALER.NET**.

These setup instructions were written to correspond to the latest state of this series. We reserve the right to make changes in the interest of technical advancement without at the same time updating this manual.

We shall not provide a description of general workshop methods. Likewise, safety rules that apply in a workshop are not specified here. It is assumed that the work will be performed by a fully trained mechanic.

All specifications are non-binding. KTM Sportmotorcycle AG in particular reserves the right to modify or delete technical specifications, prices, colors, forms, materials, services, designs, equipment, etc., without prior notice and without specifying reasons, to adapt these to local conditions, as well as to stop production of a particular model without prior notice. KTM accepts no liability for delivery options, deviations from illustrations and descriptions, as well as misprints and other errors. The models portrayed partly contain special equipment that does not belong to the regular scope of delivery.

© 2010 KTM-Sportmotorcycle AG, Mattighofen Austria

All rights reserved

Reproduction, even in part, as well as copying of all kinds, is permitted only with the express written permission of the copyright owner.



REG.NO. 12 100 6061

ISO 9001(12 100 6061)

According to the international quality management standard ISO 9001, KTM uses quality assurance processes that lead to the maximum possible quality of the products.

Issued by: TÜV Management Service

KTM-Sportmotorcycle AG
5230 Mattighofen, Austria

Symbols used

The symbols used are explained in the following.



Indicates an expected reaction (e.g. of a work step or a function).



Indicates an unexpected reaction (e.g. of a work step or a function).



Identifies a page reference (more information is provided on the specified page).



Denotes additional information or tips.



Denotes the result of a test step.



Denotes a voltage measurement.



Denotes a current measurement.



Denotes a resistance measurement.

Formats used

The typographical and other formats used are explained in the following.

Own name Indicates a proprietary name.

Name[®] Identifies a protected name.

Brand[™] Identifies a brand in merchandise traffic.

Unpacking and setting up the vehicle



Packaging 2

- Remove the box and the plastic packaging.

i Info
To avoid damaging the motorcycle during the setup, leave the protective film on the vehicle until you have finished.

- Remove the separate enclosure and unpack it. Check that the scope of delivery is complete on the basis of the enclosed packing list.
- Have a lift stand available.

Lift stand (54829055000)

- Carefully loosen and remove the tensioning belt over the link fork.

i Info
An assistant prevents the motorcycle from falling over.

- Carefully loosen and remove the tensioning belts around the lower triple clamp.
 - ✓ The vehicle is released at the front.
- Together with an assistant, take the vehicle off of the palette.
- Position the vehicle on a lift stand.
- Check the vehicle for transport damage.

Package 12

- Remove the box and the plastic packaging.

i Info
An assistant prevents the motorcycle from falling over.
To avoid damaging the motorcycle during the setup, leave the protective film on the vehicle until you have finished.

- Remove the separate enclosure and unpack it. Check that the scope of delivery is complete on the basis of the enclosed packing list.
- Have a lift stand available.

Lift stand (54829055000)

- Together with an assistant, take the vehicle off of the palette.
- Position the vehicle on a lift stand.
- Check the vehicle for transport damage.
- Remove the cardboard from around the shock absorber.
- Install the shock absorber. (☛ p. 6)



- Route the clutch line with the clutch master cylinder toward the front between the upper and lower triple clamps.
- Position the fork legs and tighten the screws of the triple clamp.

Guideline

Screw, top triple clamp	M8	17 Nm (12.5 lbf ft)
Screw, bottom triple clamp	M8	12 Nm (8.9 lbf ft)

i Info
The upper milled groove in the fork leg must be flush with the top edge of the upper triple clamp.
Position bleeder screws toward the front.

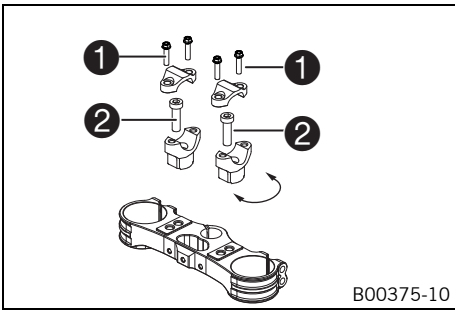

B00375-10

- Remove screws ❶. Remove the handlebar clamp.
- Remove screws ❷. Remove the handlebar support.
- Place the handlebar support in the required position. Mount and tighten screws ❷.

Guideline

Screw, handlebar support	M10	40 Nm (29.5 lbf ft)	Loctite® 243™
--------------------------	-----	------------------------	---------------

i Info
Position the left and right handlebar supports evenly.

- Position the handlebar.

i Info
Make sure cables and wiring are positioned correctly.

- Position the handlebar clamps. Mount and tighten the screws.

Guideline

Screw, handlebar clamp	M8	20 Nm (14.8 lbf ft)
------------------------	----	------------------------

i Info
The markings on the handlebar should be at the center of the handlebar clamps.
Keep the gap widths equal when tightening.

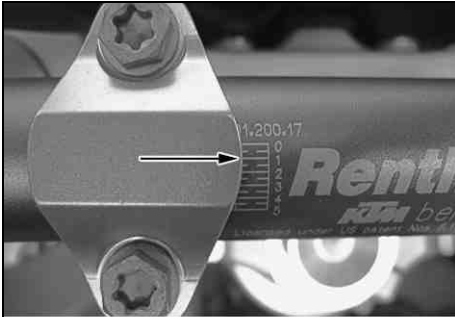

600824-10

- Position the controls on the right half of the handlebar.

i Info
The routing of the cables can be seen in the figure.



B00092-01

- Position the controls on the left half of the handlebar.

i Info
The figure shows how to route the clutch line and wiring harness.



B00093-01

- Install the front fender. (☛ p. 7)
- Correctly mount the fuel tank breather.

- Secure the handlebar cushion with two cable binders.
- Install the start number plate. (☛ p. 7)



B00539-01

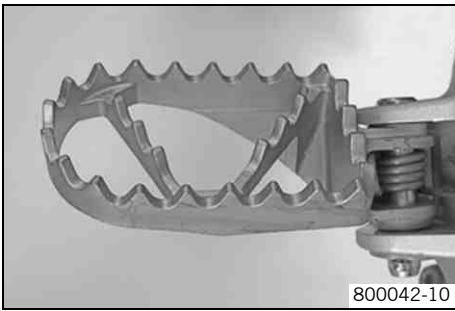

- Mount the footrests with the springs and bolts. Secure the bolts using the washers and pins.

Plier for footrest spring (58429083000)



(250/300 XC)



Warning

Risk of injury Battery acid and battery gases cause serious cauterization.

- Keep batteries out of the reach of children.
- Wear suitable protective clothing and goggles.
- Avoid contact with battery acid and battery gases.
- Keep the battery away from sparks or open fire. Charge only in well ventilated rooms.
- Flush with copious amounts of water in case of skin contact. If battery acid comes into contact with the eyes, flush the eyes with water for at least 15 minutes and consult a physician.

- Fill the battery.



Info

Read the notes in the battery package.

- Recharge the battery. (☛ p. 8)
- Install the battery. (☛ p. 9)
- Unpack and mount the **KTM PowerParts** included in the delivery (optional).



Info

Read the accompanying **KTM PowerParts** installation instructions.

- Apply the label included in the delivery (optional).
- Refuel. (☛ p. 10)
- Position all controls exactly on the handlebar. Tighten all screws.
- Print out the current **PDI** form found on **KTM DEALER.NET** and perform the delivery inspection.



Installing the shock absorber

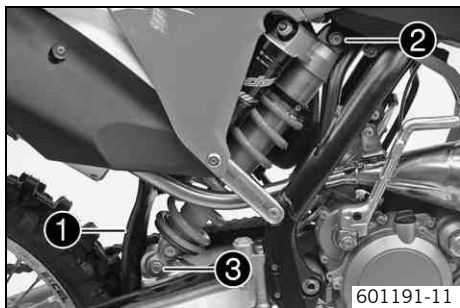

(All 125/150 models)

- Push splash protector ❶ to the side and position the shock absorber. Mount and tighten screw ❷.

Guideline

Screw, top shock absorber	M12	80 Nm (59 lbf ft)	Loctite® 2701
---------------------------	-----	-------------------	---------------

- Mount and tighten screw ❸.

Guideline

Screw, bottom shock absorber	M12	80 Nm (59 lbf ft)	Loctite® 2701
------------------------------	-----	-------------------	---------------

i Info
The heim joint for the shock absorber at the swing arm is Teflon coated. It must not be lubricated with grease or with other lubricants. Lubricants dissolve the Teflon coating, thereby drastically reducing the service life.

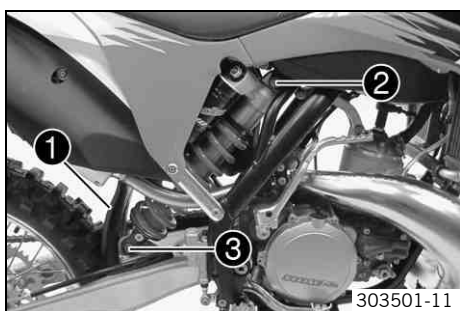

(All 250/300 models)

- Push splash protector ❶ to the side and position the shock absorber. Mount and tighten screw ❷.

Guideline

Screw, top shock absorber	M12	80 Nm (59 lbf ft)	Loctite® 2701
---------------------------	-----	-------------------	---------------

- Mount and tighten screw ❸.

Guideline

Screw, bottom shock absorber	M12	80 Nm (59 lbf ft)	Loctite® 2701
------------------------------	-----	-------------------	---------------

i Info
The heim joint for the shock absorber at the swing arm is Teflon coated. It must not be lubricated with grease or with other lubricants. Lubricants dissolve the Teflon coating, thereby drastically reducing the service life.

- Remove the motorcycle from the lift stand.

Installing the front wheel

Warning
Danger of accidents Reduced braking efficiency due to oil or grease on the brake discs.

- Always keep the brake discs free of oil and grease, and clean them with brake cleaner when necessary.

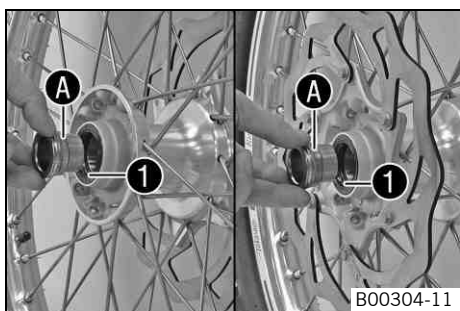

- Check the wheel bearing for damage and wear.
 - » If the wheel bearing is damaged or worn:
 - Change the wheel bearing.
- Clean and grease shaft seal rings ❶ and bearing surface A of the spacers.

Long-life grease (☛ p. 13)

- Insert the spacers.

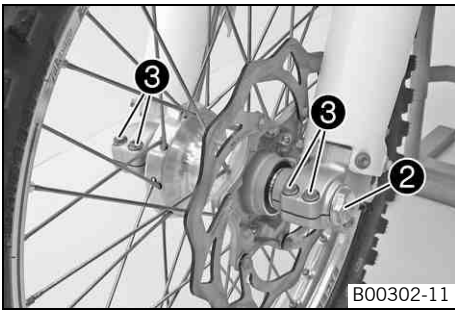

- Lift the front wheel into the fork, position it, and insert the wheel spindle.
- Mount and tighten screw ②.

Guideline

Screw, front wheel spindle	M24x1.5	45 Nm (33.2 lbf ft)
----------------------------	---------	------------------------

- Operate the hand brake lever several times until the brake linings are lying correctly against on the brake disc.
- Remove the motorcycle from the lift stand.
- Pull the front wheel brake and push down hard on the fork several times to align the fork legs.
- Tighten screws ③.

Guideline

Screw, fork stub	M8	15 Nm (11.1 lbf ft)
------------------	----	------------------------

Installing the front fender

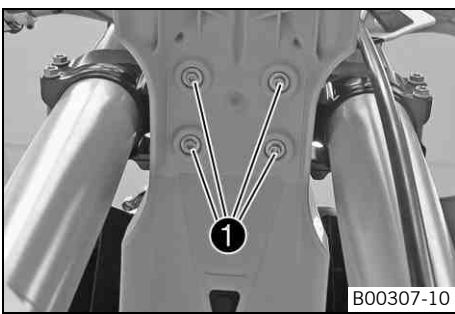

- Ensure that the spacers are mounted in the fender.
- Position the front fender. Mount and tighten screws ①.

Guideline

Remaining screws, chassis	M6	10 Nm (7.4 lbf ft)
---------------------------	----	--------------------

i Info
Make sure the holding lugs engage in the start number plate.

Installing the start number plate

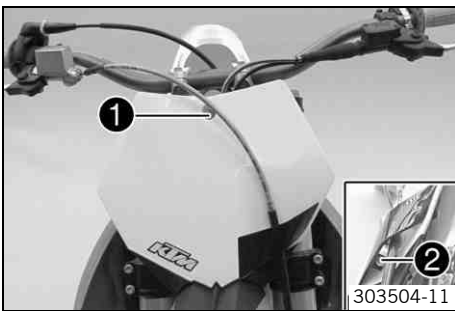

- Position the start number plate. Mount and tighten screw ①.

Guideline

Remaining screws, chassis	M6	10 Nm (7.4 lbf ft)
---------------------------	----	--------------------

i Info
Ensure that the holding lugs engage in the fender.

- Position the brake line. Position the clamp and mount and tighten screw ②.

Removing the seat

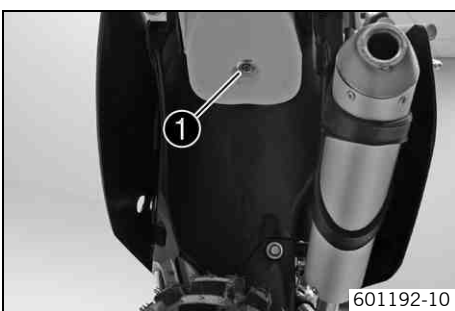

- Remove screw ①. Lift up the seat at the rear, pull it back and then remove from above.

Mounting the seat

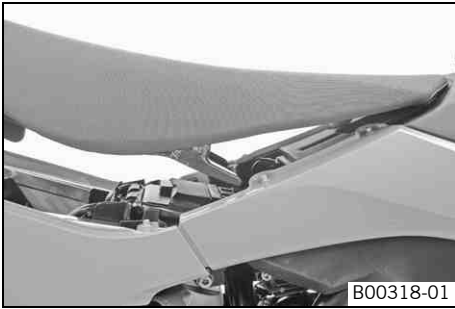

B00318-01

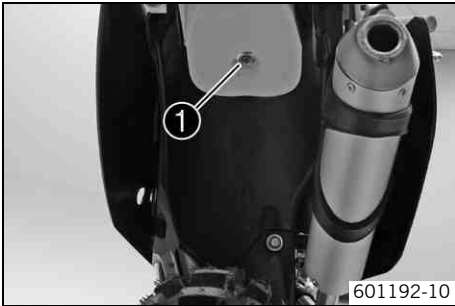

601192-10

- Hook in the front of the seat at the collar bushing of the fuel tank, lower at the rear and simultaneously push forward.
- Make sure that the seat is correctly locked in.

- Mount and tighten screw ❶ of the seat fixation.

Guideline

Remaining screws, chassis	M6	10 Nm (7.4 lbf ft)
---------------------------	----	--------------------

Recharging the battery (250/300 XC)



Warning

Risk of injury Battery acid and battery gases cause serious cauterization.

- Keep batteries out of the reach of children.
- Wear suitable protective clothing and goggles.
- Avoid contact with battery acid and battery gases.
- Keep the battery away from sparks or open fire. Charge only in well ventilated rooms.
- Flush with copious amounts of water in case of skin contact. If battery acid comes into contact with the eyes, flush the eyes with water for at least 15 minutes and consult a physician.



Warning

Environmental hazard Battery parts and acid are harmful to the environment.

- Do not discard batteries with the household trash. Dispose of a defective battery in an environmentally compatible manner. Give the battery to your KTM dealer or to a recycling center that accepts used batteries.



Warning

Environmental hazard Hazardous substances cause environmental damage.

- Oil, grease, filters, fuel, cleaners, brake fluid, etc., should be disposed of as stipulated in applicable regulations.



Info

Even when there is no load on the battery, it still loses power steadily. The charge state and the type of charge are very important for the service life of the battery. Rapid recharging with a high charging current shortens the battery's service life. If the charging current, charging voltage and charging time are exceeded, electrolyte escapes through the safety valves. This reduces the battery capacity. If the battery is depleted from starting the vehicle repeatedly, the battery must be charged immediately. If the battery is left in a discharged state for an extended period, it will become over-discharged and sulfate, destroying the battery. The battery is maintenance-free, i.e., the acid level does not have to be checked.

- Switch off all power consumers and switch off the engine.
- Remove the seat. (☛ p. 7)
- Disconnect the negative cable of the battery to avoid damage to the motorcycle's electronics.

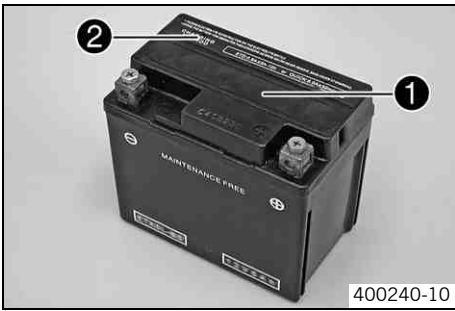

- Connect the battery charger to the battery. Switch on the battery charger.

Battery charger (58429074000)

You can also use the battery charger to test rest potential and start potential of the battery, and to test the alternator. With this device, you cannot overcharge the battery.



Info

Never remove lid ❶.

Charge the battery with a maximum of 10% of the capacity specified on the battery housing ❷.

- Switch off the charger after charging. Disconnect the battery.

Guideline

The charge current, charge voltage and charge time must not be exceeded.

Charge the battery regularly when the motorcycle is not in use	3 months
--	----------

- Mount the seat. (☛ p. 8)

Installing the battery (250/300 XC)

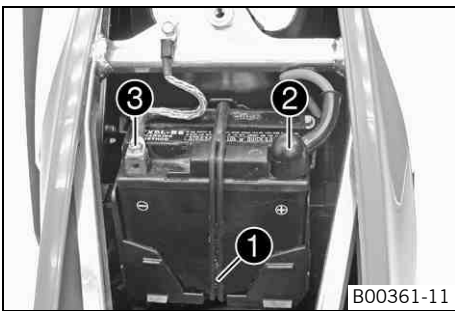

- Place the battery in the battery holder.

Battery (YTX4L-BS)

- Reconnect rubber band ❶.
- Attach the positive cable and replace the positive terminal cover ❷.
- Attach negative cable ❸.
- Mount the seat. (☛ p. 8)

Opening the filler cap

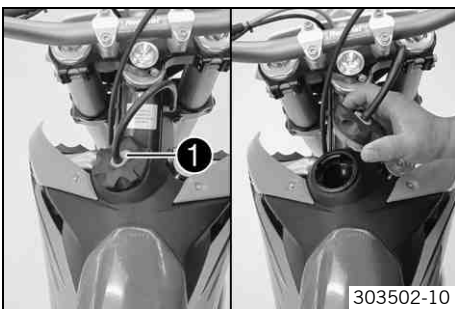

- Press release button ❶, turn the filler cap counterclockwise and lift it free.

Closing the filler cap

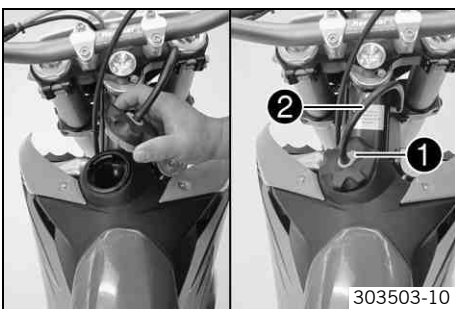

- Replace the filler cap and turn clockwise until the release button ❶ locks in place.



Info

Run the fuel tank breather hose ❷ without kinks.

Refueling

Danger
Fire hazard Fuel is highly flammable.

- Never refuel the vehicle near open flames or burning cigarettes, and always switch off the engine first. Be careful that no fuel is spilt, especially on hot vehicle components. Clean up spilt fuel immediately.
- Fuel in the fuel tank expands when warm and can escape if the tank is overfilled. See the notes on refueling.

Warning
Danger of poisoning Fuel is poisonous and a health hazard.

- Avoid contact of the fuel with skin, eyes and clothing. Do not inhale fuel vapors. If fuel gets into your eyes, rinse immediately with water and contact a doctor. Wash affected skin areas immediately with soap and water. If fuel is swallowed, contact a doctor immediately. Change clothing that has come into contact with fuel.

Warning
Environmental hazard Improper handling of fuel is a danger to the environment.

- Do not allow fuel to get into the ground water, the ground, or the sewage system.

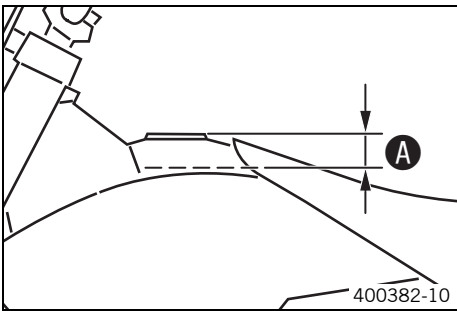

- Switch off the engine.
- Open the filler cap. (☛ p. 9)
- Fill the fuel tank with fuel up to measurement **A**.

Guideline

Measurement of A		35 mm (1.38 in)
Total fuel tank capacity, approx.	7.5 l (1.98 US gal)	Super unleaded gasoline, mixed with 2-stroke engine oil (1:40) (☛ p. 12) (125/150 SX)
		Super unleaded gasoline, mixed with 2-stroke engine oil (1:60) (☛ p. 12) (250 SX)
Total fuel tank capacity, approx.	11.5 l (3.04 US gal)	Super unleaded gasoline, mixed with 2-stroke engine oil (1:40) (☛ p. 12) (150 XC USA)
		Super unleaded gasoline, mixed with 2-stroke engine oil (1:60) (☛ p. 12) (250/300 XC)
2-stroke engine oil (☛ p. 12)		

- Close the filler cap. (☛ p. 9)

Spoke nipple, front wheel	M4.5	5... 6 Nm (3.7... 4.4 lbf ft)	–
Spoke nipple, rear wheel	M4.5	5... 6 Nm (3.7... 4.4 lbf ft)	–
Screw, frame protector	M5	3 Nm (2.2 lbf ft)	–
Screw, shock absorber adjusting ring	M5	5 Nm (3.7 lbf ft)	–
Remaining nuts, chassis	M6	15 Nm (11.1 lbf ft)	–
Remaining screws, chassis	M6	10 Nm (7.4 lbf ft)	–
Screw, ball joint of push rod on foot brake cylinder	M6	10 Nm (7.4 lbf ft)	Loctite® 243™
Screw, chain sliding guard	M6	6 Nm (4.4 lbf ft)	Loctite® 243™
Screw, front brake disc	M6	14 Nm (10.3 lbf ft)	Loctite® 243™
Screw, rear brake disc	M6	14 Nm (10.3 lbf ft)	Loctite® 243™
Nut, foot brake lever stop	M8	20 Nm (14.8 lbf ft)	–
Nut, rear sprocket screw	M8	35 Nm (25.8 lbf ft)	Loctite® 2701
Nut, rim lock	M8	10 Nm (7.4 lbf ft)	–
Nut, starter motor (250/300 XC)	M8	10 Nm (7.4 lbf ft)	–
Remaining nuts, chassis	M8	30 Nm (22.1 lbf ft)	–
Remaining screws, chassis	M8	25 Nm (18.4 lbf ft)	–
Screw, bottom triple clamp	M8	12 Nm (8.9 lbf ft)	–
Screw, chain sliding piece	M8	15 Nm (11.1 lbf ft)	–
Screw, engine brace	M8	33 Nm (24.3 lbf ft)	–
Screw, fork stub	M8	15 Nm (11.1 lbf ft)	–
Screw, front brake caliper	M8	25 Nm (18.4 lbf ft)	Loctite® 243™
Screw, handlebar clamp	M8	20 Nm (14.8 lbf ft)	–
Screw, side stand attachment	M8	40 Nm (29.5 lbf ft)	Loctite® 2701
Screw, subframe	M8	35 Nm (25.8 lbf ft)	Loctite® 2701
Screw, top steering stem	M8	17 Nm (12.5 lbf ft)	Loctite® 243™
Screw, top triple clamp	M8	17 Nm (12.5 lbf ft)	–
Engine bracket screw	M10	60 Nm (44.3 lbf ft)	–
Remaining nuts, chassis	M10	50 Nm (36.9 lbf ft)	–
Remaining screws, chassis	M10	45 Nm (33.2 lbf ft)	–
Screw, handlebar support	M10	40 Nm (29.5 lbf ft)	Loctite® 243™
Screw, bottom shock absorber	M12	80 Nm (59 lbf ft)	Loctite® 2701
Screw, top shock absorber	M12	80 Nm (59 lbf ft)	Loctite® 2701
Nut, seat fixing	M12x1	20 Nm (14.8 lbf ft)	–
Nut, swingarm pivot	M16x1.5	100 Nm (73.8 lbf ft)	–
Nut, rear wheel spindle	M20x1.5	80 Nm (59 lbf ft)	–
Screw, top steering head	M20x1.5	10 Nm (7.4 lbf ft)	–
Screw-in nozzles, cooling system	M20x1.5	12 Nm (8.9 lbf ft)	Loctite® 243™
Screw, front wheel spindle	M24x1.5	45 Nm (33.2 lbf ft)	–

2-stroke engine oil

According to

- JASO FC (☛ p. 14)

Guideline

- Only use high quality 2-stroke engine oil of a well-known brand. KTM recommends **Motorex®** products.

Fully synthetic

Supplier

Motorex®

- **Cross Power 2T**

Super unleaded gasoline, mixed with 2-stroke engine oil (1:40)

According to

- DIN EN 228
- JASO FC (☛ p. 14) (1:40)

Mixture ratio

1:40	2-stroke engine oil (☛ p. 12) Super unleaded (ROZ 95 / RON 95 / PON 91)
------	--

Super unleaded gasoline, mixed with 2-stroke engine oil (1:60)

According to

- DIN EN 228
- JASO FC (☛ p. 14) (1:60)

Mixture ratio

1:60	2-stroke engine oil (☛ p. 12) Super unleaded (ROZ 95 / RON 95 / PON 91)
------	--

Long-life grease

Guideline

- KTM recommends **Motorex®** products.

Supplier

Motorex®

- **Bike Grease 2000**

JASO FC

JASO FC is a classification for a 2-stroke engine oil that was specifically developed for the extreme demands of racing. Thanks to first rate synthetic esters and specially designed additives, superb combustion is achieved even under extreme operating conditions.



3211692en



09/2010 Photo: Mitterbauer



KTM-Sportmotorcycle AG
5230 Mattighofen/Austria
<http://www.ktm.com>