

# OWNER'S MANUAL 2012

**250 EXC-F EU**

**250 EXC-F AUS**

**250 EXC-F SIX DAYS EU**

**250 XCF-W USA**

Art. no. 3211719en



**KTM**



Congratulations on your decision to purchase a KTM motorcycle. You are now the owner of a state-of-the-art sports motorcycle that will give you enormous pleasure if you service and maintain it accordingly.

We wish you a lot of enjoyment in riding this vehicle.

Enter the serial numbers of your vehicle below.

Chassis number (☛ p. 9)	Dealer's stamp
Engine number (☛ p. 9)	
Key number (All EXC-F models) (☛ p. 9)	

The owner's manual corresponded to the latest state of this series at the time of printing. Slight deviations resulting from continuing development and design of the motorcycles can, however, not be completely excluded.

All specifications are non-binding. KTM Sportmotorcycle AG specifically reserves the right to modify or delete technical specifications, prices, colors, forms, materials, services, designs, equipment, etc., without prior notice and without specifying reasons, to adapt these to local conditions, as well as to stop production of a particular model without prior notice. KTM accepts no liability for delivery options, deviations from illustrations and descriptions, as well as misprints and other errors. The models portrayed partly contain special equipment that does not belong to the regular scope of delivery.

© 2011 KTM-Sportmotorcycle AG, Mattighofen Austria

All rights reserved

Reproduction, even in part, as well as copying of all kinds, is permitted only with the express written permission of the copyright owner.



ISO 9001(12 100 6061)





























According to the international quality management standard ISO 9001, KTM uses quality assurance processes that lead to the maximum possible quality of the products.

Issued by: TÜV Management Service

REG.NO. 12 100 6061





KTM-Sportmotorcycle AG  
5230 Mattighofen, Austria

MEANS OF REPRESENTATION .....	4	Running-in the engine .....	25
IMPORTANT INFORMATION .....	5	Preparing the vehicle for difficult riding conditions .....	25
VIEW OF VEHICLE.....	7	Preparing for rides on dry sand .....	26
View of vehicle, front left (example).....	7	Preparing for rides on wet sand.....	26
View of vehicle, rear right (example).....	8	Preparing for rides on wet and muddy surfaces.....	27
SERIAL NUMBERS.....	9	Preparing for rides at high temperature and slow speed .....	27
Chassis number.....	9	Preparing for rides at low temperatures or in snow .....	28
Type label.....	9	RIDING INSTRUCTIONS .....	29
Key number (All EXC-F models) .....	9	Checks and maintenance work when preparing for use .....	29
Engine number.....	9	Starting.....	29
Fork part number.....	9	Starting off .....	30
Shock absorber part number .....	10	Shifting, riding.....	30
CONTROLS .....	11	Braking .....	30
Clutch lever .....	11	Stopping, parking .....	31
Hand brake lever .....	11	Refueling.....	31
Throttle grip.....	11	SERVICE SCHEDULE.....	33
Kill switch (XCF-W).....	11	Service schedule .....	33
Kill switch (All EXC-F models) .....	11	Service work (as additional order).....	34
Horn button (All EXC-F models) .....	12	TUNING THE CHASSIS.....	35
Light switch (All EXC-F models) .....	12	Checking the basic suspension setting against the rider's weight .....	35
Turn signal switch (All EXC-F models) .....	12	Compression damping of shock absorber.....	35
Emergency OFF switch (EXC-F AUS) .....	12	Adjusting the low-speed compression damping of the shock absorber .....	35
Electric starter button (EXC-F AUS).....	12	Adjusting the high-speed compression damping of the shock absorber .....	36
Electric starter button (XCF-W, EXC-F EU, EXC-F SIX DAYS) .....	13	Adjusting the rebound damping of the shock absorber.....	36
Map-Select switch for the basic setting (EXC-F SIX DAYS) .....	13	Measuring rear wheel sag unloaded .....	37
Map-Select switch for vehicle operation (EXC-F SIX DAYS) .....	13	Checking the static sag of the shock absorber .....	37
Light switch (XCF-W) .....	13	Checking the riding sag of the shock absorber .....	37
Overview of indicator lamps (XCF-W) .....	13	Adjusting the spring preload of the shock absorber 🛠️ .....	38
Overview of indicator lamps (All EXC-F models) .....	14	Adjusting the riding sag 🛠️.....	38
Speedometer.....	14	Checking basic setting of fork.....	39
Speedometer activation and test .....	14	Adjusting the compression damping of the fork .....	39
Tripmaster switch.....	14	Adjusting the rebound damping of the fork.....	39
Setting kilometers or miles .....	15	Adjusting the spring preload of the fork .....	40
Setting the clock .....	15	Handlebar position .....	40
Adjusting the speedometer functions.....	16	Adjusting handlebar position 🛠️.....	40
Querying lap time .....	16	SERVICE WORK ON THE CHASSIS.....	42
Display mode SPEED (speed) .....	17	Raising the motorcycle with the lift stand .....	42
Display mode SPEED/H (operating hours) .....	17	Removing the motorcycle from the lift stand .....	42
Display mode SPEED/CLK (clock) .....	17	Bleeding fork legs.....	42
Display mode SPEED/LAP (lap time) .....	17	Cleaning the dust boots of the fork legs .....	42
Display mode SPEED/ODO (odometer) .....	18	Loosening the fork protector .....	43
Display mode SPEED/TR1 (trip master 1) .....	18	Positioning the fork protection .....	43
Display mode SPEED/TR2 (trip master 2) .....	18	Removing the fork legs.....	43
Display mode SPEED/A1 (average speed 1).....	19	Installing the fork legs 🛠️.....	44
Display mode SPEED/A2 (average speed 2).....	19	Removing the fork protector 🛠️.....	44
Display mode SPEED/S1 (stop watch 1) .....	19	Installing the fork protector 🛠️ .....	45
Display mode SPEED/S2 (stop watch 2) .....	19	Removing the lower triple clamp 🛠️ (XCF-W, EXC-F EU, EXC-F AUS) .....	45
Opening filler cap.....	20	Removing the lower triple clamp 🛠️ (EXC-F SIX DAYS) .....	45
Closing filler cap .....	21	Installing the lower triple clamp 🛠️ (XCF-W, EXC-F EU, EXC-F AUS) .....	46
Idle speed adjusting screw .....	21	Installing the lower triple clamp 🛠️ (EXC-F SIX DAYS) .....	48
Shift lever.....	21	Checking the steering head bearing play .....	49
Kick starter.....	22	Adjusting the play of the steering head bearing 🛠️ (XCF-W, EXC-F EU, EXC-F AUS) .....	50
Foot brake lever.....	22	Adjusting the play of the steering head bearing 🛠️ (EXC-F SIX DAYS) .....	50
Side stand .....	22	Greasing the steering head bearing 🛠️.....	50
Steering lock (All EXC-F models).....	22	Removing the shock absorber 🛠️.....	51
Locking the steering (All EXC-F models) .....	23		
Unlocking the steering (All EXC-F models) .....	23		
PREPARING FOR USE.....	24		
Advice on first use.....	24		

Installing the shock absorber 	51	Installing the battery 	79
Removing the front fender	51	Charging the battery 	79
Installing the front fender	51	Changing the main fuse	80
Removing the seat	52	Changing the fuses of individual power consumers	81
Mounting the seat	52	Changing the fuse of the radiator fan (EXC-F SIX DAYS)	82
Removing the air filter box lid	52	Removing headlight mask with headlight	83
Installing the air filter box lid	52	Refitting the headlight mask with the headlight	83
Removing the air filter 	52	Changing the headlight bulb	83
Installing the air filter 	53	Checking the headlight setting	84
Cleaning the air filter and air filter box 	53	Adjusting the headlight range	84
Removing main silencer	54	Changing the speedometer battery	84
Installing the main silencer	54	COOLING SYSTEM	86
Changing the glass fiber yarn filling of the main silencer 	54	Cooling system	86
Removing the fuel tank 	55	Checking the antifreeze and coolant level	86
Installing the fuel tank 	56	Checking the coolant level	87
Checking for chain dirt accumulation	57	Draining the coolant 	87
Cleaning the chain	57	Refilling coolant 	88
Checking the chain tension	58	TUNING THE ENGINE	89
Adjusting the chain tension	58	Checking the play in the throttle cable	89
Checking the chain, rear sprocket, engine sprocket and chain guide	59	Adjusting the play in the throttle cable 	89
Adjusting the chain guide 	61	Setting the engine characteristics (EXC-F SIX DAYS)	89
Checking the frame 	61	Adjusting the idle speed 	90
Checking the swingarm 	61	Checking the basic position of the shift lever	90
Checking the throttle cable routing	62	Adjusting the basic position of the shift lever 	91
Checking the rubber grip	62	SERVICE WORK ON THE ENGINE	92
Additionally securing the rubber grip	62	Checking the engine oil level	92
Adjusting the basic position of the clutch lever	62	Changing the engine oil and oil filter, cleaning the oil screens 	92
Checking the fluid level of the hydraulic clutch	63	Adding engine oil	94
Changing the hydraulic clutch fluid 	63	CLEANING, CARE	95
Removing the engine guard (EXC-F AUS, EXC-F SIX DAYS)	64	Cleaning the motorcycle	95
Installing the engine guard (EXC-F AUS, EXC-F SIX DAYS)	64	Checks and maintenance steps for winter operation	96
BRAKES	65	STORAGE	97
Checking free travel of hand brake lever	65	Storage	97
Adjusting the basic position of the hand brake lever (XCF-W)	65	Preparing for use after storage	97
Adjusting free travel of hand brake lever (All EXC-F models)	65	TROUBLESHOOTING	98
Checking the brake discs	66	BLINK CODE	100
Checking the front brake fluid level	66	TECHNICAL DATA - ENGINE	102
Adding front brake fluid 	66	Capacity - engine oil	102
Checking the front brake linings	67	Capacity - coolant	102
Changing the front brake linings 	67	TECHNICAL DATA - ENGINE TIGHTENING TORQUES	103
Checking the free travel of foot brake lever	69	TECHNICAL DATA - CHASSIS	105
Adjusting the basic position of the foot brake lever 	69	Lighting equipment	105
Checking the rear brake fluid level	70	Tires	106
Adding brake fluid to the rear brake circuit 	70	Capacity - fuel	106
Checking the rear brake linings	71	TECHNICAL DATA - FORK	107
Changing the rear brake linings 	72	TECHNICAL DATA - SHOCK ABSORBER	108
WHEELS, TIRES	74	TECHNICAL DATA - TIGHTENING TORQUES FOR CHASSIS	109
Removing the front wheel 	74	SUBSTANCES	110
Installing the front wheel 	74	AUXILIARY SUBSTANCES	112
Removing the rear wheel 	75	STANDARDS	114
Installing the rear wheel 	75	INDEX	115
Checking the tire condition	76		
Checking tire air pressure	77		
Checking spoke tension	77		
ELECTRICAL SYSTEM	79		
Removing the battery 	79		

## Symbols used

The symbols used are explained in the following.

- 
- |  |   |
|--|---|
|  | Indicates an expected reaction (e.g., to a work step or a function).  |
|  | Indicates an unexpected reaction (e.g., to a work step or a function).  |
|  | All work marked with this symbol requires specialist knowledge and technical understanding. In the interest of your own safety, have these jobs done in an authorized KTM workshop! There, your motorcycle will be serviced optimally by specially trained experts using the specialist tools required. |
|  | Identifies a page reference (more information is provided on the specified page).   |
- 

## Formats used

The typographical and other formats used are explained below.

- 
- |                          |   |
|--------------------------|---|
| <b>Proprietary name</b>  | Denotes a proprietary name.                   |
| <b>Name<sup>®</sup></b>  | Denotes a protected name.                     |
| <b>Brand<sup>™</sup></b> | Denotes a brand available on the open market. |
-

## Use definition (All EXC-F models)

KTM sport motorcycles are designed and built to withstand the normal stresses and strains of competitive use. The motorcycles comply with currently valid regulations and categories of the top international motorsport organizations.

### Info

The motorcycle is authorized for public road traffic in the homologous (reduced) version only. In the derestricted version, the motorcycle must be used only on closed off property remote from public road traffic. The motorcycle is designed for off-road sport endurance competition (Enduro) and not for the use predominantly in motocross.

## Use definition (XCF-W)

KTM sport motorcycles are designed and built to withstand the normal stresses and strains of competitive use. The motorcycles comply with currently valid regulations and categories of the top international motorsport organizations.

### Info

The motorcycle may only be used in closed off areas remote from public road traffic. This motorcycle is designed for use in offroad endurance competition (enduro) and not primarily for use in Motocross.

## Service

A prerequisite for perfect operation and prevention of premature wear is that the service, care and tuning work on the engine and chassis is properly carried out as described in the owner's manual. Poor adjustment and tuning of the engine and chassis can lead to damage and breakage of components.

Using the vehicle in difficult conditions such as on sand or very muddy or wet terrain can lead to above-average wear of components such as the drive train or the brakes. For this reason, it may be necessary to service or replace worn parts before the limit specified in the service schedule is reached.

Pay careful attention to the prescribed running-in period and service intervals. If you observe these exactly, you will ensure a much longer service life for your motorcycle.

## Warranty

The work prescribed in the service schedule must be carried out by an authorized KTM workshop only and confirmed in the customer's service record and in the **KTM dealer.net**; otherwise, all warranty claims will be void. No warranty claim can be honored for damage resulting from manipulation and/or other changes to the vehicle.

## Fuel, oils, etc.

You should use the fuels, oils and greases according to specifications as listed in the owner's manual.

## Spare parts, accessories

For your own safety, only use spare parts and accessory products that have been approved and/or recommended by KTM and have them installed by an authorized KTM workshop. KTM accepts no liability for other products and any resulting damage or loss. Some spare parts and accessories are specified in brackets in the respective descriptions. Your KTM dealer will be happy to advise you.

You will find the current **KTM PowerParts** for your vehicle on the KTM website.

International KTM Website: <http://www.ktm.com>

## Work rules

Special tools are necessary for some of the work. These are not included with the vehicle and can be ordered under the number in parentheses. Ex: valve spring compressor (59029019000)

During assembly, non-reusable parts (e.g. self-locking screws and nuts, seals and seal rings, O-rings, pins, lock washers) must be replaced by new parts.

If thread lock (e.g. **Loctite**<sup>®</sup>) is used for screw connections, be sure to comply with the manufacturer's specific instructions on its usage.

Parts that you want to reuse following repairs and servicing should be cleaned and checked for damage and wear. Change damaged or worn parts.

Ensure that the vehicle is safe to operate after completing repair and maintenance work.

## Transport

### Note

**Danger of damage** The parked vehicle may roll away or fall over.

- Always place the vehicle on a firm and even surface.

### Note

**Fire hazard** Some vehicle components become very hot when the vehicle is operated.

- Do not park the vehicle near flammable or explosive substances. Do not place objects on the vehicle while it is still warm from being run. Always let the vehicle cool first.
- 
- Switch off the engine.
  - Use straps or other suitable devices to secure the motorcycle against accidents or falling over.

## Environment

Motorcycling is a wonderful sport and we naturally hope that you can enjoy it to the full. However, it is a potential problem for the environment and can lead to conflicts with other persons. But if you use your motorcycle responsibly, you can ensure that such problems and conflicts do not have to occur. To protect the future of motorcycle sport, make sure that you use your motorcycle legally, display environmental consciousness, and respect the rights of others.

## Notes/warnings

Pay close attention to the notes/warnings.



### Info

Various information and warning labels are affixed to the vehicle. Do not remove information/warning labels. If they are missing, you or others may not recognize potential hazards and may therefore be injured.

## Grades of risks



### Danger

Identifies a danger that will immediately and invariably lead to fatal or serious permanent injury if the appropriate measures are not taken.



### Warning

Identifies a danger that is likely to lead to fatal or serious injury if the appropriate measures are not taken.



### Caution

Identifies a danger that may lead to minor injuries if the appropriate measures are not taken.

### Note

Identifies a danger that will lead to considerable machine and material damage if the appropriate measures are not taken.



### Warning

Identifies a danger that will lead to environmental damage if the appropriate measures are not taken.

## Owner's manual

- It is important that you read this owner's manual carefully and completely before making your first trip. It contains information and tips to help you operate and handle your motorcycle. Only then will you learn how to best adjust the motorcycle for your own use and how to protect yourself from injury. The owner's manual also contains important information on servicing the motorcycle.
- The owner's manual is an important component of the motorcycle and should be handed over to the new owner if the vehicle is sold.



## View of vehicle, front left (example)



- |   |                             |
|---|-----------------------------|
| 1 | Filler cap                  |
| 2 | Air filter box lid          |
| 3 | Fork compression adjustment |
| 4 | Shift lever (☛ p. 21)       |
| 5 | Engine number (☛ p. 9)      |
| 6 | Side stand (☛ p. 22)        |

## View of vehicle, rear right (example)

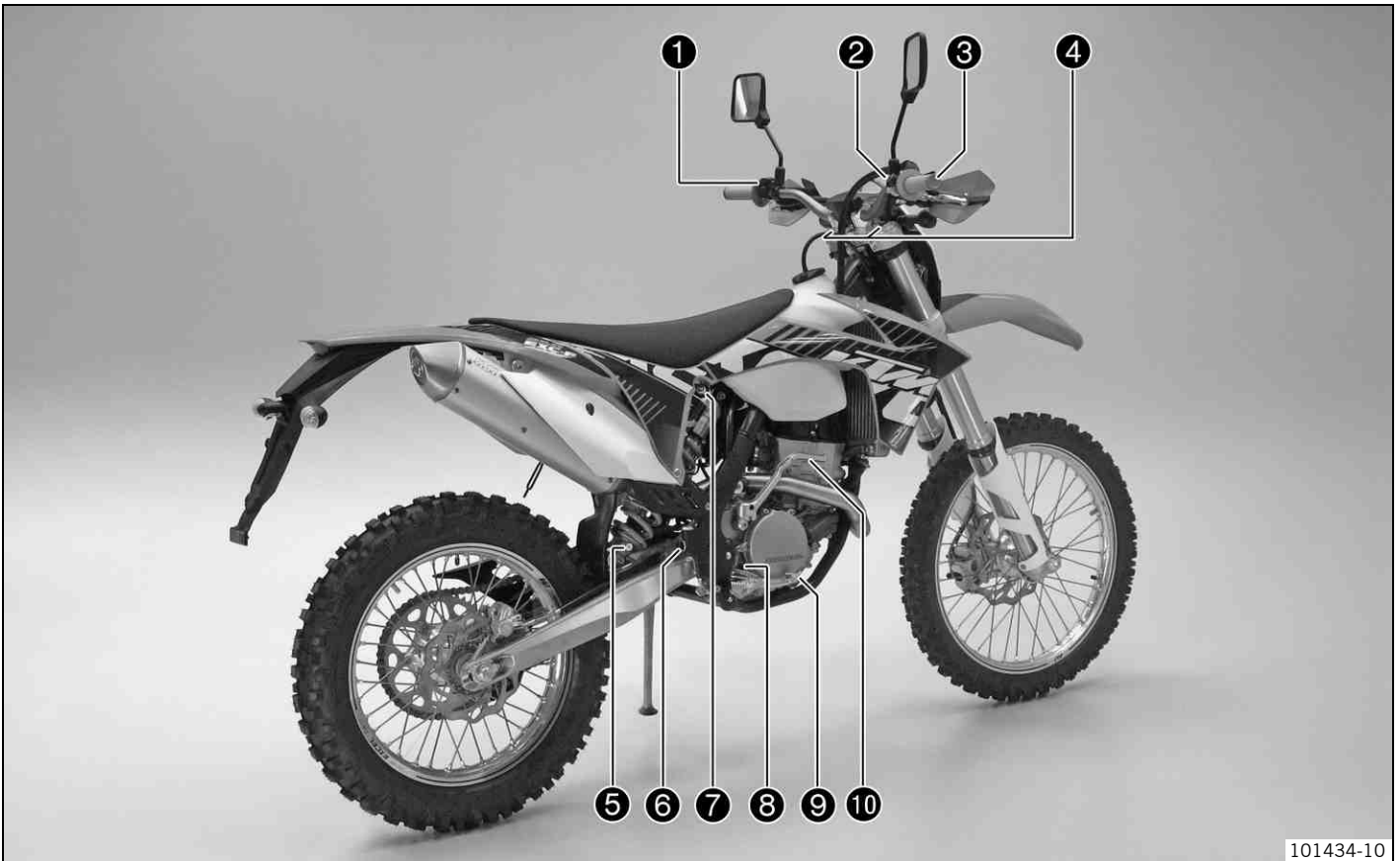

1	Kill switch (☛ p. 11)
1	Horn button (☛ p. 12)
1	Light switch (☛ p. 12)
1	Turn signal switch (☛ p. 12)
2	Emergency OFF switch (☛ p. 12)
2	Electric starter button (☛ p. 13)
3	Throttle grip (☛ p. 11)
4	Fork rebound adjustment and spring preload adjustment
5	Shock absorber rebound adjustment
6	Level viewer for brake fluid, rear
7	Shock absorber compression adjustment
8	Level viewer, engine oil
9	Foot brake lever (☛ p. 22)
10	Kick starter (☛ p. 22)

## Chassis number

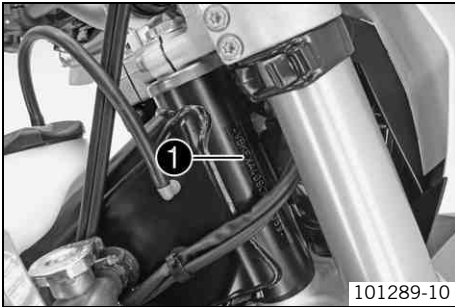

The chassis number ❶ is stamped on the steering head on the right.

## Type label

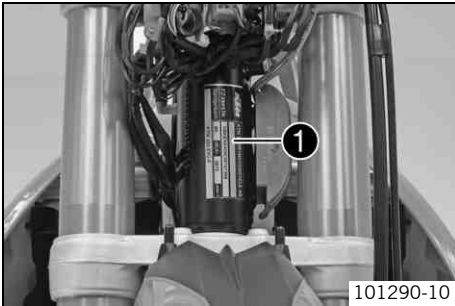

The type label ❶ is fixed to the front of the steering head.

## Key number (All EXC-F models)

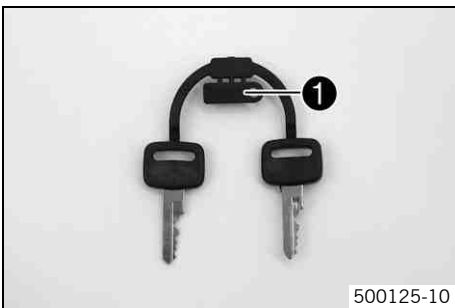

The key number ❶ is stamped on the key strap.

## Engine number

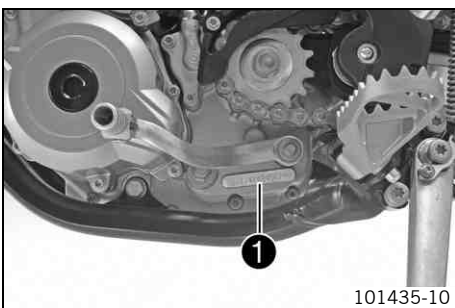

The engine number ❶ is stamped on the left side of the engine under the engine sprocket.

## Fork part number

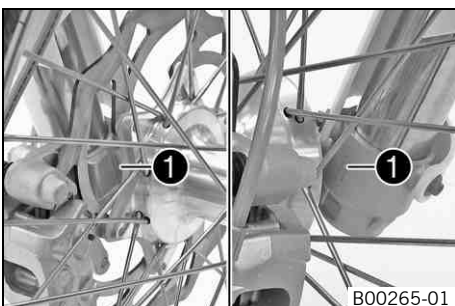

The fork part number ❶ is stamped on the inner side of the fork stub.

## Shock absorber part number

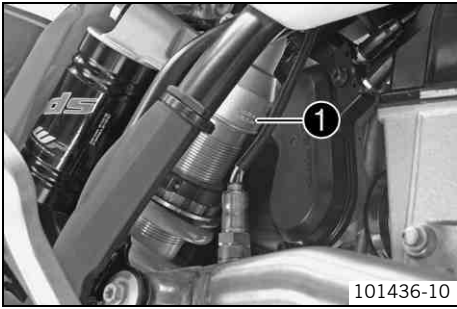

The shock absorber part number ❶ is stamped on the top of the shock absorber above the adjusting ring on the engine side.

101436-10

## Clutch lever

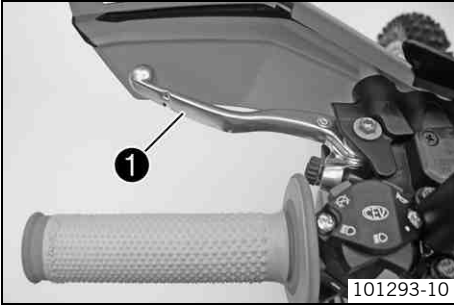

The clutch lever ❶ is fitted on the left side of the handlebar. The clutch is hydraulically operated and self-adjusting.

## Hand brake lever

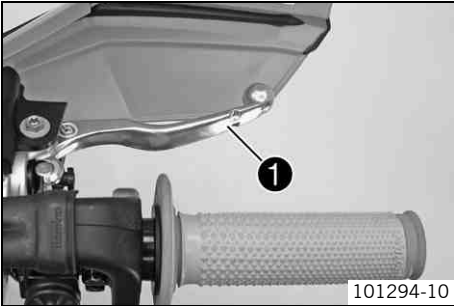

Hand brake lever ❶ is located on the right side of the handlebar. The hand brake lever is used to activate the front brake.

## Throttle grip

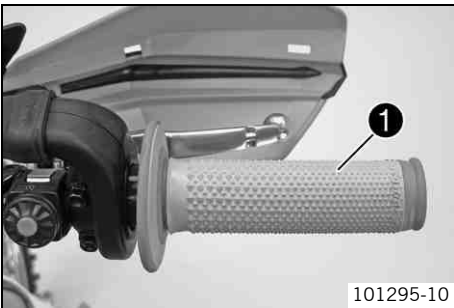

The throttle grip ❶ is fitted on the right side of the handlebar.

## Kill switch (XCF-W)

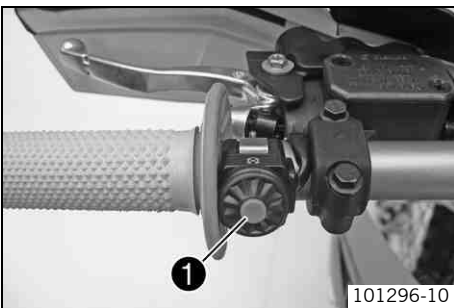

Kill switch ❶ is fitted on the left side of the handlebar.

### Possible states

- Kill switch ☒ in basic position – In this position, the ignition circuit is closed and the engine can be started.
- Kill switch ☒ pressed – In this position, the ignition circuit is interrupted, a running engine stops, and a non-running engine will not start.

## Kill switch (All EXC-F models)

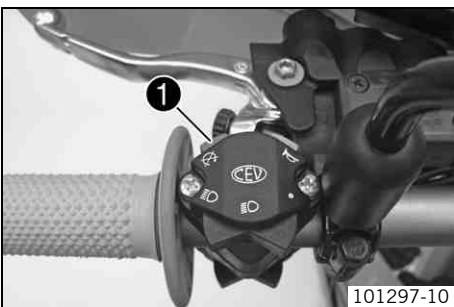

Kill switch ❶ is fitted on the left side of the handlebar.

### Possible states

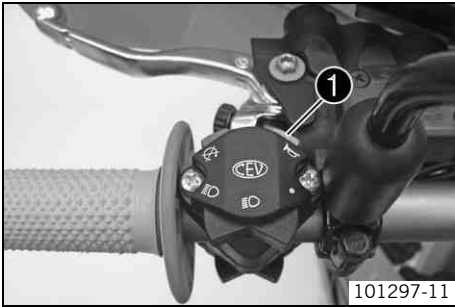

- Kill switch ☒ in basic position – In this position, the ignition circuit is closed and the engine can be started.
- Kill switch ☒ pressed – In this position, the ignition circuit is interrupted, a running engine stops, and a non-running engine will not start.

## Horn button (All EXC-F models)



The horn button ❶ is fitted on the left side of the handlebar.

**Possible states**

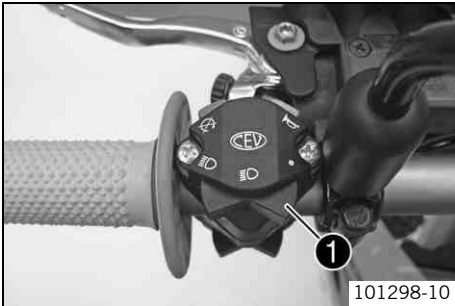

- Horn button  in neutral position
- Horn button  pressed – The horn is operated in this position.

## Light switch (All EXC-F models)



The light switch ❶ is fitted on the left side of the handlebar.

**Possible states**

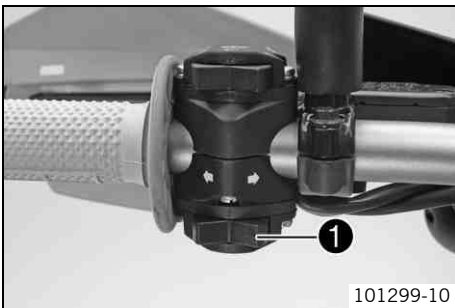

	Light off – Light switch is turned to the right. In this position, the light is switched off.
	Low beam on – Light switch is in the central position. In this position, the low beam and tail light are switched on.
	High beam on – Light switch is turned to the left. In this position, the high beam and the tail light are switched on.

## Turn signal switch (All EXC-F models)



Turn signal switch ❶ is fitted on the left side of the handlebar.

**Possible states**

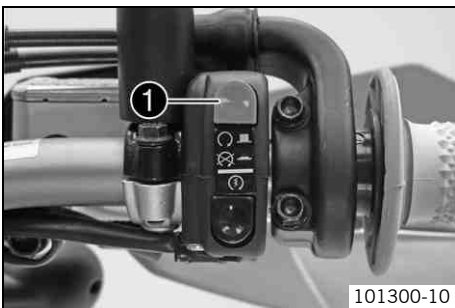

	Turn signal light off – Turn signal switch is in the central position.
	Turn signal light, left, on – Turn signal switch is turned to the left.
	Turn signal light, right, on – Turn signal switch is turned to the right.

## Emergency OFF switch (EXC-F AUS)



The emergency OFF switch ❶ is fitted on the right side of the handlebar.

**Possible states**



	Ignition off – In this position, the ignition circuit is interrupted, a running engine stops, and a non-running engine will not start.
	Ignition on – In this position, the ignition circuit is closed, and the engine can be started.

## Electric starter button (EXC-F AUS)



The electric starter button ❶ is fitted on the right side of the handlebar.

**Possible states**

- Electric starter button  in basic position
- Electric starter button  pressed – In this position, the electric starter is actuated.

## Electric starter button (XCF-W, EXC-F EU, EXC-F SIX DAYS)

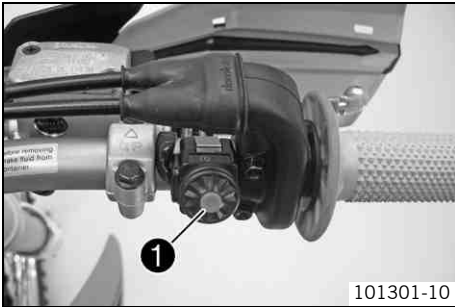

The electric starter button ❶ is fitted on the right side of the handlebar.

### Possible states

- Electric starter button ❶ in basic position
- Electric starter button ❶ pressed – In this position, the electric starter is actuated.

## Map-Select switch for the basic setting (EXC-F SIX DAYS)

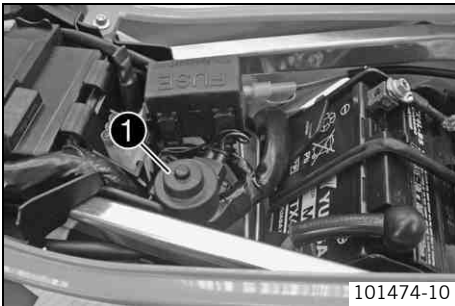

The **Map-Select** switch for the basic setting ❶ is fitted under the seat.

### Possible states

1	Soft – The mapping with reduced peak performance for better rideability is activated.
2	ADVANCED – The mapping for performance with a very direct response is activated.
3 - 9, 0	Standard – The mapping for performance with a balanced response is activated.

The **Map-Select** switch for the basic setting is used to make a preselection of the engine characteristics.

## Map-Select switch for vehicle operation (EXC-F SIX DAYS)



The **Map-Select** switch for vehicle operation ❶ is fitted on the right side of the handlebar.

### Possible states

I	Standard – STANDARD Mapping is always activated in this setting.
II	SOFT or ADVANCED – The mapping that is set on the <b>Map-Select</b> switch for the basic setting is activated in this setting.

The **Map-Select** switch for vehicle operation is used to change the engine characteristics on the handlebar. This change is activated when the engine is idling or after the motorcycle is restarted.

## Light switch (XCF-W)

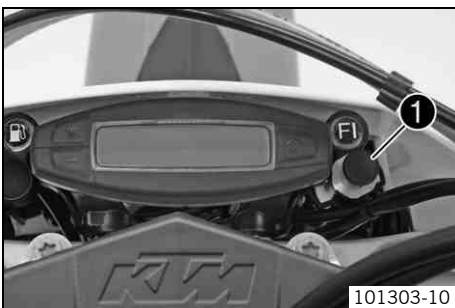

The light switch ❶ is on the right of the speedometer.

### Possible states

- Light off – Light switch is pressed in up to the stop. In this position, the light is switched off.
- Light on – Light switch is pulled out to the stop. In this position, the low beam and tail light are switched on.

## Overview of indicator lamps (XCF-W)



### Possible states

	<b>FI</b> warning lamp ( <b>MIL</b> ) lights up/flashes orange – The OBD has detected an emission- or safety-critical fault.
	The fuel level warning lamp lights up orange – The fuel level has reached the reserve mark.

## Overview of indicator lamps (All EXC-F models)



101304-01

### Possible states

	High beam indicator light lights up blue – High beam is switched on.
	<b>FI</b> warning lamp ( <b>MIL</b> ) lights up/flashes orange – The OBD has detected an emission- or safety-critical fault.
	The fuel level warning lamp lights up orange – The fuel level has reached the reserve mark.
	Turn signal indicator light flashes green – Turn signal is switched on.

## Speedometer

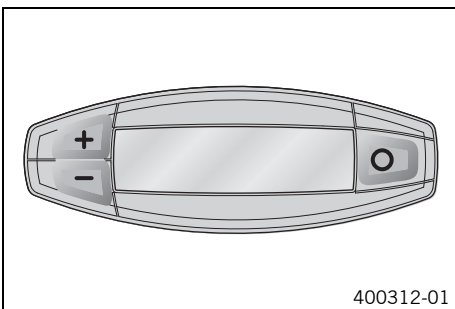

400312-01

- Press the button to change the display mode or change to one of the Setup menus.
- Press the button to control different functions.
- Press the button to control different functions.

**i Info**  
When the vehicle is delivered, only the **SPEED/H** and **SPEED/ODO** display modes are activated.

## Speedometer activation and test

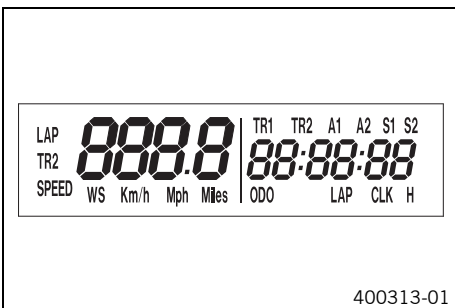

400313-01

### Activating the speedometer

The speedometer is activated when one of the buttons is pressed or an impulse comes from the wheel speed sensor.

### Display test

For the function test of the display, all display segments light up briefly.

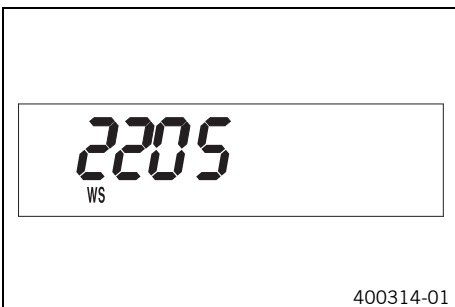

400314-01

### WS (wheel size)

After the display function test, the wheel size **WS** is displayed briefly.

**i Info**  
The number 2205 mm equals the circumference of the 21" front wheel with a series production tire.

The display then changes to the last selected mode.

## Tripmaster switch

### (Option: Tripmaster switch)

You can use the trip master switch to control the functions of the speedometer from the handlebar.

**i Info**  
The trip master is an optional accessory.



## Setting kilometers or miles



### Info

If you change the unit of measure, the **ODO** value is retained and converted accordingly. The values **TR1**, **TR2**, **A1**, **A2** and **S1** are cleared when the unit of measure is changed.

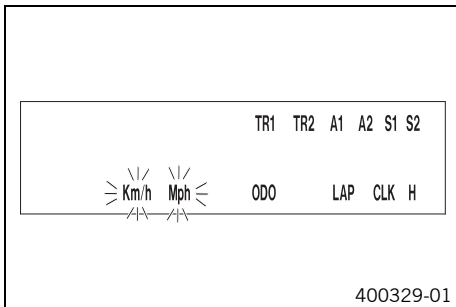

### Condition

The motorcycle is stationary.

- Press the button briefly and repeatedly until **H** appears at the bottom right of the display.
- Press the button for 3 - 5 seconds.
  - ✓ The Setup menu is displayed and the active functions are shown.
- Press the button repeatedly until the **Km/h/Mph** display flashes.

### Adjusting Km/h

- Press the button .

### Adjusting Mph

- Press the button .
- Press the button for 3 - 5 seconds.
  - ✓ The settings are stored and the Setup menu is closed.



### Info

If no button is pressed for 20 seconds, or if no impulse comes from the wheel speed sensor, the settings are automatically saved and the Setup menu is closed.

## Setting the clock

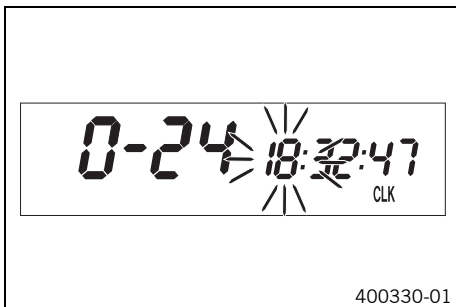

### Condition

The motorcycle is stationary.

- Press the button briefly and repeatedly until **CLK** appears at the bottom right of the display.
- Press the button for 3 - 5 seconds.
  - ✓ The hour display flashes.
- Set the hour display with the button and/or button .
- Press the button briefly.
  - ✓ The next segment of the display flashes and can be set.
- You can set the following segments in the same way as the hours by pressing the button and the button .



### Info

The seconds can only be set to zero.

- Press the button for 3 - 5 seconds.
  - ✓ The settings are stored and the Setup menu is closed.



### Info

If no button is pressed for 20 seconds, or if a pulse arrives from the wheel speed sensor, the settings are stored automatically and the Setup menu is closed.

## Adjusting the speedometer functions



### Info

When the vehicle is delivered, only the **SPEED/H** and **SPEED/ODO** display modes are activated.

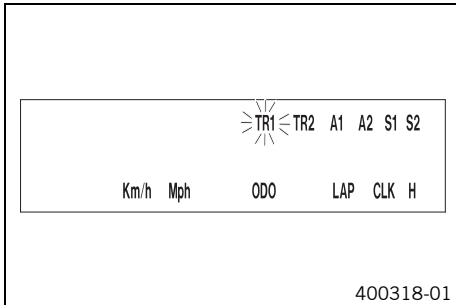

### Condition

The motorcycle is stationary.

- Press the button briefly and repeatedly until **H** appears at the bottom right of the display.
- Press the button for 3 - 5 seconds.
  - ✓ The Setup menu is displayed and the activated functions are shown.
- Change to the desired function by pressing the button briefly.
  - ✓ The selected function flashes.

### Activating a function

- Press the button .
- ✓ The symbol remains on the screen and the display changes to the next function.

### Deactivating the function

- Press the button .
- ✓ The symbol on the screen goes out and the display changes to the next function.
- All desired functions are activated or deactivated accordingly.
- Press the button for 3 - 5 seconds.
  - ✓ The settings are stored and the Setup menu is closed.



### Info

If no button is pressed for 20 seconds, or if a pulse arrives from the wheel speed sensor, the settings are stored automatically and the Setup menu is closed.

## Querying lap time



### Info

This function can be called up only if lap times are measured.

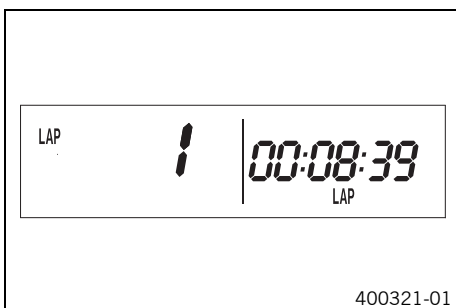

### Condition

The motorcycle is stationary.

- Press the button briefly and repeatedly until **LAP** appears at the bottom right of the display.
- Press the button briefly.
  - ✓ **LAP 1** appears on the left side of the display.
- Laps 1-10 can be displayed by pressing the button .
- The button has no function.
- Press the button briefly.
  - ✓ Next display mode



### Info

If an impulse is received from the wheel speed sensor, the left side of the display changes back to the **SPEED** mode.

## Display mode SPEED (speed)

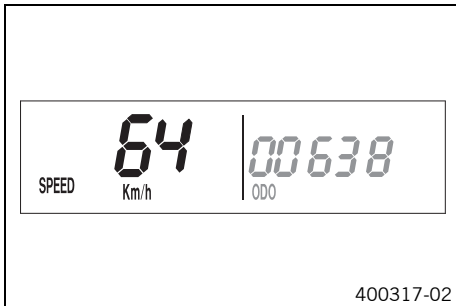

400317-02

- Press the button  briefly and repeatedly until **SPEED** appears on the left side of the display.

The current speed is displayed in the **SPEED** display mode.  
The current speed can be displayed in **Km/h** or **Mph**.

**i Info**  
Making the setting according to the country.  
When an impulse comes from the front wheel, the left side of the speedometer display changes to the **SPEED** mode and the current speed is shown.

## Display mode SPEED/H (operating hours)



400316-01





### Condition

- The motorcycle is stationary.

- Press the button  briefly and repeatedly until **H** appears at the bottom right of the display.

In display mode **H**, the operating hours of the engine are displayed.  
The operating hours counter stores the total traveling time.

**i Info**  
The operating hours counter is necessary for ensuring that maintenance work is carried out at the right intervals.  
If the speedometer is in **H** display mode at the start of the journey, it automatically changes to the **ODO** display mode.  
The **H** display mode is suppressed during the journey.

Press the button  .	No function
Press the button  .	No function
Press the button  for 3 - 5 seconds.	The display changes to the Setup menu of the speedometer functions.
Press the button  briefly.	Next display mode



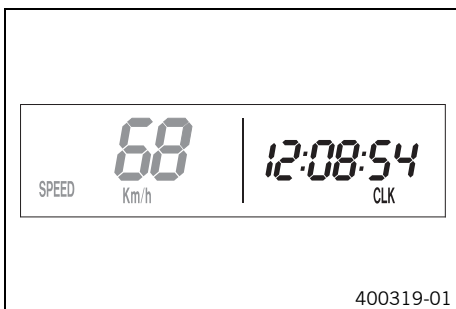

## Display mode SPEED/CLK (clock)



400319-01

- Press the button  briefly and repeatedly until **CLK** appears at the bottom right of the display.

The time is displayed in **CLK** display mode.

Press the button  .	No function
Press the button  .	No function
Press the button  for 3 - 5 seconds.	The display changes to the Setup menu of the clock.
Press the button  briefly.	Next display mode



## Display mode SPEED/LAP (lap time)







400320-01

- Press the button  briefly and repeatedly until **LAP** appears at the bottom right of the display.

In the **LAP** display mode, up to 10 lap times can be timed with the stop watch.

**i Info**  
If the lap time continues after you press the button , 9 memory locations are already occupied.  
Lap 10 must be timed with the button .

Press the button  .	Starts or stops the clock.
Press the button  .	Stops the current lap time and saves it, and the stop watch starts the next lap.
Press the button  for 3 - 5 seconds.	The stop watch and the lap time are reset.





Press the button  briefly.	Next display mode
---	-------------------

## Display mode SPEED/ODO (odometer)





- Press the button  briefly and repeatedly until **ODO** appears at the bottom right of the display.

The total distance traveled is displayed in the **ODO** display mode.

Press the button  .	No function
Press the button  .	No function
Press the button  for 3 - 5 seconds.	–
Press the button  briefly.	Next display mode

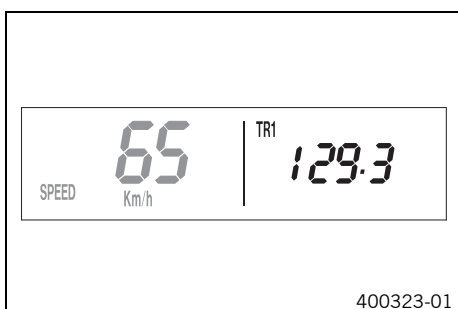
## Display mode SPEED/TR1 (trip master 1)







- Press the button  briefly and repeatedly until **TR1** appears at the top right of the display.

**TR1** (trip master 1) runs constantly and counts to 999.9.

You can use it to measure trips or the distance between refueling stops.

**TR1** is coupled with **A1** (average speed 1) and **S1** (stop watch 1).

**i Info**  
If 999.9 is exceeded, the values of **TR1**, **A1** and **S1** are automatically reset to 0.0.



Press the button  .	No function
Press the button  .	No function
Press the button  for 3 - 5 seconds.	The <b>TR1</b> , <b>A1</b> and <b>S1</b> displays are reset to 0.0.
Press the button  briefly.	Next display mode

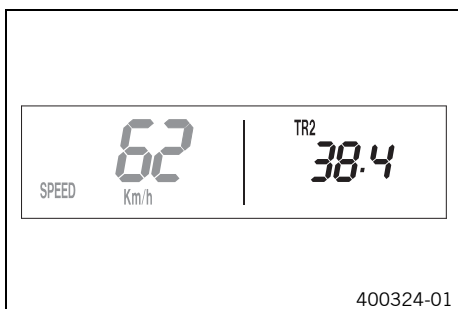

## Display mode SPEED/TR2 (trip master 2)







- Press the button  briefly and repeatedly until **TR2** appears at the top right of the display.

**TR2** (trip master 2) runs constantly and counts up to 999.9.

The displayed value can be set manually with the button  and the button . This is a very practical function when riding using the road book.

**i Info**  
The **TR2** value can also be corrected manually during the journey with the button  and the button .  
If 999.9 is exceeded, the value of **TR2** is automatically reset to 0.0.

Press the button  .	Increases value of <b>TR2</b> .
Press the button  .	Reduces value of <b>TR2</b> .
Press the button  for 3 - 5 seconds.	Deletes value of <b>TR2</b> .
Press the button  briefly.	Next display mode



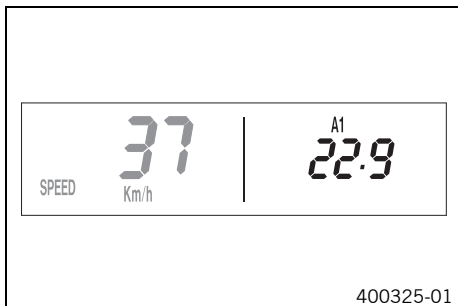

## Display mode SPEED/A1 (average speed 1)



- Press the button  briefly and repeatedly until **A1** appears at the top right of the display.

**A1** (average speed 1) shows the average speed calculated on the basis of **TR1** (trip master 1) and **S1** (stop watch 1).

The calculation of this value is activated by the first impulse of the wheel speed sensor and ends 3 seconds after the last impulse.

Press the button  .	No function
Press the button  .	No function
Press the button  for 3 - 5 seconds.	The <b>TR1</b> , <b>A1</b> and <b>S1</b> displays are reset to 0.0.
Press the button  briefly.	Next display mode





## Display mode SPEED/A2 (average speed 2)



- Press the button  briefly and repeatedly until **A2** appears at the top right of the display.

**A2** (average speed 2) shows the average speed on the basis of the current speed if the stop watch **S2** (stop watch 2) is running.

 **Info**  
The displayed value can differ from the actual average speed if **S2** was not timed after the ride.

Press the button  .	No function
Press the button  .	No function
Press the button  for 3 - 5 seconds.	–
Press the button  briefly.	Next display mode





## Display mode SPEED/S1 (stop watch 1)



- Press the button  briefly and repeatedly until **S1** appears at the top right of the display.

**S1** (stop watch 1) displays the journey time on the basis of **TR1** and continues when an impulse is received from the wheel speed sensor.

The calculation of this value starts with the first impulse of the wheel speed sensor and ends 3 seconds after the last impulse.

Press the button  .	No function
Press the button  .	No function
Press the button  for 3 - 5 seconds.	Displays of <b>TR1</b> , <b>A1</b> and <b>S1</b> are reset to 0.0.
Press the button  briefly.	Next display mode

## Display mode SPEED/S2 (stop watch 2)



- Press the button  briefly and repeatedly until **S2** appears at the top right of the display.

**S2** (stop watch 2) is a manual stop watch.

If **S2** is running in the background, the **S2** display flashes in the speedometer display.





Press the button  .	Starts or stops <b>S2</b> .
Press the button  .	No function
Press the button  for 3 - 5 seconds.	Displays of <b>S2</b> and <b>A2</b> are reset to 0.0.
Press the button  briefly.	Next display mode





Table of functions				
Display	Press the button  .	Press the button  .	Press the button  for 3 - 5 seconds.	Press the button  briefly.
Display mode <b>SPEED/H</b> (operating hours)	No function	No function	The display changes to the Setup menu of the speedometer functions.	Next display mode
Display mode <b>SPEED/CLK</b> (clock)	No function	No function	The display changes to the Setup menu of the clock.	Next display mode
Display mode <b>SPEED/LAP</b> (lap time)	Starts or stops the clock.	Stops the current lap time and saves it, and the stop watch starts the next lap.	The stop watch and the lap time are reset.	Next display mode
Display mode <b>SPEED/ODO</b> (odometer)	No function	No function	–	Next display mode
Display mode <b>SPEED/TR1</b> (trip master 1)	No function	No function	The <b>TR1</b> , <b>A1</b> and <b>S1</b> displays are reset to 0.0.	Next display mode
Display mode <b>SPEED/TR2</b> (trip master 2)	Increases value of <b>TR2</b> .	Reduces value of <b>TR2</b> .	Deletes value of <b>TR2</b> .	Next display mode
Display mode <b>SPEED/A1</b> (average speed 1)	No function	No function	The <b>TR1</b> , <b>A1</b> and <b>S1</b> displays are reset to 0.0.	Next display mode
Display mode <b>SPEED/A2</b> (average speed 2)	No function	No function	–	Next display mode
Display mode <b>SPEED/S1</b> (stop watch 1)	No function	No function	Displays of <b>TR1</b> , <b>A1</b> and <b>S1</b> are reset to 0.0.	Next display mode
Display mode <b>SPEED/S2</b> (stop watch 2)	Starts or stops <b>S2</b> .	No function	Displays of <b>S2</b> and <b>A2</b> are reset to 0.0.	Next display mode

Table of conditions and menu activation		
Display	The motorcycle is stationary.	Menu can be activated
Display mode <b>SPEED/H</b> (operating hours)	•	
Display mode <b>SPEED/CLK</b> (clock)		•
Display mode <b>SPEED/LAP</b> (lap time)		•
Display mode <b>SPEED/TR1</b> (trip master 1)		•
Display mode <b>SPEED/TR2</b> (trip master 2)		•
Display mode <b>SPEED/A1</b> (average speed 1)		•
Display mode <b>SPEED/A2</b> (average speed 2)		•
Display mode <b>SPEED/S1</b> (stop watch 1)		•
Display mode <b>SPEED/S2</b> (stop watch 2)		•

## Opening filler cap



### Danger

**Fire hazard** Fuel is highly flammable.

- Never refuel the vehicle near open flames or burning cigarettes, and always switch off the engine first. Be careful that no fuel is spilt, especially on hot vehicle components. Clean up spilt fuel immediately.
- Fuel in the fuel tank expands when warm and can escape if the tank is overfilled. See the notes on refueling.



### Warning

**Danger of poisoning** Fuel is poisonous and a health hazard.

- Avoid contact between fuel and skin, eyes and clothing. Do not inhale fuel vapors. If fuel gets into your eyes, rinse immediately with water and contact a doctor. Wash affected skin areas immediately with soap and water. If fuel is swallowed, contact a doctor immediately. Change clothing that has come into contact with fuel. Store fuel in a suitable canister according to regulations and keep it out of the reach of children.



### Warning

**Environmental hazard** Improper handling of fuel is a danger to the environment.

- Do not allow fuel to get into the ground water, the ground, or the sewage system.

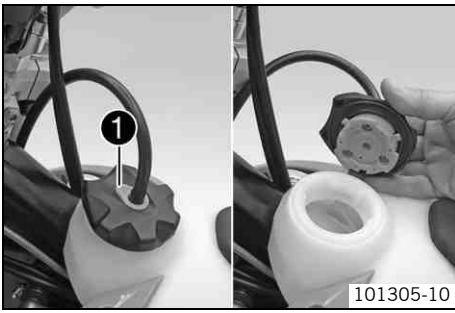

- Press release button ❶, turn filler cap counterclockwise and lift it upwards and remove.

## Closing filler cap

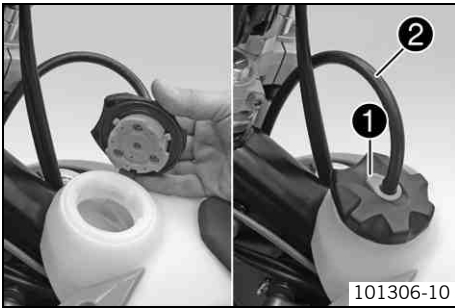

- Replace the filler cap and turn clockwise until the release button ❶ locks in place.



### Info

Route the fuel tank breather hose ❷ without kinking.

## Idle speed adjusting screw

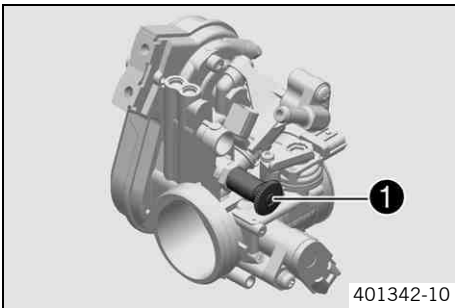

Idle speed adjusting screw ❶ is located on the throttle valve body at the top left. The idle speed adjusting screw has two functions. Turning it controls the idle speed. Pulling it out all the way raises the idle speed during a cold start.

### Possible states

- RPM increase activated – Idle speed adjusting screw is pulled out all the way.
- RPM increase deactivated – Idle speed adjusting screw is pushed in all the way.

## Shift lever

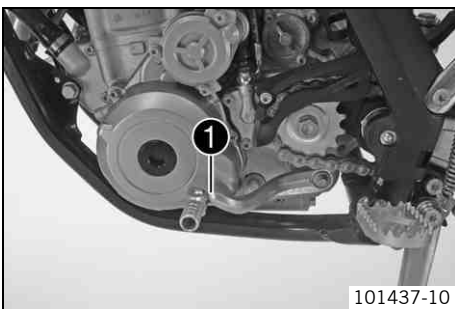

Shift lever ❶ is mounted on the left side of the engine.

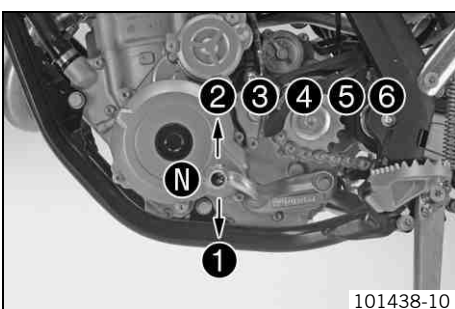

The gear positions can be seen in the photograph. The neutral or idle position is between the first and second gears.

## Kick starter

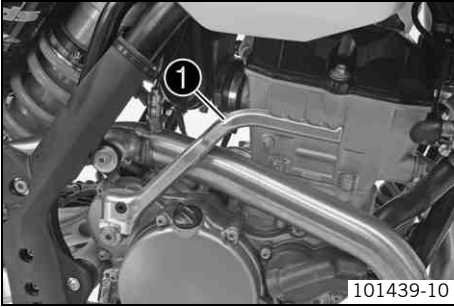

101439-10

The kick starter ❶ is fitted on the right of the engine. The engine can be started with either the kick starter or the electric starter. The upper part of the kick starter can be swung out.

**i** **Info**

Before riding, swing the upper part of the kick starter inwards towards the engine.

## Foot brake lever

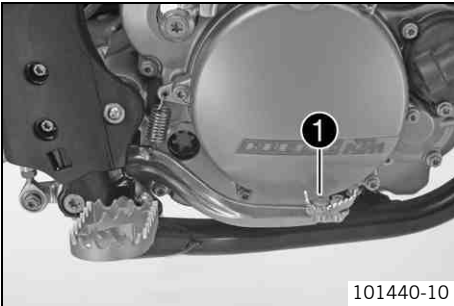

101440-10

Foot brake lever ❶ is located in front of the right footrest. The foot brake lever is used to activate the rear brake.

## Side stand

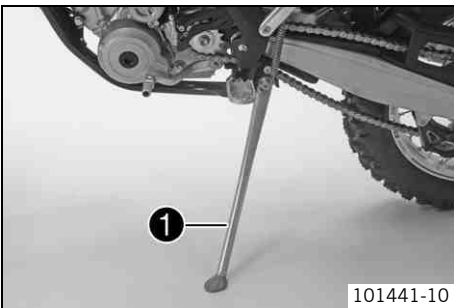

101441-10

The side stand ❶ is on the left side of the vehicle.

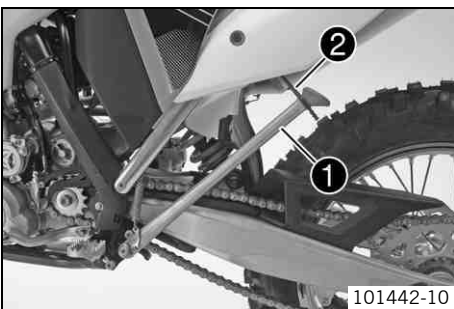

101442-10

The side stand is used to park the motorcycle.

**i** **Info**

When you are riding, the side stand ❶ must be folded up and secured with the rubber band ❷.

## Steering lock (All EXC-F models)

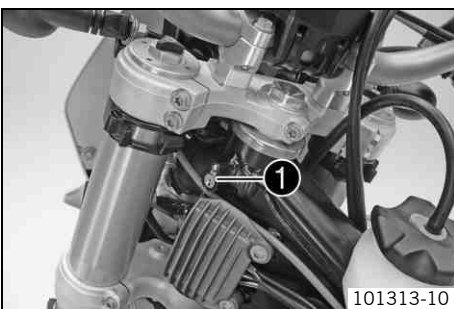

101313-10

Steering lock ❶ is fitted on the left side of the steering head. The steering lock is used to lock the steering. Steering, and therefore riding, is no longer possible.



## Locking the steering (All EXC-F models)

**Note**

**Danger of damage** The parked vehicle may roll away or fall over.

- Always place the vehicle on a firm and even surface.



- Park the vehicle.
- Turn the handlebar as far as possible to the right.
- Insert the key in the steering lock, turn it to the left, press it in and turn it to the right. Remove the key.
- ✓ Steering is no longer possible.



**Info**

Never leave the key in the steering lock.

## Unlocking the steering (All EXC-F models)

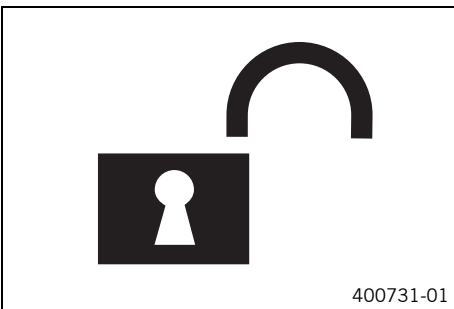

- Insert the key in the steering lock, turn it to the left, pull it out and turn it to the right. Remove the key.
- ✓ You can now steer the bike again.



**Info**

Never leave the key in the steering lock.

## Advice on first use



### Danger

**Danger of accidents** Danger arising from the rider's judgement being impaired.

- Do not operate the vehicle while under the influence of alcohol, drugs and certain medications or physically or mentally impaired.



### Warning

**Risk of injury** Missing or poor protective clothing present an increased safety risk.

- Wear protective clothing (helmet, boots, gloves, pants and jacket with protectors) every time you ride the vehicle. Always wear protective clothing, which must be undamaged and meet legal requirements.



### Warning

**Danger of crashing** Poor vehicle handling due to different tire tread patterns on front and rear wheels.

- The front and rear wheels must be fitted with tires with similar tread patterns to prevent loss of control over the vehicle.



### Warning

**Danger of accidents** Critical riding behavior due to inappropriate riding.

- Adapt your riding speed to the road conditions and your riding ability.



### Warning

**Danger of accidents** Accident risk caused by presence of a passenger.

- Your vehicle is not designed to carry passengers. Do not ride with a passenger.



### Warning

**Danger of accidents** Failure of brake system.

- If the foot brake lever is not released, the brake linings drag continuously. The rear brake may fail due to overheating. Take your foot off the foot brake lever when you are not braking.



### Warning

**Danger of accidents** Unstable riding behavior.

- Do not exceed the maximum permissible weight and axle loads.



### Warning

**Risk of misappropriation** Usage by unauthorized persons.

- Never leave the vehicle while the engine is running. Secure the vehicle against use by unauthorized persons.



### Info

When using your motorcycle, remember that others may feel disturbed by excessive noise.

- Make sure that the pre-delivery inspection work has been carried out by an authorized KTM workshop.
  - ✓ You receive a delivery certificate and the service record at vehicle handover.
- Before your first trip, read the entire operating instructions carefully.
- Get to know the controls.
- Adjust the basic position of the clutch lever. (☞ p. 62)

#### (XCF-W)

- Adjust the basic position of the hand brake lever. (☞ p. 65)

#### (All EXC-F models)

- Adjust the free travel of the hand brake lever. (☞ p. 65)
- Adjust the basic position of the foot brake lever. ☞ (☞ p. 69)
- Adjust the basic position of the shift lever. ☞ (☞ p. 91)
- Get used to handling the motorcycle on a suitable piece of land before making a longer trip.



### Info

Offroad, you should be accompanied by another person on another machine so that you can help each other.

- Try also to ride as slowly as possible and in a standing position to get a better feeling for the vehicle.
- Do not make any offroad trips that over-stress your ability and experience.

- Hold the handlebar firmly with both hands and keep your feet on the footrests when riding.
- If you carry any baggage, make sure it is fixed firmly as close as possible to the center of the vehicle and ensure even weight distribution between the front and rear wheels.



**Info**

Motorcycles react sensitively to any changes of weight distribution.

- Do not exceed the overall maximum permitted weight and the axle loads.

Guideline

Maximum permissible overall weight	335 kg (739 lb.)
Maximum permissible front axle load	145 kg (320 lb.)
Maximum permissible rear axle load	190 kg (419 lb.)

- Run the engine in.

## Running-in the engine

- During the running-in phase, do not exceed the specified engine speed and engine performance.

Guideline

Maximum engine speed	
During the first operating hour	7,000 rpm
Maximum engine performance	
During the first 3 operating hours	≤ 75 %

- Avoid fully opening the throttle!

## Preparing the vehicle for difficult riding conditions



**Info**

Using a motorcycle in difficult conditions can lead to excessive wear of components such as the power train or brakes. For this reason, it may be necessary to service or replace worn parts before the limit specified in the service schedule is reached.

- KTM recommends that you use the specified engine oil for difficult riding conditions and to increase performance.

Engine oil (SAE 10W/60) (00062010035) (☞ p. 110)
--

- Seal the air filter box. 🛠️



**Tip**

Seal the air filter box at the edges against dirt.

- Clean the air filter and air filter box. 🛠️ (☞ p. 53)



**Info**

Check the air filter approx. every 30 minutes.

- Additionally secure the rubber grip. (☞ p. 62)
- Check the electrical connector for humidity and corrosion and to ensure it is firmly seated.
  - » If humidity, corrosion or damage is found:
    - Clean and dry the connector, or change it if necessary.

**Difficult riding conditions are:**

- Rides on dry sand. (☞ p. 26)
- Rides on wet sand. (☞ p. 26)
- Rides on wet and muddy surfaces. (☞ p. 27)
- Rides at high temperature and slow speed. (☞ p. 27)
- Rides at low temperatures or in snow. (☞ p. 28)

## Preparing for rides on dry sand



- Check the radiator cap.

Value on radiator cap	1.8 bar (26 psi)
-----------------------	------------------

- » If the displayed value does meet specifications:



### Warning

**Danger of scalding** During motorcycle operation, the coolant gets very hot and is under pressure.

- Do not remove the radiator cap, radiator hoses or other cooling system components when the engine is hot. Allow the engine and cooling system to cool down. In case of scalding, rinse immediately with lukewarm water.

- Change the radiator cap.

- Fit a dust cover on the air filter.

Dust protection device for air filter (59006019000)
---



### Info

See the **KTM PowerParts** fitting instructions.



- Fit a sand cover on the air filter.

Sand protection device for air filter (59006022000)
---



### Info

See the **KTM PowerParts** fitting instructions.



- Adjust the carburetor jetting and the setting.



### Info

The specific carburetor tuning can be recommended by your authorized KTM workshop.

- Clean the chain.

Chain cleaner (☞ p. 112)
--------------------------

- Fit the steel sprocket.



### Tip

Do not grease the chain.



- Clean the radiator fins.
- Straighten bent radiator fins carefully.

## Preparing for rides on wet sand



- Check the radiator cap.

Value on radiator cap	1.8 bar (26 psi)
-----------------------	------------------

- » If the displayed value does meet specifications:



### Warning

**Danger of scalding** During motorcycle operation, the coolant gets very hot and is under pressure.

- Do not remove the radiator cap, radiator hoses or other cooling system components when the engine is hot. Allow the engine and cooling system to cool down. In case of scalding, rinse immediately with lukewarm water.



- Change the radiator cap.
- Fit a rain cover on the air filter.

Waterproofing device for air filter (59006021000)
---

**i Info**  
See the **KTM PowerParts** fitting instructions.

- Adjust the carburetor jetting and the setting.

**i Info**  
The specific carburetor tuning can be recommended by your authorized KTM workshop.



- Clean the chain.

Chain cleaner (☛ p. 112)
--------------------------

- Fit the steel sprocket.

**i Tip**  
Do not grease the chain.

- Clean the radiator fins.
- Straighten bent radiator fins carefully.

## Preparing for rides on wet and muddy surfaces



- Fit a waterproofing device on the air filter.

Waterproofing device for air filter (59006021000)
---

**i Info**  
See the **KTM PowerParts** fitting instructions.

- Adjust the carburetor jetting and setting.

**i Info**  
Recommendations on the carburetor setting are available from your authorized KTM workshop.



- Fit the steel sprocket.
- Clean the motorcycle. (☛ p. 95)
- Straighten bent radiator fins carefully.

## Preparing for rides at high temperature and slow speed



- Check the radiator cap.

Value on radiator cap	1.8 bar (26 psi)
-----------------------	------------------

» If the displayed value does meet specifications:

**! Warning**  
**Danger of scalding** During motorcycle operation, the coolant gets very hot and is under pressure.

- Do not remove the radiator cap, radiator hoses or other cooling system components when the engine is hot. Allow the engine and cooling system to cool down. In case of scalding, rinse immediately with lukewarm water.



600868-01

- Change the radiator cap.
- Adjust the secondary drive to the road conditions.



**Info**

The engine oil quickly gets hot if the clutch has to be operated very often due to an excessively high secondary drive.

- Clean the chain.

Chain cleaner (☛ p. 112)

- Clean the radiator fins.
- Straighten bent radiator fins carefully.
- Check the coolant level. (☛ p. 87)

## Preparing for rides at low temperatures or in snow



600870-01

- Fit a waterproofing device on the air filter.

Waterproofing device for air filter (59006021000)



**Info**

See the **KTM PowerParts** fitting instructions.

- Adjust the carburetor jetting and setting.



**Info**

Recommendations on the carburetor setting are available from your authorized KTM workshop.

## Checks and maintenance work when preparing for use



### Info

Before riding the vehicle, always check its condition and operating safety. The vehicle must be in perfect technical condition when used.

- Check the engine oil level. (☛ p. 92)
- Check the electrical system.
- Check the front brake fluid level. (☛ p. 66)
- Check the rear brake fluid level. (☛ p. 70)
- Check the front brake linings. (☛ p. 67)
- Check the rear brake linings. (☛ p. 71)
- Check that the brake system is functioning properly.
- Check the coolant level. (☛ p. 87)
- Check for chain dirt accumulation. (☛ p. 57)
- Check the chain, rear sprocket, engine sprocket and chain guide. (☛ p. 59)
- Check the chain tension. (☛ p. 58)
- Check the tire condition. (☛ p. 76)
- Check the tire air pressure. (☛ p. 77)
- Check the spoke tension. (☛ p. 77)
- Clean the dust boots of the fork legs. (☛ p. 42)
- Bleed fork legs. (☛ p. 42)
- Check the air filter.
- Check the settings of all controls and ensure that they can be operated smoothly.
- Check all screws, nuts, and hose clamps regularly for tightness.
- Check the fuel supply.

## Starting



### Danger

**Danger of poisoning** Exhaust gases are poisonous and inhaling them may result in unconsciousness and/or death.

- When running the engine, always make sure there is sufficient ventilation, and do not start or run the engine in an enclosed space without an effective exhaust extraction system.

### Note

**Engine failure** High engine speeds in cold engines have a negative effect on the service life of the engine.

- Always warm up the engine at low engine speeds.

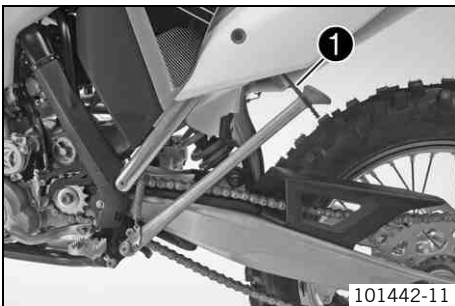

101442-11

- Raise the motorcycle off of the stand and secure the stand with the rubber band ❶.
- Shift transmission to neutral.

### (EXC-F AUS)

- Turn the emergency OFF switch to the position ❷.

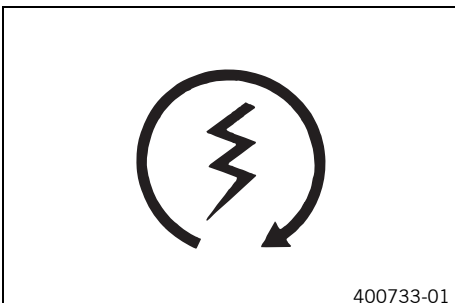

400733-01

- Press the electric starter button or press the kick starter robustly through its full range.



### Info

Press the electric starter button for at most 5 seconds. Wait for a least 5 seconds before trying again.

Warning lamp **FI** lights up briefly as a functional control when starting.

## Starting off



### Info

If your bike has lights, switch them on before riding. You will then be seen earlier by other motorists. When you are riding, the side stand must be folded up and secured with the rubber band.

- Pull the clutch lever, engage 1st gear, release the clutch lever slowly and simultaneously open the throttle carefully.

## Shifting, riding



### Warning

**Danger of accidents** If you change down at high engine speed, the rear wheel can lock up.

- Do not change into a low gear at high engine speed. The engine races and the rear wheel can lock up.



### Info

If you hear unusual noises while riding, stop immediately, switch off the engine, and contact an authorized KTM workshop. First gear is used for starting off or for steep inclines.

- When conditions allow (incline, road situation, etc.), you can shift into a higher gear. To do so, release the throttle while simultaneously pulling the clutch lever, shift into the next gear, release the clutch, and open the throttle.
- After reaching maximum speed by fully opening the throttle grip, turn the throttle back so it is  $\frac{3}{4}$  open. This will barely reduce the speed but fuel consumption will be considerably lower.
- Always open the throttle only as much as the engine can handle – abrupt throttle opening increases fuel consumption.
- To shift down, brake and close the throttle at the same time.
- Pull the clutch lever and shift into a lower gear, release the clutch lever slowly, and open the throttle or shift again.
- Switch off the engine if you expect to be standing for a long time.

Guideline

≥ 2 min

- Avoid frequent and longer slipping of the clutch. This heats the engine oil, the engine, and the cooling system.
- Ride with a lower engine speed instead of with a high engine speed and a slipping clutch.

## Braking



### Warning

**Danger of accidents** If you brake too hard, the wheels can lock.

- Adapt your braking to the traffic situation and the road conditions.



### Warning

**Danger of accidents** Reduced braking efficiency caused by spongy pressure point of front or rear brake.

- Check the brake system and do not continue riding. (Your authorized KTM workshop will be glad to help.)



### Warning

**Danger of accidents** Reduced braking efficiency due to wet or dirty brakes.

- Clean or dry dirty or wet brakes by riding and braking gently.

- On sandy, wet or slippery surfaces, use the rear brake.
- Braking should always be completed before you go into a bend. Change down to a lower gear appropriate to your road speed.
- On long downhill stretches, use the braking effect of the engine. Change down one or two gears, but do not overstress the engine. In this way, you have to brake far less and the brakes do not overheat.



## Stopping, parking



### Warning

**Risk of misappropriation** Usage by unauthorized persons.

- Never leave the vehicle while the engine is running. Secure the vehicle against use by unauthorized persons.



### Warning

**Danger of burns** Some vehicle components become very hot when the vehicle is operated.

- Do not touch hot components such as exhaust system, radiator, engine, shock absorber and brakes. Allow these components to cool down before starting work on them.

### Note

**Danger of damage** The parked vehicle may roll away or fall over.

- Always place the vehicle on a firm and even surface.

### Note

**Fire hazard** Some vehicle components become very hot when the vehicle is operated.

- Do not park the vehicle near flammable or explosive substances. Do not place objects on the vehicle while it is still warm from being run. Always let the vehicle cool first.

### Note

**Material damage** Damage and destruction of components by excessive load.

- The side stand is designed for the weight of the motorcycle only. Do not sit on the motorcycle when it is supported by the side stand only. The side stand and/or the frame could be damaged and the motorcycle could fall over.

- Brake the motorcycle.
- Shift transmission to neutral.

### (XCF-W)

- Press and hold the kill switch  while the engine is idling until the engine stops.

### (All EXC-F models)

- Press and hold the kill switch  while the engine is idling until the engine stops.
- Park the motorcycle on firm ground.

## Refueling



### Danger

**Fire hazard** Fuel is highly flammable.

- Never refuel the vehicle near open flames or burning cigarettes, and always switch off the engine first. Be careful that no fuel is spilt, especially on hot vehicle components. Clean up spilt fuel immediately.
- Fuel in the fuel tank expands when warm and can escape if the tank is overfilled. See the notes on refueling.



### Warning

**Danger of poisoning** Fuel is poisonous and a health hazard.

- Avoid contact of the fuel with skin, eyes and clothing. Do not inhale fuel vapors. If fuel gets into your eyes, rinse immediately with water and contact a doctor. Wash affected skin areas immediately with soap and water. If fuel is swallowed, contact a doctor immediately. Change clothing that has come into contact with fuel.



### Warning

**Environmental hazard** Improper handling of fuel is a danger to the environment.

- Do not allow fuel to get into the ground water, the ground, or the sewage system.

- Switch off engine.
- Open the filler cap. (🔧 p. 20)

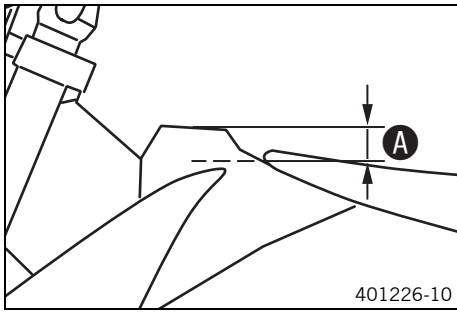

- Fill the fuel tank with fuel up to measurement **A**.

Guideline

Measurement of <b>A</b>	35 mm (1.38 in)	
Total fuel tank capacity, approx.	9.5 l (2.51 US gal)	Super unleaded (ROZ 95/RON 95/PON 91) (☛ p. 111)

- Close the filler cap. (☛ p. 21)

## Service schedule

	S1N	S15A	S30A
Read out the fault memory using the KTM diagnostics tool. 🛠️	•	•	•
Check that the electrical equipment is functioning properly.	•	•	•
Check and charge the battery. 🛠️		•	•
Change the engine oil and oil filter and clean the oil screens. 🛠️ (📖 p. 92)	•	•	•
Check the front brake linings. (📖 p. 67)		•	•
Check the rear brake linings. (📖 p. 71)		•	•
Check the brake discs. (📖 p. 66)		•	•
Check the brake lines for damage and leakage.		•	•
Check the rear brake fluid level. (📖 p. 70)		•	•
Check the free travel of the foot brake lever. (📖 p. 69)		•	•
Check the frame and swingarm. 🛠️		•	•
Check the swingarm bearing. 🛠️			•
Check the heim joints at the top and bottom of the shock absorber. 🛠️		•	•
Check the tire condition. (📖 p. 76)	•	•	•
Check the tire air pressure. (📖 p. 77)	•	•	•
Check the wheel bearing for play. 🛠️		•	•
Check the wheel hubs. 🛠️		•	•
Check the rim run-out. 🛠️	•	•	•
Check the spoke tension. (📖 p. 77)	•	•	•
Check the chain, rear sprocket, engine sprocket and chain guide. (📖 p. 59)		•	•
Check the chain tension. (📖 p. 58)	•	•	•
Grease all moving parts (e.g., side stand, hand lever, chain, ...) and check for smooth operation. 🛠️		•	•
Check the fluid level of the hydraulic clutch. (📖 p. 63)		•	•
Check the front brake fluid level. (📖 p. 66)		•	•
Check the free travel of the hand brake lever. (📖 p. 65)		•	•
Check the steering head bearing play. (📖 p. 49)	•	•	•
Check the valve clearance. 🛠️	•		•
Check the clutch. 🛠️			•
Check the fuel pressure. 🛠️		•	•
Check all hoses (e. g., fuel, cooling, bleeding, drainage) and sleeves for cracking, leaks, and incorrect routing. 🛠️	•	•	•
Check the antifreeze and coolant level. (📖 p. 86)	•	•	•
Check the cables for damage and routing without sharp bends. 🛠️		•	•
Check that the cables are undamaged, routed without sharp bends and set correctly.	•	•	•
Clean the air filter and air filter box. 🛠️		•	•
Change the glass fiber yarn filling of the main silencer. 🛠️ (📖 p. 54)			•
Check the screws and nuts for tightness. 🛠️	•	•	•
Check the headlight setting. (📖 p. 84)	•	•	•
Check idle. 🛠️	•	•	•
Check that the radiator fan is functioning properly. 🛠️ (EXC-F SIX DAYS)	•	•	•
Final check: Check the vehicle for roadworthiness and take a test ride.	•	•	•
Read out the fault memory using the KTM diagnostics tool after a test ride. 🛠️	•	•	•
Make the service entry in <b>KTM DEALER.NET</b> and in the service record. 🛠️	•	•	•

**S1N:** Once after 1 operating hour

**S15A:** Every 15 operating hours

**S30A:** Every 30 operating hours/after every race

## Service work (as additional order)

	S15N	S45A	S105A	J1A
Change the front brake fluid. 🛠️				•
Change the rear brake fluid. 🛠️				•
Change the foot brake cylinder seals. 🛠️ (XCF-W, EXC-F EU, EXC-F AUS)				•
Change the hydraulic clutch fluid. 🛠️ (🔧 p. 63)				•
Grease the steering head bearing. 🛠️ (🔧 p. 50)				•
Clean the spark arrestor. 🛠️ (XCF-W)				•
Perform a fork service. 🛠️	•	•		
Service the shock absorber. 🛠️		•		
Change the spark plug and spark plug connector. 🛠️			•	
Change the piston. 🛠️			•	
Check/measure the cylinder. 🛠️			•	
Check the cylinder head. 🛠️			•	
Check the valves, valve springs, and valve spring seats. 🛠️			•	
Check the camshaft and cam lever. 🛠️			•	
Change the connecting rod, conrod bearing and crank pin. 🛠️			•	
Check the transmission and shift mechanism. 🛠️			•	
Check the oil pressure regulator valve. 🛠️			•	
Check the oil pumps and lubrication system. 🛠️			•	
Check the timing assembly. 🛠️			•	
Change all engine bearings. 🛠️			•	

**S15N:** Once after 15 operating hours

**S45A:** Every 45 operating hours

**S105A:** Every 105 operating hours/every 50 operating hours when used for motorsports

**J1A:** Annually

## Checking the basic suspension setting against the rider's weight



### Info

When adjusting the basic suspension setting, first adjust the shock absorber and then the fork.

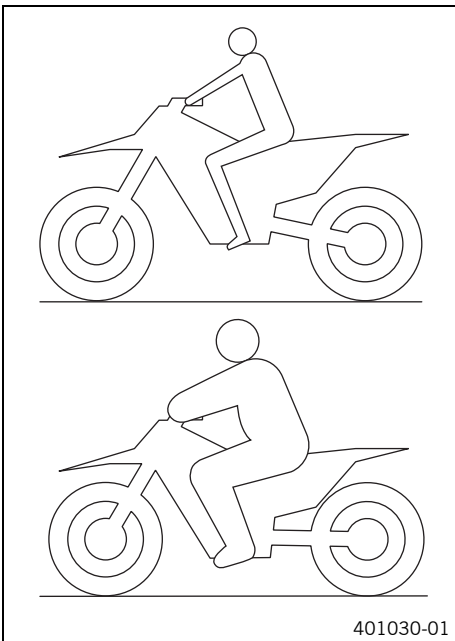

- For optimal motorcycle riding characteristics and to avoid damage to forks, shock absorbers, swingarm and frame, the basic settings of the suspension components must match the rider's weight.
- As delivered, KTM offroad motorcycles are adjusted for a standard rider weight (with full protective clothing).

### Guideline

Standard rider weight	75... 85 kg (165... 187 lb.)
-----------------------	------------------------------

- If the rider's weight is above or below the standard range, the basic setting of the suspension components must be adjusted accordingly.
- Small weight differences can be compensated by adjusting the spring preload, but in the case of large weight differences, the springs must be replaced.

## Compression damping of shock absorber

The compression damping of the shock absorber is divided into two ranges: high-speed and low-speed.

High-speed and low-speed refer to the compression speed of the rear wheel suspension and not to the vehicle speed.

The high-speed setting, for example, has an effect on the landing after a jump: the rear wheel suspension compresses more quickly.

The low-speed setting, for example, has an effect when riding over long ground swells: the rear wheel suspension compresses more slowly.

These two ranges can be adjusted separately, although the transition between high-speed and low-speed is gradual. Thus, changes in the high-speed range affect the compression damping in the low-speed range and vice versa.

## Adjusting the low-speed compression damping of the shock absorber



### Caution

**Danger of accidents** Disassembly of pressurized parts can lead to injury.

- The shock absorber is filled with high density nitrogen. Adhere to the description provided. (Your authorized KTM workshop will be glad to help.)



### Info

The low-speed setting can be seen during the slow to normal compression of the shock absorber.

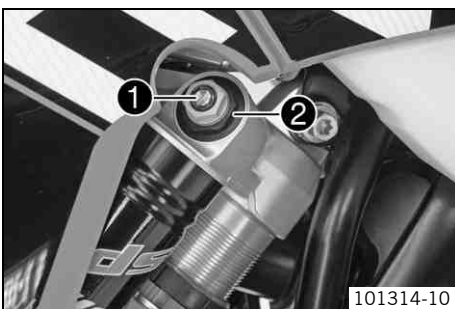

- Turn adjusting screw ❶ clockwise with a screwdriver up to the last perceptible click.



### Info

Do not loosen nut ❷!

- Turn back counterclockwise by the number of clicks corresponding to the shock absorber type.

### Guideline

Compression damping, low-speed	
Comfort	25 clicks
Standard	20 clicks
Sport	15 clicks
Full payload	15 clicks

**i Info**  
Turn clockwise to increase damping; turn counterclockwise to reduce damping.

## Adjusting the high-speed compression damping of the shock absorber

**⚠ Caution**  
**Danger of accidents** Disassembly of pressurized parts can lead to injury.

- The shock absorber is filled with high density nitrogen. Adhere to the description provided. (Your authorized KTM workshop will be glad to help.)

**i Info**  
The high-speed setting can be seen during the fast compression of the shock absorber.

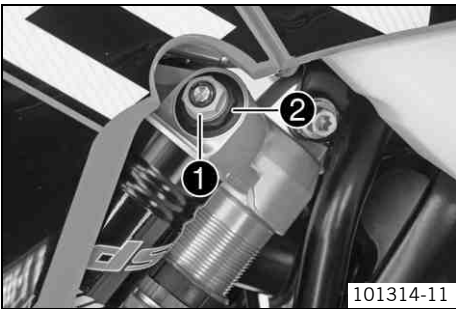

- Turn adjusting screw ❶ all the way clockwise with a socket wrench.

**i Info**  
Do not loosen nut ❷!

- Turn back counterclockwise by the number of turns corresponding to the shock absorber type.

Guideline

Compression damping, high-speed	
Comfort	2 turns
Standard	1.5 turns
Sport	1.25 turns
Full payload	1.25 turns

**i Info**  
Turn clockwise to increase damping; turn counterclockwise to reduce damping.

## Adjusting the rebound damping of the shock absorber

**⚠ Caution**  
**Danger of accidents** Disassembly of pressurized parts can lead to injury.

- The shock absorber is filled with high density nitrogen. Adhere to the description provided. (Your authorized KTM workshop will be glad to help.)

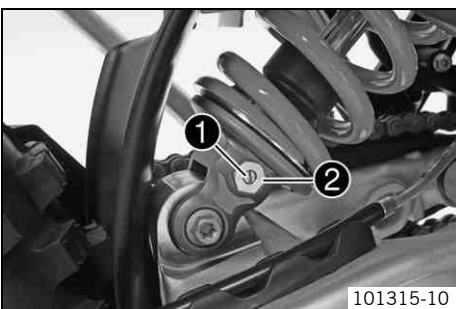

- Turn adjusting screw ❶ clockwise up to the last perceptible click.

**i Info**  
Do not loosen nut ❷!

- Turn back counterclockwise by the number of clicks corresponding to the shock absorber type.

Guideline

Rebound damping	
Comfort	28 clicks
Standard	24 clicks
Sport	22 clicks
Full payload	22 clicks

**i Info**  
Turn clockwise to increase damping; turn counterclockwise to reduce damping.

## Measuring rear wheel sag unloaded

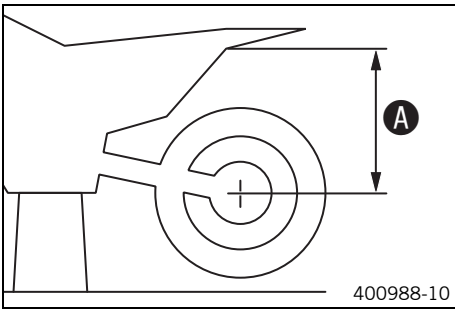

- Raise the motorcycle with the lift stand. (🔧 p. 42)
- Measure the distance – as vertically as possible – between the rear axle and a fixed point, such as a mark on the side cover.
- Make note of the value as measurement **A**.
- Remove the motorcycle from the lift stand. (🔧 p. 42)

## Checking the static sag of the shock absorber

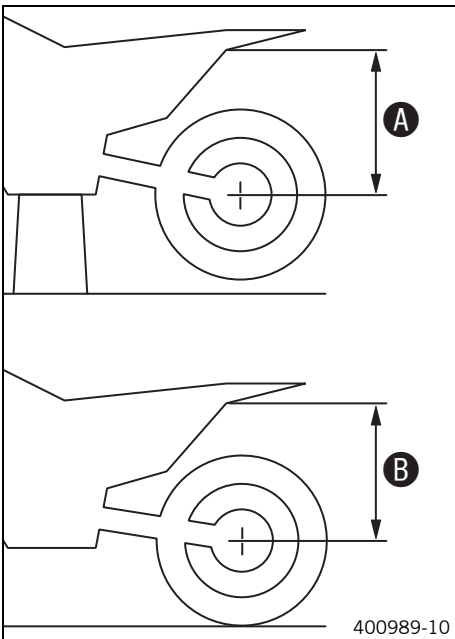

- Measure distance **A** of rear wheel unloaded. (🔧 p. 37)
- Hold the motorcycle upright with the aid of an assistant.
- Measure the distance between the rear axle and the fixed point again.
- Note down the value as dimension **B**.



### Info

The static sag is the difference between measurements **A** and **B**.

- Check the static sag.

Static sag	33... 35 mm (1.3... 1.38 in)
------------	------------------------------

- » If the static sag is less or more than the specified value:
  - Adjust the spring preload of the shock absorber. 🛠️ (🔧 p. 38)

## Checking the riding sag of the shock absorber

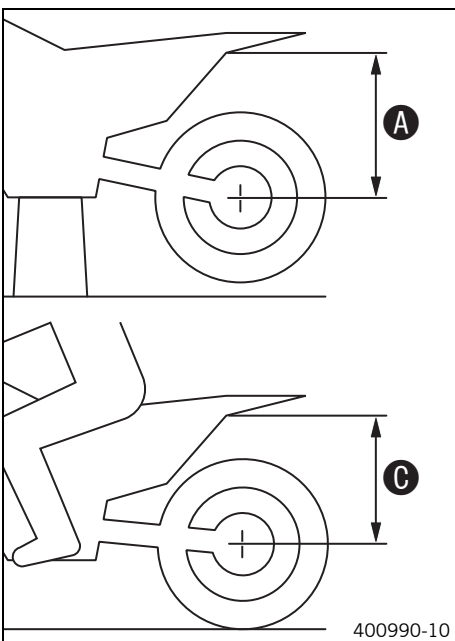

- Measure distance **A** of rear wheel unloaded. (🔧 p. 37)
- With another person holding the motorcycle, the rider, wearing full protective clothing, sits on the seat in a normal sitting position (feet on footrests) and bounces up and down a few times.
  - ✓ The rear wheel suspension levels out.
- Another person now measures the distance between the rear axle and a fixed point.
- Note down the value as dimension **C**.



### Info

The riding sag is the difference between measurements **A** and **C**.

- Check the riding sag.

Riding sag	105... 115 mm (4.13... 4.53 in)
------------	---------------------------------

- » If the riding sag differs from the specified measurement:
  - Adjust the riding sag. 🛠️ (🔧 p. 38)

## Adjusting the spring preload of the shock absorber 🛠️

**Caution**  
**Danger of accidents** Disassembly of pressurized parts can lead to injury.

- The shock absorber is filled with high density nitrogen. Adhere to the description provided. (Your authorized KTM workshop will be glad to help.)

**Info**  
 Before changing the spring preload, make a note of the present setting, e.g., by measuring the length of the spring.

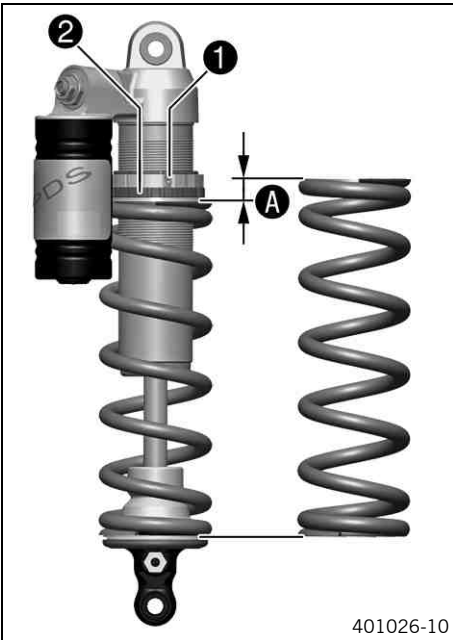

401026-10

- Remove shock absorber. 🛠️ (☞ p. 51)
- After removing the shock absorber, clean it thoroughly.
- Loosen screw ❶.
- Turn adjusting ring ❷ until the spring is no longer under tension.

Combination wrench (50329080000)
Hook wrench (T106S)

- Measure the overall spring length while the spring is not under tension.
- Tighten the spring by turning adjusting ring ❷ to measurement ❸.

Guideline

Spring preload	
Comfort	7 mm (0.28 in)
Standard	7 mm (0.28 in)
Sport	7 mm (0.28 in)
Full payload	8 mm (0.31 in)

**Info**  
 Depending on the static sag and/or the riding sag, it may be necessary to increase or decrease the spring preload.

- Tighten screw ❶.

Guideline

Screw, shock absorber adjusting ring	M5	5 Nm (3.7 lbf ft)
--------------------------------------	----	-------------------

- Install the shock absorber. 🛠️ (☞ p. 51)

## Adjusting the riding sag 🛠️

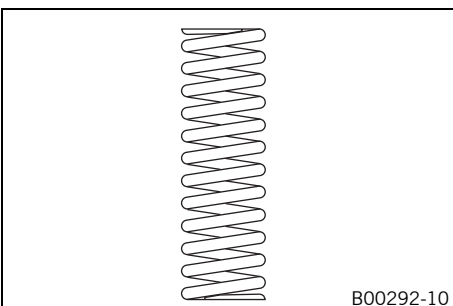

B00292-10

- Remove shock absorber. 🛠️ (☞ p. 51)
- After removing the shock absorber, clean it thoroughly.
- Choose and mount a suitable spring.

Guideline

Spring rate	
Weight of rider: 65... 75 kg (143... 165 lb.)	66 N/mm (377 lb/in)
Weight of rider: 75... 85 kg (165... 187 lb.)	69 N/mm (394 lb/in)
Weight of rider: 85... 95 kg (187... 209 lb.)	72 N/mm (411 lb/in)

**Info**  
 The spring rate is shown on the outside of the spring. Smaller weight differences can be compensated by changing the spring preload.

- Install the shock absorber. 🛠️ (☞ p. 51)
- Check the static sag of the shock absorber. (☞ p. 37)
- Check the riding sag of the shock absorber. (☞ p. 37)
- Adjust the rebound damping of the shock absorber. (☞ p. 36)



## Checking basic setting of fork

**i Info**  
For various reasons, no exact riding sag can be determined for the forks.

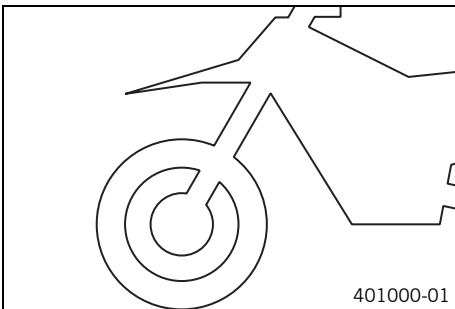

- As with the shock absorber, smaller differences in the rider's weight can be compensated by the spring preload.
- However, if the fork is often overloaded (hard end stop on compression), harder springs must be fit to avoid damage to the fork and frame.

## Adjusting the compression damping of the fork

**i Info**  
The hydraulic compression damping determines the fork suspension behavior.

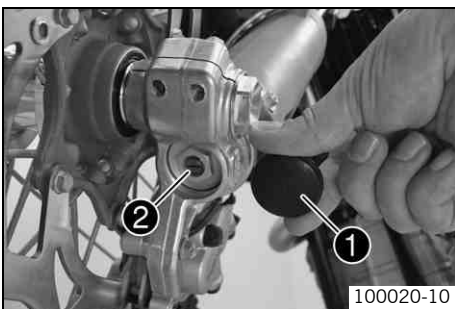

- Remove protection caps ❶.
- Turn adjusting screws ❷ clockwise all the way.

**i Info**  
Adjusting screws ❷ are located at the bottom end of the fork legs. Make the same adjustment on both fork legs.

- Turn back counterclockwise by the number of clicks corresponding to the fork type. Guideline

Compression damping	
Comfort	24 clicks
Standard	22 clicks
Sport	20 clicks
Full payload	20 clicks

**i Info**  
Turn clockwise to increase damping; turn counterclockwise to reduce damping.

- Mount protection covers ❶.

## Adjusting the rebound damping of the fork

**i Info**  
The hydraulic rebound damping determines the fork suspension behavior.

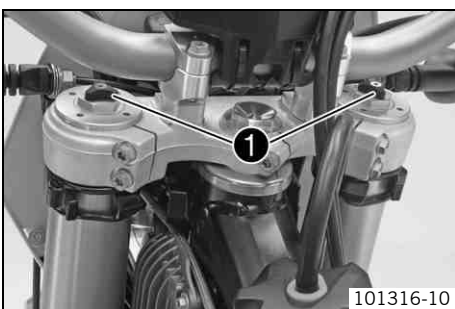

- Turn adjusting screws ❶ clockwise all the way.

**i Info**  
Adjusting screws ❶ are located at the top end of the fork legs. Make the same adjustment on both fork legs.

- Turn back counterclockwise by the number of clicks corresponding to the fork type. Guideline

Rebound damping	
Comfort	22 clicks
Standard	20 clicks
Sport	18 clicks
Full payload	18 clicks

**i Info**  
Turn clockwise to increase damping; turn counterclockwise to reduce damping.

## Adjusting the spring preload of the fork

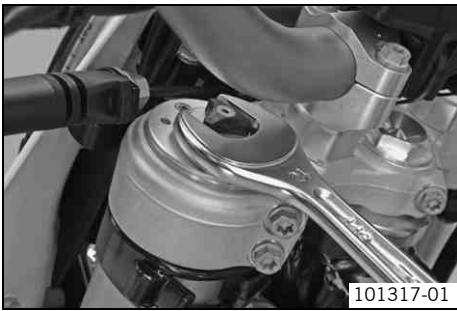

- Turn the adjusting screws counterclockwise all the way.

**i Info**  
Make the same adjustment on both fork legs.

- Turn back clockwise by the number of turns corresponding to the fork type.

Guideline

Spring preload - Preload Adjuster	
Comfort	1 turn
Standard	2 turns
Sport	2 turns
Full payload	4 turns

**i Info**  
Turn clockwise to increase spring preload; turn counterclockwise to reduce spring preload.  
Adjusting the spring preload has no influence on the absorption setting of the rebound damping.  
Basically, however, you should set the rebound damping higher with a higher spring preload.

## Handlebar position

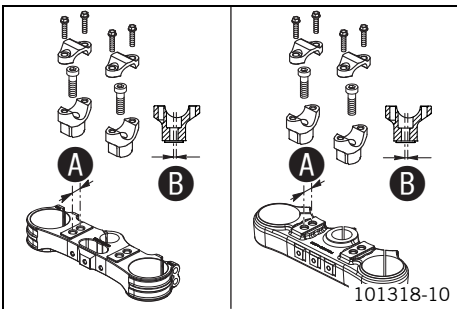

On the upper triple clamp, there are two holes at a distance of **A** to each other.

Hole distance <b>A</b>	15 mm (0.59 in)
------------------------	-----------------

The holes on the handlebar supports are placed at a distance of **B** from the center.

Hole distance <b>B</b>	3.5 mm (0.138 in)
------------------------	-------------------

The handlebar supports can be mounted in four different positions.

## Adjusting handlebar position

**Warning**  
**Danger of accidents** Handlebar breakage.

- If the handlebar is bent or straightened it will cause material fatigue, and the handlebar can break. Always replace handlebar.

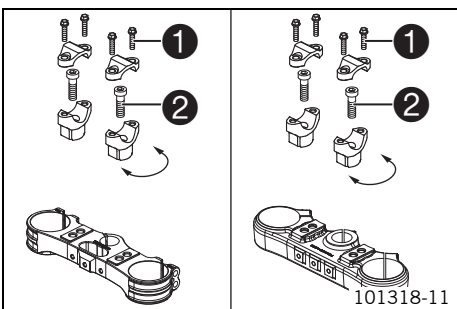

- Remove the four screws **1**. Remove the handlebar clamps. Remove the handlebar and lay it to one side.

**i Info**  
Protect the motorcycle and its attachments against damage by covering them.  
Do not bend the cables and lines.

- Remove the two screws **2**. Remove the handlebar support.
- Place the handlebar support in the required position. Fit and tighten the two screws **2**.

Guideline

Screw, handlebar support	M10	40 Nm (29.5 lbf ft)	Loctite® 243™
--------------------------	-----	------------------------	---------------



**Info**

Position the left and right handlebar supports evenly.

- Position the handlebars.



**Info**

Make sure cables and wiring are positioned correctly.

- Position the handlebar clamps. Fit and evenly tighten the four screws ①.

Guideline

Screw, handlebar clamp	M8	20 Nm (14.8 lbf ft)
------------------------	----	------------------------



**Info**

Make sure the gap width is even.

## Raising the motorcycle with the lift stand

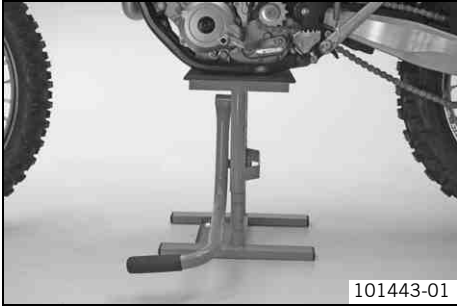

**Note**

**Danger of damage** The parked vehicle may roll away or fall over.

- Always place the vehicle on a firm and even surface.

- Raise the motorcycle at the frame underneath the engine.

Lift stand (54829055000)

- ✓ The wheels should no longer touch the ground.
- Secure the motorcycle against falling over.

## Removing the motorcycle from the lift stand

**Note**

**Danger of damage** The parked vehicle may roll away or fall over.

- Always place the vehicle on a firm and even surface.

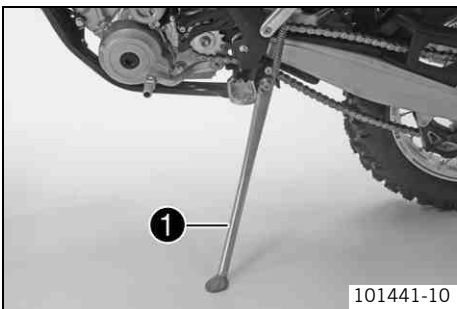

- Remove the motorcycle from the lift stand.
- Remove the lift stand.
- To park the motorcycle, press the side stand ❶ to the ground with your foot and lean the motorcycle on it.

**i Info**

When you are riding, the side stand must be folded up and secured with the rubber band.

## Bleeding fork legs

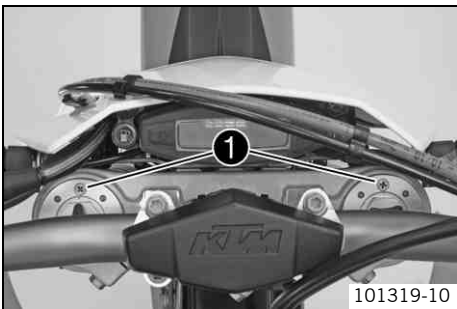

- Raise the motorcycle with the lift stand. (☞ p. 42)
- Remove bleeder screws ❶ briefly.
- ✓ Any excess pressure escapes from the interior of the fork.
- Mount and tighten bleeder screws.
- Remove the motorcycle from the lift stand. (☞ p. 42)

## Cleaning the dust boots of the fork legs



- Raise the motorcycle with the lift stand. (☞ p. 42)
- Loosen the fork protector. (☞ p. 43)
- Push dust boots ❶ of both fork legs downwards.

**i Info**

The dust boots should remove dust and coarse dirt particles from the fork tubes. Over time, there is an ingress of dirt inside the boots. If this dirt is not removed, it may cause the oil seals to leak.

**! Warning**

**Danger of accidents** Reduced braking efficiency due to oil or grease on the brake discs.

- Always keep the brake discs free of oil and grease, and clean them with brake cleaner when necessary.

- Clean and oil the dust boots and inner fork tube of both fork legs.

Universal oil spray (☞ p. 113)

- Press the dust boots back into their normal position.
- Remove excess oil.
- Position the fork protection. (☛ p. 43)
- Remove the motorcycle from the lift stand. (☛ p. 42)

## Loosening the fork protector

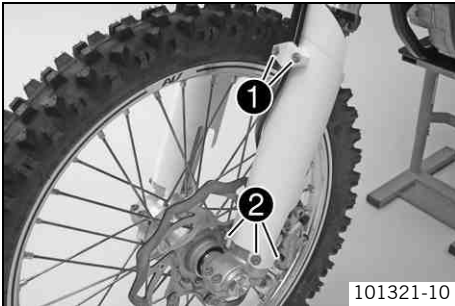

- Remove screws ❶ and remove the clamp.
- Remove screws ❷ on the left fork leg. Push the fork protector downwards.
- Remove the screws on the right fork leg. Push the fork protector downwards.

## Positioning the fork protection

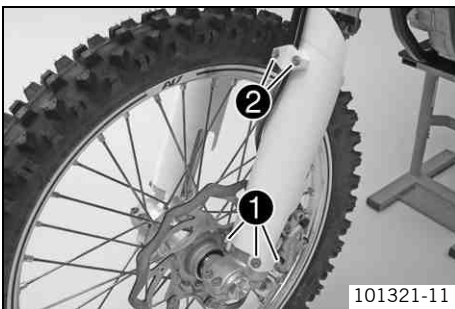

- Position the fork protection on the left fork leg. Mount and tighten screws ❶.

### Guideline

Remaining screws, chassis	M6	10 Nm (7.4 lbf ft)
---------------------------	----	--------------------

- Position the wiring harness.
- Position the brake line. Put the clamp on, mount and tighten screws ❷.
- Position the fork protection on the right fork leg. Mount and tighten the screws.

### Guideline

Remaining screws, chassis	M6	10 Nm (7.4 lbf ft)
---------------------------	----	--------------------

## Removing the fork legs

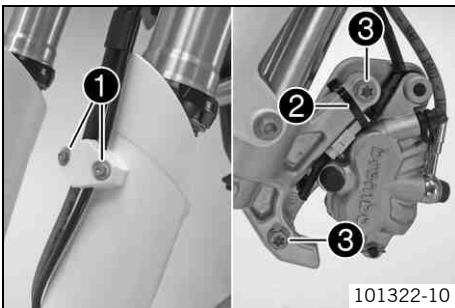

- Remove the headlight mask with the headlight. (☛ p. 83)
- Remove the front wheel. ☛ (☛ p. 74)
- Remove screws ❶ and take off the clamp.
- Remove cable binder ❷.
- Remove screws ❸ and take off the brake caliper.
- Allow the brake caliper and brake line to hang tension-free to the side.

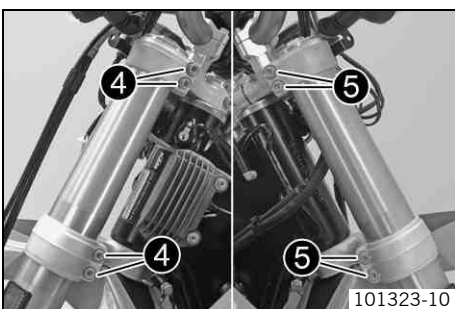

### (XCF-W, EXC-F EU, EXC-F AUS)

- Unscrew screws ❹. Take out the left fork leg.
- Loosen screws ❺. Take out the right fork leg.

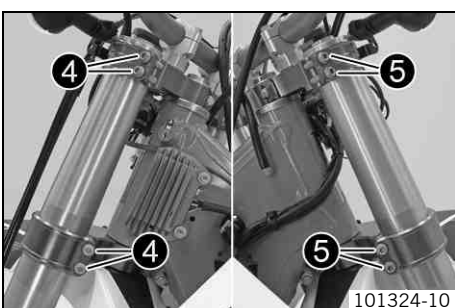

### (EXC-F SIX DAYS)

- Release screws ❹. Take out the left fork leg.
- Release screws ❺. Take out the right fork leg.

## Installing the fork legs



- Position the fork legs.

**i Info**

The topmost milled groove in the fork leg must be flush with the top edge of the upper triple clamp.  
Position bleeder screws **1** toward the front.

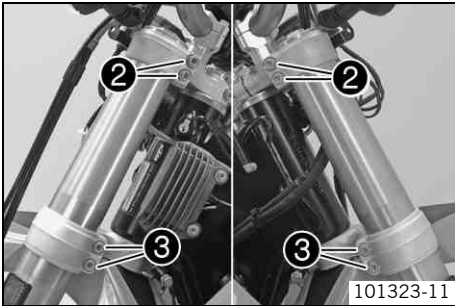

**(XCF-W, EXC-F EU, EXC-F AUS)**

- Tighten screws **2**.

Guideline

Screw, top triple clamp	M8	20 Nm (14.8 lbf ft)
-------------------------	----	------------------------

- Tighten screws **3**.

Guideline

Screw, bottom triple clamp	M8	15 Nm (11.1 lbf ft)
----------------------------	----	------------------------

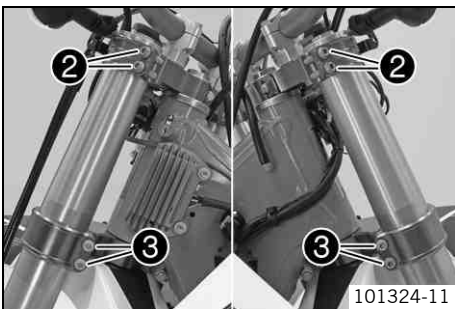

**(EXC-F SIX DAYS)**

- Tighten screws **2**.

Guideline

Screw, top triple clamp	M8	17 Nm (12.5 lbf ft)
-------------------------	----	------------------------

- Tighten screws **3**.

Guideline

Screw, bottom triple clamp	M8	12 Nm (8.9 lbf ft)
----------------------------	----	-----------------------

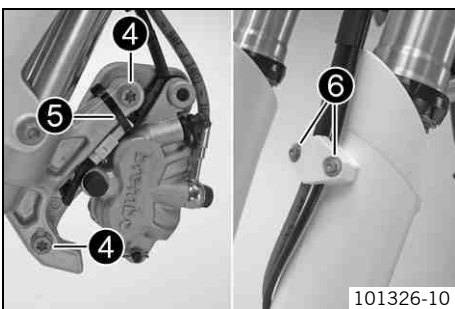

- Position brake caliper, and mount and tighten screws **4**.

Guideline

Screw, front brake caliper	M8	25 Nm (18.4 lbf ft)	<b>Loctite® 243™</b>
----------------------------	----	------------------------	----------------------

- Mount cable binder **5**.
- Refit the headlight mask with the headlight. (☛ p. 83)
- Position the brake line, wiring harness, and clamp. Mount and tighten screws **6**.
- Install the front wheel. (☛ p. 74)

## Removing the fork protector

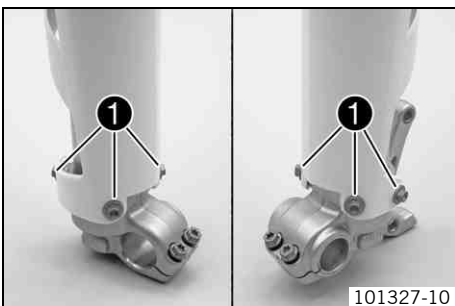

- Remove the fork legs. (☛ p. 43)
- Remove screws **1** on the left fork leg. Remove the fork protector upwards.
- Remove the screws on the right fork leg. Remove the fork protector upwards.

## Installing the fork protector

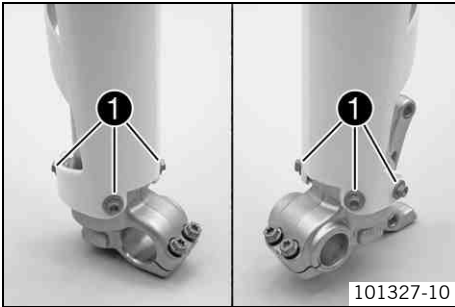

- Position the fork protection on the left fork leg. Mount and tighten screws **1**.

Guideline

Remaining screws, chassis	M6	10 Nm (7.4 lbf ft)
---------------------------	----	--------------------

- Position the fork protection on the right fork leg. Mount and tighten the screws.

Guideline

Remaining screws, chassis	M6	10 Nm (7.4 lbf ft)
---------------------------	----	--------------------

- Install the fork legs. (p. 44)

## Removing the lower triple clamp (XCF-W, EXC-F EU, EXC-F AUS)

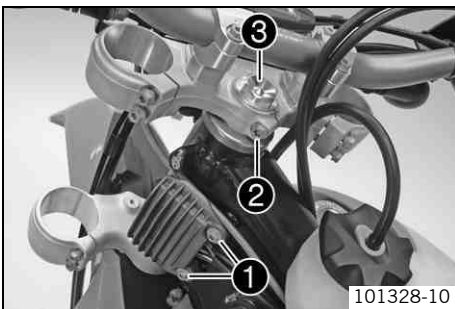

- Remove the fork legs. (p. 43)
- Remove the front fender. (p. 51)
- Remove the handlebar cushion.
- Open the cable holder in front of the right radiator and detach the wiring harness.
- Remove screws **1** and hang the voltage regulator to one side.
- Remove screw **2** and screw **3**. Take off the upper triple clamp with the handlebar and set it aside.

### **i** Info

Protect the motorcycle and its attachments against damage by covering them.

Do not bend the cables and lines.

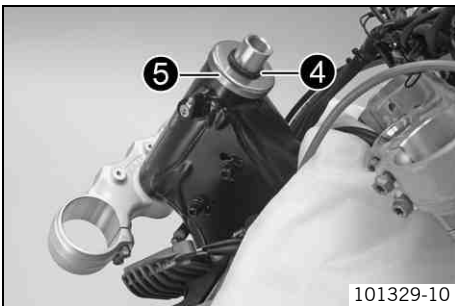

- Remove O-ring **4**. Remove protective ring **5**.
- Take out the lower triple clamp with the steering stem.
- Take out the upper steering head bearing.

## Removing the lower triple clamp (EXC-F SIX DAYS)

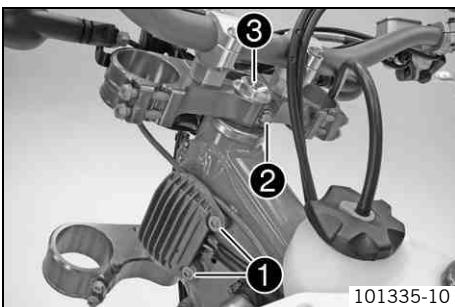

- Remove the fork legs. (p. 43)
- Remove the front fender. (p. 51)
- Remove the handlebar cushion.
- Open the cable holder in front of the right radiator and detach the wiring harness.
- Remove screws **1** and hang the voltage regulator to the side.
- Remove screw **2**. Remove screw **3**, take off the upper triple clamp with the handlebar and set it aside.

### **i** Info

Protect the motorcycle and its attachments against damage by covering them.

Do not bend the cables and lines.

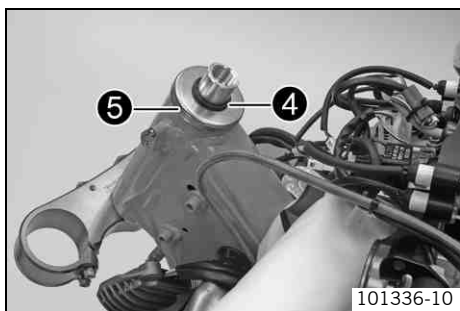

101336-10

- Remove O-ring ④. Remove protective ring ⑤.
- Take out the lower triple clamp with the steering stem.
- Take out the upper steering head bearing.

## Installing the lower triple clamp (XCF-W, EXC-F EU, EXC-F AUS)

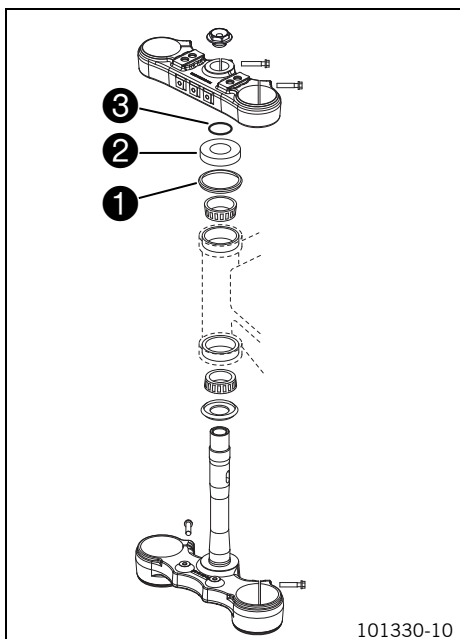

101330-10

- Clean the bearing and sealing elements, check for damage, and grease.
- High viscosity grease (☛ p. 112)
- Insert the lower triple clamp with the steering stem. Mount the upper steering head bearing.
  - Check whether the top steering head seal ① is correctly positioned.
  - Slide on protective ring ② and O-ring ③.

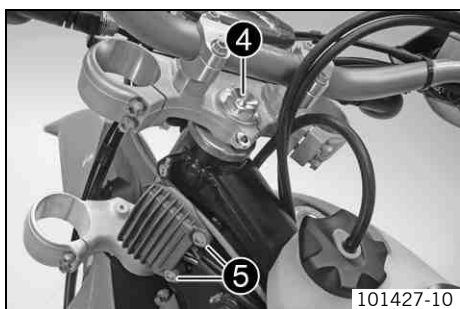

101427-10

- Position the upper triple clamp with the steering.
- Mount screw ④ but do not tighten yet.
- Position the clutch line, wiring harness, and voltage regulator. Mount and tighten screws ⑤.

Guideline

Remaining screws, chassis	M6	10 Nm (7.4 lbf ft)
---------------------------	----	--------------------

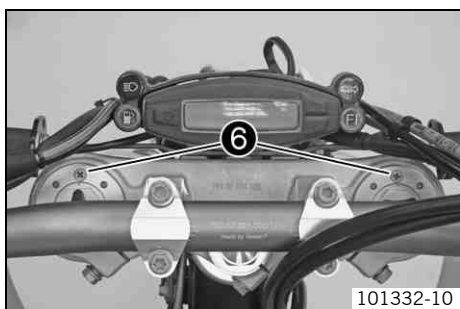

101332-10

- Position the fork legs.

**i Info**  
 The topmost milled groove in the fork leg must be flush with the top edge of the upper triple clamp.  
 Position bleeder screws ⑥ toward the front.

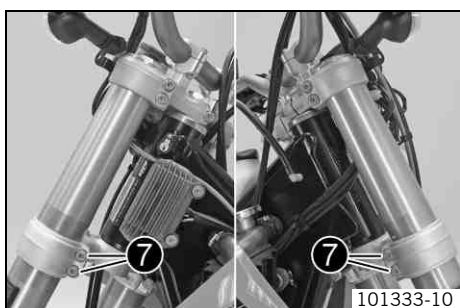

101333-10

- Tighten screws ⑦.

Guideline

Screw, bottom triple clamp	M8	15 Nm (11.1 lbf ft)
----------------------------	----	---------------------



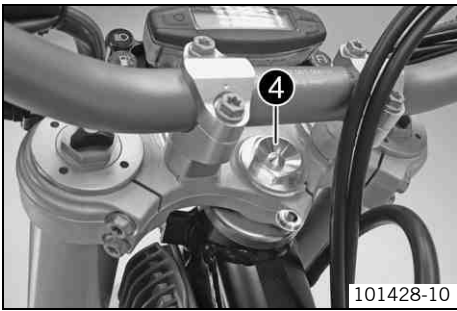

- Tighten screw 4.

Guideline

Screw, top steering head	M20x1.5	12 Nm (8.9 lbf ft)
--------------------------	---------	--------------------

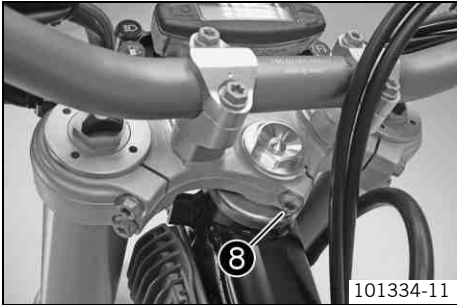

- Tighten screw 8.

Guideline

Screw, top steering stem	M8	20 Nm (14.8 lbf ft)
--------------------------	----	---------------------

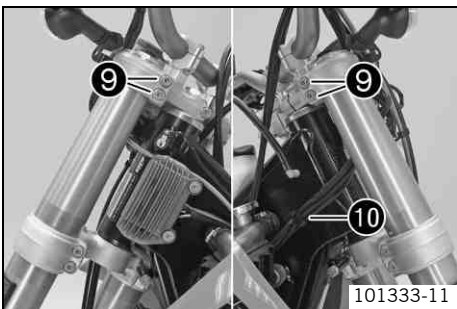

- Tighten screws 9.

Guideline

Screw, top triple clamp	M8	20 Nm (14.8 lbf ft)
-------------------------	----	---------------------

- Secure the wiring harness with cable holder 10.

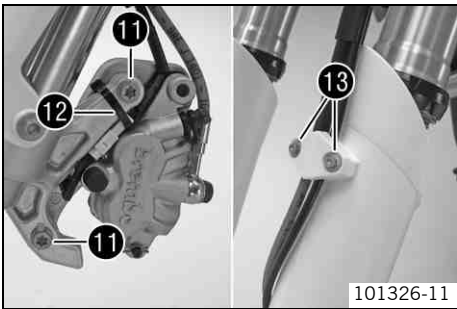

- Position the brake caliper. Mount and tighten screws 11.

Guideline

Screw, front brake caliper	M8	25 Nm (18.4 lbf ft)	Loctite® 243™
----------------------------	----	---------------------	---------------

- Mount cable binder 12.
- Position the brake line, wiring harness, and clamp. Mount and tighten screws 13.
- Install the front fender. (☛ p. 51)
- Mount the handlebar cushion.
- Refit the headlight mask with the headlight. (☛ p. 83)
- Install the front wheel. ☛ (☛ p. 74)
- Check that the wiring harness, cables, and brake and clutch lines can move freely and are routed correctly.
- Check the steering head bearing play. (☛ p. 49)

## Installing the lower triple clamp (EXC-F SIX DAYS)

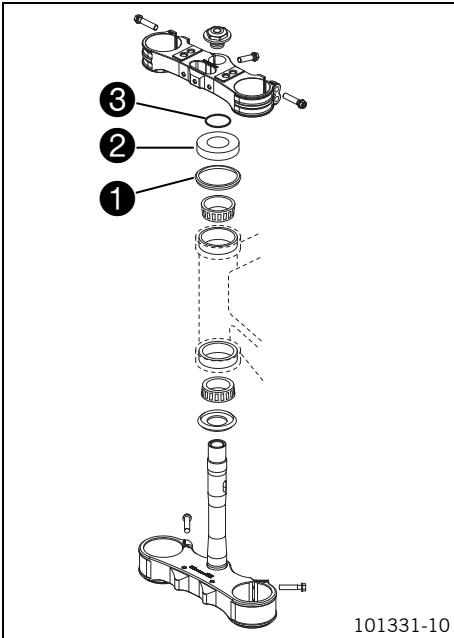

- Clean the bearing and sealing elements, check for damage, and grease.

High viscosity grease (☛ p. 112)

- Insert the lower triple clamp with the steering stem. Mount the upper steering head bearing.
- Check whether the top steering head seal ① is correctly positioned.
- Slide on protective ring ② and O-ring ③.

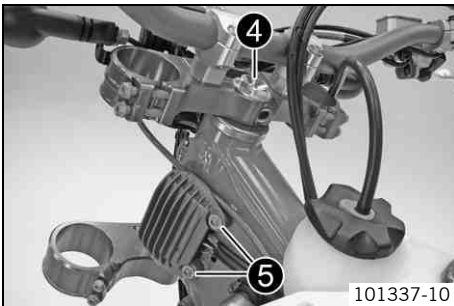

- Position the upper triple clamp with the steering.
- Mount screw ④ but do not tighten yet.
- Position the clutch line, wiring harness, and voltage regulator. Mount and tighten screws ⑤.

### Guideline

Remaining screws, chassis	M6	10 Nm (7.4 lbf ft)
---------------------------	----	--------------------

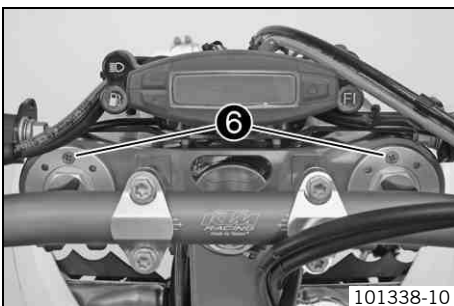

- Position the fork legs.

### **i** Info

The topmost milled groove in the fork leg must be flush with the top edge of the upper triple clamp.

Position bleeder screws ⑥ toward the front.

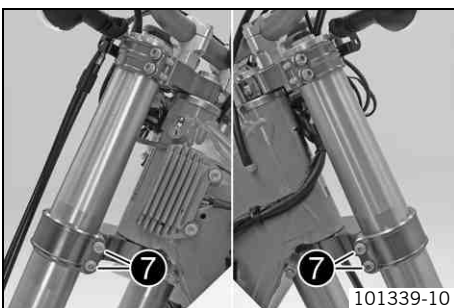

- Tighten screws ⑦.

### Guideline

Screw, bottom triple clamp	M8	12 Nm (8.9 lbf ft)
----------------------------	----	--------------------

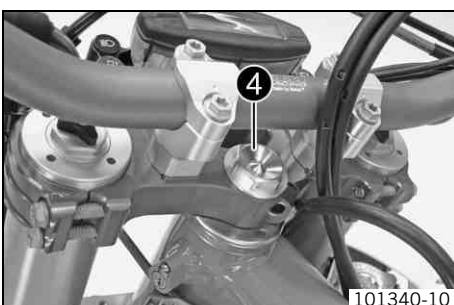

- Tighten screw ④.

### Guideline

Screw, top steering head	M20x1.5	12 Nm (8.9 lbf ft)
--------------------------	---------	--------------------

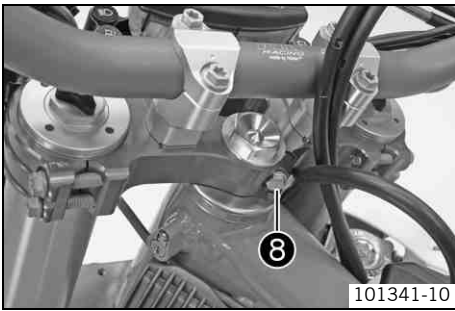

- Mount and tighten screw 8.

Guideline

Screw, top steering stem	M8	17 Nm (12.5 lbf ft)	Loctite® 243™
--------------------------	----	------------------------	---------------

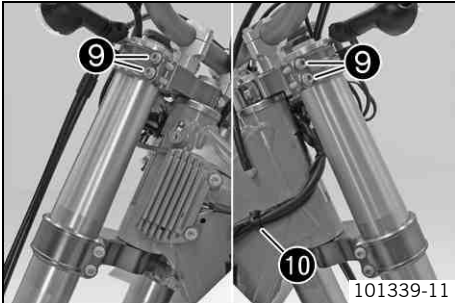

- Tighten screws 9.

Guideline

Screw, top triple clamp	M8	17 Nm (12.5 lbf ft)	
-------------------------	----	------------------------	--

- Secure the wiring harness with cable holder 10.

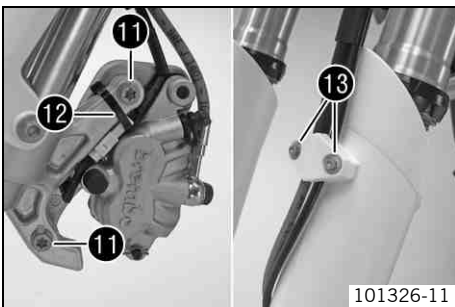

- Position the brake caliper. Mount and tighten screws 11.

Guideline

Screw, front brake caliper	M8	25 Nm (18.4 lbf ft)	Loctite® 243™
----------------------------	----	------------------------	---------------

- Mount cable binder 12.
- Position the brake line, wiring harness, and clamp. Mount and tighten screws 13.
- Install the front fender. (☛ p. 51)
- Mount the handlebar cushion.
- Refit the headlight mask with the headlight. (☛ p. 83)
- Install the front wheel. ☛ (☛ p. 74)
- Check that the wiring harness, cables, and brake and clutch lines can move freely and are routed correctly.
- Check the steering head bearing play. (☛ p. 49)

## Checking the steering head bearing play



### Warning

**Danger of accidents** Unstable vehicle handling from incorrect steering head bearing play.

- Adjust the steering head bearing play without delay. (Your authorized KTM workshop will be glad to help.)



### Info

If the bike is ridden with play in the steering head bearing, the bearing and the bearing seats in the frame can become damaged over time.

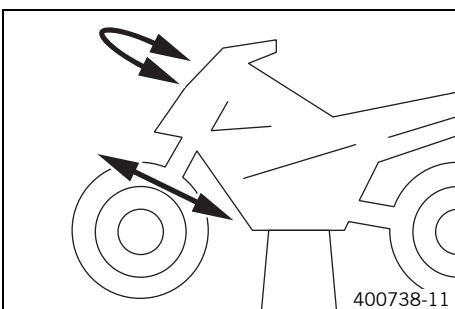

- Raise the motorcycle with the lift stand. (☛ p. 42)
- Move the handlebar to the straight-ahead position. Move the fork legs to and fro in the direction of travel.

No play should be noticeable in the steering head bearing.

- » If there is noticeable play present:

#### (EXC-F SIX DAYS)

- Adjust the play of the steering head bearing. ☛ (☛ p. 50)

#### (XCF-W, EXC-F EU, EXC-F AUS)

- Adjust the play of the steering head bearing. ☛ (☛ p. 50)

- Move the handlebar to and fro over the entire steering range.

The handlebar must be able to move easily over the entire steering range. No resting locations should be noticeable.

- » If click positions are noticeable:
  - (EXC-F SIX DAYS)**
    - Adjust the play of the steering head bearing. 🛠️ (📄 p. 50)
  - (XCF-W, EXC-F EU, EXC-F AUS)**
    - Adjust the play of the steering head bearing. 🛠️ (📄 p. 50)
    - Check the steering head bearing and replace if required.
- Remove the motorcycle from the lift stand. (📄 p. 42)

## Adjusting the play of the steering head bearing 🛠️ (XCF-W, EXC-F EU, EXC-F AUS)

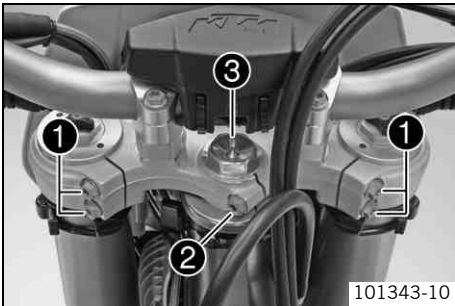

- Raise the motorcycle with the lift stand. (📄 p. 42)
- Loosen screws ❶ and ❷.
- Loosen and retighten screw ❸.

Guideline

Screw, top steering head	M20x1.5	12 Nm (8.9 lbf ft)
--------------------------	---------	--------------------

- Using a plastic hammer, tap lightly on the upper triple clamp to avoid strains.
- Tighten screws ❶.

Guideline

Screw, top triple clamp	M8	20 Nm (14.8 lbf ft)
-------------------------	----	------------------------

- Tighten screw ❷.

Guideline

Screw, top steering stem	M8	20 Nm (14.8 lbf ft)
--------------------------	----	------------------------

- Check the steering head bearing play. (📄 p. 49)

## Adjusting the play of the steering head bearing 🛠️ (EXC-F SIX DAYS)

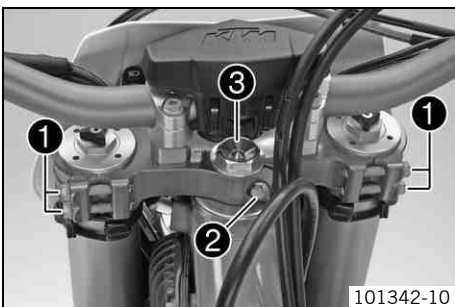

- Raise the motorcycle with the lift stand. (📄 p. 42)
- Loosen screws ❶. Remove screw ❷.
- Loosen and retighten screw ❸.

Guideline

Screw, top steering head	M20x1.5	12 Nm (8.9 lbf ft)
--------------------------	---------	--------------------

- Using a plastic hammer, tap lightly on the upper triple clamp to avoid strains.
- Fully tighten screws ❶.

Guideline

Screw, top triple clamp	M8	17 Nm (12.5 lbf ft)
-------------------------	----	------------------------

- Mount and tighten screw ❷.

Guideline

Screw, top steering stem	M8	17 Nm (12.5 lbf ft)	Loctite® 243™
--------------------------	----	------------------------	---------------

- Check the steering head bearing play. (📄 p. 49)

## Greasing the steering head bearing 🛠️

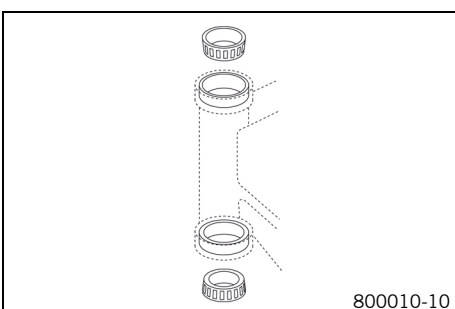

### (EXC-F SIX DAYS)

- Remove the lower triple clamp. 🛠️ (📄 p. 45)
- Install the lower triple clamp. 🛠️ (📄 p. 48)

### (XCF-W, EXC-F EU, EXC-F AUS)

- Remove the lower triple clamp. 🛠️ (📄 p. 45)
- Install the lower triple clamp. 🛠️ (📄 p. 46)

## Removing the shock absorber

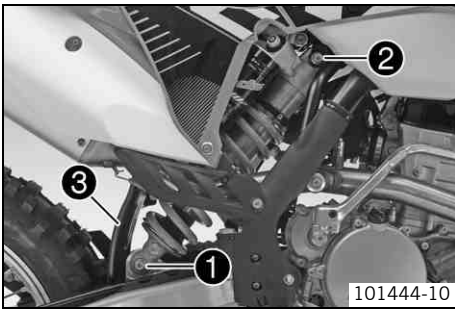

- Raise the motorcycle with the lift stand. ( p. 42)
- Remove screw ❶ and lower the rear wheel with the swing arm as far as possible without blocking the rear wheel. Fix the rear wheel in this position.
- Remove screw ❷, push splash protector ❸ to the side, and remove the shock absorber.

## Installing the shock absorber

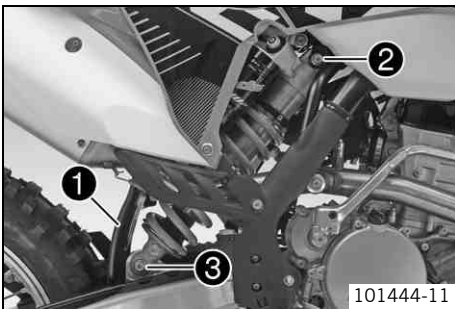

- Push splash protector ❶ to the side and position the shock absorber. Mount and tighten screw ❷.

Guideline

Screw, top shock absorber	M12	80 Nm (59 lbf ft)	<b>Loctite® 2701</b>
---------------------------	-----	----------------------	----------------------

- Mount and tighten screw ❸.

Guideline

Screw, bottom shock absorber	M12	80 Nm (59 lbf ft)	<b>Loctite® 2701</b>
------------------------------	-----	----------------------	----------------------



### Info

The heim joint for the shock absorber at the swing arm is Teflon coated. It must not be greased with grease or with other lubricants. Lubricants dissolve the Teflon coating, thereby drastically reducing the service life.

- Remove the motorcycle from the lift stand. ( p. 42)

## Removing the front fender

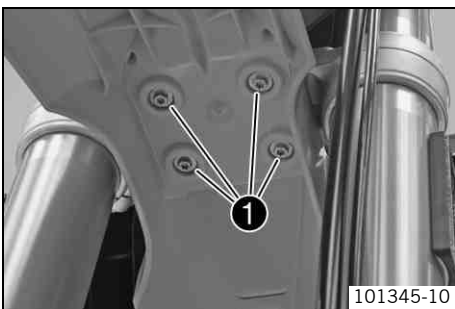

- Remove screws ❶. Remove the front fender.
- Make sure the spacers remain in place.

## Installing the front fender

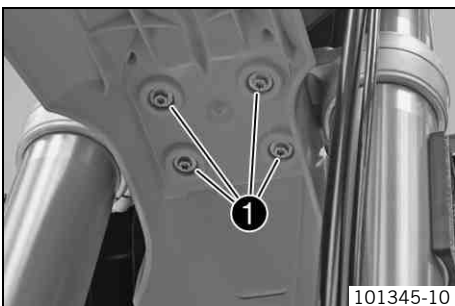

- Ensure that the spacers are mounted in the fender.
- Position the front fender. Mount and tighten screws ❶.

Guideline

Remaining screws, chassis	M6	10 Nm (7.4 lbf ft)
---------------------------	----	--------------------



### Info

Make sure the holding lugs engage in the start number plate or headlight mask.

## Removing the seat

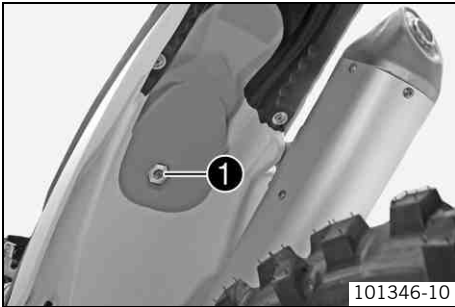

- Remove screw ❶.
- Lift up the seat at the rear, pull it back and then remove it from above.

## Mounting the seat

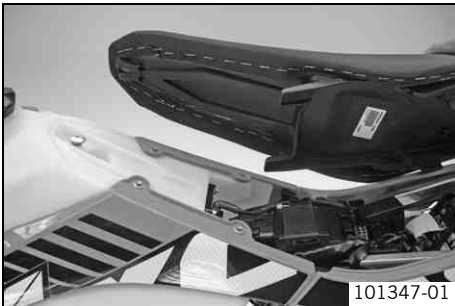

- Hook in the front of the seat at the collar sleeve of the fuel tank, lower it at the rear and simultaneously push it forward.
- Make sure that the seat is correctly locked in.
- Mount and tighten the screw of the seat fixing.

Guideline

Remaining screws, chassis	M6	10 Nm (7.4 lbf ft)
---------------------------	----	--------------------

## Removing the air filter box lid

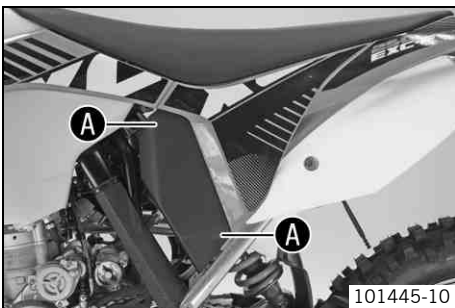

- Pull off the air filter box lid in area ❶ to the side and remove to the front.

## Installing the air filter box lid

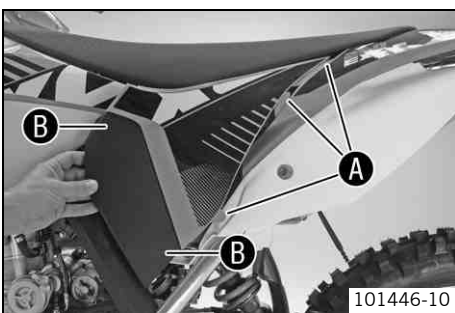

- Insert the air filter box lid into the rear area ❶ and clip it into the front area ❷.

## Removing the air filter

### Note

**Engine failure** Unfiltered intake air has a negative effect on the service life of the engine.

- Never ride the vehicle without an air filter since dust and dirt can get into the engine and result in increased wear.



### Warning

**Environmental hazard** Hazardous substances cause environmental damage.

- Oil, grease, filters, fuel, cleaners, brake fluid, etc., should be disposed of as stipulated in applicable regulations.

- Remove the air filter box lid. (☞ p. 52)

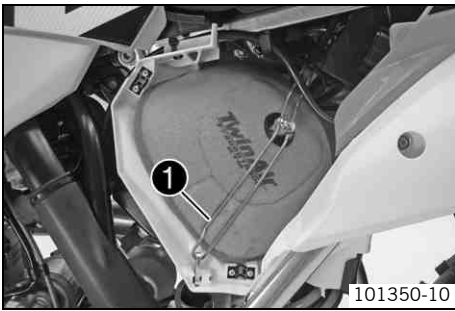

- Detach air filter holder ❶ at the bottom and swing it to one side. Remove the air filter with the air filter support.
- Remove the air filter from the air filter support.

## Installing the air filter 🛠️

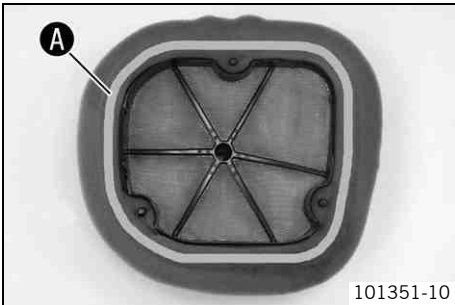

- Mount the clean air filter onto the air filter support.
- Apply grease to the section ❶ of the air filter.

Long-life grease (🔧 p. 112)

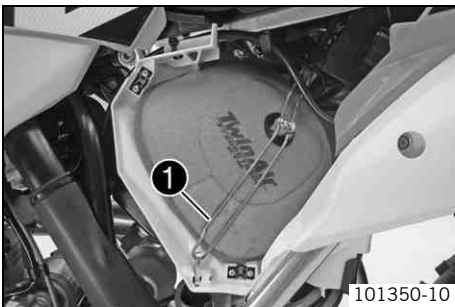

- Put in both parts together, position them and fix them with air filter holder ❶.

### Info

If the air filter is not correctly mounted, dust and dirt can penetrate into the engine and can cause damage.

- Install the air filter box lid. (🔧 p. 52)

## Cleaning the air filter and air filter box 🛠️



### Warning

**Environmental hazard** Hazardous substances cause environmental damage.

- Oil, grease, filters, fuel, cleaners, brake fluid, etc., should be disposed of as stipulated in applicable regulations.



### Info

Do not clean the air filter with fuel or petroleum since these substances attack the foam.



- Remove the air filter. 🛠️ (🔧 p. 52)
- Wash the air filter thoroughly in special cleaning liquid and allow it to dry properly.

Air filter cleaner (🔧 p. 112)

### Info

Only press the air filter to dry it, never wring it out.

- Oil the dry air filter with a high quality filter oil.

Oil for foam air filter (🔧 p. 112)

- Clean the air filter box.
- Check the inlet sleeve for damage and firm seating.
- Install the air filter. 🛠️ (🔧 p. 53)

## Removing main silencer

- Warning**  
**Danger of burns** The exhaust system gets very hot when the vehicle is driven.
- Allow the exhaust system to cool down. Do not touch hot components.

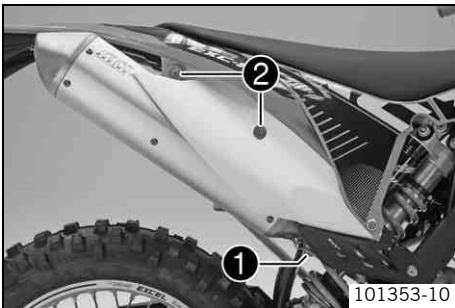

- Disconnect spring ①.
- Remove screws ② and take off main silencer.

## Installing the main silencer

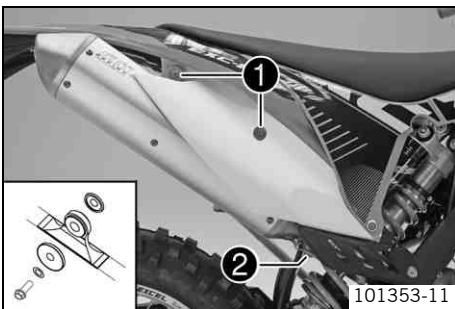

- Mount the main silencer. Mount and tighten screws ①.

Guideline

Remaining screws, chassis	M6	10 Nm (7.4 lbf ft)
---------------------------	----	--------------------

- Reconnect spring ②.

## Changing the glass fiber yarn filling of the main silencer

- Warning**  
**Danger of burns** The exhaust system gets very hot when the vehicle is driven.
- Allow the exhaust system to cool down. Do not touch hot components.

- i Info**  
 Over a period, the fibers of the insulating material vanish into the air, and the silencer "burns out". Not only is the noise level higher, the performance characteristic changes.

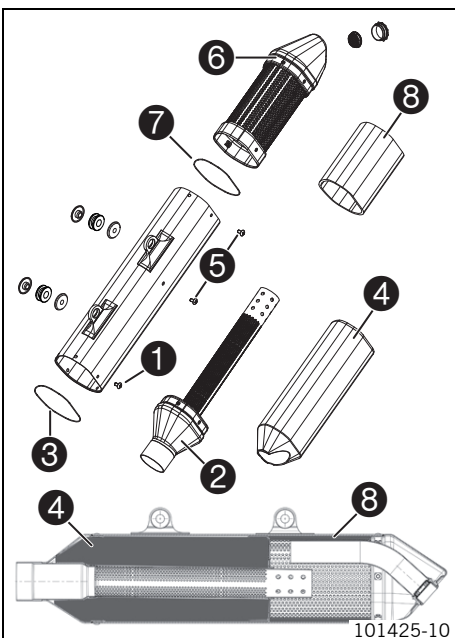

- Remove the main silencer. (☛ p. 54)

**(All EXC-F models)**

- Remove screws ① of connecting cap ②.
- Take off the connecting cap with the perforated pipe, O-ring ③, and glass fiber yarn filling ④.
- Remove screws ⑤ and take off silencer cap ⑥ with O-ring ⑦ and stuffing yarn ⑧.
- Clean the parts that need to be reinstalled and check for damage.
- Mount the O-ring on the silencer cap.
- Mount the new stuffing yarn on the silencer cap and fasten with adhesive tape.
- Position the silencer cap. Mount and tighten the screws.
- Mount the O-ring on the connecting cap.
- Slide the new glass fiber yarn filling over the perforated pipe.
- Mount the connecting cap with the glass fiber yarn filling in the main silencer.

- i Info**  
 Slide the glass fiber yarn filling into the main silencer with a blunt tool.



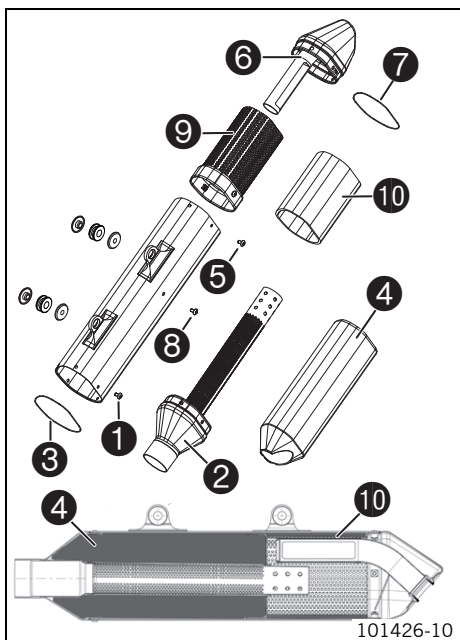

- Mount and tighten the screws.
- (XCF-W)**
- Remove screws ① of connecting cap ②.
  - Take off the connecting cap with the perforated pipe, O-ring ③ and glass fiber yarn filling ④.
  - Remove screws ⑤ and silencer cap ⑥ with O-ring ⑦.
  - Remove screw ⑧ and remove insert ⑨ together with stuffing yarn ⑩.
  - Clean the parts that need to be reinstalled and check for damage.
  - Mount the new stuffing yarn on the insert and fasten with adhesive tape.
  - Slide the insert with the stuffing yarn into the main silencer and fasten with the screw.
  - Mount the O-ring on the connecting cap.
  - Slide the new glass fiber yarn filling over the perforated pipe.
  - Mount the connecting cap with the glass fiber yarn filling in the main silencer.

**i Info**  
Slide the glass fiber yarn filling into the main silencer with a blunt tool.

- Mount and tighten the screws.
- Mount the O-ring on the silencer cap.
- Position the silencer cap. Mount and tighten the screws.
- Install the main silencer. (☛ p. 54)

## Removing the fuel tank ☞

**⚠ Danger**  
**Fire hazard** Fuel is highly flammable.

- Never refuel the vehicle near open flames or burning cigarettes, and always switch off the engine first. Be careful that no fuel is spilt, especially on hot vehicle components. Clean up spilt fuel immediately.
- Fuel in the fuel tank expands when warm and can escape if the tank is overfilled. See the notes on refueling.

**⚠ Warning**  
**Danger of poisoning** Fuel is poisonous and a health hazard.

- Avoid contact between fuel and skin, eyes and clothing. Do not inhale fuel vapors. If fuel gets into your eyes, rinse immediately with water and contact a doctor. Wash affected skin areas immediately with soap and water. If fuel is swallowed, contact a doctor immediately. Change clothing that has come into contact with fuel. Store fuel in a suitable canister according to regulations and keep it out of the reach of children.

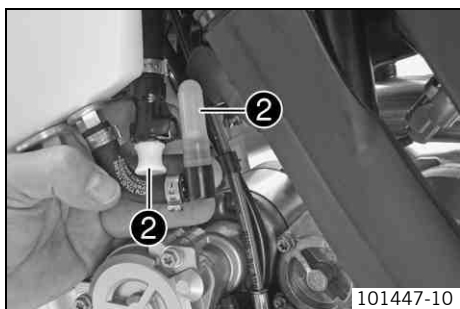
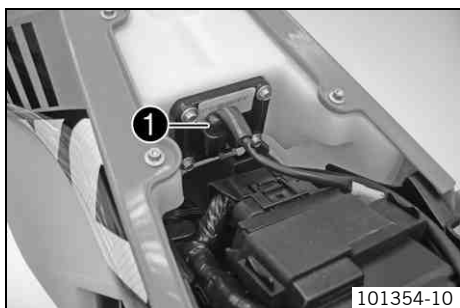

- Remove the seat. (☛ p. 52)
- Disconnect electric plug-in connection ① of the fuel pump.
- Remove the tube from the fuel tank breather.

- Thoroughly clean the plug-in connection of the fuel line using compressed air.

**i Info**  
Under no circumstances should dirt enter into the fuel line. Dirt in the fuel line will clog the fuel injection jets.

- Disconnect the plug-in connection of the fuel line.
- Mount wash cap set ②.

Wash cap set (81212016000)

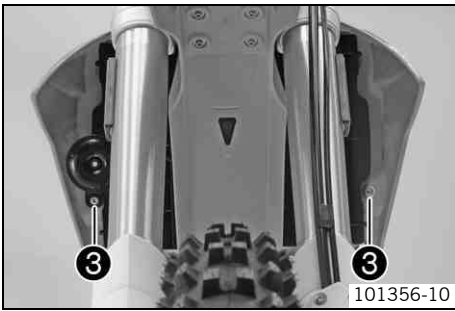

- Remove screws 3 with the collar bushings and horn.

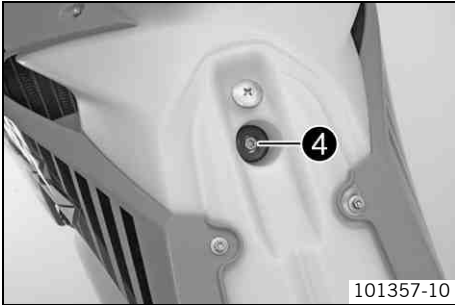

- Remove screw 4 with the rubber bushing.



- Pull both spoilers off of the sides of the radiator bracket and lift off the fuel tank.

## Installing the fuel tank ↩

**Danger**  
**Fire hazard** Fuel is highly flammable.

- Never refuel the vehicle near open flames or burning cigarettes, and always switch off the engine first. Be careful that no fuel is spilt, especially on hot vehicle components. Clean up spilt fuel immediately.
- Fuel in the fuel tank expands when warm and can escape if the tank is overfilled. See the notes on refueling.

**Warning**  
**Danger of poisoning** Fuel is poisonous and a health hazard.

- Avoid contact of the fuel with skin, eyes and clothing. Do not inhale fuel vapors. If fuel gets into your eyes, rinse immediately with water and contact a doctor. Wash affected skin areas immediately with soap and water. If fuel is swallowed, contact a doctor immediately. Change clothing that has come into contact with fuel.

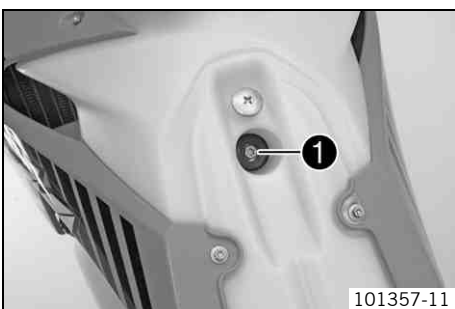

- Check the throttle cable routing. (↩ p. 62)
- Position the fuel tank and fit the two spoilers to the sides of the radiator bracket.
- Make sure that no cables are trapped or damaged.
- Mount the fuel tank breather.
- Mount and tighten screw 1 with the rubber bushing.

### Guideline

Remaining screws, chassis	M6	10 Nm (7.4 lbf ft)
---------------------------	----	--------------------

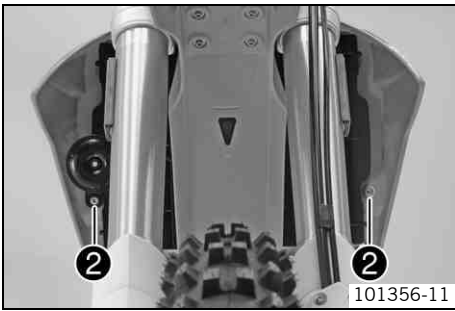

- Position the horn, and fit and tighten screws ② with collar bushings.

Guideline

Remaining screws, chassis	M6	10 Nm (7.4 lbf ft)
---------------------------	----	--------------------

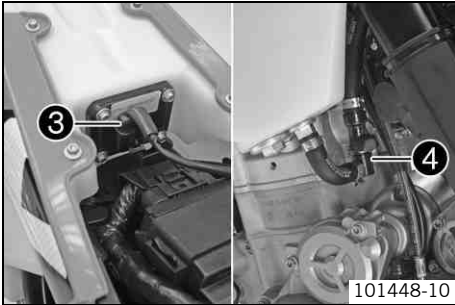

- Connect the electrical plug-in connection ③.
- Thoroughly clean the plug-in connection of the fuel line using compressed air.

**i Info**  
Under no circumstances should dirt enter into the fuel line. Dirt in the fuel line will clog the fuel injection jets.

- Remove the wash cap set. Lubricate the O-ring and connect plug-in connection ④ of the fuel line.

**i Info**  
Route the cable and fuel line at a safe distance from the exhaust system.

- Mount the seat. (☛ p. 52)

## Checking for chain dirt accumulation

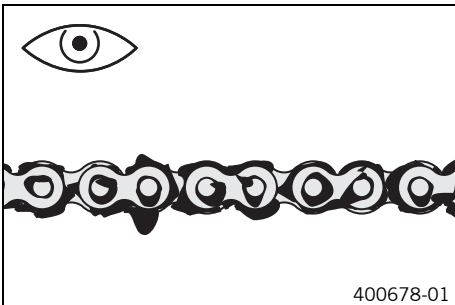

- Check the chain for coarse dirt accumulation.
  - » If the chain is very dirty:
    - Clean the chain. (☛ p. 57)

## Cleaning the chain

**⚠ Warning**  
**Danger of accidents** Oil or grease on the tires reduces their grip.  
- Remove oil and grease with a suitable cleaning material.

**⚠ Warning**  
**Danger of accidents** Reduced braking efficiency due to oil or grease on the brake discs.  
- Always keep the brake discs free of oil and grease, and clean them with brake cleaner when necessary.

**☀ Warning**  
**Environmental hazard** Hazardous substances cause environmental damage.  
- Oil, grease, filters, fuel, cleaners, brake fluid, etc., should be disposed of as stipulated in applicable regulations.

**i Info**  
The service life of the chain depends largely on its maintenance.

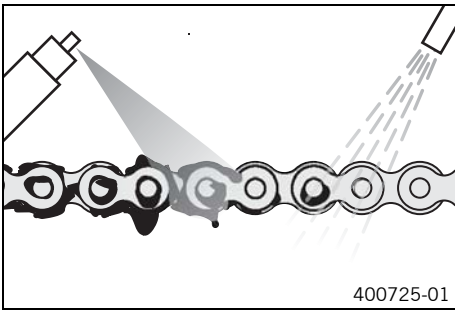

- Clean the chain regularly and then treat with chain spray.

Chain cleaner (☛ p. 112)

Off-road chain spray (☛ p. 112)

## Checking the chain tension

- Warning**  
**Danger of accidents** Danger caused by incorrect chain tension.
- If the chain tension is too high, the components of the secondary power train (chain, engine sprocket, rear sprocket, bearings in transmission and rear wheel) are under additional load. Apart from premature wear, in extreme cases the chain can rupture or the countershaft of the transmission can break. On the other hand, if the chain is loose, it can fall off the engine sprocket or the rear sprocket and block the rear wheel or damage the engine. Check the chain tension and correct if necessary.

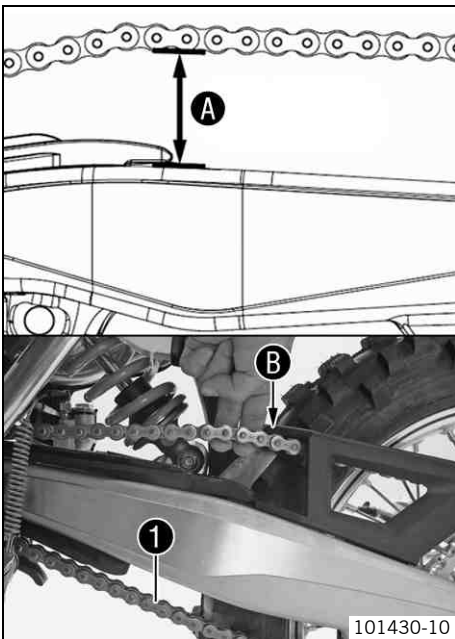

- Raise the motorcycle with the lift stand. (☛ p. 42)
- Push the chain at the end of the chain sliding component upwards to measure the chain tension **A**.

**i Info**  
 The lower chain section **1** must be taut.  
 When the chain guard is mounted, it must be possible to pull up the chain at least to the point where it makes contact with chain guard **B**.  
 Chain wear is not always even, so you should repeat this measurement at different chain positions.

Chain tension	55... 58 mm (2.17... 2.28 in)
---------------	-------------------------------

- » If the chain tension does not meet specifications:
  - Adjust the chain tension. (☛ p. 58)
- Remove the motorcycle from the lift stand. (☛ p. 42)

## Adjusting the chain tension

- Warning**  
**Danger of accidents** Danger caused by incorrect chain tension.
- If the chain tension is too high, the components of the secondary power train (chain, engine sprocket, rear sprocket, bearings in transmission and rear wheel) are under additional load. Apart from premature wear, in extreme cases the chain can rupture or the countershaft of the transmission can break. On the other hand, if the chain is loose, it can fall off the engine sprocket or the rear sprocket and block the rear wheel or damage the engine. Check the chain tension and correct if necessary.

- Raise the motorcycle with the lift stand. (☛ p. 42)
- Check the chain tension. (☛ p. 58)

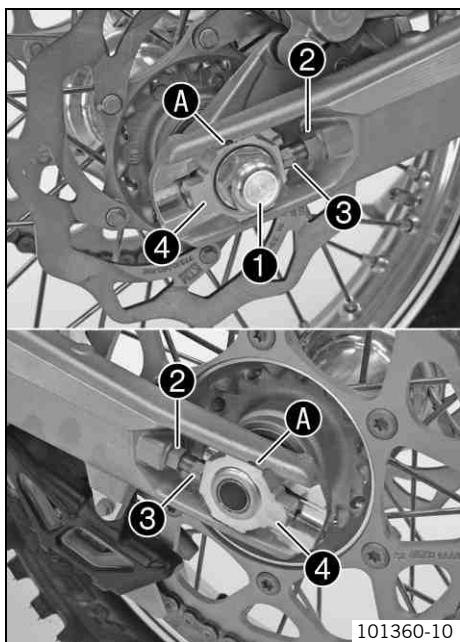

- Loosen nut ①.
- Loosen nuts ②.
- Adjust the chain tension by turning the adjusting screws ③ left and right.

Guideline

Chain tension	55... 58 mm (2.17... 2.28 in)	
Turn adjusting screws ③ on the left and right so that the markings on the left and right chain adjusters are in the same position relative to reference marks A. The rear wheel is then correctly aligned.		

- Tighten nuts ②.
- Make sure that the chain adjusters ④ are fitted correctly on the adjusting screws ③.
- Tighten nut ①.

Guideline

Nut, rear wheel spindle	M20x1.5	80 Nm (59 lbf ft)
-------------------------	---------	-------------------

**i Info**  
The wide adjustment range of the chain adjusters (32 mm (1.18 in)) enables different secondary ratios with the same chain length. Chain adjusters ④ can be turned by 180°.

- Remove the motorcycle from the lift stand. (☛ p. 42)

## Checking the chain, rear sprocket, engine sprocket and chain guide

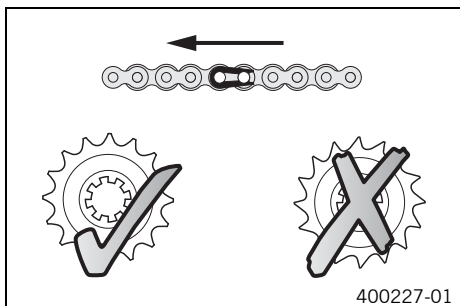

- Raise the motorcycle with the lift stand. (☛ p. 42)
- Shift gear to neutral.
- Check the rear sprocket and engine sprocket for wear.
  - » If the rear sprocket or engine sprocket is worn:
    - Change the rear sprocket or engine sprocket. ☛

**i Info**  
The engine sprocket, rear sprocket and chain should always be replaced together.

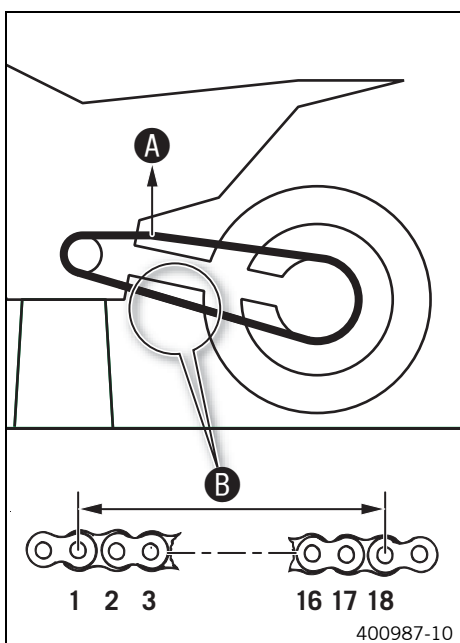

- Pull on the upper part of the chain with the specified weight A.

Guideline

Weight of chain wear measurement	10... 15 kg (22... 33 lb.)
----------------------------------	----------------------------

- Measure the distance B of 18 chain links in the lower chain section.

**i Info**  
Chain wear is not always even, so you should repeat this measurement at different chain positions.

Maximum distance B at the longest chain section	272 mm (10.71 in)
---	-------------------

- » If the distance B is greater than the specified measurement:
  - Change the chain. ☛

**i Info**  
When the chain is replaced, the rear sprocket and engine sprocket should also be changed. New chains wear out faster on old, worn sprockets.

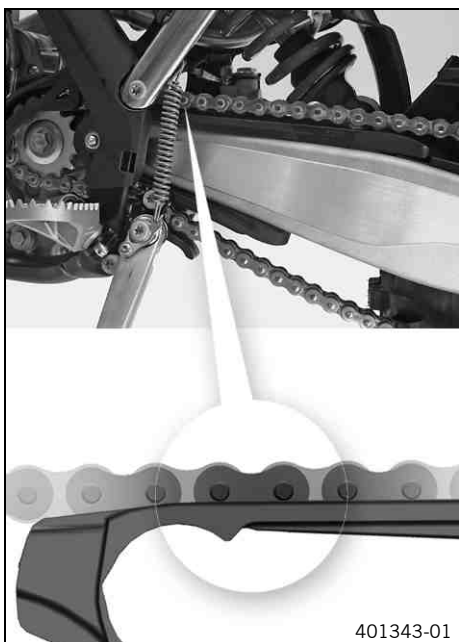

401343-01

- Check the chain sliding guard for wear.
  - » If the bottom edge of the chain bolt is in line with or below the chain sliding guard:
    - Change the chain sliding guard. 🛠️
- Check that the chain sliding guard is firmly seated.
  - » If the chain sliding guard is loose:
    - Tighten the chain sliding guard.

Guideline

Screw, chain sliding guard	M6	6 Nm (4.4 lbf ft)	Loctite® 243™
----------------------------	----	----------------------	---------------

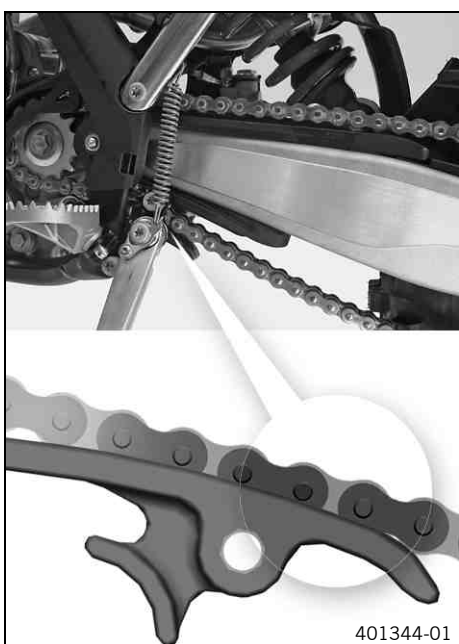

401344-01

- Check the chain sliding piece for wear.
  - » If the bottom edge of the chain bolt is in line with or below the chain sliding piece:
    - Change the chain sliding piece. 🛠️
- Check that the chain sliding piece is firmly seated.
  - » If the chain sliding piece is loose:
    - Tighten the chain sliding piece.

Guideline

Screw, chain sliding piece	M8	15 Nm (11.1 lbf ft)
----------------------------	----	------------------------

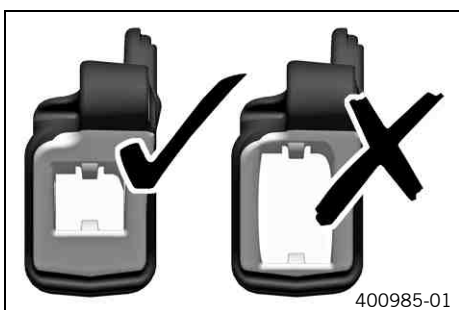

400985-01

- Check the chain guide for wear.



**Info**

Wear is visible on the front of the chain guide.

- » If the light part of the chain guide is worn:
  - Change the chain guide. 🛠️

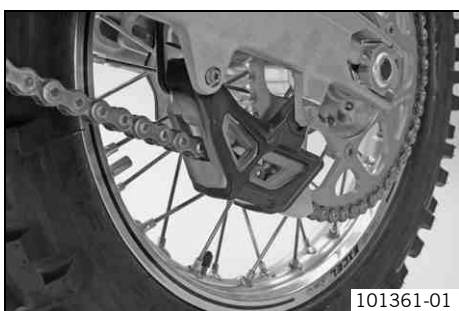

101361-01

- Check that the chain guide is firmly seated.
  - » If the chain guide is loose:
    - Tighten the chain guide.

Guideline

Remaining screws, chassis	M6	10 Nm (7.4 lbf ft)
Remaining nuts, chassis	M6	10 Nm (7.4 lbf ft)

- Remove the motorcycle from the lift stand. (👉 p. 42)

## Adjusting the chain guide ↩

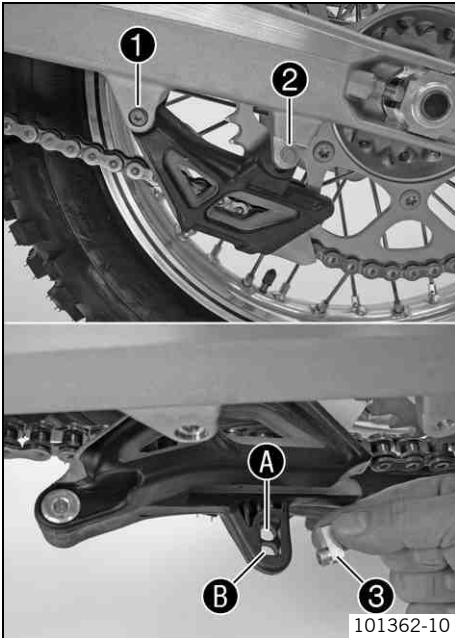

- Remove the nut of screw ❶.
- Remove screws ❶ and ❷. Take off the chain guide.

### Condition

Number of teeth: ≤ 44 teeth

- Insert nut ❸ in hole A. Position the chain guide.
- Mount and tighten screws ❶ and ❷.

### Guideline

Remaining screws, chassis	M6	10 Nm (7.4 lbf ft)
---------------------------	----	-----------------------

- Mount the nut on screw ❶ and tighten.

### Guideline

Remaining nuts, chassis	M6	10 Nm (7.4 lbf ft)
-------------------------	----	-----------------------

### Condition

Number of teeth: ≥ 45 teeth

- Insert nut ❸ in hole B. Position the chain guide.
- Mount and tighten screws ❶ and ❷.

### Guideline

Remaining screws, chassis	M6	10 Nm (7.4 lbf ft)
---------------------------	----	-----------------------

- Mount the nut on screw ❶ and tighten.

### Guideline

Remaining nuts, chassis	M6	10 Nm (7.4 lbf ft)
-------------------------	----	-----------------------

## Checking the frame ↩

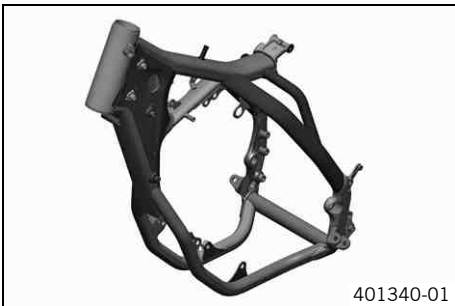

- Check the frame for cracking and deformation.
  - » If the frame exhibits cracking or deformation due to a mechanical impact:
    - Change the frame. ↩



### Info

A frame that has been damaged due to a mechanical impact must always be changed. Repair of the frame is not authorized by KTM.

## Checking the swingarm ↩



- Check the swingarm for damage, cracking, and deformation.
  - » If the swingarm shows signs of damage, cracking, or deformation:
    - Change the swingarm. ↩



### Info

A damaged swingarm must always be changed. Repair of the swingarm is not authorized by KTM.

## Checking the throttle cable routing



101449-10

- Remove the fuel tank. (🔧 p. 55)
- Check the throttle cable routing.

Both throttle cables must be routed to the carburetor side by side behind the handlebars and above the tank bearing.

- » If the throttle cable is not routed as specified:
  - Correct the throttle cable routing.
- Install the fuel tank. (🔧 p. 56)

## Checking the rubber grip

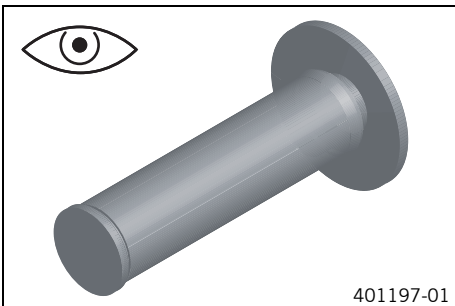

401197-01

- Check the rubber grips on the handlebar for damage and wear and to ensure they are firmly seated.
  - » If a rubber grip is damaged, worn or loose:
    - Change and secure the rubber grip.

Rubber grip adhesive (00062030051) (🔧 p. 113)

## Additionally securing the rubber grip

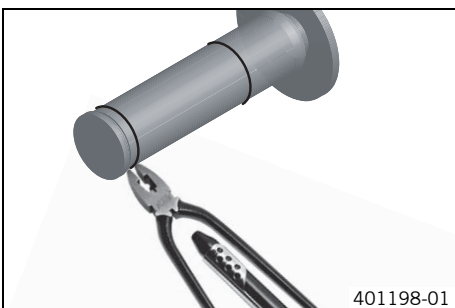

401198-01

- Check the rubber grip. (🔧 p. 62)
- Secure the rubber grip at two points using the securing wire.

Securing wire (54812016000)

Wire twister forceps (U6907854)

- ✓ The twisted wire ends face away from the hands and are bent toward the rubber grip.

## Adjusting the basic position of the clutch lever

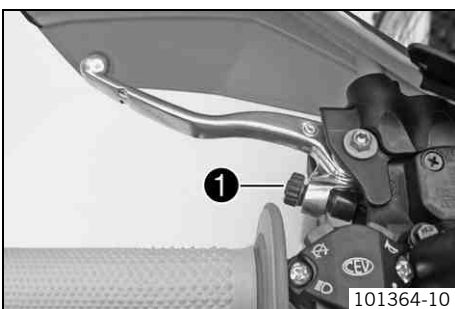

101364-10

- Adjust the basic setting of the clutch lever to your hand size by turning adjusting screw ❶.

### **i** Info

Turn the adjusting screw clockwise to increase the distance between the clutch lever and the handlebar.  
 Turn the adjusting screw counterclockwise to decrease the distance between the clutch lever and the handlebar.  
 The range of adjustment is limited.  
 Turn the adjusting screw by hand only, and do not apply any force.  
 Do not make any adjustments while riding!



## Checking the fluid level of the hydraulic clutch

**i Info**  
The fluid level rises with increased wear of the clutch lining discs.

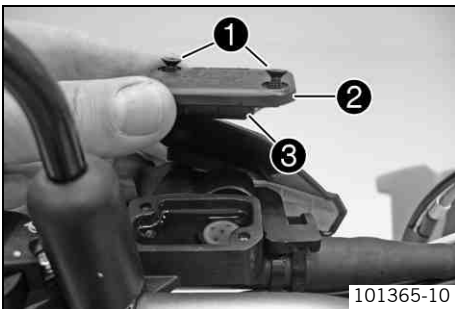

- Move the clutch fluid reservoir mounted on the handlebar to a horizontal position.
- Remove screws ①.
- Remove cover ② with membrane ③.
- Check the fluid level.

Fluid level below container rim	4 mm (0.16 in)
---------------------------------	----------------

- » If the fluid level does not meet specifications:
  - Correct the fluid level of the hydraulic clutch.

Brake fluid DOT 4 / DOT 5.1 (☛ p. 110)
--

- Position the cover with the membrane. Mount and tighten the screws.

**i Info**  
Clean up overflowed or spilt brake fluid immediately with water.

## Changing the hydraulic clutch fluid ☞

**Warning**  
**Environmental hazard** Hazardous substances cause environmental damage.

- Oil, grease, filters, fuel, cleaners, brake fluid, etc., should be disposed of as stipulated in applicable regulations.

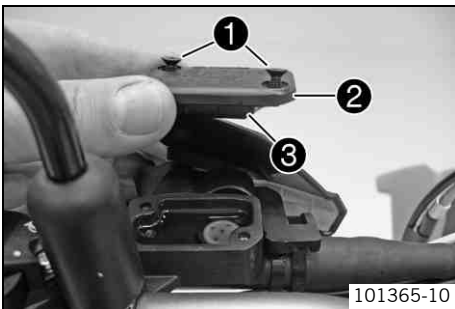

- Move the clutch fluid reservoir mounted on the handlebar to a horizontal position.
- Remove screws ①.
- Remove cover ② with membrane ③.

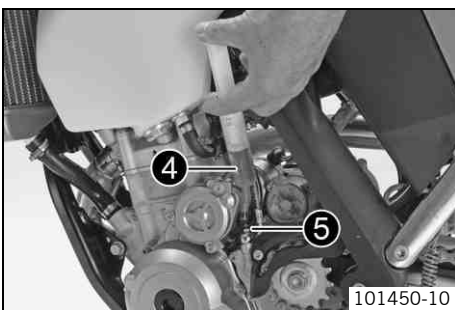

- Fill bleeding syringe ④ with the appropriate hydraulic fluid.
- On the slave cylinder, remove bleeder screw ⑤ and mount bleeding syringe ④.

Bleed syringe (50329050000)
-----------------------------

Brake fluid DOT 4 / DOT 5.1 (☛ p. 110)
--

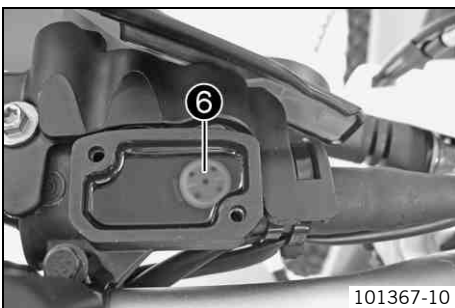

- Inject the liquid into the system until it escapes from openings ⑥ of the master cylinder without bubbles.
- To prevent overflow, drain fluid occasionally from the master cylinder reservoir.
- Remove the bleeding syringe. Mount and tighten screws bleeder screw.
- Correct the fluid level of the hydraulic clutch.

Guideline

Fluid level below container rim	4 mm (0.16 in)
---------------------------------	----------------

- Position the cover with the membrane. Mount and tighten the screws.

## Removing the engine guard (EXC-F AUS, EXC-F SIX DAYS)

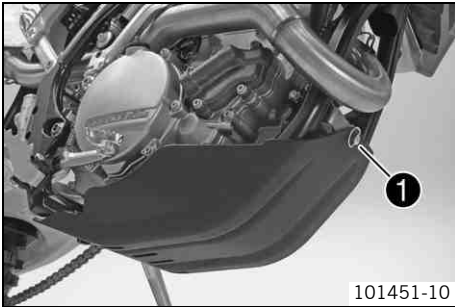

- Turn quick release ❶ counterclockwise until it disengages. Remove the engine guard.

## Installing the engine guard (EXC-F AUS, EXC-F SIX DAYS)



- Attach the engine guard on the frame at the rear and swing up at the front.
- Turn quick release ❶ clockwise all the way.

## Checking free travel of hand brake lever



### Warning

**Danger of accidents** Brake system failure.

- If there is no free travel on the hand brake lever, pressure builds up in the front brake circuit. The front brake can fail due to overheating. Adjust free travel on hand brake lever according to specifications.

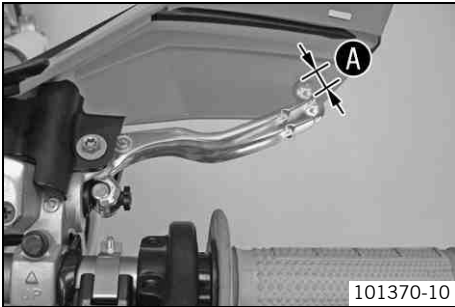

### (XCF-W)

- Push the hand brake lever forwards and check free travel **A**.

Free travel of hand brake lever	$\geq 3 \text{ mm } (\geq 0.12 \text{ in})$
---------------------------------	---

- » If the free travel does not meet specifications:
  - Adjust the basic position of the hand brake lever. (☛ p. 65)

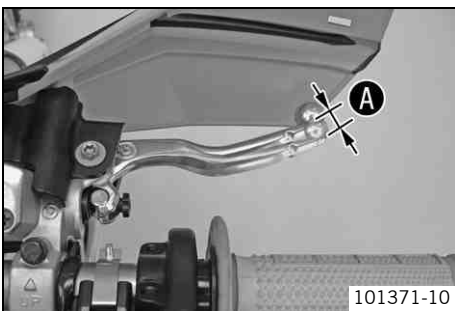

### (All EXC-F models)

- Push the hand brake to the handlebar and check free travel **A**.

Free travel of hand brake lever	$\geq 3 \text{ mm } (\geq 0.12 \text{ in})$
---------------------------------	---

- » If the free travel does not meet specifications:
  - Adjust the free travel of the hand brake lever. (☛ p. 65)

## Adjusting the basic position of the hand brake lever (XCF-W)

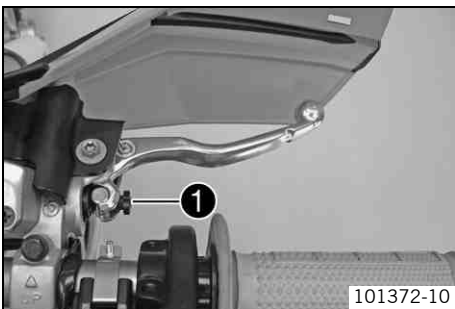

- Check the free travel of the hand brake lever. (☛ p. 65)
- Adjust the basic setting of the hand brake lever to your hand size by turning adjusting screw **1**.



### Info

Turn the adjusting screw clockwise to increase the distance between the hand brake lever and the handlebar.  
Turn the adjusting screw counterclockwise to decrease the distance between the hand brake lever and the handlebar.  
The range of adjustment is limited.  
Turn the adjusting screw by hand only, and do not apply any force.  
Do not make any adjustments while riding!

## Adjusting free travel of hand brake lever (All EXC-F models)

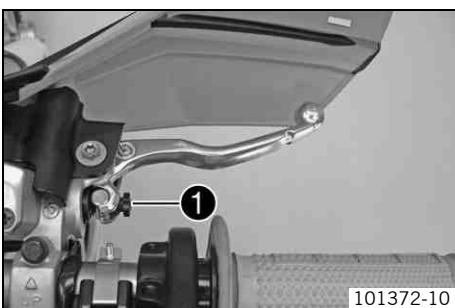

- Check the free travel of the hand brake lever. (☛ p. 65)
- Adjust the free travel of the hand brake lever with adjusting screw **1**.



### Info

Turn the adjustment screw clockwise to reduce free travel. The pressure point moves away from the handlebar.  
Turn the adjustment screw counterclockwise to increase free travel. The pressure point moves towards the handlebar.  
The range of adjustment is limited.  
Turn the adjusting screw by hand only, and do not apply any force.  
Do not make any adjustments while riding!

## Checking the brake discs



### Warning

**Danger of accidents** Reduced braking efficiency due to worn brake disc(s).

- Change the worn brake disc(s) without delay. (Your authorized KTM workshop will be glad to help.)

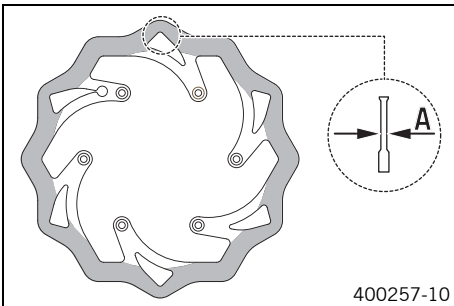

- Check the thickness of the front and rear brake discs at several places on the disk to see if it conforms to measurement **A**.



### Info

Wear reduces the thickness of the brake disc around the area used by the brake linings.

#### Brake discs - wear limit

Front	2.5 mm (0.098 in)
Rear	3.5 mm (0.138 in)

- » If the brake disc thickness is less than the specified value:
  - Change the brake disc.
- Check the front and rear brake discs for damage, cracking and deformation.
  - » If the brake disc shows signs of damage, cracking, or deformation:
    - Change the brake disc.

## Checking the front brake fluid level



### Warning

**Danger of accidents** Failure of the brake system.

- If the brake fluid level falls below the **MIN** mark, this indicates a leakage in the brake system or worn-out brake linings. Check the brake system and do not continue riding. (Your authorized KTM workshop will be glad to help.)



### Warning

**Danger of accidents** Reduced braking effect caused by old brake fluid.

- Change the brake fluid of the front and rear brake according to the service schedule. (Your authorized KTM workshop will be glad to help.)



- Move the brake fluid reservoir mounted on the handlebar to a horizontal position.
- Check the brake fluid level in the viewer **1**.
  - » If the brake fluid is below the **MIN** marking:
    - Add front brake fluid. 🛠️ (📄 p. 66)

## Adding front brake fluid 🛠️



### Warning

**Danger of accidents** Failure of the brake system.

- If the brake fluid level falls below the **MIN** mark, this indicates a leakage in the brake system or worn-out brake linings. Check the brake system and do not continue riding. (Your authorized KTM workshop will be glad to help.)



### Warning

**Skin irritation** Brake fluid can cause skin irritation on contact.

- Avoid contact with skin and eyes, and keep out of the reach of children.
- Wear suitable protective clothing and goggles.
- If brake fluid comes into contact with the eyes, flush the eyes thoroughly with water and consult a physician immediately.

- Warning**  
**Danger of accidents** Reduced braking effect caused by old brake fluid.
- Change the brake fluid of the front and rear brake according to the service schedule. (Your authorized KTM workshop will be glad to help.)

- Warning**  
**Environmental hazard** Hazardous substances cause environmental damage.
- Oil, grease, filters, fuel, cleaners, brake fluid, etc., should be disposed of as stipulated in applicable regulations.

**Info**  
 Never use DOT 5 brake fluid! It is silicone-based and purple in color. Oil seals and brake lines are not designed for DOT 5 brake fluid.  
 Avoid contact between brake fluid and painted parts. Brake fluid attacks paint!  
 Use only clean brake fluid from a sealed container.

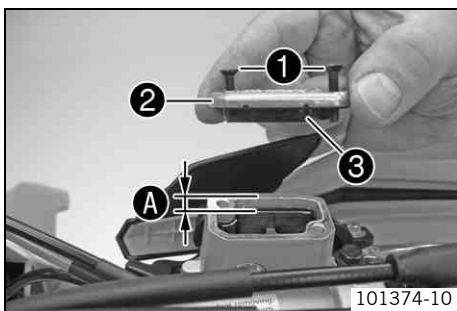

- Move the brake fluid reservoir mounted on the handlebar to a horizontal position.
- Remove screws ❶.
- Remove cover ❷ with membrane ❸.
- Add brake fluid to level A.

**Guideline**

Dimension A (brake fluid level below top edge of container)	5 mm (0.2 in)
---	---------------

Brake fluid DOT 4 / DOT 5.1 (☞ p. 110)

- Position the cover with the membrane. Mount and tighten the screws.

**Info**  
 Clean up overflowed or spilt brake fluid immediately with water.

## Checking the front brake linings

- Warning**  
**Danger of accidents** Reduced braking efficiency caused by worn brake linings.
- Change worn brake linings immediately. (Your authorized KTM workshop will be glad to help.)

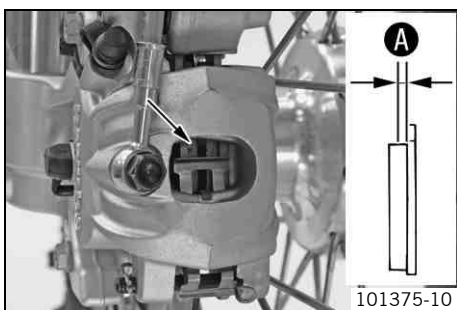

- Check the brake linings for minimum thickness A.

Minimum thickness A	≥ 1 mm (≥ 0.04 in)
---------------------	--------------------

- » If the minimum thickness is less than specified:
  - Change the front brake linings. ☞ (☞ p. 67)
- Check the brake linings for damage and cracking.
  - » If damage or cracking is visible:
    - Change the front brake linings. ☞ (☞ p. 67)

## Changing the front brake linings ☞

- Warning**  
**Danger of accident** Brake system failure.
- Maintenance work and repairs must be carried out professionally. (Your authorized KTM workshop will be glad to help.)

- Warning**  
**Skin irritation** Brake fluid can cause skin irritation on contact.
- Avoid contact with skin and eyes, and keep out of the reach of children.
  - Wear suitable protective clothing and goggles.
  - If brake fluid comes into contact with the eyes, flush the eyes thoroughly with water and consult a physician immediately.

- Warning**  
**Danger of accidents** Reduced braking effect caused by old brake fluid.
- Change the brake fluid of the front and rear brake according to the service schedule. (Your authorized KTM workshop will be glad to help.)

- Warning**  
**Danger of accidents** Reduced braking efficiency due to oil or grease on the brake discs.
- Always keep the brake discs free of oil and grease, and clean them with brake cleaner when necessary.

- Warning**  
**Danger of accidents** Reduced braking efficiency due to use of non-approved brake linings.
- Brake linings available from accessory suppliers are often not tested and approved for use on KTM vehicles. The construction and friction factor of the brake linings and therefore the brake power can differ considerably from the original KTM brake linings. If brake linings are used that differ from the originals, there is no guarantee that they comply with the original license. The vehicle no longer corresponds to the condition at delivery, and the warranty is no longer valid.

- Warning**  
**Environmental hazard** Hazardous substances cause environmental damage.
- Oil, grease, filters, fuel, cleaners, brake fluid, etc., should be disposed of as stipulated in applicable regulations.

- i Info**  
 Never use DOT 5 brake fluid! This is based on silicone oil and is colored purple. Oil seals and brake lines are not designed for DOT 5 brake fluid.  
 Avoid contact between brake fluid and painted parts. Brake fluid attacks paint!  
 Use only clean brake fluid from a sealed container.

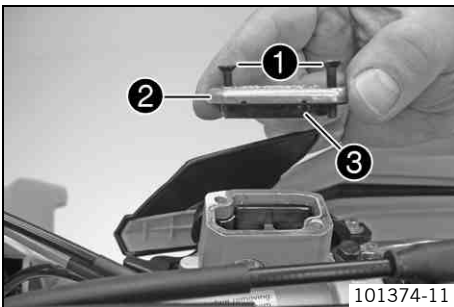

101374-11

- Move the brake fluid reservoir mounted on the handlebar to a horizontal position.
- Remove screws ❶.
- Remove cover ❷ with membrane ❸.
- Press the brake caliper onto the brake disc by hand in order to push back the brake pistons. Ensure that brake fluid does not overflow from the brake fluid reservoir, using suction to remove it if it does.

- i Info**  
 Make sure when pushing back the brake pistons that you do not press the brake caliper against the spokes.

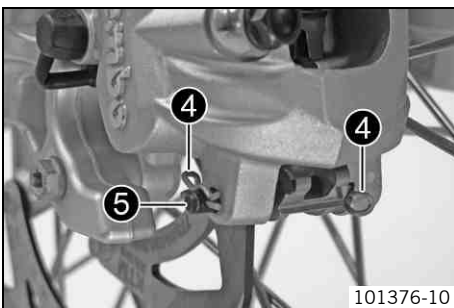

101376-10

- Remove locking split pins ❹, withdraw bolt ❺, and take out the brake linings.
- Clean the brake caliper and brake caliper support.

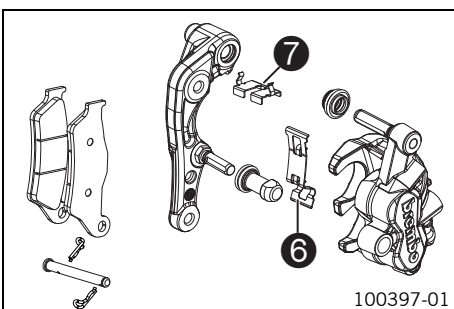

100397-01

- Check that leaf spring ❻ in the brake caliper and sliding plate ❼ in the brake caliper support are seated correctly.

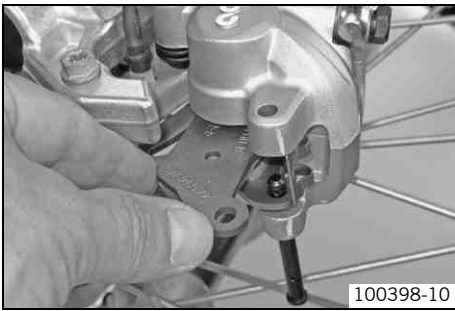

100398-10

- Fit the brake linings, insert the bolt, and mount the locking split pins.
- Operate the hand brake lever repeatedly until the brake linings are in contact with the brake disc and there is a pressure point.

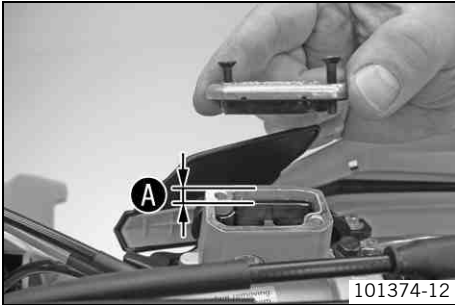

101374-12

- Correct the brake fluid quantity to level **A**.

Guideline

Measurement of <b>A</b>	5 mm (0.2 in)
-------------------------	---------------

Brake fluid DOT 4 / DOT 5.1 (🔧 p. 110)
--

- Position the cover with the membrane. Mount and tighten the screws.

**i Info**  
Clean up overflowed or spilt brake fluid immediately with water.

## Checking the free travel of foot brake lever

**⚠ Warning**  
**Danger of accidents** Brake system failure.

- If there is no free travel on the foot brake lever, pressure builds up on the rear brake circuit. The rear brake can fail due to overheating. Adjust free travel on foot brake lever according to specifications.

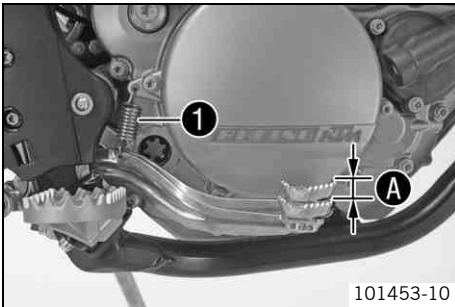

101453-10

- Disconnect spring **1**.
- Move the foot brake lever back and forth between the end stop and the contact to the foot brake cylinder piston and check free travel **A**.

Guideline

Free travel at foot brake lever	3... 5 mm (0.12... 0.2 in)
---------------------------------	----------------------------

- » If the free travel does not meet specifications:
  - Adjust the basic position of the foot brake lever. 🛠 (🔧 p. 69)
- Reconnect spring **1**.

## Adjusting the basic position of the foot brake lever 🛠

**⚠ Warning**  
**Danger of accidents** Brake system failure.

- If there is no free travel on the foot brake lever, pressure builds up on the rear brake circuit. The rear brake can fail due to overheating. Adjust free travel on foot brake lever according to specifications.

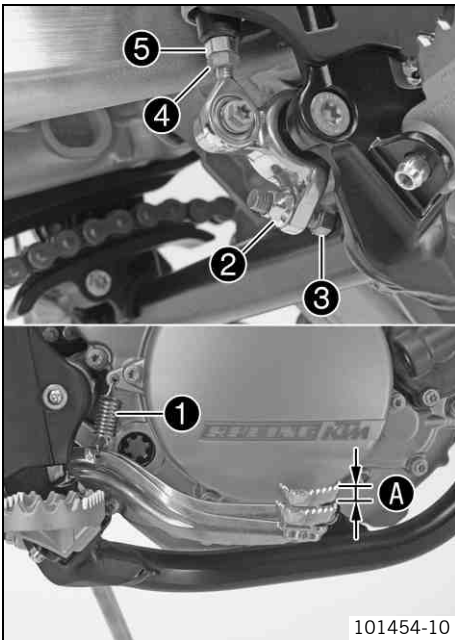

- Disconnect spring ①.
- Loosen nut ④ and, with push rod ⑤, turn it back until you have maximum free travel.
- To adjust the basic position of the foot brake lever individually, loosen nut ② and turn screw ③ accordingly.

**i Info**

The range of adjustment is limited.

- Turn push rod ⑤ accordingly until you have free travel A. If necessary, adjust the basic position of the foot brake lever.

Guideline

Free travel at foot brake lever	3... 5 mm (0.12... 0.2 in)
---------------------------------	----------------------------

- Hold screw ③ and tighten nut ②.

Guideline

Nut, foot brake lever stop	M8	30 Nm (22.1 lbf ft)
----------------------------	----	------------------------

- Hold push rod ⑤ and tighten nut ④.

Guideline

Remaining nuts, chassis	M6	10 Nm (7.4 lbf ft)
-------------------------	----	--------------------

- Reconnect spring ①.

## Checking the rear brake fluid level



**Warning**

**Danger of accidents** Failure of the brake system.

- If the brake fluid level falls below the **MIN** mark, this indicates a leakage in the brake system or worn-out brake linings. Check the brake system and do not continue riding. (Your authorized KTM workshop will be glad to help.)



**Warning**

**Danger of accidents** Reduced braking effect caused by old brake fluid.

- Change the brake fluid of the front and rear brake according to the service schedule. (Your authorized KTM workshop will be glad to help.)

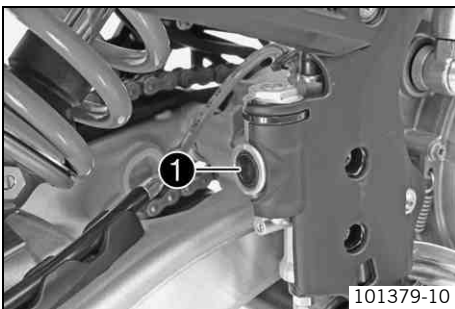

- Stand the vehicle upright.
- Check the brake fluid level in the viewer ①.
  - » When in the viewer ① an air bubble is visible:
    - Add brake fluid to the rear brake circuit. (p. 70)

## Adding brake fluid to the rear brake circuit



**Warning**

**Danger of accidents** Failure of the brake system.

- If the brake fluid level falls below the **MIN** mark, this indicates a leakage in the brake system or worn-out brake linings. Check the brake system and do not continue riding. (Your authorized KTM workshop will be glad to help.)



**Warning**

**Skin irritation** Brake fluid can cause skin irritation on contact.

- Avoid contact with skin and eyes, and keep out of the reach of children.
- Wear suitable protective clothing and goggles.
- If brake fluid comes into contact with the eyes, flush the eyes thoroughly with water and consult a physician immediately.



- Warning**  
**Danger of accidents** Reduced braking effect caused by old brake fluid.
- Change the brake fluid of the front and rear brake according to the service schedule. (Your authorized KTM workshop will be glad to help.)

- Warning**  
**Environmental hazard** Hazardous substances cause environmental damage.
- Oil, grease, filters, fuel, cleaners, brake fluid, etc., should be disposed of as stipulated in applicable regulations.

**Info**  
 Never use DOT 5 brake fluid! It is silicone-based and purple in color. Oil seals and brake lines are not designed for DOT 5 brake fluid.  
 Avoid contact between brake fluid and painted parts. Brake fluid attacks paint!  
 Use only clean brake fluid from a sealed container.

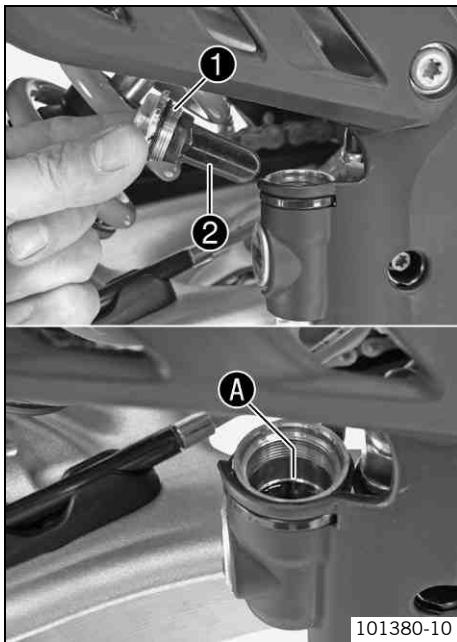

- Stand the vehicle upright.
- Remove screw cap ① with membrane ② and the O-ring.
- Add brake fluid to level A.

Brake fluid DOT 4 / DOT 5.1 (☞ p. 110)
--

- Mount the screw cap with the membrane and the O-ring.

**Info**  
 Clean up overflowed or spilt brake fluid immediately with water.

## Checking the rear brake linings

- Warning**  
**Danger of accidents** Reduced braking efficiency caused by worn brake linings.
- Change worn brake linings immediately. (Your authorized KTM workshop will be glad to help.)

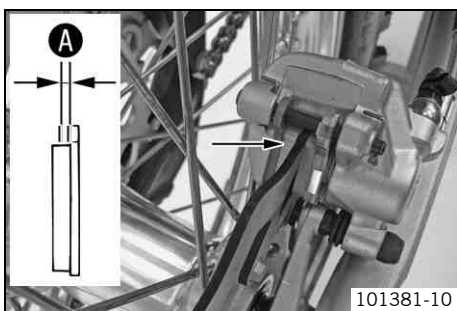

- Check the brake linings for minimum thickness A.

Minimum thickness A	≥ 1 mm (≥ 0.04 in)
---------------------	--------------------

- » If the minimum thickness is less than specified:
  - Change the rear brake linings. ☞ (☞ p. 72)
- Check the brake linings for damage and cracking.
  - » If damage or cracking is visible:
    - Change the rear brake linings. ☞ (☞ p. 72)

## Changing the rear brake linings

- Warning**  
**Danger of accident** Brake system failure.
- Maintenance work and repairs must be carried out professionally. (Your authorized KTM workshop will be glad to help.)
- Warning**  
**Skin irritation** Brake fluid can cause skin irritation on contact.
- Avoid contact with skin and eyes, and keep out of the reach of children.
  - Wear suitable protective clothing and goggles.
  - If brake fluid comes into contact with the eyes, flush the eyes thoroughly with water and consult a physician immediately.
- Warning**  
**Danger of accidents** Reduced braking effect caused by old brake fluid.
- Change the brake fluid of the front and rear brake according to the service schedule. (Your authorized KTM workshop will be glad to help.)
- Warning**  
**Danger of accidents** Reduced braking efficiency due to oil or grease on the brake discs.
- Always keep the brake discs free of oil and grease, and clean them with brake cleaner when necessary.
- Warning**  
**Danger of accidents** Reduced braking efficiency due to use of non-approved brake linings.
- Brake linings available from accessory suppliers are often not tested and approved for use on KTM vehicles. The construction and friction factor of the brake linings and therefore the brake power can differ considerably from the original KTM brake linings. If brake linings are used that differ from the originals, there is no guarantee that they comply with the original license. The vehicle no longer corresponds to the condition at delivery, and the warranty is no longer valid.
- Warning**  
**Environmental hazard** Hazardous substances cause environmental damage.
- Oil, grease, filters, fuel, cleaners, brake fluid, etc., should be disposed of as stipulated in applicable regulations.

- i Info**  
Never use DOT 5 brake fluid! This is based on silicone oil and is colored purple. Oil seals and brake lines are not designed for DOT 5 brake fluid.  
Avoid contact between brake fluid and painted parts. Brake fluid attacks paint!  
Use only clean brake fluid from a sealed container.



- Stand the vehicle upright.
- Remove screw cap **1** with membrane **2** and the O-ring.
- Press the brake piston back to its basic position and make sure that no brake fluid overflows from the brake fluid reservoir.

- i Info**  
Make sure when pushing back the brake piston that you do not press the brake caliper against the spokes.

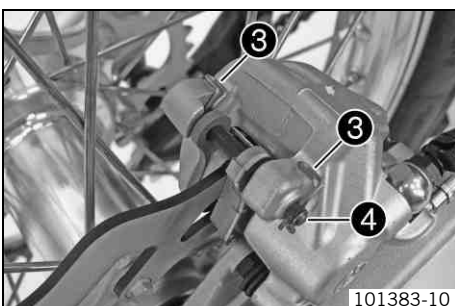

- Remove locking split pins **3**, withdraw bolt **4**, and take out the brake linings.
- Clean the brake caliper and brake caliper support.

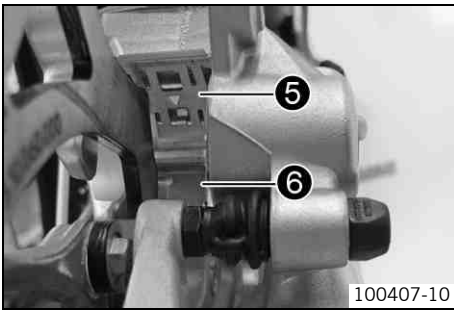

- Check that leaf spring ⑤ in the brake caliper and sliding plate ⑥ in the brake caliper support are seated correctly.

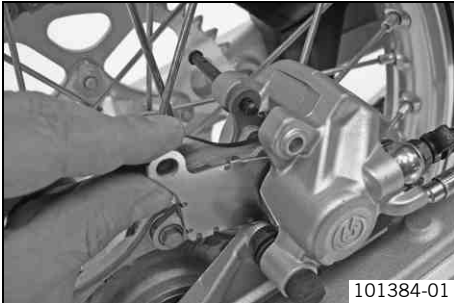

- Fit the brake linings, insert the bolt, and mount the locking split pins.
- Operate the foot brake lever repeatedly until the brake linings are in contact with the brake disc and there is a pressure point.

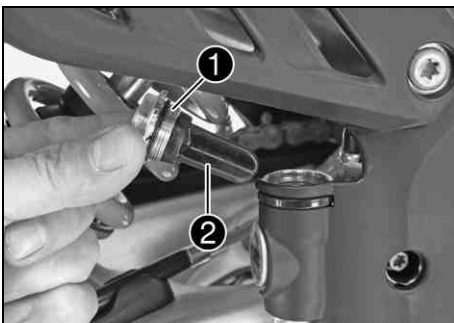

- Add brake fluid to level **A**.

Brake fluid DOT 4 / DOT 5.1 (☞ p. 110)

- Mount screw cap ① with membrane ② and the O-ring.

**i** **Info**

Clean up overflowed or spilt brake fluid immediately with water.

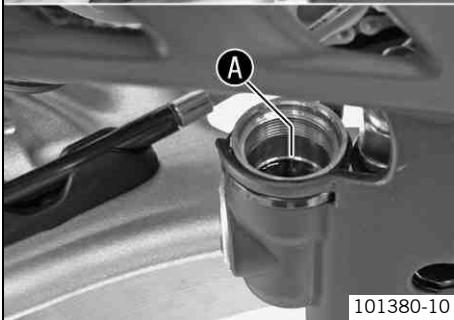

## Removing the front wheel



- Raise the motorcycle with the lift stand. (☛ p. 42)
- Press the brake caliper onto the brake disc by hand in order to push back the brake pistons.

**i Info**

Make sure when pushing back the brake pistons that you do not press the brake caliper against the spokes.

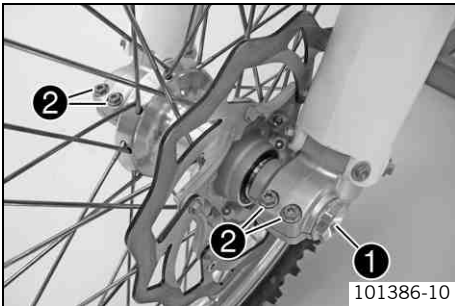

- Remove screw ❶.
- Release screws ❷.

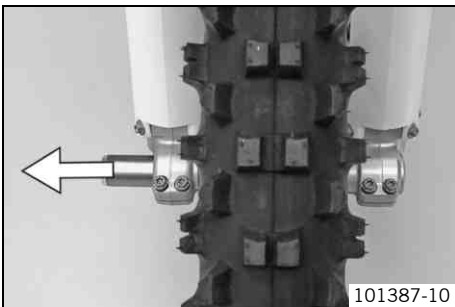

- Holding the front wheel, withdraw the wheel spindle. Take the front wheel out of the fork.

**i Info**

Do not pull the hand brake lever when the front wheel is removed. Always lay the wheel down in such a way that the brake disc is not damaged.

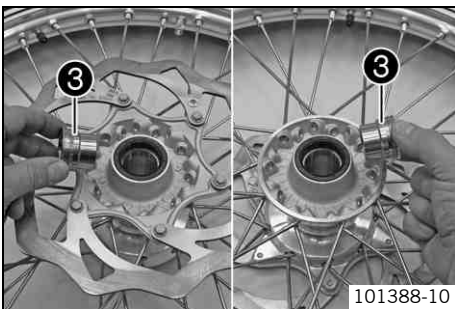

- Remove spacers ❸.

## Installing the front wheel



**Warning**

**Danger of accidents** Reduced braking efficiency due to oil or grease on the brake discs.

- Always keep the brake discs free of oil and grease, and clean them with brake cleaner when necessary.

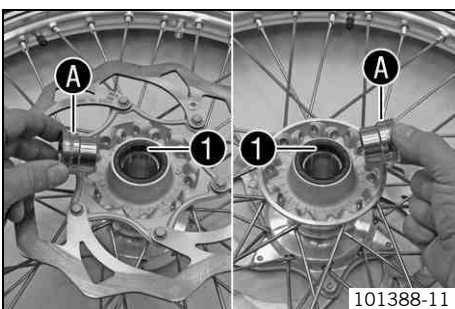

- Check the wheel bearing for damage and wear.
  - » If the wheel bearing is damaged or worn:
    - Change the wheel bearing. ☛
- Clean and grease shaft seal rings ❶ and bearing surface A of the spacers.

Long-life grease (☛ p. 112)

- Insert the spacers.

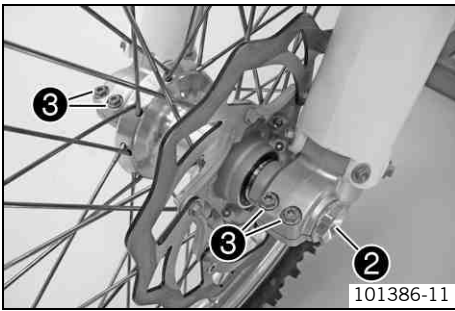

- Lift the front wheel into the fork, position it, and insert the wheel spindle.
- Mount and tighten screw ②.

Guideline

Screw, front wheel spindle	M24x1.5	45 Nm (33.2 lbf ft)
----------------------------	---------	------------------------

- Activate the hand brake lever multiple times until the brake linings are in contact with the brake disc.
- Remove the motorcycle from the lift stand. (☛ p. 42)
- Pull the front wheel brake and push down hard on the fork several times to align the fork legs.
- Fully tighten screw ③.

Guideline

Screw, fork stub	M8	15 Nm (11.1 lbf ft)
------------------	----	------------------------

## Removing the rear wheel ☛

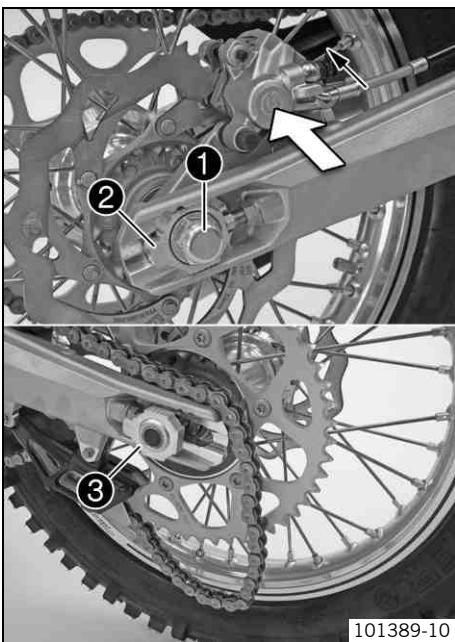

- Raise the motorcycle with the lift stand. (☛ p. 42)
- Press the brake caliper by hand on to the brake disc in order to press back the brake piston.

**i** Info

Make sure when pushing back the brake piston that you do not press the brake caliper against the spokes.

- Remove nut ①.
- Remove chain adjuster ②. Withdraw wheel spindle ③ only enough to allow the rear wheel to be pushed forward.
- Push the rear wheel forward as far as possible. Remove the chain from the rear sprocket.
- Holding the rear wheel, withdraw the wheel spindle. Take the rear wheel out of the swingarm.

**i** Info

Do not operate the foot brake when the rear wheel is removed. Always lay the wheel down in such a way that the brake disc is not damaged.

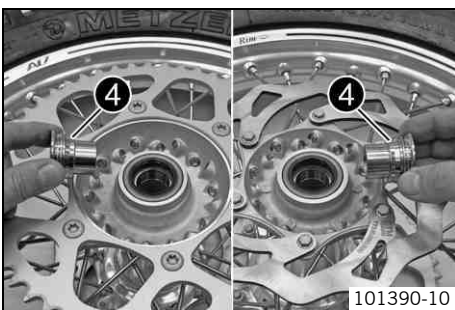

- Remove spacers ④.

## Installing the rear wheel ☛

**!** Warning

**Danger of accidents** Reduced braking efficiency due to oil or grease on the brake discs.

- Always keep the brake discs free of oil and grease, and clean them with brake cleaner when necessary.

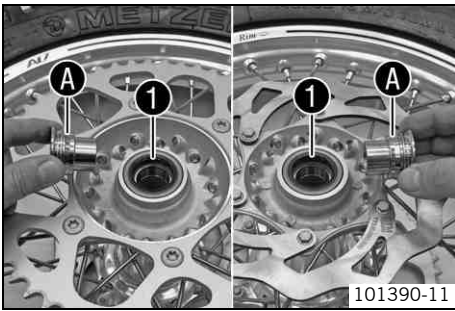

- Check the wheel bearing for damage and wear.
  - » If the wheel bearing is damaged or worn:
    - Change the wheel bearing. 🛠️
- Clean and grease shaft seal rings ① and bearing surface ①A of the spacers.

Long-life grease (👉 p. 112)

- Insert the spacers.

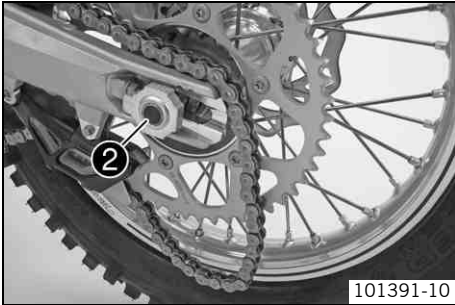

- Lift the rear wheel into the swing arm, position it, and insert the wheel spindle ②.
- Put the chain on.

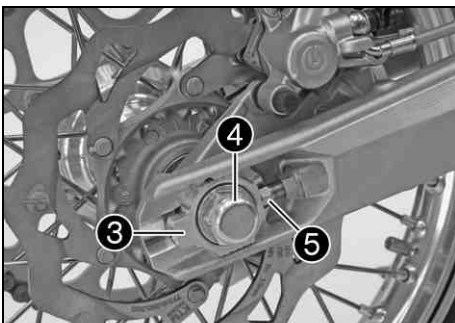

- Position chain adjuster ③. Mount nut ④ but do not tighten it yet.
- Make sure that chain adjusters ③ are fitted correctly on adjusting screws ⑤.
- Check the chain tension. (👉 p. 58)
- Tighten nut ④.

**Guideline**

Nut, rear wheel spindle	M20x1.5	80 Nm (59 lbf ft)
-------------------------	---------	-------------------

**i Info**

The wide adjustment range of the chain adjusters (32 mm (1.18 in)) enables different secondary ratios with the same chain length. Chain adjusters ③ can be turned by 180°.

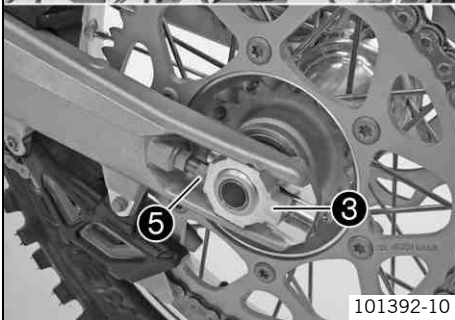

- Operate the foot brake lever repeatedly until the brake linings are in contact with the brake disc and there is a pressure point.
- Remove the motorcycle from the lift stand. (👉 p. 42)

## Checking the tire condition

**i Info**

Only mount tires approved and/or recommended by KTM. Other tires could have a negative effect on handling characteristics. The type, condition, and air pressure of the tires all have a significant impact on the handling characteristics of the motorcycle. The tires mounted on the front and rear wheels must have a similar profile. Worn tires have a negative effect on handling characteristics, especially on wet surfaces.

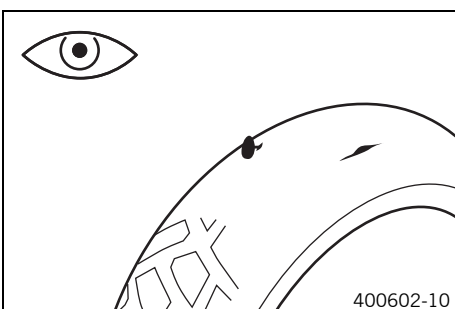

- Check the front and rear tires for cuts, run-in objects, and other damage.
  - » If the tire exhibits cuts, run-in objects, or other damage:
    - Change the tire.
- Check the depth of the tread.

**i Info**

Note local national regulations concerning the minimum tread depth.

Minimum tread depth	≥ 2 mm (≥ 0.08 in)
---------------------	--------------------

- » If the tread depth is less than the minimum permissible depth:

- Change the tire.
- Check the tire age.



**Info**

The tire's date of manufacture is usually part of the tire markings and is indicated by the last four digits of the **DOT** marking. The first two digits indicate the week of manufacture and the last two digits the year of manufacture.

KTM recommends that the tires be changed after 5 years at the latest, regardless of the actual state of wear.

- » If the tire is older than five years:
  - Change the tire.

## Checking tire air pressure



**Info**

Low tire air pressure leads to abnormal wear and overheating of the tire. Correct tire air pressure ensures optimal riding comfort and maximum tire service life.

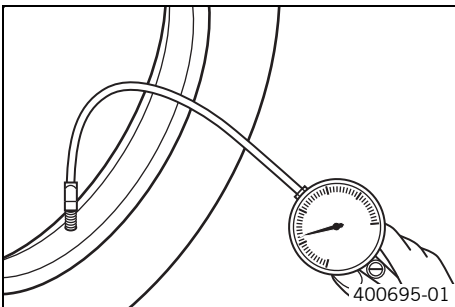

- Remove the dust cap.
- Check tire air pressure when tires are cold.

Tire air pressure off road	
Front	1.0 bar (15 psi)
Rear	1.0 bar (15 psi)

Road tire pressure (All EXC-F models)	
Front	1.5 bar (22 psi)
Rear	2.0 bar (29 psi)

- » If the tire pressure does not meet specifications:
  - Correct the tire air pressure.
- Fit the dust cap.

## Checking spoke tension



**Warning**

**Danger of accidents** Instable handling due to incorrect spoke tension.

- Ensure that the spoke tension is correct. (Your authorized KTM workshop will be glad to help.)



**Info**

A loose spoke can cause wheel imbalance, which leads to more loose spokes in a short time. If the spokes are too tight, they can break due to local overload. Check the spoke tension regularly, especially on a new motorcycle.

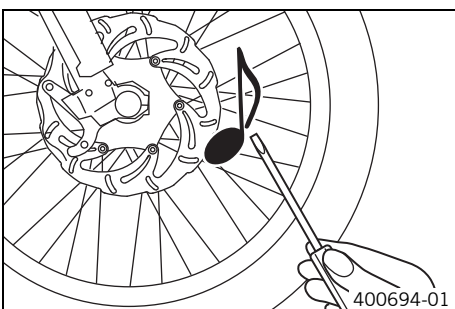

- Tap each spoke with a screwdriver.



**Info**

The sound frequency depends on the length and thickness of the spoke. If there are different sound frequencies in spokes with the same length and thickness, this indicates different spoke tensions.

You should hear a high note.

- » If the spoke tension varies:
  - Correct the spoke tension. 🛠️
- Check the spoke torque.

Guideline

Spoke nipple, front wheel	M4.5	5... 6 Nm (3.7... 4.4 lbf ft)
Spoke nipple, rear wheel	M5	5... 6 Nm (3.7... 4.4 lbf ft)

Torque wrench with various accessories in set (58429094000)



## Removing the battery

- Warning**  
**Risk of injury** Battery acid and battery gases cause serious chemical burns.
- Keep batteries out of the reach of children.
  - Wear suitable protective clothing and goggles.
  - Avoid contact with battery acid and battery gases.
  - Keep the battery away from sparks or open flames. Charge only in well-ventilated areas.
  - In the event of skin contact, rinse with large amounts of water. If battery acid gets in the eyes, rinse with water for at least 15 minutes and contact a physician.

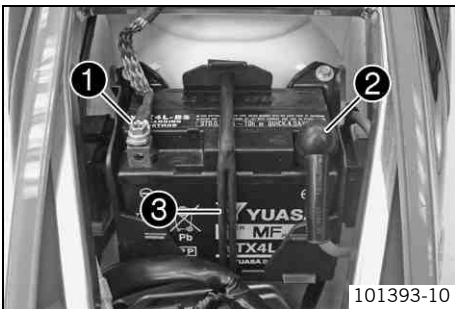

- Switch off all power consumers and switch off the engine.
- Remove the seat. (☛ p. 52)
- Disconnect negative cable ① of the battery.
- Pull back the positive terminal cover ② and disconnect the positive (plus) cable of the battery.
- Detach rubber band ③ at the bottom.
- Lift the battery up and out.

## Installing the battery

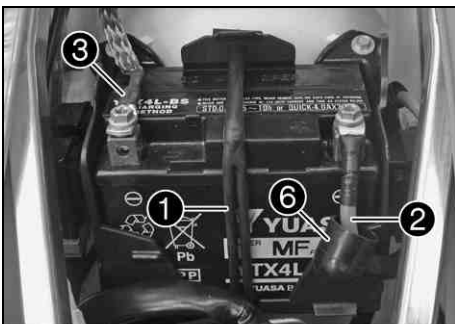

- Insert battery into the battery compartment with the terminals facing to the front.
- Battery (YTX4L-BS) (☛ p. 105)
- Reconnect rubber band ①.
  - Connect positive cable ② and negative cable ③.

### Guideline

Screw, battery terminal	M5	2.5 Nm (1.84 lbf ft)
-------------------------	----	-------------------------

**i Info**  
 Contact disks ④ must be mounted between battery terminals ④ and cable sockets ⑤ with the claws facing up.

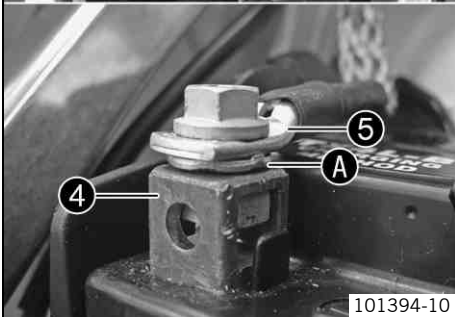

- Slide positive terminal cover ⑥ over the positive terminal.
- Mount the seat. (☛ p. 52)

## Charging the battery

- Warning**  
**Risk of injury** Battery acid and battery gases cause serious chemical burns.
- Keep batteries out of the reach of children.
  - Wear suitable protective clothing and goggles.
  - Avoid contact with battery acid and battery gases.
  - Keep the battery away from sparks or open flames. Charge only in well-ventilated areas.
  - In the event of skin contact, rinse with large amounts of water. If battery acid gets in the eyes, rinse with water for at least 15 minutes and contact a physician.



**Warning**

**Environmental hazard** The battery contains elements that are harmful to the environment.

- Do not discard batteries with the household trash. Dispose of a defective battery in an environmentally compatible manner. Give the battery to your KTM dealer or to a recycling center that accepts used batteries.



**Warning**

**Environmental hazard** Hazardous substances cause environmental damage.

- Oil, grease, filters, fuel, cleaners, brake fluid, etc., should be disposed of as stipulated in applicable regulations.



**Info**

Even when there is no load on the battery, it still loses power steadily. The charge state and the type of charge are very important for the service life of the battery. Rapid recharging with a high charging current shortens the battery's service life. If the charging current, charging voltage and charging time are exceeded, electrolyte escapes through the safety valves. This reduces the battery capacity. If the battery is depleted from starting the vehicle repeatedly, the battery must be charged immediately. If the battery is left in a discharged state for an extended period, it will become over-discharged and sulfate, destroying the battery. The battery is maintenance-free, which means that the acid level does not need to be checked.

- Switch off all power consumers and switch off the engine.
- Remove the seat. (☛ p. 52)
- Disconnect the negative cable of the battery to avoid damage to the onboard electronics.
- Connect the battery charger to the battery. Switch on the battery charger.



Battery charger (58429074000)

You can also use the battery charger to test the open-circuit voltage and starting voltage of the battery, and to test the alternator. With this device, you cannot over-charge the battery.



**Info**

Never remove lid ❶. Charge the battery with at most 10% of the capacity specified on the battery housing ❷.

- Switch off the battery charger after charging. Disconnect the battery.

**Guideline**

The charge current, charge voltage, and charge time must not be exceeded.

Charge the battery regularly when the motorcycle is not in use	3 months
--	----------

- Mount the seat. (☛ p. 52)

## Changing the main fuse



**Warning**

**Fire hazard** The electrical system can be overloaded if the wrong fuses are used.

- Use only fuses with the prescribed amperage. Never by-pass or repair fuses.



**Info**

The main fuse protects all power consumers of the vehicle. It is located in the starter relay housing under the filter box cover.

- Switch off all power consumers and switch off the engine.
- Remove the air filter box lid. (☛ p. 52)

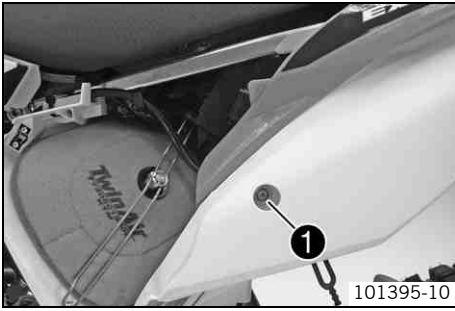

- Remove screw ❶.

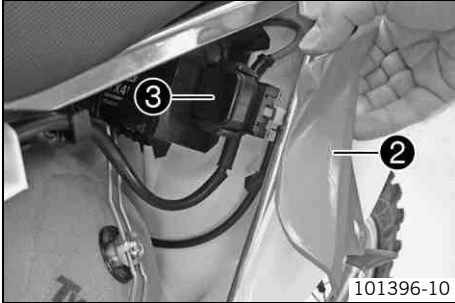

- Lift rear fairing ❷ slightly and pull starter relay ❸ out of the bracket.

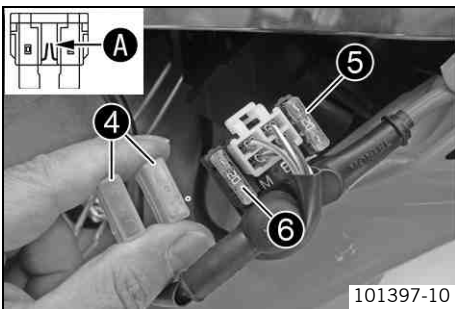

- Remove protection caps ❹.
- Remove the faulty main fuse ❺.

**i Info**  
A defective fuse can be identified by the burned-out fuse wire **A**.  
A reserve fuse **6** is located in the starter relay.

- Install a new main fuse.

Fuse (58011109120) (☛ p. 105)
-------------------------------

- Check that the electrical equipment is functioning properly.

**i Tip**  
Insert the spare fuse so that it is available if needed.

- Mount the protection caps.
- Mount the starter relay onto the bracket and lay the cable.
- Position the rear fairing. Mount and tighten the screw.

**Guideline**

Remaining screws, chassis	M6	10 Nm (7.4 lbf ft)
---------------------------	----	--------------------

- Install the air filter box lid. (☛ p. 52)

## Changing the fuses of individual power consumers

**i Info**  
The fuse box containing the fuses of individual power consumers is located under the seat.

- Switch off all power consumers and switch off the engine.
- Remove the seat. (☛ p. 52)
- Open fuse box cover ❶.



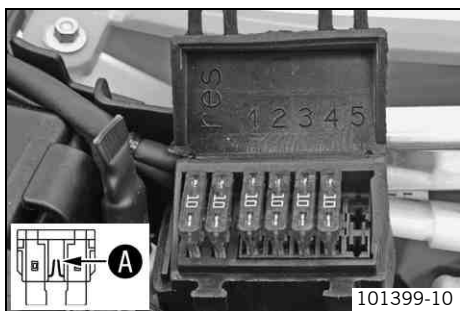

- Remove the defective fuse.

Guideline

Fuse 1 - 10 A - EFI control unit
Fuse 2 - 10 A - fuel pump
Fuse 3 - 10 A - high beam, low beam, parking light, tail light, license plate lamp
Fuse 4 - 10 A - horn, brake light, turn signal, radiator fan (optional)
Fuse 5 - not used
Fuses res - 10 A - spare fuses

**Info**  
A defective fuse can be identified by the burned-out fuse wire **A**.

**Warning**  
**Fire hazard** The electrical system can be overloaded if the wrong fuses are used.

- Use only fuses with the prescribed amperage. Never by-pass or repair fuses.

- Use spare fuses with the correct rating only.

Fuse (58011109110) (☞ p. 105)

**Tip**  
Replace the spare fuse in the fuse box so that it is available if needed.

- Check that the power consumer is functioning properly.
- Close the fuse box cover.
- Mount the seat. (☞ p. 52)

## Changing the fuse of the radiator fan (EXC-F SIX DAYS)

**Warning**  
**Fire hazard** The electrical system can be overloaded if the wrong fuses are used.

- Use only fuses with the prescribed amperage. Never by-pass or repair fuses.

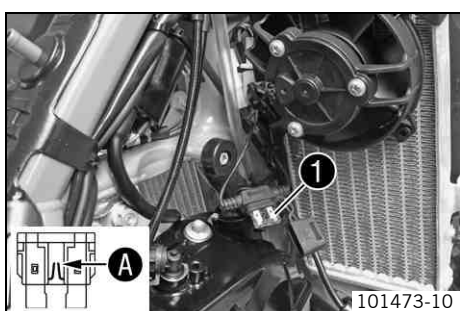

- Remove the fuel tank. (☞ p. 55)
- Remove protection.

**Info**  
The radiator fan fuse **1** is in the area of the right-hand radiator.

- Remove the defective fuse.
- Insert a new fuse.

Fuse (58011109105) (☞ p. 105)

**Info**  
Replace a faulty fuse by an equivalent fuse only.

- Mount protection cap.
- Install the fuel tank. (☞ p. 56)

### Removing headlight mask with headlight

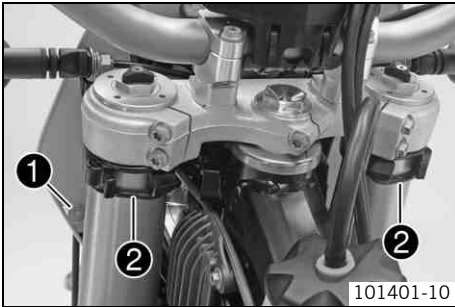

- Switch off all electrical equipment.
- Remove screw ① and take off clamp.
- Loosen the rubber band ②. Push up the headlight mask and swing it forwards.

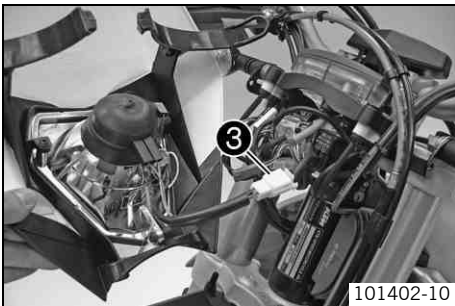

- Pull out the electric plug connector ③ and remove the headlight mask with the headlight.

### Refitting the headlight mask with the headlight



- Connect the electric plug connector ①.

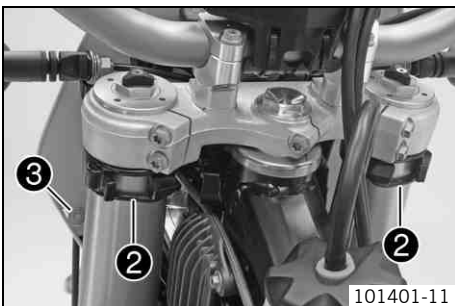

- Position the headlight mask and fix it with the rubber band ②.



#### Info

Ensure that the retaining lugs engage in the fender.

- Position the brake line and wiring harness. Put the clamp on, mount and tighten screw ③.
- Check the headlight setting. (☛ p. 84)

### Changing the headlight bulb

#### Note

**Damage to reflector** Reduced luminance.

- Grease on the lamp will evaporate due to the heat and be deposited on the reflector. Clean the lamp and keep it free of grease before mounting.

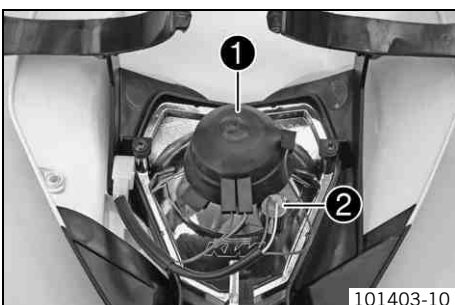

- Remove the headlight mask with the headlight. (☛ p. 83)
- Turn rubber cap ① together with the underlying lamp socket counterclockwise all the way and remove it.
- Pull lamp socket ② of the parking light out of the reflector.

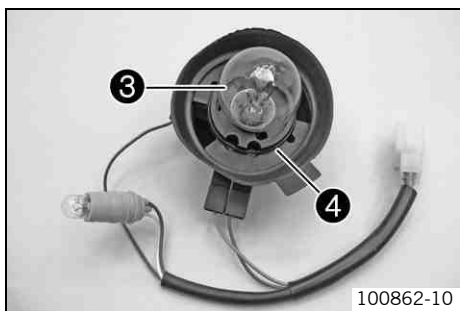

- Press headlight bulb ③ into the lamp socket lightly, turn it counterclockwise all the way and pull it out.
  - Insert a new headlight bulb.
- |  |
|--|
| Headlight (S2 / socket BA20d) (☛ p. 105) |
|--|
- Insert the rubber cap together with the lamp socket into the reflector and turn it clockwise all the way.



**Info**

Ensure that the O-ring ④ is seated properly.

- Insert the lamp socket of the parking light into the reflector.
- Refit the headlight mask with the headlight. (☛ p. 83)

## Checking the headlight setting

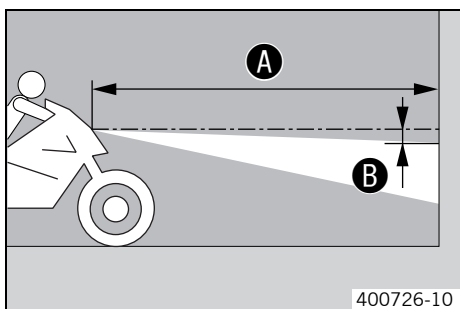

- Position the vehicle upright on a horizontal surface in front of a light wall and make a mark at the height of the center of the low beam headlight.
- Make another mark a distance ② under the first mark.

Guideline

Distance ②	5 cm (2 in)
------------	-------------

- Position the vehicle vertically a distance ① away from the wall.

Guideline

Distance ①	5 m (16 ft)
------------	-------------

- The rider now sits down on the motorcycle.
- Switch on the low beam.
- Check the headlight setting.

The boundary between light and dark must be exactly on the lower mark for a motorcycle with driver.
---

- » If the light-dark border does not meet specifications:
  - Adjust the headlight range. (☛ p. 84)

## Adjusting the headlight range

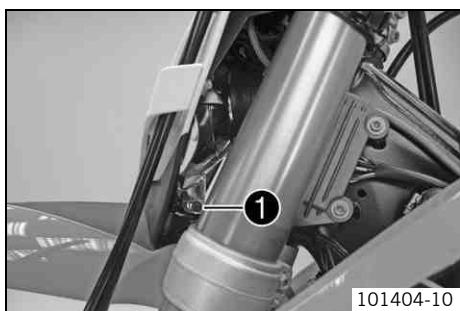

- Check the headlight setting. (☛ p. 84)
- Loosen screw ①.
- Adjust the headlight range of the headlight by moving it up or down.

Guideline

The boundary between light and dark must be exactly on the lower mark for a motorcycle with a rider (mark is applied under: Checking the headlight setting).
--



**Info**

A change in weight on the vehicle may require a correction of the headlight range.

- Tighten screw ①.

## Changing the speedometer battery

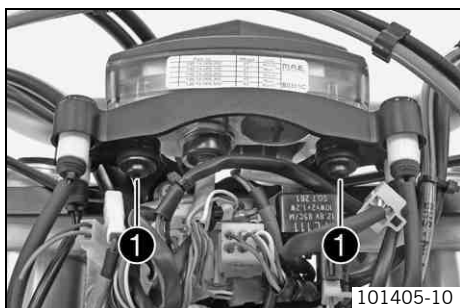

- Remove the headlight mask with the headlight. (☛ p. 83)
- Remove screws ①.
- Pull the speedometer out of the bracket from above.

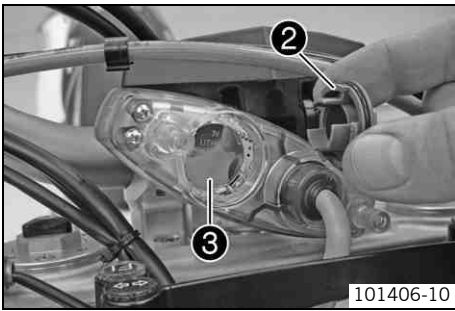

- Using a coin, turn locking cap ② counterclockwise all the way and remove it.
- Remove speedometer battery ③.
- Insert the new battery with the label facing upward.

Speedometer battery (CR 2430) (☛ p. 105)

- Check that the O-ring of the locking cap is seated properly.

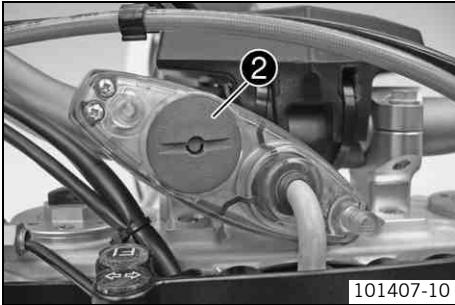

- Position locking cap ② and, using a coin, turn it clockwise all the way.
- Press any button on the speedometer.
  - ✓ The speedometer is activated.
- Position the speedometer in the bracket.
- Mount and tighten the screws with washers.
- Refit the headlight mask with the headlight. (☛ p. 83)
- Set kilometers or miles. (☛ p. 15)
- Adjust the speedometer functions. (☛ p. 16)
- Set the clock. (☛ p. 15)

## Cooling system

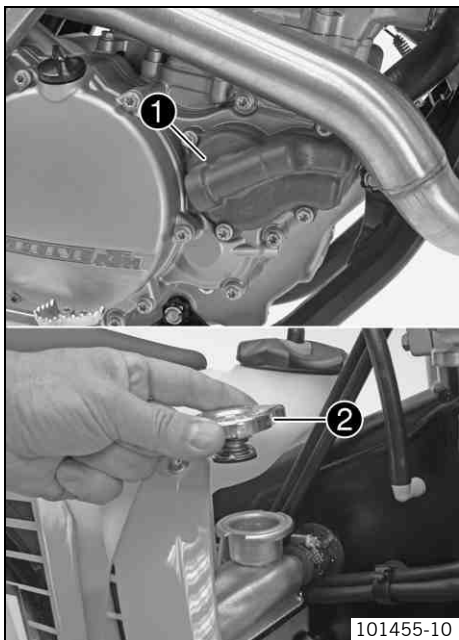

Water pump ❶ in the engine circulates the coolant.

The pressure resulting from the warming of the cooling system is regulated by a valve in radiator cap ❷. This ensures that operating the vehicle at the specified coolant temperature will not result in a risk of malfunctions.

120 °C (248 °F)
-----------------

Cooling is effected by the air stream.

The lower the speed, the less the cooling effect. Dirty cooling fins also reduce the cooling effect.

### (EXC-F SIX DAYS)

The radiator fan provides extra cooling. It is controlled by a thermostwitch.

## Checking the antifreeze and coolant level



### Warning

**Danger of scalding** During motorcycle operation, the coolant gets very hot and is under pressure.

- Do not remove the radiator cap, radiator hoses or other cooling system components when the engine is hot. Allow the engine and cooling system to cool down. In case of scalding, rinse immediately with lukewarm water.



### Warning

**Danger of poisoning** Coolant is poisonous and a health hazard.

- Avoid contact between coolant and skin, eyes and clothing. If it gets into your eyes, rinse immediately with water and contact a doctor. Wash affected skin areas immediately with soap and water. If coolant is swallowed, contact a doctor immediately. Change clothes that have come into contact with coolants. Keep coolant out of the reach of children.

### Condition

The engine is cold.

- Stand the motorcycle upright on a horizontal surface.
- Remove the radiator cap.
- Check antifreeze of coolant.

-25... -45 °C (-13... -49 °F)
-------------------------------

» If the antifreeze of the coolant does not meet specifications:

- Correct the antifreeze of the coolant.

- Check the coolant level in the radiator.

Coolant level A above radiator fins.	10 mm (0.39 in)
--------------------------------------	-----------------

» If the coolant level does not meet specifications:

- Correct the coolant level.

### Alternative 1

Coolant (☛ p. 110)
--------------------

### Alternative 2

Coolant (mixed ready to use) (☛ p. 110)
---

- Mount the radiator cap.

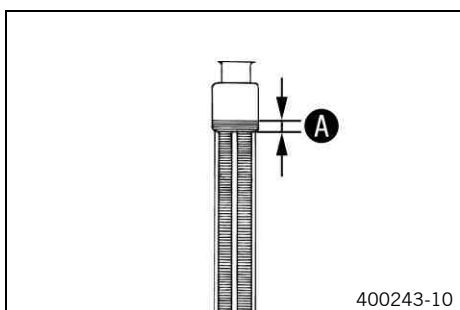



## Checking the coolant level



### Warning

**Danger of scalding** During motorcycle operation, the coolant gets very hot and is under pressure.

- Do not remove the radiator cap, radiator hoses or other cooling system components when the engine is hot. Allow the engine and cooling system to cool down. In case of scalding, rinse immediately with lukewarm water.



### Warning

**Danger of poisoning** Coolant is poisonous and a health hazard.

- Avoid contact between coolant and skin, eyes and clothing. If it gets into your eyes, rinse immediately with water and contact a doctor. Wash affected skin areas immediately with soap and water. If coolant is swallowed, contact a doctor immediately. Change clothes that have come into contact with coolants. Keep coolant out of the reach of children.

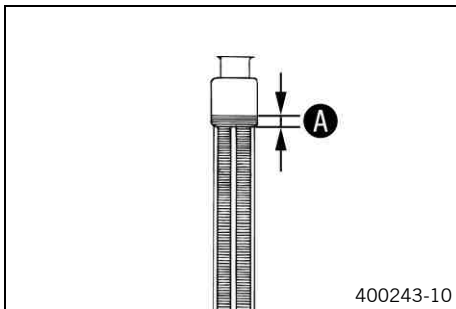

### Condition

The engine is cold.

- Stand the motorcycle upright on a horizontal surface.
- Remove the radiator cap.
- Check the coolant level in the radiator.

Coolant level <b>A</b> above radiator fins.	10 mm (0.39 in)
---	-----------------

» If the coolant level does not meet specifications:

- Correct the coolant level.

### Alternative 1

Coolant (☞ p. 110)
--------------------

### Alternative 2

Coolant (mixed ready to use) (☞ p. 110)
---

- Mount the radiator cap.

## Draining the coolant



### Warning

**Danger of scalding** During motorcycle operation, the coolant gets very hot and is under pressure.

- Do not remove the radiator cap, radiator hoses or other cooling system components when the engine is hot. Allow the engine and cooling system to cool down. In case of scalding, rinse immediately with lukewarm water.



### Warning

**Danger of poisoning** Coolant is poisonous and a health hazard.

- Avoid contact between coolant and skin, eyes and clothing. If it gets into your eyes, rinse immediately with water and contact a doctor. Wash affected skin areas immediately with soap and water. If coolant is swallowed, contact a doctor immediately. Change clothes that have come into contact with coolants. Keep coolant out of the reach of children.

### Condition

The engine is cold.

- Position the motorcycle upright.
- Place a suitable container under the water pump cover.
- Remove screw **1**. Take off radiator cap **2**.
- Completely drain the coolant.
- Mount and tighten screw **1** with a new seal ring.

### Guideline

Screw, water pump cover	M6	10 Nm (7.4 lbf ft)
-------------------------	----	--------------------

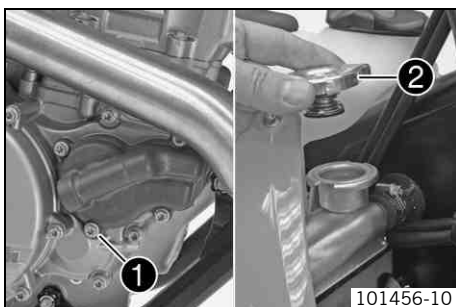

## Refilling coolant



### Warning

**Danger of poisoning** Coolant is poisonous and a health hazard.

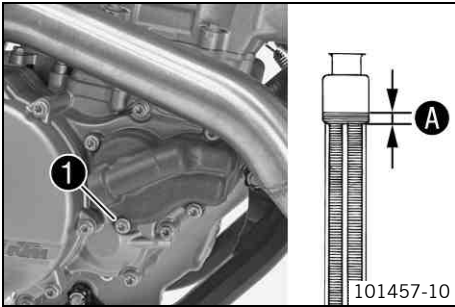

- Avoid contact between coolant and skin, eyes and clothing. If it gets into your eyes, rinse immediately with water and contact a doctor. Wash affected skin areas immediately with soap and water. If coolant is swallowed, contact a doctor immediately. Change clothes that have come into contact with coolants. Keep coolant out of the reach of children.



- Make sure that the screw ❶ is tightened.
- Stand the vehicle upright.
- Pour coolant in up to measurement ❶ above the radiator fins.

Guideline

10 mm (0.39 in)

Coolant	1.2 l (1.3 qt.)	Coolant (  p. 110)
		Coolant (mixed ready to use) (  p. 110)

- Refit the radiator cap.
- Make a short test ride.
- Check the coolant level. ( p. 87)

## Checking the play in the throttle cable

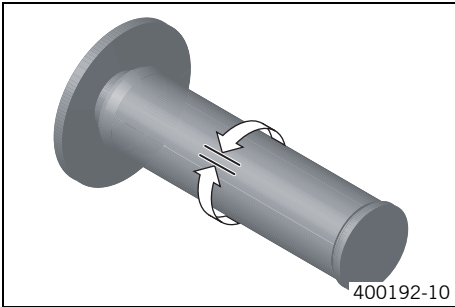

- Check the throttle grip for smooth operation.
- Move the handlebar to the straight-ahead position. Move the throttle grip backwards and forwards to ascertain the play in the throttle cable.

Play in throttle cable	3... 5 mm (0.12... 0.2 in)
------------------------	----------------------------

- » If the throttle cable play does not meet specifications:
  - Adjust the play in the throttle cable. 🛠️ (📖 p. 89)



### Danger

**Danger of poisoning** Exhaust gases are poisonous and inhaling them may result in unconsciousness and/or death.

- When running the engine, always make sure there is sufficient ventilation, and do not start or run the engine in an enclosed space without an effective exhaust extraction system.

- Start the engine and let it run idle. Move the handlebar to and fro over the entire steering range.

The idle speed must not change.
---------------------------------

- » If the idle speed changes:
  - Adjust the play in the throttle cable. 🛠️ (📖 p. 89)

## Adjusting the play in the throttle cable 🛠️

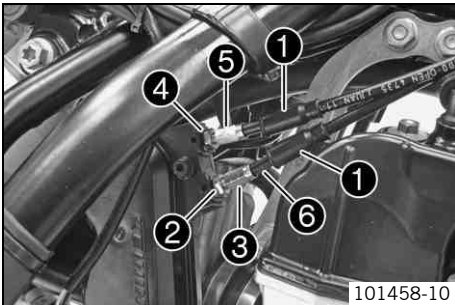

- Check the throttle cable routing. (📖 p. 62)
- Move the handlebar to the straight-ahead position.
- Push back sleeves ❶.
- Loosen nut ❷. Turn adjusting screw ❸ in as far as possible.
- Loosen nut ❹. Turn adjusting screw ❺ so that there is play in the throttle cable at the throttle grip.

### Guideline

Play in throttle cable	3... 5 mm (0.12... 0.2 in)
------------------------	----------------------------

- Tighten nut ❹.
- Press and hold the throttle grip in the closed setting. Turn adjusting screw ❸ out until there is no play in throttle cable ❻.
- Tighten nut ❷.
- Push sleeves ❶ on. Check the throttle grip for smooth operation.
- Install the fuel tank. 🛠️ (📖 p. 56)
- Check the play in the throttle cable. (📖 p. 89)

## Setting the engine characteristics (EXC-F SIX DAYS)



### Danger

**Loss of approval for road use and insurance coverage** The motorcycle is authorized for public road traffic in the homologous (reduced) version only.

- In the derestricted version, the motorcycle must be used only on closed off property remote from public road traffic.

- Remove the seat. (📖 p. 52)

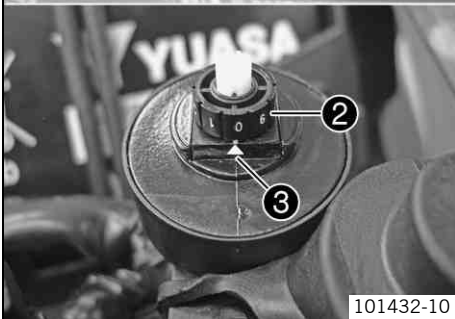
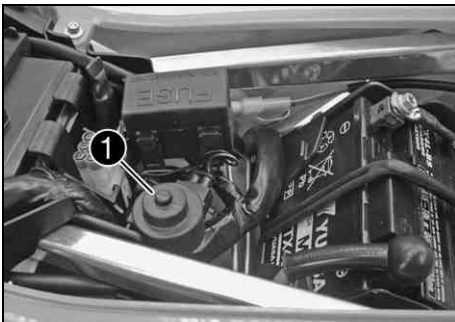

101432-10

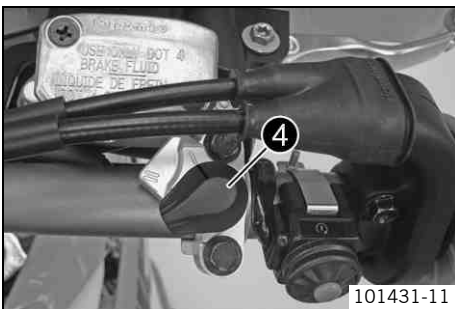

101431-11

**On the Map-Select switch for the basic setting:**

- Pull off rubber cap ❶ of **Map-Select**.
- Turn adjusting wheel ❷ until the desired number is aligned with marking ❸.

**SOFT:**

- Set the adjusting wheel to position 1.
- ✓ Soft – The mapping with reduced peak performance for better rideability is activated.

**ADVANCED:**

- Set the adjusting wheel to position 2.
- ✓ ADVANCED – The mapping for performance with a very direct response is activated.

**STANDARD:**

- Set the adjusting wheel to position 3, 4, 5, 6, 7, 8, 9 oder 0.
- ✓ Standard – The mapping for performance with a balanced response is activated.
- Position the rubber cap of the **Map-Select** switch.

**On the Map-Select switch for vehicle operation:**

- Turn lever ❹ to the desired setting.

**STANDARD:**

- Turn lever to position I.

**SOFT:**

**Condition**

The **Map-Select** switch for the basic setting is at position 1.

- Turn lever to position II.

**ADVANCED:**

**Condition**

The **Map-Select** switch for the basic setting is at position 2.

- Turn lever to position II.
- Mount the seat. (☛ p. 52)

## Adjusting the idle speed 🛠️

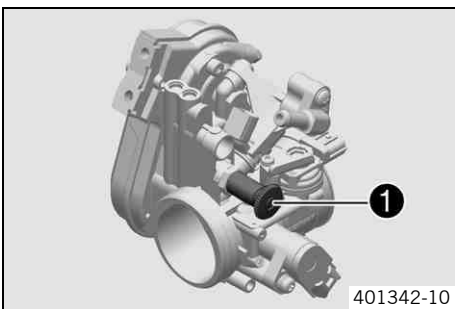

401342-10

- Run the engine warm and push the idle speed adjusting screw ❶ all the way in.
- Set the desired idle speed by turning the idle speed adjusting screw.

**Guideline**

Idle speed	2,050... 2,150 rpm
------------	--------------------

**i Info**

Turn counterclockwise to increase the idle speed.  
Turn clockwise to decrease the idle speed.

## Checking the basic position of the shift lever

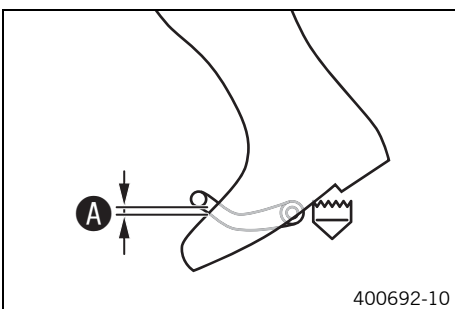

400692-10

- Sit on the vehicle in the riding position and determine the distance A between the upper edge of your boot and the shift lever.

Gap between the shift lever and the top of the boot	10... 20 mm (0.39... 0.79 in)
---	-------------------------------

- » If the distance does not meet the specifications:
  - Adjust the basic position of the shift lever. 🛠️ (☛ p. 91)

## Adjusting the basic position of the shift lever

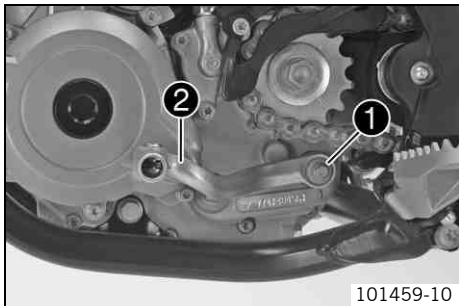

101459-10

- Remove screw ❶ and take off shift lever ❷.

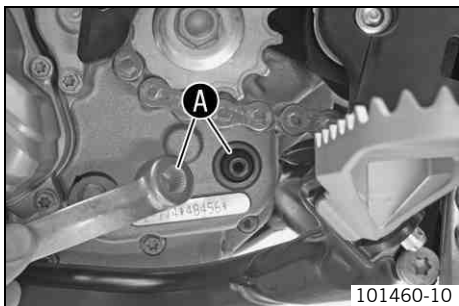

101460-10

- Clean gear teeth ❸ of the shift lever and shift shaft.
- Mount the shift lever on the shift shaft in the required position and engage the gearing.

**i** **Info**

The range of adjustment is limited.  
The shift lever must not come into contact with any other vehicle components during the shift procedure.

- Mount and tighten the screw.

Guideline

Screw, shift lever	M6	14 Nm (10.3 lbf ft)	Loctite® 243™
--------------------	----	------------------------	---------------

## Checking the engine oil level



### Info

The engine oil level can be checked when the engine is cold or warm.

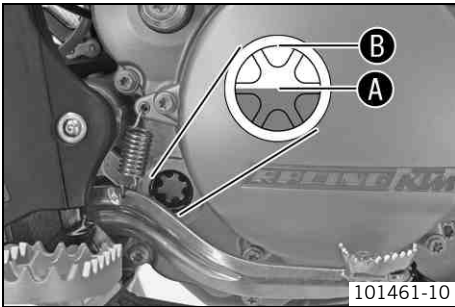

- Stand the motorcycle upright on a horizontal surface.

### Condition

The engine is cold.

- Check the engine oil level.

The engine oil level is up to the middle **A** of the level viewer.

- » If the engine oil is not up to the middle of the level viewer:
  - Add engine oil. (☛ p. 94)

### Condition

The engine is at operating temperature.

- Check the engine oil level.



### Info

After switching off the engine, wait one minute before checking the level.

The engine oil is at a level between the middle **A** and upper edge **B** of the level viewer.

- » If the engine oil is not up to the middle **A** of the level viewer:
  - Add engine oil. (☛ p. 94)

## Changing the engine oil and oil filter, cleaning the oil screens



### Warning

**Danger of scalding** Engine oil and gear oil get very hot when the motorcycle is ridden.

- Wear appropriate protective clothing and safety gloves. In case of burns, rinse immediately with lukewarm water.



### Warning

**Environmental hazard** Hazardous substances cause environmental damage.

- Oil, grease, filters, fuel, cleaners, brake fluid, etc., should be disposed of as stipulated in applicable regulations.



### Info

Drain the engine oil only when the engine is warm.

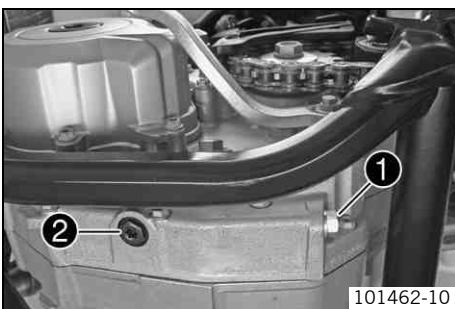

### (EXC-F AUS, EXC-F SIX DAYS)

- Remove the engine guard. (☛ p. 64)
- Park the motorcycle on a level surface.
- Place a suitable container under the engine.
- Remove oil drain plug **1** with the magnet and seal ring.
- Remove screw plug **2** with the short oil screen.

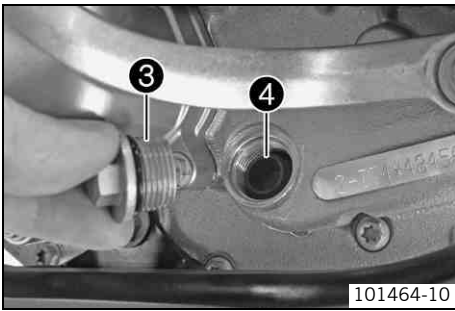

- Remove screw plug ③ with the long oil screen ④.

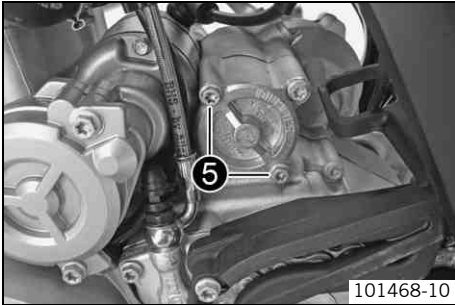

- Remove screws ⑤. Remove the oil filter cover with the O-ring.

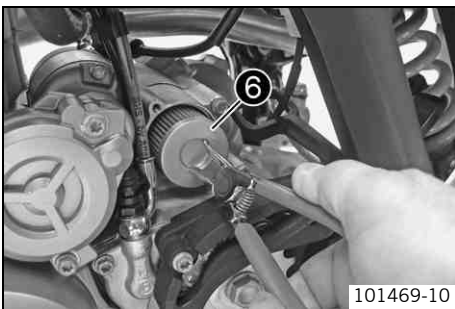

- Pull oil filter ⑥ out of the oil filter housing.

Circlip pliers reverse (51012011000)

- Completely drain the engine oil.
- Thoroughly clean the parts and sealing surfaces.

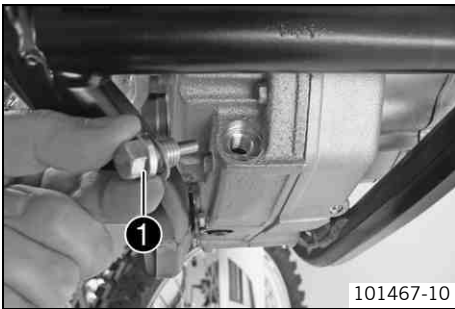

- Mount and tighten the oil drain plug ① with the magnet and a new seal ring.

Guideline

Oil drain plug with magnet	M12x1.5	20 Nm (14.8 lbf ft)
----------------------------	---------	------------------------

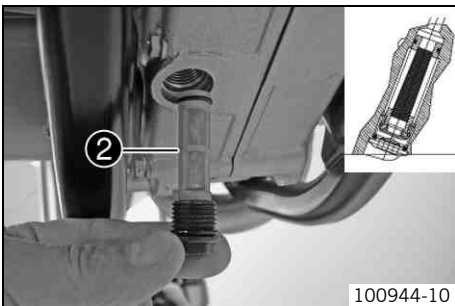

- Insert the short oil screen ② into the screw plug, mount it with the O-ring and tighten.

Guideline

Plug for oil screen, short	M16x1.5	10 Nm (7.4 lbf ft)	Lubricated with engine oil
----------------------------	---------	-----------------------	----------------------------

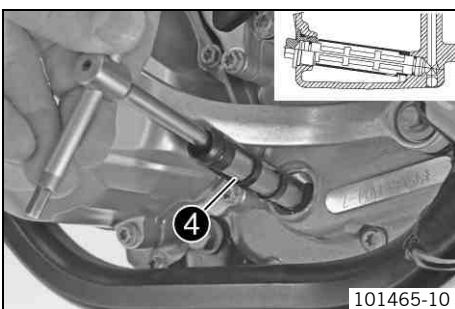

- Place the long oil screen ④ with the O-rings onto a pin wrench.

**i Info**

The larger inside diameter of the oil screen must face the engine case.

- Push the pin wrench through the opening into the drill hole of the opposite engine case wall and push the oil screen as far as possible into the engine case.
- Mount and tighten the screw plug with the O-ring.

Guideline

Plug for oil screen, long	M20x1.5	15 Nm (11.1 lbf ft)
---------------------------	---------	------------------------

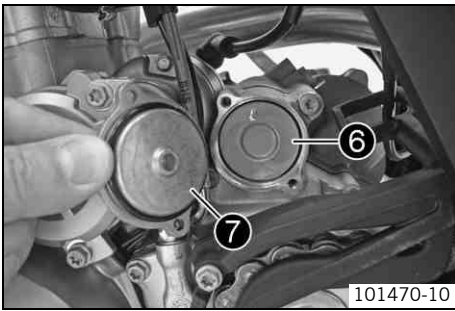

- Lay the motorcycle on its side and fill the oil filter housing to about 1/3 full with engine oil.
- Fill oil filter 6 with engine oil and place it in the oil filter housing.
- Oil the O-ring of the oil filter cover and mount it with the oil filter cover 7.
- Mount and tighten the screws.

**Guideline**

Screw, oil filter cover	M5	6 Nm (4.4 lbf ft)
-------------------------	----	-------------------

- Stand the motorcycle upright.

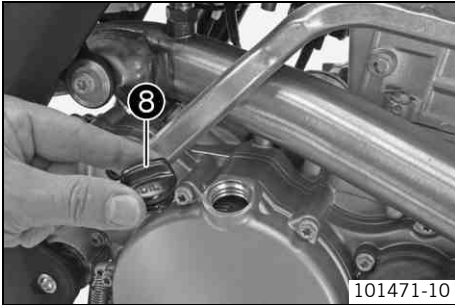

- Remove filler plug 8 with the O-ring on the clutch cover and add engine oil until it reaches the upper edge of the level viewer.

Engine oil	1.20 l (1.27 qt.)	Engine oil (SAE 10W/50) (☛ p. 110)	
		Alternative engine oil for harsh operating conditions and increased performance	Engine oil (SAE 10W/60) (00062010035) (☛ p. 110)

**i Info**

Too little engine oil or poor-quality engine oil results in premature wear to the engine.

- Install and tighten the oil filler plug with the O-ring.

**! Danger**

**Danger of poisoning** Exhaust gases are poisonous and inhaling them may result in unconsciousness and/or death.

- When running the engine, always make sure there is sufficient ventilation, and do not start or run the engine in an enclosed space without an effective exhaust extraction system.

- Start the engine and check that it is oil-tight.

**(EXC-F AUS, EXC-F SIX DAYS)**

- Install the engine guard. (☛ p. 64)
- Check the engine oil level. (☛ p. 92)

## Adding engine oil

**i Info**

Too little engine oil or poor-quality engine oil results in premature wear to the engine.

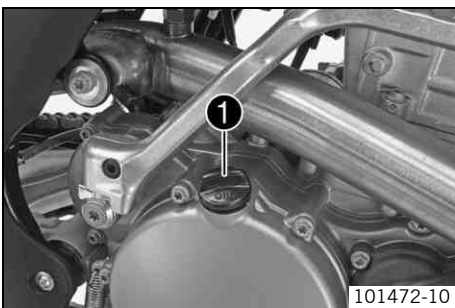

- Remove screw cap 1 from the clutch cover and fill up with engine oil.

Engine oil (SAE 10W/50) (☛ p. 110)
------------------------------------

- Mount and tighten screw cap 1.

**! Danger**

**Danger of poisoning** Exhaust gases are poisonous and inhaling them may result in unconsciousness and/or death.

- When running the engine, always make sure there is sufficient ventilation, and do not start or run the engine in an enclosed space without an effective exhaust extraction system.

- Start the engine and check that it is oil-tight.
- Check the engine oil level. (☛ p. 92)



## Cleaning the motorcycle

### Note

**Material damage** Damage and destruction of components by high-pressure cleaning equipment.

- Never clean the vehicle with high-pressure cleaning equipment or a strong water-jet. The excessive pressure can penetrate electrical components, socket connects, throttle cables, and bearings, etc., and can damage or destroy these parts.

### Warning



**Environmental hazard** Hazardous substances cause environmental damage.

- Oil, grease, filters, fuel, cleaners, brake fluid, etc., should be disposed of as stipulated in applicable regulations.

### Info

If you clean the motorcycle regularly, its value and appearance will be maintained over a long period.  
Avoid direct sunshine on the motorcycle during cleaning.

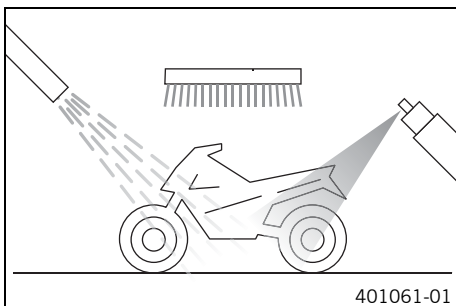

- Close off the exhaust system to prevent water from entering.
- First remove coarse dirt particles with a gentle spray of water.
- Spray very dirty areas with a normal motorcycle cleaner and then clean with a paintbrush.

Motorcycle cleaner (☛ p. 112)

### Info

Use warm water containing normal motorcycle cleaner and a soft sponge.

- After rinsing the motorcycle with a gentle spray of water, allow it to dry thoroughly.



### Warning

**Danger of accidents** Reduced braking efficiency due to wet or dirty brakes.

- Clean or dry dirty or wet brakes by riding and braking gently.

- After cleaning, ride a short distance until the engine reaches operating temperature.

### Info

The heat produced causes water at inaccessible locations in the engine and the brakes to evaporate.

- After the motorcycle has cooled off, lubricate all moving parts and bearings.
- Clean the chain. (☛ p. 57)
- Treat bare metal parts (except for brake discs and exhaust system) with anti-corrosion materials.

Cleaning and preserving materials for metal, rubber and plastic (☛ p. 112)

- Treat all plastic parts and powder-coated parts with a mild cleaning and care product.

Paint cleaner and polish for high-gloss and matte finishes, bare metal and plastic surfaces (☛ p. 113)

### (All EXC-F models)

- Oil the steering lock.

Universal oil spray (☛ p. 113)

## Checks and maintenance steps for winter operation

- i Info**  
 If the motorcycle is used in the winter, salt can be expected on the roads. Precautions need to be taken against road salt corrosion.  
 If the vehicle was operated in road salt, clean it with cold water after riding. Warm water would enhance the corrosive effects of salt.

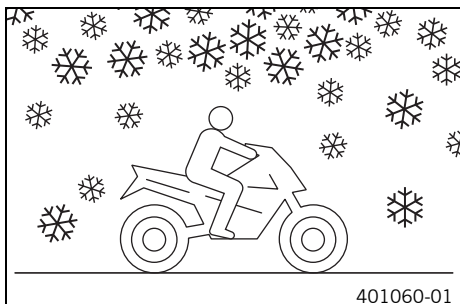

- Clean the motorcycle. (☛ p. 95)
- Clean the brakes.

**i Info**  
 After **EVERY** trip on salted roads, thoroughly wash the brake calipers and brake linings with cold water and dry carefully. This should be done after the parts are cooled down and while they are installed.  
 After riding on salted roads, thoroughly wash the motorcycle with cold water and dry it well.

- Treat the engine, swingarm, and all other bright and zinc-plated parts (except for the brake discs) with a wax-based corrosion inhibitor.

**i Info**  
 Corrosion inhibitor is not permitted to come in contact with the brake discs as this would greatly reduce the braking force.

- Clean the chain. (☛ p. 57)

## Storage

**Warning**

**Danger of poisoning** Fuel is poisonous and a health hazard.

- Avoid contact between fuel and skin, eyes and clothing. Do not inhale fuel vapors. If fuel gets into your eyes, rinse immediately with water and contact a doctor. Wash affected skin areas immediately with soap and water. If fuel is swallowed, contact a doctor immediately. Change clothing that has come into contact with fuel. Store fuel in a suitable canister according to regulations and keep it out of the reach of children.

**Info**

If you want to garage the motorcycle for a longer period, take the following steps.

Before storing the motorcycle, check all parts for function and wear. If service, repairs or replacements are necessary, you should do this during the storage period (less workshop overload). In this way, you can avoid long workshop waiting times at the start of the new season.

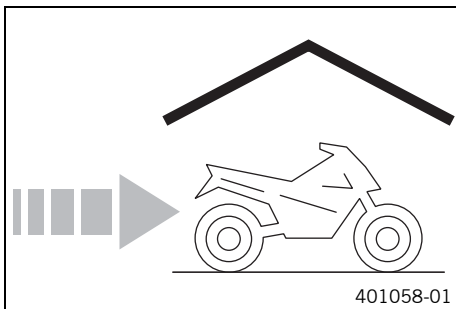

- Clean the motorcycle. (☞ p. 95)
- Change the engine oil and oil filter and clean the oil screens. 🛠️ (☞ p. 92)
- Check the antifreeze and coolant level. (☞ p. 86)
- Drain the fuel from the tank into a suitable container.
- Check the tire air pressure. (☞ p. 77)
- Remove the battery. 🛠️ (☞ p. 79)
- Charge the battery. 🛠️ (☞ p. 79)

**Guideline**

Storage temperature of battery without direct sunlight	0... 35 °C (32... 95 °F)
--	--------------------------

- Store the vehicle in a dry location that is not subject to large fluctuations in temperature.

**Info**

KTM recommends raising the motorcycle.

- Raise the motorcycle with the lift stand. (☞ p. 42)
- Cover the motorcycle with a porous sheet or blanket. Do not use non-porous materials since they prevent humidity from escaping, thus causing corrosion.

**Info**





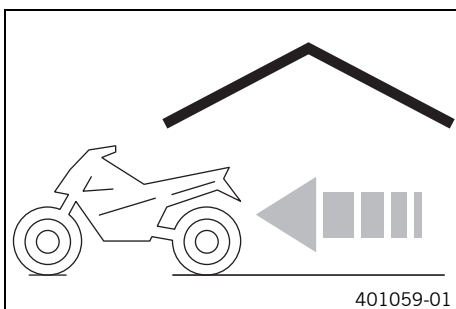







Avoid running the engine for a short time only. Since the engine cannot warm up properly, the water vapor produced during combustion condenses and causes valves and exhaust system to rust.







## Preparing for use after storage



- Remove the motorcycle from the lift stand. (☞ p. 42)
- Install the battery. 🛠️ (☞ p. 79)
- Refuel. (☞ p. 31)
- Perform checks and maintenance work when preparing the vehicle for use. (☞ p. 29)
- Take a test ride.

Faults	Possible cause	Action
The engine cannot be cranked (electric starter)	Operating error	– Carry out the start procedure. (☛ p. 29)
	Battery is discharged	– Charge the battery. ☛ (☛ p. 79) – Check the charging voltage. ☛ – Check the closed current. ☛ – Check the stator winding of the alternator. ☛
	Main fuse blown	– Change the main fuse. (☛ p. 80)
	Starter relay defective	– Check the starter relay. ☛
	Starter motor defective	– Check the starter motor. ☛
Engine turns but does not start	Operating error	– Carry out the start procedure. (☛ p. 29)
	Coupling of fuel hose connection not joined together	– Join the fuel hose connection.
	Fuse 1 blown	– Change the fuses of individual power consumers. (☛ p. 81)
	Fuse 2 blown	– Change the fuses of individual power consumers. (☛ p. 81)
	Idle speed is not set correctly	– Adjust the idle speed. ☛ (☛ p. 90)
	Spark plug oily or wet	– Clean and dry the spark plug or replace if necessary.
	Electrode distance (plug gap) of spark plug too wide	– Adjust the plug gap. Guideline Spark plug electrode gap 0.7 mm (0.028 in)
	Ignition system defective	– Check the ignition system. ☛
	Short-circuit cable in wiring harness frayed, kill switch or emergency OFF switch defective	– Check the wiring harness. (visual check) – Check the electrical system.
	Plug-in connector of the EFI control device, ignition pulse generator, or ignition coil is oxidized	– Clean the plug connection and treat it with contact spray.
Engine does not speed up	Defect in fuel injection system	– Read out the fault memory using the KTM diagnostics tool. ☛
	Ignition system defective	– Ignition coil - check the secondary winding. ☛ – Check the spark plug connector. ☛ – Check the stator winding of the alternator. ☛
Engine has too little power	Air filter heavily contaminated	– Clean the air filter and air filter box. ☛ (☛ p. 53)
	Fuel filter is very dirty	– Change the fuel filter. ☛
	Defect in fuel injection system	– Read out the fault memory using the KTM diagnostics tool. ☛
	Exhaust system leaky, deformed or too little glass fiber yarn filling in main silencer	– Check exhaust system for damage. – Change the glass fiber yarn filling of the main silencer. ☛ (☛ p. 54)
	Valve clearance too little	– Adjust the valve clearance. ☛
	Ignition system defective	– Ignition coil - check the secondary winding. ☛ – Check the spark plug connector. ☛ – Check the stator winding of the alternator. ☛
Engine dies during the trip	Lack of fuel	– Refuel. (☛ p. 31)
	Fuse 1 blown	– Change the fuses of individual power consumers. (☛ p. 81)
	Fuse 2 blown	– Change the fuses of individual power consumers. (☛ p. 81)
Engine overheats	Coolant level low in cooling system	– Check the cooling system for leaks. – Check the coolant level. (☛ p. 87)

Faults	Possible cause	Action
Engine overheats	Insufficient airflow	– Switch off engine when stationary.
	Radiator fins very dirty	– Clean radiator fins.
	Foam formation in cooling system	– Drain the coolant.  (☞ p. 87) – Refill the coolant.  (☞ p. 88)
	Bent radiator hose	– Change the radiator hose. 
	Thermostat defective	– Check the thermostat.  Guideline Opening temperature: 70 °C (158 °F)
	Defect in radiator fan system (EXC-F SIX DAYS)	– Check the radiator fan fuse. – Check fuse <b>4</b> . – Check the radiator fan. 
<b>FI</b> warning lamp ( <b>MIL</b> ) lights up/flashes	Defect in fuel injection system	– Stop the motorcycle and identify the faulty part using the blink code. <hr/>  <b>Info</b> See blink code <hr/> – Check the cabling for damage and the electrical plug-in connections for corrosion and damage. – Read out the fault memory using the KTM diagnostics tool. 
High oil consumption	Engine vent hose bent	– Route the vent hose without bends or replace it if necessary.
	Engine oil level too high	– Check the engine oil level. (☞ p. 92)
	Engine oil too thin (low viscosity)	– Change the engine oil and oil filter and clean the oil screens.  (☞ p. 92)
	Piston and cylinder worn	– Piston/cylinder - determine the mounting clearance 
Battery discharged	Battery is not being charged by alternator	– Check the charging voltage.  – Check the stator winding of the alternator. 
	Undesired power consumer	– Check the closed current. 
Speedometer values deleted (time, stop watch, lap times)	The battery in the speedometer is discharged	– Change the speedometer battery. (☞ p. 84)
The high beam, low beam, parking light, tail light, and license plate lamp are not working	Fuse <b>3</b> blown	– Change the fuses of individual power consumers. (☞ p. 81)
The speedometer, horn, brake light, turn signal, and radiator fan (optional) are not working	Fuse <b>4</b> blown	– Change the fuses of individual power consumers. (☞ p. 81)

<b>Blink code FI warning lamp (MIL)</b>	 02 FI warning lamp (MIL) flashes 2x short
<b>Error level condition</b>	Crankshaft position sensor - circuit fault
<b>Blink code FI warning lamp (MIL)</b>	 06 FI warning lamp (MIL) flashes 6x short
<b>Error level condition</b>	Throttle position sensor circuit A - input signal too low
	Throttle position sensor circuit A - input signal too high
<b>Blink code FI warning lamp (MIL)</b>	 09 FI warning lamp (MIL) flashes 9x short
<b>Error level condition</b>	Manifold absolute pressure sensor cylinder 1 - input signal too low
	Manifold absolute pressure sensor cylinder 1 - input signal too high
<b>Blink code FI warning lamp (MIL)</b>	 12 FI warning lamp (MIL) flashes 1x long, 2x short
<b>Error level condition</b>	Engine coolant temperature sensor - input signal too low
	Engine coolant temperature sensor - input signal too high
<b>Blink code FI warning lamp (MIL)</b>	 13 FI warning lamp (MIL) flashes 1x long, 3x short
<b>Error level condition</b>	Intake air temperature sensor - input signal too low
	Intake air temperature sensor - input signal too high
<b>Blink code FI warning lamp (MIL)</b>	 15 FI warning lamp (MIL) flashes 1x long, 5x short
<b>Error level condition</b>	Rollover sensor (A/D type) - input signal too low
	Rollover sensor (A/D type) - input signal too high
<b>Blink code FI warning lamp (MIL)</b>	 17 FI warning lamp (MIL) flashes 1x long, 7x short
<b>Error level condition</b>	<b>EXC-F EU, EXC-F SIX DAYS</b> Lambda sensor cylinder 1, sensor 1 - circuit fault
<b>Blink code FI warning lamp (MIL)</b>	 33 FI warning lamp (MIL) flashes 3x long, 3x short
<b>Error level condition</b>	Injector cylinder 1 - circuit fault
<b>Blink code FI warning lamp (MIL)</b>	 37 FI warning lamp (MIL) flashes 3x long, 7x short
<b>Error level condition</b>	Ignition coil 1, cylinder 1 - circuit fault
<b>Blink code FI warning lamp (MIL)</b>	 41 FI warning lamp (MIL) flashes 4x long, 1x short
<b>Error level condition</b>	Fuel pump control - open/short circuit to ground
	Fuel pump control - input signal too low

Blink code FI warning lamp (MIL)	 45 FI warning lamp (MIL) flashes 4x long, 5x short
Error level condition	<b>EXC-F EU, EXC-F SIX DAYS</b> Lambda sensor heater cylinder 1, sensor 1 - short circuit to ground or open circuit
	<b>EXC-F EU, EXC-F SIX DAYS</b> Lambda sensor heater cylinder 1, sensor 1 - input signal too high

Design	1-cylinder 4-stroke engine, water-cooled	
Displacement	248.60 cm <sup>3</sup> (15.1706 cu in)	
Stroke	54.80 mm (2.1575 in)	
Bore	76 mm (2.99 in)	
Compression ratio	13.2:1	
Idle speed	2,050... 2,150 rpm	
Control	DOHC, four valves controlled via cam lever, drive via tooth-wheel chain	
Valve diameter, intake	30.0 mm (1.181 in)	
Valve diameter, exhaust	26.0 mm (1.024 in)	
Valve clearance		
Exhaust at: 20 °C (68 °F)	0.12... 0.17 mm (0.0047... 0.0067 in)	
Intake at: 20 °C (68 °F)	0.10... 0.15 mm (0.0039... 0.0059 in)	
Crankshaft bearing	2 cylinder bearings	
Conrod bearing	Needle bearing	
Piston pin bearing	Bronze bush	
Pistons	Forged light alloy	
Piston rings	1 compression ring, 1 oil scraper ring	
Engine lubrication	Pressure circulation lubrication with two rotary pumps	
Primary transmission	22:68	
Clutch	Multidisc clutch in oil bath/hydraulically activated	
Transmission ratio		
1st gear	13:33	
2nd gear	17:33	
3rd gear	19:29	
4th gear	23:28	
5th gear	23:23	
6th gear	26:22	
Alternator		
Light coil and charging coil	12 V, 168 W	
Ignition	Contactless controlled fully electronic ignition with digital ignition adjustment, type Kokusan	
Spark plug	NGK CR 9 EKB	
Spark plug electrode gap	0.7 mm (0.028 in)	
Cooling	Water cooling, permanent circulation of coolant by water pump	
Starting aid	Electric starter/kickstarter	

## Capacity - engine oil

Engine oil	1.20 l (1.27 qt.)	Engine oil (SAE 10W/50) (☛ p. 110)	
		Alternative engine oil for harsh operating conditions and increased performance	Engine oil (SAE 10W/60) (00062010035) (☛ p. 110)

## Capacity - coolant

Coolant	1.2 l (1.3 qt.)	Coolant (☛ p. 110)	
		Coolant (mixed ready to use) (☛ p. 110)	



Jet, crank chamber ventilation	M4	2 Nm (1.5 lbf ft)	Loctite® 243™
Oil jet for alternator cooling	M4	2 Nm (1.5 lbf ft)	Loctite® 243™
Oil jet, conrod lubrication	M4	2 Nm (1.5 lbf ft)	Loctite® 243™
Oil jet for cam lever lubrication	M5	4 Nm (3 lbf ft)	Loctite® 243™
Screw, ignition pulse generator	M5	6 Nm (4.4 lbf ft)	Loctite® 243™
Screw, locking lever	M5	6 Nm (4.4 lbf ft)	Loctite® 243™
Screw, oil filter cover	M5	6 Nm (4.4 lbf ft)	–
Screw, oil pump cover	M5	6 Nm (4.4 lbf ft)	Loctite® 243™
Screw, stator bracket	M5	6 Nm (4.4 lbf ft)	Loctite® 243™
Locking screw for bearing	M6	6 Nm (4.4 lbf ft)	Loctite® 243™
Screw, alternator cover	M6	10 Nm (7.4 lbf ft)	–
Screw, clutch cover	M6	10 Nm (7.4 lbf ft)	–
Screw, clutch slave cylinder	M6	10 Nm (7.4 lbf ft)	–
Screw, clutch spring	M6	10 Nm (7.4 lbf ft)	–
Screw, cover of torque limiter	M6	10 Nm (7.4 lbf ft)	–
Screw, cover plate of valve cover	M6	3 Nm (2.2 lbf ft)	Loctite® 243™
Screw, cylinder head	M6	10 Nm (7.4 lbf ft)	–
Screw, engine case	M6	10 Nm (7.4 lbf ft)	–
Screw, exhaust flange	M6	10 Nm (7.4 lbf ft)	Loctite® 243™
Screw, kickstarter stop	M6	10 Nm (7.4 lbf ft)	Loctite® 243™
Screw, shift drum locating	M6	10 Nm (7.4 lbf ft)	Loctite® 243™
Screw, shift lever	M6	14 Nm (10.3 lbf ft)	Loctite® 243™
Screw, starter motor	M6	10 Nm (7.4 lbf ft)	–
Screw, timing chain securing guide	M6	8 Nm (5.9 lbf ft)	Loctite® 243™
Screw, timing chain tensioning rail	M6	8 Nm (5.9 lbf ft)	Loctite® 243™
Screw, valve cover	M6	10 Nm (7.4 lbf ft)	–
Screw, water pump cover	M6	10 Nm (7.4 lbf ft)	–
Oil jet, piston cooling	M6x0.75	4 Nm (3 lbf ft)	Loctite® 243™
Nut, camshaft bearing bridge	M7	15 Nm (11.1 lbf ft)	Lubricated with engine oil
Screw, camshaft bearing bridge	M7	15 Nm (11.1 lbf ft)	Lubricated with engine oil
Stud, camshaft bearing bridge	M7	2 Nm (1.5 lbf ft)	Loctite® 243™
Plug, crankshaft location	M8	20 Nm (14.8 lbf ft)	–
Screw, kickstarter	M8	25 Nm (18.4 lbf ft)	Loctite® 243™
Screw, timing chain guide rail	M8	10 Nm (7.4 lbf ft)	Loctite® 243™
Screw, cylinder head	M10	Tightening sequence: Tighten diagonally, beginning with the rear screw on the chain shaft. Step 1 40 Nm (29.5 lbf ft) Step 2 50 Nm (36.9 lbf ft)	Lubricated with engine oil
Screw, engine sprocket	M10	60 Nm (44.3 lbf ft)	Loctite® 243™
Spark plug	M10	10... 12 Nm (7.4... 8.9 lbf ft)	–
Rotor screw	M10x1	70 Nm (51.6 lbf ft)	Thread, oiled with engine oil/cone degreased
Screw, unlocking of timing chain tensioner	M10x1	10 Nm (7.4 lbf ft)	–
Screw, camshaft gear	M12x1	80 Nm (59 lbf ft)	Loctite® 243™
Engine coolant temperature sensor	M12x1.5	12 Nm (8.9 lbf ft)	–
Oil drain plug with magnet	M12x1.5	20 Nm (14.8 lbf ft)	–
Plug, oil pressure regulator valve	M12x1.5	20 Nm (14.8 lbf ft)	–
Plug for oil screen, short	M16x1.5	10 Nm (7.4 lbf ft)	Lubricated with engine oil

Nut, inner clutch hub	M18x1.5	100 Nm (73.8 lbf ft)	<b>Loctite® 243™</b>
Nut, primary gear	M18LHx1.5	130 Nm (95.9 lbf ft)	<b>Loctite® 243™</b>
Plug for oil screen, long	M20x1.5	15 Nm (11.1 lbf ft)	–
Plug, timing chain tensioner	M24x1.5	25 Nm (18.4 lbf ft)	–

Frame	Central tube frame made of chrome molybdenum steel tubing	
Fork	<b>WP Suspension</b> Up Side Down 4860 MXMA PA	
Suspension travel		
Front	300 mm (11.81 in)	
Rear	335 mm (13.19 in)	
Fork offset	20 mm (0.79 in)	
Shock absorber	<b>WP Suspension</b> PDS 5018 DCC	
Brake system	Disc brakes, brake calipers on floating bearings	
Brake discs - diameter		
Front	260 mm (10.24 in)	
Rear	220 mm (8.66 in)	
Brake discs - wear limit		
Front	2.5 mm (0.098 in)	
Rear	3.5 mm (0.138 in)	
Tire air pressure off road		
Front	1.0 bar (15 psi)	
Rear	1.0 bar (15 psi)	
Road tire pressure (All EXC-F models)		
Front	1.5 bar (22 psi)	
Rear	2.0 bar (29 psi)	
Final drive (All EXC-F models)	14:50 (13:50)	
Final drive (XCF-W)	13:50	
Chain	5/8 x 1/4"	
Rear sprockets available	38, 40, 42, 45, 48, 49, 50, 51, 52	
Steering head angle	63.5°	
Wheelbase	1,482±10 mm (58.35±0.39 in)	
Seat height unloaded	970 mm (38.19 in)	
Ground clearance unloaded	345 mm (13.58 in)	
Weight without fuel, approx. (All EXC-F models)	107.5 kg (237 lb.)	
Weight without fuel, approx. (XCF-W)	106 kg (234 lb.)	
Maximum permissible front axle load	145 kg (320 lb.)	
Maximum permissible rear axle load	190 kg (419 lb.)	
Maximum permissible overall weight	335 kg (739 lb.)	

Battery	YTX4L-BS	Battery voltage: 12 V Nominal capacity: 3 Ah Maintenance-free
Speedometer battery	CR 2430	Battery voltage: 3 V
Fuse	58011109105	5 A
Fuse	58011109110	10 A
Fuse	58011109120	20 A

## Lighting equipment

Headlight	S2 / socket BA20d	12 V 35/35 W
Parking light	W5W / socket W2.1x9.5d	12 V 5 W
Indicator lamps (All EXC-F models)	W2.3W / socket W2x4.6d	12 V 2.3 W
Turn signal (All EXC-F models)	R10W / socket BA15s	12 V 10 W
Brake/tail light	LED	
License plate lamp (All EXC-F models)	W5W / socket W2.1x9.5d	12 V 5 W

## Tires

Validity	Front tire	Rear tire
(All EXC-F models)	<b>90/90 - 21 M/C 54M M+S TT</b> Metzeler MEC 6 DAYS EXTREME	<b>120/90 - 18 M/C 65M M+S TT</b> Metzeler MEC 6 DAYS EXTREME
(XCF-W)	<b>80/100 - 21 51M TT</b> Dunlop GEOMAX MX51	<b>100/100 - 18 59M TT</b> Dunlop GEOMAX MX51
Additional information is available in the Service section under: <a href="http://www.ktm.com">http://www.ktm.com</a>		

## Capacity - fuel

Total fuel tank capacity, approx.	9.5 l (2.51 US gal)	Super unleaded (ROZ 95/RON 95/PON 91) (☛ p. 111)
Fuel reserve, approx.	1.5 l (1.6 qt.)	

Fork part number	14.18.7L.63	
Fork	<b>WP Suspension</b> Up Side Down 4860 MXMA PA	
Compression damping		
Comfort	24 clicks	
Standard	22 clicks	
Sport	20 clicks	
Full payload	20 clicks	
Rebound damping		
Comfort	22 clicks	
Standard	20 clicks	
Sport	18 clicks	
Full payload	18 clicks	
Spring preload - <b>Preload Adjuster</b>		
Comfort	1 turn	
Standard	2 turns	
Sport	2 turns	
Full payload	4 turns	
Spring length with preload spacer(s)		
Weight of rider: 65... 75 kg (143... 165 lb.)	513 mm (20.2 in)	
Weight of rider: 75... 85 kg (165... 187 lb.)	513 mm (20.2 in)	
Weight of rider: 85... 95 kg (187... 209 lb.)	513 mm (20.2 in)	
Spring rate		
Weight of rider: 65... 75 kg (143... 165 lb.)	4.0 N/mm (22.8 lb/in)	
Weight of rider: 75... 85 kg (165... 187 lb.)	4.2 N/mm (24 lb/in)	
Weight of rider: 85... 95 kg (187... 209 lb.)	4.4 N/mm (25.1 lb/in)	
Fork length	940 mm (37.01 in)	
Air chamber length	110 <sup>+10</sup> <sub>-20</sub> mm (4.33 <sup>+0.39</sup> <sub>-0.79</sub> in)	
Fork oil per fork leg	625 ml (21.13 fl. oz.)	Fork oil (SAE 5) (☛ p. 111)

Shock absorber part number	12.18.7L.63
Shock absorber	<b>WP Suspension</b> PDS 5018 DCC
Compression damping, low-speed	
Comfort	25 clicks
Standard	20 clicks
Sport	15 clicks
Full payload	15 clicks
Compression damping, high-speed	
Comfort	2 turns
Standard	1.5 turns
Sport	1.25 turns
Full payload	1.25 turns
Rebound damping	
Comfort	28 clicks
Standard	24 clicks
Sport	22 clicks
Full payload	22 clicks
Spring preload	
Comfort	7 mm (0.28 in)
Standard	7 mm (0.28 in)
Sport	7 mm (0.28 in)
Full payload	8 mm (0.31 in)
Spring rate	
Weight of rider: 65... 75 kg (143... 165 lb.)	66 N/mm (377 lb/in)
Weight of rider: 75... 85 kg (165... 187 lb.)	69 N/mm (394 lb/in)
Weight of rider: 85... 95 kg (187... 209 lb.)	72 N/mm (411 lb/in)
Spring length	250 mm (9.84 in)
Gas pressure	10 bar (145 psi)
Static sag	33... 35 mm (1.3... 1.38 in)
Riding sag	105... 115 mm (4.13... 4.53 in)
Fitted length	417 mm (16.42 in)
Damper oil	Shock absorber oil (SAE 2.5) (50180342S1) (☛ p. 111)

Spoke nipple, front wheel	M4.5	5... 6 Nm (3.7... 4.4 lbf ft)	–
Screw, battery terminal	M5	2.5 Nm (1.84 lbf ft)	–
Screw, intake air temperature sensor	M5	2 Nm (1.5 lbf ft)	–
Screw, shock absorber adjusting ring	M5	5 Nm (3.7 lbf ft)	–
Screw, spoiler on fuel tank (XCF-W)	M5x12	1.5 Nm (1.11 lbf ft)	–
Spoke nipple, rear wheel	M5	5... 6 Nm (3.7... 4.4 lbf ft)	–
Remaining nuts, chassis	M6	10 Nm (7.4 lbf ft)	–
Remaining screws, chassis	M6	10 Nm (7.4 lbf ft)	–
Screw, ball joint of push rod on foot brake cylinder	M6	10 Nm (7.4 lbf ft)	<b>Loctite® 243™</b>
Screw, chain sliding guard	M6	6 Nm (4.4 lbf ft)	<b>Loctite® 243™</b>
Screw, front brake disc	M6	14 Nm (10.3 lbf ft)	<b>Loctite® 243™</b>
Screw, rear brake disc	M6	14 Nm (10.3 lbf ft)	<b>Loctite® 243™</b>
Fuel connection on fuel pump	M8	10 Nm (7.4 lbf ft)	–
Nut, foot brake lever stop	M8	30 Nm (22.1 lbf ft)	–
Nut, rear sprocket screw	M8	35 Nm (25.8 lbf ft)	<b>Loctite® 2701</b>
Nut, rim lock	M8	10 Nm (7.4 lbf ft)	–
Remaining nuts, chassis	M8	25 Nm (18.4 lbf ft)	–
Remaining screws, chassis	M8	25 Nm (18.4 lbf ft)	–
Screw, bottom triple clamp (EXC-F SIX DAYS)	M8	12 Nm (8.9 lbf ft)	–
Screw, bottom triple clamp (XCF-W, EXC-F EU, EXC-F AUS)	M8	15 Nm (11.1 lbf ft)	–
Screw, chain sliding piece	M8	15 Nm (11.1 lbf ft)	–
Screw, engine brace	M8	33 Nm (24.3 lbf ft)	–
Screw, fork stub	M8	15 Nm (11.1 lbf ft)	–
Screw, front brake caliper	M8	25 Nm (18.4 lbf ft)	<b>Loctite® 243™</b>
Screw, handlebar clamp	M8	20 Nm (14.8 lbf ft)	–
Screw, side stand attachment	M8	45 Nm (33.2 lbf ft)	<b>Loctite® 2701</b>
Screw, subframe	M8	35 Nm (25.8 lbf ft)	<b>Loctite® 2701</b>
Screw, top steering stem (EXC-F SIX DAYS)	M8	17 Nm (12.5 lbf ft)	<b>Loctite® 243™</b>
Screw, top steering stem (XCF-W, EXC-F EU, EXC-F AUS)	M8	20 Nm (14.8 lbf ft)	–
Screw, top triple clamp (EXC-F SIX DAYS)	M8	17 Nm (12.5 lbf ft)	–
Screw, top triple clamp (XCF-W, EXC-F EU, EXC-F AUS)	M8	20 Nm (14.8 lbf ft)	–
Engine attachment bolt	M10	60 Nm (44.3 lbf ft)	–
Remaining nuts, chassis	M10	45 Nm (33.2 lbf ft)	–
Remaining screws, chassis	M10	45 Nm (33.2 lbf ft)	–
Screw, handlebar support	M10	40 Nm (29.5 lbf ft)	<b>Loctite® 243™</b>
Nut, fuel pump fixation	M12	15 Nm (11.1 lbf ft)	–
Screw, bottom shock absorber	M12	80 Nm (59 lbf ft)	<b>Loctite® 2701</b>
Screw, top shock absorber	M12	80 Nm (59 lbf ft)	<b>Loctite® 2701</b>
Nut, seat fixing	M12x1	20 Nm (14.8 lbf ft)	–
Nut, swingarm pivot	M16x1.5	100 Nm (73.8 lbf ft)	–
Nut, rear wheel spindle	M20x1.5	80 Nm (59 lbf ft)	–
Screw, top steering head	M20x1.5	12 Nm (8.9 lbf ft)	–
Screw-in nozzles, cooling system	M20x1.5	12 Nm (8.9 lbf ft)	<b>Loctite® 243™</b>
Screw, front wheel spindle	M24x1.5	45 Nm (33.2 lbf ft)	–

## Brake fluid DOT 4 / DOT 5.1

### According to

- DOT

### Guideline

- Use only brake fluid that complies with the specified standard (see specifications on the container) and that possesses the corresponding properties. KTM recommends **Castrol** and **Motorex®** products.

### Supplier

#### Castrol

- **RESPONSE BRAKE FLUID SUPER DOT 4**

#### Motorex®

- **Brake Fluid DOT 5.1**

## Coolant

### Guideline

- Use only suitable coolant (also in countries with high temperatures). Use of low-quality antifreeze can lead to corrosion and foaming. KTM recommends **Motorex®** products.

### Mixture ratio

Antifreeze protection: -25... -45 °C (-13... -49 °F)	50 % corrosion inhibitor/antifreeze 50 % distilled water
--	---

## Coolant (mixed ready to use)

Antifreeze	-40 °C (-40 °F)
------------	-----------------

### Supplier

#### Motorex®

- **Anti Freeze**

## Engine oil (SAE 10W/60) (00062010035)

### According to

- JASO T903 MA (☛ p. 114)
- SAE (☛ p. 114) (SAE 10W/60)
- KTM LC4 2007+

### Guideline

- Use only engine oils that comply with the specified standards (see specifications on the container) and that possess the corresponding properties. KTM recommends **Motorex®** products.

Synthetic engine oil
----------------------

### Supplier

#### Motorex®

- **Motorex® KTM Cross Power 4T**

## Engine oil (SAE 10W/50)

### According to

- JASO T903 MA (☛ p. 114)
- SAE (☛ p. 114) (SAE 10W/50)

### Guideline

- Use only engine oils that comply with the specified standards (see specifications on the container) and that possess the corresponding properties. KTM recommends **Motorex®** products.

Synthetic engine oil
----------------------

### Supplier

#### Motorex®

- **Cross Power 4T**



**Fork oil (SAE 5)****According to**

- SAE (☛ p. 114) (SAE 5)

**Guideline**

- Use only oils that comply with the specified standards (see specifications on the container) and that possess the corresponding properties. KTM recommends **Motorex®** products.

**Supplier****Motorex®**

- **Racing Fork Oil**

**Shock absorber oil (SAE 2.5) (50180342S1)****According to**

- SAE (☛ p. 114) (SAE 2.5)

**Guideline**

- Use only oils that comply with the specified standards (see specifications on the container) and that possess the corresponding properties.

**Super unleaded (ROZ 95/RON 95/PON 91)****According to**

- DIN EN 228 (ROZ 95/RON 95/PON 91)

**Guideline**

- Only use unleaded super fuel that matches or is equivalent to the specified fuel grade.
- Fuel with an ethanol content of up to 10 % (E10 fuel) is safe to use.

**Info**

Do **not** use fuel containing methanol (e. g. M15, M85, M100) or more than 10 % ethanol (e. g. E15, E25, E85, E100).

## Air filter cleaner

### Guideline

- KTM recommends **Motorex®** products.

### Supplier

#### Motorex®

- **Twin Air Dirt Bio Remover**

## Chain cleaner

### Guideline

- KTM recommends **Motorex®** products.

### Supplier

#### Motorex®

- **Chain Clean**

## Cleaning and preserving materials for metal, rubber and plastic

### Guideline

- KTM recommends **Motorex®** products.

### Supplier

#### Motorex®

- **Protect & Shine**

## High viscosity grease

### Guideline

- KTM recommends **SKF®** products.

### Supplier

#### SKF®

- **LGHB 2**

## Long-life grease

### Guideline

- KTM recommends **Motorex®** products.

### Supplier

#### Motorex®

- **Bike Grease 2000**

## Motorcycle cleaner

### Guideline

- KTM recommends **Motorex®** products.

### Supplier

#### Motorex®

- **Moto Clean 900**

## Off-road chain spray

### Guideline

- KTM recommends **Motorex®** products.

### Supplier

#### Motorex®

- **Chainlube Offroad**

## Oil for foam air filter

### Guideline

- KTM recommends **Motorex®** products.

### Supplier

#### Motorex®

- **Twin Air Liquid Bio Power**

## Paint cleaner and polish for high-gloss and matte finishes, bare metal and plastic surfaces

### Guideline

- KTM recommends **Motorex®** products.

### Supplier

**Motorex®**

- **Clean & Polish**

## Rubber grip adhesive (00062030051)

### Supplier

KTM-Sportmotorcycle AG

- **GRIP GLUE**

## Universal oil spray

### Guideline

- KTM recommends **Motorex®** products.

### Supplier

**Motorex®**

- **Joker 440 Synthetic**

## JASO T903 MA

Different technical development directions required a new specification for 4-stroke motorcycles – the JASO T903 MA Standard. Earlier, engine oils from the automobile industry were used for 4-stroke motorcycles because there was no separate motorcycle specification. Whereas long service intervals are demanded for automobile engines, high performance at high engine speeds are in the foreground for motorcycle engines. With most motorcycles, the gearbox and the clutch are lubricated with the same oil as the engine. The JASO MA Standard meets these special requirements.

## SAE

The SAE viscosity classes were defined by the Society of Automotive Engineers and are used for classifying oils according to their viscosity. The viscosity describes only one property of oil and says nothing about quality.

**A**

**Accessories** . . . . . 5

**Air filter**

    cleaning . . . . . 53

    installing . . . . . 53

    removing . . . . . 52

**Air filter box**

    cleaning . . . . . 53

**Air filter box lid**

    installing . . . . . 52

    removing . . . . . 52

**Antifreeze**

    checking . . . . . 86

**B**

**Basic suspension setting**

    checking against the rider's weight . . . . . 35

**Battery**

    charging . . . . . 79

    installing . . . . . 79

    removing . . . . . 79

**Blink code** . . . . . 100-101

**Brake discs**

    checking . . . . . 66

**Brake fluid**

    front brake, adding . . . . . 66

    rear brake, adding . . . . . 70

**Brake fluid level**

    front brake, checking . . . . . 66

    rear brake, checking . . . . . 70

**Brake linings**

    front brake, changing . . . . . 67

    front brake, checking . . . . . 67

    rear brake, changing . . . . . 72

    rear brake, checking . . . . . 71

**Brakes** . . . . . 65-73

**C**

**Chain**

    checking . . . . . 59

    cleaning . . . . . 57

**Chain guide**

    adjusting . . . . . 61

    checking . . . . . 59

**Chain tension**

    adjusting . . . . . 58

    checking . . . . . 58

**Chassis number** . . . . . 9

**Clutch**

    fluid level, checking . . . . . 63

    fluid, changing . . . . . 63

**Clutch lever** . . . . . 11

    basic position, adjusting . . . . . 62

**Compression damping**

    fork, adjusting . . . . . 39

**Compression damping, high-speed**

    shock absorber, adjusting . . . . . 36

**Compression damping, low-speed**

    shock absorber, adjusting . . . . . 35

**Coolant**

    draining . . . . . 87

    refilling . . . . . 88

**Coolant level**

    checking . . . . . 86-87

**Cooling system** . . . . . 86

**D**

**Difficult riding conditions** . . . . . 25

    dry sand . . . . . 26

    high temperature . . . . . 27

    low temperatures . . . . . 28

    muddy surfaces . . . . . 27

    slow speed . . . . . 27

    snow . . . . . 28

    wet sand . . . . . 26

    wet surfaces . . . . . 27

**E**

**Electric starter button** . . . . . 12-13

**Emergency OFF switch** . . . . . 12

**Engine**

    running-in . . . . . 25

**Engine characteristics**

    adjusting . . . . . 89

**Engine guard**

    installing . . . . . 64

    removing . . . . . 64

**Engine number** . . . . . 9

**Engine oil**

    adding . . . . . 94

    changing . . . . . 92

**Engine oil level**

    checking . . . . . 92

**Engine sprocket**

    checking . . . . . 59

**Environment** . . . . . 6

**F**

**Filler cap**

    closing . . . . . 21

    opening . . . . . 20

**Filling up**

    fuel . . . . . 31

**Foot brake lever** . . . . . 22

    basic position, adjusting . . . . . 69

    free travel, checking . . . . . 69

**Fork legs**

    basic setting, checking . . . . . 39

    bleeding . . . . . 42

    dust boots, cleaning . . . . . 42

    installing . . . . . 44

    removing . . . . . 43

    spring preload, adjusting . . . . . 40

**Fork protector**

    installing . . . . . 45

- removing ..... 44
- Frame**
  - checking ..... 61
- Front fender**
  - installing ..... 51
  - removing ..... 51
- Front wheel**
  - installing ..... 74
  - removing ..... 74
- Fuel tank**
  - installing ..... 56
  - removing ..... 55
- Fuel, oils, etc.** ..... 5
- Fuse**
  - individual power consumers, changing ..... 81
  - main fuse, changing ..... 80
  - radiator fan, changing ..... 82
- H**
- Hand brake lever** ..... 11
  - basic position, adjusting ..... 65
  - free travel, adjusting ..... 65
  - free travel, checking ..... 65
- Handlebar position** ..... 40
  - adjusting ..... 40
- Headlight**
  - headlight range, adjusting ..... 84
- Headlight bulb**
  - changing ..... 83
- Headlight mask with headlight**
  - installing ..... 83
  - removing ..... 83
- Headlight setting**
  - checking ..... 84
- Horn button** ..... 12
- I**
- Idle speed**
  - adjusting ..... 90
- Idle speed adjusting screw** ..... 21
- K**
- Key number** ..... 9
- Kick starter** ..... 22
- Kill switch** ..... 11
- L**
- Light switch** ..... 12-13
- Lower triple clamp**
  - installing ..... 46, 48
  - removing ..... 45
- M**
- Main fuse**
  - changing ..... 80
- Main silencer**
  - glass fiber yarn filling, changing ..... 54
  - installing ..... 54
  - removing ..... 54
- Map-Select switch**
  - engine characteristics, setting ..... 89
  - for the basic setting ..... 13
  - for vehicle operation ..... 13
- Motorcycle**
  - cleaning ..... 95
  - raising with lift stand ..... 42
  - removing from lift stand ..... 42
- O**
- Oil filter**
  - changing ..... 92
- Oil screens**
  - cleaning ..... 92
- Overview of indicator lamps** ..... 13-14
- Owner's manual** ..... 6
- P**
- Play in throttle cable**
  - checking ..... 89
- Preparing for use**
  - advice on first use ..... 24
  - after storage ..... 97
  - checks and maintenance work when preparing for use .. 29
- R**
- Rear sprocket**
  - checking ..... 59
- Rear wheel**
  - installing ..... 75
  - removing ..... 75
- Rebound damping**
  - fork, adjusting ..... 39
  - shock absorber, adjusting ..... 36
- Riding sag**
  - adjusting ..... 38
- Rubber grip**
  - checking ..... 62
  - securing ..... 62
- S**
- Seat**
  - mounting ..... 52
  - removing ..... 52
- Service** ..... 5
- Service schedule** ..... 33-34
- Shift lever** ..... 21
  - basic position, adjusting ..... 91
  - basic position, checking ..... 90
- Shock absorber**
  - installing ..... 51
  - removing ..... 51
  - riding sag, checking ..... 37
  - spring preload, adjusting ..... 38
  - static sag, checking ..... 37
- Side stand** ..... 22
- Spare parts** ..... 5
- Speedometer**
  - adjusting ..... 16

battery, changing	84
clock, setting	15
function description	14
kilometers or miles, setting	15
<b>Spoke tension</b>	
checking	77
<b>Starting</b>	29
<b>Steering</b>	
locking	23
unlocking	23
<b>Steering head bearing</b>	
greasing	50
<b>Steering head bearing play</b>	
adjusting	50
checking	49
<b>Storage</b>	97
<b>Swingarm</b>	
checking	61
<b>T</b>	
<b>Technical data</b>	
chassis	105-106
chassis tightening torques	109
engine	102
engine tightening torques	103-104
fork	107
shock absorber	108
<b>Throttle cable play</b>	
adjusting	89
<b>Throttle cable routing</b>	
checking	62
<b>Throttle grip</b>	11
<b>Tire condition</b>	
checking	76
<b>Tire pressure</b>	
checking	77
<b>Transport</b>	6
<b>Troubleshooting</b>	98-99
<b>Turn signal switch</b>	12
<b>Type label</b>	9
<b>U</b>	
<b>Use definition</b>	5
<b>V</b>	
<b>View of vehicle</b>	
front left	7
rear right side	8
<b>W</b>	
<b>Warranty</b>	5
<b>Winter operation</b>	
checks and maintenance steps	96
<b>Work rules</b>	5



3211719en



05/2011 Photo: Mittenbauer



KTM-Sportmotorcycle AG  
5230 Mattighofen/Austria  
<http://www.ktm.com>