

450 EXC EU
450 EXC AUS
450 EXC SIX DAYS EU
450 XC-W USA
500 EXC EU
500 EXC AUS
500 EXC SIX DAYS EU
500 XC-W USA

Art. no. 3213037en



KTM

DEAR KTM CUSTOMER

Congratulations on your decision to purchase a KTM motorcycle. You are now the owner of a state-of-the-art sports motorcycle that will give you enormous pleasure if you service and maintain it accordingly.

We wish you a lot of enjoyment in riding this vehicle.

Please enter the serial number of your vehicle below.

Chassis number (☛ p. 12)	Stamp of dealer
Engine number (☛ p. 12)	
Key number (all EXC models) (☛ p. 12)	

The Owner's Manual contained the latest information for this model series at the time of going to print. Slight deviations resulting from continuing development and design of the motorcycles can, however, not be completely excluded.

All specifications are non-binding. KTM Sportmotorcycle AG specifically reserves the right to modify or delete technical specifications, prices, colors, forms, materials, services, designs, equipment, etc., without prior notice and without specifying reasons, to adapt these to local conditions, as well as to stop production of a particular model without prior notice. KTM accepts no liability for delivery options, deviations from illustrations and descriptions, as well as misprints and other errors. The models portrayed partly contain special equipment that does not belong to the regular scope of supply.

© 2013 KTM-Sportmotorcycle AG, Mattighofen Austria

All rights reserved

Reproduction, even in part, as well as copying of all kinds, is permitted only with the express written permission of the copyright owner.



ISO 9001(12 100 6061)

According to the international quality management standard ISO 9001, KTM uses quality assurance processes that lead to the maximum possible quality of the products.



































Issued by: TÜV Management Service

REG.NO. 12 100 6061

KTM-Sportmotorcycle AG
5230 Mattighofen, Austria

TABLE OF CONTENTS





1	MEANS OF REPRESENTATION	5	7.1.2	Activation and test	21
1.1	Symbols used	5	7.1.3	Setting kilometers or miles	21
1.2	Formats used	5	7.1.4	Adjusting the speedometer functions	22
2	SAFETY ADVICE	6	7.1.5	Setting the clock	22
2.1	Use definition - intended use	6	7.1.6	Querying lap time	22
2.2	Safety advice	6	7.1.7	Display mode SPEED (speed)	23
2.3	Degrees of risk and symbols	6	7.1.8	Display mode SPEED/H (service hours)	23
2.4	Tampering warning	6	7.1.9	Setup menu	23
2.5	Safe operation	7	7.1.10	Unit of measurement menu	24
2.6	Protective clothing	7	7.1.11	Display mode SPEED/CLK (time)	24
2.7	Work rules	7	7.1.12	Setting the clock	24
2.8	Environment	7	7.1.13	Display mode SPEED/LAP (lap time)	25
2.9	Owner's Manual	8	7.1.14	Viewing the lap time	25
3	IMPORTANT NOTES	9	7.1.15	Display mode SPEED/ODO (odometer)	25
3.1	Guarantee, warranty	9	7.1.16	Display mode SPEED/TR1 (trip master 1)	25
3.2	Operating and auxiliary substances	9	7.1.17	Display mode SPEED/TR2 (trip master 2)	26
3.3	Spare parts, accessories	9	7.1.18	Setting TR2 (trip master 2)	26
3.4	Service	9	7.1.19	Display mode SPEED/A1 (average speed 1)	26
3.5	Figures	9	7.1.20	Display mode SPEED/A2 (average speed 2)	27
3.6	Customer service	9	7.1.21	Display mode SPEED/S1 (stop watch 1)	27
4	VIEW OF VEHICLE	10	7.1.22	Display mode SPEED/S2 (stop watch 2)	27
4.1	View of vehicle, front left (example)	10	7.1.23	Table of functions	27
4.2	View of vehicle, rear right (example)	11	7.1.24	Table of conditions and menu activation	28
5	SERIAL NUMBERS	12	7.2	EXC SIX DAYS	28
5.1	Chassis number	12	7.2.1	Speedometer overview	28
5.2	Type label	12	7.2.2	Activation and test	29
5.3	Key number (all EXC models)	12	7.2.3	Setting kilometers or miles	29
5.4	Engine number	12	7.2.4	Setting the speedometer functions	29
5.5	Fork part number	12	7.2.5	Setting the clock	30
5.6	Shock absorber part number	13	7.2.6	Viewing the lap time	30
6	CONTROLS	14	7.2.7	Display mode SPEED (speed)	31
6.1	Clutch lever	14	7.2.8	Display mode SPEED/H (service hours)	31
6.2	Hand brake lever	14	7.2.9	Setup menu	31
6.3	Throttle grip	14	7.2.10	Setting the unit of measurement	32
6.4	Kill switch (all EXC models)	14	7.2.11	Display mode SPEED/CLK (time)	32
6.5	Kill switch (all XC-W models)	14	7.2.12	Setting the clock	32
6.6	Horn button (all EXC models)	15	7.2.13	Display mode SPEED/LAP (lap time)	33
6.7	Light switch (all EXC models)	15	7.2.14	Viewing the lap time	33
6.8	Light switch (all XC-W models)	15	7.2.15	Display mode SPEED/ODO (odometer)	33
6.9	Turn signal switch (all EXC models)	15	7.2.16	Display mode SPEED/TR1 (trip master 1)	33
6.10	Emergency OFF switch (EXC AUS)	15	7.2.17	Display mode SPEED/TR2 (trip master 2)	34
6.11	Electric starter button (EXC AUS)	16	7.2.18	Setting TR2 (trip master 2)	34
6.12	Electric starter button (EXC EU, EXC SIX DAYS, XC-W)	16	7.2.19	Display mode SPEED/A1 (average speed 1)	34
6.13	Overview of indicator lamps (EXC EU, EXC AUS)	16	7.2.20	Display mode SPEED/A2 (average speed 2)	35
6.14	Overview of indicator lamps (EXC SIX DAYS)	16	7.2.21	Display mode SPEED/S1 (stop watch 1)	35
6.15	Overview of indicator lamps (all XC-W models)	16	7.2.22	Display mode SPEED/S2 (stop watch 2)	35
6.16	Opening filler cap	17	7.2.23	Table of functions	36
6.17	Closing filler cap	17	7.2.24	Table of conditions and menu activation	37
6.18	Idle speed adjusting screw	18	8	PREPARING FOR USE	38
6.19	Shift lever	18	8.1	Advice on first use	38
6.20	Kick starter	18	8.2	Running-in the engine	39
6.21	Foot brake lever	19	8.3	Preparing the vehicle for difficult riding conditions	39
6.22	Side stand	19	8.4	Preparing for rides on dry sand	40
6.23	Steering lock (all EXC models)	19	8.5	Preparing for rides on wet sand	40
6.24	Locking the steering (all EXC models)	19	8.6	Preparing for rides on wet and muddy surfaces	41
6.25	Unlocking the steering (all EXC models)	20	8.7	Preparing for rides at high temperature and slow speed	41
7	SPEEDOMETER	21	8.8	Preparing for rides at low temperature or in snow	41
7.1	EXC EU, EXC AUS, all XC-W models	21			
7.1.1	Speedometer overview	21			

9	RIDING INSTRUCTIONS.....	42	12.19	Removing the front fender	66
9.1	Checks and maintenance work when preparing for use.....	42	12.20	Installing the front fender	66
9.2	Starting.....	42	12.21	Removing the shock absorber 	67
9.3	Starting off.....	43	12.22	Installing the shock absorber 	67
9.4	Shifting, riding	43	12.23	Removing the seat	67
9.5	Braking.....	43	12.24	Mounting the seat	68
9.6	Stopping, parking.....	44	12.25	Removing the air filter box lid	68
9.7	Transport	44	12.26	Installing the air filter box lid	68
9.8	Refueling	45	12.27	Removing the air filter 	68
10	SERVICE SCHEDULE	46	12.28	Installing the air filter 	69
10.1	Service schedule.....	46	12.29	Cleaning the air filter and air filter box 	69
10.2	Service work (as additional order)	47	12.30	Sealing the air filter box 	70
11	TUNING THE CHASSIS	48	12.31	Removing main silencer.....	70
11.1	Checking the basic suspension setting against the rider's weight	48	12.32	Installing the main silencer.....	70
11.2	Compression damping of shock absorber	48	12.33	Changing the glass fiber yarn filling of the main silencer 	70
11.3	Adjusting the low-speed compression damping of the shock absorber	48	12.34	Removing the fuel tank 	71
11.4	Adjusting the high-speed compression damping of the shock absorber.....	49	12.35	Installing the fuel tank 	72
11.5	Adjusting the rebound damping of the shock absorber.....	49	12.36	Checking for chain dirt accumulation.....	73
11.6	Measuring rear wheel sag unloaded.....	50	12.37	Cleaning the chain	74
11.7	Checking the static sag of the shock absorber....	50	12.38	Checking the chain tension.....	74
11.8	Checking the riding sag of the shock absorber....	50	12.39	Adjusting the chain tension.....	75
11.9	Adjusting the spring preload of the shock absorber 	51	12.40	Checking the chain, rear sprocket, engine sprocket and chain guide.....	75
11.10	Adjusting the riding sag 	51	12.41	Checking the frame 	77
11.11	Checking basic setting of fork	52	12.42	Checking the swingarm 	77
11.12	Adjusting the compression damping of the fork	52	12.43	Checking the throttle cable routing	77
11.13	Adjusting the rebound damping of the fork	53	12.44	Checking the rubber grip	78
11.14	Adjusting the spring preload of the fork (EXC EU, EXC AUS, all XC-W models).....	54	12.45	Additionally securing the rubber grip.....	78
11.15	Handlebar position.....	54	12.46	Adjusting the basic position of the clutch lever	78
11.16	Adjusting handlebar position 	54	12.47	Checking/correcting the fluid level of the hydraulic clutch.....	79
12	SERVICE WORK ON THE CHASSIS.....	56	12.48	Changing the hydraulic clutch fluid 	79
12.1	Raising the motorcycle with the lift stand.....	56	12.49	Removing the engine guard (EXC SIX DAYS, EXC AUS).....	80
12.2	Removing the motorcycle from the lift stand.....	56	12.50	Installing the engine guard (EXC SIX DAYS, EXC AUS).....	80
12.3	Bleeding fork legs	56	13	BRAKE SYSTEM	81
12.4	Cleaning the dust boots of the fork legs.....	56	13.1	Checking free travel of hand brake lever	81
12.5	Loosening the fork protector.....	57	13.2	Adjusting free travel of hand brake lever (all EXC models).....	81
12.6	Positioning the fork protector	57	13.3	Adjusting the basic position of the hand brake lever (all XC-W models).....	81
12.7	Removing the fork legs 	57	13.4	Checking the brake discs	82
12.8	Installing the fork legs 	58	13.5	Checking the brake fluid level of the front brake	82
12.9	Removing the fork protector 	59	13.6	Adding front brake fluid 	82
12.10	Installing the fork protector 	59	13.7	Checking the front brake linings	83
12.11	Removing the lower triple clamp  (EXC EU, EXC AUS, all XC-W models)	59	13.8	Changing the front brake linings 	84
12.12	Removing the lower triple clamp  (EXC SIX DAYS)	60	13.9	Checking the free travel of foot brake lever	85
12.13	Installing the lower triple clamp  (EXC EU, EXC AUS, all XC-W models)	61	13.10	Adjusting the basic position of the foot brake lever 	85
12.14	Installing the lower triple clamp  (EXC SIX DAYS).....	63	13.11	Checking the rear brake fluid level.....	86
12.15	Checking the steering head bearing play.....	64	13.12	Adding rear brake fluid 	86
12.16	Adjusting the play of the steering head bearing  (EXC EU, EXC AUS, all XC-W models).....	65	13.13	Checking the rear brake linings	87
12.17	Adjusting the play of the steering head bearing  (EXC SIX DAYS).....	65	13.14	Changing the rear brake linings 	88
12.18	Greasing the steering head bearing 	66	14	WHEELS, TIRES	90
			14.1	Removing the front wheel 	90
			14.2	Installing the front wheel 	90
			14.3	Removing the rear wheel 	91
			14.4	Installing the rear wheel 	92

14.5	Checking the tire condition	92	25	AUXILIARY SUBSTANCES	128
14.6	Checking the tire air pressure.....	93	26	STANDARDS	130
14.7	Checking spoke tension	93	INDEX		131
15	ELECTRICAL SYSTEM	95			
15.1	Removing the battery 🛠️.....	95			
15.2	Installing the battery 🛠️	95			
15.3	Charging the battery 🛠️.....	96			
15.4	Changing the main fuse.....	97			
15.5	Changing the fuses of individual power consumers.....	98			
15.6	Removing headlight mask with headlight.....	98			
15.7	Refitting the headlight mask with the headlight.....	99			
15.8	Changing the headlight bulb	99			
15.9	Changing the turn signal bulb	100			
15.10	Checking the headlight setting	100			
15.11	Adjusting the headlight range.....	101			
15.12	Changing the speedometer battery	101			
16	COOLING SYSTEM	103			
16.1	Cooling system	103			
16.2	Checking the antifreeze and coolant level	103			
16.3	Checking the coolant level	103			
16.4	Draining the coolant 🛠️.....	104			
16.5	Refilling coolant 🛠️.....	104			
17	TUNING THE ENGINE.....	106			
17.1	Checking the play in the throttle cable.....	106			
17.2	Adjusting the play in the throttle cable 🛠️.....	106			
17.3	Adjusting the idle speed 🛠️	107			
17.4	Checking the basic position of the shift lever ...	107			
17.5	Adjusting the basic position of the shift lever 🛠️	107			
18	SERVICE WORK ON THE ENGINE	108			
18.1	Changing the fuel screen 🛠️	108			
18.2	Checking the engine oil level.....	108			
18.3	Changing the engine oil and oil filter, cleaning the oil screens 🛠️	109			
18.4	Adding engine oil	111			
19	CLEANING, CARE	112			
19.1	Cleaning the motorcycle	112			
19.2	Checks and maintenance steps for winter operation.....	113			
20	STORAGE	114			
20.1	Storage	114			
20.2	Preparing for use after storage.....	114			
21	TROUBLESHOOTING	115			
22	BLINK CODE	117			
23	TECHNICAL DATA.....	119			
23.1	Engine	119			
23.2	Engine tightening torques	119			
23.3	Capacities	121			
23.3.1	Capacity - engine oil	121			
23.3.2	Capacity - coolant	121			
23.3.3	Capacity - fuel	121			
23.4	Chassis	121			
23.5	Electrical system.....	122			
23.6	Tires.....	122			
23.7	Fork.....	122			
23.7.1	EXC EU, EXC AUS, all XC-W models.....	122			
23.7.2	EXC SIX DAYS	123			
23.8	Shock absorber.....	123			
23.9	Chassis tightening torques	124			
24	SUBSTANCES	126			

1.1 Symbols used

The meaning of specific symbols is described below.

-
- | | |
|--|---|
|  | Indicates an expected reaction (e.g. of a work step or a function). |
|  | Indicates an unexpected reaction (e.g. of a work step or a function). |
|  | All work marked with this symbol requires specialist knowledge and technical understanding. In the interest of your own safety, have these jobs performed by an authorized KTM workshop. There, your motorcycle will be optimally cared for by specially trained experts using the specialist tools required. |
|  | Indicates a page reference (more information is provided on the specified page). |
-

1.2 Formats used

The typographical formats used in this document are explained below.

-
- | | |
|----------------------|--|
| Specific name | Identifies a proprietary name. |
| Name® | Identifies a protected name. |
| Brand™ | Identifies a brand available on the open market. |
-

2.1 Use definition - intended use

(all EXC models)

KTM sport motorcycles are designed and built to withstand the normal stresses and strains of competitive use. The motorcycles comply with currently valid regulations and categories of the top international motorsport organizations.



Info

The vehicle should only be used by trained persons. The motorcycle is authorized for public road traffic in the homologous (reduced) version only.

In the derestricted version, the motorcycle must be used only on closed off property remote from public road traffic.

This motorcycle is designed for use in offroad endurance competition and not primarily for use in motocross.

(all XC-W models)

KTM sport motorcycles are designed and built to withstand the normal stresses and strains of competitive use. The motorcycles comply with currently valid regulations and categories of the top international motorsport organizations.



Info

This motorcycle is designed for use in offroad endurance competition and not primarily for use in motocross.

2.2 Safety advice

A number of safety instructions need to be followed to operate the vehicle safely. Therefore, read this manual carefully. The safety instructions are highlighted in the text and are referred to at the relevant passages.



Info

The vehicle has various information and warning labels at prominent locations. Do not remove information/warning labels. If they are missing, you or others may not recognize dangers and may therefore be injured.

2.3 Degrees of risk and symbols



Danger

Identifies a danger that will immediately and invariably lead to fatal or serious permanent injury if the appropriate measures are not taken.



Warning

Identifies a danger that is likely to lead to fatal or serious injury if the appropriate measures are not taken.



Caution

Identifies a danger that may lead to minor injuries if the appropriate measures are not taken.

Note

Identifies a danger that will lead to considerable machine and material damage if the appropriate measures are not taken.



Warning

Identifies a danger that will lead to environmental damage if the appropriate measures are not taken.

2.4 Tampering warning



Tampering with the noise control system is prohibited. Federal law prohibits the following acts or the causing thereof:

- 1 The removal or rendering inoperative by any person other than for purposes of maintenance, repair, or replacement, of any device or element of design incorporated into any new vehicle for the purpose of noise control prior to its sale or delivery to the ultimate purchaser or while it is in use, or
- 2 the use of the vehicle after such device or element of design has been removed or rendered inoperative by any person.

Among those acts presumed to constitute tampering are the acts listed below:

- 1 Removal or puncturing of the main silencer, baffles, header pipes or any other components which conduct exhaust gases.
- 2 Removal or puncturing of parts of the intake system.
- 3 Lack of proper maintenance.
- 4 Replacing moving part of the vehicle, or parts of the exhaust or intake system, with parts other than those specified by the manufacturer.

2.5 Safe operation

-  **Danger**
Danger of accidents Danger arising from the rider's judgement being impaired.
- Do not operate the vehicle while under the influence of alcohol, drugs and certain medications or physically or mentally impaired.
-  **Danger**
Danger of poisoning Exhaust gases are toxic and inhaling them may result in unconsciousness and/or death.
- When running the engine, always make sure there is sufficient ventilation, and do not start or run the engine in an enclosed space without an effective exhaust extraction system.
-  **Warning**
Danger of burns Some vehicle components become very hot when the vehicle is operated.
- Do not touch hot components such as exhaust system, radiator, engine, shock absorber, and the brake system. Allow these components to cool down before starting work on them.

Only operate the vehicle when it is in perfect technical condition, in accordance with its intended use, and in a safe and environmentally compatible manner.

An appropriate driver's license is needed to ride the vehicle on public roads.

Have malfunctions that impair safety promptly eliminated by an authorized KTM workshop.

Adhere to the information and warning labels on the vehicle.

2.6 Protective clothing

-  **Warning**
Risk of injury Missing or poor protective clothing presents an increased safety risk.
- Wear protective clothing (helmet, boots, gloves, pants and jacket with protectors) every time you ride the vehicle. Always wear protective clothing that is in good condition and meets the legal requirements.

In the interest of your own safety, KTM recommends that you only operate the vehicle while wearing protective clothing.

2.7 Work rules

Special tools are necessary for certain tasks. The tools are not contained in the vehicle but can be ordered under the number in parentheses. E.g.: bearing puller (15112017000)

During assembly, non-reusable parts (e.g. self-locking screws and nuts, seals and seal rings, O-rings, pins, lock washers) must be replaced by new parts.

In some instances, a thread locker (e.g. **Loctite**®) is required. The manufacturer instructions for use must be followed.

After disassembly, clean the parts that are to be reused and check them for damage and wear. Change damaged or worn parts.

After you complete the repair or service work, check the operating safety of the vehicle.

2.8 Environment

If you use your motorcycle responsibly, you can ensure that problems and conflicts do not occur. To protect the future of the motorcycle sport, make sure that you use your motorcycle legally, display environmental consciousness, and respect the rights of others.

When disposing of used oil, other operating and auxiliary fluids, and used components, comply with the laws and regulations of the respective country.

Because motorcycles are not subject to the EU regulations governing the disposal of used vehicles, there are no legal regulations that pertain to the disposal of an end-of-life motorcycle. Your authorized KTM dealer will be glad to advise you.

2.9 Owner's Manual

It is important that you read this Owner's Manual carefully and completely before making your first trip. The Owner's Manual contains useful information and many tips on how to operate, handle, and maintain your motorcycle. Only then will you find out how to customize the vehicle ideally for your own use and how you can protect yourself from injury.

Keep the Owner's Manual in an accessible place to enable you to refer to it as needed.

If you would like to know more about the vehicle or have questions on the material you read, please contact an authorized KTM dealer. The Owner's Manual is an important component of the vehicle and should be handed over to the new owner if the vehicle is sold.

3.1 Guarantee, warranty

The work prescribed in the service schedule must be carried out by an authorized KTM workshop only and confirmed in the customer's Service & Warranty Booklet and in the **KTM dealer.net**; otherwise, all warranty claims will be void. No warranty claims can be considered for damage resulting from manipulations and/or alterations to the vehicle.

Additional information on the guarantee or warranty and the procedures involved can be found in the Service & Warranty Booklet.

3.2 Operating and auxiliary substances



Warning

Environmental hazard Improper handling of fuel is a danger to the environment.

- Do not allow fuel to get into the ground water, the ground, or the sewage system.

Use operating and auxiliary substances (such as fuel and lubricants) as specified in the Owner's Manual.

3.3 Spare parts, accessories

For your own safety, only use spare parts and accessory products that are approved and/or recommended by KTM and have them installed by an authorized KTM workshop. KTM accepts no liability for other products and any resulting damage or loss. Certain spare parts and accessory products are specified in parentheses in the descriptions. Your authorized KTM dealer will be glad to advise you.

The current **KTM PowerParts** for your vehicle can be found on the KTM website.

International KTM Website: <http://www.ktm.com>

3.4 Service

A prerequisite for perfect operation and prevention of premature wear is that the service, care, and tuning work on the engine and chassis is properly carried out as described in the Owner's Manual. Incorrect adjustment and tuning of the engine and chassis can lead to damage and breakage of components.

Use of the vehicle under difficult conditions, such as on sand or on wet and muddy surfaces, can lead to considerably more rapid wear of components such as the drive train, brake system, or suspension components. For this reason, it may be necessary to inspect or replace parts before the next scheduled service.

It is imperative that you adhere to the stipulated run-in times and service intervals. If you observe these exactly, you will ensure a much longer service life for your motorcycle.

3.5 Figures

The figures contained in the manual may depict special equipment.

In the interest of clarity, some components may be shown disassembled or may not be shown at all. It is not always necessary to disassemble the component to perform the activity in question. Please follow the instructions in the text.

3.6 Customer service

Your authorized KTM dealer will be happy to answer any questions you may have on your vehicle and KTM.

A list of authorized KTM dealers can be found on the KTM website.

International KTM Website: <http://www.ktm.com>

4.1 View of vehicle, front left (example)



- | | |
|---|----------------------------|
| 1 | Hand brake lever (☛ p. 14) |
| 2 | Clutch lever (☛ p. 14) |
| 3 | Filler cap |
| 4 | Shift lever (☛ p. 18) |
| 5 | Engine number (☛ p. 12) |
| 6 | Side stand (☛ p. 19) |

4.2 View of vehicle, rear right (example)



L00700-10

1	Kill switch (☛ p. 14)
1	Horn button (☛ p. 15)
1	Light switch (☛ p. 15)
1	Turn signal switch (☛ p. 15)
2	Emergency OFF switch (☛ p. 15)
2	Electric starter button (☛ p. 16)
3	Throttle grip (☛ p. 14)
4	Chassis number (☛ p. 12)
4	Type label (☛ p. 12)
5	Shock absorber part number (☛ p. 13)
6	Foot brake lever (☛ p. 19)
7	Kick starter (☛ p. 18)
8	Fork part number (☛ p. 12)

5.1 Chassis number

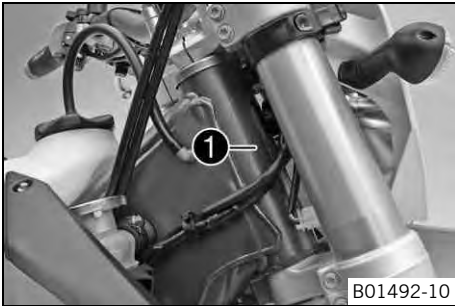

The chassis number ❶ is stamped on the steering head on the right.

5.2 Type label

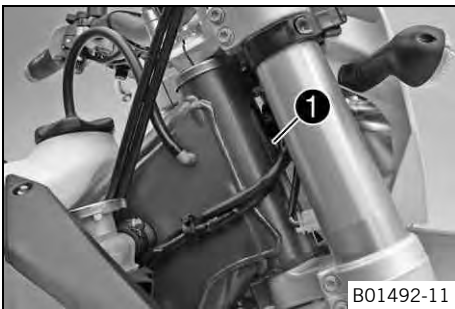

The type label ❶ is fixed to the front of the steering head.

5.3 Key number (all EXC models)



The key number ❶ for the steering lock is stamped onto the key connector.

5.4 Engine number

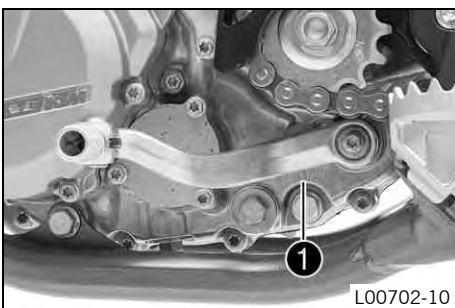

The engine number ❶ is stamped on the left side of the engine under the engine sprocket.

5.5 Fork part number

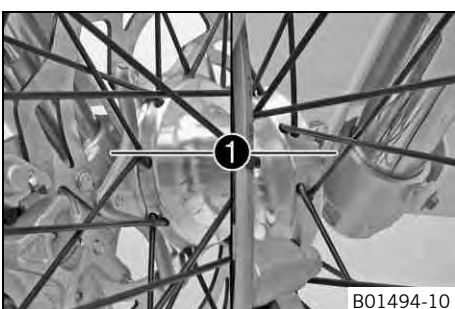

The fork part number ❶ is stamped on the inner side of the fork stub.

5.6 Shock absorber part number

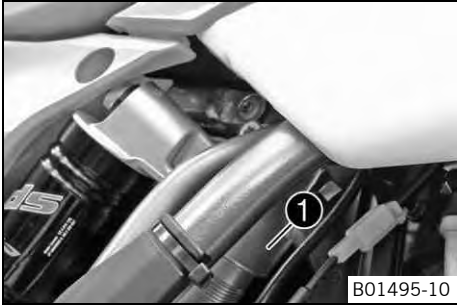

The shock absorber part number ❶ is stamped on the top of the shock absorber above the adjusting ring on the engine side.

6.1 Clutch lever

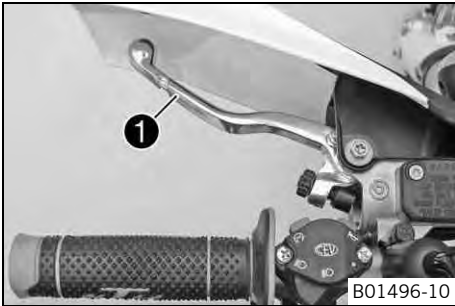

The clutch lever ❶ is fitted on the left side of the handlebar. The clutch is hydraulically operated and self-adjusting.

6.2 Hand brake lever

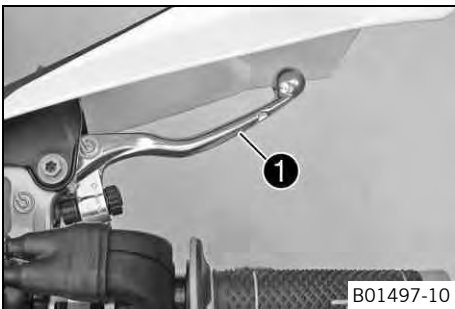

Hand brake lever ❶ is located on the right side of the handlebar. The hand brake lever is used to activate the front brake.

6.3 Throttle grip

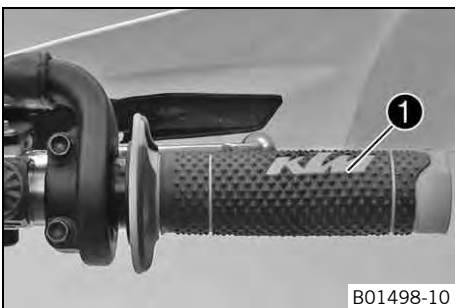

The throttle grip ❶ is fitted on the right side of the handlebar.

6.4 Kill switch (all EXC models)

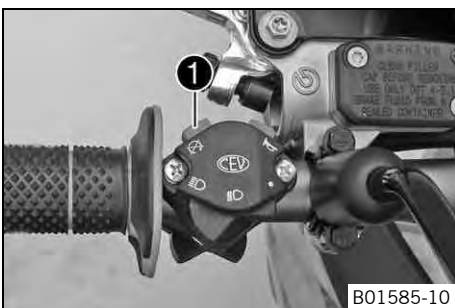

Kill switch ❶ is fitted on the left side of the handlebar.

Possible states

- Kill switch ☒ in basic position – the ignition circuit is closed in this position and the engine can be started.
- Kill switch ☒ pressed – the ignition circuit is open in this position, the engine goes out if it was running, or does not start if it was off.

6.5 Kill switch (all XC-W models)

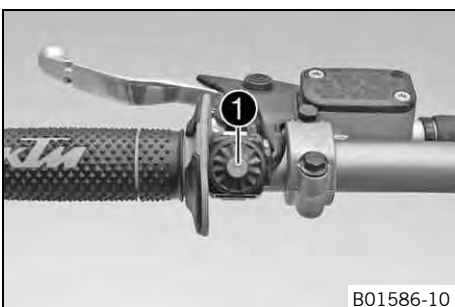

Kill switch ❶ is fitted on the left side of the handlebar.

Possible states

- Kill switch ☒ in basic position – the ignition circuit is closed in this position and the engine can be started.
- Kill switch ☒ pressed – the ignition circuit is open in this position, the engine goes out if it was running, or does not start if it was off.

6.6 Horn button (all EXC models)

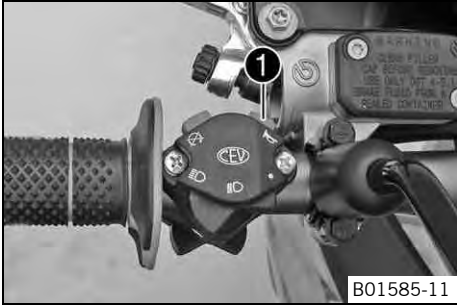

B01585-11

The horn button ❶ is fitted on the left side of the handlebar.

Possible states

- Horn button ↷ in neutral position
- Horn button ↷ pressed – the horn is actuated in this position.

6.7 Light switch (all EXC models)

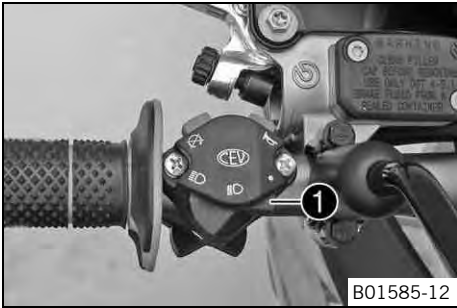

B01585-12

The light switch ❶ is fitted on the left side of the handlebar.

Possible states

●	Light off – Light switch is turned to the right. In this position, the light is switched off.
☰	Low beam on – Light switch is in the central position. In this position, the low beam and tail light are switched on.
☰	High beam on – Light switch is turned to the left. In this position, the high beam and the tail light are switched on.

6.8 Light switch (all XC-W models)



B01499-10

The light switch ❶ is on the right of the speedometer.

Possible states

- Light off – Light switch is pressed in up to the stop. In this position, the light is switched off.
- Light on – Light switch is pulled out to the stop. In this position, the low beam and tail light are switched on.

6.9 Turn signal switch (all EXC models)

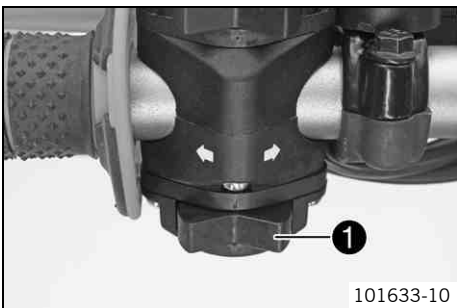

101633-10

Turn signal switch ❶ is fitted on the left side of the handlebar.

Possible states

	Turn signal light off – Turn signal switch is in the central position.
←	Turn signal light, left, on – Turn signal switch is turned to the left.
→	Turn signal light, right, on – Turn signal switch is turned to the right.

6.10 Emergency OFF switch (EXC AUS)

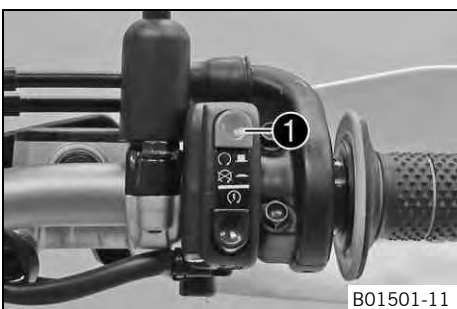

B01501-11

The emergency OFF switch ❶ is fitted on the right side of the handlebar.

Possible states

⊗	Ignition off – the ignition circuit is open in this position, the engine goes out if it was running, or does not start if it was off.
⊙	Ignition on – the ignition circuit is closed in this position and the engine can be started.

6.11 Electric starter button (EXC AUS)

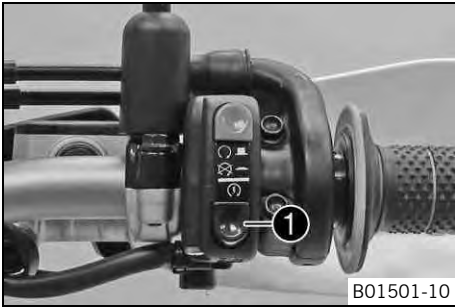

B01501-10

The electric starter button ❶ is fitted on the right side of the handlebar.

Possible states

- Electric starter button ❸ in basic position
- Electric starter button ❸ pressed – the electric starter is actuated in this position.

6.12 Electric starter button (EXC EU, EXC SIX DAYS, XC-W)

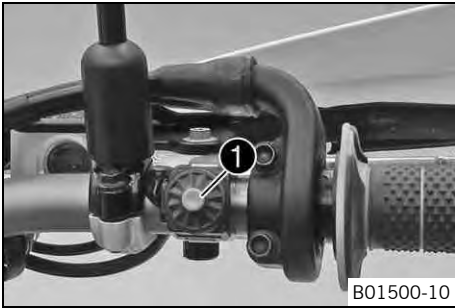

B01500-10

The electric starter button ❶ is fitted on the right side of the handlebar.

Possible states

- Electric starter button ❸ in basic position
- Electric starter button ❸ pressed – the electric starter is actuated in this position.

6.13 Overview of indicator lamps (EXC EU, EXC AUS)



B01587-01

Possible states

	The high beam indicator lamp lights up blue – The high beam is switched on.
	FI warning lamp (MIL) lights up/flashes orange – The OBD has detected an emission- or safety-critical fault.
	The low fuel warning lamp lights up orange – The fuel level has reached the reserve mark.
	Turn signal indicator light flashes green – The turn signal is switched on.

6.14 Overview of indicator lamps (EXC SIX DAYS)



B01589-01

Possible states

	The high beam indicator lamp lights up blue – The high beam is switched on.
	EFI warning lamp (MIL) lights up/flashes orange – The OBD has detected an emission- or safety-critical fault.
	The low fuel warning lamp lights up orange – The fuel level has reached the reserve mark.
	Turn signal indicator light flashes green – The turn signal is switched on.

6.15 Overview of indicator lamps (all XC-W models)



B01588-01

Possible states

	FI warning lamp (MIL) lights up/flashes orange – The OBD has detected an emission- or safety-critical fault.
	The low fuel warning lamp lights up orange – The fuel level has reached the reserve mark.

6.16 Opening filler cap

- Danger**
Fire hazard Fuel is highly flammable.
- Never refuel the vehicle near open flames or burning cigarettes, and always switch off the engine first. Be careful that no fuel is spilt, especially on hot vehicle components. Clean up spilt fuel immediately.
 - The fuel in the fuel tank expands when warm and may emerge if overfilled. Follow the instructions on refueling.

- Warning**
Danger of poisoning Fuel is poisonous and a health hazard.
- Fuel must not come into contact with the skin, eyes, or clothing. Do not breathe in the fuel vapors. If contact occurs with the eyes, rinse with water immediately and contact a physician. Immediately clean contaminated areas on the skin with soap and water. If fuel is swallowed, contact a physician immediately. Change clothing that is contaminated with fuel. Store fuel properly in a suitable canister and keep away from children.

- Warning**
Environmental hazard Improper handling of fuel is a danger to the environment.
- Do not allow fuel to get into the ground water, the ground, or the sewage system.

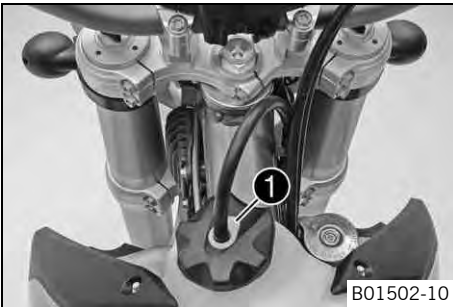

- Press release button **1**, turn filler cap counterclockwise and lift it upwards and remove.

6.17 Closing filler cap

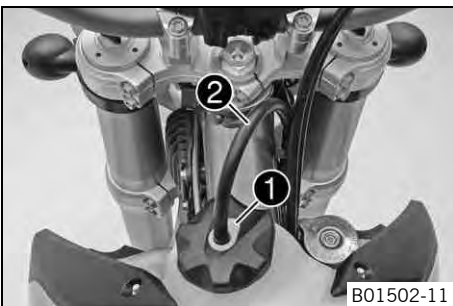

- Replace the filler cap and turn clockwise until the release button **1** locks in place.

i Info
Route the fuel tank breather hose **2** without kinking.

6.18 Idle speed adjusting screw

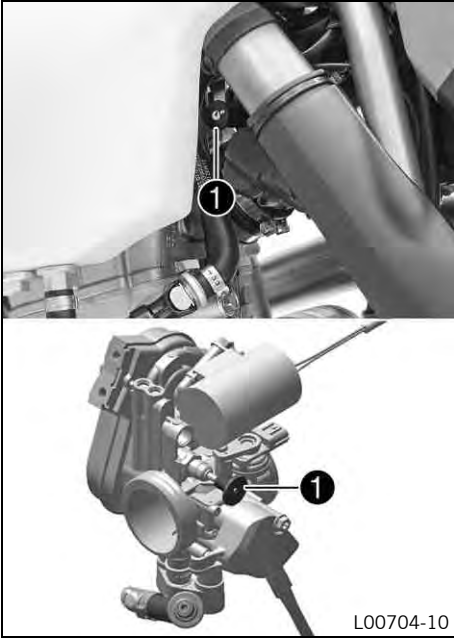

The idle speed adjusting screw ❶ is located on the throttle valve body at the top left. The idle speed adjusting screw has two functions. Turning it controls the idle speed. Pulling it out all the way raises the idle speed during a cold start.

Possible states

- RPM increase activated – Idle speed adjusting screw is pulled out all the way.
- RPM increase deactivated – Idle speed adjusting screw is pushed in all the way.

6.19 Shift lever

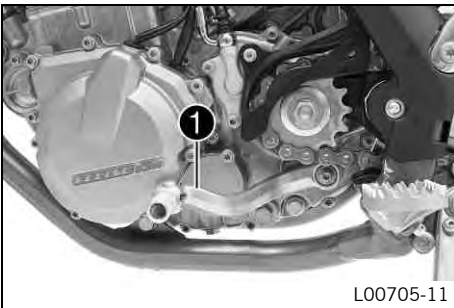

Shift lever ❶ is mounted on the left side of the engine.

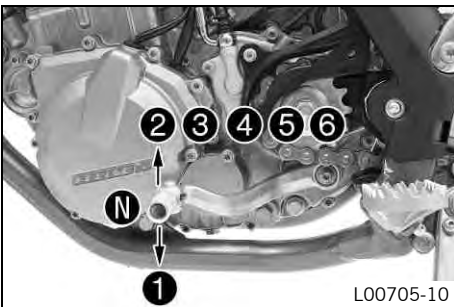

The gear positions can be seen in the photograph. The neutral or idle position is between the first and second gears.

6.20 Kick starter



The kick starter ❶ is fitted on the right of the engine. The engine can be started with either the kick starter or the electric starter. The upper part of the kick starter can be swung out.

i Info
Before riding, swing the upper part of the kick starter inwards towards the engine.

6.21 Foot brake lever



Foot brake lever ❶ is located in front of the right footrest. The foot brake lever is used to activate the rear brake.

6.22 Side stand

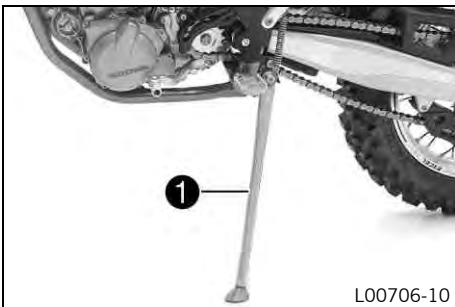

The side stand ❶ is on the left side of the vehicle.

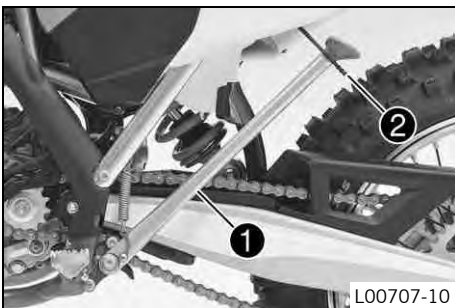

The side stand is used to park the motorcycle.

i Info
When you are riding, the side stand ❶ must be folded up and secured with the rubber band ❷.

6.23 Steering lock (all EXC models)

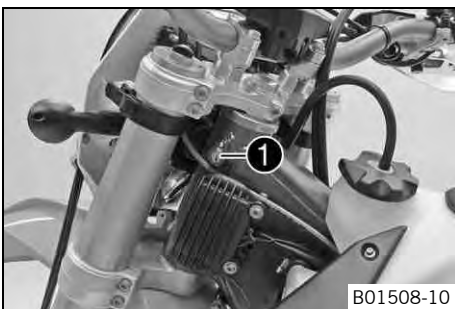

Steering lock ❶ is fitted on the left side of the steering head. The steering lock is used to lock the steering. Steering, and therefore riding, is no longer possible.

6.24 Locking the steering (all EXC models)

Note

Danger of damage The parked vehicle may roll away or fall over.

- Always place the vehicle on a firm and even surface.

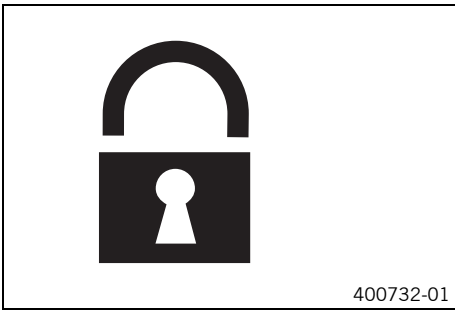

- Park the vehicle.
 - Turn the handlebar as far as possible to the right.
 - Insert the key in the steering lock, turn it to the left, press it in and turn it to the right. Remove the key.
- ✓ Steering is no longer possible.



Info

Never leave the key in the steering lock.

6.25 Unlocking the steering (all EXC models)

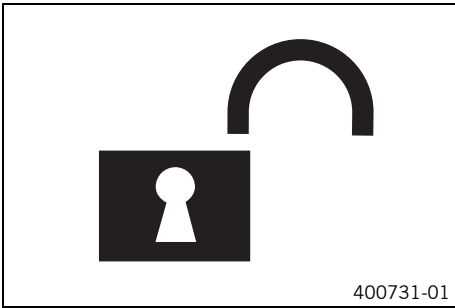

- Insert the key in the steering lock, turn it to the left, pull it out and turn it to the right. Remove the key.
- ✓ You can now steer the bike again.



Info

Never leave the key in the steering lock.

7.1 EXC EU, EXC AUS, all XC-W models

7.1.1 Speedometer overview

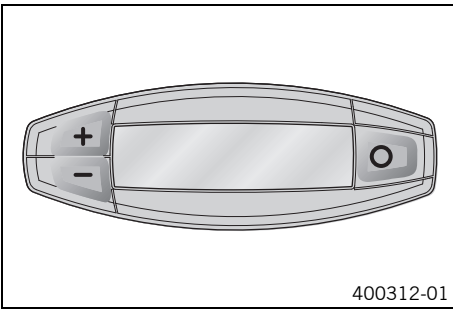

- Press the button to change the display mode or change to one of the Setup menus.
- Press the button to control different functions.
- Press the button to control different functions.

i Info
When the vehicle is delivered, only the **SPEED/H** and **SPEED/ODO** display modes are activated.

7.1.2 Activation and test

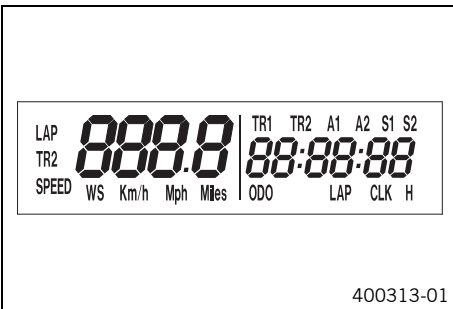

Activating the speedometer

The speedometer is activated when one of the buttons is pressed or an impulse comes from the wheel speed sensor.

Display test

To enable you to check that the display is functioning properly, all display segments light up briefly.

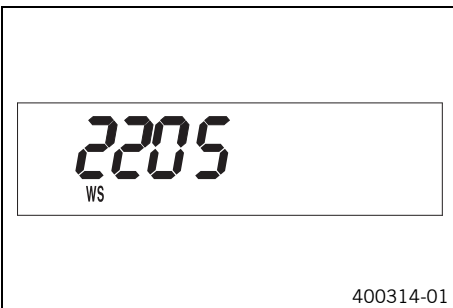

WS (wheel size)

After the display function check, the wheel size **WS** is displayed briefly.

i Info
The number 2205 equals the circumference of the 21" front wheel with standard tires.

The display then changes to the last selected mode.

7.1.3 Setting kilometers or miles

i Info
If you change the unit of measure, the **ODO** value is retained and converted accordingly. The values **TR1**, **TR2**, **A1**, **A2** and **S1** are cleared when the unit of measure is changed.

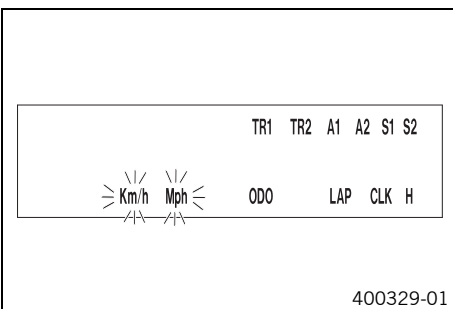

Condition

The motorcycle is stationary.

- Press the button briefly and repeatedly until **H** appears at the bottom right of the display.
- Press the button for 3 - 5 seconds.
 - ✓ The Setup menu is displayed and the active functions are shown.
- Press the button repeatedly until the **Km/h/Mph** display flashes.

Adjusting Km/h

- Press the button .

Adjusting Mph

- Press the button .
- Press the button for 3 - 5 seconds.
 - ✓ The settings are stored and the Setup menu is closed.

i Info
If no button is pressed for 20 seconds, or if no impulse comes from the wheel speed sensor, the settings are automatically saved and the Setup menu is closed.

7.1.4 Adjusting the speedometer functions



Info

When the vehicle is delivered, only the **SPEED/H** and **SPEED/ODO** display modes are activated.

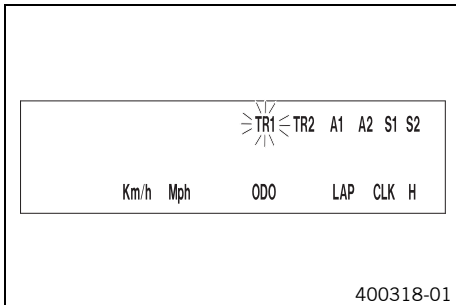

Condition

The motorcycle is stationary.

- Press the button briefly and repeatedly until **H** appears at the bottom right of the display.
- Press the button for 3 - 5 seconds.
 - ✓ The Setup menu is displayed and the activated functions are shown.
- Change to the desired function by pressing the button briefly.
 - ✓ The selected function flashes.

Activating a function

- Press the button .
- ✓ The symbol remains on the screen and the display changes to the next function.

Deactivating the function

- Press the button .
- ✓ The symbol on the screen goes out and the display changes to the next function.

- All desired functions are activated or deactivated accordingly.
- Press the button for 3 - 5 seconds.
 - ✓ The settings are stored and the Setup menu is closed.



Info

If no button is pressed for 20 seconds, or if no impulse comes from the wheel speed sensor, the settings are automatically saved and the Setup menu is closed.

7.1.5 Setting the clock

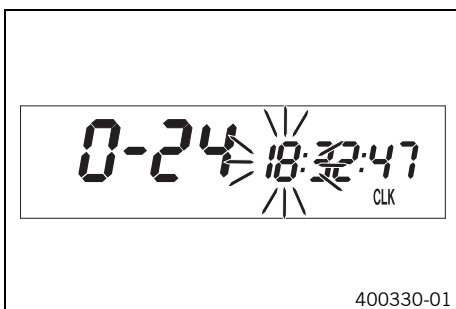

Condition

The motorcycle is stationary.

- Press the button briefly and repeatedly until **CLK** appears at the bottom right of the display.
- Press the button for 3 - 5 seconds.
 - ✓ The hour display flashes.
- Set the hour display with the button and/or button .
- Press the button briefly.
 - ✓ The next segment of the display flashes and can be set.
- You can set the following segments in the same way as the hours by pressing the button and the button .



Info

The seconds can only be set to zero.

- Press the button for 3 - 5 seconds.
 - ✓ The settings are stored and the Setup menu is closed.



Info

If no button is pressed for 20 seconds, or if no impulse comes from the wheel speed sensor, the settings are automatically saved and the Setup menu is closed.

7.1.6 Querying lap time



Info

This function can be called up only if lap times are measured.

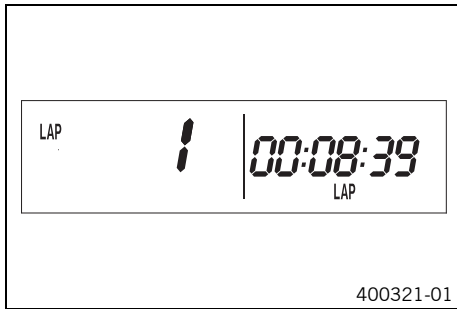

Condition

The motorcycle is stationary.

- Press the button briefly and repeatedly until **LAP** appears at the bottom right of the display.
- Press the button briefly.
 - ✓ **LAP 1** appears on the left side of the display.
- Laps 1-10 can be displayed by pressing the button .
- The button has no function.
- Press the button briefly.
 - ✓ Next display mode



Info

If an impulse is received from the wheel speed sensor, the left side of the display changes back to the **SPEED** mode.

7.1.7 Display mode SPEED (speed)

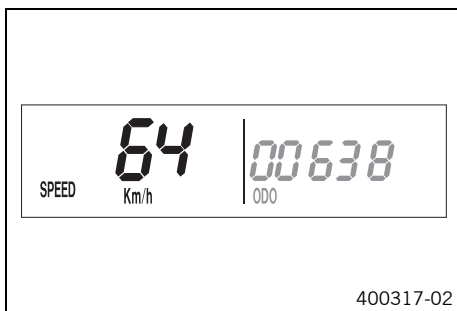

- Press the button briefly and repeatedly until **SPEED** appears on the left side of the display.

The current speed is displayed in the **SPEED** display mode.

The current speed can be displayed in **Km/h** or **Mph**.



Info

Making the setting according to the country.

When an impulse comes from the front wheel, the left side of the speedometer display changes to the **SPEED** mode and the current speed is shown.

7.1.8 Display mode SPEED/H (service hours)



Condition

- The motorcycle is stationary.
- Press the button briefly and repeatedly until **H** appears at the bottom right of the display.

In display mode **H**, the service hours of the engine are displayed.

The service hour counter stores the total traveling time.



Info

The service hour counter is necessary for ensuring that service work is carried out at the right intervals.

If the speedometer is in **H** display mode at the start of the journey, it automatically changes to the **ODO** display mode.

The **H** display mode is suppressed during the journey.

Press the button .	No function
Press the button .	No function
Press the button for 3 - 5 seconds.	The display changes to the Setup menu of the speedometer functions.
Press the button briefly.	Next display mode

7.1.9 Setup menu

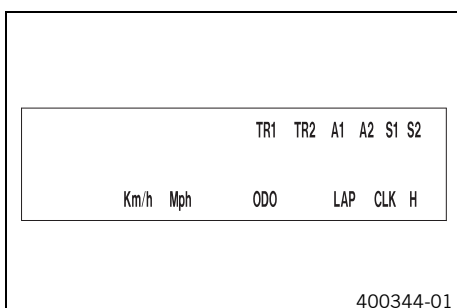

Condition





- The motorcycle is stationary.
- Press the button briefly and repeatedly until **H** appears at the bottom right of the display.
- Press the button for 3 - 5 seconds.

The Setup menu displays the active functions.



Info



If no button is pressed for 20 seconds, the settings are automatically stored.

Press the button 	Activates the flashing display
Press the button 	Deactivates the flashing display
Press the button  briefly.	Changes to the next display without changes
Press the button  for 3 - 5 seconds.	Setup menu starts, stores the settings, and changes to H or ODO .

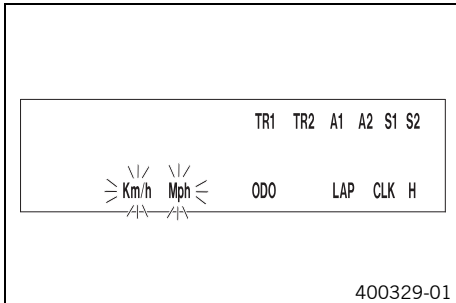
7.1.10 Unit of measurement menu







Condition

- The motorcycle is stationary.
- Press the button  briefly and repeatedly until **H** appears at the bottom right of the display.
- Press the button .

In measurement unit mode, you can change the unit of measurement.

Info

If no button is pressed for 20 seconds, the settings are automatically stored.



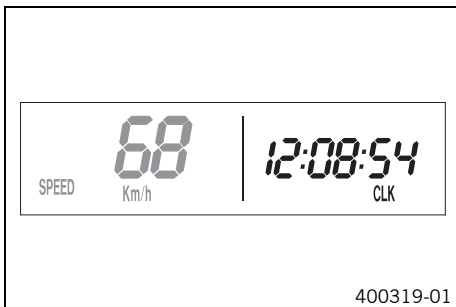

Press the button 	Starts selection, activates Km/h display
Press the button 	Activates Mph display
Press the button  briefly.	Changes to the next display, changes from selection to the Setup menu
Press the button  for 3 - 5 seconds.	Saves and closes the Setup menu

7.1.11 Display mode SPEED/CLK (time)



- Press the button  briefly and repeatedly until **CLK** appears at the bottom right of the display.



The time is shown in display mode **CLK**.



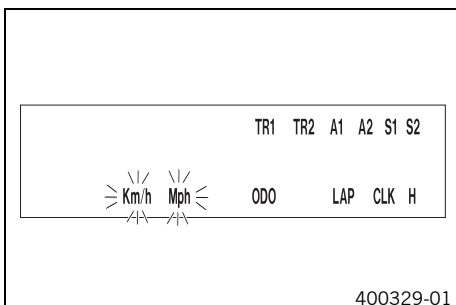

Press the button 	No function
Press the button 	No function
Press the button  for 3 - 5 seconds.	The display changes to the Setup menu of the clock.
Press the button  briefly.	Next display mode

7.1.12 Setting the clock





Condition

- The motorcycle is stationary.
- Press the button  briefly and repeatedly until **CLK** appears at the bottom right of the display.
- Press the button  for 3 - 5 seconds.

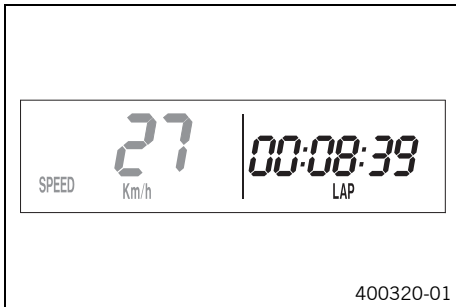

Press the button 	Increases the value
Press the button 	Reduces the value
Press the button  briefly.	Changes to the next value
Press the button  for 3 - 5 seconds.	Starts and exits the SETUP menu





7.1.13 Display mode SPEED/LAP (lap time)



- Press the button  briefly and repeatedly until **LAP** appears at the bottom right of the display.

In the **LAP** display mode, up to 10 lap times can be timed with the stop watch.



i Info
If the lap time continues running after the button  is pressed, 9 memory locations are occupied.
Lap 10 must be timed using the button .



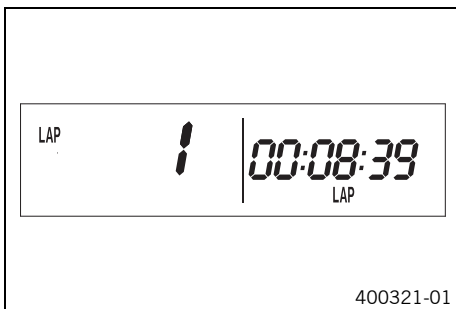

Press the button  .	Starts or stops the clock.
Press the button  .	Times the current lap time, stores it and the stop watch starts the next lap.
Press the button  for 3 - 5 seconds.	The stop watch and the lap time are reset.
Press the button  briefly.	Next display mode

7.1.14 Viewing the lap time





Condition

- The motorcycle is stationary.
- Press the button  briefly and repeatedly until **LAP** appears at the bottom right of the display.
- Briefly press the button .



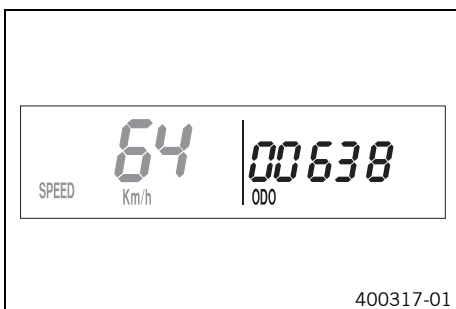

Press the button  .	Select a lap from 1–10
Press the button  .	No function
Press the button  for 3 - 5 seconds.	No function
Press the button  briefly.	Next display mode

7.1.15 Display mode SPEED/ODO (odometer)





- Press the button  briefly and repeatedly until **ODO** appears at the bottom right of the display.

The total distance traveled is displayed in the **ODO** display mode.

Press the button  .	No function
Press the button  .	No function
Press the button  for 3 - 5 seconds.	No function
Press the button  briefly.	Next display mode

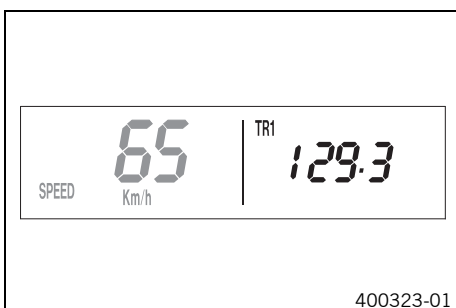
7.1.16 Display mode SPEED/TR1 (trip master 1)





- Press the button  briefly and repeatedly until **TR1** appears at the top right of the display.

TR1 (trip master 1) runs constantly and counts to 999.9.

You can use it to measure trips or the distance between refueling stops.

TR1 is coupled with **A1** (average speed 1) and **S1** (stop watch 1).

i Info
If 999.9 is exceeded, the values of **TR1**, **A1** and **S1** are automatically reset to 0.0.

Press the button  .	No function
Press the button  .	No function
Press the button  for 3 - 5 seconds.	The TR1 , A1 and S1 displays are reset to 0.0.



Press the button  briefly.	Next display mode
---	-------------------

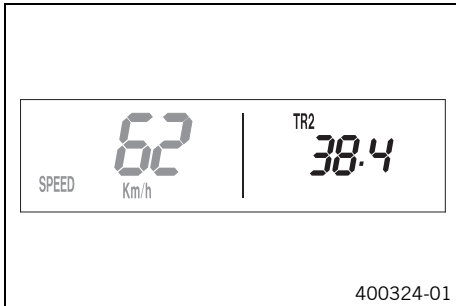

7.1.17 Display mode SPEED/TR2 (trip master 2)







- Press the button  briefly and repeatedly until **TR2** appears at the top right of the display.

TR2 (trip master 2) runs constantly and counts up to 999.9.

The displayed value can be set manually with the button  and the button . This is a very practical function when riding using the road book.



i Info
The **TR2** value can also be corrected manually during the journey with the button  and the button . If 999.9 is exceeded, the value of **TR2** is automatically reset to 0.0.

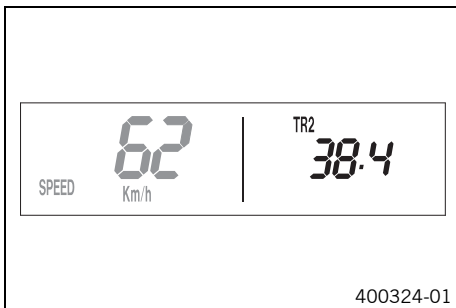

Press the button  .	Increases value of TR2 .
Press the button  .	Reduces value of TR2 .
Press the button  for 3 - 5 seconds.	Deletes value of TR2 .
Press the button  briefly.	Next display mode



7.1.18 Setting TR2 (trip master 2)







Condition

- The motorcycle is stationary.
- Press the button  briefly and repeatedly until **TR2** appears at the top right of the display.
- Press the button  for 2–3 seconds until **TR2** flashes.

The displayed value can be set manually with the button  and the button . This is a very practical function when riding using the road book.

i Info
The **TR2** value can also be corrected manually during the journey with the button  and the button . If 999.9 is exceeded, the value of **TR2** is automatically reset to 0.0.

Press the button  .	Increases value of TR2 .
Press the button  .	Reduces value of TR2 .
Press the button  for 3 - 5 seconds.	Deletes value of TR2 .
Press the button  briefly.	Next display mode





7.1.19 Display mode SPEED/A1 (average speed 1)



- Press the button  briefly and repeatedly until **A1** appears at the top right of the display.

A1 (average speed 1) shows the average speed calculated on the basis of **TR1** (trip master 1) and **S1** (stop watch 1).

The calculation of this value is activated by the first impulse of the wheel speed sensor and ends 3 seconds after the last impulse.

Press the button  .	No function
Press the button  .	No function
Press the button  for 3 - 5 seconds.	The TR1 , A1 and S1 displays are reset to 0.0.
Press the button  briefly.	Next display mode

7.1.20 Display mode SPEED/A2 (average speed 2)

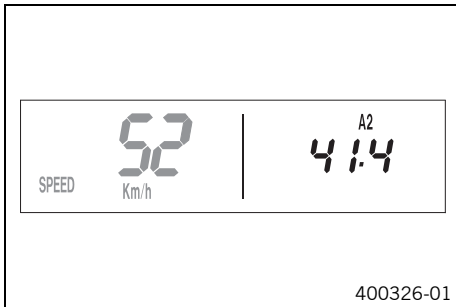

- Press the button briefly and repeatedly until **A2** appears at the top right of the display.

A2 (average speed 2) shows the average speed on the basis of the current speed if the stop watch **S2** (stop watch 2) is running.

i Info
The displayed value can differ from the actual average speed if **S2** is not stopped after the ride.

Press the button	No function
Press the button	No function
Press the button for 3 - 5 seconds.	Displays of TR2 , A2 and S2 are reset to 0,0.
Press the button briefly.	Next display mode

7.1.21 Display mode SPEED/S1 (stop watch 1)



- Press the button briefly and repeatedly until **S1** appears at the top right of the display.

S1 (stop watch 1) displays the journey time on the basis of **TR1** and continues when an impulse is received from the wheel speed sensor.

The calculation of this value starts with the first impulse of the wheel speed sensor and ends 3 seconds after the last impulse.

Press the button	No function
Press the button	No function
Press the button for 3 - 5 seconds.	Displays of TR1 , A1 and S1 are reset to 0.0.
Press the button briefly.	Next display mode

7.1.22 Display mode SPEED/S2 (stop watch 2)



- Press the button briefly and repeatedly until **S2** appears at the top right of the display.

S2 (stop watch 2) is a manual stop watch.

If **S2** is running in the background, the **S2** display flashes in the speedometer display.

Press the button	Starts or stops S2 .
Press the button	No function
Press the button for 3 - 5 seconds.	Displays of S2 and A2 are reset to 0.0.
Press the button briefly.	Next display mode

7.1.23 Table of functions

Display	Press the button	Press the button	Press the button for 3 - 5 seconds.	Press the button briefly.
Display mode SPEED/H (service hours)	No function	No function	The display changes to the Setup menu of the speedometer functions.	Next display mode
Setup menu	Activates the flashing display	Deactivates the flashing display	Setup menu starts, stores the settings, and changes to H or ODO .	Changes to the next display without changes
Unit of measurement menu	Starts selection, activates Km/h display	Activates Mph display	Saves and closes the Setup menu	Changes to the next display, changes from selection to the Setup menu
Display mode SPEED/CLK (time)	No function	No function	The display changes to the Setup menu of the clock.	Next display mode

Display	Press the button + .	Press the button - .	Press the button ○ for 3 - 5 seconds.	Press the button ○ briefly.
Setting the clock	Increases the value	Reduces the value	Starts and exits the SETUP menu	Changes to the next value
Display mode SPEED/LAP (lap time)	Starts or stops the clock.	Times the current lap time, stores it and the stop watch starts the next lap.	The stop watch and the lap time are reset.	Next display mode
Viewing the lap time	Select a lap from 1–10	No function	No function	Next display mode
Display mode SPEED/ODO (odometer)	No function	No function	No function	Next display mode
Display mode SPEED/TR1 (trip master 1)	No function	No function	The TR1 , A1 and S1 displays are reset to 0.0.	Next display mode
Display mode SPEED/TR2 (trip master 2)	Increases value of TR2 .	Reduces value of TR2 .	Deletes value of TR2 .	Next display mode
Setting TR2 (trip master 2)	Increases value of TR2 .	Reduces value of TR2 .	Deletes value of TR2 .	Next display mode
Display mode SPEED/A1 (average speed 1)	No function	No function	The TR1 , A1 and S1 displays are reset to 0.0.	Next display mode
Display mode SPEED/A2 (average speed 2)	No function	No function	Displays of TR2 , A2 and S2 are reset to 0,0.	Next display mode
Display mode SPEED/S1 (stop watch 1)	No function	No function	Displays of TR1 , A1 and S1 are reset to 0.0.	Next display mode
Display mode SPEED/S2 (stop watch 2)	Starts or stops S2 .	No function	Displays of S2 and A2 are reset to 0.0.	Next display mode

7.1.24 Table of conditions and menu activation

Display	The motorcycle is stationary.	Menu can be activated
Display mode SPEED/H (service hours)	•	
Setup menu	•	
Unit of measurement menu	•	
Setting the clock	•	
Display mode SPEED/LAP (lap time)		•
Viewing the lap time	•	
Display mode SPEED/TR1 (trip master 1)		•
Display mode SPEED/TR2 (trip master 2)		•
Setting TR2 (trip master 2)	•	
Display mode SPEED/A1 (average speed 1)		•
Display mode SPEED/A2 (average speed 2)		•
Display mode SPEED/S1 (stop watch 1)		•
Display mode SPEED/S2 (stop watch 2)		•

7.2 EXC SIX DAYS

7.2.1 Speedometer overview

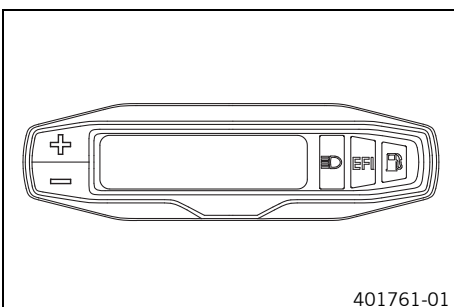

401761-01

- Press the button **+** to control different functions.
- Press the button **-** to control different functions.

i Info
When the vehicle is delivered, only the **SPEED/H** and **SPEED/ODO** display modes are activated.

7.2.2 Activation and test

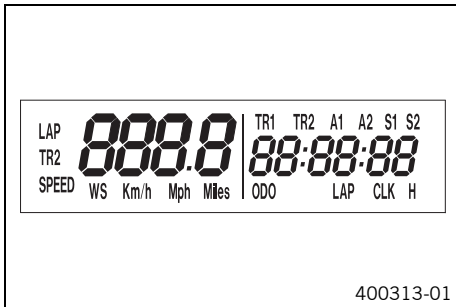

Activating the speedometer

The speedometer is activated when one of the buttons is pressed or an impulse comes from the wheel speed sensor.

Display test

To enable you to check that the display is functioning properly, all display segments light up briefly.



WS (wheel size)

After the display function check, the wheel size **WS** is displayed briefly.



Info

The number 2205 equals the circumference of the 21" front wheel with standard tires.

The display then changes to the last selected mode.

7.2.3 Setting kilometers or miles



Info

If you change the unit, the value **ODO** is retained and converted accordingly. The values **TR1**, **TR2**, **A1**, **A2** and **S1** are cleared when the unit of measure is changed.

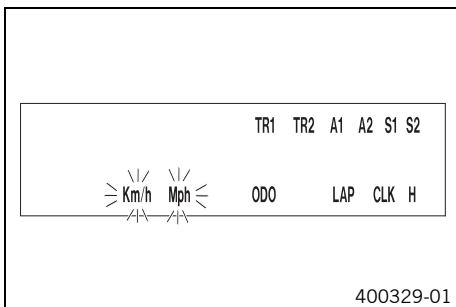

Condition

The motorcycle is stationary.

- Repeatedly press the button briefly until **H** appears at the bottom right of the display.
- Press the button for 2–3 seconds.
 - ✓ The Setup menu is displayed and the active functions are shown.
- Repeatedly press the button briefly until **Km/h/Mph** flashes.

Setting the Km/h

- Press the button .

Setting the Mph

- Press the button .
- Wait 3–5 seconds
- ✓ The settings are stored.



Info

If no button is actuated for 10–12 seconds or there is no signal from the wheel speed sensor, then the settings are automatically stored and the Setup menu is closed.

7.2.4 Setting the speedometer functions



Info

When the vehicle is delivered, only the **SPEED/H** and **SPEED/ODO** display modes are activated.

Condition

The motorcycle is stationary.

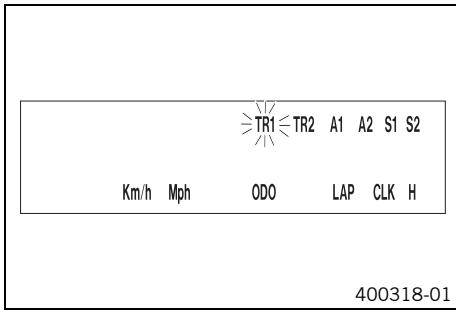

- Repeatedly press the button briefly until **H** appears at the bottom right of the display.
- Press the button for 2–3 seconds.
- ✓ The Setup menu is displayed and the active functions are shown.

i Info

If no button is pressed for 10–12 seconds, the settings are automatically stored.
If no button is actuated for 20 seconds or there is no signal from the wheel speed sensor, then the settings are automatically stored and the Setup menu is closed.

- Repeatedly press the button briefly until the desired function flashes.
- ✓ The selected function flashes.

Activating the function

- Press the button .
- ✓ The symbol continues to appear in the display and the next function appears.

Deactivating a function

- Press the button .
- ✓ The symbol disappears in the display and the next function appears.

7.2.5 Setting the clock

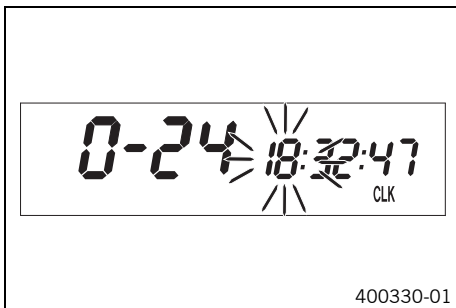

Condition

The motorcycle is stationary.

- Repeatedly press the button briefly until **CLK** appears at the bottom right of the display.
- Press the button for 2–3 seconds.
- ✓ The hour display flashes.
- Set the hour display with the button and/or button .
- Wait 3–5 seconds
- ✓ The next segment of the display flashes and can be set.
- You can set the following segments in the same way as the hours by pressing the button and the button .

i Info

The seconds can only be set to zero.
If no button is actuated for 15–20 seconds or there is no signal from the wheel speed sensor, then the settings are automatically stored and the Setup menu is closed.

7.2.6 Viewing the lap time

i Info

This function can only be opened if lap times have actually been timed.

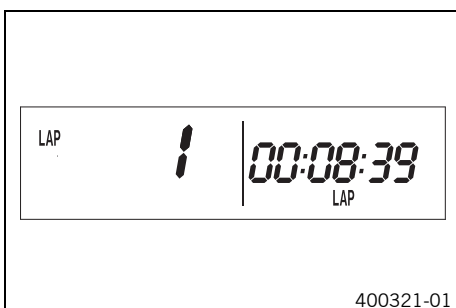

Condition

The motorcycle is stationary.

- Repeatedly press the button briefly until **LAP** appears at the bottom right of the display.
- Briefly press the button .
- ✓ **LAP 1** appears on the left side of the display.
- The laps 1–10 can be viewed with the button .
- Press and hold the button for 3–5 seconds to clear the lap times.
- Briefly press the button .
- ✓ Next display mode

i Info

When a signal from the wheel speed sensor arrives, the left side of the display changes back to the **SPEED** mode.

7.2.7 Display mode SPEED (speed)

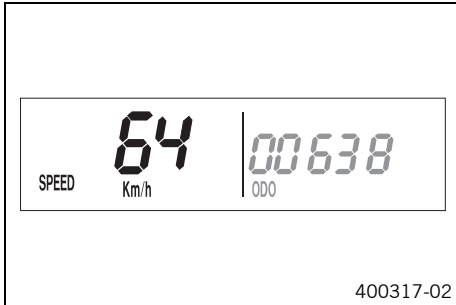

400317-02

- Repeatedly press the button briefly until **SPEED** appears on the left side of the display.

The current speed is displayed in the **SPEED** display mode.
The current speed can be displayed in **Km/h** or **Mph**.

i Info
Making the setting according to the country.
When an impulse comes from the front wheel, the left side of the speedometer display changes to the **SPEED** mode and the current speed is shown.

7.2.8 Display mode SPEED/H (service hours)



400316-01

Condition

- The motorcycle is stationary.
- Repeatedly press the button briefly until **H** appears at the bottom right of the display.

In display mode **H**, the service hours of the engine are displayed.
The service hour counter stores the total traveling time.

i Info
The service hour counter is necessary for ensuring that service work is carried out at the right intervals.
If the speedometer is in **H** display mode at the start of the journey, it automatically changes to the **ODO** display mode.
The **H** display mode is suppressed during the journey.

Press the button for 2–3 seconds.	The display changes to the Setup menu of the speedometer functions.
Briefly press the button .	Next display mode
Press the button for 2–3 seconds.	No function
Briefly press the button .	No function

7.2.9 Setup menu

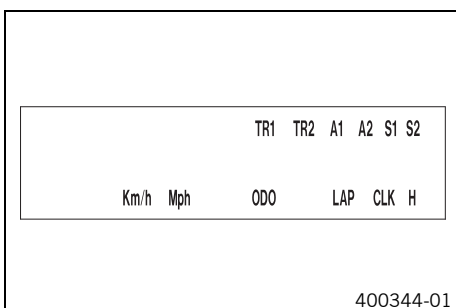

400344-01

Condition

- The motorcycle is stationary.
- Repeatedly press the button briefly until **H** appears at the bottom right of the display.
- Press the button for 2–3 seconds.

The Setup menu displays the active functions.

i Info
Repeatedly press the button briefly until the desired function is opened.
If no button is pressed for 20 seconds, the settings are automatically stored.

Briefly press the button .	Activates the flashing display and changes to the next display
Press the button for 2–3 seconds.	No function
Briefly press the button .	Deactivates the flashing display and changes to the next display
Press the button for 2–3 seconds.	No function
Wait 3–5 seconds	Changes to the next display without changes
Wait 10–12 seconds	Setup menu starts, stores the settings, and changes to H or ODO .

7.2.10 Setting the unit of measurement

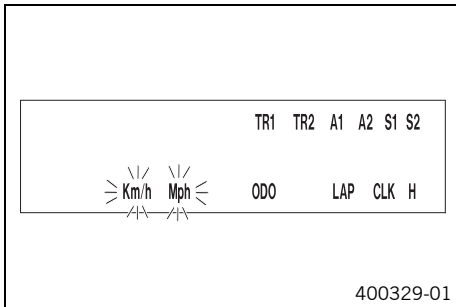

Condition

- The motorcycle is stationary.
- Repeatedly press the button briefly until **H** appears at the bottom right of the display.
- Press the button for 2–3 seconds.
- Repeatedly press the button briefly until **Km/h/Mph** flashes.

In measurement unit mode, you can change the unit of measurement.

Info

If no button is pressed for 5 seconds, the settings are automatically stored.

Briefly press the button .	Starts selection, activates Km/h display
Press the button for 2–3 seconds.	No function
Briefly press the button .	Activates Mph display
Press the button for 2–3 seconds.	No function
Wait 3–5 seconds	Changes to the next display, changes from selection to the Setup menu
Wait 10–12 seconds	Saves and closes the Setup menu

7.2.11 Display mode SPEED/CLK (time)

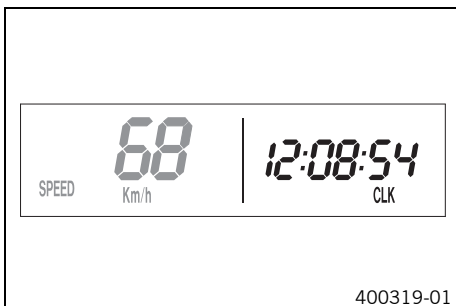

- Repeatedly press the button briefly until **CLK** appears at the bottom right of the display.

The time is shown in display mode **CLK**.

Press the button for 2–3 seconds.	The display changes to the Setup menu of the clock.
Briefly press the button .	Next display mode
Press the button for 2–3 seconds.	No function
Briefly press the button .	No function

7.2.12 Setting the clock

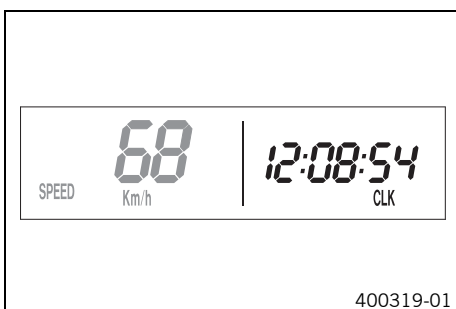

Condition

- The motorcycle is stationary.
- Repeatedly press the button briefly until **CLK** appears at the bottom right of the display.
- Press the button for 2–3 seconds.

Press the button for 2–3 seconds.	Increases the value
Briefly press the button .	Increases the value
Press the button for 2–3 seconds.	Reduces the value
Briefly press the button .	Reduces the value
Wait 3–5 seconds	Changes to the next value
Wait 10–12 seconds	Closes the SETUP menu

7.2.13 Display mode SPEED/LAP (lap time)

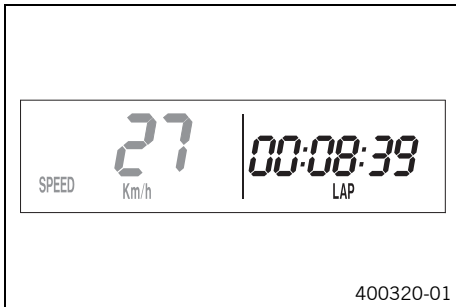

- Repeatedly press the button **+** briefly until **LAP** appears at the bottom right of the display.

In the **LAP** display mode, up to 10 lap times can be timed with the stop watch.

i Info
If the lap time continues running after the button **-** is pressed, 9 memory locations are occupied.
Lap 10 must be timed using the button **+**.

Press the button + for 2–3 seconds.	The stop watch and the lap time are reset.
Briefly press the button + .	Next display mode
Press the button - for 2–3 seconds.	Stops the clock.
Briefly press the button - .	Starts the stop watch or stop the current lap time measurement, stores it and the stop watch starts the next lap.

7.2.14 Viewing the lap time

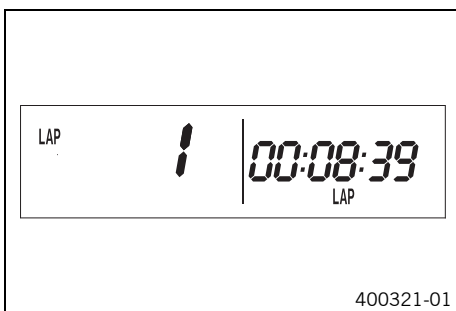

Condition

- The motorcycle is stationary.
- Repeatedly press the button **+** briefly until **LAP** appears at the bottom right of the display.
- Briefly press the button **+**.

Press the button + for 2–3 seconds.	The stop watch and the lap time are reset.
Briefly press the button + .	Select a lap from 1–10
Press the button - for 2–3 seconds.	No function
Briefly press the button - .	View the next lap time.

7.2.15 Display mode SPEED/ODO (odometer)

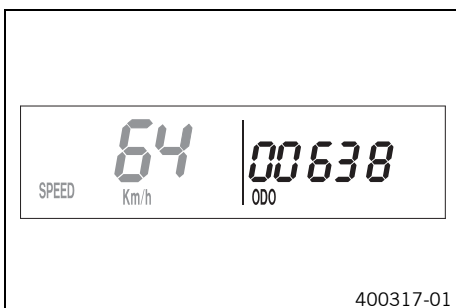

- Repeatedly press the button **+** briefly until **ODO** appears at the bottom right of the display.

The total traveled distance is shown in display mode **ODO**.

Press the button + for 2–3 seconds.	No function
Briefly press the button + .	Next display mode
Press the button - for 2–3 seconds.	No function
Briefly press the button - .	No function

7.2.16 Display mode SPEED/TR1 (trip master 1)

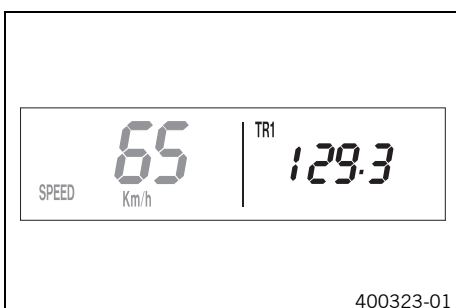

- Repeatedly press the button **+** briefly until **TR1** appears at the top right of the display.

TR1 (trip master 1) runs constantly and counts up to 999.9.

You can use it to measure trips or the distance between refueling stops.

TR1 is coupled with **A1** (average speed 1) and **S1** (stop watch 1).

i Info
If 999.9 is exceeded, the values of **TR1**, **A1** and **S1** are automatically reset to 0.0.

Press the button + for 2–3 seconds.	Displays of TR1 , A1 and S1 are reset to 0,0.
Briefly press the button + .	Next display mode
Press the button - for 2–3 seconds.	No function
Briefly press the button - .	No function

7.2.17 Display mode SPEED/TR2 (trip master 2)

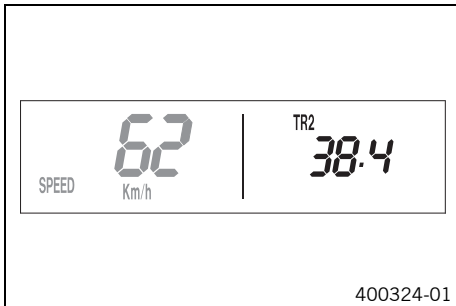

- Repeatedly press the button **+** briefly until **TR2** appears at the top right of the display.

TR2 (trip master 2) runs constantly and counts up to 999.9.

Press the button + for 2–3 seconds.	Clears the values TR2 and A2 .
Briefly press the button + .	Next display mode
Press the button - for 2–3 seconds.	Reduces value of TR2 .
Briefly press the button - .	Reduces value of TR2 .

7.2.18 Setting TR2 (trip master 2)

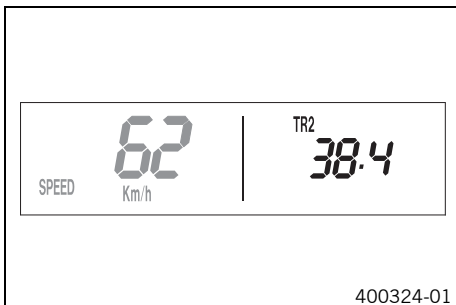

Condition

- The motorcycle is stationary.
- Repeatedly press the button **+** briefly until **TR2** appears at the top right of the display.
- Press the button **-** for 2–3 seconds until **TR2** flashes.

The displayed value can be set manually with the button **+** and the button **-**. This is a very practical function when riding using the road book.

i Info

The **TR2** value can also be corrected manually during the journey with the button **+** and the button **-**.
If 999.9 is exceeded, the value of **TR2** is automatically reset to 0.0.

Press the button + for 2–3 seconds.	Increases value of TR2 .
Briefly press the button + .	Increases value of TR2 .
Press the button - for 2–3 seconds.	Reduces value of TR2 .
Briefly press the button - .	Reduces value of TR2 .
Wait 10–12 seconds	Saves and closes the Setup menu

7.2.19 Display mode SPEED/A1 (average speed 1)



- Repeatedly press the button **+** briefly until **A1** appears at the top right of the display.

A1 (average speed 1) shows the average speed calculated using **TR1** (trip master 1) and **S1** (stop watch 1).

The calculation of this value is activated by the first impulse of the wheel speed sensor and ends 3 seconds after the last impulse.

Press the button + for 2–3 seconds.	Displays of TR1 , A1 and S1 are reset to 0,0.
Briefly press the button + .	Next display mode

Press the button  for 2–3 seconds.	No function
Briefly press the button  .	No function



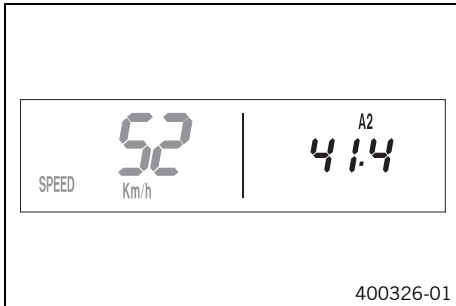

7.2.20 Display mode SPEED/A2 (average speed 2)



- Repeatedly press the button  briefly until **A2** appears at the top right of the display.

A2 (average speed 2) shows the average speed on the basis of the current speed if the stop watch **S2** (stop watch 2) is running.

Info The displayed value can differ from the actual average speed if **S2** was not stopped after the ride.

Briefly press the button  .	Next display mode
Press the button  for 2–3 seconds.	No function
Press the button  for 2–3 seconds.	No function
Briefly press the button  .	No function





7.2.21 Display mode SPEED/S1 (stop watch 1)



- Repeatedly press the button  briefly until **S1** appears at the top right of the display.

S1 (Stop watch 1) shows the riding time based on **TR1** and continues running as soon as an impulse arrives from the wheel speed sensor.

The calculation of this value starts with the first impulse from the wheel speed sensor and ends 3 seconds after the last impulse.

Press the button  for 2–3 seconds.	Displays of TR1 , A1 and S1 are reset to 0,0.
Briefly press the button  .	Next display mode
Press the button  for 2–3 seconds.	No function
Briefly press the button  .	No function



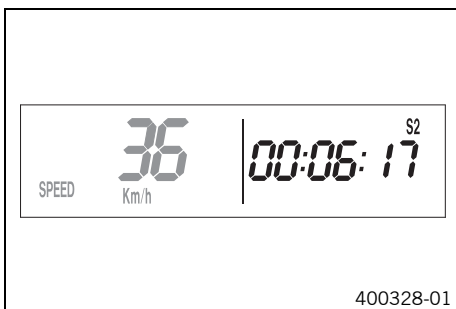

7.2.22 Display mode SPEED/S2 (stop watch 2)



- Repeatedly press the button  briefly until **S2** appears at the top right of the display.

S2 (Stop watch 2) is a manual stop watch.

If **S2** is running in the background, the display **S2** flashes on the speedometer.

Press the button  for 2–3 seconds.	The displays of S2 and A2 are set to 0,0.
Briefly press the button  .	Next display mode
Press the button  for 2–3 seconds.	No function
Briefly press the button  .	Starts or stops S2 .

7.2.23 Table of functions

Display	Press the button + for 2–3 seconds.	Briefly press the button + .	Press the button = for 2–3 seconds.	Briefly press the button = .	Wait 3–5 seconds	Wait 10–12 seconds
Display mode SPEED/H (service hours)	The display changes to the Setup menu of the speedometer functions.	Next display mode	No function	No function		
Setup menu	No function	Activates the flashing display and changes to the next display	No function	Deactivates the flashing display and changes to the next display	Changes to the next display without changes	Setup menu starts, stores the settings, and changes to H or ODO .
Setting the unit of measurement	No function	Starts selection, activates Km/h display	No function	Activates Mph display	Changes to the next display, changes from selection to the Setup menu	Saves and closes the Setup menu
Display mode SPEED/CLK (time)	The display changes to the Setup menu of the clock.	Next display mode	No function	No function		
Setting the clock	Increases the value	Increases the value	Reduces the value	Reduces the value	Changes to the next value	Closes the SETUP menu
Display mode SPEED/LAP (lap time)	The stop watch and the lap time are reset.	Next display mode	Stops the clock.	Starts the stop watch or stop the current lap time measurement, stores it and the stop watch starts the next lap.		
Viewing the lap time	The stop watch and the lap time are reset.	Select a lap from 1–10	No function	View the next lap time.		
Display mode SPEED/ODO (odometer)	No function	Next display mode	No function	No function		
Display mode SPEED/TR1 (trip master 1)	Displays of TR1 , A1 and S1 are reset to 0,0.	Next display mode	No function	No function		
Display mode SPEED/TR2 (trip master 2)	Clears the values TR2 and A2 .	Next display mode	Reduces value of TR2 .	Reduces value of TR2 .		
Setting TR2 (trip master 2)	Increases value of TR2 .	Increases value of TR2 .	Reduces value of TR2 .	Reduces value of TR2 .		Saves and closes the Setup menu
Display mode SPEED/A1 (average speed 1)	Displays of TR1 , A1 and S1 are reset to 0,0.	Next display mode	No function	No function		
Display mode SPEED/A2 (average speed 2)	No function	Next display mode	No function	No function		
Display mode SPEED/S1 (stop watch 1)	Displays of TR1 , A1 and S1 are reset to 0,0.	Next display mode	No function	No function		
Display mode SPEED/S2 (stop watch 2)	The displays of S2 and A2 are set to 0,0.	Next display mode	No function	Starts or stops S2 .		

7.2.24 Table of conditions and menu activation

Display	The motorcycle is stationary.	Menu can be activated
Display mode SPEED/H (service hours)	•	
Setup menu	•	
Setting the unit of measurement	•	
Setting the clock	•	
Display mode SPEED/LAP (lap time)		•
Viewing the lap time	•	
Display mode SPEED/TR1 (trip master 1)		•
Display mode SPEED/TR2 (trip master 2)		•
Setting TR2 (trip master 2)	•	
Display mode SPEED/A1 (average speed 1)		•
Display mode SPEED/A2 (average speed 2)		•
Display mode SPEED/S1 (stop watch 1)		•
Display mode SPEED/S2 (stop watch 2)		•

8.1 Advice on first use

**Danger****Danger of accidents** Danger arising from the rider's judgement being impaired.

- Do not operate the vehicle while under the influence of alcohol, drugs and certain medications or physically or mentally impaired.

**Warning****Risk of injury** Missing or poor protective clothing presents an increased safety risk.

- Wear protective clothing (helmet, boots, gloves, pants and jacket with protectors) every time you ride the vehicle. Always wear protective clothing that is in good condition and meets the legal requirements.

**Warning****Danger of crashing** Poor vehicle handling due to different tire tread patterns on front and rear wheels.

- The front and rear wheels must be fitted with tires with similar tread patterns to prevent loss of control over the vehicle.

**Warning****Danger of accidents** Critical riding behavior due to inappropriate riding.

- Adapt your riding speed to the road conditions and your riding ability.

**Warning****Danger of accidents** Accident risk caused by presence of a passenger.

- Your vehicle is not designed to carry passengers. Do not ride with a passenger.

**Warning****Danger of accidents** Failure of brake system.

- If the foot brake lever is not released, the brake linings drag continuously. The rear brake may fail due to overheating. Take your foot off the foot brake lever when you are not braking.

**Warning****Danger of accidents** Unstable riding behavior.

- Do not exceed the maximum permissible weight and axle loads.

**Warning****Risk of misappropriation** Usage by unauthorized persons.

- Never leave the vehicle while the engine is running. Secure the vehicle against use by unauthorized persons.

**Info**

When using your motorcycle, remember that others may feel disturbed by excessive noise.

- Make sure that the pre-delivery inspection work has been carried out by an authorized KTM workshop.
 - ✓ You receive a delivery certificate and the service record at vehicle handover.
- Before your first trip, read the entire operating instructions carefully.
- Get to know the controls.
- Adjust the basic position of the clutch lever. (☛ p. 78)

(all EXC models)

- Adjust the free travel of the hand brake lever. (☛ p. 81)

(all XC-W models)

- Adjust the basic position of the hand brake lever. (☛ p. 81)
- Adjust the basic position of the foot brake lever. ☛ (☛ p. 85)
- Adjust the basic position of the shift lever. ☛ (☛ p. 107)
- Get used to handling the motorcycle on a suitable piece of land before making a longer trip.

**Info**

Offroad, you should be accompanied by another person on another machine so that you can help each other.

- Try also to ride as slowly as possible and in a standing position to get a better feeling for the vehicle.
- Do not make any offroad trips that over-stress your ability and experience.

- Hold the handlebar firmly with both hands and keep your feet on the footrests when riding.
- If you carry any baggage, make sure it is fixed firmly as close as possible to the center of the vehicle and ensure even weight distribution between the front and rear wheels.



Info

Motorcycles react sensitively to any changes of weight distribution.

- Do not exceed the overall maximum permitted weight and the axle loads.

Guideline

Maximum permissible overall weight	335 kg (739 lb.)
Maximum permissible front axle load	145 kg (320 lb.)
Maximum permissible rear axle load	190 kg (419 lb.)

- Run in the engine. (🔧 p. 39)

8.2 Running-in the engine

- During the running-in phase, do not exceed the specified engine speed and engine performance.

Guideline

Maximum engine speed	
During the first operating hour	7,000 rpm
Maximum engine performance	
During the first 3 operating hours	≤ 75 %

- Avoid fully opening the throttle!

8.3 Preparing the vehicle for difficult riding conditions



Info

Use of the vehicle under difficult conditions, such as on sand or on wet and muddy surfaces, can lead to considerably more rapid wear of components such as the drive train, brake system, or suspension components. For this reason, it may be necessary to inspect or replace parts before the next scheduled service.

- KTM recommends that you use the specified engine oil for difficult riding conditions and to increase performance.

Engine oil (SAE 10W/60) (00062010035) (🔧 p. 126)
--

- Clean the air filter and air filter box. 🛠️ (🔧 p. 69)



Info

Check the air filter approx. every 30 minutes.

- Seal the air filter box. 🛠️ (🔧 p. 70)
- Additionally secure the rubber grip. (🔧 p. 78)
- Check the electrical connector for humidity and corrosion and to ensure it is firmly seated.
 - » If humidity, corrosion or damage is found:
 - Clean and dry the connector, or change it if necessary.

Difficult riding conditions are:

- Rides on dry sand. (🔧 p. 40)
- Rides on wet sand. (🔧 p. 40)
- Rides on wet and muddy surfaces. (🔧 p. 41)
- Rides at high temperature and slow speed. (🔧 p. 41)
- Rides at low low temperature or in snow. (🔧 p. 41)

8.4 Preparing for rides on dry sand



- Fit a dust cover on the air filter.

Dust protection device for air filter (77206920000)



Info

See the **KTM PowerParts** fitting instructions.



- Fit a sand cover on the air filter.

Sand protection device for air filter (59006022000)



Info

See the **KTM PowerParts** fitting instructions.



- Clean the chain.

Chain cleaner (☛ p. 128)

- Fit the steel sprocket.



Tip

Do not grease the chain.

- Clean the radiator fins.
- Straighten bent radiator fins carefully.

8.5 Preparing for rides on wet sand



- Fit a rain cover on the air filter.

Waterproofing device for air filter (77206921000)



Info

See the **KTM PowerParts** fitting instructions.



- Clean the chain.

Chain cleaner (☛ p. 128)

- Fit the steel sprocket.



Tip

Do not grease the chain.

- Clean the radiator fins.
- Straighten bent radiator fins carefully.

8.6 Preparing for rides on wet and muddy surfaces



- Fit a waterproofing device on the air filter.

Waterproofing device for air filter (77206921000)



Info

See the **KTM PowerParts** fitting instructions.



- Fit the steel sprocket.
- Clean the motorcycle. (☛ p. 112)
- Straighten bent radiator fins carefully.

8.7 Preparing for rides at high temperature and slow speed



- Adjust the secondary drive to the road conditions.



Info

The engine oil heats up quickly when the clutch is operated frequently due to an excessively high secondary drive.

- Clean the chain.

Chain cleaner (☛ p. 128)

- Clean the radiator fins.
- Straighten bent radiator fins carefully.
- Check the coolant level. (☛ p. 103)

8.8 Preparing for rides at low temperature or in snow



- Fit a waterproofing device on the air filter.

Waterproofing device for air filter (77206921000)



Info

See the **KTM PowerParts** fitting instructions.

9.1 Checks and maintenance work when preparing for use



Info

Before riding the vehicle, always check its condition and operating safety. The vehicle must be in perfect technical condition when used.

- Check the engine oil level. (☛ p. 108)
- Check the electrical system.
- Check the brake fluid level of the front brake. (☛ p. 82)
- Check the rear brake fluid level. (☛ p. 86)
- Check the front brake linings. (☛ p. 83)
- Check the rear brake linings. (☛ p. 87)
- Check that the brake system is functioning properly.
- Check the coolant level. (☛ p. 103)
- Check for chain dirt accumulation. (☛ p. 73)
- Check the chain, rear sprocket, engine sprocket and chain guide. (☛ p. 75)
- Check the chain tension. (☛ p. 74)
- Check the tire condition. (☛ p. 92)
- Check the tire air pressure. (☛ p. 93)
- Check the spoke tension. (☛ p. 93)
- Clean the dust boots of the fork legs. (☛ p. 56)
- Bleed fork legs. (☛ p. 56)
- Check the air filter.
- Check the settings of all controls and ensure that they can be operated smoothly.
- Check all screws, nuts, and hose clamps regularly for tightness.
- Check the fuel supply.

9.2 Starting



Danger

Danger of poisoning Exhaust gases are toxic and inhaling them may result in unconsciousness and/or death.

- When running the engine, always make sure there is sufficient ventilation, and do not start or run the engine in an enclosed space without an effective exhaust extraction system.

Note

Engine failure High engine speeds in cold engines have a negative effect on the service life of the engine.

- Always warm up the engine at low engine speeds.

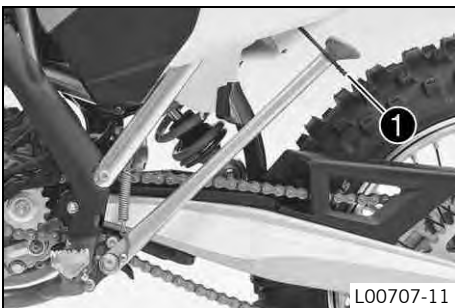

L00707-11

- Raise the motorcycle off of the stand and secure the stand with the rubber band ❶.
- Shift transmission to neutral.

(EXC AUS)

- Turn the emergency OFF switch to the position ❷.

Condition

Ambient temperature: < 20 °C (< 68 °F)

- Pull the idle speed adjusting screw all the way out.

- Press the electric starter button or press the kick starter robustly through its full range.



Info

Press the electric starter button for at most 5 seconds. Wait for a least 5 seconds before trying again.

Warning lamp **FI** lights up briefly as a functional control when starting.

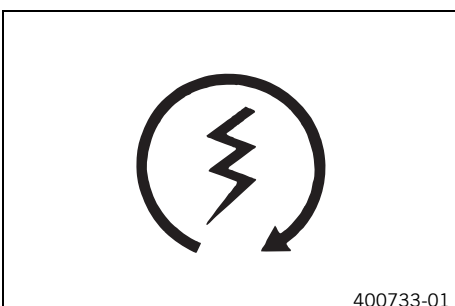

400733-01

9.3 Starting off

Info

If your bike has lights, switch them on before riding. You will then be seen earlier by other motorists. When you are riding, the side stand must be folded up and secured with the rubber band.

- Pull the clutch lever, engage 1st gear, release the clutch lever slowly and simultaneously open the throttle carefully.

9.4 Shifting, riding

Warning

Danger of accidents If you change down at high engine speed, the rear wheel can lock up.

- Do not change into a low gear at high engine speed. The engine races and the rear wheel can lock up.

Info

If you hear unusual noises while riding, stop immediately, switch off the engine, and contact an authorized KTM workshop. First gear is used for starting off or for steep inclines.

- When conditions allow (incline, road situation, etc.), you can shift into a higher gear. To do so, release the throttle while simultaneously pulling the clutch lever, shift into the next gear, release the clutch, and open the throttle.
- After reaching maximum speed by fully opening the throttle grip, turn the throttle back so it is $\frac{3}{4}$ open. This will barely reduce the speed but fuel consumption will be considerably lower.
- Always open the throttle only as much as the engine can handle – abrupt throttle opening increases fuel consumption.
- To shift down, brake and close the throttle at the same time.
- Pull the clutch lever and shift into a lower gear, release the clutch lever slowly, and open the throttle or shift again.
- Switch off the engine if you expect to be standing for a long time.

Guideline

≥ 2 min

- Avoid frequent and longer slipping of the clutch. This heats the engine oil, the engine, and the cooling system.
- Ride with a lower engine speed instead of with a high engine speed and a slipping clutch.

9.5 Braking

Warning

Danger of accidents If you brake too hard, the wheels can lock.

- Adapt your braking to the traffic situation and the road conditions.

Warning

Danger of accidents Reduced braking efficiency caused by spongy pressure point of front or rear brake.

- Check the brake system and do not continue riding. (Your authorized KTM workshop will be glad to help.)

Warning

Danger of accidents Reduced braking efficiency due to a wet or dirty brake system.

- Clean or dry a dirty or wet brake system by riding and braking gently.

- On sandy, wet or slippery surfaces, use the rear brake.
- Braking should always be completed before you go into a bend. Change down to a lower gear appropriate to your road speed.
- Make use of the braking effect of the engine when driving down long downhill stretches. To do so, shift back one or two gears, but do not overrev the engine. You will need to apply the brakes far less often and the brake system will not overheat.

9.6 Stopping, parking



Warning

Risk of misappropriation Usage by unauthorized persons.

- Never leave the vehicle while the engine is running. Secure the vehicle against use by unauthorized persons.



Warning

Danger of burns Some vehicle components become very hot when the vehicle is operated.

- Do not touch hot components such as exhaust system, radiator, engine, shock absorber, and the brake system. Allow these components to cool down before starting work on them.

Note

Danger of damage The parked vehicle may roll away or fall over.

- Always place the vehicle on a firm and even surface.

Note

Fire hazard Some vehicle components become very hot when the vehicle is operated.

- Do not park the vehicle near flammable or explosive substances. Do not place objects on the vehicle while it is still warm from being run. Always let the vehicle cool first.

Note

Material damage Damage to or destruction of components due to excessive load.

- The side stand is only designed for the weight of the motorcycle. Do not sit on the motorcycle when it is resting on the side stand. The side stand or the frame may become damaged and the motorcycle may fall over.

- Brake the motorcycle.
- Shift transmission to neutral.

(all EXC models)

- Press and hold the kill switch  while the engine is idling until the engine stops.

(all XC-W models)

- Press and hold the kill switch  while the engine is idling until the engine stops.
- Park the motorcycle on firm ground.

9.7 Transport

Note

Danger of damage The parked vehicle may roll away or fall over.

- Always place the vehicle on a firm and even surface.

Note

Fire hazard Some vehicle components become very hot when the vehicle is operated.

- Do not park the vehicle near flammable or explosive substances. Do not place objects on the vehicle while it is still warm from being run. Always let the vehicle cool first.

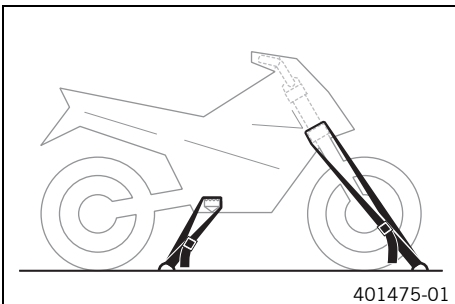

- Switch off the engine.
- Use tension belts or other suitable devices to secure the motorcycle against accidents or falling over.

9.8 Refueling

Danger
Fire hazard Fuel is highly flammable.

- Never refuel the vehicle near open flames or burning cigarettes, and always switch off the engine first. Be careful that no fuel is spilt, especially on hot vehicle components. Clean up spilt fuel immediately.
- The fuel in the fuel tank expands when warm and may emerge if overfilled. Follow the instructions on refueling.

Warning
Danger of poisoning Fuel is poisonous and a health hazard.

- Fuel must not come into contact with the skin, eyes, or clothing. Do not breathe in the fuel vapors. If contact occurs with the eyes, rinse with water immediately and contact a physician. Immediately clean contaminated areas on the skin with soap and water. If fuel is swallowed, contact a physician immediately. Change clothing that is contaminated with fuel.

Note
Material damage Premature clogging of the fuel filter.

- In some countries and regions, the available fuel quality and cleanliness may not be sufficient. This will result in problems with the fuel system. (Your authorized KTM workshop will be glad to help.)
- Only refuel with clean fuel that meets the specified standards.

Warning
Environmental hazard Improper handling of fuel is a danger to the environment.

- Do not allow fuel to get into the ground water, the ground, or the sewage system.

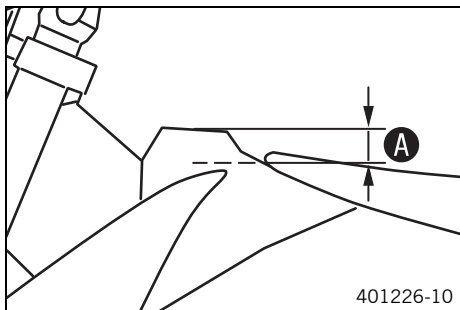

- Switch off engine.
- Open the filler cap. (☛ p. 17)
- Fill the fuel tank with fuel up to measurement **A**.

Guideline

Measurement of A	35 mm (1.38 in)	
Total fuel tank capacity, approx. (all EXC models)	9 l (2.4 US gal)	Super unleaded (ROZ 95/RON 95/PON 91) (☛ p. 127)
Total fuel tank capacity, approx. (all XC-W models)	8.5 l (2.25 US gal)	Super unleaded (ROZ 95/RON 95/PON 91) (☛ p. 127)

- Close the filler cap. (☛ p. 17)

10.1 Service schedule

	Every 30 operating hours/after every race	Every 15 operating hours	Once after 1 operating hour
Read out the fault memory using the KTM diagnostics tool. 🛠️	○	●	●
Check that the electrical equipment is functioning properly.	○	●	●
Check and charge the battery. 🛠️		●	●
Check the front brake linings. (🔧 p. 83)		●	●
Check the rear brake linings. (🔧 p. 87)		●	●
Check the brake discs. (🔧 p. 82)		●	●
Check the brake lines for damage and leakage.		●	●
Check the rear brake fluid level. (🔧 p. 86)		●	●
Check the free travel of the foot brake lever. (🔧 p. 85)		●	●
Check the frame and swingarm. 🛠️		●	●
Check the swingarm bearing. 🛠️			●
Check the heim joints at the top and bottom of the shock absorber. 🛠️		●	●
Check the tire condition. (🔧 p. 92)	○	●	●
Check the tire air pressure. (🔧 p. 93)	○	●	●
Check the wheel bearing for play. 🛠️		●	●
Check the wheel hubs. 🛠️		●	●
Check the rim run-out. 🛠️	○	●	●
Check the spoke tension. (🔧 p. 93)	○	●	●
Check the chain, rear sprocket, engine sprocket and chain guide. (🔧 p. 75)		●	●
Check the chain tension. (🔧 p. 74)	○	●	●
Grease all moving parts (e.g., side stand, hand lever, chain, ...) and check for smooth operation. 🛠️		●	●
Check/correct the fluid level of the hydraulic clutch. (🔧 p. 79)		●	●
Check the brake fluid level of the front brake. (🔧 p. 82)		●	●
Check the free travel of the hand brake lever. (🔧 p. 81)		●	●
Check the steering head bearing play. (🔧 p. 64)	○	●	●
Check the valve clearance. 🛠️	○		●
Check the clutch. 🛠️			●
Change the shaft seal rings of the water pump. 🛠️			●
Change the engine oil and oil filter and clean the oil screens. 🛠️ (🔧 p. 109)	○	●	●
Check all hoses (e. g., fuel, cooling, bleeding, drainage) and sleeves for cracking, leaks, and incorrect routing. 🛠️	○	●	●
Check the antifreeze and coolant level. (🔧 p. 103)	○	●	●
Check the cables for damage and routing without sharp bends. 🛠️		●	●
Check that the cables are undamaged, routed without sharp bends and set correctly.	○	●	●
Clean the air filter and air filter box. 🛠️		●	●
Change the glass fiber yarn filling of the main silencer. 🛠️ (🔧 p. 70)			●
Check the screws and nuts for tightness. 🛠️	○	●	●
Check the headlight setting. (🔧 p. 100)	○	●	●
Change the fuel screen. 🛠️ (🔧 p. 108)	○	●	●
Check the fuel pressure. 🛠️		●	●
Adjust the idle speed. 🛠️ (🔧 p. 107)	○	●	●
Check that the radiator fan is functioning properly. 🛠️	○	●	●
Final check: Check the vehicle for roadworthiness and take a test ride.	○	●	●
Read out the fault memory using the KTM diagnostics tool after a test ride. 🛠️	○	●	●
Make the service entry in KTM DEALER.NET and in the service record. 🛠️	○	●	●

○ One-time interval

- Periodic interval

10.2 Service work (as additional order)

	Annually		
	Every 135 operating hours/every 70 operating hours when used for motorsports	Every 45 operating hours	Once after 15 operating hours
Change the front brake fluid. 🛠️			•
Change the rear brake fluid. 🛠️			•
Change the hydraulic clutch fluid. 🛠️ (🔧 p. 79)			•
Grease the steering head bearing. 🛠️ (🔧 p. 66)			•
Clean the spark arrestor. 🛠️ (all XC-W models)			•
Perform a fork service. (EXC SIX DAYS) 🛠️	○	•	•
Perform a fork service. (EXC EU, EXC AUS, all XC-W models) 🛠️	○	•	•
Service the shock absorber. 🛠️		•	•
Change the spark plug and spark plug connector. 🛠️			•
Change the piston. 🛠️			•
Check/measure the cylinder. 🛠️			•
Check the cylinder head. 🛠️			•
Change the valves, valve springs and valve spring seats. 🛠️			•
Check the camshaft and cam lever. 🛠️			•
Change the connecting rod, conrod bearing, and crank pin. 🛠️			•
Check the transmission and shift mechanism. 🛠️			•
Check the oil pressure regulator valve. 🛠️			•
Change the suction pump. 🛠️			•
Check the oil pumps and lubrication system. 🛠️			•
Replace the timing chain. 🛠️			•
Check the timing assembly. 🛠️			•
Change all engine bearings. 🛠️			•

- One-time interval
- Periodic interval

11.1 Checking the basic suspension setting against the rider's weight

i Info
When adjusting the basic suspension setting, first adjust the shock absorber and then the fork.

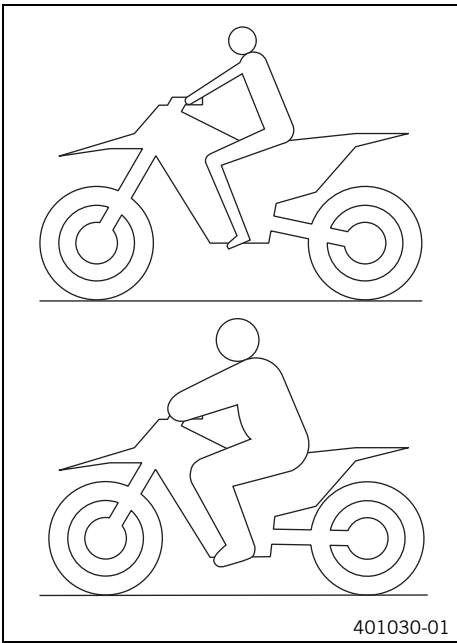

- For optimal motorcycle riding characteristics and to avoid damage to forks, shock absorbers, swingarm and frame, the basic settings of the suspension components must match the rider's weight.
- As delivered, KTM offroad motorcycles are adjusted for a standard rider weight (with full protective clothing).

Guideline

Standard rider weight	75... 85 kg (165... 187 lb.)
-----------------------	------------------------------

- If the rider's weight is above or below the standard range, the basic setting of the suspension components must be adjusted accordingly.
- Small weight differences can be compensated by adjusting the spring preload, but in the case of large weight differences, the springs must be replaced.

11.2 Compression damping of shock absorber

The compression damping of the shock absorber is divided into two ranges: high-speed and low-speed. High-speed and low-speed refer to the compression speed of the rear wheel suspension and not to the vehicle speed. The high-speed setting, for example, has an effect on the landing after a jump: the rear wheel suspension compresses more quickly. The low-speed setting, for example, has an effect when riding over long ground swells: the rear wheel suspension compresses more slowly. These two ranges can be adjusted separately, although the transition between high-speed and low-speed is gradual. Thus, changes in the high-speed range affect the compression damping in the low-speed range and vice versa.

11.3 Adjusting the low-speed compression damping of the shock absorber

⚠ Caution
Danger of accidents Disassembly of pressurized parts can lead to injury.

- The shock absorber is filled with high density nitrogen. Adhere to the description provided. (Your authorized KTM workshop will be glad to help.)

i Info
The low-speed setting can be seen during the slow to normal compression of the shock absorber.

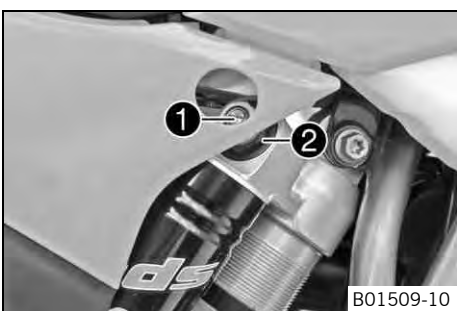

- Turn adjusting screw ❶ clockwise with a screwdriver up to the last perceptible click.

i Info
Do not loosen nut ❷!

- Turn back counterclockwise by the number of clicks corresponding to the shock absorber type.

Guideline

Compression damping, low-speed	
Comfort	25 clicks
Standard	20 clicks
Sport	15 clicks

i Info
Turn clockwise to increase damping; turn counterclockwise to reduce damping.

11.4 Adjusting the high-speed compression damping of the shock absorber

! Caution
Danger of accidents Disassembly of pressurized parts can lead to injury.

- The shock absorber is filled with high density nitrogen. Adhere to the description provided. (Your authorized KTM workshop will be glad to help.)

i Info
The high-speed setting can be seen during the fast compression of the shock absorber.

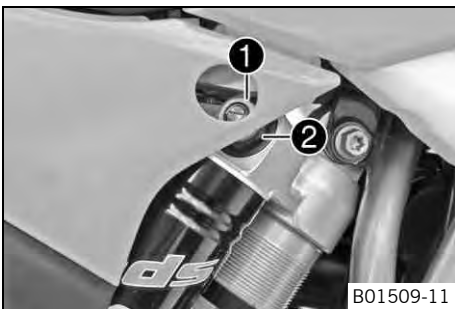

- Turn adjusting screw ❶ all the way clockwise with a socket wrench.

i Info
Do not loosen nut ❷!

- Turn back counterclockwise by the number of turns corresponding to the shock absorber type.

Guideline

Compression damping, high-speed	
Comfort	2 turns
Standard	1.5 turns
Sport	1.25 turns

i Info
Turn clockwise to increase damping; turn counterclockwise to reduce damping.

11.5 Adjusting the rebound damping of the shock absorber

! Caution
Danger of accidents Disassembly of pressurized parts can lead to injury.

- The shock absorber is filled with high density nitrogen. Adhere to the description provided. (Your authorized KTM workshop will be glad to help.)

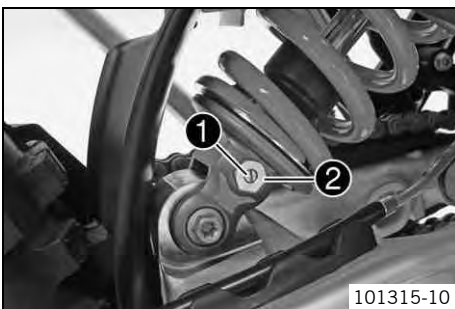

- Turn adjusting screw ❶ clockwise up to the last perceptible click.

i Info
Do not loosen nut ❷!

- Turn back counterclockwise by the number of clicks corresponding to the shock absorber type.

Guideline

Rebound damping	
Comfort	28 clicks
Standard	24 clicks
Sport	22 clicks

i Info
Turn clockwise to increase damping; turn counterclockwise to reduce damping.

11.6 Measuring rear wheel sag unloaded

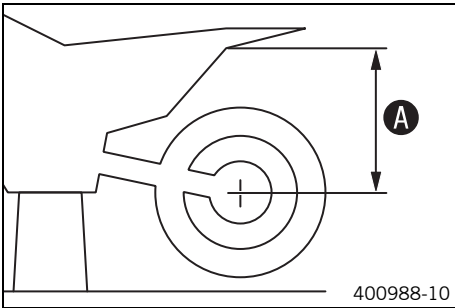

Preparatory work

- Raise the motorcycle with the lift stand. (☞ p. 56)

Main work

- Measure the distance – as vertically as possible – between the rear axle and a fixed point such as a mark on the side cover.
- Make note of the value as measurement **A**.

Finishing work

- Remove the motorcycle from the lift stand. (☞ p. 56)

11.7 Checking the static sag of the shock absorber

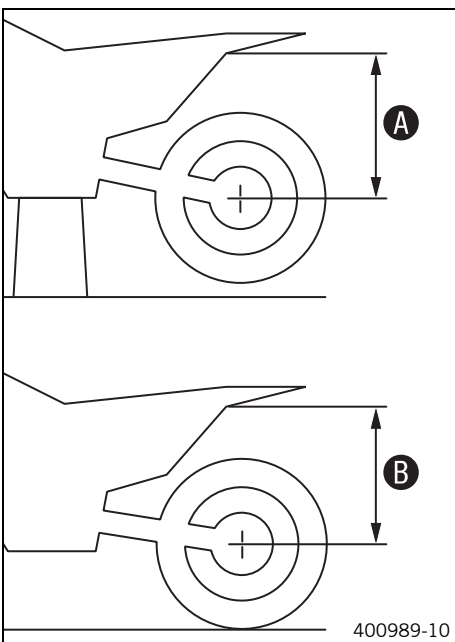

- Measure distance **A** of rear wheel unloaded. (☞ p. 50)
- Hold the motorcycle upright with the aid of an assistant.
- Measure the distance between the rear axle and the fixed point again.
- Note down the value as dimension **B**.

Info

The static sag is the difference between measurements **A** and **B**.

- Check the static sag.

Static sag	33... 35 mm (1.3... 1.38 in)
------------	------------------------------

- » If the static sag is less or more than the specified value:
 - Adjust the spring preload of the shock absorber. ☞ (☞ p. 51)

11.8 Checking the riding sag of the shock absorber

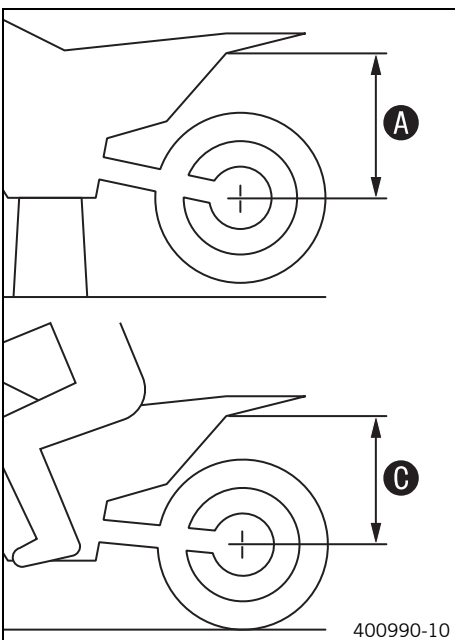

- Measure distance **A** of rear wheel unloaded. (☞ p. 50)
- With another person holding the motorcycle, the rider, wearing full protective clothing, sits on the seat in a normal sitting position (feet on footrests) and bounces up and down a few times.
 - ✓ The rear wheel suspension levels out.
- Another person now measures the distance between the rear axle and a fixed point.
- Note down the value as dimension **C**.

Info

The riding sag is the difference between measurements **A** and **C**.

- Check the riding sag.

Riding sag	105... 115 mm (4.13... 4.53 in)
------------	---------------------------------

- » If the riding sag differs from the specified measurement:
 - Adjust the riding sag. ☞ (☞ p. 51)

11.9 Adjusting the spring preload of the shock absorber 🛠️

Caution
Danger of accidents Disassembly of pressurized parts can lead to injury.

- The shock absorber is filled with high density nitrogen. Adhere to the description provided. (Your authorized KTM workshop will be glad to help.)

Info
 Before changing the spring preload, make a note of the present setting, e.g., by measuring the length of the spring.

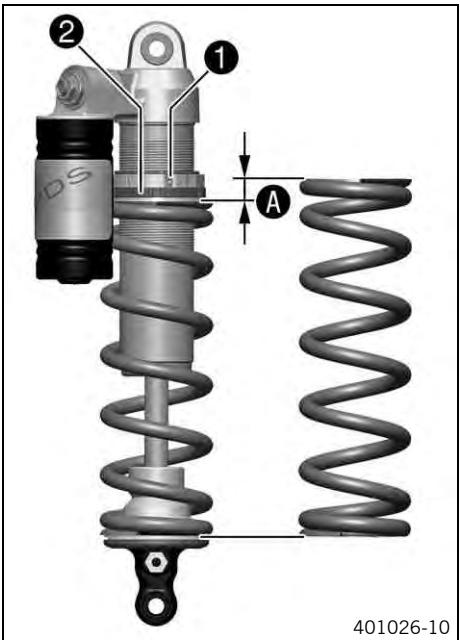

Preparatory work

- Raise the motorcycle with the lift stand. (🔧 p. 56)
- Remove shock absorber. 🛠️ (🔧 p. 67)
- After removing the shock absorber, clean it thoroughly.

Main work

- Loosen screw ❶.
- Turn adjusting ring ❷ until the spring is no longer under tension.

Hook wrench (T106S)

- Measure the overall spring length while the spring is not under tension.
- Tighten the spring by turning adjusting ring ❷ to measurement ❸.

Guideline

Spring preload	
Comfort	9 mm (0.35 in)
Standard	9 mm (0.35 in)
Sport	9 mm (0.35 in)



Info
 Depending on the static sag and/or the riding sag, it may be necessary to increase or decrease the spring preload.

- Tighten screw ❶.

Guideline

Screw, shock absorber adjusting ring	M5	5 Nm (3.7 lbf ft)
--------------------------------------	----	-------------------

Finishing work

- Install the shock absorber. 🛠️ (🔧 p. 67)
- Remove the motorcycle from the lift stand. (🔧 p. 56)

11.10 Adjusting the riding sag 🛠️

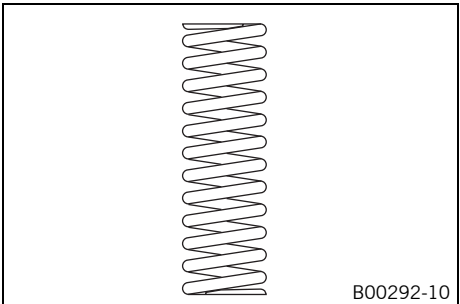

Preparatory work

- Raise the motorcycle with the lift stand. (🔧 p. 56)
- Remove shock absorber. 🛠️ (🔧 p. 67)
- After removing the shock absorber, clean it thoroughly.

Main work

- Choose and mount a suitable spring.

Guideline

Spring rate	
Weight of rider: 65... 75 kg (143... 165 lb.)	69 N/mm (394 lb/in)
Weight of rider: 75... 85 kg (165... 187 lb.)	72 N/mm (411 lb/in)
Weight of rider: 85... 95 kg (187... 209 lb.)	76 N/mm (434 lb/in)



Info

The spring rate is shown on the outside of the spring. Smaller weight differences can be compensated by changing the spring preload.

Finishing work

- Install the shock absorber. (🔧 p. 67)
- Remove the motorcycle from the lift stand. (🔧 p. 56)
- Check the static sag of the shock absorber. (🔧 p. 50)
- Check the riding sag of the shock absorber. (🔧 p. 50)
- Adjust the rebound damping of the shock absorber. (🔧 p. 49)

11.11 Checking basic setting of fork



Info

For various reasons, no exact riding sag can be determined for the forks.

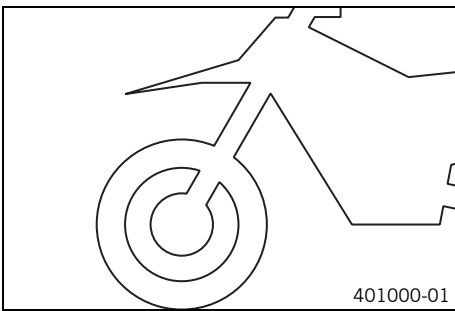

- As with the shock absorber, smaller differences in the rider's weight can be compensated by the spring preload.
- However, if the fork is often overloaded (hard end stop on compression), harder springs must be fit to avoid damage to the fork and frame.

11.12 Adjusting the compression damping of the fork



Info

The hydraulic compression damping determines the fork suspension behavior.

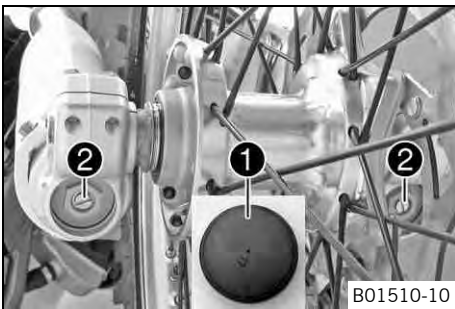

(EXC EU, EXC AUS, all XC-W models)

- Remove protection caps ❶.
- Turn adjusting screws ❷ clockwise all the way.



Info

Adjusting screws ❷ are located at the bottom end of the fork legs. Make the same adjustment on both fork legs.

- Turn back counterclockwise by the number of clicks corresponding to the fork type.

Guideline

Compression damping	
Comfort	22 clicks
Standard	20 clicks
Sport	18 clicks



Info

Turn clockwise to increase damping; turn counterclockwise to reduce damping.

- Mount protection covers ❶.

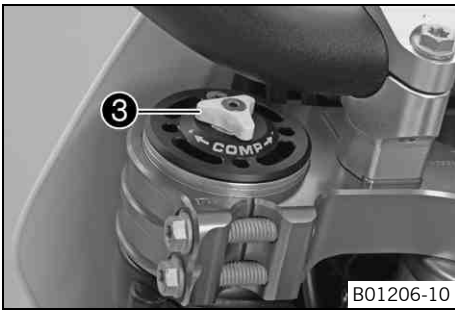

(EXC SIX DAYS)

- Turn the white adjusting screw ③ all the way clockwise.

i Info
Adjusting screw ③ is located at the upper end of the left fork leg. The compression damping is located in the left fork leg **COMP** (white adjusting screw). The rebound damping is located in the right fork leg **REB** (red adjusting screw).

- Turn back counterclockwise by the number of clicks corresponding to the fork type.

Guideline

Compression damping	
Comfort	15 clicks
Standard	13 clicks
Sport	11 clicks

i Info
Turn clockwise to increase damping; turn counterclockwise to reduce damping.

11.13 Adjusting the rebound damping of the fork

i Info
The hydraulic rebound damping determines the fork suspension behavior.

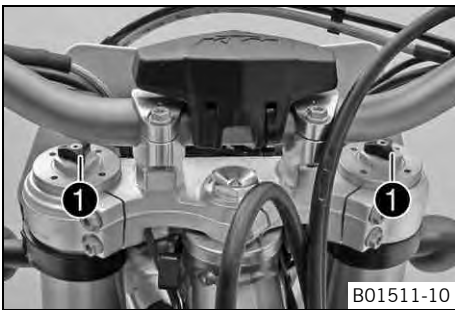

(EXC EU, EXC AUS, all XC-W models)

- Turn adjusting screws ① clockwise all the way.

i Info
Adjusting screws ① are located at the top end of the fork legs. Make the same adjustment on both fork legs.

- Turn back counterclockwise by the number of clicks corresponding to the fork type.

Guideline

Rebound damping	
Comfort	20 clicks
Standard	18 clicks
Sport	16 clicks

i Info
Turn clockwise to increase damping; turn counterclockwise to reduce damping.



(EXC SIX DAYS)

- Turn the red adjusting screw ② all the way clockwise.

i Info
Adjusting screw ② is located at the upper end of the right fork leg. The rebound damping is located in the right fork leg **REB** (red adjusting screw). The compression damping is located in the left fork leg **COMP** (white adjusting screw).

- Turn back counterclockwise by the number of clicks corresponding to the fork type.

Guideline

Rebound damping	
Comfort	15 clicks
Standard	13 clicks
Sport	11 clicks

i Info
Turn clockwise to increase damping; turn counterclockwise to reduce damping.

11.14 Adjusting the spring preload of the fork (EXC EU, EXC AUS, all XC-W models)

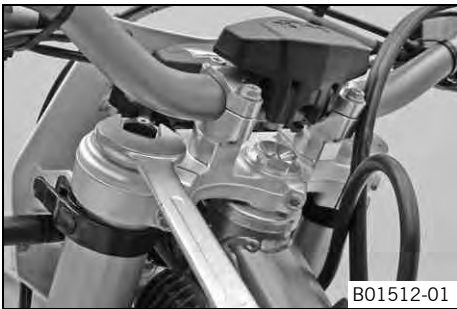

- Turn the adjusting screws counterclockwise all the way.

i Info
Make the same adjustment on both fork legs.

- Turn back clockwise by the number of turns corresponding to the fork type.

Guideline

Spring preload - Preload Adjuster	
Comfort	1 turn
Standard	2 turns
Sport	2 turns

i Info
Turn clockwise to increase spring preload; turn counterclockwise to reduce spring preload.
Adjusting the spring preload has no influence on the absorption setting of the rebound damping.
Basically, however, you should set the rebound damping higher with a higher spring preload.

11.15 Handlebar position

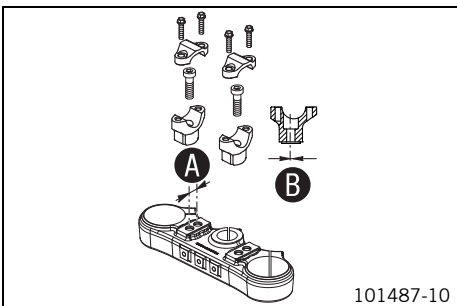

On the upper triple clamp, there are two holes at a distance of **A** to each other.

Hole distance A	15 mm (0.59 in)
------------------------	-----------------

The holes on the handlebar supports are placed at a distance of **B** from the center.

Hole distance B	3.5 mm (0.138 in)
------------------------	-------------------

The handlebar supports can be mounted in four different positions.

11.16 Adjusting handlebar position

Warning
Danger of accidents Handlebar breakage.

- If the handlebar is bent or straightened it will cause material fatigue, and the handlebar can break. Always replace handlebar.

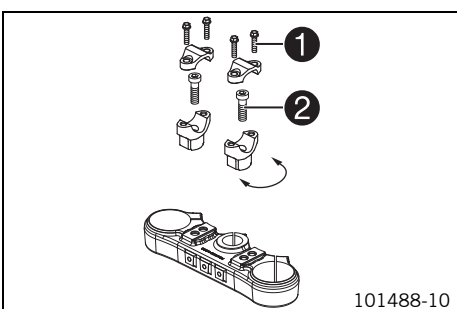

- Remove the four screws **1**. Remove the handlebar clamps. Remove the handlebar and lay it to one side.

i Info
Protect the motorcycle and its attachments from damage by covering them. Do not bend the cables and lines.

- Remove the two screws **2**. Remove the handlebar supports.
- Place the handlebar supports in the required position. Fit and tighten the two screws **2**.

Guideline

Screw, handlebar holder	M10	40 Nm (29.5 lbf ft)	Loctite® 243™
-------------------------	-----	------------------------	---------------

i Info
Position the left and right handlebar supports evenly.

- Position the handlebar.

**Info**

Make sure cables and wiring are positioned correctly.

- Position the handlebar clamps. Fit and evenly tighten the four screws ❶.

Guideline

Screw, handlebar clamp	M8	20 Nm (14.8 lbf ft)
------------------------	----	------------------------

**Info**

Make sure the gap width is even.

12.1 Raising the motorcycle with the lift stand



Note

Danger of damage The parked vehicle may roll away or fall over.

- Always place the vehicle on a firm and even surface.
- Raise the motorcycle at the frame underneath the engine.

Lift stand (54829055000)

- ✓ The wheels should no longer touch the ground.
- Secure the motorcycle against falling over.

12.2 Removing the motorcycle from the lift stand

Note

Danger of damage The parked vehicle may roll away or fall over.

- Always place the vehicle on a firm and even surface.

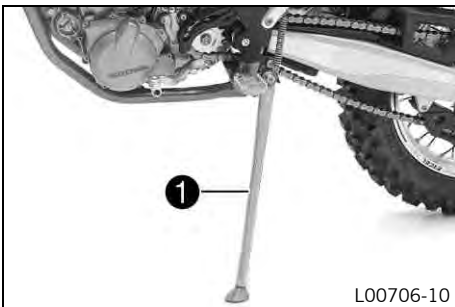

- Remove the motorcycle from the lift stand.
- Remove the lift stand.
- To park the motorcycle, press the side stand ❶ to the ground with your foot and lean the motorcycle on it.

i Info

When you are riding, the side stand must be folded up and secured with the rubber band.

12.3 Bleeding fork legs



Preparatory work

- Raise the motorcycle with the lift stand. (☛ p. 56)

Main work

- Release bleeder screws ❶.
- ✓ Any excess pressure escapes from the interior of the fork.
- Mount and tighten bleeder screws.

Finishing work

- Remove the motorcycle from the lift stand. (☛ p. 56)

12.4 Cleaning the dust boots of the fork legs

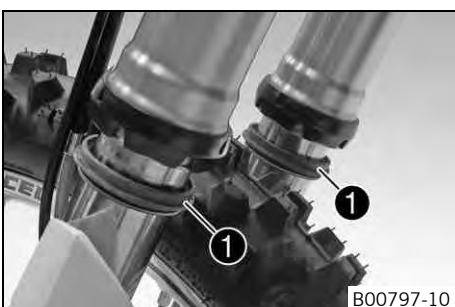

Preparatory work

- Raise the motorcycle with the lift stand. (☛ p. 56)
- Loosen the fork protector. (☛ p. 57)

Main work

- Push dust boot ❶ down on both fork leg.

i Info

The dust boots remove dust and coarse dirt particles from the inside fork tubes. Over time, dirt can penetrate behind the dust boots. If this dirt is not removed, the oil seals behind can start to leak.



Warning

Danger of accidents Reduced braking efficiency due to oil or grease on the brake discs.

- Always keep the brake discs free of oil and grease, and clean them with brake cleaner when necessary.

- Clean and lubricate the dust boot and inside fork tube on both fork legs.

Universal oil spray (☛ p. 129)

- Press the dust boots back into the installation position.
- Remove excess oil.

Finishing work

- Position the fork protector. (☛ p. 57)
- Remove the motorcycle from the lift stand. (☛ p. 56)

12.5 Loosening the fork protector

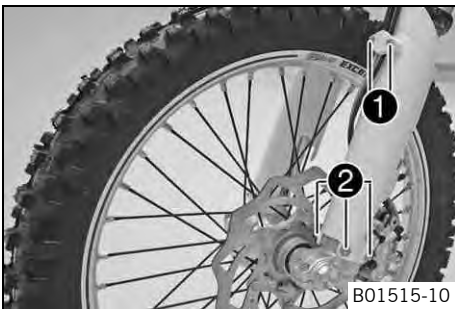

- Remove screws ❶ and remove the clamp.
- Remove screws ❷ on the left fork leg. Push the fork protector downwards.
- Remove the screws on the right fork leg. Push the fork protector downwards.

12.6 Positioning the fork protector

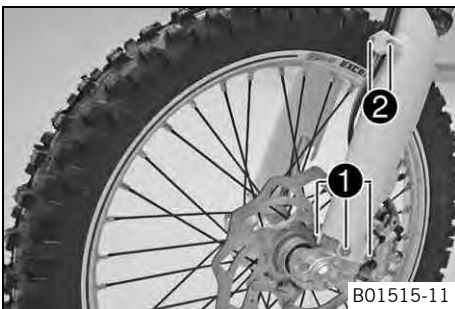

- Position the fork protector on the left fork leg. Mount and tighten screws ❶. Guideline

Remaining screws, chassis	M6	10 Nm (7.4 lbf ft)
---------------------------	----	--------------------

- Position the wiring harness.
- Position the brake line. Put the clamp on, and mount and tighten screws ❷.
- Position the fork protector on the right fork leg. Mount and tighten the screws. Guideline

Remaining screws, chassis	M6	10 Nm (7.4 lbf ft)
---------------------------	----	--------------------

12.7 Removing the fork legs ☞

Preparatory work

- Remove the headlight mask with the headlight. (☛ p. 98)
- Raise the motorcycle with the lift stand. (☛ p. 56)
- Remove the front wheel. ☞ (☛ p. 90)

Main work

- Remove screws ❶ and take off the clamp.
- Remove cable binder ❷.
- Remove screws ❸ and take off the brake caliper.
- Allow the brake caliper and brake line to hang tension-free to the side.

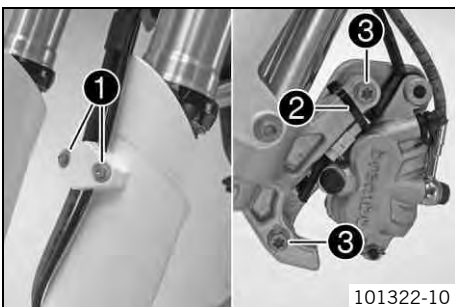

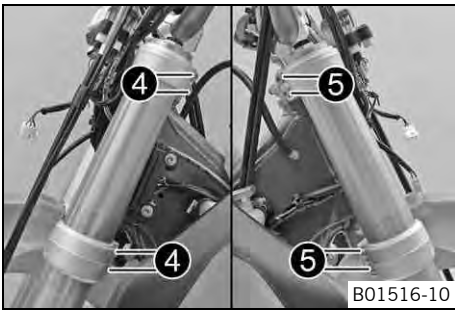

(EXC EU, EXC AUS, all XC-W models)

- Release screws 4. Take out the left fork leg.
- Release screws 5. Take out the right fork leg.

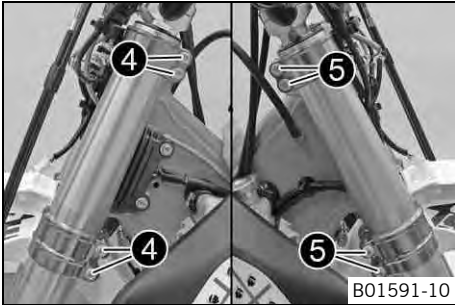

(EXC SIX DAYS)

- Release screws 4. Take out the left fork leg.
- Release screws 5. Take out the right fork leg.

12.8 Installing the fork legs



Main work

(EXC EU, EXC AUS, all XC-W models)

- Position the fork legs.
- ✓ Position bleeder screws 1 toward the front.



Info

Grooves are milled into the side of the upper end of the fork legs. The second milled groove (from the top) must be flush with the top edge of the upper triple clamp.

- Tighten screws 2.

Guideline

Screw, top triple clamp	M8	20 Nm (14.8 lbf ft)
-------------------------	----	------------------------

- Tighten screws 3.

Guideline

Screw, bottom triple clamp	M8	15 Nm (11.1 lbf ft)
----------------------------	----	------------------------

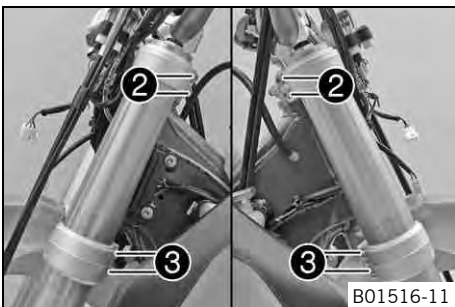

(EXC SIX DAYS)

- Position the fork legs.
- ✓ Position bleeder screws 1 toward the front.



Info

The rebound damping is located in the right fork leg **REB** (red adjusting screw). The compression damping is located in the left fork leg **COMP** (white adjusting screw).

Grooves are milled into the side of the upper end of the fork legs. The second milled groove (from the top) must be flush with the top edge of the upper triple clamp.

- Tighten screws 2.

Guideline

Screw, top triple clamp	M8	17 Nm (12.5 lbf ft)
-------------------------	----	------------------------

- Tighten screws 3.

Guideline

Screw, bottom triple clamp	M8	15 Nm (11.1 lbf ft)
----------------------------	----	------------------------

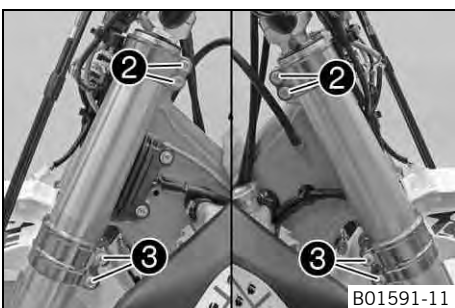

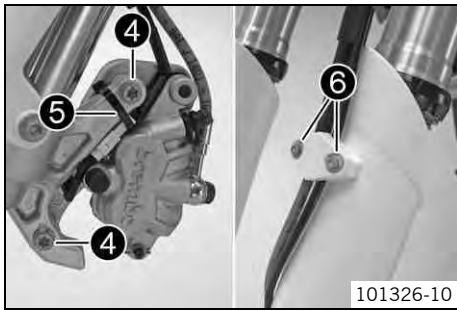

- Position the brake caliper and mount and tighten screws ④.

Guideline

Screw, front brake caliper	M8	25 Nm (18.4 lbf ft)	Loctite® 243™
----------------------------	----	------------------------	---------------

- Mount cable binder ⑤.
- Position the brake line, wiring harness, and clamp. Mount and tighten screws ⑥.

Finishing work

- Install the front wheel. (☞ p. 90)
- Refit the headlight mask with the headlight. (☞ p. 99)
- Check the headlight setting. (☞ p. 100)

12.9 Removing the fork protector ☞

Preparatory work

- Remove the headlight mask with the headlight. (☞ p. 98)
- Raise the motorcycle with the lift stand. (☞ p. 56)
- Remove the front wheel. (☞ p. 90)
- Remove the fork legs. (☞ p. 57)

Main work

- Remove screws ① on the left fork leg. Remove the fork protector upwards.
- Remove the screws on the right fork leg. Remove the fork protector upwards.

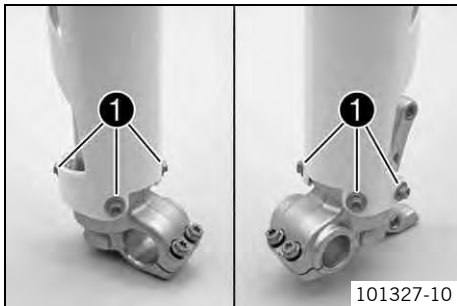

12.10 Installing the fork protector ☞

Main work

- Position the fork protector on the left fork leg. Mount and tighten screws ①.

Guideline

Remaining screws, chassis	M6	10 Nm (7.4 lbf ft)
---------------------------	----	--------------------

- Position the fork protector on the right fork leg. Mount and tighten the screws.

Guideline

Remaining screws, chassis	M6	10 Nm (7.4 lbf ft)
---------------------------	----	--------------------

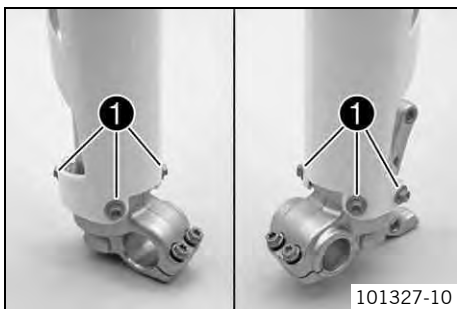

Finishing work

- Install the fork legs. (☞ p. 58)
- Install the front wheel. (☞ p. 90)
- Refit the headlight mask with the headlight. (☞ p. 99)
- Check the headlight setting. (☞ p. 100)

12.11 Removing the lower triple clamp ☞ (EXC EU, EXC AUS, all XC-W models)

Preparatory work

- Remove the headlight mask with the headlight. (☞ p. 98)
- Raise the motorcycle with the lift stand. (☞ p. 56)
- Remove the front wheel. (☞ p. 90)
- Remove the fork legs. (☞ p. 57)
- Remove the front fender. (☞ p. 66)
- Remove the handlebar cushion.

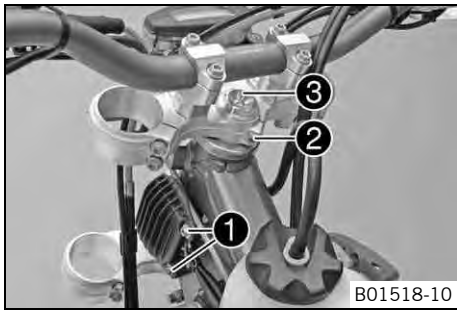

B01518-10

Main work

- Open the cable holder in front of the right radiator and detach the wiring harness.
- Remove screws ① and hang the voltage regulator to one side.
- Release screw ② and remove screw ③. Take off the upper triple clamp with the handlebar and set it aside.



Info

Protect the motorcycle and its attachments against damage by covering them.
Do not bend the cables and lines.

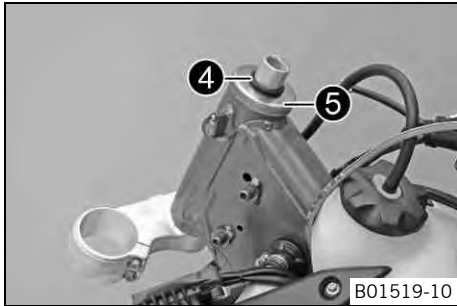

B01519-10

- Remove O-ring ④. Remove protective ring ⑤.
- Take out the lower triple clamp with the steering stem.
- Take out the upper steering head bearing.

12.12 Removing the lower triple clamp 🛠️ (EXC SIX DAYS)

Preparatory work

- Remove the headlight mask with the headlight. (🔧 p. 98)
- Raise the motorcycle with the lift stand. (🔧 p. 56)
- Remove the front wheel. 🛠️ (🔧 p. 90)
- Remove the fork legs. 🛠️ (🔧 p. 57)
- Remove the front fender. (🔧 p. 66)
- Remove the handlebar cushion.

Main work

- Open the cable holder in front of the right radiator and detach the wiring harness.
- Remove screws ① and hang the voltage regulator to the side.
- Remove screw ②. Remove screw ③, take off the upper triple clamp with the handlebar and set it aside.



Info

Protect the motorcycle and its attachments against damage by covering them.
Do not bend the cables and lines.

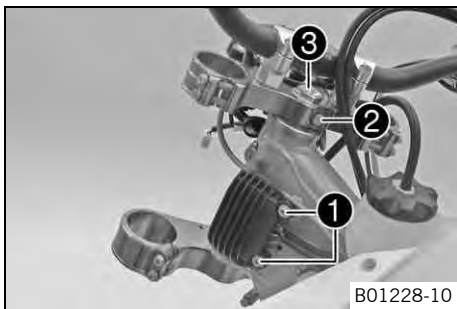

B01228-10

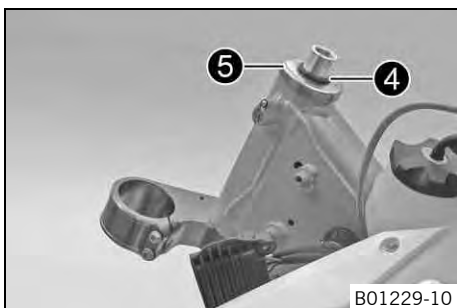

B01229-10

- Remove O-ring ④. Remove protective ring ⑤.
- Take out the lower triple clamp with the steering stem.
- Take out the upper steering head bearing.

12.13 Installing the lower triple clamp (EXC EU, EXC AUS, all XC-W models)

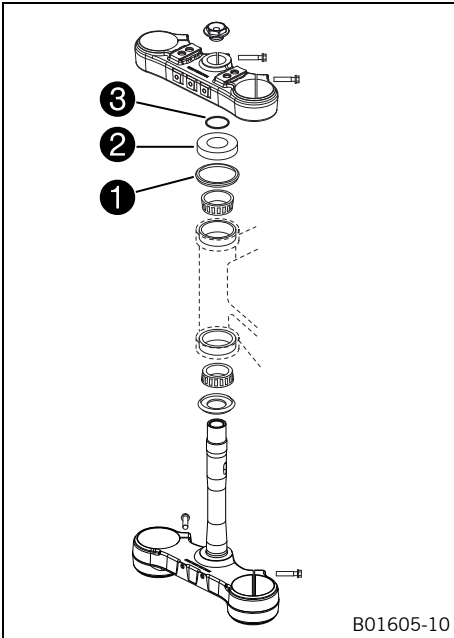

Main work

- Clean the bearing and sealing elements, check for damage, and grease.

High viscosity grease (☛ p. 128)

- Insert the lower triple clamp with the steering stem. Mount the upper steering head bearing.
- Check whether the upper steering head seal ❶ is correctly positioned.
- Slide on protective ring ❷ and O-ring ❸.

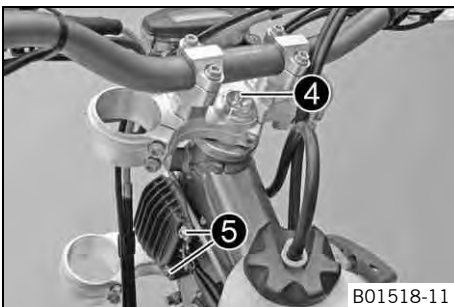

- Position the upper triple clamp with the handlebar.
- Mount screw ❷ but do not tighten yet.
- Position the clutch line, wiring harness, and voltage regulator. Mount and tighten screws ❸.

Guideline

Remaining screws, chassis	M6	10 Nm (7.4 lbf ft)
---------------------------	----	--------------------

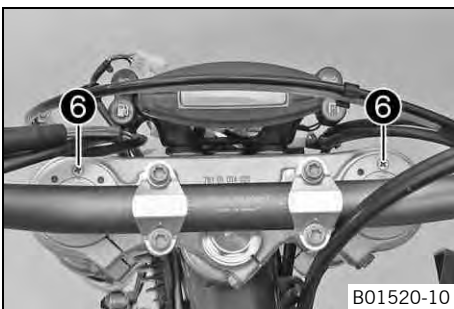

- Position the fork legs.
- ✓ Position bleeder screws ❹ toward the front.

Info

Grooves are milled into the side of the upper end of the fork legs. The second milled groove (from the top) must be flush with the top edge of the upper triple clamp.

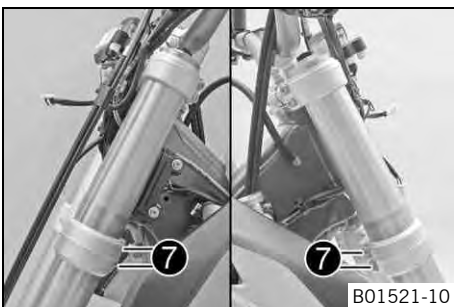

- Tighten screws ❺.

Guideline

Screw, bottom triple clamp	M8	15 Nm (11.1 lbf ft)
----------------------------	----	------------------------



- Tighten screw ❻.

Guideline

Screw, top steering head	M20x1.5	12 Nm (8.9 lbf ft)
--------------------------	---------	--------------------

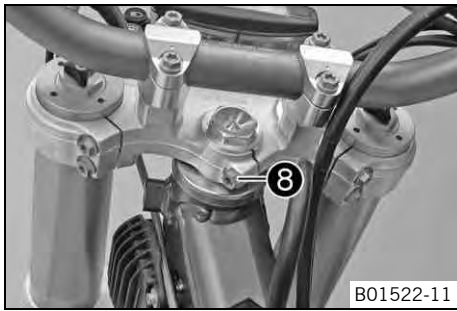

- Tighten screw 8.

Guideline

Screw, top steering stem	M8	20 Nm (14.8 lbf ft)
--------------------------	----	------------------------

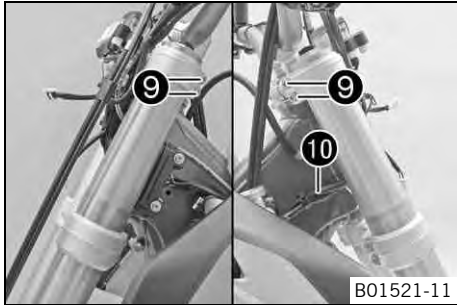

- Tighten screws 9.

Guideline

Screw, top triple clamp	M8	20 Nm (14.8 lbf ft)
-------------------------	----	------------------------

- Secure the wiring harness with cable holder 10.

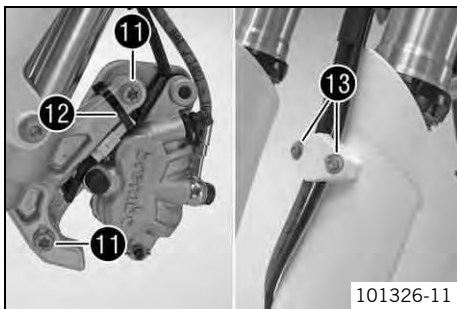

- Position the brake caliper. Mount and tighten screws 11.

Guideline

Screw, front brake caliper	M8	25 Nm (18.4 lbf ft)	Loctite® 243™
----------------------------	----	------------------------	---------------

- Mount cable binder 12.
- Position the brake line, wiring harness, and clamp. Mount and tighten screws 13.

Finishing work

- Mount the handlebar cushion.
- Install the front fender. (☛ p. 66)
- Install the front wheel. 🛞 (☛ p. 90)
- Refit the headlight mask with the headlight. (☛ p. 99)
- Check that the wiring harness, throttle cables and brake and clutch lines can move freely and are routed correctly.
- Check the steering head bearing play. (☛ p. 64)
- Remove the motorcycle from the lift stand. (☛ p. 56)
- Check the headlight setting. (☛ p. 100)

12.14 Installing the lower triple clamp (EXC SIX DAYS)

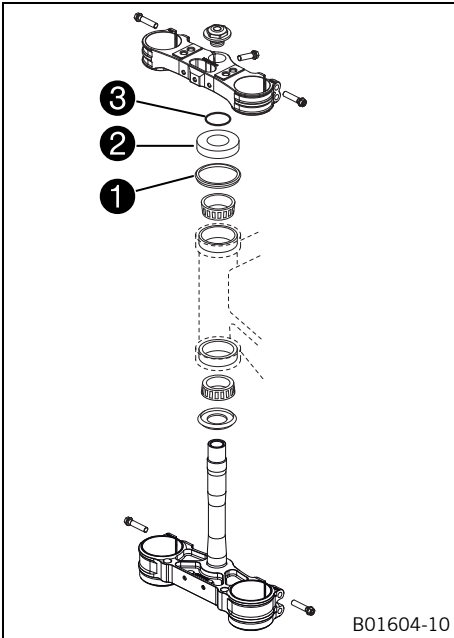

Main work

- Clean the bearing and sealing elements, check for damage, and grease.

High viscosity grease (☛ p. 128)

- Insert the lower triple clamp with the steering stem. Mount the upper steering head bearing.
- Check whether the upper steering head seal ❶ is correctly positioned.
- Slide on protective ring ❷ and O-ring ❸.

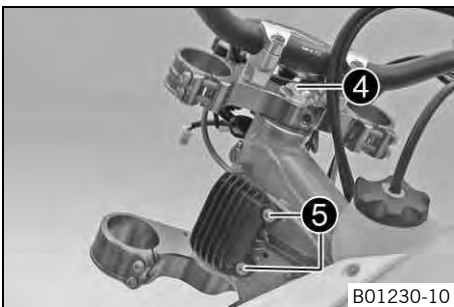

- Position the upper triple clamp with the handlebar.
- Mount screw ❹ but do not tighten yet.
- Position the clutch line, wiring harness, and voltage regulator. Mount and tighten screws ❺.

Guideline

Remaining screws, chassis	M6	10 Nm (7.4 lbf ft)
---------------------------	----	--------------------



- Position the fork legs.
- ✓ Position bleeder screws ❻ toward the front.

Info

The rebound damping is located in the right fork leg **REB** (red adjusting screw). The compression damping is located in the left fork leg **COMP** (white adjusting screw). Grooves are milled into the side of the upper end of the fork legs. The second milled groove (from the top) must be flush with the top edge of the upper triple clamp.

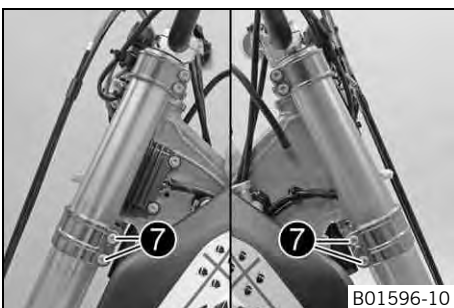

- Tighten screws ❷.

Guideline

Screw, bottom triple clamp	M8	15 Nm (11.1 lbf ft)
----------------------------	----	---------------------

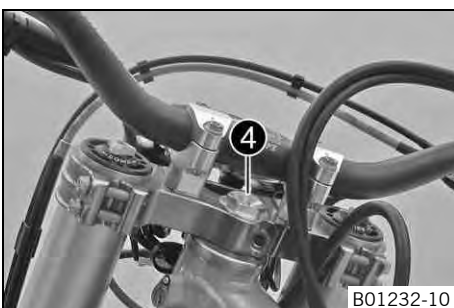

- Tighten screw ❹.

Guideline

Screw, top steering head	M20x1.5	12 Nm (8.9 lbf ft)
--------------------------	---------	--------------------

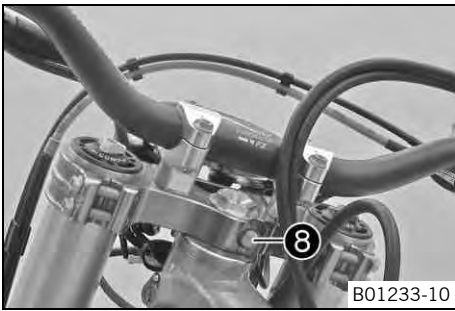

- Mount and tighten screw 8.

Guideline

Screw, top steering stem	M8	17 Nm (12.5 lbf ft)	Loctite® 243™
--------------------------	----	------------------------	---------------

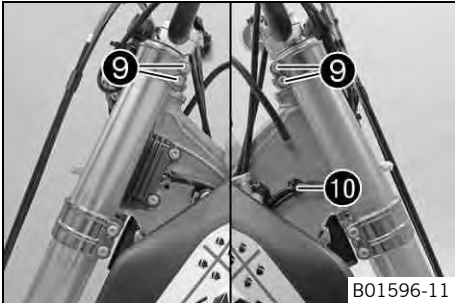

- Tighten screws 9.

Guideline

Screw, top triple clamp	M8	17 Nm (12.5 lbf ft)	
-------------------------	----	------------------------	--

- Secure the wiring harness with cable holder 10.

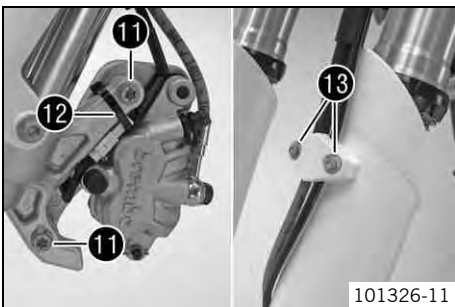

- Position the brake caliper. Mount and tighten screws 11.

Guideline

Screw, front brake caliper	M8	25 Nm (18.4 lbf ft)	Loctite® 243™
----------------------------	----	------------------------	---------------

- Mount cable binder 12.
- Position the brake line, wiring harness, and clamp. Mount and tighten screws 13.

Finishing work

- Mount the handlebar cushion.
- Install the front fender. (☛ p. 66)
- Install the front wheel. ☛ (☛ p. 90)
- Refit the headlight mask with the headlight. (☛ p. 99)
- Check that the wiring harness, throttle cables and brake and clutch lines can move freely and are routed correctly.
- Check the steering head bearing play. (☛ p. 64)
- Remove the motorcycle from the lift stand. (☛ p. 56)
- Check the headlight setting. (☛ p. 100)

12.15 Checking the steering head bearing play

Warning
Danger of accidents Unstable vehicle handling from incorrect steering head bearing play.

- Adjust the steering head bearing play without delay. (Your authorized KTM workshop will be glad to help.)

Info
 If the bike is ridden with play in the steering head bearing, the bearing and the bearing seats in the frame can become damaged over time.

Preparatory work

- Raise the motorcycle with the lift stand. (☛ p. 56)

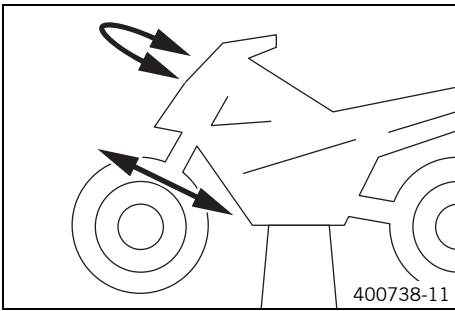

Main work

- Move the handlebar to the straight-ahead position. Move the fork legs to and fro in the direction of travel.

No play should be noticeable in the steering head bearing.

- » If there is noticeable play present:

(EXC SIX DAYS)

- Adjust the play of the steering head bearing. (🔧 p. 65)

(EXC EU, EXC AUS, all XC-W models)

- Adjust the play of the steering head bearing. (🔧 p. 65)

- Move the handlebar to and fro over the entire steering range.

The handlebar must be able to move easily over the entire steering range. No resting locations should be noticeable.

- » If click positions are noticeable:

(EXC SIX DAYS)

- Adjust the play of the steering head bearing. (🔧 p. 65)

(EXC EU, EXC AUS, all XC-W models)

- Adjust the play of the steering head bearing. (🔧 p. 65)

- Check the steering head bearing and replace if required.

Finishing work

- Remove the motorcycle from the lift stand. (🔧 p. 56)

12.16 Adjusting the play of the steering head bearing (🔧 (EXC EU, EXC AUS, all XC-W models)

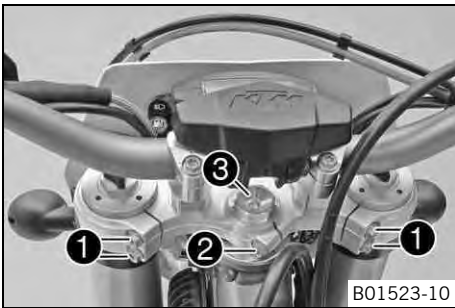

Preparatory work

- Raise the motorcycle with the lift stand. (🔧 p. 56)

Main work

- Loosen screws ① and ②.
- Loosen and retighten screw ③.

Guideline

Screw, top steering head	M20x1.5	12 Nm (8.9 lbf ft)
--------------------------	---------	--------------------

- Using a plastic hammer, tap lightly on the upper triple clamp to avoid strains.
- Tighten screws ①.

Guideline

Screw, top triple clamp	M8	20 Nm (14.8 lbf ft)
-------------------------	----	---------------------

- Tighten screw ②.

Guideline

Screw, top steering stem	M8	20 Nm (14.8 lbf ft)
--------------------------	----	---------------------

Finishing work

- Check the steering head bearing play. (🔧 p. 64)
- Remove the motorcycle from the lift stand. (🔧 p. 56)

12.17 Adjusting the play of the steering head bearing (🔧 (EXC SIX DAYS)

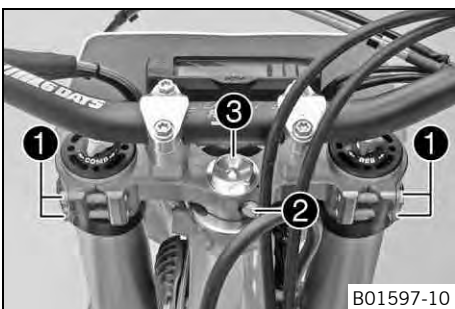

Preparatory work

- Raise the motorcycle with the lift stand. (🔧 p. 56)

Main work

- Loosen screws ①. Remove screw ②.
- Loosen and retighten screw ③.

Guideline

Screw, top steering head	M20x1.5	12 Nm (8.9 lbf ft)
--------------------------	---------	--------------------

- Using a plastic hammer, tap lightly on the upper triple clamp to avoid strains.
- Fully tighten screws ①.

Guideline

Screw, top triple clamp	M8	17 Nm (12.5 lbf ft)
-------------------------	----	---------------------

- Mount and tighten screw ②.

Guideline

Screw, top steering stem	M8	17 Nm (12.5 lbf ft)	Loctite® 243™
--------------------------	----	------------------------	---------------

Finishing work

- Check the steering head bearing play. (☞ p. 64)
- Remove the motorcycle from the lift stand. (☞ p. 56)

12.18 Greasing the steering head bearing

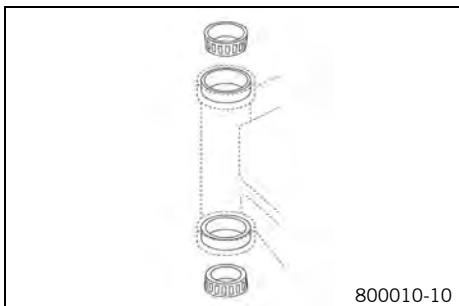

(EXC SIX DAYS)

- Remove the lower triple clamp. (☞ p. 60)
- Install the lower triple clamp. (☞ p. 63)

(EXC EU, EXC AUS, all XC-W models)

- Remove the lower triple clamp. (☞ p. 59)
- Install the lower triple clamp. (☞ p. 61)

12.19 Removing the front fender

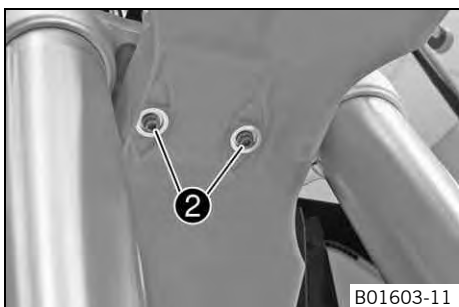
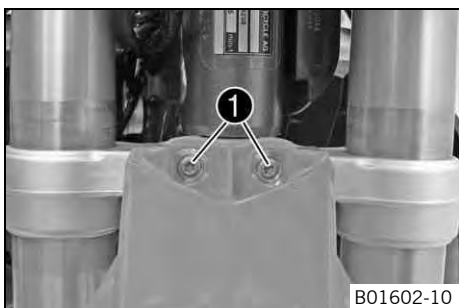

Preparatory work

- Remove the headlight mask with the headlight. (☞ p. 98)

Main work

- Remove screws ①.

- Remove screws ②. Remove the front fender.

12.20 Installing the front fender

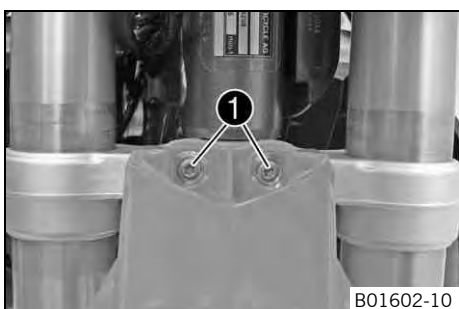

Main work

- Position the front fender. Mount and tighten screws ①.

Guideline

Remaining screws, chassis	M6	10 Nm (7.4 lbf ft)
---------------------------	----	--------------------

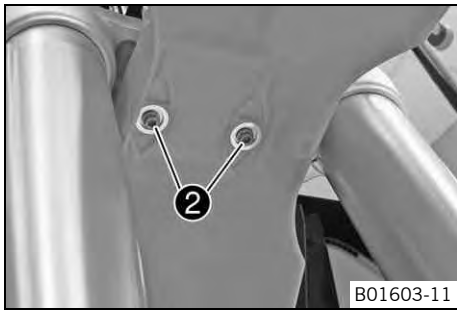

B01603-11

- Mount and tighten screws 2.

Guideline

Remaining screws, chassis	M6	10 Nm (7.4 lbf ft)
---------------------------	----	--------------------

Finishing work

- Refit the headlight mask with the headlight. (☛ p. 99)
- Check the headlight setting. (☛ p. 100)

12.21 Removing the shock absorber ☛

Preparatory work

- Raise the motorcycle with the lift stand. (☛ p. 56)

Main work

- Remove screw 1 and lower the rear wheel with the swing arm as far as possible without blocking the rear wheel. Fix the rear wheel in this position.
- Remove screw 2, push splash protector 3 to the side, and remove the shock absorber.

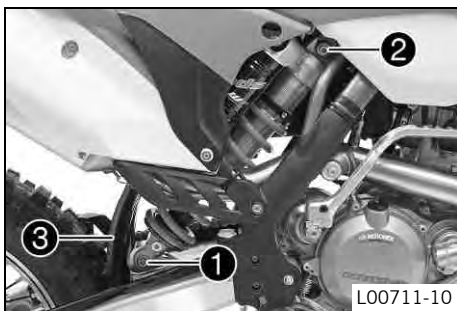

L00711-10

12.22 Installing the shock absorber ☛

Main work

- Push splash protector 1 to the side and position the shock absorber. Mount and tighten screw 2.

Guideline

Screw, top shock absorber	M12	80 Nm (59 lbf ft)	Loctite® 2701™
---------------------------	-----	-------------------	----------------

- Mount and tighten screw 3.

Guideline

Screw, bottom shock absorber	M12	80 Nm (59 lbf ft)	Loctite® 2701™
------------------------------	-----	-------------------	----------------

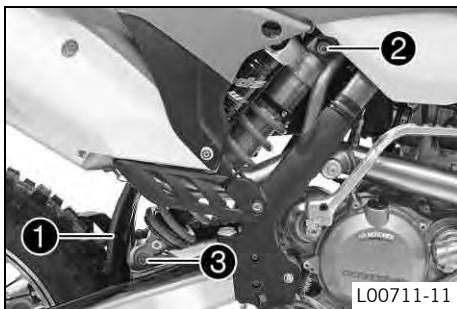

L00711-11

i Info

The heim joint for the shock absorber at the swing arm is Teflon coated. It must not be greased with grease or with other lubricants. Lubricants dissolve the Teflon coating, thereby drastically reducing the service life.

Finishing work

- Remove the motorcycle from the lift stand. (☛ p. 56)

12.23 Removing the seat

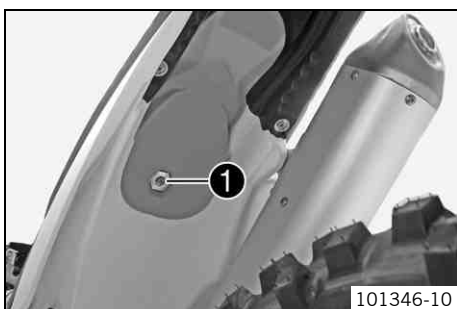

101346-10

- Remove screw 1.
- Lift up the seat at the rear, pull it back and then remove it from above.

12.24 Mounting the seat



- Hook in the front of the seat at the collar sleeve of the fuel tank, lower it at the rear and simultaneously push it forward.
- Make sure that the seat is correctly locked in.
- Mount and tighten the screw of the seat fixing.

Guideline

Remaining screws, chassis	M6	10 Nm (7.4 lbf ft)
---------------------------	----	--------------------

12.25 Removing the air filter box lid

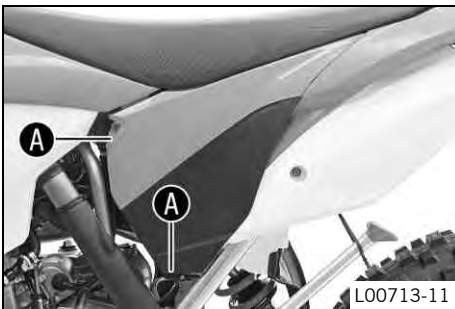

- Pull off the air filter box lid in area **A** to the side and remove to the front.

12.26 Installing the air filter box lid

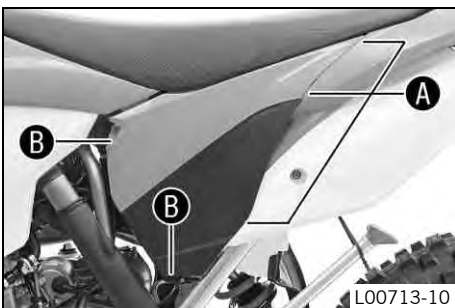

- Insert the air filter box lid into the rear area **A** and clip it into the front area **B**.

12.27 Removing the air filter

Note

Engine failure Unfiltered intake air has a negative effect on the service life of the engine.

- Never ride the vehicle without an air filter since dust and dirt can get into the engine and result in increased wear.



Warning

Environmental hazard Hazardous substances cause environmental damage.

- Oil, grease, filters, fuel, cleaners, brake fluid, etc., should be disposed of as stipulated in applicable regulations.

Preparatory work

- Remove the air filter box lid. (☞ p. 68)

Main work

- Detach air filter holder **1** at the bottom and swing it to one side. Remove the air filter with the air filter support.
- Remove the air filter from the air filter support.



12.28 Installing the air filter

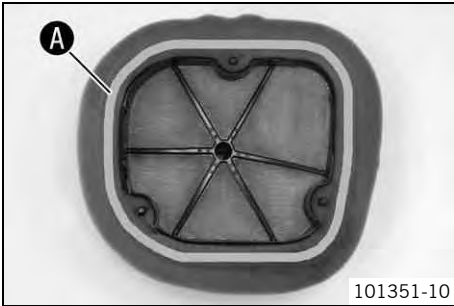

101351-10

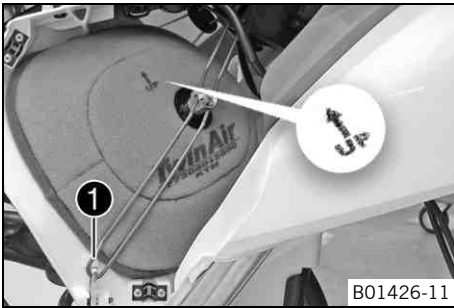

B01426-11

Main work

- Mount the clean air filter on the air filter support.
- Grease the air filter in area **A**.

Long-life grease (☛ p. 128)

- Insert both parts together, position them and fasten them using air filter holder **1**.
- ✓ The arrow of marking **UP** faces up.



Info

If the air filter is not correctly mounted, dust and dirt can enter the engine and cause damage.

Finishing work

- Install the air filter box lid. (☛ p. 68)

12.29 Cleaning the air filter and air filter box



Warning

Environmental hazard Hazardous substances cause environmental damage.

- Oil, grease, filters, fuel, cleaners, brake fluid, etc., should be disposed of as stipulated in applicable regulations.



Info

Do not clean the air filter with fuel or petroleum since these substances attack the foam.

Preparatory work

- Remove the air filter box lid. (☛ p. 68)
- Remove the air filter. ☛ (☛ p. 68)

Main work

- Wash the air filter thoroughly in special cleaning liquid and allow it to dry properly.

Air filter cleaner (☛ p. 128)



Info

Only press the air filter to dry it, never wring it out.

- Oil the dry air filter with a high quality filter oil.

Oil for foam air filter (☛ p. 129)

- Clean the air filter box.
- Check the intake flange for damage and firm seating.

Finishing work

- Install the air filter. ☛ (☛ p. 69)
- Install the air filter box lid. (☛ p. 68)



S00044-10

12.30 Sealing the air filter box

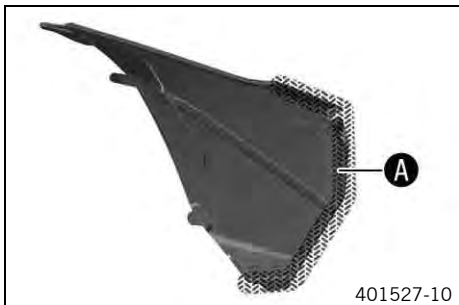

- Seal the air filter box in the marked area **A**.

12.31 Removing main silencer



Warning

Danger of burns The exhaust system gets very hot when the vehicle is driven.

- Allow the exhaust system to cool down. Do not touch hot components.

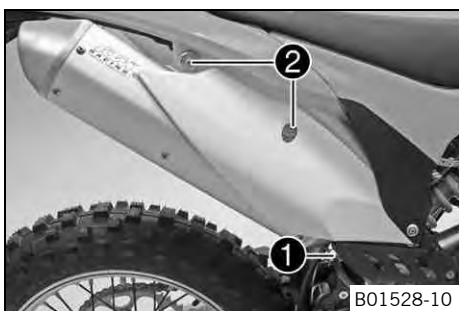

- Disconnect spring **1**.
- Remove screws **2** and take off main silencer.

12.32 Installing the main silencer

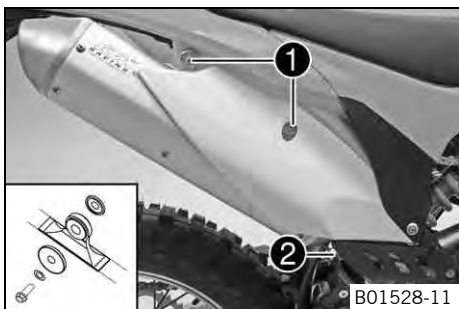

- Mount the main silencer. Mount screws **1** but do not tighten yet.
- Reconnect spring **2**.
- Tighten screws **1**.

Guideline

Remaining screws, chassis	M6	10 Nm (7.4 lbf ft)
---------------------------	----	--------------------

12.33 Changing the glass fiber yarn filling of the main silencer



Warning

Danger of burns The exhaust system gets very hot when the vehicle is driven.

- Allow the exhaust system to cool down. Do not touch hot components.



Info

Over time, the fibers of the glass fiber yarn escape and the damper "burns" out. Not only is the noise level higher, the performance characteristic changes.

Preparatory work

- Remove the main silencer. (☛ p. 70)

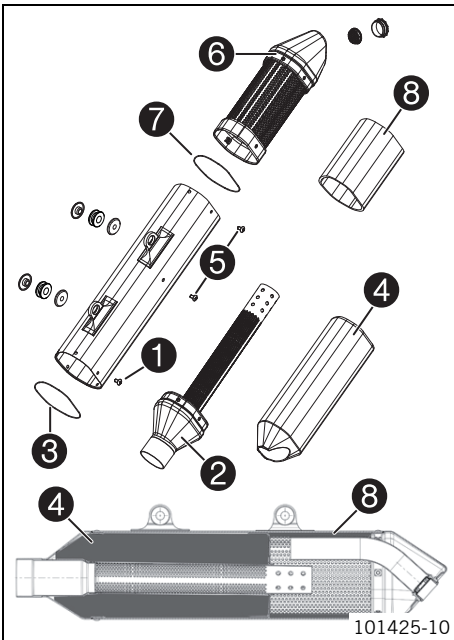

Main work
(all EXC models)

- Remove screws ① of connecting cap ②.
- Take off the connecting cap with the perforated pipe, O-ring ③, and glass fiber yarn filling ④.
- Remove screws ⑤ and take off silencer cap ⑥ with O-ring ⑦ and stuffing yarn ⑧.
- Clean the parts that need to be reinstalled and check for damage.
- Mount the O-ring on the silencer cap.
- Mount the new stuffing yarn on the silencer cap and fasten with adhesive tape.
- Position the silencer cap. Mount and tighten the screws.
- Mount the O-ring on the connecting cap.
- Slide the new glass fiber yarn filling over the perforated pipe.
- Mount the connecting cap with the glass fiber yarn filling in the main silencer.

i Info
Slide the glass fiber yarn filling into the main silencer with a blunt tool.

- Mount and tighten the screws.

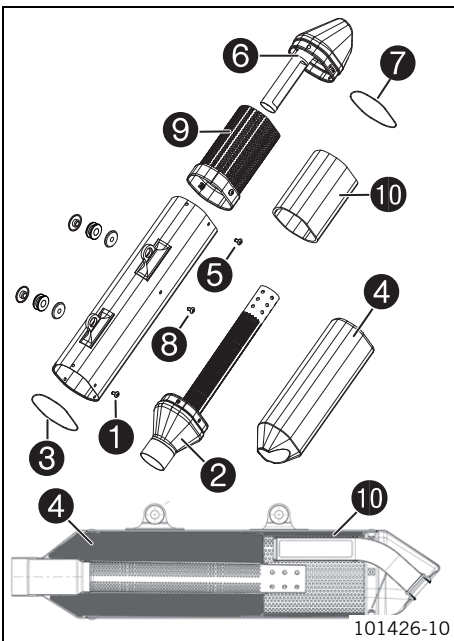

(all XC-W models)

- Remove screws ① of connecting cap ②.
- Take off the connecting cap with the perforated pipe, O-ring ③, and glass fiber yarn filling ④.
- Remove screw ⑤ and take off silencer cap ⑥ with O-ring ⑦.
- Remove screw ⑧ and remove insert ⑨ together with stuffing yarn ⑩.
- Clean the parts that need to be reinstalled and check for damage.
- Mount the new stuffing yarn on the insert and fasten with adhesive tape.
- Slide the insert with the stuffing yarn into the main silencer and fasten with the screw.
- Mount the O-ring on the connecting cap.
- Slide the new glass fiber yarn filling over the perforated pipe.
- Mount the connecting cap with the glass fiber yarn filling in the main silencer.

i Info
Slide the glass fiber yarn filling into the main silencer with a blunt tool.

- Mount and tighten the screws.
- Mount the O-ring on the silencer cap.
- Position the silencer cap. Mount and tighten the screws.

Finishing work

- Install the main silencer. (☛ p. 70)

12.34 Removing the fuel tank ☛

! Danger
Fire hazard Fuel is highly flammable.

- Never refuel the vehicle near open flames or burning cigarettes, and always switch off the engine first. Be careful that no fuel is spilt, especially on hot vehicle components. Clean up spilt fuel immediately.
- The fuel in the fuel tank expands when warm and may emerge if overfilled. Follow the instructions on refueling.

! Warning
Danger of poisoning Fuel is poisonous and a health hazard.

- Fuel must not come into contact with the skin, eyes, or clothing. Do not breathe in the fuel vapors. If contact occurs with the eyes, rinse with water immediately and contact a physician. Immediately clean contaminated areas on the skin with soap and water. If fuel is swallowed, contact a physician immediately. Change clothing that is contaminated with fuel. Store fuel properly in a suitable canister and keep away from children.

Preparatory work

- Remove the seat. (☛ p. 67)

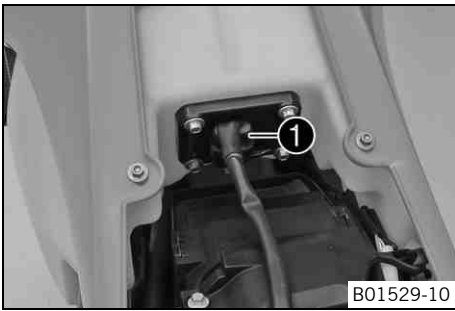

Main work

- Disconnect electric plug-in connection ❶ of the fuel pump.
- Remove the tube from the fuel tank breather.

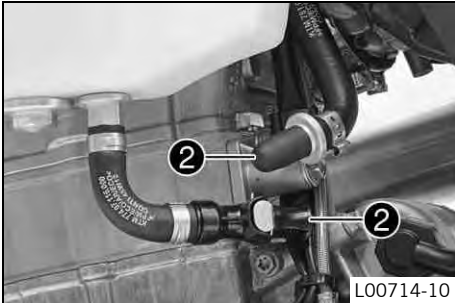

- Thoroughly clean the plug-in connection of the fuel line using compressed air.



Info

Under no circumstances should dirt enter into the fuel line. Dirt in the fuel line clogs the injection valve.

- Disconnect the plug-in connection of the fuel line.
- Mount wash cap set ❷.

Wash cap set (81212016100)

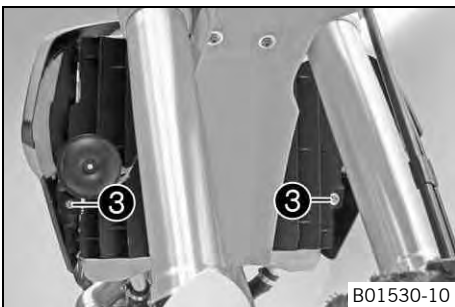

- Remove screws ❸ with the collar bushings and horn.

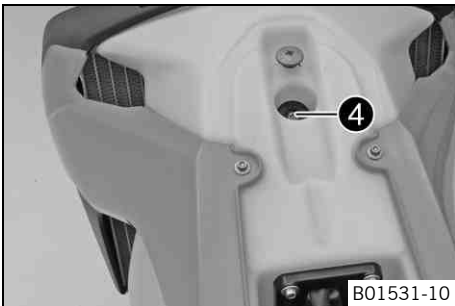

- Remove screw ❹ with the rubber bushing.

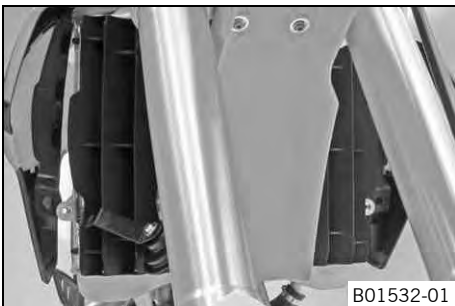

- Pull both spoilers off of the sides of the radiator bracket and lift off the fuel tank.

12.35 Installing the fuel tank ↩



Danger

Fire hazard Fuel is highly flammable.

- Never refuel the vehicle near open flames or burning cigarettes, and always switch off the engine first. Be careful that no fuel is spilt, especially on hot vehicle components. Clean up spilt fuel immediately.
- The fuel in the fuel tank expands when warm and may emerge if overfilled. Follow the instructions on refueling.



Warning

Danger of poisoning Fuel is poisonous and a health hazard.

- Fuel must not come into contact with the skin, eyes, or clothing. Do not breathe in the fuel vapors. If contact occurs with the eyes, rinse with water immediately and contact a physician. Immediately clean contaminated areas on the skin with soap and water. If fuel is swallowed, contact a physician immediately. Change clothing that is contaminated with fuel.

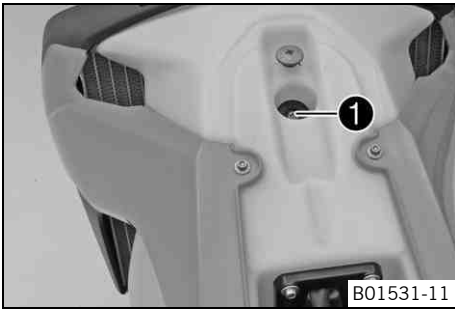

Main work

- Check the throttle cable routing. (☛ p. 77)
- Position the fuel tank and fit the two spoilers to the sides of the radiator bracket.
- Make sure that no cables are trapped or damaged.
- Mount the fuel tank breather.
- Mount and tighten screw ❶ with the rubber bushing.

Guideline

Remaining screws, chassis	M6	10 Nm (7.4 lbf ft)
---------------------------	----	--------------------

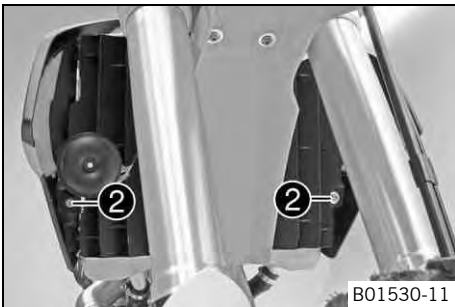

- Position the horn, and fit and tighten screws ❷ with collar bushings.

Guideline

Remaining screws, chassis	M6	10 Nm (7.4 lbf ft)
---------------------------	----	--------------------

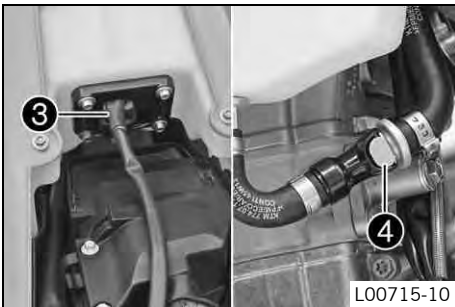

- Connect the electrical plug-in connection ❸.
- Remove the wash cap set.
- Thoroughly clean the plug-in connection of the fuel line using compressed air.



Info

Never let dirt enter the fuel line. Dirt in the fuel line clogs the injection valve.

- Lubricate the O-ring and connect plug-in connection ❹ of the fuel line.



Info

Route the cable and fuel line at a safe distance from the exhaust system.

Finishing work

- Mount the seat. (☛ p. 68)

12.36 Checking for chain dirt accumulation

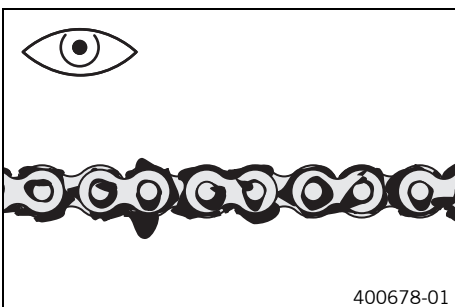

- Check the chain for coarse dirt accumulation.
 - » If the chain is very dirty:
 - Clean the chain. (☛ p. 74)

12.37 Cleaning the chain

Warning
Danger of accidents Oil or grease on the tires reduces their grip.
 – Remove oil and grease with a suitable cleaning material.

Warning
Danger of accidents Reduced braking efficiency due to oil or grease on the brake discs.
 – Always keep the brake discs free of oil and grease, and clean them with brake cleaner when necessary.

Warning
Environmental hazard Hazardous substances cause environmental damage.
 – Oil, grease, filters, fuel, cleaners, brake fluid, etc., should be disposed of as stipulated in applicable regulations.

Info
 The service life of the chain depends largely on its maintenance.

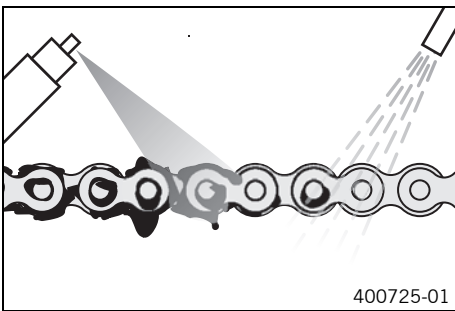

– Clean the chain regularly and then treat with chain spray.

Chain cleaner (☛ p. 128)
Off-road chain spray (☛ p. 128)

12.38 Checking the chain tension

Warning
Danger of accidents Danger caused by incorrect chain tension.
 – If the chain is too taut, the components of the secondary power transmission (chain, engine sprocket, rear sprocket, bearings in the transmission and in the rear wheel) will be under additional load. In addition to premature wear, this can cause the chain or the countershaft of the transmission to break in extreme cases. If the chain is too loose, however, it may fall off the engine sprocket or rear sprocket and block the rear wheel or damage the engine. Ensure that the chain tension is correct and adjust it if necessary.

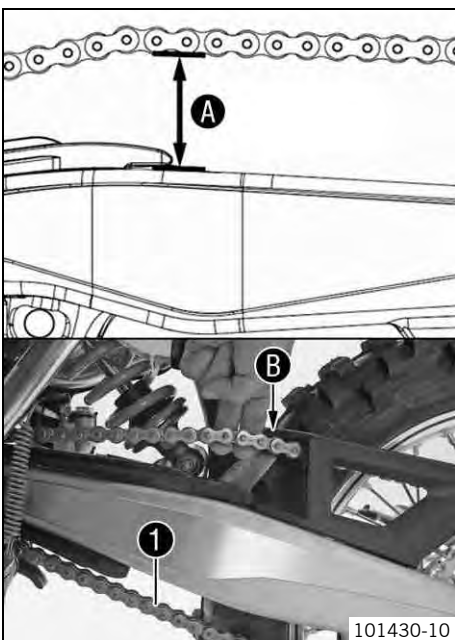

Preparatory work

– Raise the motorcycle with the lift stand. (☛ p. 56)

Main work

– Push the chain at the end of the chain sliding component upwards to measure the chain tension **A**.

Info
 The lower chain section **1** must be taut.
 When the chain guard is mounted, it must be possible to pull up the chain at least to the point where it makes contact with chain guard **B**.
 Chain wear is not always even, so you should repeat this measurement at different chain positions.

Chain tension	55... 58 mm (2.17... 2.28 in)
---------------	-------------------------------

» If the chain tension does not meet specifications:
 – Adjust the chain tension. (☛ p. 75)

Finishing work

- Remove the motorcycle from the lift stand. (🔧 p. 56)

12.39 Adjusting the chain tension



Warning
Danger of accidents Danger caused by incorrect chain tension.

- If the chain is too taut, the components of the secondary power transmission (chain, engine sprocket, rear sprocket, bearings in the transmission and in the rear wheel) will be under additional load. In addition to premature wear, this can cause the chain or the countershaft of the transmission to break in extreme cases. If the chain is too loose, however, it may fall off the engine sprocket or rear sprocket and block the rear wheel or damage the engine. Ensure that the chain tension is correct and adjust it if necessary.

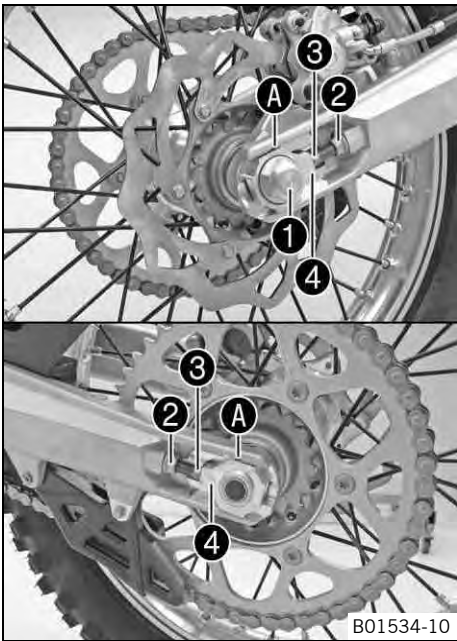

Preparatory work

- Raise the motorcycle with the lift stand. (🔧 p. 56)
- Check the chain tension. (🔧 p. 74)

Main work

- Loosen nut ①.
- Loosen nuts ②.
- Adjust the chain tension by turning adjusting screws ③ left and right.

Guideline

Chain tension	55... 58 mm (2.17... 2.28 in)
Turn adjusting screws ③ on the left and right so that the markings on the left and right chain adjusters are in the same position relative to the reference marks A. The rear wheel is then correctly aligned.	

- Tighten nuts ②.
- Make sure that the chain adjusters ④ are fitted correctly on the adjusting screws ③.
- Tighten nut ①.

Guideline

Nut, rear wheel spindle	M20x1.5	80 Nm (59 lbf ft)
-------------------------	---------	-------------------



Info
 The wide adjustment range of the chain adjusters (32 mm (1.26 in)) enables different secondary ratios with the same chain length. Chain adjusters ④ can be turned by 180°.

Finishing work

- Remove the motorcycle from the lift stand. (🔧 p. 56)

12.40 Checking the chain, rear sprocket, engine sprocket and chain guide

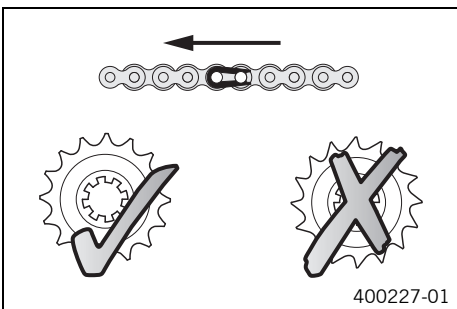

Preparatory work

- Raise the motorcycle with the lift stand. (🔧 p. 56)

Main work

- Shift gear to neutral.
- Check the rear sprocket and engine sprocket for wear.
 - » If the rear sprocket or engine sprocket is worn:
 - Change the power set. 🛠️



Info
 The engine sprocket, rear sprocket and chain should always be replaced together.

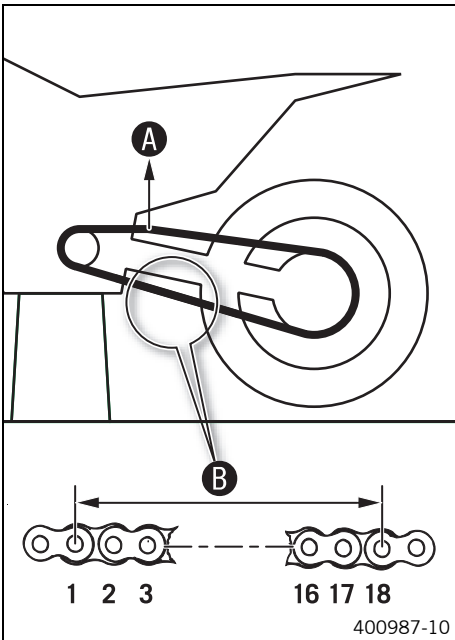

- Pull on the upper part of the chain with the specified weight **A**.

Guideline

Weight of chain wear measurement	10... 15 kg (22... 33 lb.)
----------------------------------	----------------------------

- Measure the distance **B** of 18 chain links in the lower chain section.

i Info

Chain wear is not always even, so you should repeat this measurement at different chain positions.

Maximum distance B at the longest chain section	272 mm (10.71 in)
--	-------------------

- » If the distance **B** is greater than the specified measurement:

- Change the power set.

i Info

When the chain is replaced, the rear sprocket and engine sprocket should also be changed.
New chains wear out faster on old, worn sprockets.



- Check the chain sliding guard for wear.
 - » If the bottom edge of the chain bolt is in line with or below the chain sliding guard:
 - Change the chain sliding guard.

- Check that the chain sliding guard is firmly seated.

- » If the chain sliding guard is loose:

- Tighten the chain sliding guard.

Guideline

Screw, chain sliding guard	M6	6 Nm (4.4 lbf ft)	Loctite® 243™
----------------------------	----	----------------------	----------------------

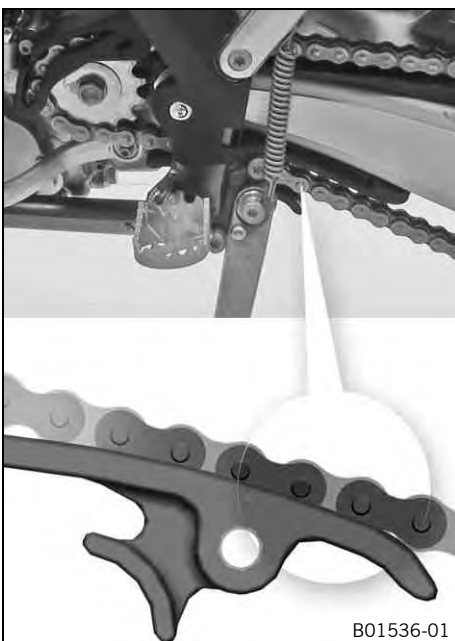

- Check the chain sliding piece for wear.
 - » If the bottom edge of the chain bolt is in line with or below the chain sliding piece:
 - Change the chain sliding piece.

- Check that the chain sliding piece is firmly seated.

- » If the chain sliding piece is loose:

- Tighten the chain sliding piece.

Guideline

Screw, chain sliding piece	M8	15 Nm (11.1 lbf ft)
----------------------------	----	------------------------

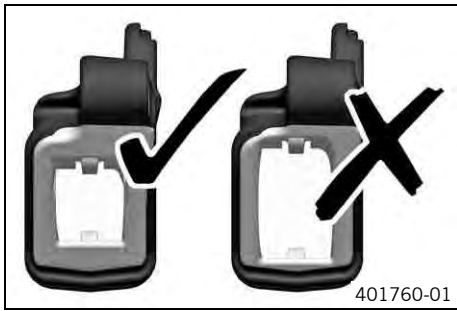

- Check the chain guide for wear.

i Info

Wear is visible on the front of the chain guide.

- » If the light part of the chain guide is worn:
 - Change the chain guide. 🛠️

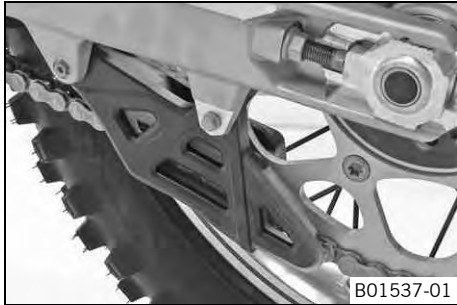

- Check that the chain guide is firmly seated.

- » If the chain guide is loose:
 - Tighten the chain guide.

Guideline

Remaining screws, chassis	M6	10 Nm (7.4 lbf ft)
Remaining nuts, chassis	M6	10 Nm (7.4 lbf ft)

Finishing work

- Remove the motorcycle from the lift stand. (🔧 p. 56)

12.41 Checking the frame 🛠️

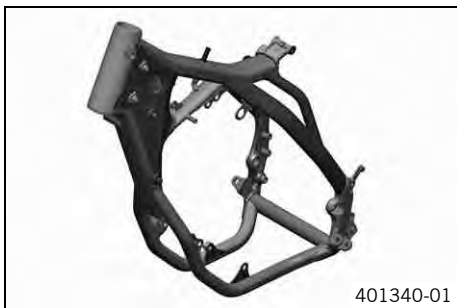

- Check the frame for cracking and deformation.
 - » If the frame exhibits cracking or deformation due to a mechanical impact:
 - Change the frame. 🛠️

i Info

A frame that has been damaged due to a mechanical impact must always be changed. Repair of the frame is not authorized by KTM.

12.42 Checking the swingarm 🛠️



- Check the swingarm for damage, cracking, and deformation.
 - » If the swingarm shows signs of damage, cracking, or deformation:
 - Change the swingarm. 🛠️

i Info

A damaged swingarm must always be changed. Repair of the swingarm is not authorized by KTM.

12.43 Checking the throttle cable routing

Preparatory work

- Remove the seat. (🔧 p. 67)
- Remove the fuel tank. 🛠️ (🔧 p. 71)



Main work

- Check the throttle cable routing.

Both throttle cables must be routed side by side behind the handlebars and above the fuel tank bearing to the throttle valve body.

- » If the throttle cable is not routed as specified:
 - Correct the throttle cable routing.

Finishing work

- Install the fuel tank. (🔧 p. 72)
- Mount the seat. (🔧 p. 68)

12.44 Checking the rubber grip

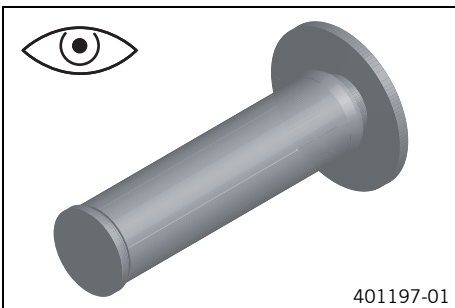

- Check the rubber grips on the handlebar for damage and wear and to ensure they are firmly seated.
 - » If a rubber grip is damaged, worn or loose:
 - Change and secure the rubber grip.

Rubber grip adhesive (00062030051) (🔧 p. 129)

12.45 Additionally securing the rubber grip



Preparatory work

- Check the rubber grip. (🔧 p. 78)

Main work

- Secure the rubber grip at two points using the securing wire.

Securing wire (54812016000)

Wire twister forceps (U6907854)

- ✓ The twisted wire ends face away from the hands and are bent toward the rubber grip.

12.46 Adjusting the basic position of the clutch lever

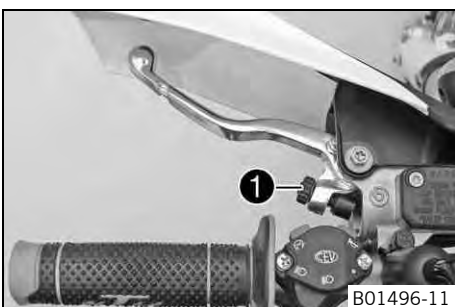

- Adjust the basic setting of the clutch lever to your hand size by turning adjusting screw ❶.

i Info

Turn the adjusting screw clockwise to increase the distance between the clutch lever and the handlebar.
 Turn the adjusting screw counterclockwise to decrease the distance between the clutch lever and the handlebar.
 The range of adjustment is limited.
 Turn the adjusting screw by hand only, and do not apply any force.
 Do not make any adjustments while riding!

12.47 Checking/correcting the fluid level of the hydraulic clutch

i Info
The fluid level rises with increased wear of the clutch lining discs.

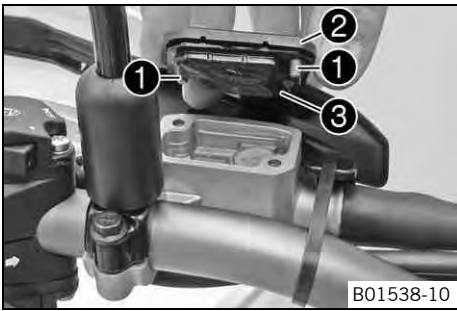

- Move the clutch fluid reservoir mounted on the handlebar to a horizontal position.
- Remove screws ❶.
- Remove cover ❷ with membrane ❸.
- Check the fluid level.

Fluid level below container rim	4 mm (0.16 in)
---------------------------------	----------------

- » If the fluid level does not meet specifications:
 - Correct the fluid level of the hydraulic clutch.

Brake fluid DOT 4 / DOT 5.1 (☛ p. 126)
--

- Position the cover with the membrane. Mount and tighten the screws.

i Info
Clean up overflowed or spilt brake fluid immediately with water.

12.48 Changing the hydraulic clutch fluid ☞

Warning
Environmental hazard Hazardous substances cause environmental damage.

- Oil, grease, filters, fuel, cleaners, brake fluid, etc., should be disposed of as stipulated in applicable regulations.

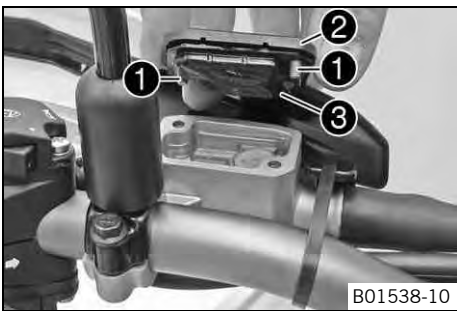

- Move the clutch fluid reservoir mounted on the handlebar to a horizontal position.
- Remove screws ❶.
- Remove cover ❷ with membrane ❸.

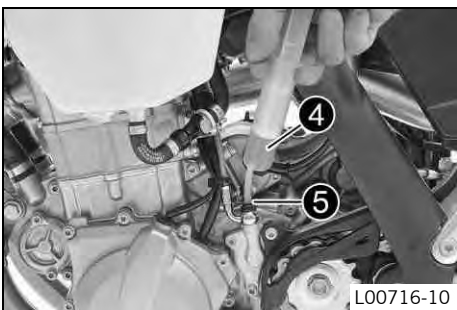

- Fill bleeding syringe ❹ with the appropriate hydraulic fluid.
- On the slave cylinder of the clutch, remove bleeder screw ❺ and mount bleeding syringe ❹.

Bleed syringe (50329050000)

Brake fluid DOT 4 / DOT 5.1 (☛ p. 126)
--

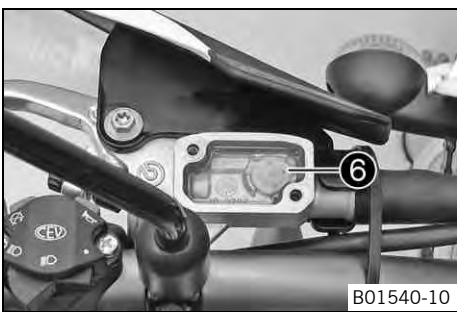

- Inject the liquid into the system until it escapes from openings ❻ of the master cylinder without bubbles.
- To prevent overflow, drain fluid occasionally from the master cylinder reservoir.
- Remove the bleeding syringe. Mount and tighten screws bleeder screw.
- Correct the fluid level of the hydraulic clutch.

Guideline

Fluid level below container rim	4 mm (0.16 in)
---------------------------------	----------------

- Position the cover with the membrane. Mount and tighten the screws.

12.49 Removing the engine guard (EXC SIX DAYS, EXC AUS)



- Turn quick release ❶ counterclockwise until it disengages. Remove the engine guard.

12.50 Installing the engine guard (EXC SIX DAYS, EXC AUS)

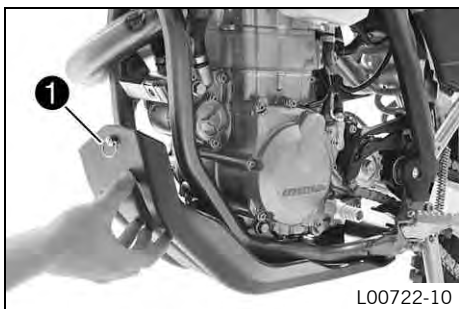

- Attach the engine guard on the frame at the rear and swing up at the front.
- Turn quick release ❶ clockwise all the way.

13.1 Checking free travel of hand brake lever

Warning
Danger of accidents Brake system failure.

- If there is no free travel on the hand brake lever, pressure builds up on the front brake circuit. The front brake can fail due to overheating. Adjust the free travel on hand brake lever according to specifications.

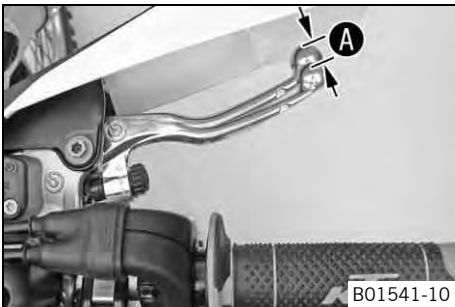

(all EXC models)

- Push the hand brake to the handlebar and check free travel **A**.

Free travel of hand brake lever	≥ 3 mm (≥ 0.12 in)
---------------------------------	--------------------

- » If the free travel does not meet specifications:
 - Adjust the free travel of the hand brake lever. (☛ p. 81)

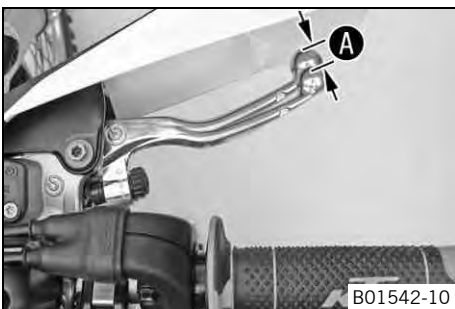

(all XC-W models)

- Push the hand brake lever forwards and check free travel **A**.

Free travel of hand brake lever	≥ 3 mm (≥ 0.12 in)
---------------------------------	--------------------

- » If the free travel does not meet specifications:
 - Adjust the basic position of the hand brake lever. (☛ p. 81)

13.2 Adjusting free travel of hand brake lever (all EXC models)



- Check the free travel of the hand brake lever. (☛ p. 81)
- Adjust the free travel of the hand brake lever with adjusting screw **1**.

i Info

Turn the adjustment screw clockwise to reduce free travel. The pressure point moves away from the handlebar.
 Turn the adjustment screw counterclockwise to increase free travel. The pressure point moves towards the handlebar.
 The range of adjustment is limited.
 Turn the adjusting screw by hand only, and do not apply any force.
 Do not make any adjustments while riding!

13.3 Adjusting the basic position of the hand brake lever (all XC-W models)

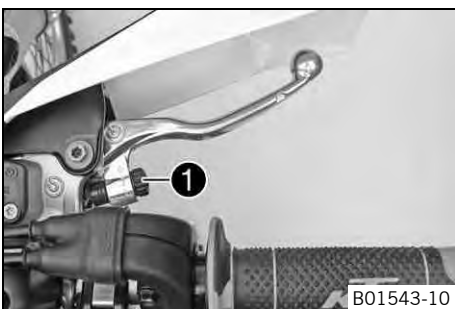

- Check the free travel of the hand brake lever. (☛ p. 81)
- Adjust the basic setting of the hand brake lever to your hand size by turning adjusting screw **1**.

i Info

Turn the adjusting screw clockwise to increase the distance between the hand brake lever and the handlebar.
 Turn the adjusting screw counterclockwise to decrease the distance between the hand brake lever and the handlebar.
 The range of adjustment is limited.
 Turn the adjusting screw by hand only, and do not apply any force.
 Do not make any adjustments while riding!

13.4 Checking the brake discs

Warning
Danger of accidents Reduced braking efficiency due to worn brake disc(s).
 - Change the worn brake disc(s) without delay. (Your authorized KTM workshop will be glad to help.)

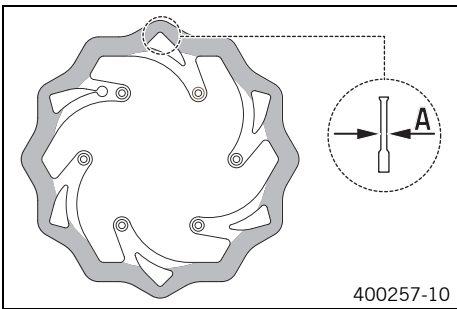

- Check the thickness of the front and rear brake discs at several places on the disk to see if it conforms to measurement **A**.

Info
 Wear reduces the thickness of the brake disc around the area used by the brake linings.

Brake discs - wear limit	
Front	2.5 mm (0.098 in)
Rear	3.5 mm (0.138 in)

- » If the brake disc thickness is less than the specified value:
 - Change the brake disc.
- Check the front and rear brake discs for damage, cracking and deformation.
 - » If the brake disc shows signs of damage, cracking, or deformation:
 - Change the brake disc.

13.5 Checking the brake fluid level of the front brake

Warning
Danger of accidents Brake system failure.
 - If the brake fluid level drops below the specified marking or the specified value, this is an indication that the brake system is leaking or that the brake linings are completely worn down. Check the brake system and do not continue riding. (Your authorized KTM workshop will be glad to help.)

Warning
Danger of accidents Reduced braking efficiency due to old brake fluid.
 - Change the brake fluid of the front and rear brake according to the service schedule. (Your authorized KTM workshop will be glad to help.)

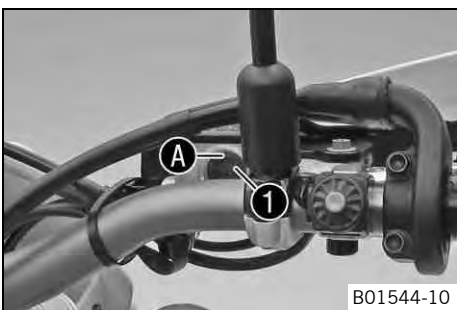

- Move the brake fluid reservoir mounted on the handlebar to a horizontal position.
- Check the brake fluid level in level viewer **1**.
 - » If the brake fluid level has dropped below marking **A**:
 - Add front brake fluid. 🛠️ (👉 p. 82)

13.6 Adding front brake fluid 🛠️

Warning
Danger of accidents Brake system failure.
 - If the brake fluid level drops below the specified marking or the specified value, this is an indication that the brake system is leaking or that the brake linings are completely worn down. Check the brake system and do not continue riding. (Your authorized KTM workshop will be glad to help.)

Warning
Skin irritation Brake fluid can cause skin irritation on contact.
 - Avoid contact with skin and eyes, and keep out of the reach of children.
 - Wear suitable protective clothing and goggles.
 - If brake fluid comes into contact with the eyes, flush the eyes thoroughly with water and consult a physician immediately.

- Warning**
Danger of accidents Reduced braking efficiency due to old brake fluid.
- Change the brake fluid of the front and rear brake according to the service schedule. (Your authorized KTM workshop will be glad to help.)

- Warning**
Environmental hazard Hazardous substances cause environmental damage.
- Oil, grease, filters, fuel, cleaners, brake fluid, etc., should be disposed of as stipulated in applicable regulations.

i Info
 Never use DOT 5 brake fluid. It is silicone-based and purple in color. Oil seals and brake lines are not designed for DOT 5 brake fluid.
 Avoid contact between brake fluid and painted parts. Brake fluid attacks paint!
 Use only clean brake fluid from a sealed container.

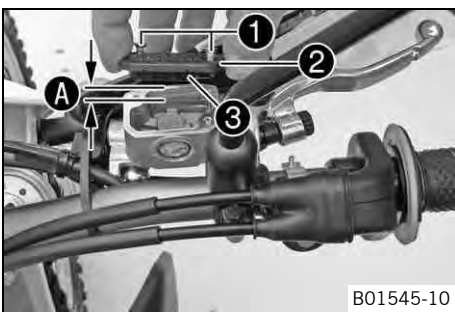

Preparatory work

- Check the front brake linings. (☞ p. 83)

Main work

- Move the brake fluid reservoir mounted on the handlebar to a horizontal position.
- Remove screws ❶.
- Remove cover ❷ with membrane ❸.
- Add brake fluid to level A.

Guideline

Level A (brake fluid level below container rim)	5 mm (0.2 in)
---	---------------

Brake fluid DOT 4 / DOT 5.1 (☞ p. 126)

- Position the cover with the membrane. Mount and tighten the screws.

i Info
 Clean up overflowed or spilt brake fluid immediately with water.

13.7 Checking the front brake linings

- Warning**
Danger of accidents Reduced braking efficiency caused by worn brake linings.
- Change worn brake linings immediately. (Your authorized KTM workshop will be glad to help.)

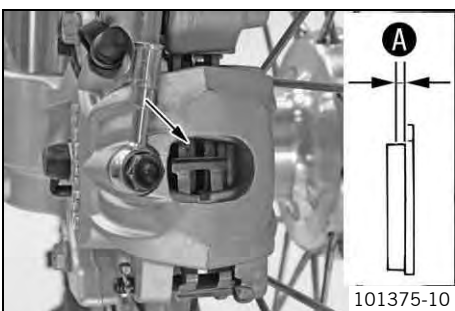







- Check the brake linings for minimum thickness A.

Minimum thickness A	≥ 1 mm (≥ 0.04 in)
---------------------	--------------------

- » If the minimum thickness is less than specified:
 - Change the front brake linings. ☞ (☞ p. 84)
- Check the brake linings for damage and cracking.
 - » If damage or cracking is visible:
 - Change the front brake linings. ☞ (☞ p. 84)

13.8 Changing the front brake linings

-  **Warning**
Danger of accident Brake system failure.
 - Maintenance work and repairs must be carried out professionally. (Your authorized KTM workshop will be glad to help.)
-  **Warning**
Skin irritation Brake fluid can cause skin irritation on contact.
 - Avoid contact with skin and eyes, and keep out of the reach of children.
 - Wear suitable protective clothing and goggles.
 - If brake fluid comes into contact with the eyes, flush the eyes thoroughly with water and consult a physician immediately.
-  **Warning**
Danger of accidents Reduced braking efficiency due to old brake fluid.
 - Change the brake fluid of the front and rear brake according to the service schedule. (Your authorized KTM workshop will be glad to help.)
-  **Warning**
Danger of accidents Reduced braking efficiency due to oil or grease on the brake discs.
 - Always keep the brake discs free of oil and grease, and clean them with brake cleaner when necessary.
-  **Warning**
Danger of accidents Reduced braking efficiency due to use of non-approved brake linings.
 - Brake linings available from accessory suppliers are often not tested and approved for use on KTM vehicles. The construction and friction factor of the brake linings and therefore the brake power can differ considerably from the original KTM brake linings. If brake linings are used that differ from the originals, there is no guarantee that they comply with the original license. The vehicle no longer corresponds to the condition at delivery, and the warranty is no longer valid.
-  **Warning**
Environmental hazard Hazardous substances cause environmental damage.
 - Oil, grease, filters, fuel, cleaners, brake fluid, etc., should be disposed of as stipulated in applicable regulations.

 **Info**
 Never use DOT 5 brake fluid! This is based on silicone oil and is colored purple. Oil seals and brake lines are not designed for DOT 5 brake fluid.
 Avoid contact between brake fluid and painted parts. Brake fluid attacks paint!
 Use only clean brake fluid from a sealed container.

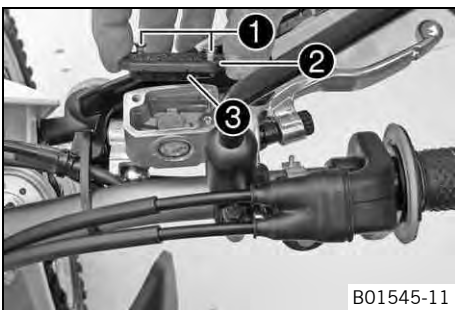

B01545-11

- Move the brake fluid reservoir mounted on the handlebar to a horizontal position.
- Remove screws **1**.
- Remove cover **2** with membrane **3**.
- Manually press the brake caliper toward the brake disc to push back the brake pistons. Ensure that brake fluid does not flow out of the brake fluid reservoir, extracting it by suction if it does.

 **Info**
 Make sure when pushing back the brake pistons that you do not press the brake caliper against the spokes.

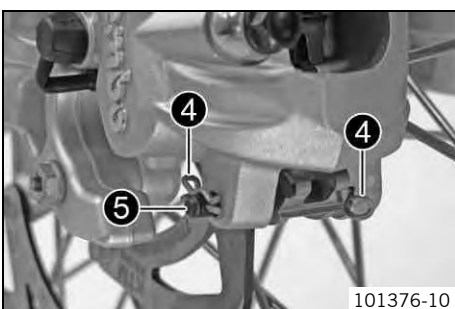

101376-10

- Remove cotter pin **4**, pull out pin **5**, and remove the brake linings.
- Clean the brake caliper and brake caliper support.

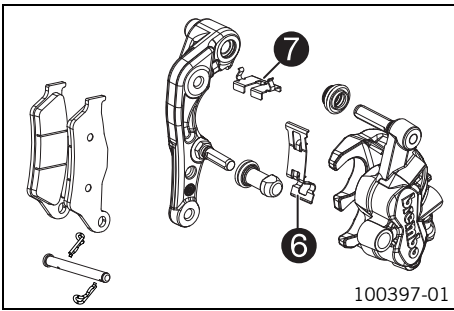

- Check that leaf spring 6 in the brake caliper and sliding plate 7 in the brake caliper support are seated correctly.

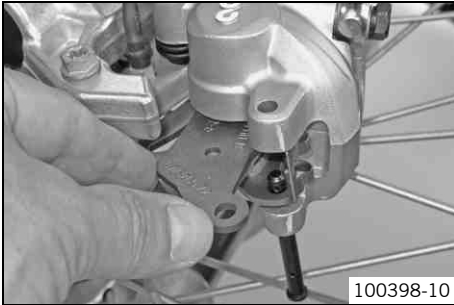

- Insert the brake linings, insert the pin, and mount the cotter pin.
- Operate the hand brake lever repeatedly until the brake linings are in contact with the brake disc and there is a pressure point.

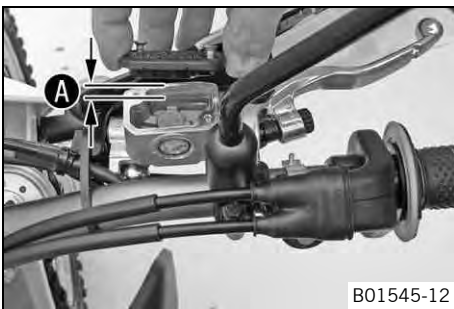

- Correct the brake fluid quantity to level A.

Guideline

Dimension A (brake fluid level below top edge of container)	5 mm (0.2 in)
---	---------------

Brake fluid DOT 4 / DOT 5.1 (↖ p. 126)
--

- Position the cover with the membrane. Mount and tighten the screws.

Info
Clean up overflowed or spilt brake fluid immediately with water.

13.9 Checking the free travel of foot brake lever

Warning
Danger of accidents Brake system failure.

- If there is no free travel on the foot brake lever, pressure builds up on the rear brake circuit. The rear brake can fail due to overheating. Adjust the free travel on foot brake lever according to specifications.

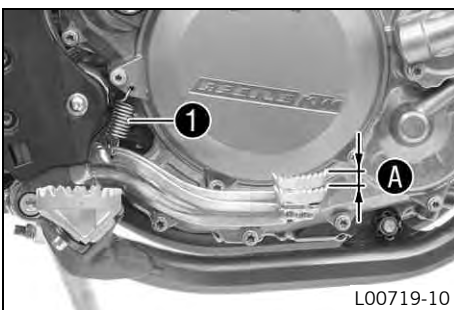

- Disconnect spring 1.
- Move the foot brake lever back and forth between the end stop and the contact to the foot brake cylinder piston and check free travel A.

Guideline

Free travel at foot brake lever	3... 5 mm (0.12... 0.2 in)
---------------------------------	----------------------------

- » If the free travel does not meet specifications:
 - Adjust the basic position of the foot brake lever. ↗ (↖ p. 85)
- Reconnect spring 1.

13.10 Adjusting the basic position of the foot brake lever ↗

Warning
Danger of accidents Brake system failure.

- If there is no free travel on the foot brake lever, pressure builds up on the rear brake circuit. The rear brake can fail due to overheating. Adjust the free travel on foot brake lever according to specifications.

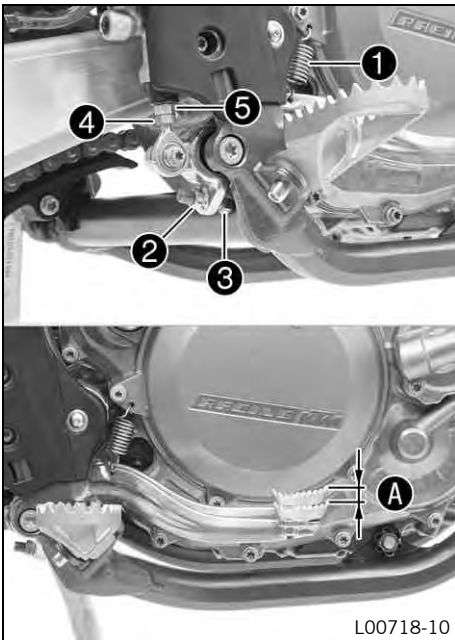

- Disconnect spring ①.
- Loosen nut ④ and, with push rod ⑤, turn it back until you have maximum free travel.
- To adjust the basic position of the foot brake lever individually, loosen nut ② and turn screw ③ accordingly.

Info
The range of adjustment is limited.

- Turn push rod ⑤ accordingly until you have free travel A. If necessary, adjust the basic position of the foot brake lever.

Guideline

Free travel at foot brake lever	3... 5 mm (0.12... 0.2 in)
---------------------------------	----------------------------

- Hold screw ③ and tighten nut ②.

Guideline

Nut, foot brake lever stop	M8	20 Nm (14.8 lbf ft)
----------------------------	----	------------------------

- Hold push rod ⑤ and tighten nut ④.

Guideline

Remaining nuts, chassis	M6	10 Nm (7.4 lbf ft)
-------------------------	----	--------------------

- Reconnect spring ①.

13.11 Checking the rear brake fluid level

Warning
Danger of accidents Brake system failure.

- If the brake fluid level drops below the specified marking or the specified value, this is an indication that the brake system is leaking or that the brake linings are completely worn down. Check the brake system and do not continue riding. (Your authorized KTM workshop will be glad to help.)

Warning
Danger of accidents Reduced braking efficiency due to old brake fluid.

- Change the brake fluid of the front and rear brake according to the service schedule. (Your authorized KTM workshop will be glad to help.)

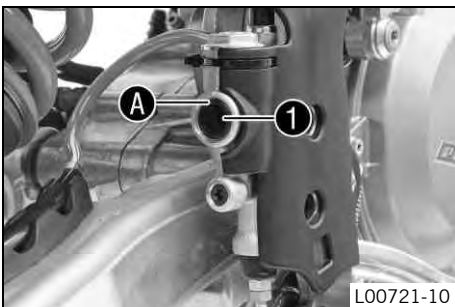

- Stand the vehicle upright.
- Check the brake fluid level in level viewer ①.
 - » If the brake fluid level has dropped below marking A:
 - Add rear brake fluid. (p. 86)

13.12 Adding rear brake fluid

Warning
Danger of accidents Brake system failure.

- If the brake fluid level drops below the specified marking or the specified value, this is an indication that the brake system is leaking or that the brake linings are completely worn down. Check the brake system and do not continue riding. (Your authorized KTM workshop will be glad to help.)

Warning
Skin irritation Brake fluid can cause skin irritation on contact.

- Avoid contact with skin and eyes, and keep out of the reach of children.
- Wear suitable protective clothing and goggles.
- If brake fluid comes into contact with the eyes, flush the eyes thoroughly with water and consult a physician immediately.

- Warning**
Danger of accidents Reduced braking efficiency due to old brake fluid.
- Change the brake fluid of the front and rear brake according to the service schedule. (Your authorized KTM workshop will be glad to help.)

- Warning**
Environmental hazard Hazardous substances cause environmental damage.
- Oil, grease, filters, fuel, cleaners, brake fluid, etc., should be disposed of as stipulated in applicable regulations.

i Info
 Never use DOT 5 brake fluid. It is silicone-based and purple in color. Oil seals and brake lines are not designed for DOT 5 brake fluid.
 Avoid contact between brake fluid and painted parts. Brake fluid attacks paint!
 Use only clean brake fluid from a sealed container.

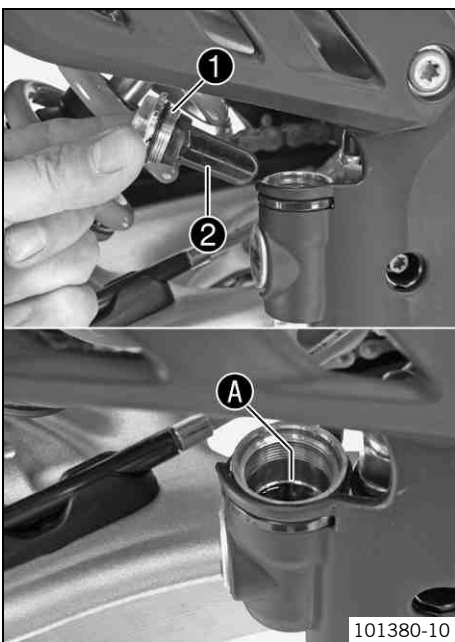

Preparatory work

- Check the rear brake linings. (☞ p. 87)

Main work

- Stand the vehicle upright.
- Remove screw cap ❶ with membrane ❷ and the O-ring.
- Add brake fluid to level A.

Brake fluid DOT 4 / DOT 5.1 (☞ p. 126)
--

- Mount the screw cap with the membrane and the O-ring.

i Info
 Clean up overflowed or spilt brake fluid immediately with water.

13.13 Checking the rear brake linings

- Warning**
Danger of accidents Reduced braking efficiency caused by worn brake linings.
- Change worn brake linings immediately. (Your authorized KTM workshop will be glad to help.)

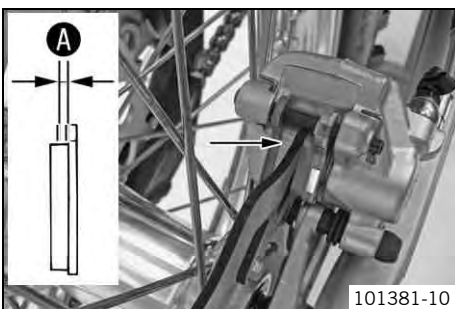







- Check the brake linings for minimum thickness A.

Minimum thickness A	≥ 1 mm (≥ 0.04 in)
---------------------	--------------------

- » If the minimum thickness is less than specified:
 - Change the rear brake linings. ☞ (☞ p. 88)
- Check the brake linings for damage and cracking.
 - » If damage or cracking is visible:
 - Change the rear brake linings. ☞ (☞ p. 88)

13.14 Changing the rear brake linings

-  **Warning**
Danger of accident Brake system failure.
 - Maintenance work and repairs must be carried out professionally. (Your authorized KTM workshop will be glad to help.)
-  **Warning**
Skin irritation Brake fluid can cause skin irritation on contact.
 - Avoid contact with skin and eyes, and keep out of the reach of children.
 - Wear suitable protective clothing and goggles.
 - If brake fluid comes into contact with the eyes, flush the eyes thoroughly with water and consult a physician immediately.
-  **Warning**
Danger of accidents Reduced braking efficiency due to old brake fluid.
 - Change the brake fluid of the front and rear brake according to the service schedule. (Your authorized KTM workshop will be glad to help.)
-  **Warning**
Danger of accidents Reduced braking efficiency due to oil or grease on the brake discs.
 - Always keep the brake discs free of oil and grease, and clean them with brake cleaner when necessary.
-  **Warning**
Danger of accidents Reduced braking efficiency due to use of non-approved brake linings.
 - Brake linings available from accessory suppliers are often not tested and approved for use on KTM vehicles. The construction and friction factor of the brake linings and therefore the brake power can differ considerably from the original KTM brake linings. If brake linings are used that differ from the originals, there is no guarantee that they comply with the original license. The vehicle no longer corresponds to the condition at delivery, and the warranty is no longer valid.
-  **Warning**
Environmental hazard Hazardous substances cause environmental damage.
 - Oil, grease, filters, fuel, cleaners, brake fluid, etc., should be disposed of as stipulated in applicable regulations.

 **Info**
 Never use DOT 5 brake fluid! This is based on silicone oil and is colored purple. Oil seals and brake lines are not designed for DOT 5 brake fluid.
 Avoid contact between brake fluid and painted parts. Brake fluid attacks paint!
 Use only clean brake fluid from a sealed container.

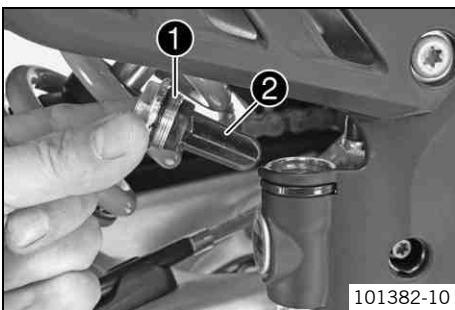

- Stand the vehicle upright.
- Remove screw cap **1** with membrane **2** and the O-ring.
- Press the brake piston back to its basic position and make sure that no brake fluid overflows from the brake fluid reservoir.

 **Info**
 Make sure when pushing back the brake piston that you do not press the brake caliper against the spokes.

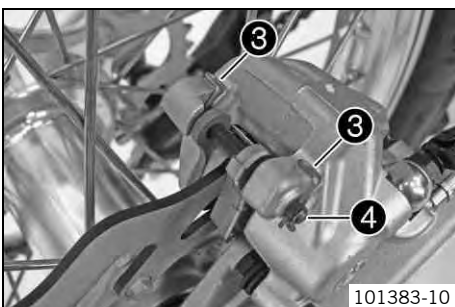

- Remove cotter pin **3**, pull out pin **4**, and remove the brake linings.
- Clean the brake caliper and brake caliper support.

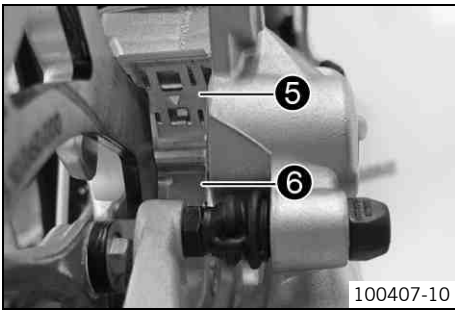

100407-10

- Check that leaf spring ⑤ in the brake caliper and sliding plate ⑥ in the brake caliper support are seated correctly.

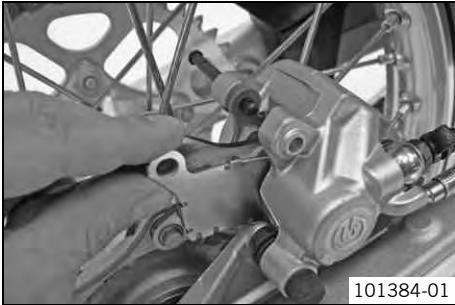

101384-01

- Insert the brake linings, insert the pin, and mount the cotter pin.
- Operate the foot brake lever repeatedly until the brake linings are in contact with the brake disc and there is a pressure point.

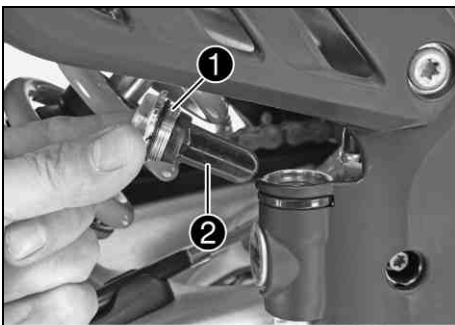

- Add brake fluid to level A.

Brake fluid DOT 4 / DOT 5.1 (☞ p. 126)

- Mount screw cap ① with membrane ② and the O-ring.

i Info

Clean up overflowed or spilt brake fluid immediately with water.

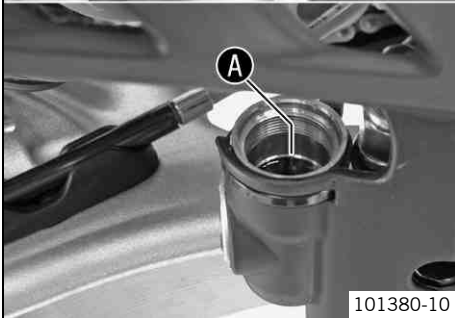

101380-10

14.1 Removing the front wheel



Preparatory work

- Raise the motorcycle with the lift stand. (☛ p. 56)

Main work

- Press the brake caliper onto the brake disc by hand in order to push back the brake pistons.

i Info

Make sure when pushing back the brake pistons that you do not press the brake caliper against the spokes.

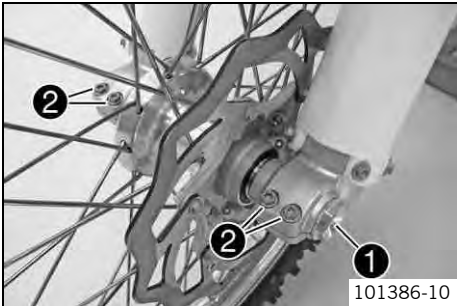

- Remove screw ❶.
- Release screws ❷.

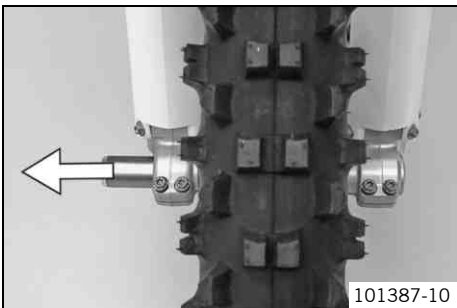

- Holding the front wheel, withdraw the wheel spindle. Take the front wheel out of the fork.

i Info

Do not pull the hand brake lever when the front wheel is removed. Always lay the wheel down in such a way that the brake disc is not damaged.

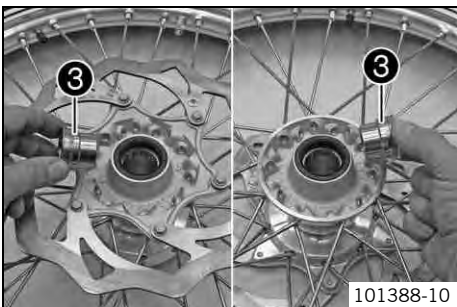

- Remove spacers ❸.

14.2 Installing the front wheel

Warning
Danger of accidents Reduced braking efficiency due to oil or grease on the brake discs.

- Always keep the brake discs free of oil and grease, and clean them with brake cleaner when necessary.

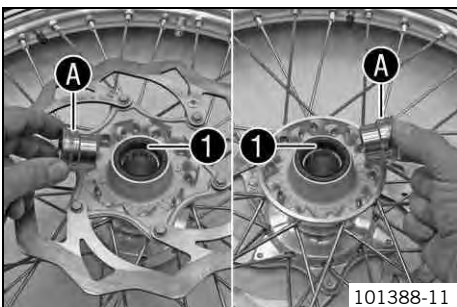

- Check the wheel bearing for damage and wear.
 - » If the wheel bearing is damaged or worn:
 - Change the wheel bearing. ☛
- Clean and grease shaft seal rings ❶ and bearing surface **A** of the spacers.

Long-life grease (☛ p. 128)

- Insert the spacers.

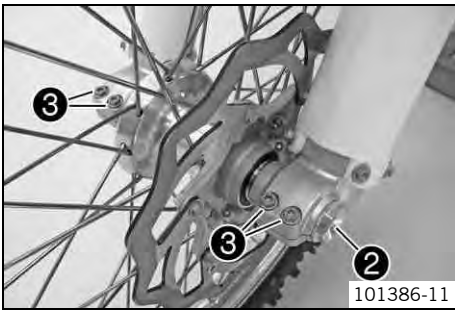

- Position the front wheel and insert the wheel spindle.
 ✓ The brake linings are correctly positioned.
- Mount and tighten screw ②.

Guideline

Screw, front wheel spindle	M24x1.5	45 Nm (33.2 lbf ft)
----------------------------	---------	------------------------

- Activate the hand brake lever multiple times until the brake linings are in contact with the brake disc.
- Remove the motorcycle from the lift stand. (☛ p. 56)
- Pull the front wheel brake and push down hard on the fork several times to align the fork legs.
- Fully tighten screw ③.

Guideline

Screw, fork stub	M8	15 Nm (11.1 lbf ft)
------------------	----	------------------------

14.3 Removing the rear wheel 🛠️

Preparatory work

- Raise the motorcycle with the lift stand. (☛ p. 56)

Main work

- Press the brake caliper by hand on to the brake disc in order to press back the brake piston.

i Info
 Make sure when pushing back the brake piston that you do not press the brake caliper against the spokes.

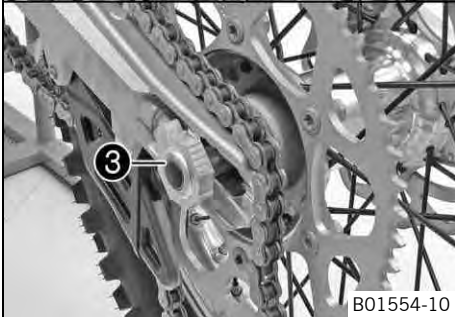
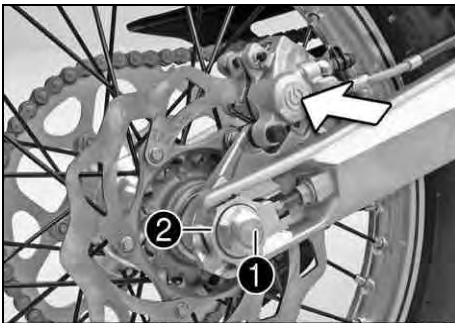

- Remove nut ①.
- Remove chain adjuster ②. Withdraw wheel spindle ③ only enough to allow the rear wheel to be pushed forward.
- Push the rear wheel forward as far as possible. Remove the chain from the rear sprocket.
- Holding the rear wheel, withdraw the wheel spindle. Take the rear wheel out of the swingarm.

i Info
 Do not operate the foot brake when the rear wheel is removed.
 Always lay the wheel down in such a way that the brake disc is not damaged.

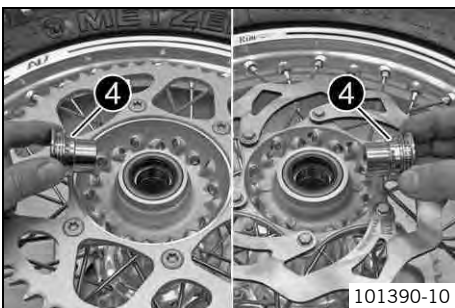

- Remove spacers ④.

14.4 Installing the rear wheel

Warning
Danger of accidents Reduced braking efficiency due to oil or grease on the brake discs.
 – Always keep the brake discs free of oil and grease, and clean them with brake cleaner when necessary.

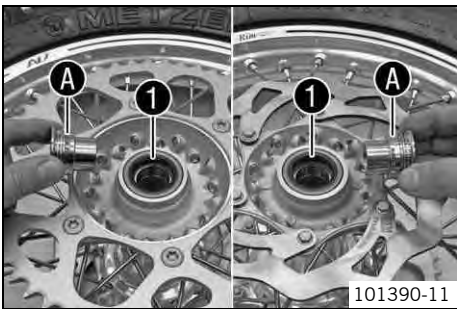

Main work

- Check the wheel bearing for damage and wear.
 - » If the wheel bearing is damaged or worn:
 - Change the wheel bearing.
- Clean and grease shaft seal rings 1 and bearing surface A of the spacers.

Long-life grease (☛ p. 128)

- Insert the spacers.

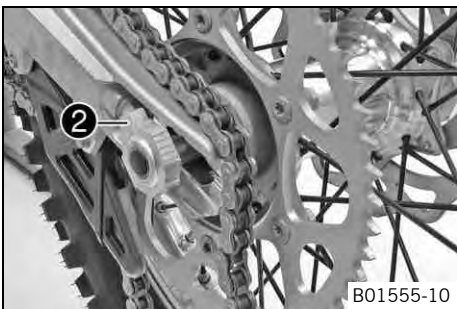

- Position the rear wheel and insert wheel spindle 2.
 - ✓ The brake linings are correctly positioned.
- Attach the chain.

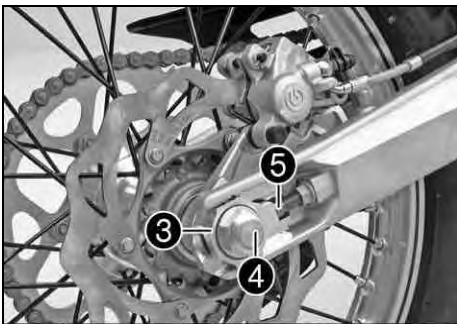

- Position chain adjuster 3. Mount nut 4 but do not tighten it yet.
- Make sure that chain adjusters 3 are fitted correctly on adjusting screws 5.
- Check the chain tension. (☛ p. 74)
- Tighten nut 4.

Guideline

Nut, rear wheel spindle	M20x1.5	80 Nm (59 lbf ft)
-------------------------	---------	-------------------

i Info
 The wide adjustment range of the chain adjusters (32 mm (1.26 in)) enables different secondary ratios with the same chain length. Chain adjusters 3 can be turned by 180°.

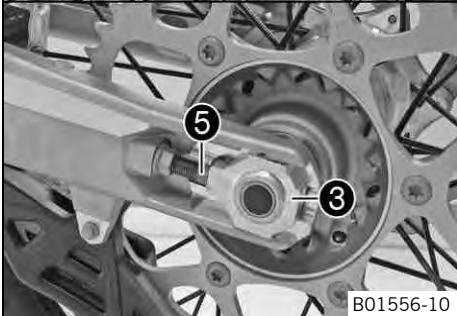

- Operate the foot brake lever repeatedly until the brake linings are in contact with the brake disc and there is a pressure point.

Finishing work

- Remove the motorcycle from the lift stand. (☛ p. 56)

14.5 Checking the tire condition

i Info
 Only mount tires approved and/or recommended by KTM. Other tires could have a negative effect on handling characteristics. The type, condition, and air pressure of the tires all have a significant impact on the handling characteristics of the motorcycle. The tires mounted on the front and rear wheels must have a similar profile. Worn tires have a negative effect on handling characteristics, especially on wet surfaces.

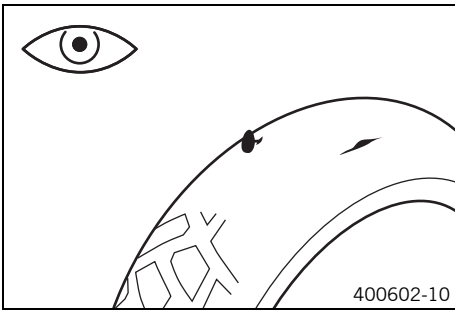

- Check the front and rear tires for cuts, run-in objects, and other damage.
 - » If the tire exhibits cuts, run-in objects, or other damage:
 - Change the tire.
- Check the depth of the tread.



Info

Note local national regulations concerning the minimum tread depth.

Minimum tread depth	≥ 2 mm (≥ 0.08 in)
---------------------	--------------------

- » If the tread depth is less than the minimum permissible depth:
 - Change the tire.
- Check the tire age.



Info

The tire's date of manufacture is usually part of the tire markings and is indicated by the last four digits of the **DOT** marking. The first two digits indicate the week of manufacture and the last two digits the year of manufacture.

KTM recommends that the tires be changed after 5 years at the latest, regardless of the actual state of wear.

- » If the tire is older than five years:
 - Change the tire.

14.6 Checking the tire air pressure



Info

Low tire air pressure leads to abnormal wear and overheating of the tire. Correct tire air pressure ensures optimal riding comfort and maximum tire service life.

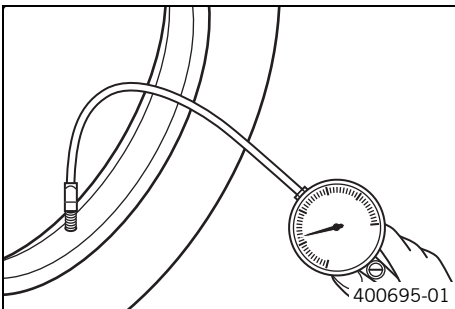

- Remove the protection cap.
- Check the tire air pressure when the tires are cold.

Tire air pressure off road	
Front	1.0 bar (15 psi)
Rear	1.0 bar (15 psi)

Road tire pressure (all EXC models)	
Front	1.5 bar (22 psi)
Rear	1.5 bar (22 psi)

- » If the tire air pressure does not meet specifications:
 - Correct the tire air pressure.
- Mount protection cap.

14.7 Checking spoke tension



Warning

Danger of accidents Instable handling due to incorrect spoke tension.

- Ensure that the spoke tension is correct. (Your authorized KTM workshop will be glad to help.)



Info

A loose spoke can cause wheel imbalance, which leads to more loose spokes in a short time. If the spokes are too tight, they can break due to local overload. Check the spoke tension regularly, especially on a new motorcycle.

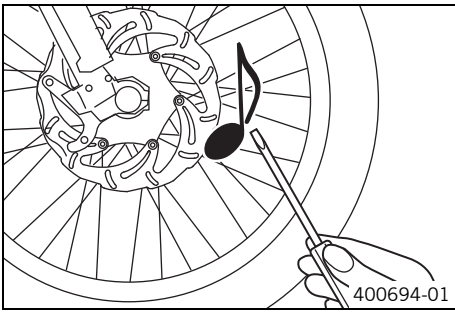

- Tap each spoke with a screwdriver.

i Info

The sound frequency depends on the length and thickness of the spoke. If there are different sound frequencies in spokes with the same length and thickness, this indicates different spoke tensions.

You should hear a high note.

- » If the spoke tension varies:
 - Correct the spoke tension. ↩

- Check the spoke torque.

Guideline

Spoke nipple, front wheel	M4.5	5... 6 Nm (3.7... 4.4 lbf ft)
Spoke nipple, rear wheel	M4.5	5... 6 Nm (3.7... 4.4 lbf ft)

Torque wrench with various accessories in set (58429094000)

15.1 Removing the battery

- Warning**
Risk of injury Battery acid and battery gases cause serious chemical burns.
- Keep batteries out of the reach of children.
 - Wear suitable protective clothing and goggles.
 - Avoid contact with battery acid and battery gases.
 - Keep sparks and open flames away from the battery. Only charge in well-ventilated rooms.
 - In the event of skin contact, rinse with large amounts of water. If battery acid gets in the eyes, rinse with water for at least 15 minutes and contact a physician.

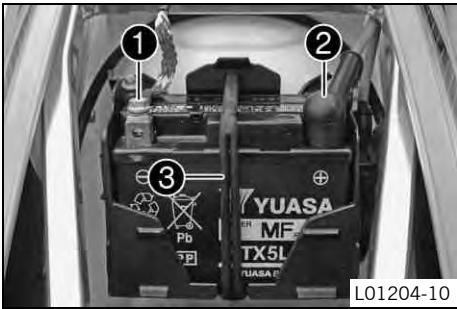

L01204-10

Preparatory work

- Switch off all power consumers and switch off the engine.
- Remove the seat. (☛ p. 67)

Main work

- Disconnect negative cable ① of the battery.
- Pull back the positive terminal cover ② and disconnect the positive (plus) cable of the battery.
- Detach rubber band ③ at the bottom.
- Lift the battery up and out.

15.2 Installing the battery

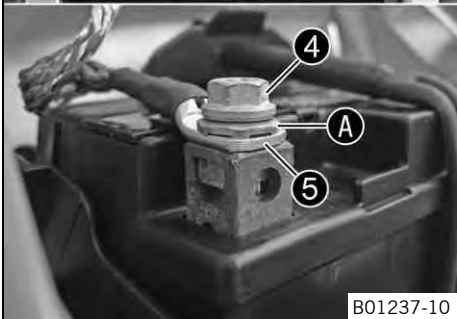
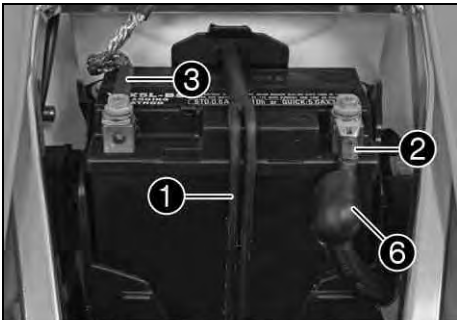

B01237-10

Main work

- Insert battery into the battery compartment with the terminals facing to the front.
- Battery (YTX5L-BS) (☛ p. 122)
- Reconnect rubber band ①.
 - Connect positive cable ②.

Guideline

Screw, battery terminal	M5	2.5 Nm (1.84 lbf ft)
-------------------------	----	-------------------------



Info
 Contact disk **A** must be mounted between screw ④ and cable socket ⑤ with the claws facing down.

- Slide positive terminal cover ⑥ over the positive terminal.
- Connect negative cable ③.

Guideline

Screw, battery terminal	M5	2.5 Nm (1.84 lbf ft)
-------------------------	----	-------------------------



Info
 Contact disk **A** must be mounted between screw ④ and cable socket ⑤ with the claws facing down.

Finishing work

- Mount the seat. (☛ p. 68)

15.3 Charging the battery ↩

Warning
Risk of injury Battery acid and battery gases cause serious chemical burns.

- Keep batteries out of the reach of children.
- Wear suitable protective clothing and goggles.
- Avoid contact with battery acid and battery gases.
- Keep sparks and open flames away from the battery. Only charge in well-ventilated rooms.
- In the event of skin contact, rinse with large amounts of water. If battery acid gets in the eyes, rinse with water for at least 15 minutes and contact a physician.

Warning
Environmental hazard The battery contains elements that are harmful to the environment.

- Do not discard batteries with the household waste. Dispose of faulty batteries in an environmentally compatible manner. Give the battery to your authorized KTM dealer or dispose of it at a collection point for used batteries.

Warning
Environmental hazard Hazardous substances cause environmental damage.

- Oil, grease, filters, fuel, cleaners, brake fluid, etc., should be disposed of as stipulated in applicable regulations.

i Info
 Even when there is no load on the battery, it still loses power steadily.
 The charge state and the type of charge are very important for the service life of the battery.
 Rapid recharging with a high charging current shortens the battery's service life.
 If the charging current, charging voltage and charging time are exceeded, electrolyte escapes through the safety valves. This reduces the battery capacity.
 If the battery is depleted from starting the vehicle repeatedly, the battery must be charged immediately.
 If the battery is left in a discharged state for an extended period, it will become over-discharged and sulfate, destroying the battery.
 The battery is maintenance-free, which means that the acid level does not need to be checked.

Preparatory work

- Switch off all power consumers and switch off the engine.
- Remove the seat. (↩ p. 67)
- Disconnect the negative cable of the battery to avoid damage to the onboard electronics.

Main work

- Connect the battery charger to the battery. Switch on the battery charger.

Battery charger (58429074000)

You can also use the battery charger to test the open-circuit voltage and starting voltage of the battery, and to test the alternator. With this device, you cannot over-charge the battery.

i Info
 Never remove lid ❶.
 Charge the battery with a maximum of 10% of the capacity specified on battery housing ❷.

- Switch off the battery charger after charging. Disconnect the battery.

Guideline

The charge current, charge voltage, and charge time must not be exceeded.	
Charge the battery regularly when the motorcycle is not in use	3 months

Finishing work

- Mount the seat. (↩ p. 68)



15.4 Changing the main fuse

Warning
Fire hazard The electrical system can be overloaded if the wrong fuses are used.
 – Use only fuses with the prescribed amperage. Never by-pass or repair fuses.

Info
 The main fuse protects all power consumers of the vehicle. It is located in the starter relay housing under the air filter box cover.

Preparatory work

- Switch off all power consumers and the engine.
- Remove the air filter box lid. (☛ p. 68)

Main work

- Remove screw ❶.

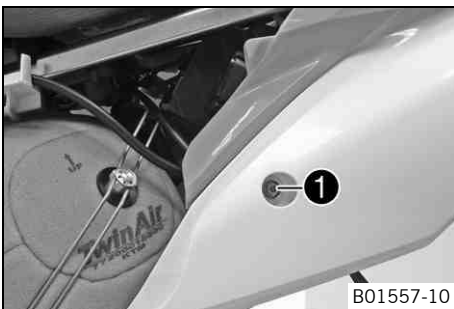

- Lift rear fairing ❷ slightly and pull starter relay ❸ out of the holder.

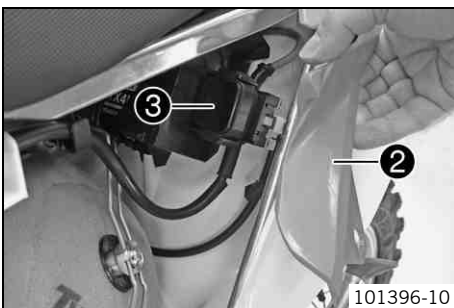

- Remove protection caps ❹.
- Remove the faulty main fuse ❺.

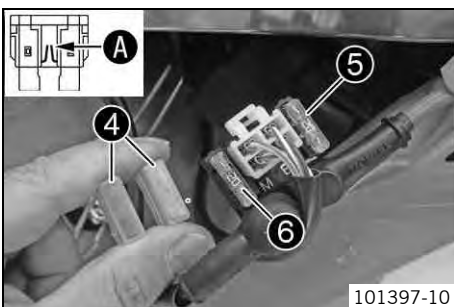

Info

A defective fuse can be identified by the burned-out fuse wire ❹. A reserve fuse ❻ is located in the starter relay.

- Install a new main fuse.

Fuse (58011109120) (☛ p. 122)

- Check that the electrical equipment is functioning properly.

Tip

Insert the spare fuse so that it is available if needed.

- Mount the protection caps.
- Mount the starter relay onto the holder and lay the cable.
- Position the rear fairing. Mount and tighten the screw.

Guideline

Remaining screws, chassis	M6	10 Nm (7.4 lbf ft)
---------------------------	----	--------------------

Finishing work

- Install the air filter box lid. (☛ p. 68)

15.5 Changing the fuses of individual power consumers

i Info
The fuse box containing the fuses of individual power consumers is located under the seat.

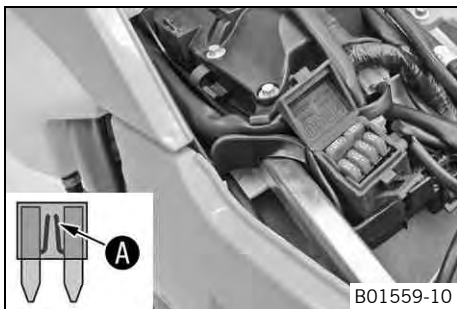

Preparatory work

- Switch off all power consumers and switch off the engine.
- Remove the seat. (☛ p. 67)

Main work

- Open fuse box cover ❶.

- Remove the defective fuse.

Guideline

Fuse 1 - 10 A - EFI control unit
Fuse 2 - 10 A - fuel pump
Fuse 3 - 10 A - high beam, low beam, parking light, tail light, license plate lamp
Fuse 4 - 10 A - horn, brake light, turn signal, radiator fan
Fuses res - 10 A - spare fuses

i Info
A defective fuse can be identified by the burned-out fuse wire ❸.

! Warning
Fire hazard The electrical system can be overloaded if the wrong fuses are used.

- Use only fuses with the prescribed amperage. Never by-pass or repair fuses.

- Use spare fuses with the correct rating only.

Fuse (75011088010) (☛ p. 122)

i Tip
Replace the spare fuse in the fuse box so that it is available if needed.

- Check that the power consumer is functioning properly.
- Close the fuse box cover.

Finishing work

- Mount the seat. (☛ p. 68)

15.6 Removing headlight mask with headlight

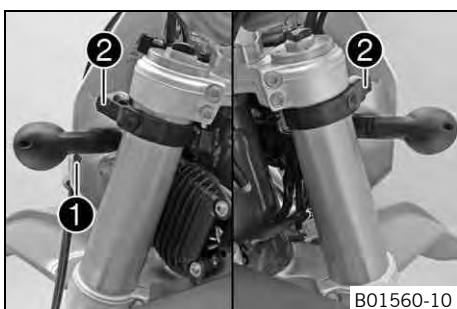

- Switch off all electrical equipment.
- Remove screw ❶ and take off clamp.
- Loosen the rubber band ❷. Push up the headlight mask and swing it forwards.

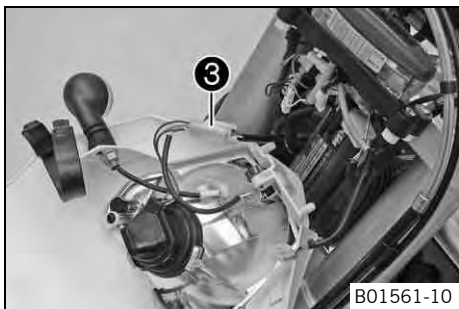

- Pull out the electric plug connector ③ and remove the headlight mask with the headlight.

15.7 Refitting the headlight mask with the headlight

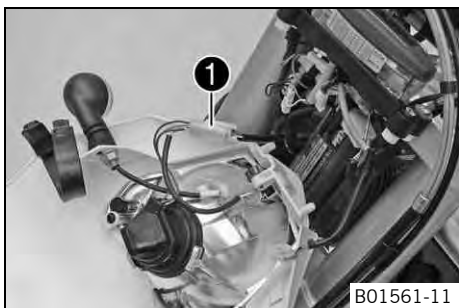

Main work

- Connect the electric plug connector ①.

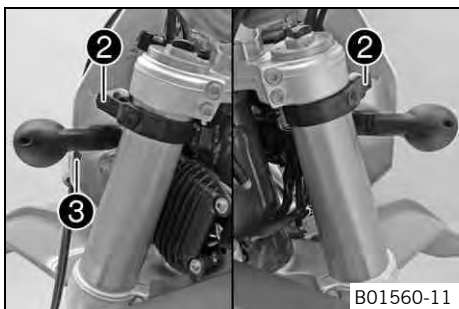

- Position the headlight mask and fix it with the rubber band ②.



Info

Ensure that the retaining lugs engage in the fender.

- Position the brake line and wiring harness. Put the clamp on, mount and tighten screw ③.

Finishing work

- Check the headlight setting. (☛ p. 100)

15.8 Changing the headlight bulb

Note

Damage to reflector Reduced brightness.

- Grease on the lamp will evaporate due to the heat and be deposited on the reflector. Clean the lamp and keep it free of grease before mounting.

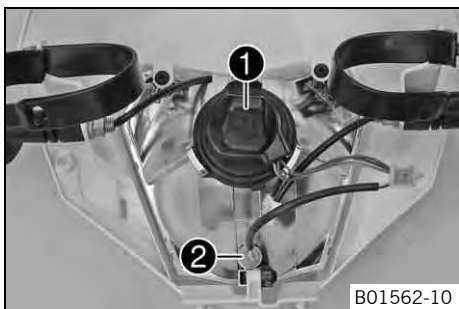

Preparatory work

- Remove the headlight mask with the headlight. (☛ p. 98)

Main work

- Turn protection cap ① together with the underlying bulb socket counterclockwise all the way and remove it.
- Pull bulb socket ② of the parking light out of the reflector.

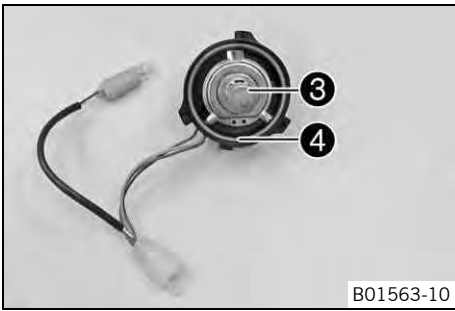

- Pull out headlight bulb ③.
- Insert the new headlight bulb.

Headlight (HS1 / socket PX43t) (☛ p. 122)

- Insert the protection cap with the bulb socket into the reflector and turn it clockwise all the way.



Info

Ensure that O-ring ④ is seated properly.

- Insert the bulb socket of the parking light into the reflector.

Finishing work

- Refit the headlight mask with the headlight. (☛ p. 99)
- Check the headlight setting. (☛ p. 100)

15.9 Changing the turn signal bulb

Note

Damage to reflector Reduced brightness.

- Grease on the lamp will evaporate due to the heat and be deposited on the reflector. Clean the lamp and keep it free of grease before mounting.

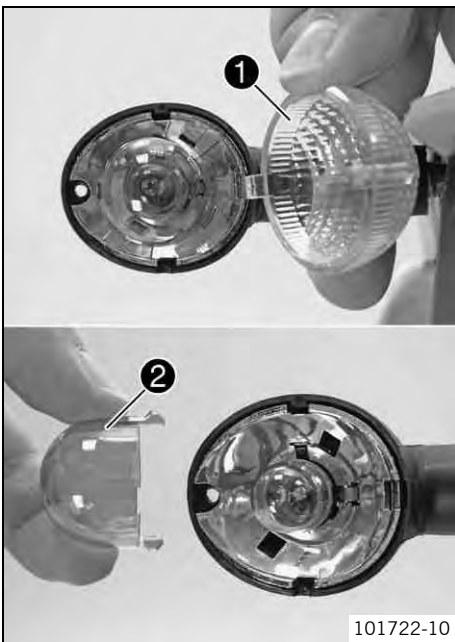

Main work
(all EXC models)

- Remove the screw on the rear of the turn signal housing.
- Carefully remove diffuser ①.
- Lightly squeeze orange cap ② in the area of the holding lugs and take it off.
- Press the turn signal bulb carefully into the socket, turn it counterclockwise by about 30°, and take it out of the socket.



Info

Do not touch the reflector with your fingers, and keep it free from grease.

- Press the new turn signal bulb carefully into the socket and turn it clockwise until it stops.

Turn signal (R10W / socket BA15s) (☛ p. 122)

- Mount the orange cap.
- Position the diffuser.
- Insert the screw and first turn it counterclockwise until it engages in the thread. Tighten the screw slightly.

Finishing work

- Check that the turn signal system is functioning properly.

15.10 Checking the headlight setting

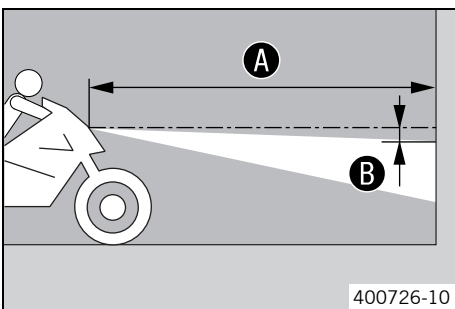

- Position the vehicle upright on a horizontal surface in front of a light wall and make a mark at the height of the center of the low beam headlight.
- Make another mark a distance ② under the first mark.

Guideline

Distance ②	5 cm (2 in)
------------	-------------

- Position the vehicle vertically a distance ④ away from the wall.

Guideline

Distance ④	5 m (16 ft)
------------	-------------

- The rider now sits down on the motorcycle.
- Switch on the low beam.
- Check the headlight setting.

The boundary between light and dark must be exactly on the lower mark for a motorcycle with driver.

- » If the light-dark border does not meet specifications:
 - Adjust the headlight range. (☛ p. 101)

15.11 Adjusting the headlight range

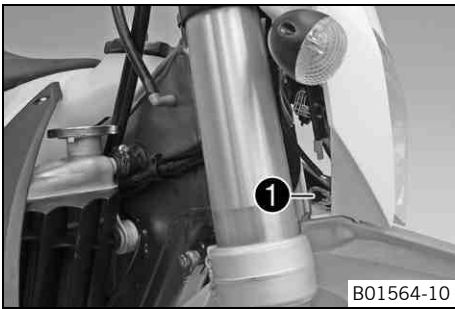

Preparatory work

- Check the headlight setting. (☛ p. 100)

Main work

- Loosen screw ❶.
- Adjust the headlight range of the headlight by moving it up or down.

Guideline

The boundary between light and dark must be exactly on the lower mark for a motorcycle with driver (instructions on how to apply the mark: Checking the headlight setting).



Info

A change in weight on the vehicle may require a correction of the headlight range.

- Tighten screw ❶.

15.12 Changing the speedometer battery

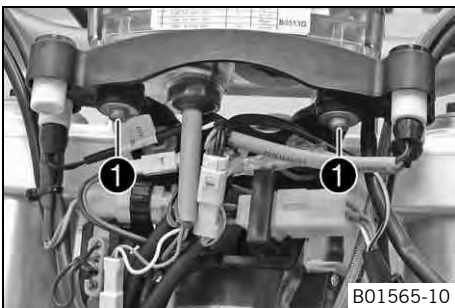

Preparatory work

- Remove the headlight mask with the headlight. (☛ p. 98)

Main work

(EXC EU, EXC AUS, all XC-W models)

- Remove screws ❶.
- Pull the speedometer upward out of the holder.

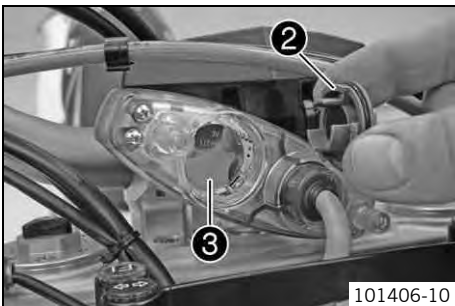

- Using a coin, turn protection cap ❷ all the way counterclockwise and remove it.
- Remove speedometer battery ❸.
- Insert the new battery with the label facing upward.

Speedometer battery (CR 2430) (☛ p. 122)

- Check the O-ring of the protection cap for correct seating.

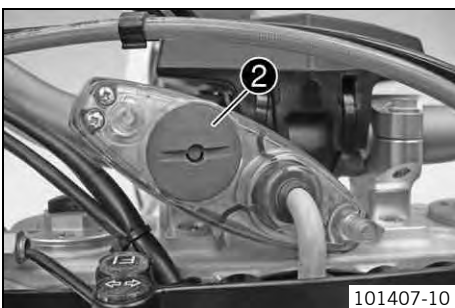

- Position protection cap ❷ and turn all the way clockwise using a coin.
- Press any button on the speedometer.
- ✓ The speedometer is activated.
- Position the speedometer in the holder.
- Mount and tighten the screws with washers.

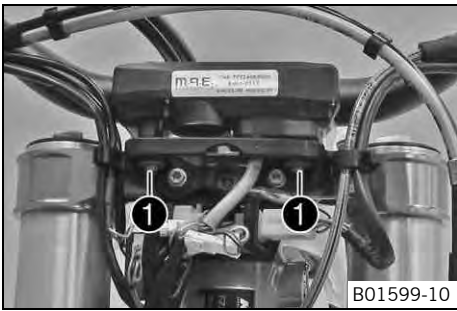

(EXC SIX DAYS)

- Remove screws ❶.
- Pull the speedometer upward out of the holder.

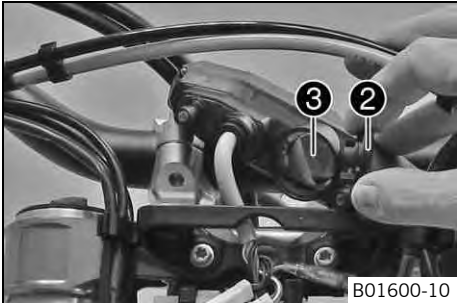

- Using a coin, turn protection cap ❷ all the way counterclockwise and remove it.
- Remove speedometer battery ❸.
- Insert the new battery with the label facing upward.

Speedometer battery (CR 2430) (☛ p. 122)

- Check the O-ring of the protection cap for correct seating.

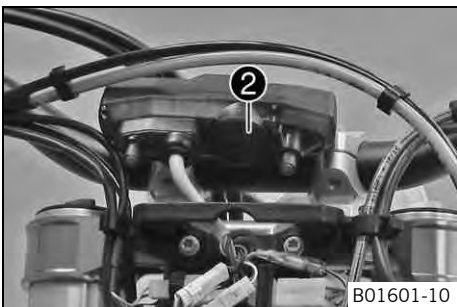

- Position protection cap ❷ and turn all the way clockwise using a coin.
- Press any button on the speedometer.
- ✓ The speedometer is activated.
- Position the speedometer in the holder.
- Mount and tighten the screws with washers.

Finishing work

- Refit the headlight mask with the headlight. (☛ p. 99)
- Check the headlight setting. (☛ p. 100)
- Set kilometers or miles. (☛ p. 21)
- Adjust the speedometer functions. (☛ p. 22)
- Set the clock. (☛ p. 22)

16.1 Cooling system

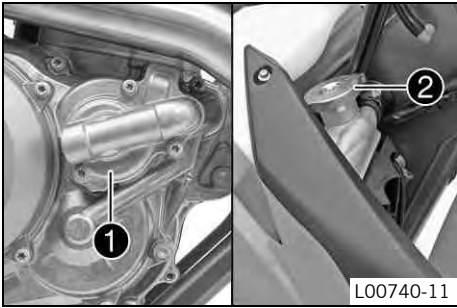

Water pump ❶ in the engine circulates the coolant. The pressure resulting from the warming of the cooling system is regulated by a valve in radiator cap ❷. This ensures that operating the vehicle at the specified coolant temperature will not result in a risk of malfunctions.

120 °C (248 °F)

Cooling is effected by the air stream. The lower the speed, the less the cooling effect. Dirty cooling fins also reduce the cooling effect. The radiator fan provides extra cooling. It is controlled by a thermostwitch.

16.2 Checking the antifreeze and coolant level

Warning
Danger of scalding During motorcycle operation, the coolant gets very hot and is under pressure.

- Do not remove the radiator cap, radiator hoses or other cooling system components when the engine is hot. Allow the engine and cooling system to cool down. In case of scalding, rinse immediately with lukewarm water.

Warning
Danger of poisoning Coolant is poisonous and a health hazard.

- Coolant must not come into contact with the skin, eyes, or clothing. If contact occurs with the eyes, rinse with water immediately and contact a physician. Immediately clean contaminated areas on the skin with soap and water. If coolant is swallowed, contact a physician immediately. Change clothing that is contaminated with coolant. Keep coolant out of reach of children.

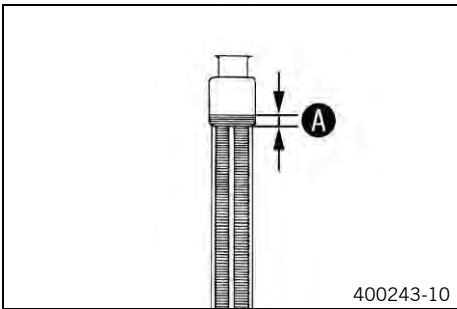

Condition
 The engine is cold.

- Stand the motorcycle upright on a horizontal surface.
- Remove the radiator cap.
- Check antifreeze of coolant.

-25... -45 °C (-13... -49 °F)

- » If the antifreeze of the coolant does not meet specifications:
 - Correct the antifreeze of the coolant.

- Check the coolant level in the radiator.

Coolant level ❶ above radiator fins.	10 mm (0.39 in)
--------------------------------------	-----------------

- » If the coolant level does not meet specifications:
 - Correct the coolant level.

Alternative 1

Coolant (☞ p. 126)

Alternative 2

Coolant (mixed ready to use) (☞ p. 126)

- Mount the radiator cap.

16.3 Checking the coolant level

Warning
Danger of scalding During motorcycle operation, the coolant gets very hot and is under pressure.

- Do not remove the radiator cap, radiator hoses or other cooling system components when the engine is hot. Allow the engine and cooling system to cool down. In case of scalding, rinse immediately with lukewarm water.

Warning
Danger of poisoning Coolant is poisonous and a health hazard.

- Coolant must not come into contact with the skin, eyes, or clothing. If contact occurs with the eyes, rinse with water immediately and contact a physician. Immediately clean contaminated areas on the skin with soap and water. If coolant is swallowed, contact a physician immediately. Change clothing that is contaminated with coolant. Keep coolant out of reach of children.

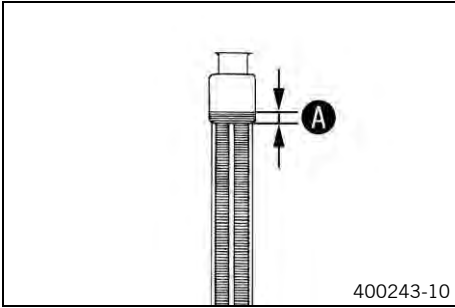

Condition

The engine is cold.

- Stand the motorcycle upright on a horizontal surface.
- Remove the radiator cap.
- Check the coolant level in the radiator.

Coolant level A above radiator fins.	10 mm (0.39 in)
---	-----------------

- » If the coolant level does not meet specifications:
 - Correct the coolant level.

Alternative 1

Coolant (☛ p. 126)

Alternative 2

Coolant (mixed ready to use) (☛ p. 126)

- Mount the radiator cap.

16.4 Draining the coolant ☛



Warning

Danger of scalding During motorcycle operation, the coolant gets very hot and is under pressure.

- Do not remove the radiator cap, radiator hoses or other cooling system components when the engine is hot. Allow the engine and cooling system to cool down. In case of scalding, rinse immediately with lukewarm water.



Warning

Danger of poisoning Coolant is poisonous and a health hazard.

- Coolant must not come into contact with the skin, eyes, or clothing. If contact occurs with the eyes, rinse with water immediately and contact a physician. Immediately clean contaminated areas on the skin with soap and water. If coolant is swallowed, contact a physician immediately. Change clothing that is contaminated with coolant. Keep coolant out of reach of children.

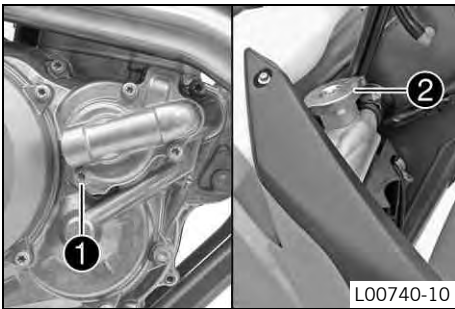

Condition

The engine is cold.

- Position the motorcycle upright.
- Place a suitable container under the water pump cover.
- Remove screw **1**. Take off radiator cap **2**.
- Completely drain the coolant.
- Mount and tighten screw **1** with a new seal ring.

Guideline

Screw, water pump cover	M6x25	10 Nm (7.4 lbf ft)
-------------------------	-------	--------------------

16.5 Refilling coolant ☛



Warning

Danger of poisoning Coolant is poisonous and a health hazard.

- Coolant must not come into contact with the skin, eyes, or clothing. If contact occurs with the eyes, rinse with water immediately and contact a physician. Immediately clean contaminated areas on the skin with soap and water. If coolant is swallowed, contact a physician immediately. Change clothing that is contaminated with coolant. Keep coolant out of reach of children.

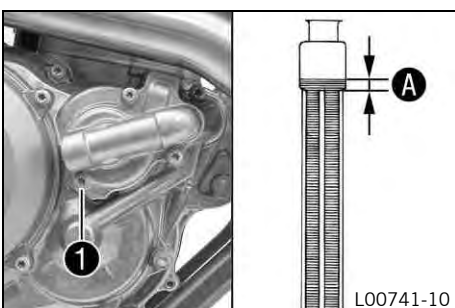

Main work

- Make sure that the screw **1** is tightened.
- Stand the vehicle upright.
- Pour coolant in up to measurement **A** above the radiator fins.

Guideline

10 mm (0.39 in)

Coolant	1.2 l (1.3 qt.)	Coolant (☛ p. 126)
---------	-----------------	--------------------

Coolant	1.2 l (1.3 qt.)	Coolant (mixed ready to use) (☛ p. 126)
---------	-----------------	--

- Refit the radiator cap.

Finishing work

- Take a short test ride.
- Check the coolant level. (☛ p. 103)

17.1 Checking the play in the throttle cable

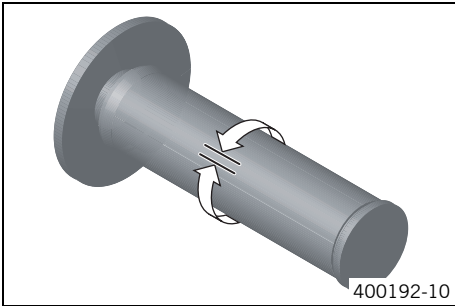

- Check the throttle grip for smooth operation.
- Move the handlebar to the straight-ahead position. Move the throttle grip backwards and forwards to ascertain the play in the throttle cable.

Play in throttle cable	3... 5 mm (0.12... 0.2 in)
------------------------	----------------------------

- » If the throttle cable play does not meet specifications:
 - Adjust the play in the throttle cable. 🛠️ (👉 p. 106)



Danger

Danger of poisoning Exhaust gases are toxic and inhaling them may result in unconsciousness and/or death.

- When running the engine, always make sure there is sufficient ventilation, and do not start or run the engine in an enclosed space without an effective exhaust extraction system.

- Start the engine and let it run idle. Move the handlebar to and fro over the entire steering range.

The idle speed must not change.

- » If the idle speed changes:
 - Adjust the play in the throttle cable. 🛠️ (👉 p. 106)

17.2 Adjusting the play in the throttle cable 🛠️

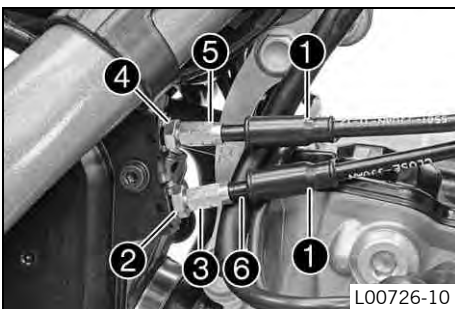

Preparatory work

- Remove the seat. (👉 p. 67)
- Remove the fuel tank. 🛠️ (👉 p. 71)
- Check the throttle cable routing. (👉 p. 77)

Main work

- Move the handlebar to the straight-ahead position.
- Push back sleeves ❶.
- Loosen nut ❷. Turn adjusting screw ❸ in as far as possible.
- Loosen nut ❹. Turn adjusting screw ❺ so that there is play in the throttle cable at the throttle grip.

Guideline

Play in throttle cable	3... 5 mm (0.12... 0.2 in)
------------------------	----------------------------

- Tighten nut ❹.
- Press and hold the throttle grip in the closed setting. Turn adjusting screw ❸ out until there is no play in throttle cable ❻.
- Tighten nut ❷.
- Push sleeves ❶ on. Check the throttle grip for smooth operation.

Finishing work

- Install the fuel tank. 🛠️ (👉 p. 72)
- Mount the seat. (👉 p. 68)
- Check the play in the throttle cable. (👉 p. 106)

17.3 Adjusting the idle speed

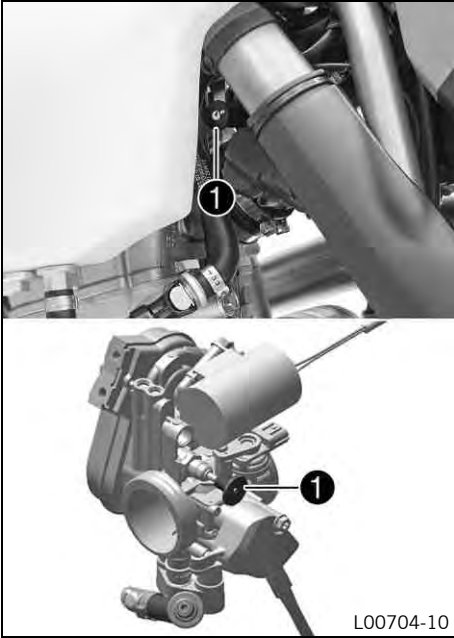

- Run the engine warm and push the idle speed adjusting screw ❶ all the way in.
- Set the desired idle speed by turning the idle speed adjusting screw.

Guideline

Idle speed	1,950... 2,050 rpm
------------	--------------------

i Info

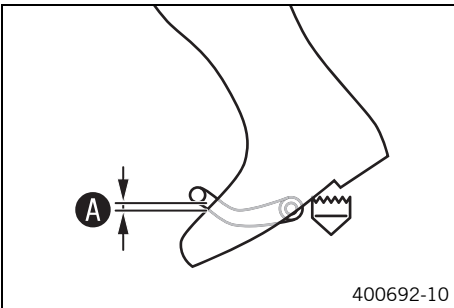

Turn counterclockwise to increase the idle speed.
Turn clockwise to decrease the idle speed.

17.4 Checking the basic position of the shift lever



- Sit on the vehicle in the riding position and determine the distance ❶ between the upper edge of your boot and the shift lever.

Gap between the shift lever and the top of the boot	10... 20 mm (0.39... 0.79 in)
---	-------------------------------

- » If the distance does not meet the specifications:
 - Adjust the basic position of the shift lever.  ( p. 107)

17.5 Adjusting the basic position of the shift lever

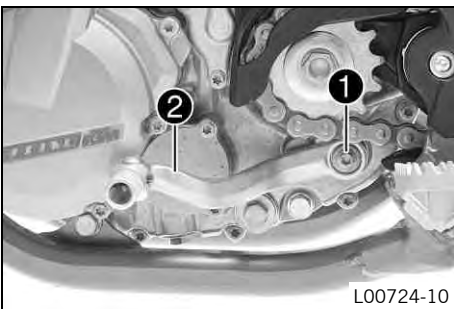

- Remove screw ❶ and take off shift lever ❷.

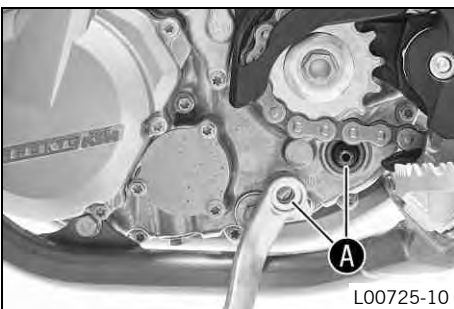

- Clean gear teeth ❶ of the shift lever and shift shaft.
- Mount the shift lever on the shift shaft in the required position and engage the gearing.

i Info

The range of adjustment is limited.
The shift lever must not come into contact with any other vehicle components during the shift procedure.

- Mount and tighten the screw.

Guideline

Screw, shift lever	M6	14 Nm (10.3 lbf ft)	Loctite® 243™
--------------------	----	------------------------	---------------

18.1 Changing the fuel screen

Danger
Fire hazard Fuel is highly flammable.

- Never refuel the vehicle near open flames or burning cigarettes, and always switch off the engine first. Be careful that no fuel is spilt, especially on hot vehicle components. Clean up spilt fuel immediately.
- The fuel in the fuel tank expands when warm and may emerge if overfilled. Follow the instructions on refueling.

Warning
Danger of poisoning Fuel is poisonous and a health hazard.

- Fuel must not come into contact with the skin, eyes, or clothing. Do not breathe in the fuel vapors. If contact occurs with the eyes, rinse with water immediately and contact a physician. Immediately clean contaminated areas on the skin with soap and water. If fuel is swallowed, contact a physician immediately. Change clothing that is contaminated with fuel.

 **Warning**
Environmental hazard Improper handling of fuel is a danger to the environment.

- Do not allow fuel to get into the ground water, the ground, or the sewage system.

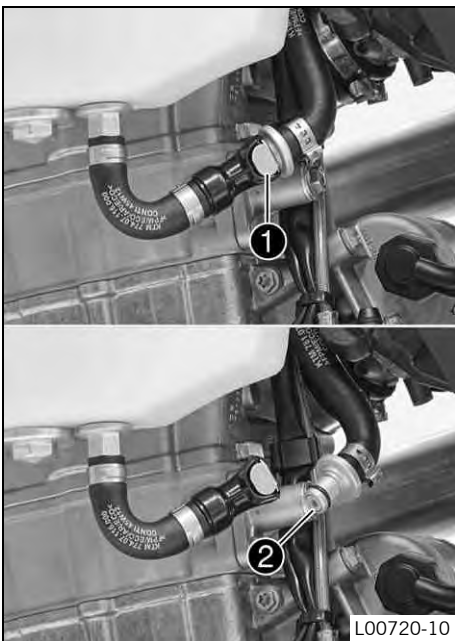

- Clean the plug-in connection ❶ of the fuel line thoroughly with compressed air.

i Info
 Under no circumstances should dirt enter into the fuel line. Dirt in the fuel line clogs the injection valve.

- Disconnect the plug-in connection ❶ of the fuel line.
- Pull fuel screen ❷ out of the connecting piece.
- Insert the new fuel screen all the way into the connecting piece.
- Lubricate the O-ring and connect plug-in connection of the fuel line.

! Danger
Danger of poisoning Exhaust gases are toxic and inhaling them may result in unconsciousness and/or death.

- When running the engine, always make sure there is sufficient ventilation, and do not start or run the engine in an enclosed space without an effective exhaust extraction system.

- Start the motor and check the response.

18.2 Checking the engine oil level

Condition
 The engine is at operating temperature.

Preparatory work
 - Stand the motorcycle upright on a horizontal surface.

Main work
 - Check the engine oil level.

i Info
 After switching off the engine, wait one minute before checking the level.

The engine oil level is between **A** and **B**.

- » When the engine oil level is below the **A** marking:
 - Add engine oil. (🔧 p. 111)
- » When the engine oil level is at or above the **B** marking:
 - Correct the engine oil level.



18.3 Changing the engine oil and oil filter, cleaning the oil screens

Warning
Danger of scalding Engine oil and gear oil get very hot when the motorcycle is ridden.
 – Wear appropriate protective clothing and safety gloves. In case of burns, rinse immediately with lukewarm water.

Warning
Environmental hazard Hazardous substances cause environmental damage.
 – Oil, grease, filters, fuel, cleaners, brake fluid, etc., should be disposed of as stipulated in applicable regulations.

Info
 Drain the engine oil only when the engine is warm.

**Preparatory work
 (EXC SIX DAYS, EXC AUS)**

- Remove the engine guard. ( p. 80)
- Park the motorcycle on a level surface.

Main work

- Place a suitable container under the engine.
- Remove oil drain plug **1** with the magnet and seal ring.

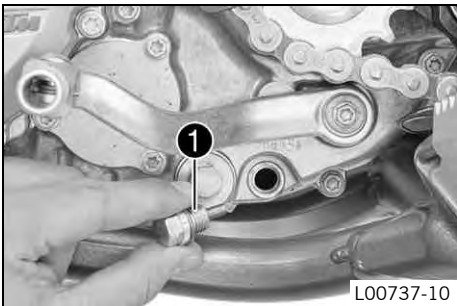

- Remove screw plug **2** with the gear oil screen and the O-rings.

Info
 Do not remove screw **A**.

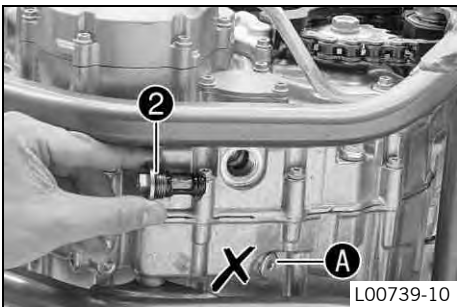

- Remove screw plug **3** with engine oil screen **4** and the O-rings.
- Completely drain the engine oil.
- Thoroughly clean the parts and sealing surfaces.

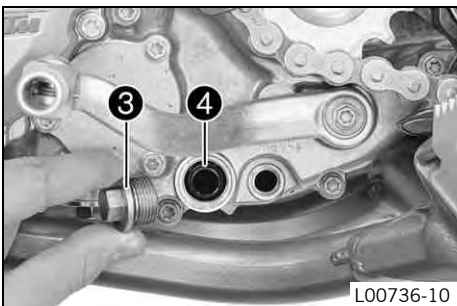

- Mount and tighten screw plug **2** with the gear oil screen and the O-rings.

Guideline

Screw plug, gear oil screen	M20x1.5	15 Nm (11.1 lbf ft)
-----------------------------	---------	------------------------

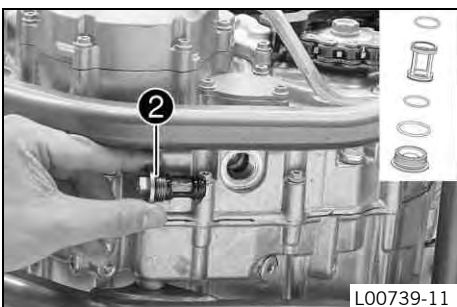

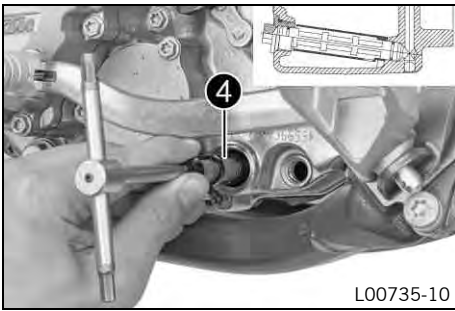

- Push the engine oil screen 4 with the O-rings onto a pin wrench.
- Push the pin wrench through the opening into the drill hole of the opposite engine case wall and push the oil screen as far as possible into the engine case.

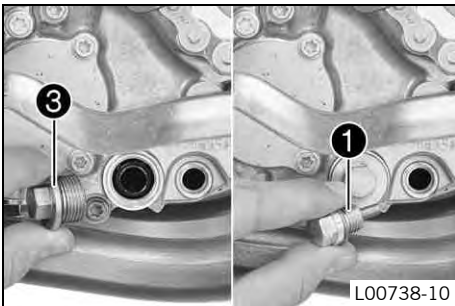

- Mount and tighten screw plug 3 with the O-ring.

Guideline

Screw plug, engine oil screen	M20x1.5	15 Nm (11.1 lbf ft)
-------------------------------	---------	------------------------

- Mount and tighten the oil drain plug 1 with the magnet and a new seal ring.

Guideline

Oil drain plug with magnet	M12x1.5	20 Nm (14.8 lbf ft)
----------------------------	---------	------------------------

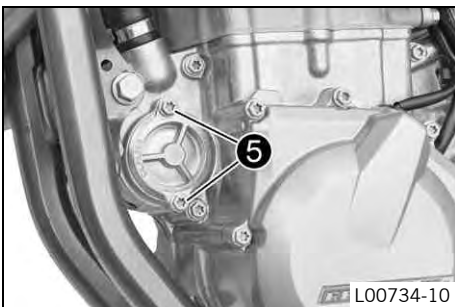

- Remove screws 5. Remove the oil filter cover with the O-ring.

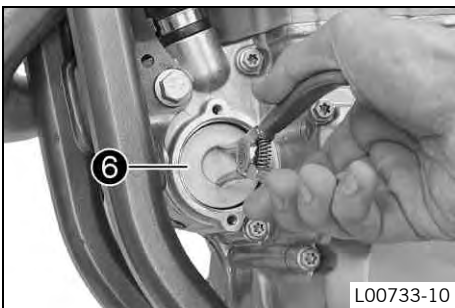

- Pull oil filter 6 out of the oil filter housing.

Circlip pliers reverse (51012011000)

- Completely drain the engine oil.
- Thoroughly clean the parts and sealing area.

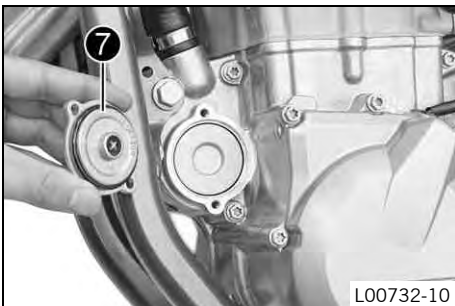

- Lay the motorcycle on its side and fill the oil filter housing to about 1/3 full with engine oil.
- Insert the oil filter into the oil filter housing.
- Oil the O-ring of the oil filter cover and mount it with the oil filter cover 7.
- Mount and tighten the screws.

Guideline

Screw, oil filter cover	M5	6 Nm (4.4 lbf ft)
-------------------------	----	-------------------

- Stand the motorcycle upright.



- Remove the oil filler plug 8 with the O-ring from the clutch cover and fill up with engine oil.

Engine oil	1.20 l (1.27 qt.)	Engine oil (SAE 10W/50) (☛ p. 126)	Engine oil (SAE 10W/60) (00062010035) (☛ p. 126)
		Alternative engine oil for harsh operating conditions and increased performance	

i Info

Too little engine oil or poor-quality engine oil results in premature wear to the engine.

- Install and tighten the oil filler plug with O-ring.



Danger

Danger of poisoning Exhaust gases are toxic and inhaling them may result in unconsciousness and/or death.

- When running the engine, always make sure there is sufficient ventilation, and do not start or run the engine in an enclosed space without an effective exhaust extraction system.

- Start the engine and check that it is oil-tight.

**Finishing work
(EXC SIX DAYS, EXC AUS)**

- Install the engine guard. (☛ p. 80)
- Check the engine oil level. (☛ p. 108)

18.4 Adding engine oil



Info

Too little engine oil or poor-quality engine oil results in premature wear to the engine.

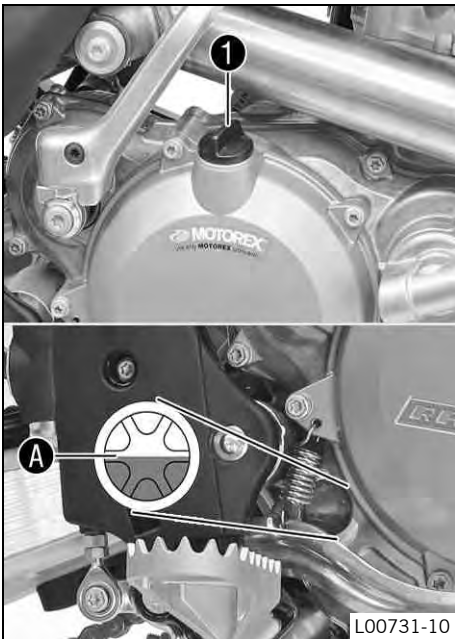

Main work

- Remove the oil filler plug ❶ with the O-ring from the clutch cover.
- Fill engine oil to the middle ❷ of the level viewer.

Engine oil (SAE 10W/50) (☛ p. 126)

Alternative 1

Engine oil (SAE 10W/60) (00062010035) (☛ p. 126)



Info

For optimal performance of the engine oil, do not mix different types of engine oil.
If appropriate, change the engine oil.

- Install and tighten the oil filler plug with O-ring.



Danger

Danger of poisoning Exhaust gases are toxic and inhaling them may result in unconsciousness and/or death.

- When running the engine, always make sure there is sufficient ventilation, and do not start or run the engine in an enclosed space without an effective exhaust extraction system.

- Start the engine and check that it is oil-tight.

Finishing work

- Check the engine oil level. (☛ p. 108)

19.1 Cleaning the motorcycle

Note

Material damage Damage and destruction of components by high-pressure cleaning equipment.

- When cleaning the vehicle with a pressure cleaner, do not point the water jet directly onto electrical components, connectors, cables, bearings, etc. Maintain a minimum distance of 60 cm between the nozzle of the pressure cleaner and the component. Excessive pressure can cause malfunctions or destroy these parts.

 **Warning**

Environmental hazard Hazardous substances cause environmental damage.

- Oil, grease, filters, fuel, cleaners, brake fluid, etc., should be disposed of as stipulated in applicable regulations.

 **Info**

If you clean the motorcycle regularly, its value and appearance will be maintained over a long period. Avoid direct sunshine on the motorcycle during cleaning.

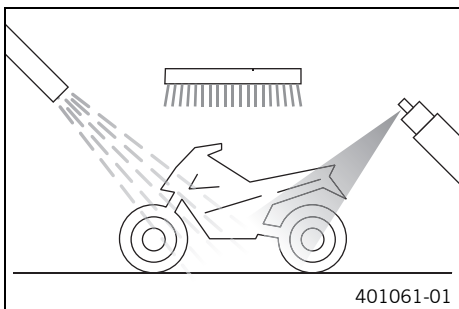

- Close off the exhaust system to prevent water from entering.
- First remove coarse dirt particles with a gentle spray of water.
- Spray very dirty areas with a normal motorcycle cleaner and then clean with a paintbrush.

Motorcycle cleaner (☛ p. 128)

 **Info**

Use warm water containing normal motorcycle cleaner and a soft sponge. Never apply motorcycle cleaner to the dry vehicle; always rinse with water first.

- After rinsing the motorcycle with a gentle spray of water, allow it to dry thoroughly.
- Remove the plug from the exhaust system.

 **Warning**

Danger of accidents Reduced braking efficiency due to a wet or dirty brake system.

- Clean or dry a dirty or wet brake system by riding and braking gently.

- After cleaning, ride a short distance until the engine reaches operating temperature.

 **Info**

The heat produced causes water at inaccessible locations in the engine and brake system to evaporate.

- After the motorcycle has cooled off, lubricate all moving parts and bearings.
- Clean the chain. (☛ p. 74)
- Treat bare metal parts (except for brake discs and exhaust system) with anti-corrosion materials.

Cleaning and preserving materials for metal, rubber and plastic (☛ p. 128)

- Treat all plastic parts and powder-coated parts with a mild cleaning and care product.

Paint cleaner and polish for high-gloss and matte finishes, bare metal and plastic surfaces (☛ p. 129)

19.2 Checks and maintenance steps for winter operation

- i Info**
If the motorcycle is used in the winter, salt can be expected on the roads. Precautions need to be taken against road salt corrosion.
If the vehicle was operated in road salt, clean it with cold water after riding. Warm water would enhance the corrosive effects of salt.

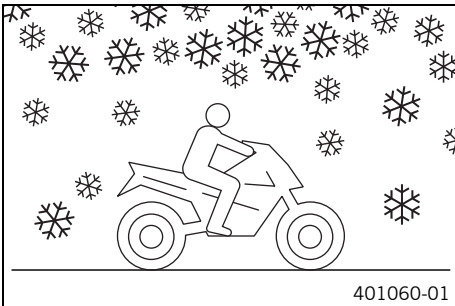

- Clean the motorcycle. (☛ p. 112)
- Clean the brake system.

- i Info**
After **EVERY** trip on salted roads, thoroughly wash the brake calipers and brake linings with cold water and dry carefully. This should be done after the parts are cooled down and while they are installed.
After riding on salted roads, thoroughly wash the motorcycle with cold water and dry it well.

- Treat the engine, swingarm, and all other bright and zinc-plated parts (except for the brake discs) with a wax-based corrosion inhibitor.

- i Info**
Corrosion inhibitor is not permitted to come in contact with the brake discs as this would greatly reduce the braking force.

- Clean the chain. (☛ p. 74)

20.1 Storage



Warning

Danger of poisoning Fuel is poisonous and a health hazard.

- Fuel must not come into contact with the skin, eyes, or clothing. Do not breathe in the fuel vapors. If contact occurs with the eyes, rinse with water immediately and contact a physician. Immediately clean contaminated areas on the skin with soap and water. If fuel is swallowed, contact a physician immediately. Change clothing that is contaminated with fuel. Store fuel properly in a suitable canister and keep away from children.



Info

If you want to garage the motorcycle for a longer period, take the following steps. Before storing the motorcycle, check all parts for function and wear. If service, repairs or replacements are necessary, you should do this during the storage period (less workshop overload). In this way, you can avoid long workshop waiting times at the start of the new season.

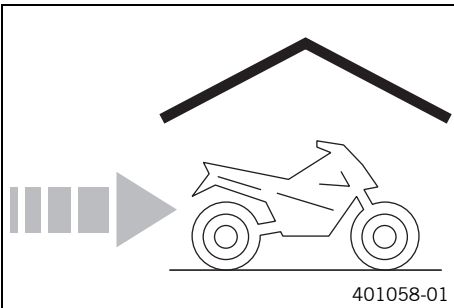

- When refueling for the last time before taking the motorcycle out of service, add fuel additive.

Fuel additive (☞ p. 128)

- Refuel. (☞ p. 45)
- Clean the motorcycle. (☞ p. 112)
- Change the engine oil and oil filter and clean the oil screens. 🛠️ (☞ p. 109)
- Check the antifreeze and coolant level. (☞ p. 103)
- Check the tire air pressure. (☞ p. 93)
- Remove the battery. 🛠️ (☞ p. 95)
- Charge the battery. 🛠️ (☞ p. 96)

Guideline

Storage temperature of battery without direct sunlight	0... 35 °C (32... 95 °F)
--	--------------------------

- Store the vehicle in a dry location that is not subject to large fluctuations in temperature.



Info

KTM recommends raising the motorcycle.

- Raise the motorcycle with the lift stand. (☞ p. 56)
- Cover the motorcycle with a porous sheet or blanket. Do not use non-porous materials since they prevent humidity from escaping, thus causing corrosion.



Info

Avoid running the engine for a short time only. Since the engine cannot warm up properly, the water vapor produced during combustion condenses and causes valves and exhaust system to rust.



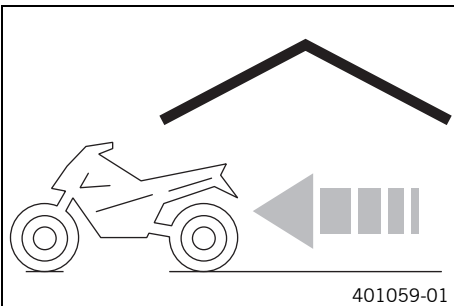







20.2 Preparing for use after storage



- Remove the motorcycle from the lift stand. (☞ p. 56)
- Install the battery. 🛠️ (☞ p. 95)
- Perform checks and maintenance work when preparing the vehicle for use. (☞ p. 42)
- Take a test ride.

Faults	Possible cause	Action
The engine cannot be cranked (electric starter)	Operating error	– Carry out the start procedure. (☞ p. 42)
	Battery is discharged	– Charge the battery. 🛠️ (☞ p. 96) – Check the charging voltage. 🛠️ – Check the closed current. 🛠️ – Check the stator winding of the alternator. 🛠️
	Main fuse blown	– Change the main fuse. (☞ p. 97)
	Starter relay defective	– Check the starter relay. 🛠️
	Starter motor defective	– Check the starter motor. 🛠️
Engine turns but does not start	Operating error	– Carry out the start procedure. (☞ p. 42)
	Coupling of fuel hose connection not joined together	– Join the fuel hose connection.
	Fuse 1 blown	– Change the fuses of individual power consumers. (☞ p. 98)
	Fuse 2 blown	– Change the fuses of individual power consumers. (☞ p. 98)
	Idle speed is not set correctly	– Adjust the idle speed. 🛠️ (☞ p. 107)
	Spark plug oily or wet	– Clean and dry the spark plug or replace if necessary.
	Electrode distance (plug gap) of spark plug too wide	– Adjust the plug gap. Guideline Spark plug electrode gap 0.9 mm (0.035 in)
	Ignition system defective	– Check the ignition system. 🛠️
	Short-circuit cable in wiring harness frayed, kill switch or emergency OFF switch defective	– Check the wiring harness. (visual check) – Check the electrical system.
Defect in fuel injection system	– Read out the fault memory using the KTM diagnostics tool. 🛠️	
Engine does not speed up	Defect in fuel injection system	– Read out the fault memory using the KTM diagnostics tool. 🛠️
	Ignition system defective	– Ignition coil - check the secondary winding. 🛠️ – Check the spark plug connector. 🛠️ – Check the stator winding of the alternator. 🛠️
Engine has too little power	Air filter heavily contaminated	– Clean the air filter and air filter box. 🛠️ (☞ p. 69)
	Fuel filter is very dirty	– Change the fuel filter. 🛠️
	Fuel screen is very dirty	– Change the fuel screen. 🛠️ (☞ p. 108)
	Defect in fuel injection system	– Read out the fault memory using the KTM diagnostics tool. 🛠️
	Exhaust system leaky, deformed or too little glass fiber yarn filling in main silencer	– Check exhaust system for damage. – Change the glass fiber yarn filling of the main silencer. 🛠️ (☞ p. 70)
	Valve clearance too little	– Adjust the valve clearance. 🛠️
	Ignition system defective	– Ignition coil - check the secondary winding. 🛠️ – Check the spark plug connector. 🛠️ – Check the stator winding of the alternator. 🛠️
Engine dies during the trip	Lack of fuel	– Refuel. (☞ p. 45)
	Fuse 1 blown	– Change the fuses of individual power consumers. (☞ p. 98)
	Fuse 2 blown	– Change the fuses of individual power consumers. (☞ p. 98)
Engine overheats	Coolant level low in cooling system	– Check the cooling system for leaks. – Check the coolant level. (☞ p. 103)
	Insufficient airflow	– Switch off engine when stationary.
	Radiator fins very dirty	– Clean radiator fins.

Faults	Possible cause	Action
Engine overheats	Foam formation in cooling system	<ul style="list-style-type: none"> – Drain the coolant. 🛠️ (📖 p. 104) – Refill the coolant. 🛠️ (📖 p. 104)
	Bent radiator hose	– Change the radiator hose. 🛠️
	Thermostat defective	<ul style="list-style-type: none"> – Check the thermostat. 🛠️ <p>Guideline Opening temperature: 70 °C (158 °F)</p>
	Defect in radiator fan system	<ul style="list-style-type: none"> – Check the radiator fan fuse. – Check fuse 4. – Check the radiator fan. 🛠️
FI warning lamp (MIL) lights up/flashes	Defect in fuel injection system	<ul style="list-style-type: none"> – Stop the motorcycle and identify the faulty part using the blink code. <hr/> <p>i Info See blink code</p> <hr/> <ul style="list-style-type: none"> – Check the cabling for damage and the electrical plug-in connections for corrosion and damage. – Read out the fault memory using the KTM diagnostics tool. 🛠️
High oil consumption	Engine vent hose bent	– Route the vent hose without bends or replace it if necessary.
	Engine oil level too high	– Check the engine oil level. (📖 p. 108)
	Engine oil too thin (low viscosity)	– Change the engine oil and oil filter and clean the oil screens. 🛠️ (📖 p. 109)
	Piston and cylinder worn	– Measure the piston/cylinder mounting clearance. 🛠️
Battery discharged	Battery is not being charged by alternator	<ul style="list-style-type: none"> – Check the charging voltage. 🛠️ – Check the stator winding of the alternator. 🛠️
	Undesired power consumer	– Check the closed current. 🛠️
Speedometer values deleted (time, stop watch, lap times)	The battery in the speedometer is discharged	– Change the speedometer battery. (📖 p. 101)
The high beam, low beam, parking light, tail light, and license plate lamp are not working	Fuse 3 blown	– Change the fuses of individual power consumers. (📖 p. 98)
The speedometer, horn, brake light, turn signal, and radiator fan are not working	Fuse 4 blown	– Change the fuses of individual power consumers. (📖 p. 98)

Blink code FI warning lamp (MIL)	 02 FI warning lamp (MIL) flashes 2x short
Error level condition	Crankshaft position sensor - circuit fault
Blink code FI warning lamp (MIL)	 06 FI warning lamp (MIL) flashes 6x short
Error level condition	Throttle position sensor circuit A - input signal too low Throttle position sensor circuit A - input signal too high
Blink code FI warning lamp (MIL)	 09 FI warning lamp (MIL) flashes 9x short
Error level condition	Manifold absolute pressure sensor cylinder 1 - input signal too low Manifold absolute pressure sensor cylinder 1 - input signal too high
Blink code FI warning lamp (MIL)	 12 FI warning lamp (MIL) flashes 1x long, 2x short
Error level condition	Engine coolant temperature sensor - input signal too low Engine coolant temperature sensor - input signal too high
Blink code FI warning lamp (MIL)	 13 FI warning lamp (MIL) flashes 1x long, 3x short
Error level condition	Intake air temperature sensor - input signal too low Intake air temperature sensor - input signal too high
Blink code FI warning lamp (MIL)	 15 FI warning lamp (MIL) flashes 1x long, 5x short
Error level condition	Rollover sensor (A/D type) - input signal too low Rollover sensor (A/D type) - input signal too high
Blink code FI warning lamp (MIL)	 17 FI warning lamp (MIL) flashes 1x long, 7x short
Error level condition	EXC EU, EXC SIX DAYS Lambda sensor cylinder 1, sensor 1 - circuit fault
Blink code FI warning lamp (MIL)	 33 FI warning lamp (MIL) flashes 3x long, 3x short
Error level condition	Injector cylinder 1 - circuit fault
Blink code FI warning lamp (MIL)	 37 FI warning lamp (MIL) flashes 3x long, 7x short
Error level condition	Ignition coil 1, cylinder 1 - circuit fault
Blink code FI warning lamp (MIL)	 41 FI warning lamp (MIL) flashes 4x long, 1x short
Error level condition	Fuel pump control - open/short circuit to ground Fuel pump control - input signal too low

Blink code FI warning lamp (MIL)	 45 FI warning lamp (MIL) flashes 4x long, 5x short
Error level condition	EXC EU, EXC SIX DAYS Lambda sensor heater cylinder 1, sensor 1 - short circuit to ground or open circuit Lambda sensor heater cylinder 1, sensor 1 - input signal too high

23.1 Engine

Design	1-cylinder 4-stroke engine, water-cooled
Displacement (all 450 models)	449.3 cm ³ (27.418 cu in)
Displacement (all 500 models)	510.4 cm ³ (31.147 cu in)
Stroke (all 450 models)	63.4 mm (2.496 in)
Stroke (all 500 models)	72 mm (2.83 in)
Bore	95 mm (3.74 in)
Compression ratio	11,8:1
Idle speed	1,950... 2,050 rpm
Control	OHC, 4 valves controlled via rocker arm, drive via tooth/wheel chain
Valve diameter, intake	40 mm (1.57 in)
Valve diameter, exhaust	33 mm (1.3 in)
Valve clearance	
Exhaust at: 20 °C (68 °F)	0.12... 0.17 mm (0.0047... 0.0067 in)
Intake at: 20 °C (68 °F)	0.10... 0.15 mm (0.0039... 0.0059 in)
Crankshaft bearing	2 grooved ball bearings
Conrod bearing	Slide bearing
Piston pin bearing	No bearing bushes - DLC-plated piston pins
Pistons	Forged light alloy
Piston rings	1 compression ring, 1 oil scraper ring
Engine lubrication	Pressure circulation lubrication with two rotary pumps
Primary transmission	32:76
Clutch	Multidisc clutch in oil bath / hydraulically activated
Transmission ratio	
1st gear	14:36
2nd gear	17:32
3rd gear	19:28
4th gear	22:26
5th gear	24:23
6th gear	26:21
Alternator	12 V, 200 W
Ignition	Contactless controlled fully electronic ignition with digital ignition adjustment, type Kokusan
Spark plug	NGK LKAR 8AI - 9
Spark plug electrode gap	0.9 mm (0.035 in)
Cooling	Water, permanent circulation of coolant by water pump
Starter	Electric starter/kick starter

23.2 Engine tightening torques

Oil jet, piston cooling	M4	2 Nm (1.5 lbf ft)	Loctite® 243™
Screw, cable holder in alternator cover	M4	4 Nm (3 lbf ft)	Loctite® 243™
Oil jet, piston cooling	M5	2 Nm (1.5 lbf ft)	Loctite® 243™
Oil jet, rocker arm lubrication	M5	2 Nm (1.5 lbf ft)	Loctite® 243™
Screw, bearing retainer	M5	6 Nm (4.4 lbf ft)	Loctite® 2701™
Screw, clutch spring retainer	M5	6 Nm (4.4 lbf ft)	–
Screw, ignition pulse generator	M5	6 Nm (4.4 lbf ft)	Loctite® 243™
Screw, locking lever	M5	6 Nm (4.4 lbf ft)	Loctite® 243™
Screw, oil filter cover	M5	6 Nm (4.4 lbf ft)	–
Screw, oil pump cover	M5	6 Nm (4.4 lbf ft)	Loctite® 243™
Screw, stator	M5	6 Nm (4.4 lbf ft)	Loctite® 243™

Nut, water pump impeller	M6	8 Nm (5.9 lbf ft)	Loctite® 243™
Plug, vacuum connection	M6	2.5 Nm (1.84 lbf ft)	Loctite® 243™
Screw, alternator cover	M6x25	10 Nm (7.4 lbf ft)	–
Screw, camshaft bearing support	M6	10 Nm (7.4 lbf ft)	Loctite® 243™
Screw, clutch cover	M6x25	10 Nm (7.4 lbf ft)	–
Screw, cylinder head	M6	10 Nm (7.4 lbf ft)	–
Screw, engine case	M6x40	10 Nm (7.4 lbf ft)	–
Screw, engine case	M6x60	10 Nm (7.4 lbf ft)	–
Screw, engine case	M6x75	10 Nm (7.4 lbf ft)	–
Screw, engine case	M6x80	10 Nm (7.4 lbf ft)	–
Screw, engine case	M6x85	10 Nm (7.4 lbf ft)	–
Screw, exhaust flange	M6	10 Nm (7.4 lbf ft)	Loctite® 243™
Screw, idler	M6	10 Nm (7.4 lbf ft)	Loctite® 243™
Screw, kick starter spring hanger	M6	10 Nm (7.4 lbf ft)	Loctite® 243™
Screw, kick starter stop	M6	10 Nm (7.4 lbf ft)	Loctite® 243™
Screw, oil pump cover	M6	10 Nm (7.4 lbf ft)	Loctite® 243™
Screw, shift drum locating	M6	10 Nm (7.4 lbf ft)	Loctite® 243™
Screw, shift lever	M6	14 Nm (10.3 lbf ft)	Loctite® 243™
Screw, starter motor	M6	10 Nm (7.4 lbf ft)	–
Screw, timing chain guide rail	M6	10 Nm (7.4 lbf ft)	Loctite® 243™
Screw, timing chain securing guide	M6	10 Nm (7.4 lbf ft)	Loctite® 243™
Screw, timing chain tensioner	M6	10 Nm (7.4 lbf ft)	–
Screw, timing chain tensioning rail	M6	10 Nm (7.4 lbf ft)	Loctite® 243™
Screw, torque governor	M6	10 Nm (7.4 lbf ft)	Loctite® 243™
Screw, valve cover	M6	10 Nm (7.4 lbf ft)	–
Screw, water pump cover	M6x25	10 Nm (7.4 lbf ft)	–
Screw, water pump cover	M6x55	10 Nm (7.4 lbf ft)	–
Oil jet for balancer shaft lubrication	M6x0.75	4 Nm (3 lbf ft)	–
Oil nozzle for conrod bearing lubrication	M6x0.75	4 Nm (3 lbf ft)	–
Plug, oil channel	M7	9 Nm (6.6 lbf ft)	Loctite® 243™
Screw, rocker arm bearing	M7x1	15 Nm (11.1 lbf ft)	–
Plug, crankshaft location	M8	10 Nm (7.4 lbf ft)	–
Screw, kick starter	M8	25 Nm (18.4 lbf ft)	Loctite® 2701™
Plug, timing chain tensioner	M8x1	8 Nm (5.9 lbf ft)	–
Plug, oil drilling	M10	15 Nm (11.1 lbf ft)	Loctite® 243™
Screw, engine sprocket	M10	60 Nm (44.3 lbf ft)	Loctite® 2701™
Screw, cylinder head	M10x1.25	Tightening sequence: Tighten diagonally, beginning with the rear screw on the timing chain shaft. Step 1 10 Nm (7.4 lbf ft) Step 2 30 Nm (22.1 lbf ft) Step 3 50 Nm (36.9 lbf ft)	Lubricated with engine oil
Nut, rotor	M12x1	60 Nm (44.3 lbf ft)	–
Spark plug	M12x1.25	15... 20 Nm (11.1... 14.8 lbf ft)	–
Engine coolant temperature sensor	M12x1.5	12 Nm (8.9 lbf ft)	–
Oil drain plug with magnet	M12x1.5	20 Nm (14.8 lbf ft)	–
Oil pressure control valve plug	M12x1.5	20 Nm (14.8 lbf ft)	–
Plug, rocker arm	M14x1.25	20 Nm (14.8 lbf ft)	–

Nut, inner clutch hub	M18x1.5	80 Nm (59 lbf ft)	–
Nut, primary gear	M20LHx1.5	100 Nm (73.8 lbf ft)	Loctite® 648™
Screw plug, engine oil screen	M20x1.5	15 Nm (11.1 lbf ft)	–
Screw plug, gear oil screen	M20x1.5	15 Nm (11.1 lbf ft)	–

23.3 Capacities

23.3.1 Capacity - engine oil

Engine oil	1.20 l (1.27 qt.)	Engine oil (SAE 10W/50) (☛ p. 126)
		Alternative engine oil for harsh operating conditions and increased performance
		Engine oil (SAE 10W/60) (00062010035) (☛ p. 126)

23.3.2 Capacity - coolant

Coolant	1.2 l (1.3 qt.)	Coolant (☛ p. 126)
		Coolant (mixed ready to use) (☛ p. 126)

23.3.3 Capacity - fuel

Total fuel tank capacity, approx. (all EXC models)	9 l (2.4 US gal)	Super unleaded (ROZ 95/RON 95/PON 91) (☛ p. 127)
Total fuel tank capacity, approx. (all XC-W models)	8.5 l (2.25 US gal)	Super unleaded (ROZ 95/RON 95/PON 91) (☛ p. 127)
Fuel reserve, approx.	1.5 l (1.6 qt.)	

23.4 Chassis

Frame	Central tube frame made of chrome molybdenum steel tubing	
Fork (EXC EU, EXC AUS, all XC-W models)	WP Suspension Up Side Down 4860 MXMA PA	
Fork (EXC SIX DAYS)	WP Suspension Up Side Down 4860 4CS	
Suspension travel		
Fork offset	20 mm (0.79 in)	
Shock absorber	WP Suspension PDS 5018 DCC	
Brake system	Disc brakes, brake calipers on floating bearings	
Brake discs - diameter		
Front	260 mm (10.24 in)	
Rear	220 mm (8.66 in)	
Brake discs - wear limit		
Front	2.5 mm (0.098 in)	
Rear	3.5 mm (0.138 in)	
Tire air pressure off road		
Front	1.0 bar (15 psi)	
Rear	1.0 bar (15 psi)	
Road tire pressure (all EXC models)		
Front	1.5 bar (22 psi)	
Rear	1.5 bar (22 psi)	
Final drive (all 450 EXC models)	14:52 (13:52)	
Final drive (all 500 EXC models)	14:50 (13:50)	
Final drive (450 XC-W USA)	14:52 (13:52)	
Final drive (500 XC-W USA)	14:50 (13:50)	
Chain	5/8 x 1/4"	
Rear sprockets available	38, 40, 42, 45, 48, 49, 50, 51, 52	
Steering head angle	63.5°	
Wheelbase	1,482±10 mm (58.35±0.39 in)	

Seat height unloaded	970 mm (38.19 in)
Ground clearance unloaded	345 mm (13.58 in)
Homologated weight without fuel, approx. (all 450 EXC models)	112.0 kg (246.9 lb.)
Homologated weight without fuel, approx. (all 500 EXC models)	112.5 kg (248 lb.)
Weight without fuel, approx. (450 XC-W USA)	111.0 kg (244.7 lb.)
Weight without fuel, approx. (500 XC-W USA)	111.5 kg (245.8 lb.)
Maximum permissible front axle load	145 kg (320 lb.)
Maximum permissible rear axle load	190 kg (419 lb.)
Maximum permissible overall weight	335 kg (739 lb.)

23.5 Electrical system

Battery	YTX5L-BS	Battery voltage: 12 V Nominal capacity: 4 Ah Maintenance-free
Speedometer battery	CR 2430	Battery voltage: 3 V
Fuse	58011109105	5 A
Fuse	75011088010	10 A
Fuse	58011109120	20 A
Headlight	HS1 / socket PX43t	12 V 35/35 W
Parking light	W5W / socket W2.1x9.5d	12 V 5 W
Indicator lamps	W2.3W / socket W2x4.6d	12 V 2.3 W
Turn signal (all EXC models)	R10W / socket BA15s	12 V 10 W
Brake/tail light	LED	
License plate lamp (all EXC models)	W5W / socket W2.1x9.5d	12 V 5 W

23.6 Tires

Validity	Front tires	Rear tires
(all EXC models)	80/100 - 21 M/C 51M TT MAXXIS MAXX CROSS SI	140/80 - 18 M/C 70R TT MAXXIS MAXX ENDURO
(all XC-W models)	80/100 - 21 51M TT Dunlop GEOMAX MX51FA	110/100 - 18 64M TT Dunlop GEOMAX MX51

Additional information is available in the Service section under:
<http://www.ktm.com>

23.7 Fork

23.7.1 EXC EU, EXC AUS, all XC-W models

Fork part number	14.18.7L.69
Fork	WP Suspension Up Side Down 4860 MXMA PA
Compression damping	
Comfort	22 clicks
Standard	20 clicks
Sport	18 clicks
Rebound damping	
Comfort	20 clicks
Standard	18 clicks
Sport	16 clicks
Spring preload - Preload Adjuster	
Comfort	1 turn

Standard	2 turns	
Sport	2 turns	
Spring length with preload spacer(s)		
Weight of rider: 65... 75 kg (143... 165 lb.)	513 mm (20.2 in)	
Weight of rider: 75... 85 kg (165... 187 lb.)	513 mm (20.2 in)	
Weight of rider: 85... 95 kg (187... 209 lb.)	513 mm (20.2 in)	
Spring rate		
Weight of rider: 65... 75 kg (143... 165 lb.)	4.2 N/mm (24 lb/in)	
Weight of rider: 75... 85 kg (165... 187 lb.)	4.4 N/mm (25.1 lb/in)	
Weight of rider: 85... 95 kg (187... 209 lb.)	4.6 N/mm (26.3 lb/in)	
Fork length	940 mm (37.01 in)	
Air chamber length	110 ⁺¹⁰ / ₋₂₀ mm (4.33 ^{+0.39} / _{-0.79} in)	
Fork oil per fork leg	618 ml (20.89 fl. oz.)	Fork oil (SAE 4) (48601166S1) (☛ p. 127)

23.7.2 EXC SIX DAYS

Fork part number	24.18.7N.69	
Fork	WP Suspension Up Side Down 4860 4CS	
Compression damping		
Comfort	15 clicks	
Standard	13 clicks	
Sport	11 clicks	
Rebound damping		
Comfort	15 clicks	
Standard	13 clicks	
Sport	11 clicks	
Spring length with preload spacer(s)	472 mm (18.58 in)	
Spring rate		
Weight of rider: 65... 75 kg (143... 165 lb.)	4.2 N/mm (24 lb/in)	
Weight of rider: 75... 85 kg (165... 187 lb.)	4.4 N/mm (25.1 lb/in)	
Weight of rider: 85... 95 kg (187... 209 lb.)	4.6 N/mm (26.3 lb/in)	
Fork length	932 mm (36.69 in)	
Oil capacity per fork leg	635 ml (21.47 fl. oz.)	Fork oil (SAE 4) (48601166S1) (☛ p. 127)

23.8 Shock absorber

Shock absorber part number	12.18.7L.69	
Shock absorber	WP Suspension PDS 5018 DCC	
Compression damping, low-speed		
Comfort	25 clicks	
Standard	20 clicks	
Sport	15 clicks	
Compression damping, high-speed		
Comfort	2 turns	
Standard	1.5 turns	
Sport	1.25 turns	
Rebound damping		
Comfort	28 clicks	
Standard	24 clicks	
Sport	22 clicks	
Spring preload		
Comfort	9 mm (0.35 in)	
Standard	9 mm (0.35 in)	

Sport	9 mm (0.35 in)
Spring rate	
Weight of rider: 65... 75 kg (143... 165 lb.)	69 N/mm (394 lb/in)
Weight of rider: 75... 85 kg (165... 187 lb.)	72 N/mm (411 lb/in)
Weight of rider: 85... 95 kg (187... 209 lb.)	76 N/mm (434 lb/in)
Spring length	250 mm (9.84 in)
Gas pressure	10 bar (145 psi)
Static sag	33... 35 mm (1.3... 1.38 in)
Riding sag	105... 115 mm (4.13... 4.53 in)
Fitted length	417 mm (16.42 in)
Damper oil	Shock absorber oil (SAE 2.5) (50180342S1) (☛ p. 127)

23.9 Chassis tightening torques

Screw, pressure regulator	EJOT PT®	3 Nm (2.2 lbf ft)	–
Spoke nipple, front wheel	M4.5	5... 6 Nm (3.7... 4.4 lbf ft)	–
Spoke nipple, rear wheel	M4.5	5... 6 Nm (3.7... 4.4 lbf ft)	–
Screw, battery terminal	M5	2.5 Nm (1.84 lbf ft)	–
Screw, intake air temperature sensor	M5	2 Nm (1.5 lbf ft)	–
Screw, shock absorber adjusting ring	M5	5 Nm (3.7 lbf ft)	–
Screw, spoiler on fuel tank (all XC-W models)	M5x12	1.5 Nm (1.11 lbf ft)	–
Nut, cable on starter motor	M6	4 Nm (3 lbf ft)	–
Remaining nuts, chassis	M6	10 Nm (7.4 lbf ft)	–
Remaining screws, chassis	M6	10 Nm (7.4 lbf ft)	–
Screw, ball joint of push rod on foot brake cylinder	M6	10 Nm (7.4 lbf ft)	Loctite® 243™
Screw, chain sliding guard	M6	6 Nm (4.4 lbf ft)	Loctite® 243™
Screw, front brake disc	M6	14 Nm (10.3 lbf ft)	Loctite® 243™
Screw, rear brake disc	M6	14 Nm (10.3 lbf ft)	Loctite® 243™
Screw, throttle grip	M6	5 Nm (3.7 lbf ft)	–
Fuel connection on fuel pump	M8	10 Nm (7.4 lbf ft)	–
Nut, foot brake lever stop	M8	20 Nm (14.8 lbf ft)	–
Nut, rear sprocket screw	M8	35 Nm (25.8 lbf ft)	Loctite® 2701™
Nut, rim lock	M8	12 Nm (8.9 lbf ft)	–
Remaining nuts, chassis	M8	25 Nm (18.4 lbf ft)	–
Remaining screws, chassis	M8	25 Nm (18.4 lbf ft)	–
Screw, bottom triple clamp (EXC SIX DAYS)	M8	15 Nm (11.1 lbf ft)	–
Screw, bottom triple clamp (EXC EU, EXC AUS, all XC-W models)	M8	15 Nm (11.1 lbf ft)	–
Screw, chain sliding piece	M8	15 Nm (11.1 lbf ft)	–
Screw, engine brace	M8	33 Nm (24.3 lbf ft)	–
Screw, fork stub	M8	15 Nm (11.1 lbf ft)	–
Screw, front brake caliper	M8	25 Nm (18.4 lbf ft)	Loctite® 243™
Screw, handlebar clamp	M8	20 Nm (14.8 lbf ft)	–
Screw, side stand attachment	M8	45 Nm (33.2 lbf ft)	Loctite® 2701™
Screw, subframe	M8	35 Nm (25.8 lbf ft)	Loctite® 2701™
Screw, top steering stem (EXC SIX DAYS)	M8	17 Nm (12.5 lbf ft)	Loctite® 243™
Screw, top steering stem (EXC EU, EXC AUS, all XC-W models)	M8	20 Nm (14.8 lbf ft)	–
Screw, top triple clamp (EXC SIX DAYS)	M8	17 Nm (12.5 lbf ft)	–

Screw, top triple clamp (EXC EU, EXC AUS, all XC-W models)	M8	20 Nm (14.8 lbf ft)	–
Engine attachment bolt	M10	60 Nm (44.3 lbf ft)	–
Remaining nuts, chassis	M10	45 Nm (33.2 lbf ft)	–
Remaining screws, chassis	M10	45 Nm (33.2 lbf ft)	–
Screw, handlebar holder	M10	40 Nm (29.5 lbf ft)	Loctite® 243™
Nut, fuel pump fixation	M12	15 Nm (11.1 lbf ft)	–
Screw, bottom shock absorber	M12	80 Nm (59 lbf ft)	Loctite® 2701™
Screw, top shock absorber	M12	80 Nm (59 lbf ft)	Loctite® 2701™
Nut, seat fixing	M12x1	20 Nm (14.8 lbf ft)	–
Nut, swingarm pivot	M16x1.5	100 Nm (73.8 lbf ft)	–
Nut, rear wheel spindle	M20x1.5	80 Nm (59 lbf ft)	–
Screw, top steering head	M20x1.5	12 Nm (8.9 lbf ft)	–
Screw-in nozzles, cooling system	M20x1.5	12 Nm (8.9 lbf ft)	Loctite® 243™
Screw, front wheel spindle	M24x1.5	45 Nm (33.2 lbf ft)	–

Brake fluid DOT 4 / DOT 5.1

According to

- DOT

Guideline

- Use only brake fluid that complies with the specified standard (see specifications on the container) and that possesses the corresponding properties. KTM recommends **Castrol** and **Motorex®** products.

Supplier

Castrol

- **RESPONSE BRAKE FLUID SUPER DOT 4**

Motorex®

- **Brake Fluid DOT 5.1**

Coolant

Guideline

- Use only suitable coolant (also in countries with high temperatures). Use of low-quality antifreeze can lead to corrosion and foaming. KTM recommends **Motorex®** products.

Mixture ratio

Antifreeze protection: -25... -45 °C (-13... -49 °F)	50 % corrosion inhibitor/antifreeze 50 % distilled water
--	---

Coolant (mixed ready to use)

Antifreeze	-40 °C (-40 °F)
------------	-----------------

Supplier

Motorex®

- **COOLANT G48**

Engine oil (SAE 10W/60) (00062010035)

According to

- JASO T903 MA (☛ p. 130)
- SAE (☛ p. 130) (SAE 10W/60)
- KTM LC4 2007+

Guideline

- Use only engine oils that comply with the specified standards (see specifications on the container) and that possess the corresponding properties. KTM recommends **Motorex®** products.

Synthetic engine oil

Supplier

Motorex®

- **Cross Power 4T**

Engine oil (SAE 10W/50)

According to

- JASO T903 MA (☛ p. 130)
- SAE (☛ p. 130) (SAE 10W/50)

Guideline

- Use only engine oils that comply with the specified standards (see specifications on the container) and that possess the corresponding properties. KTM recommends **Motorex®** products.

Synthetic engine oil

Supplier

Motorex®

- **Cross Power 4T**

Fork oil (SAE 4) (48601166S1)

According to

- SAE (☛ p. 130) (SAE 4)

Guideline

- Use only oils that comply with the specified standards (see specifications on the container) and that possess the corresponding properties.

Shock absorber oil (SAE 2.5) (50180342S1)

According to

- SAE (☛ p. 130) (SAE 2.5)

Guideline

- Use only oils that comply with the specified standards (see specifications on the container) and that possess the corresponding properties.

Super unleaded (ROZ 95/RON 95/PON 91)

According to

- DIN EN 228 (ROZ 95/RON 95/PON 91)

Guideline

- Only use unleaded super fuel that matches or is equivalent to the specified fuel grade.
- Fuel with an ethanol content of up to 10 % (E10 fuel) is safe to use.



Info

Do **not** use fuel containing methanol (e. g. M15, M85, M100) or more than 10 % ethanol (e. g. E15, E25, E85, E100).

Air filter cleaner

Guideline

- KTM recommends **Motorex®** products.

Supplier

Motorex®

- **Twin Air Dirt Bio Remover**

Chain cleaner

Guideline

- KTM recommends **Motorex®** products.

Supplier

Motorex®

- **Chain Clean**

Cleaning and preserving materials for metal, rubber and plastic

Guideline

- KTM recommends **Motorex®** products.

Supplier

Motorex®

- **Protect & Shine**

Fuel additive

Guideline

- KTM recommends **Motorex®** products.

Supplier

Motorex®

- **Fuel Stabilizer**

High viscosity grease

Guideline

- KTM recommends **SKF®** products.

Supplier

SKF®

- **LGHB 2**

Long-life grease

Guideline

- KTM recommends **Motorex®** products.

Supplier

Motorex®

- **Bike Grease 2000**

Motorcycle cleaner

Guideline

- KTM recommends **Motorex®** products.

Supplier

Motorex®

- **Moto Clean 900**

Off-road chain spray

Guideline

- KTM recommends **Motorex®** products.

Supplier

Motorex®

- **Chainlube Offroad**

Oil for foam air filter

Guideline

- KTM recommends **Motorex®** products.

Supplier

Motorex®

- **Twin Air Liquid Bio Power**

Paint cleaner and polish for high-gloss and matte finishes, bare metal and plastic surfaces

Guideline

- KTM recommends **Motorex®** products.

Supplier

Motorex®

- **Clean & Polish**

Rubber grip adhesive (00062030051)

Supplier

KTM-Sportmotorcycle AG

- **GRIP GLUE**

Universal oil spray

Guideline

- KTM recommends **Motorex®** products.

Supplier

Motorex®

- **Joker 440 Synthetic**

JASO T903 MA

Different technical development directions required a new specification for 4-stroke motorcycles – the JASO T903 MA Standard. Earlier, engine oils from the automobile industry were used for 4-stroke motorcycles because there was no separate motorcycle specification. Whereas long service intervals are demanded for automobile engines, high performance at high engine speeds are in the foreground for motorcycle engines. In most motorcycles, the gearbox and the clutch are lubricated with the same oil as the engine. The JASO MA Standard meets these special requirements.

SAE

The SAE viscosity classes were defined by the Society of Automotive Engineers and are used for classifying oils according to their viscosity. The viscosity describes only one property of oil and says nothing about quality.

A	
Accessories	9
Air filter	
cleaning	69
installing	69
removing	68
Air filter box	
cleaning	69
sealing	70
Air filter box lid	
installing	68
removing	68
Antifreeze	
checking	103
Auxiliary substances	9
B	
Basic suspension setting	
checking against the rider's weight	48
Battery	
charging	96
installing	95
removing	95
Blink code	117-118
Brake discs	
checking	82
Brake fluid	
front brake, adding	82
rear brake, adding	86
Brake fluid level	
front brake, checking	82
rear brake, checking	86
Brake linings	
front brake, changing	84
front brake, checking	83
rear brake, changing	88
rear brake, checking	87
Brake system	81-89
C	
Capacity	
coolant	104-105, 121
engine oil	110, 121
fuel	45, 121
Chain	
checking	75
cleaning	74
Chain guide	
checking	75
Chain tension	
adjusting	75
checking	74
Chassis number	12
Clutch	
fluid level, checking/correcting	79
fluid, changing	79

Clutch lever	14
basic position, adjusting	78
Compression damping	
fork, adjusting	52
Compression damping, high-speed	
shock absorber, adjusting	49
Compression damping, low-speed	
shock absorber, adjusting	48
Coolant	
draining	104
refilling	104
Coolant level	
checking	103
Cooling system	103
Customer service	9
D	
Difficult riding conditions	39
dry sand	40
high temperature	41
low temperature	41
muddy surfaces	41
slow speed	41
snow	41
wet sand	40
wet surfaces	41
E	
Electric starter button	16
Emergency OFF switch	15
Engine	
running-in	39
Engine guard	
installing	80
removing	80
Engine number	12
Engine oil	
adding	111
changing	109
Engine oil level	
checking	108
Engine sprocket	
checking	75
Environment	7
F	
Figures	9
Filler cap	
closing	17
opening	17
Filling up	
fuel	45
Foot brake lever	19
basic position, adjusting	85
free travel, checking	85
Fork	122-123
Fork legs	
basic setting, checking	52

bleeding	56
dust boots, cleaning	56
installing	58
removing	57
spring preload, adjusting	54
Fork protector	
installing	59
removing	59
Frame	
checking	77
Front fender	
installing	66
removing	66
Front wheel	
installing	90
removing	90
Fuel screen	
changing	108
Fuel tank	
installing	72
removing	71
Fuse	
individual power consumers, changing	98
main fuse, changing	97
H	
Hand brake lever	14
basic position, adjusting	81
free travel, adjusting	81
free travel, checking	81
Handlebar position	54
adjusting	54
Headlight	
headlight range, adjusting	101
Headlight bulb	
changing	99
Headlight mask with headlight	
installing	99
removing	98
Headlight setting	
checking	100
Horn button	15
I	
Idle speed	
adjusting	107
Idle speed adjusting screw	18
Intended use	6
K	
Key number	12
Kick starter	18
Kill switch	14
L	
Light switch	15
Lower triple clamp	
installing	61, 63
removing	59-60

M	
Main fuse	
changing	97
Main silencer	
glass fiber yarn filling, changing	70
installing	70
removing	70
Motorcycle	
cleaning	112
raising with lift stand	56
removing from lift stand	56
O	
Oil filter	
changing	109
Oil screens	
cleaning	109
Operating substances	9
Overview of indicator lamps	16
Owner's Manual	8
P	
Play in throttle cable	
checking	106
Preparing for use	
advice on first use	38
after storage	114
checks and maintenance work when preparing for use	42
Protective clothing	7
R	
Rear sprocket	
checking	75
Rear wheel	
installing	92
removing	91
Rebound damping	
fork, adjusting	53
shock absorber, adjusting	49
Riding sag	
adjusting	51
Rubber grip	
checking	78
securing	78
S	
Safe operation	7
Seat	
mounting	68
removing	67
Service	9
Service schedule	46-47
Shift lever	18
basic position, adjusting	107
basic position, checking	107
Shock absorber	
installing	67
removing	67

- riding sag, checking 50
- spring preload, adjusting 51
- static sag, checking 50
- Side stand** 19
- Spare parts** 9
- Speedometer**
 - adjusting 22
 - battery, changing 101
 - clock, setting 22, 30
 - kilometers or miles, setting 21, 29
 - setting 29
 - speedometer overview 21, 28
- Spoke tension**
 - checking 93
- Starting** 42
- Steering**
 - locking 19
 - unlocking 20
- Steering head bearing**
 - greasing 66
- Steering head bearing play**
 - adjusting 65
 - checking 64
- Storage** 114
- Swingarm**
 - checking 77

T

- Technical data**
 - capacities 121
 - chassis 121
 - chassis tightening torques 124
 - electrical system 122
 - engine 119
 - engine tightening torques 119
 - fork 122
 - shock absorber 123
 - tires 122
- Throttle cable play**
 - adjusting 106
- Throttle cable routing**
 - checking 77
- Throttle grip** 14
- Tire air pressure**
 - checking 93
- Tire condition**
 - checking 92
- Transport** 44
- Troubleshooting** 115-116
- Turn signal bulb**
 - changing 100
- Turn signal switch** 15
- Type label** 12

U

- Use definition** 6

V

- View of vehicle**
 - front left 10
 - rear right 11

W

- Warranty** 9
- Winter operation**
 - checks and maintenance steps 113
- Work rules** 7



3213037en

04/2013

