

1190 Adventure

Art. no. 3213424en



KTM

The work described in these setup instructions must be performed before the vehicle is delivered to the customer.

Read the setup instructions in their entirety before beginning work.

These setup instructions were written to correspond to the latest state of this series. We reserve the right to make changes in the interest of technical advancement without at the same time updating this manual.

We shall not provide a description of general workshop methods. Likewise, safety rules that apply in a workshop are not specified here. It is assumed that the work will be performed by a fully trained mechanic.

All specifications are non-binding. KTM Sportmotorcycle GmbH specifically reserves the right to modify or delete technical specifications, prices, colors, forms, materials, services, designs, equipment, etc., without prior notice and without specifying reasons, to adapt these to local conditions, as well as to stop production of a particular model without prior notice. KTM accepts no liability for delivery options, deviations from illustrations and descriptions, misprints, and other errors. The models portrayed partly contain special equipment that does not belong to the regular scope of supply.

© 2015 KTM Sportmotorcycle GmbH, Mattighofen Austria

All rights reserved

Reproduction, even in part, as well as copying of all kinds, is permitted only with the express written permission of the copyright owner.



ISO 9001(12 100 6061)

According to the international quality management standard ISO 9001, KTM uses quality assurance processes that lead to the maximum possible quality of the products.

Issued by: TÜV Management Service

REG.NO. 12 100 6061

KTM Sportmotorcycle GmbH

5230 Mattighofen, Austria

This document is valid for the following models:

1190 Adventure EU (F9903P4, F9903P5)

1190 Adventure FR (F9923P4, F9923P5)

1190 Adventure AU (F9960P4, F9960P5)

1190 Adventure JP (F9986P4, F9986P5)

1190 Adventure US (F9975P4, F9975P5)

1190 Adventure CN (F9987P5)



1.1 Symbols used

The meaning of specific symbols is described below.



Indicates an expected reaction (e.g. of a work step or a function).



Indicates an unexpected reaction (e.g. of a work step or a function).



Indicates a page reference (more information is provided on the specified page).



Indicates information with more details or tips.



Indicates the result of a testing step.



Denotes a voltage measurement.



Denotes a current measurement.



Denotes a resistance measurement.

1.2 Formats used

The typographical formats used in this document are explained below.

Proprietary name	Identifies a proprietary name.
Name[®]	Identifies a protected name.
Brand[™]	Identifies a trademark.
<u>Underlined terms</u>	Refer to technical details of the vehicle or indicate technical terms, which are explained in the glossary.

2.1 Unpacking and setting up the vehicle

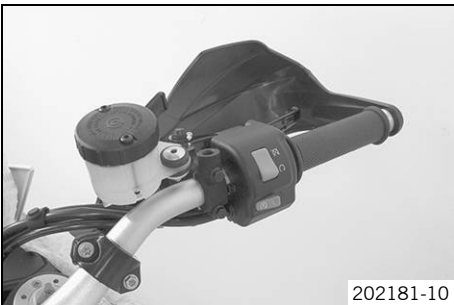
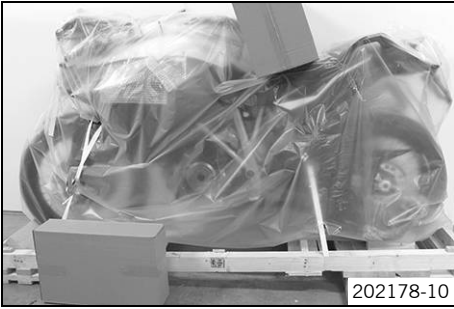

Preparatory work

- Remove the box.

Main work

- Remove the adhesive tape in the upper area of the motorcycle.

- Roll down the film at the sides.

i Info

To avoid damaging the motorcycle during unpacking, leave the other films on the vehicle until you have finished work on the vehicle.

- Remove the separate enclosure and unpack it. Check the separate enclosure for completeness.
- Check the vehicle for transport damage.
- Remove the controls from the transport holder. Remove the screws and handlebar clamps. Remove the transport holder.

- Remove the right hand guard.
- Position the controls on the right half of the handlebar. Tighten the screws.

Guideline

Remaining screws, chassis	M5	5 Nm (3.7 lbf ft)
Remaining chassis screws	M6	10 Nm (7.4 lbf ft)

- Mount the right hand guard.

- Position the handlebar.
 - ✓ The markings **1** of the scale of the handlebar are located centrally between the handlebar clamps.
- Position the handlebar clamps. Tighten the screws evenly.

Guideline

Screw, handlebar clamp	M8	20 Nm (14.8 lbf ft)
------------------------	----	---------------------

- ✓ The markings on the handlebar clamps point to the rear.
- Check the throttle grip for smooth operation.

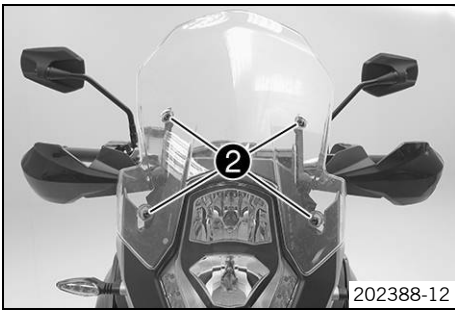

- Remove the film from the headlight. Position the windshield. Mount and tighten screws ②.

Guideline

Screw, wind shield	M5	3.5 Nm (2.58 lbf ft)
--------------------	----	-------------------------

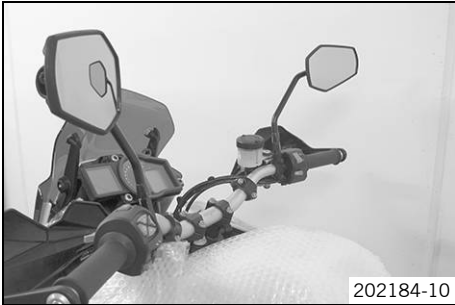

- Mount and tighten the rear mirror on both sides.

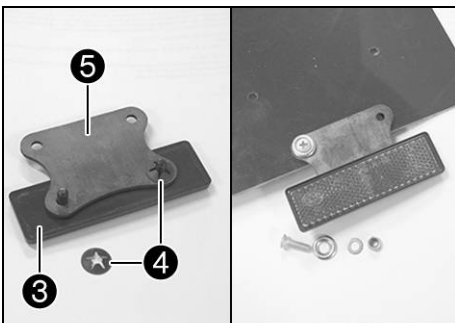

- Mount reflector ③ on retaining plate ⑤ with spring washers ④.
- Mount the retaining plate on the license plate holder. Mount the license plate holder.
- Carefully loosen and remove the tension belt over the swingarm.

i Info

An assistant prevents the motorcycle from falling over.

- Carefully loosen and remove the tension belts around the lower triple clamp.
 - ✓ The vehicle is released at the front.
- Together with an assistant, take the vehicle off the palette.

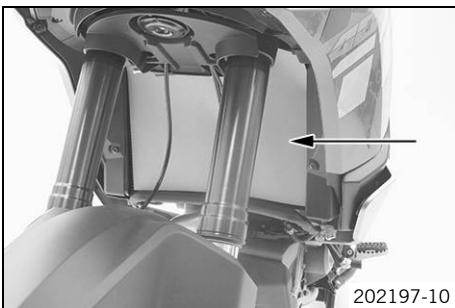
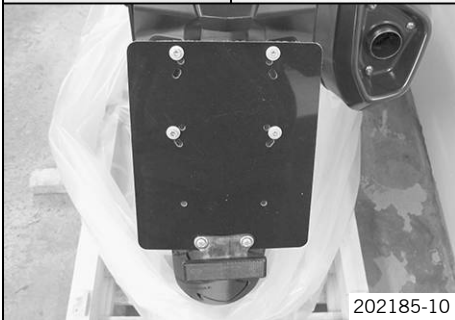

- Remove the radiator shield.

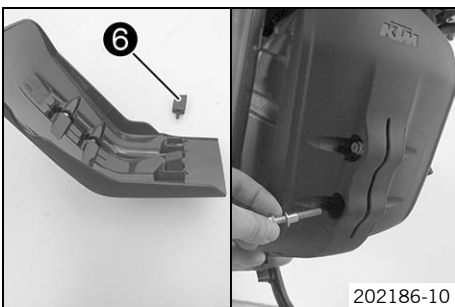

- Mount rubber dampers ⑥ on the engine guard.
- Position the engine guard. Mount and tighten the screws with the distance sleeves.

Guideline

Screw, engine guard	M6	10 Nm (7.4 lbf ft)
---------------------	----	--------------------

- Recharge the battery. (☛ p. 7)

(Adventure EU/FR/AU/JP)

- Store the tool set below the seat.
- Remove the remaining films.
- Refuel. (☛ p. 8)

- Prepare the vehicle according to the specifications in the **KTM Dealer.net** for handover to the customer.

3.1 Removing the passenger seat

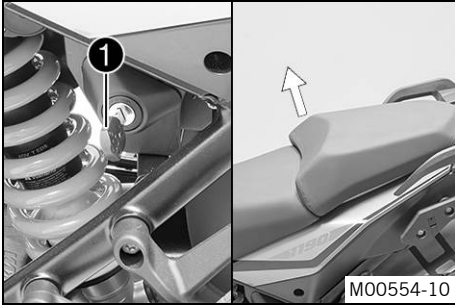

- Insert the ignition key in seat lock ❶ and turn it clockwise.
- Raise the front of the passenger seat, pull it toward the tank, and remove it upward.
- Remove the ignition key.

3.2 Mounting the passenger seat

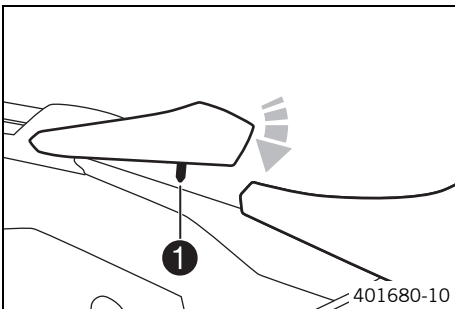

- Attach the hooks on the passenger seat to the brackets on the subframe, and lower at the front while pushing toward the rear.
- Insert locking pin ❶ into the lock housing and push down the front of the passenger seat until the locking pin engages with a click.
- Check that the passenger seat is correctly mounted.

3.3 Removing the driver's seat

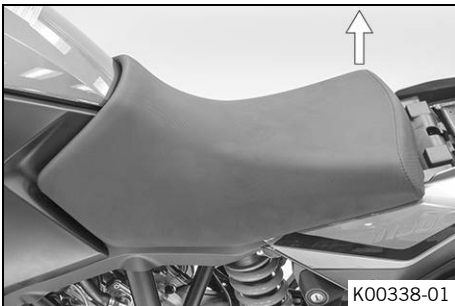

Preparatory work

- Remove the passenger seat. (☛ p. 6)

Main work

- Raise the rear of the driver's seat.
- Detach the front of the driver's seat and remove it.

3.4 Mounting the driver's seat

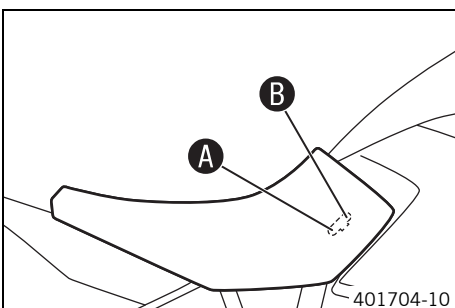

Main work

- Attach the recesses on the driver's seat to the fuel tank at the desired seat position **A** or **B**, and push the driver's seat forward while lowering it at the rear.
- Finally, check that the driver's seat is correctly mounted.

Finishing work

- Mount the passenger seat. (☛ p. 6)

3.5 Recharging the battery

- Warning**
Risk of injury Battery acid and battery gases cause serious chemical burns.
- Keep batteries out of the reach of children.
 - Wear suitable protective clothing and goggles.
 - Avoid contact with battery acid and battery gases.
 - Keep sparks and open flames away from the battery. Only charge in well-ventilated rooms.
 - In the event of skin contact, rinse with large amounts of water. If battery acid gets in the eyes, rinse with water for at least 15 minutes and contact a physician.

- Warning**
Environmental hazard The battery contains elements that are harmful to the environment.
- Do not dispose of batteries with the household waste. Dispose of a defective battery in an environmentally friendly manner. Give the battery to your authorized KTM dealer or dispose of it at a collection point for used batteries.

- Warning**
Environmental hazard Hazardous substances cause environmental damage.
- Oil, grease, filters, fuel, cleaners, brake fluid, etc., should be disposed of as stipulated in applicable regulations.

i Info
 Even when there is no load on the battery, it discharges steadily.
 The charge state and the type of charge are very important for the service life of the battery.
 Rapid recharging with a high charging current shortens the battery's service life.
 If the charging current, charging voltage, and charging time are exceeded, electrolyte escapes through the safety valves. This reduces the battery capacity.
 If the battery is depleted from starting the vehicle repeatedly, the battery must be charged immediately.
 If the battery is left in a discharged state for an extended period, it will become over-discharged and sulfate, destroying the battery.
 The battery is maintenance-free, i.e., the acid level does not have to be checked.
 If the battery is not charged using the KTM battery charger, the battery must be removed for charging. Otherwise, overvoltage may damage electronic components. Charge the battery according to the instructions on the battery housing.

Preparatory work

- Switch off all power consumers and switch off the engine.
- Remove the passenger seat. (☛ p. 6)
- Remove the driver's seat. (☛ p. 6)

Main work

- Pull locking mechanism ① in the direction of the arrow.
- Fold open cover ②.

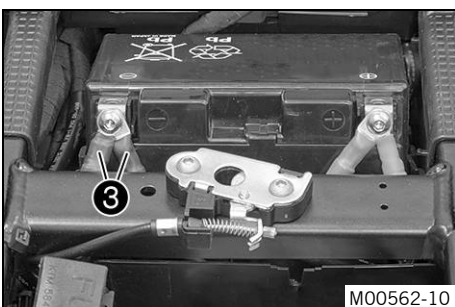
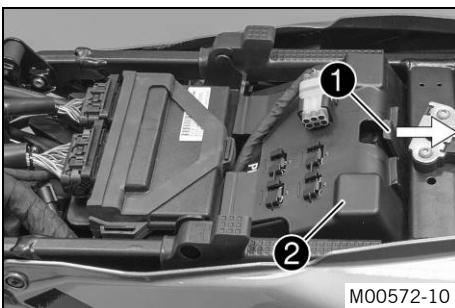

- Disconnect negative cable ③ of the battery to avoid damage to the motorcycle's electronics.



M00775-01

- Connect the battery charger to the battery. Switch on the battery charger.

Battery charger (58429074000)

i Info

You can also use the battery charger to test the open-circuit voltage and start potential of the battery, and to test the alternator. With this device, you cannot overcharge the battery. Charge the battery with a maximum of 10% of the capacity specified on the battery housing.

- Switch off the battery charger after charging and disconnect from the battery.

Guideline

The charging current, charging voltage, and charging time must not be exceeded.

Charge the battery regularly when the motorcycle is not in use	3 months
--	----------

- Connect both negative cables **3** with the battery.

Guideline

Screw, battery terminal	M6	4.5 Nm (3.32 lbf ft)
-------------------------	----	-------------------------

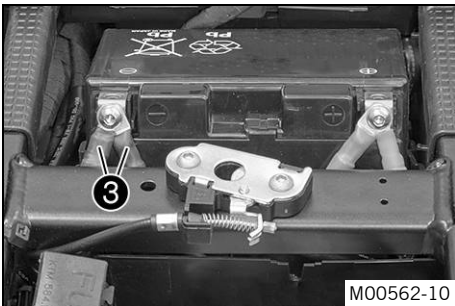

M00562-10

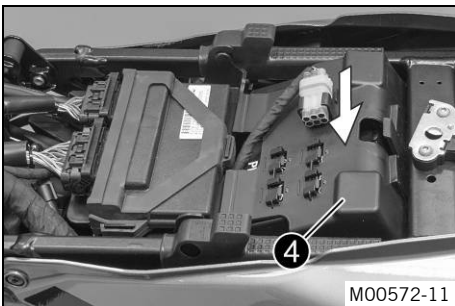

M00572-11

- Close cover **4** and push down slightly.
✓ The cover engages with an audible click.

Finishing work

- Mount the driver's seat. (☛ p. 6)
- Mount the passenger seat. (☛ p. 6)
- Set the time and date.

3.6 Refueling



Danger

Fire hazard Fuel is highly flammable.

- Never refuel the vehicle near open flames or burning cigarettes, and always switch off the engine first. Be careful that no fuel is spilt, especially on hot vehicle components. Clean up spilt fuel immediately.
- The fuel in the fuel tank expands when warm and may emerge if overfilled. Follow the instructions on refueling.



Warning

Danger of poisoning Fuel is poisonous and a health hazard.

- Fuel must not come into contact with the skin, eyes, or clothing. Do not breathe in the fuel vapors. If contact occurs with the eyes, rinse with water immediately and contact a physician. Immediately clean contaminated areas on the skin with soap and water. If fuel is swallowed, contact a physician immediately. Change clothing that is contaminated with fuel.

Note

Material damage Premature clogging of the fuel filter.

- In some countries and regions, the available fuel quality and cleanliness may not be sufficient. This will result in problems with the fuel system.
- Only refuel with clean fuel that meets the specified standards.



Warning

Environmental hazard Improper handling of fuel is a danger to the environment.

- Do not allow fuel to get into the ground water, the ground, or the sewage system.

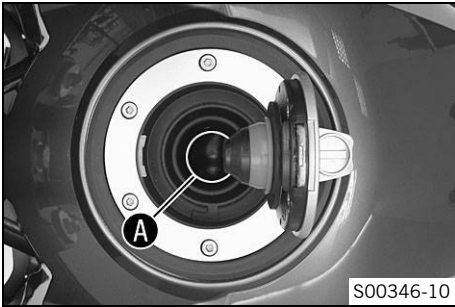

- Switch off the engine.
- Open the filler cap. (☛ p. 9)
- Fill the fuel tank with fuel up to the lower edge **A** of the filler neck.

Total fuel tank capacity, approx.	23 l (6.1 US gal)	Super unleaded (ROZ 95/RON 95/PON 91) (☛ p. 13)
-----------------------------------	-------------------	---

- Close the filler cap. (☛ p. 10)

3.7 Opening the filler cap



Danger

Fire hazard Fuel is highly flammable.

- Never refuel the vehicle near open flames or burning cigarettes, and always switch off the engine first. Be careful that no fuel is spilt, especially on hot vehicle components. Clean up spilt fuel immediately.
- The fuel in the fuel tank expands when warm and may emerge if overfilled. Follow the instructions on refueling.



Warning

Danger of poisoning Fuel is poisonous and a health hazard.

- Fuel must not come into contact with the skin, eyes, or clothing. Do not breathe in the fuel vapors. If contact occurs with the eyes, rinse with water immediately and contact a physician. Immediately clean contaminated areas on the skin with soap and water. If fuel is swallowed, contact a physician immediately. Change clothing that has been contaminated with fuel. Store fuel properly in a suitable canister and keep away from children.



Warning

Environmental hazard Improper handling of fuel is a danger to the environment.

- Do not allow fuel to get into the ground water, the ground, or the sewage system.

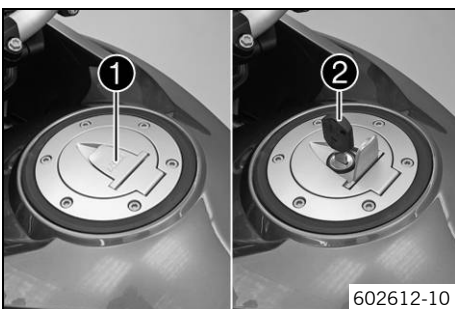

- Lift cover **1** of the filler cap and insert ignition key **2** in the fuel tank lock.

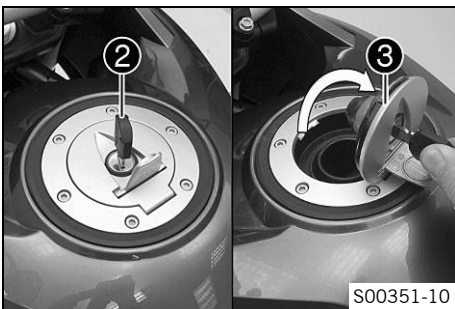

Note

Danger of damage Ignition key breakage.

- To take pressure off of the ignition key, push down on the filler cap. Damaged ignition keys must be replaced.

- Turn ignition key **2** clockwise.
- Fold open filler cap **3**.

3.8 Closing the filler cap

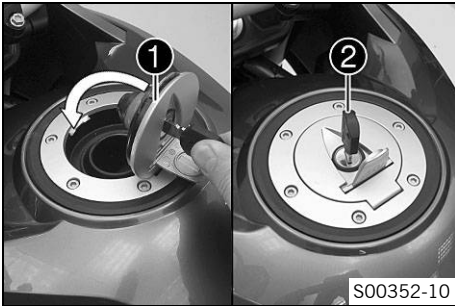

- Fold down filler cap ①.
- Turn ignition key ② clockwise.

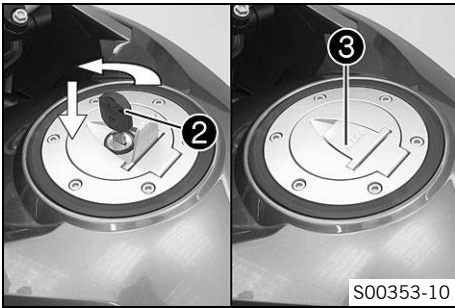

- Push down the filler cap and turn the ignition key ② counterclockwise until the tank lock closes.



Warning

Fire hazard Fuel is highly flammable, poisonous and harmful to your health.

- After closing the filler cap, ensure that it is locked properly. Change clothing that has been contaminated with fuel. Immediately clean contaminated areas on the skin with soap and water.

- Remove ignition key ② and close cover ③.

4.1 chassis tightening torques

Nut, tire pressure sensor	ISO 10V2	12 Nm (8.9 lbf ft)	Loctite® 2701™
Screw, combination switch, left	M4	2 Nm (1.5 lbf ft)	–
Screw, side stand switch	M4	2 Nm (1.5 lbf ft)	–
Remaining screws, chassis	M5	5 Nm (3.7 lbf ft)	–
Screw, brake line holder on swingarm	M5	5 Nm (3.7 lbf ft)	–
Screw, cable channel	M5	5 Nm (3.7 lbf ft)	–
Screw, cable guide, wheel speed sensor, rear	M5	3 Nm (2.2 lbf ft)	–
Screw, chain sliding guard	M5	5 Nm (3.7 lbf ft)	–
Screw, combination switch, right	M5	3.5 Nm (2.58 lbf ft)	–
Screw, cover part	M5	3.5 Nm (2.58 lbf ft)	–
Screw, filler cap	M5	3 Nm (2.2 lbf ft)	–
Screw, foot brake lever stub	M5	6 Nm (4.4 lbf ft)	Loctite® 243™
Screw, fuel level sensor	M5	3 Nm (2.2 lbf ft)	–
Screw, heat guard on main silencer	M5	4 Nm (3 lbf ft)	–
Screw, wind shield	M5	3.5 Nm (2.58 lbf ft)	–
Spoke nipple	M5	5 Nm (3.7 lbf ft)	–
Ground fitting on frame	M6	6 Nm (4.4 lbf ft)	–
Nut, ABS unit fixation	M6	8 Nm (5.9 lbf ft)	–
Remaining chassis nuts	M6	10 Nm (7.4 lbf ft)	–
Remaining chassis screws	M6	10 Nm (7.4 lbf ft)	–
Screw, angle sensor	M6	6 Nm (4.4 lbf ft)	–
Screw, ball joint of push rod on foot brake cylinder	M6	10 Nm (7.4 lbf ft)	Loctite® 243™
Screw, battery terminal	M6	4.5 Nm (3.32 lbf ft)	–
Screw, brake line holder on bottom triple clamp	M6	10 Nm (7.4 lbf ft)	–
Screw, cable channel	M6	5 Nm (3.7 lbf ft)	–
Screw, chain guide	M6	5 Nm (3.7 lbf ft)	–
Screw, clutch assembly	M6	5 Nm (3.7 lbf ft)	–
Screw, cooler retaining bracket	M6	7 Nm (5.2 lbf ft)	–
Screw, cover part	M6	6 Nm (4.4 lbf ft)	–
Screw, engine guard	M6	10 Nm (7.4 lbf ft)	–
Screw, foot brake cylinder	M6	10 Nm (7.4 lbf ft)	Loctite® 243™
Screw, front brake disc	M6	14 Nm (10.3 lbf ft)	Loctite® 243™
Screw, fuel pump	M6	6 Nm (4.4 lbf ft)	–
Screw, fuel tank	M6	10 Nm (7.4 lbf ft)	–
Screw, fuel tap	M6	6 Nm (4.4 lbf ft)	–
Screw, lower rear part	M6	6 Nm (4.4 lbf ft)	–
Screw, magnetic holder on side stand	M6	6 Nm (4.4 lbf ft)	Loctite® 243™
Screw, rear brake disc	M6	14 Nm (10.3 lbf ft)	Loctite® 243™
Screw, retaining bracket, angle sensor	M6	6 Nm (4.4 lbf ft)	Loctite® 243™
Screw, voltage regulator	M6	6 Nm (4.4 lbf ft)	–
Screw, wheel speed sensor, front	M6	10 Nm (7.4 lbf ft)	–
Screw, wheel speed sensor, rear	M6	10 Nm (7.4 lbf ft)	–
Remaining chassis nuts	M8	25 Nm (18.4 lbf ft)	–
Remaining chassis screws	M8	25 Nm (18.4 lbf ft)	–
Screw, bottom triple clamp	M8	12 Nm (8.9 lbf ft)	–
Screw, exhaust clamp	M8	25 Nm (18.4 lbf ft)	–
Screw, foot brake lever	M8	25 Nm (18.4 lbf ft)	Loctite® 243™
Screw, fork stub	M8	15 Nm (11.1 lbf ft)	–

Screw, front footrest bracket	M8	25 Nm (18.4 lbf ft)	Loctite® 243™
Screw, handlebar clamp	M8	20 Nm (14.8 lbf ft)	–
Screw, ignition lock (tamper-proof screw)	M8	25 Nm (18.4 lbf ft)	Loctite® 243™
Screw, rear footrest bracket	M8	25 Nm (18.4 lbf ft)	Loctite® 243™
Screw, steering damper	M8	25 Nm (18.4 lbf ft)	Loctite® 243™
Screw, steering damper clamp	M8	12 Nm (8.9 lbf ft)	–
Screw, suitcase hook	M8	20 Nm (14.8 lbf ft)	Loctite® 243™
Screw, top triple clamp	M8	15 Nm (11.1 lbf ft)	–
Engine carrying screw	M10	45 Nm (33.2 lbf ft)	–
Remaining chassis nuts	M10	45 Nm (33.2 lbf ft)	–
Remaining chassis screws	M10	45 Nm (33.2 lbf ft)	–
Screw, front brake caliper	M10	45 Nm (33.2 lbf ft)	Loctite® 243™
Screw, handlebar support	M10	40 Nm (29.5 lbf ft)	Loctite® 243™
Screw, side stand	M10	35 Nm (25.8 lbf ft)	Loctite® 243™
Screw, side stand bracket	M10	45 Nm (33.2 lbf ft)	Loctite® 243™
Banjo bolt, brake line	M10x1	25 Nm (18.4 lbf ft)	–
Lambda sensor	M12x1.25	25 Nm (18.4 lbf ft)	–
Screw, bottom shock absorber	M14x1.5	80 Nm (59 lbf ft)	Thread greased
Screw, top shock absorber	M14x1.5	80 Nm (59 lbf ft)	Thread greased
Nut, socket	M18x1	4 Nm (3 lbf ft)	–
Nut, swingarm pivot	M19x1.5	130 Nm (95.9 lbf ft)	Thread greased
Screw, steering head, top	M22x1.5	50 Nm (36.9 lbf ft)	–
Nut, rear wheel spindle	M25x1.5	90 Nm (66.4 lbf ft)	Thread greased
Screw, front wheel spindle	M25x1.5	45 Nm (33.2 lbf ft)	Thread greased
Nut, steering head, top	M28x1.0	Step 1 10 Nm (7.4 lbf ft) Step 2 (loosen, counter-clockwise) 60°	–

Super unleaded (ROZ 95/RON 95/PON 91)

Standard/classification

- DIN EN 228 (ROZ 95/RON 95/PON 91)

Guideline

- Only use unleaded super fuel that matches or is equivalent to the specified fuel grade.
- Fuel with an ethanol content of up to 10 % (E10 fuel) is safe to use.



Info

Do **not** use fuel containing methanol (e. g. M15, M85, M100) or more than 10 % ethanol (e. g. E15, E25, E85, E100).



3213424en

11/2015

