







50 SX MINI 2010

SPARE PARTS MANUAL: ENGINE

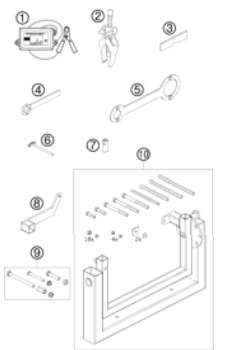
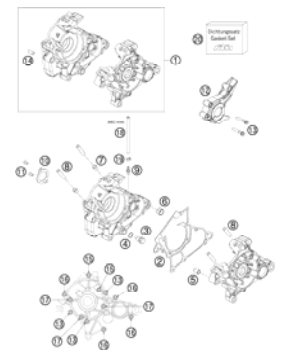
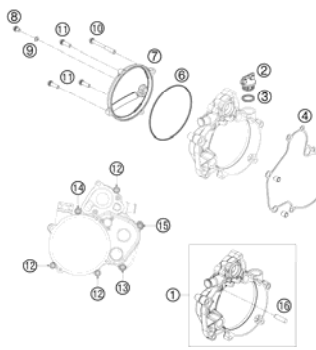
ART.NO.: 3CM080858JEN

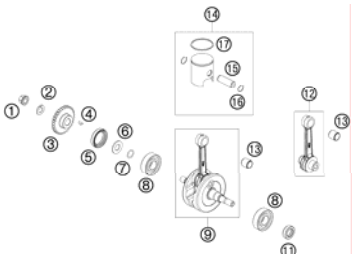
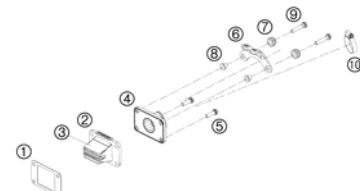
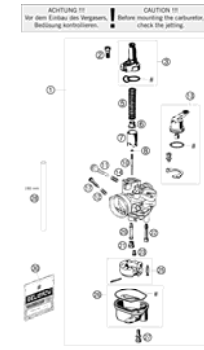
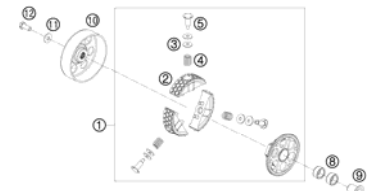
ENGLISH

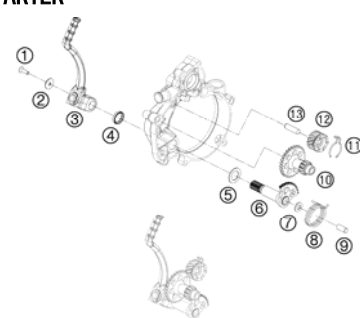

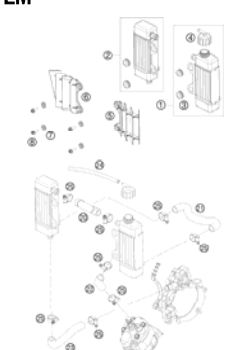
<p>SPECIAL TOOLS</p>  <p>3</p>	<p>ENGINE CASE</p>  <p>4</p>	<p>CLUTCH COVER</p>  <p>5</p>	<p>CYLINDER, CYLINDER HEAD</p>  <p>6</p>
<p>CRANKSHAFT, PISTON</p>  <p>7</p>	<p>REED VALVE CASE</p>  <p>8</p>	<p>CARBURETOR</p>  <p>9</p>	<p>CLUTCH</p>  <p>10</p>
<p>TRANSMISSION</p>  <p>11</p>	<p>KICK STARTER</p>  <p>12</p>	<p>WATER PUMP</p>  <p>13</p>	<p>COOLING SYSTEM</p>  <p>14</p>

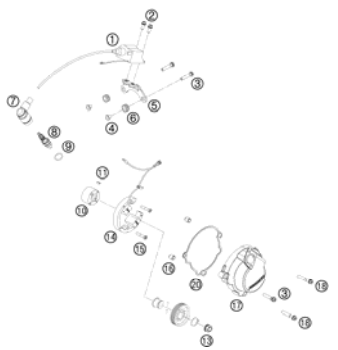
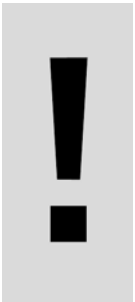
<p>LUBRICATING SYSTEM</p>  <p>15</p>	<p>IGNITION SYSTEM</p>  <p>16</p>		
	<div style="display: flex; align-items: center;">  <p>All information contained is without obligation. KTM-Sportmotorcycle AG particularly reserves the right to modify any equipment, technical specifications, prices, colors, shapes, materials, services, service work, constructions, equipment and the like so as to adapt them to local conditions or to cancel any of the above items, all without previous announcement and without giving reasons. KTM may stop manufacturing certain models without previous notice. KTM shall not be held liable for any deviations of availability and/or ability to deliver, illustrations, descriptions, printing and/or other errors. The illustrated models partly contain extra equipment, which is not applied to standard models. © by KTM-SPORTMOTORCYCLE AG, Mattighofen AUSTRIA; All rights reserved; Reprint, also in extracts, with written allowance of KTM-SPORTMOTORCYCLE AG, Mattighofen only.</p> </div>		

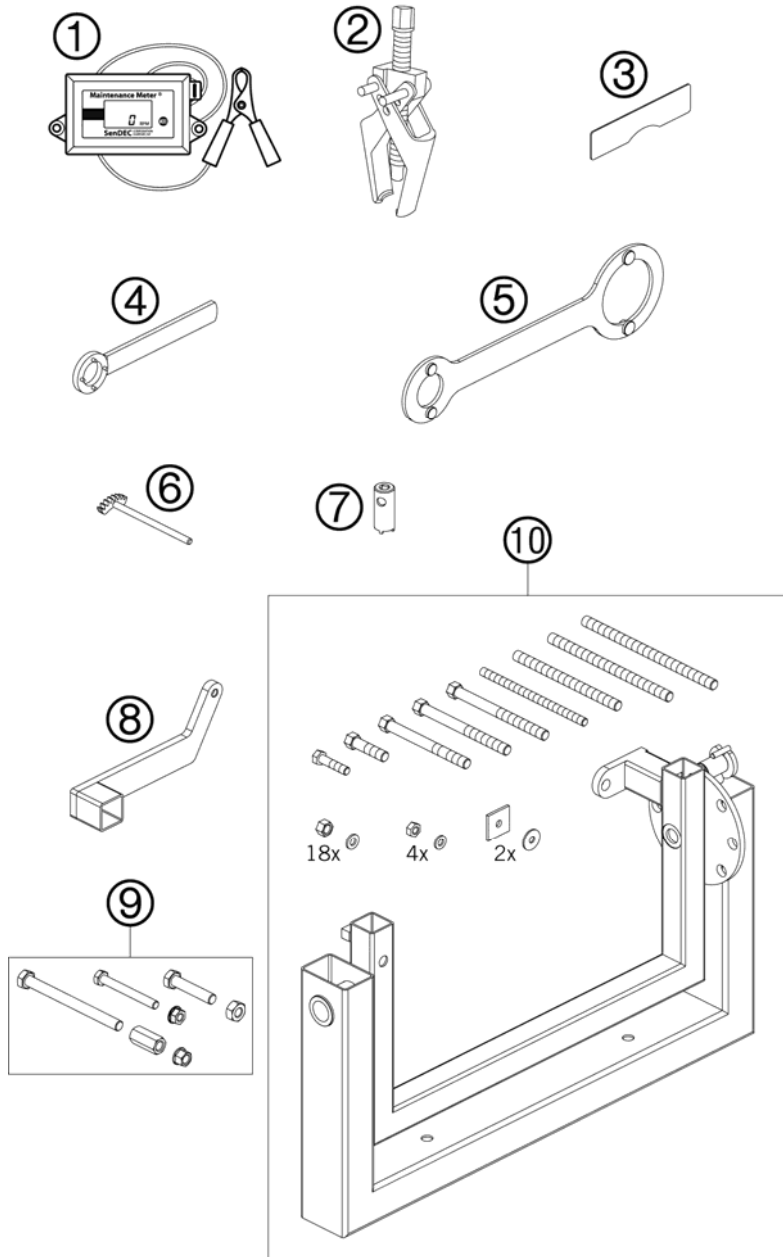

FIG	PART NUMBER	DESCRIPTION	QTY
1	45129075000	REVMETER	1
2	46129021000	EXTRACTOR PRIM. GEAR 65 SX 03	1
3	45129006000	ADJUSTING PLATE 50SX MINI 2001	1
4	45229012000	WRENCH FOR ROTOR	1
5	54629012100	HOLD. SPANNER ROTOR 2K-1/2/3/4	1
6	45229081000	GEAR SEGMENT CPL.	1
7	45229021000	SPECIAL SOCKET CLUTCH	1
8	45229001070	RETAIN. ARM F. ENG.WORK STAND	1
9	45229001060	PICKUP ENGINE STAND CPL.	1
10	56012001000	ASSY SUPPORT (WITHOUT HOLDER)	1

094522910 / C094522910

* NEW PART

X AS REQUIRED

ENGINE CASE

50 SX MINI 2010

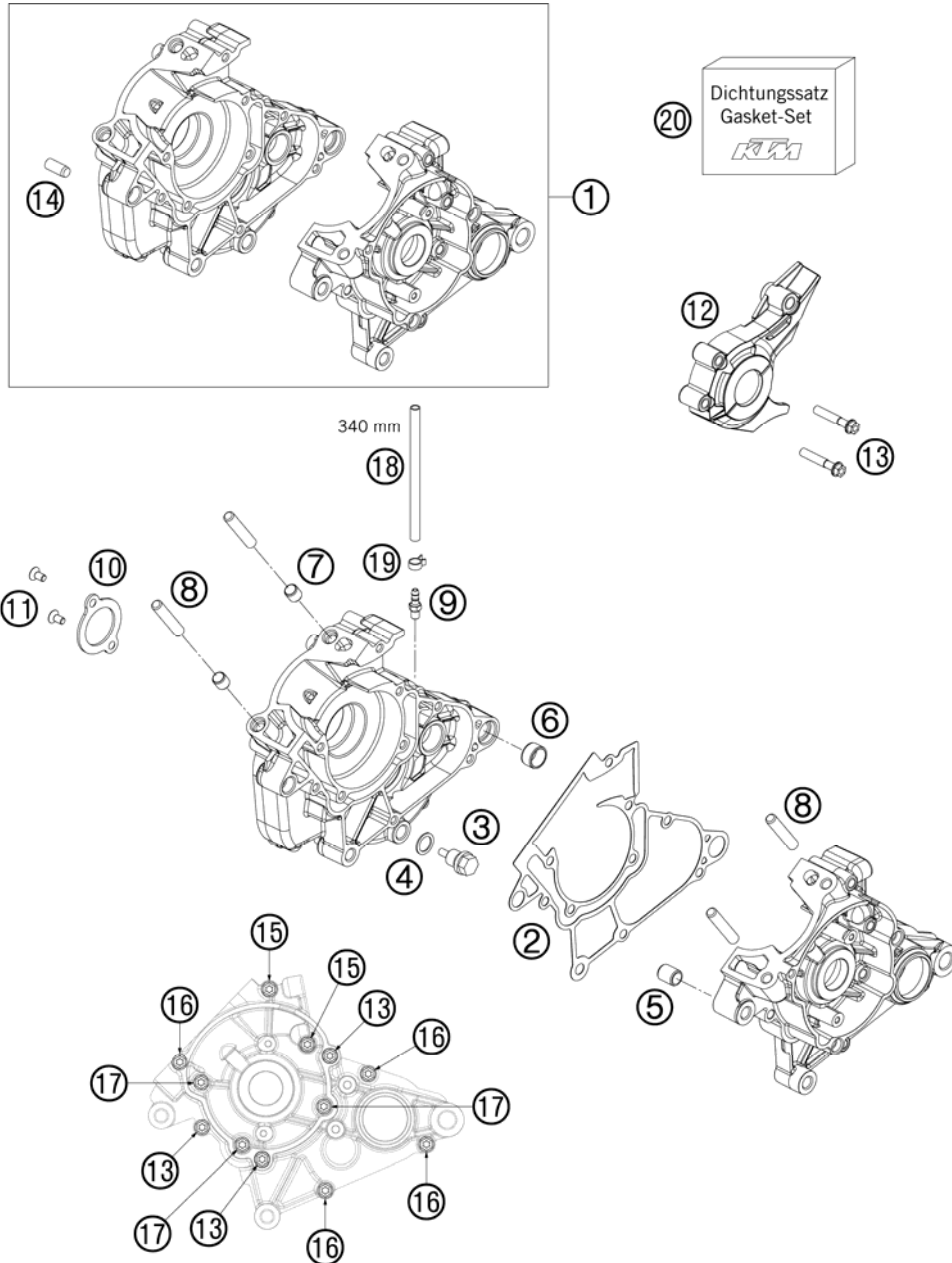

FIG	PART NUMBER	DESCRIPTION	QTY
1	45230000033	ENGINE CASE CPL. + BEAR. 50 SX	1
2	45230039000	ENGINE CASE GASKET	1
3	58030021000	OILDRAIN PLUG W.MAG. M 12X1,5	1
4	58038022000	CU-SEAL RING DIN7603-12X18X1,5	1
5	46230024000	DOWEL 12X9X14,5	1
6	58330023000	DOWEL 17 X 14 X 9,5	1
7	46230023000	DOWEL 10X8,2X10	2
8	46030043000	STUD M8X41	4
9	58336020190	VACUUM CONECTION M6/3MM '97	1
10	45230017000	BEARING BRACKET	1
11	0019050103	INT. TORX FLAT HEAD M 5X10 8.8	2
12	45230060000	CHAIN GUARD	1
13	0025060356	HH COLLAR SCREW M6X35 TX30	5
14	0325080200	CYLINDER STUD DIN6325 8X20 M6	1
15	0025060556	HH COLLAR SCREW M6X55 TX30	2
16	0025060306	HH COLLAR SCREW M6X30 TX30	4
17	0025060406	HH COLLAR SCREW M6X40 TX30	3
18	31007007101	PVC-HOSE 4X6MM	x
19	45230089000	YDNAC-CLAMP 10068 (6,8MM)	1
20	45230099000	GASKET SET 50 SX 2009	1

094523011 / C094523011

* NEW PART

X AS REQUIRED

CLUTCH COVER

50 SX MINI 2010

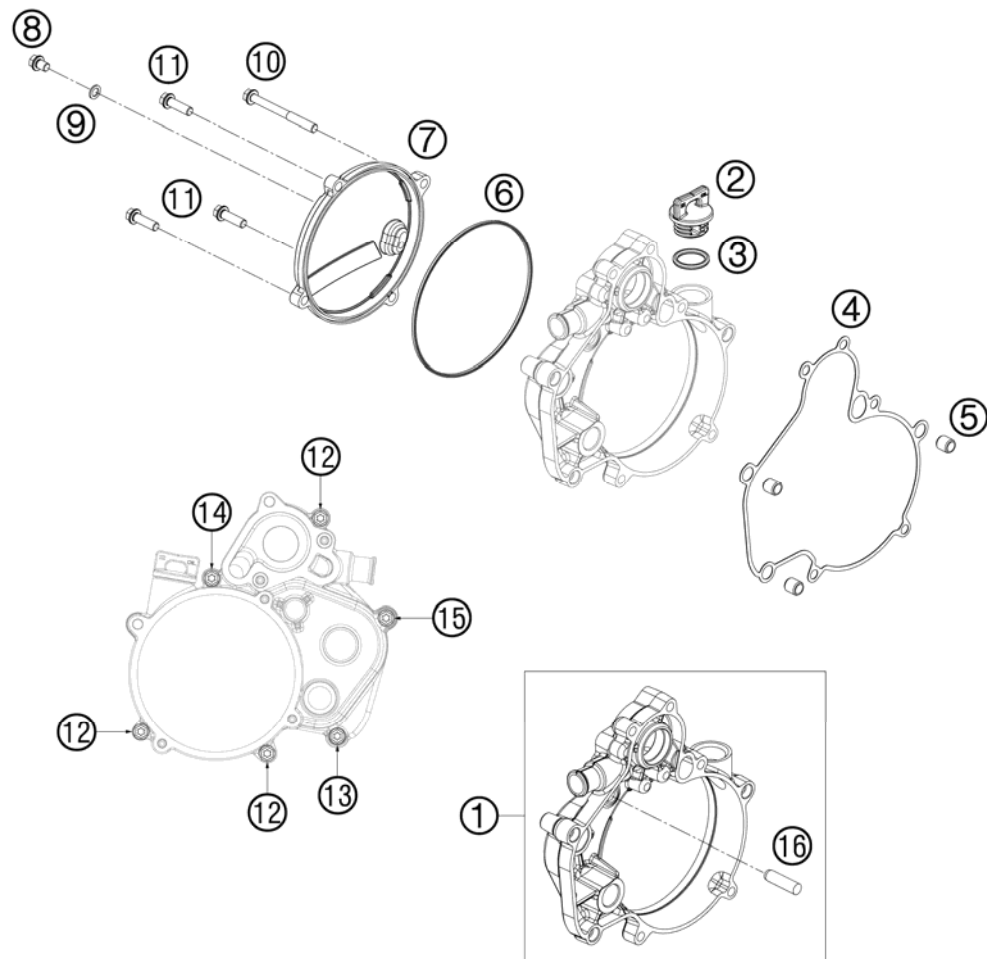

FIG	PART NUMBER	DESCRIPTION	QTY
1	45230001044	CLUTCH COVER INNER CPL.	1
2	58030020100	PLUG CPL. M24X3	1
3	0770191015	O-RING 19,00X3,00 NBR	1
4	45230025000	CLUTCH COVER GASKET INSIDE	1
5	49030090000	DOWEL 9,8 X 7 X 10	3
6	45230027000	CLUTCH COVER GASKET	1
7	45230026000	CLUTCH COVER OUTSIDE	1
8	0025060086	HH COLLAR SCREW M6X8 TX30	1
9	0603061001	CU-SEAL RING DIN7603-6X10X1	1
10	0025060606	HH COLLAR SCREW M6X60 TX30	1
11	0025060206	HH COLLAR SCREW M6X20 TX30	3
12	0025060256	HH COLLAR SCREW M6X25 TX30	3
13	0025060306	HH COLLAR SCREW M6X30 TX30	1
14	0025060356	HH COLLAR SCREW M6X35 TX30	1
15	0025060506	HH COLLAR SCREW M6X50 TX30	1
16	0325080300	CYLINDER STUD DIN6325 8X30 M6	1

094523020 / C094523020

* NEW PART

X AS REQUIRED

CYLINDER, CYLINDER HEAD

50 SX MINI 2010

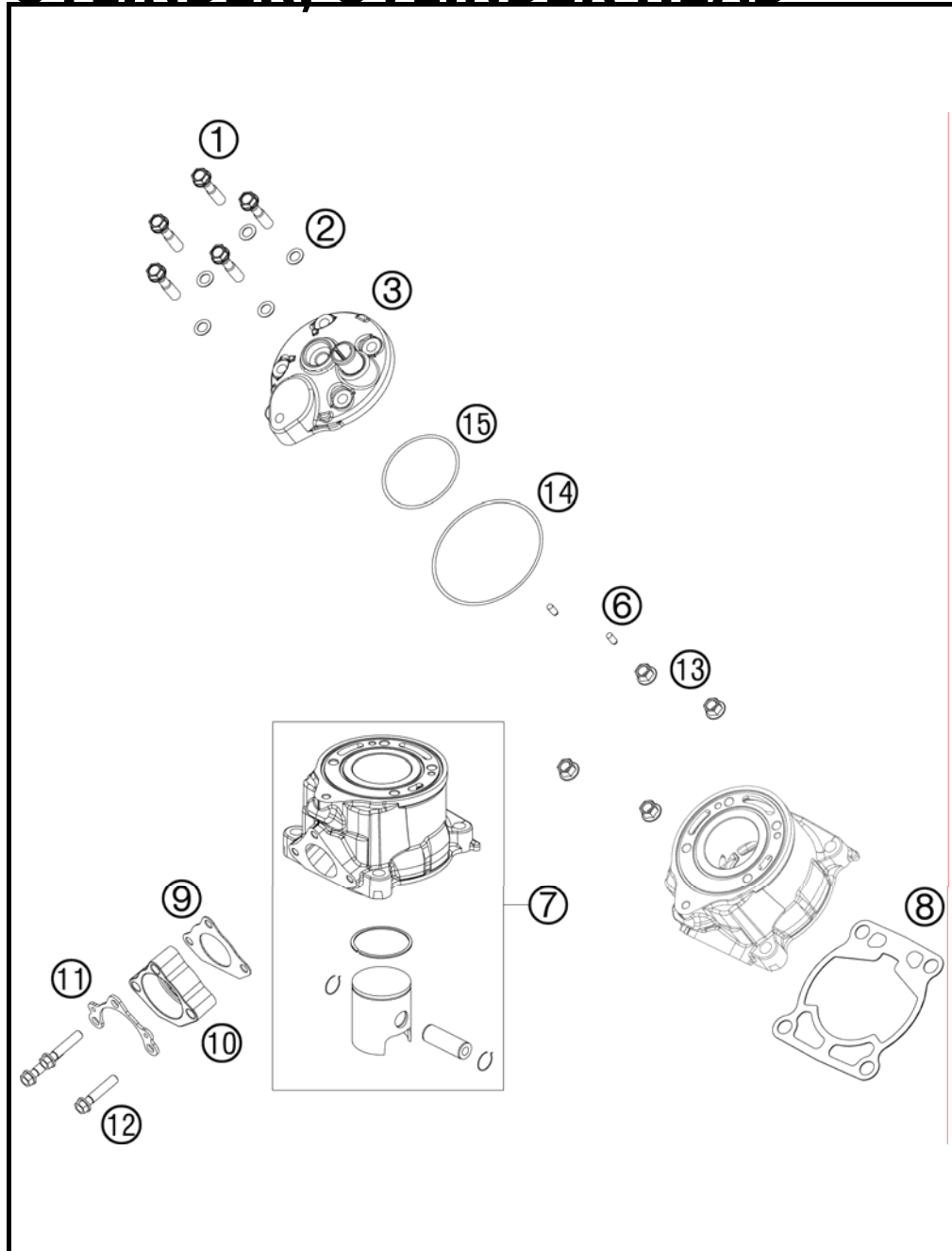

FIG	PART NUMBER	DESCRIPTION	QTY
1	50330079000	CYL. HEAD BOLT M 7X30 WS=10	5
2	50230032010	CU-SEAL RING 7,3 X 12 X 0,5	5
3	45230006000	CYLINDER HEAD	1
6	0325040100	CYLINDER PIN DIN6325- 4X10	2
7	45230038000	CYLINDER + PISTON	1
8	46230035020	CYLINDER BASE GASKET 0,2 MM	x
8	46230035040	CYLINDER BASE GASKET 0,4 MM	x
8	46230035050	CYLINDER BASE GASKET 0,5 MM	x
8	46230035060	CYLINDER BASE GASKET 0,6MM	x
9	45205004000	EXHAUST FLANGE GASKET	1
10	45205003000	EXHAUST FLANGE	1
11	46205003050	BRACKET FOR SPRINGHOLDER	1
12	0025060306	HH COLLAR SCREW M6X30 TX30	3
13	46030045000	COLLAR NUT M8 WS=10	4
14	0770078020	O-RING 78,00X2,00 VIT. BLACK	1
15	0770052020	O-RING 52,00X2,0 VITON 75	1

094523050 / C094523050

* NEW PART

X AS REQUIRED

CRANKSHAFT, PISTON

50 SX MINI 2010

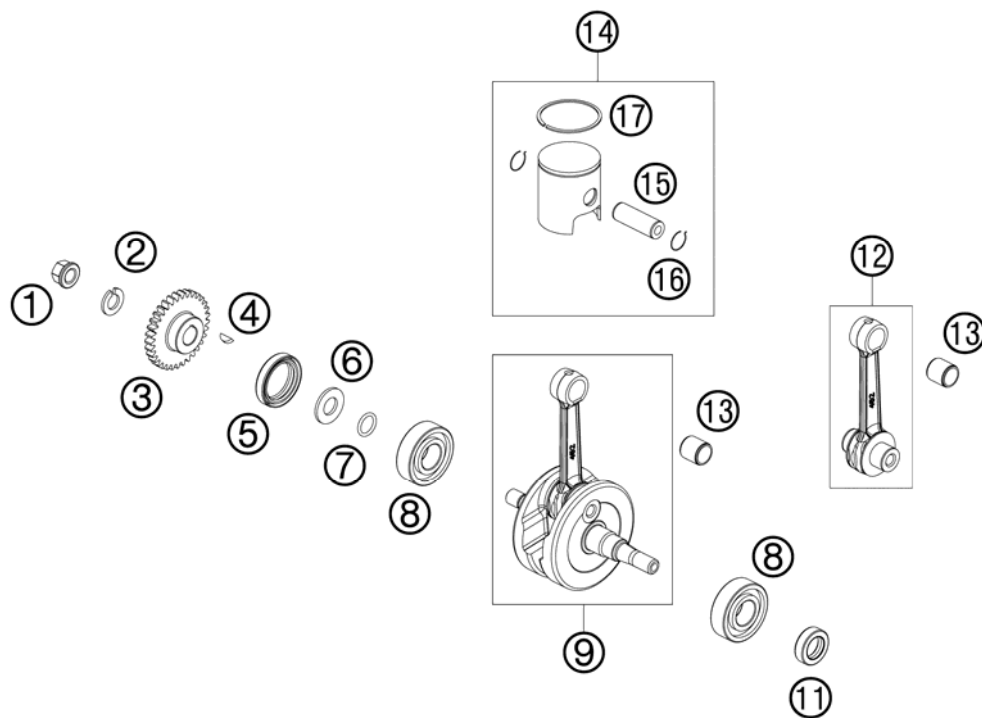

FIG	PART NUMBER	DESCRIPTION	QTY
1	58414030000	HH COLLAR NUT M10X1,25 WS=13	1
2	45230072000	LOCKING RING VSK 10	1
3	45232023033	PRIMARY DRIVE 33T	1
4	0888030037	WOODRUFF KEY DIN6888-3X3,7	1
5	0760253570	SHAFT SEAL RING 25X35X7 BTSL	1
6	45230016000	SPACER WASHER - CRANKSHAFT	1
7	0770120020	O-RING 12,00X2,00 NBR 70	1
8	0625062035	BALL BEARING 6203 JR2 C3	2
9	45230018100	CRANKSHAFT GS CPL.	1
11	0760152472	SHAFT SEAL RING 15X24X7 A-DUO	1
12	45230015000	PISTON ROD REP-SET 09	1
13	45130034000	NEEDLE BEAR.PISTONPIN 12X15X15	1
14	45230007000 I	PISTON CPL. I 2009	1
14	45230007000 II	PISTON CPL. II 2009	1
15	45230033000	PISTON BOLT 09	1
16	45230074000	CIRCLIP 09	2
17	45230030000	PISTONRING 09	1

094523060 / C094523061

* NEW PART

X AS REQUIRED

REED VALVE CASE

50 SX MINI 2010

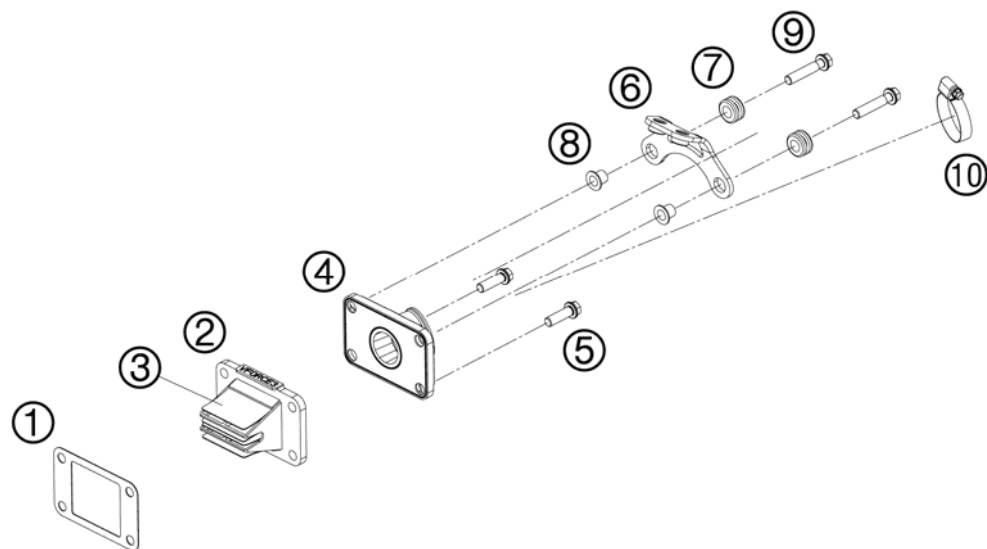

FIG	PART NUMBER	DESCRIPTION	QTY
1	46230049000	GASKET MEMBRAN CASE	1
2	45230051044	MEMBRANE CASE CPL. V-VORCE	1
3	45230052000	MEMBRANE	4
4	45230050100	INTAKE FLANGE	1
5	0025060206	HH COLLAR SCREW M6X20 TX30	2
6	45239010000	IGNIT. COIL RETAIN. PLATE CPL.	1
7	31008060000	RUBBER SLEEVE D=8MM OPEN	2
8*	45239060050	COLLAR BUSHING 6,3X8X13X9,5	2
9	0025060306	HH COLLAR SCREW M6X30 TX30	2
10	10001120000	CLAMP 25-40 SGT 4	1

094523070 / C104523071

* NEW PART

X AS REQUIRED

ACHTUNG !!!
Vor dem Einbau des Vergasers,
Bedüsung kontrollieren.

CAUTION !!!
Before mounting the carburetor,
check the jetting.

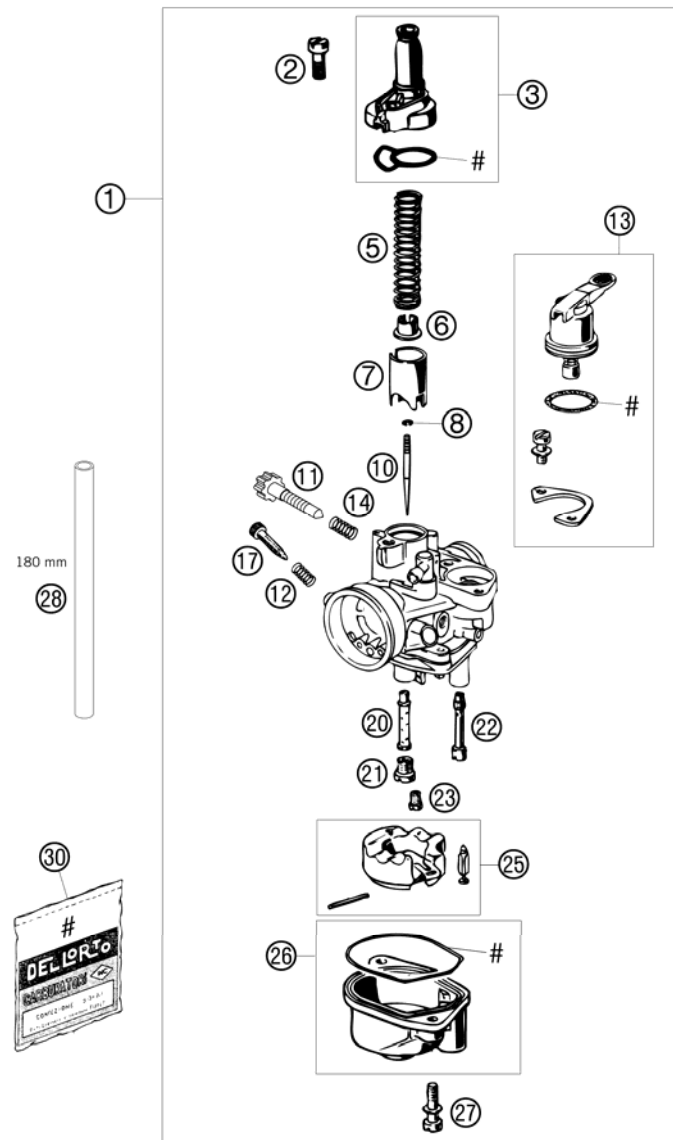

FIG	PART NUMBER	DESCRIPTION	QTY
1	45131001300	CARBURETOR DELLO. PHVA 12XS 05 CHECK THE JETTING	1
2	0084050163	CYL.HEAD SCREW DIN0084-M 5X16A	1
3	45131527000	CARBURETOR COVER DELLOR. 12-14	1
5	45131530000	SPRING	1
6	45131531000	SPRING CAP	1
7	45131535000	THROTTLE VALVE 40	1
8	45131545000	CLAMP SPRING	1
10	45131534010	JET NEEDLE A10	1
11	45131517000	IDLE ADJUST SCREW	1
12	45131516000	SPRING	1
13	45131548000	STARTING LEVER CPL. DELL.12-14	1
14	45131518000	SPRING	1
17	45131617000	ADJUST SCREW	1
20	45131536000	ATOMIZER 211FA	1
21	45131023065	MAIN JET 65 DELLORTO	x
21	45131023070	MAIN JET 70 DELLORTO	x
21	45131023075	MAIN JET 75 DELLORTO	x
21	57031523080	MAIN JET 80	x
21	59030054000	JET 60 DELLORTO M6X0,75	x
22	45131551060	STARTING JET 60	1
23	45131507035	IDLING JET 35	x
23	45131507038	IDLING JET 38	x
23	45131507045	IDLING JET 45	x
25	45131509000	FLOAT CPL.	1
26	45131511000	FLOAT BOWL DELLORTO 12-14	1
27	0084040203	CYL.SCREW DIN0084-M 4X20 A	2
28	58307016001	FUEL HOSE VITON 6X1,5 PER/M	x
30	45131599000	GASKET SET DELLORTO 12-14 PHVA	1

094523110 / C094523110

* NEW PART

X AS REQUIRED

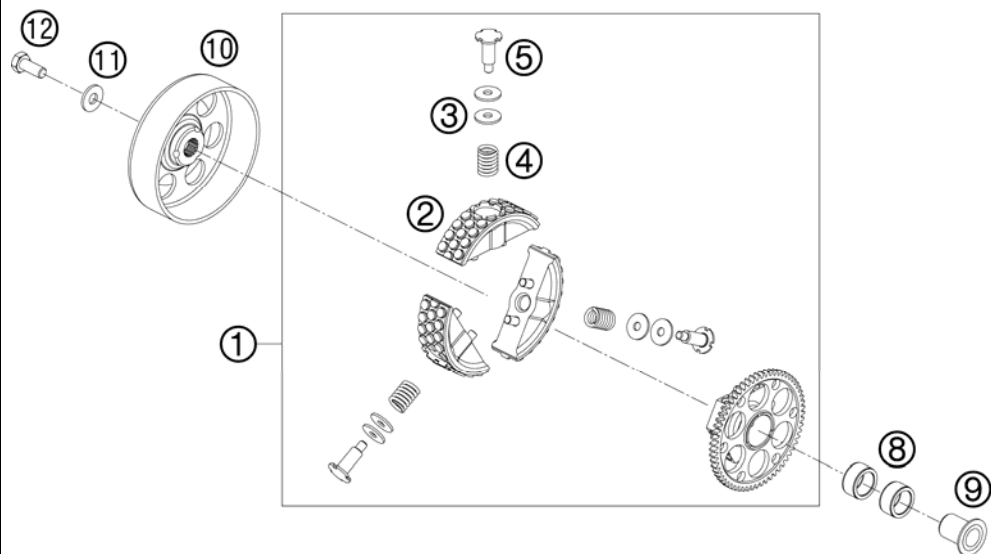

FIG	PART NUMBER	DESCRIPTION	QTY
1*	45232000133	CLUTCH CPL.	1
2*	45232011044	CLUTCH BLOCK KIT CPL.	1
3	45232007020	DISTANCE SHIM 9,5X19X0,2	x
3*	45232007044	SPACER SHIM KIT	x
3	45232007050	DISTANCE SHIM 9,5X19X0,5	x
4	45232005044	CLUTCH SPRING KIT	1
5	45232006044	HH COLLAR SCREW KIT	1
8	0402182412	NEEDLE BEARING 18X24X12A	2
9	45232013000	INNER RING WITH COLLAR	1
10	45232001000	OUT. CLUTCH HUB LOOSE	1
11	45232008000	WASHER 8,5X31X4	1
12	0933080203	HH SCREW DIN0933-M 8X20	1

094523210 / C104523210

* NEW PART

X AS REQUIRED

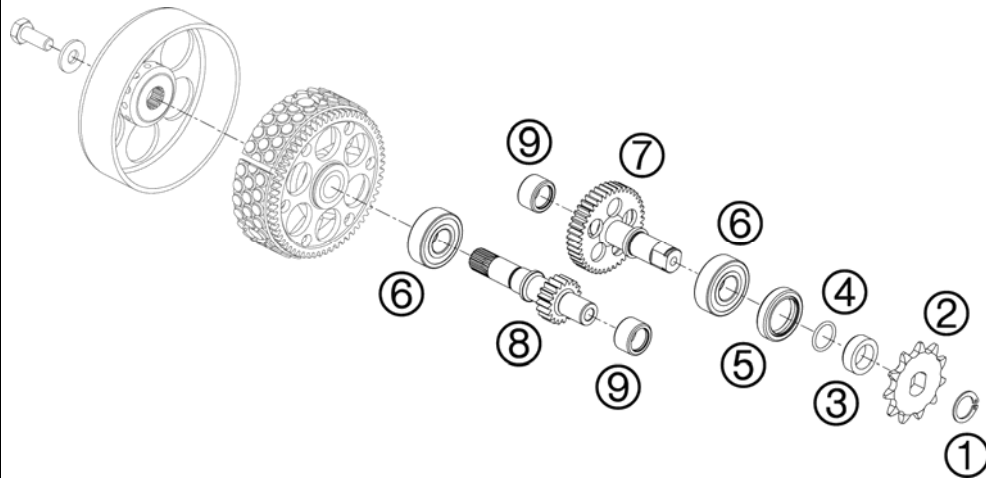

FIG	PART NUMBER	DESCRIPTION	QTY
1	0471150010	CIRCLIP DIN0471-15X1	1
2	45233029010	SPROCKET 10 T.	x
2	45233029011	SPROCKET 11 T.	x
3	45233030000	DISANCEPACER F. SPROCKET	1
4	0770015018	O-RING 15,00X1,80	1
5	0760223270	SHAFT SEAL RING 22X32X7 BSL	1
6	45133028000	BALL BEARING 15X35X11	2
7*	45233010200	COUNTER SHAFT	1
8*	45233001200	MAIN SHAFT	1
9	54632095000	NEEDLE BEAR.HK 1412 14X20X12	2

094523310 / C104523310

* NEW PART

X AS REQUIRED

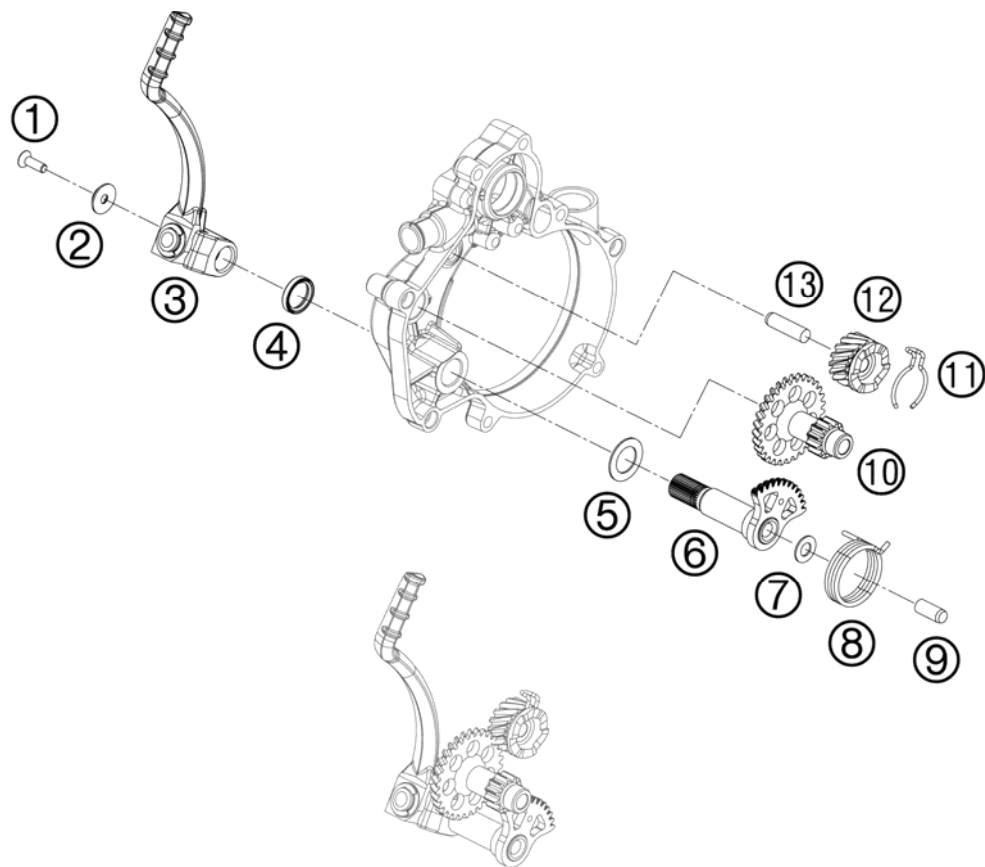

FIG	PART NUMBER	DESCRIPTION	QTY
1*	0019050163	INT. TORX FLAT HEAD M 5X16 8.8	1
2	60008045100	SPECIAL WASHER FOR M5 03	1
3	45233070044	KICKSTARTER CPL.	1
4	0760162240	SHAFT SEAL RING BALANC. SHAFT	1
5	45233058000	WASHER 16,3X25,8X1	1
6	45233050044	KICK START SHAFT CPL.	1
7	45233057000	WASHER 8,2X16X1	1
8	45233054000	KICKSTARTER SPRING	1
9	0325080200	CYLINDER STUD DIN6325 8X20 M6	1
10	45233053000	KICKSTARTER SHAFT	1
11*	45233056100	SPRING RATCHET GEAR	1
12	45233052016	RATCHET GEAR	1
13	0325080300	CYLINDER STUD DIN6325 8X30 M6	1

094523390 / C104523390

* NEW PART

X AS REQUIRED

WATER PUMP

50 SX MINI 2010

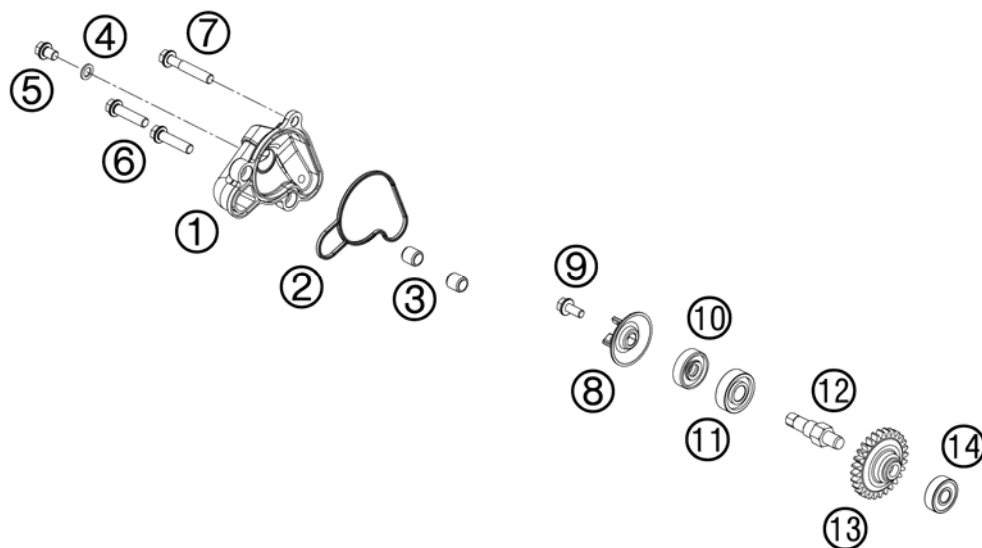

FIG	PART NUMBER	DESCRIPTION	QTY
1	45235052000	WATERPUMP COVER	1
2	45235053000	WATER PUMP COVER GASKET	1
3	49030090000	DOWEL 9,8 X 7 X 10	2
4	0603061001	CU-SEAL RING DIN7603-6X10X1	1
5	0025060086	HH COLLAR SCREW M6X8 TX30	1
6	0025060256	HH COLLAR SCREW M6X25 TX30	2
7	0025060406	HH COLLAR SCREW M6X40 TX30	1
8*	45235055000	WATER PUMP WHEEL	1
9	0025050126	HH COLLAR SCREW M5X12 TX30	1
10	0760082472	SHAFT SEAL RING 8X24X7 A DUO	1
11	0625060001	BALL BEARING 6000/C3	1
12*	50335054150	WATER PUMP SHAFT	1
13	45235054028	DRIVE WHEEL	1
14	0625006087	GROOVED BALL BEAR. 608 2RS C3	1

094523510 / C104523510

* NEW PART

X AS REQUIRED

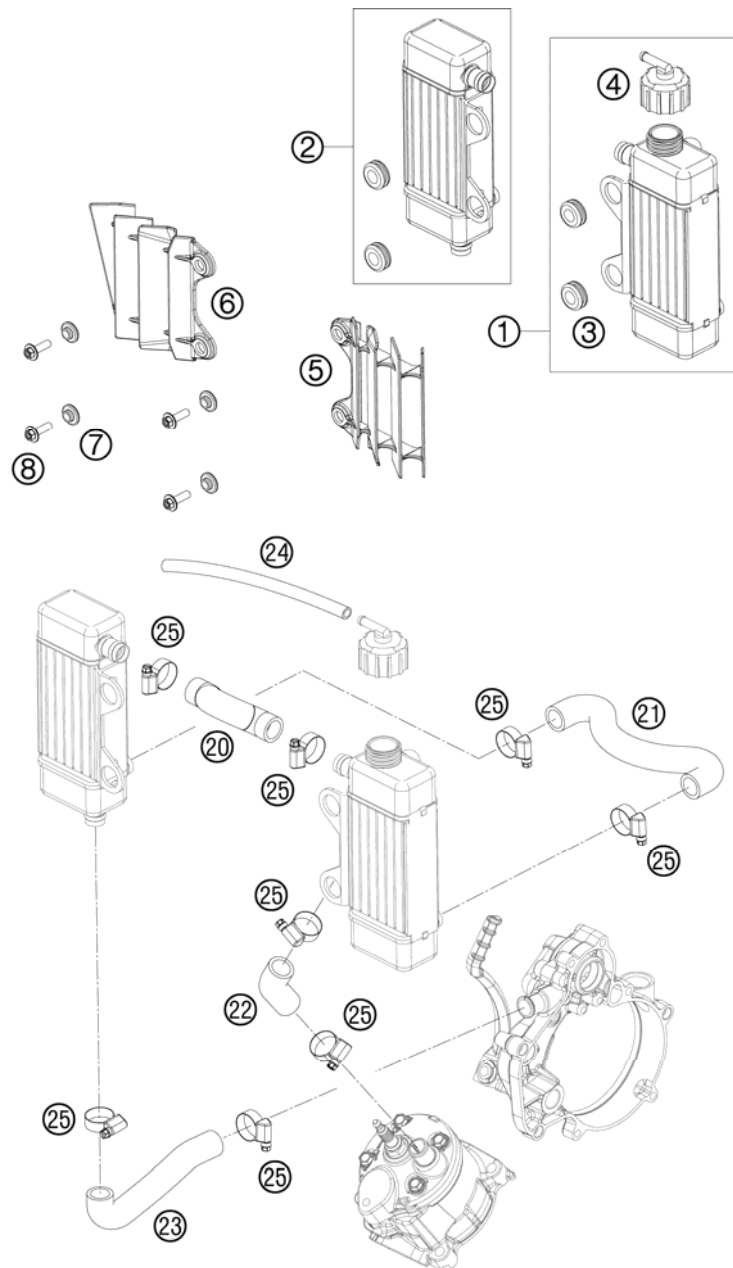

FIG	PART NUMBER	DESCRIPTION	QTY
1	45235007000	RADIATOR L/S 50 SX 2009	1
2	45235008000	RADIATOR R/S 50 SX 2009	1
3	41001052000	RUBBER SLEEVE D=12MM	4
4	45235009000	RADIATOR CAP 1,8 BAR	1
5	45235034000	RAD. PROTECT. L/S 50 SXS 2009	1
6	45235035000	RAD. PROTECT. R/S 50 SX 2009	1
7	54808020000	SPACER BUSHING 03	4
8	0024060206	HH COLLAR SCREW M6X20 TX30	4
20	45235026100	RADIATOR HOSE AHEAD 50 SX JUN	1
21	45235027200	RADIATOR HOSE BELOW 50 SX JUN	1
22	45235025100	PREFORMED HOSE 50 SX JUN. L/S	1
23	45235024200	PREFORMED RAD.HOSE 50 SX JUN	1
24	55007016001	PVC-HOSE 7X10 PER METER	1
25	42013037300	HOSE CLAMP NORMA 12/22	8

094523530 / C104523530

* NEW PART

X AS REQUIRED

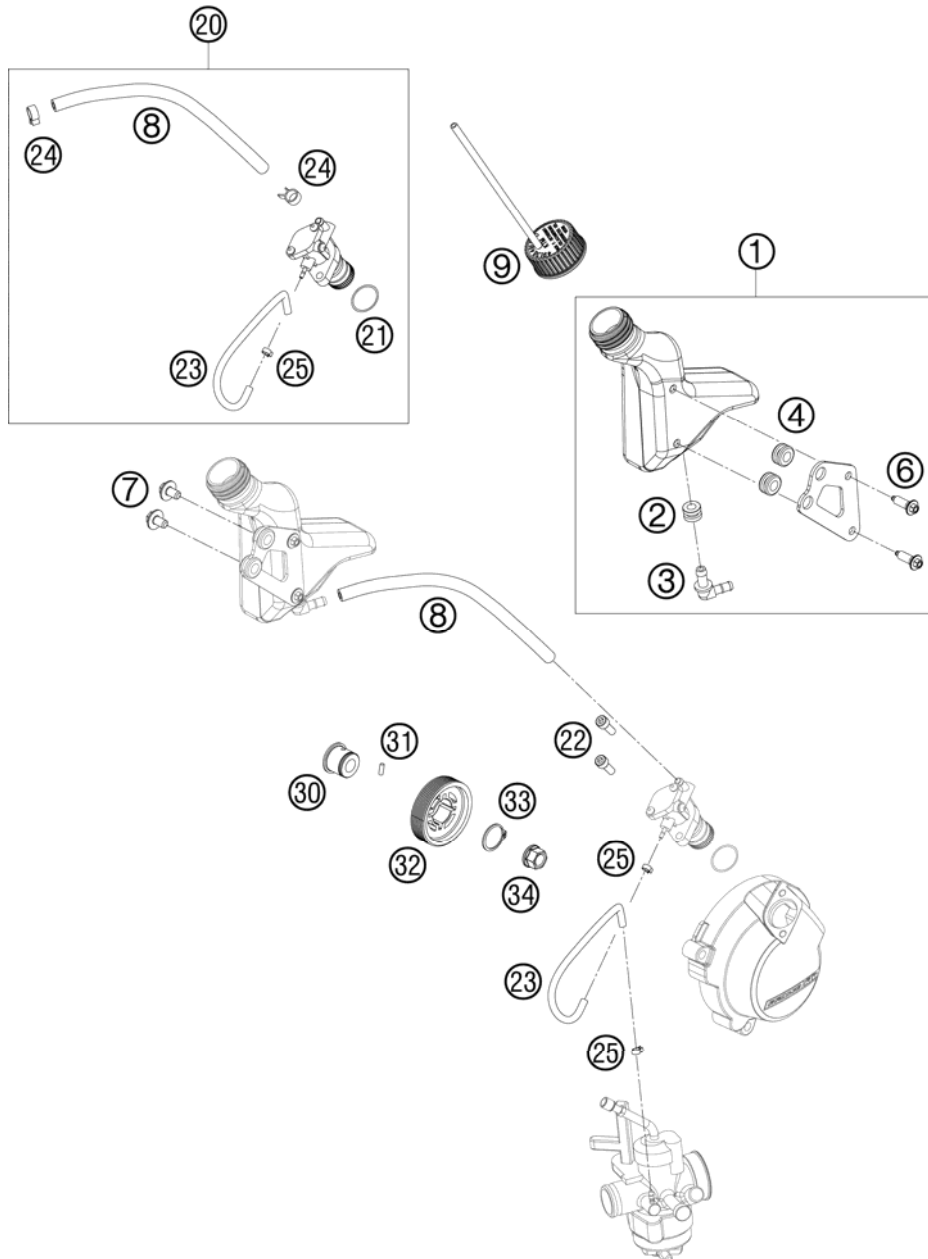

FIG	PART NUMBER	DESCRIPTION	QTY
1	45238061033	OIL TANK CPL. 50 SX MINI 2009	1
2	60035069000	RUBBER GROMMET 6X9X13MM 04	1
3	60035068000	ANGLE CONNECTION EXPANS. TANK	1
4	31008060000	RUBBER SLEEVE D=8MM OPEN	2
6	0017060203	EJOT PT SCREW K60X20 WS=6	2
7	0024060106	HH COLLAR SCREW M6X10 TX30	2
8	45138067000	HOSE 5X9MM	1
9	45238063033	OIL TANK SCREW SX MINI	1
20	45138067100	OIL PUMP	1
21	0770191016	O-RING 19,10X1,60 NBR 70	1
22	0912050163	AH SCREW DIN0912-M 5X16	2
23	45138068000	PREFORM. HOSE CARB.-PUMP 2X5MM	1
24	58007017000	YDNAC CLAMP 10101 (9MM)	2
25	45138069000	CLAMP 5 FOR OIL PUMP	2
30	45138064000	SPACER FOR OIL PUMP GEAR	1
31	0402030780	NEEDLE PIN DIN5402 NRB3X7,8 G2	1
32	45238065000	OIL PUMP DRIVE WHEEL	1
33	0471190120	CIRCLIP DIN0471-19X1,2	1
34	58414030000	HH COLLAR NUT M10X1,25 WS=13	1

094523810 / C094523810

* NEW PART

X AS REQUIRED

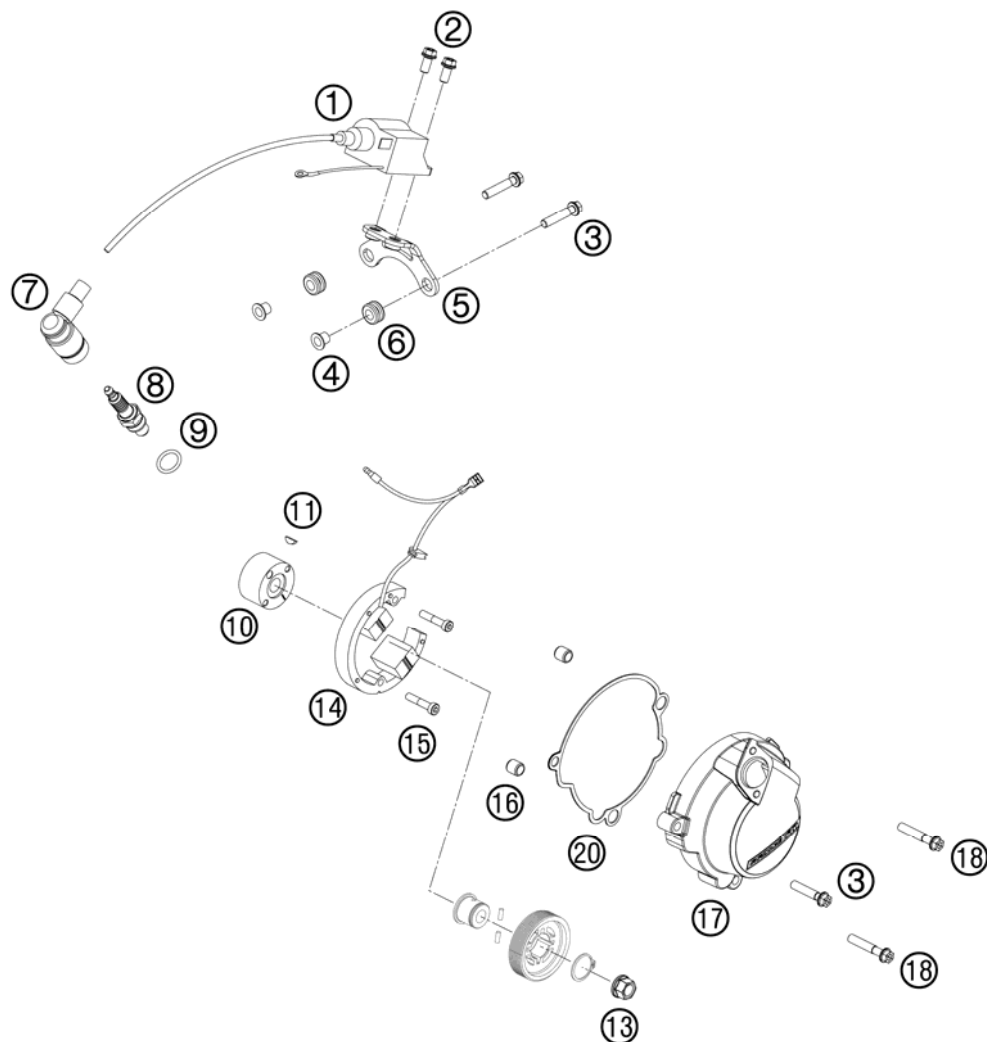

FIG	PART NUMBER	DESCRIPTION	QTY
1	45139006000	IGNITION COIL 50CCM LC 2001	1
2	0025060126	HH COLLAR SCREW M6X12 TX30	2
3	0025060306	HH COLLAR SCREW M6X30 TX30	3
4	45239060050	COLLAR BUSHING 6,3X8X13X9,5	2
5	45239010000	IGNIT. COIL RETAIN. PLATE CPL.	1
6	31008060000	RUBBER SLEEVE D=8MM OPEN	2
7	46239090000	SPARK PLUG CONNECTOR	1
8	45239093000	SPARK PLUG LR8B	1
9	0770012030	O-RING 12,00X3,0 VITON 75	1
10	45139005100	FLYWEEL ROTOR 50 2004	1
11	0888025030	WOODRUFF KEY DIN6888-2,5X3	1
13	58414030000	HH COLLAR NUT M10X1,25 WS=13	1
14	45139004000	FLYWHEEL STATOR 50CCM LC 2001	1
15	0012050253	AH SCREW DIN6912 M5X25	2
16	49030090000	DOWEL 9,8 X 7 X 10	2
17	45230002100	IGNITION COVER	1
18	0025060356	HH COLLAR SCREW M6X35 TX30	2
20	45230040000	GASKET - IGNITION COVER	1

094523911 / C104523911

* NEW PART

X AS REQUIRED



KTM-Sportmotorcycle AG
A-5230 Mattighofen
www.ktm.at

KTM Group Partner



3CM080858JEN



Art.Nr.: 3CM080858JEN 5/2009