

# OWNER'S MANUAL 2006

## 640 LC4 ADVENTURE

ART. NR. 3.211.79 EN



ENGLISH

We strongly suggest that you read this manual carefully and completely before going on your first ride. It contains a great deal of information and advice which will help you use and handle your bike properly. In your own interest, please pay particular attention to notices that are marked as follows:

**⚠ WARNING**

- IGNORING THESE INSTRUCTIONS, CAN ENDANGER YOUR BODY AND YOUR LIFE.

**! CAUTION**

- IGNORING THESE INSTRUCTIONS COULD CAUSE DAMAGE TO PARTS OF YOUR MOTORCYCLE OR THAT THE MOTOR-CYCLE IS NOT ROAD-SAFE ANYMORE.

Please insert the serial numbers of your motorcycle in the boxes below

Frame number

Engine number

Key number

Stamp of dealer

**CONSUMER INFORMATION FOR AUSTRALIA ONLY**

Tampering with noise control system prohibited

Owners are warned that the law may prohibit:

- The removal or rendering inoperative by any person other than for purposes of maintenance, repair or replacement, of any device or element of design incorporated into any new vehicle for the purpose of noise control prior to its sale or delivery to the ultimate purchaser or while it is in use; and
- the use of the vehicle after such device or element of design has been removed or rendered inoperative by any person.

All information contained is without obligation. KTM-Sportmotorcycle AG particularly reserves the right to modify any equipment, technical specifications, prices, colors, shapes, materials, services, service work, constructions, equipment and the like so as to adapt them to local conditions or to cancel any of the above items, all without previous announcement and without giving reasons. KTM may stop manufacturing certain models without previous notice. KTM shall not be held liable for any deviations of availability and/or ability to deliver, illustrations, descriptions, printing and/or other errors. The illustrated models partly contain extra equipment, which is not applied to standard models.

© 2005 by KTM-SPORTMOTORCYCLE AG, Mattighofen AUSTRIA; All rights reserved; Reprint, also in extracts, with written allowance of KTM-SPORTMOTORCYCLE AG, Mattighofen only.

We would like to congratulate you on your purchase of a KTM motorcycle.

You are now the owner of a state-of-the-art sport motorcycle that guarantees to bring you lots of fun and enjoyment, provided that you clean and maintain it appropriately. **Before you go for your first ride, be sure to read this manual carefully and thoroughly in order to familiarize yourself with how to operate your new motorcycle and with its characteristics, even if this means that you will have to dedicate some of your valuable time to this task. Only by doing so will you learn how to tune your motorcycle to your specific needs and how to protect yourself against injury. Besides, this manual contains important information on motorcycle maintenance.** At the time this manual was typeset, it was up-to-date with the latest state of this production series. It cannot be completely ruled out, however, that minor discrepancies may exist resulting from further design upgrades of these motorcycles. This manual is an important part of your motorcycle and should be passed on to any subsequent owner in case you decide to sell it.

We expressly point out that work marked with an asterisk in the chapter "Maintenance work on the chassis and engine" must be performed. If maintenance work should become necessary during a competition it should be performed by a trained mechanic. KTM strongly recommends that all service work to your KTM should be performed by a qualified KTM dealer.

**For your own safety, use KTM-approved parts and accessories only. KTM is not liable for damage that arises in connection with the use of other products.**

Take special care to follow the recommended run in, inspection, and maintenance intervals. Heeding these guidelines will significantly increase the life of your motorcycle. To ensure that all work to your KTM is performed properly and to avoid warranty conflicts, KTM recommends that you always have your KTM serviced by a recognized and qualified KTM dealer.

Off-road motorcycle driving is a wonderful sport and we hope that you will be able to enjoy it to the full. It may, however, involve potential problems for the environment or lead to conflicts with others. These problems or conflicts can be avoided if the motorcycle is used responsibly. To safeguard the future of motorcycle sports, make sure that you use the motorcycle in accordance with the law, show that you are environmentally conscious and respect the rights of others.

We wish you a lot of fun when driving !

KTM SPORTMOTORCYCLE AG  
5230 MATTIGHOFEN, AUSTRIA

The 640 Adventure is designed and constructed to resist the usual wear and tear of normal use on the road and easy terrain (dirt roads).

The service, care and operating instructions for the engine and chassis specified in the owner's manual must be observed to ensure that the bike runs smoothly and to avoid premature wear.

The service work specified in the "Lubrication and Maintenance Schedule" must be performed and service records must be kept for warranty documentation. Lack of proper service and maintenance records or documentation could void warranty.

The fuels and lubricants specified in the owner's manual or those of an equal quality must be used in accordance with the maintenance schedule.

The warranty or guarantee shall become void for damage and consequential damage caused by manipulations or conversions to the motorcycle.

The use of the motorcycle under extreme conditions, e.g. on extremely muddy and wet terrain, can lead to higher than average wear on components such as the drive train or the brakes. In this case it may become necessary to service or replace wear parts before the service limit specified in the maintenance schedule has been reached.



In accordance with the international quality management ISO 9001 standard, KTM uses quality assurance processes that lead to the highest possible product quality.

|  | Page |  | Page      |
|--|------|--|-----------|
| SERIAL NUMBER LOCATIONS                                    | .5   | Checking chain tension                                   | .25       |
| Chassis number   | .5   | Correct chain tension                                    | .25       |
| Engine number, engine type                                 | .5   | Chain maintenance  | .26       |
| OPERATION INSTRUMENTS                                      | .5   | Chain wear   | .26       |
| Clutch lever   | .5   | General informations about KTM disc brakes               | .27       |
| Hand decompression lever                                   | .5   | Adjusting of free travel at the hand brake lever         | .28       |
| Hand brake lever   | .6   | Checking of brake fluid level - front brake              | .28       |
| Choke lever  | .6   | Refilling the front brake fluid reservoir                | .28       |
| Ignition lock  | .6   | Checking the front brake pads                            | .28       |
| Socket for electric accessories                            | .6   | Changing the basic position of the brake pedal           | .29       |
| Multi-functional digital speedometer                       | .7   | Checking rear brake fluid level                          | .29       |
| Display  | .7   | Refilling the rear brake fluid reservoir                 | .29       |
| Setting options in the display                             | .8   | Checking the rear brake pads                             | .29       |
| Cooling liquid temperature display                         | .9   | Dismounting and mounting the front wheel                 | .30       |
| Indicator lamps  | .9   | Dismounting and mounting the rear wheel                  | .31       |
| Tachometer   | .9   | Checking the shock absorption rubbers in the rear hub    | .31       |
| Combination switch   | .10  | Tires, air pressure                                      | .32       |
| Starter tip switch, emergency OFF tip switch, light switch | .10  | Checking spoke tension                                   | .32       |
| Filler cap   | .10  | Changing the wheel size                                  | .32       |
| Fuel taps  | .10  | Battery  | .33       |
| Shift lever  | .11  | Charging the battery                                     | .33       |
| Kickstarter  | .11  | Fuses  | .34       |
| Foot brake pedal   | .11  | Removing and mounting the headlight mask                 | .34       |
| Compression damping of fork                                | .12  | Replacing the headlight bulb                             | .34       |
| Rebound damping of fork                                    | .12  | Exchanging the brake light and tail light bulb           | .35       |
| Compression damping of shock absorber                      | .12  | Removing the tank  | .35       |
| Rebound damping of shock absorber                          | .12  | Cooling system   | .36       |
| Baggage carrier / Grips                                    | .13  | Checking the cooling liquid level                        | .36       |
| Footrests  | .13  | Cleaning the air filter                                  | .37       |
| GENERAL TIPS AND WARNINGS FOR STARTING                     |      | Changing the original position of the clutch lever       | .38       |
| THE MOTORCYCLE   | .14  | Checking the oil level of the hydraulic clutch           | .38       |
| Instructions for initial operation                         | .14  | Adjusting the throttle cable                             | .38       |
| Running in   | .14  | Checking and adjusting the choke cable play              | .39       |
| DRIVING INSTRUCTIONS                                       | .15  | Checking the adjustment of the hand decompression cable  | .39       |
| Check the following before each start                      | .15  | Adjust idling speed                                      | .39       |
| Starting when the engine is cold                           | .16  | Draining of float chamber of the carburetor              | .40       |
| Starting when the engine is warm or hot                    | .17  | Engine oil   | .40       |
| What to do when the engine is „flooded“                    | .17  | Checking the engine oil level                            | .40       |
| Starting the engine with the kickstarter                   | .17  | Oil circuit  | .41       |
| Starting off   | .17  | Oil and screen filter change, bleeding of the oil system | .41       |
| Shifting/Riding  | .17  | Changing oil filter                                      | .42       |
| Braking  | .18  | TROUBLE SHOOTING   | .43       |
| Stopping and parking                                       | .18  | CLEANING   | .46       |
| Refueling  | .19  | CONSERVATION FOR WINTER OPERATION                        | .46       |
| Activating the ignition curve for low-octane fuel          | .19  | STORAGE  | .46       |
| PERIODIC MAINTENANCE SCHEDULE                              | .20  | RE-INITIATION AFTER TIME OF STORAGE                      | .46       |
| MAINTENANCE WORK ON CHASSIS AND ENGINE                     | .22  | TECHNICAL SPECIFICATIONS – ENGINE                        | .48       |
| Tool set   | .22  | TECHNICAL SPECIFICATIONS – CHASSIS                       | .50       |
| Removing the seat  | .22  | HEAD WORD INDEX  | .52       |
| Checking and adjusting steering head bearing               | .23  | WIRING DIAGRAM   | .APPENDIX |
| Bleeder screw front fork                                   | .23  |  |           |
| Cleaning the dust sleeves of the telescopic fork           | .23  |  |           |
| Changing the spring preload of the shock absorber          | .24  |  |           |
| Checking rubber ring on the WP rear shock absorber         | .24  |  |           |
| Lubricating the shock absorber linkage                     | .24  |  |           |

## SERIAL NUMBER LOCATIONS »

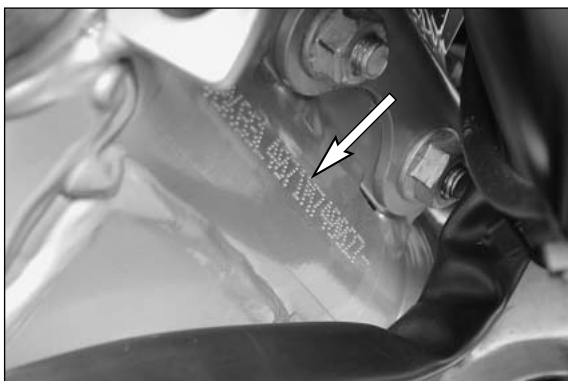

### Chassis number

The chassis number is stamped on the right side of the steering head tube. Write this number into the relevant area on page 1.

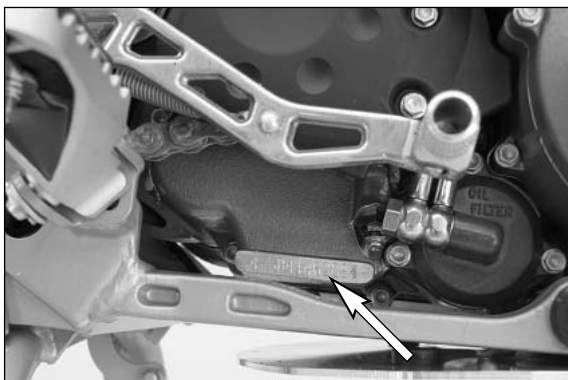

### Engine number, engine type

The engine number and engine type are stamped on the right hand side of the engine below the chain sprocket. Write this number into the relevant area on page 1.

## OPERATION INSTRUMENTS »

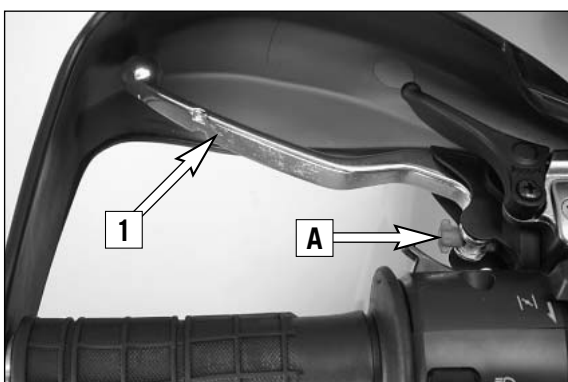

### Clutch lever

The clutch lever [1] is fitted on the left hand side of the handle bar. The adjusting screw [A] is used to change the original position of the clutch lever (see maintenance work on chassis and engine). The clutch is hydraulically actuated and adjusts itself automatically.

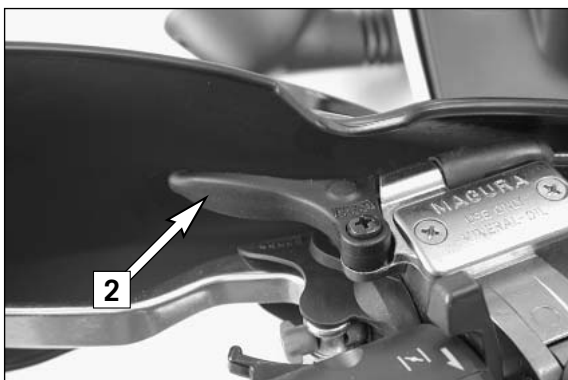

### Hand decompression lever

The hand decompression lever [2] is only used in two special cases:

- When the engine stalled.  
It is possible that the starter motor is not able to crank the engine on the next attempt. This is due to the fact that the automatic decompressor doesn't work properly. If this happens, pull the manual decompression lever and start again. Afterwards normal starting will be possible.
- When you want to push the motorcycle.  
While pushing, pull the hand decompression lever to make it easier to get the engine going.

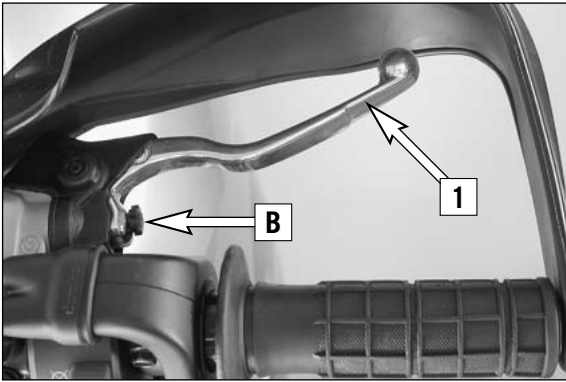

## Hand brake lever

The hand brake lever [1] is mounted on the handlebar on the right and actuates the front wheel brake. The adjusting screw [B] is used to change the original position of the hand brake lever (see maintenance work on chassis and engine).



## Choke lever

If the choke lever [2] is pulled backwards, a bore will be opened in the carburetor through which the engine may draw in additional fuel. This produces a „rich“ fuel/air mixture necessary for cold start. If the choke lever is pushed forward up to the stop, the bore will be closed again. In this position the choke cable must have a play of approx. 2 mm.



## Ignition lock

Switch positions of ignition lock

- Ignition off, (engine can't be started)
- Ignition on, (engine can be started)
- Ignition off, handlebar blocked

To switch the ignition to position turn the ignition key to position and firmly press it into the lock. Turn the handlebar to the left, then turn the ignition key to the left.

The ignition key can be withdrawn in position and .

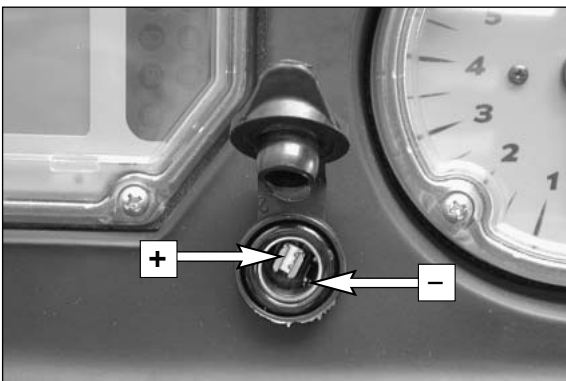

## Socket for electric accessories

A socket is provided in the cockpit for electric accessories, e.g. GPS, road-book, cell phone, etc.

The socket has a 12V voltage and is protected by a 5 A fuse. Do not plug power consumers with a higher requirement into this socket.

You can also use this socket to charge the battery with a maximum of 14.4 volts and 4 amperes.

### ! CAUTION

- REMEMBER THAT ELECTRIC ACCESSORIES WILL RUN DOWN THE BATTERY.
- THE DIGITAL SPEEDOMETER CAN BE DESTROYED IF THE ABOVE CHARGING LIMITS ARE EXCEEDED.

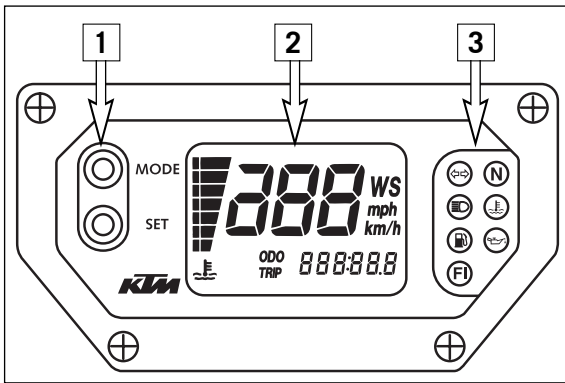

## Multi-functional digital speedometer

The universal instrument is divided into 3 parts. Use the MODE and SET [1] button to change the display and the basic settings in the display. Display [2] shows all of the information that may be of interest to you. 5 display modes can be selected with the MODE button.

The indicator lamps [3] provide additional information on the motorcycle's running condition.

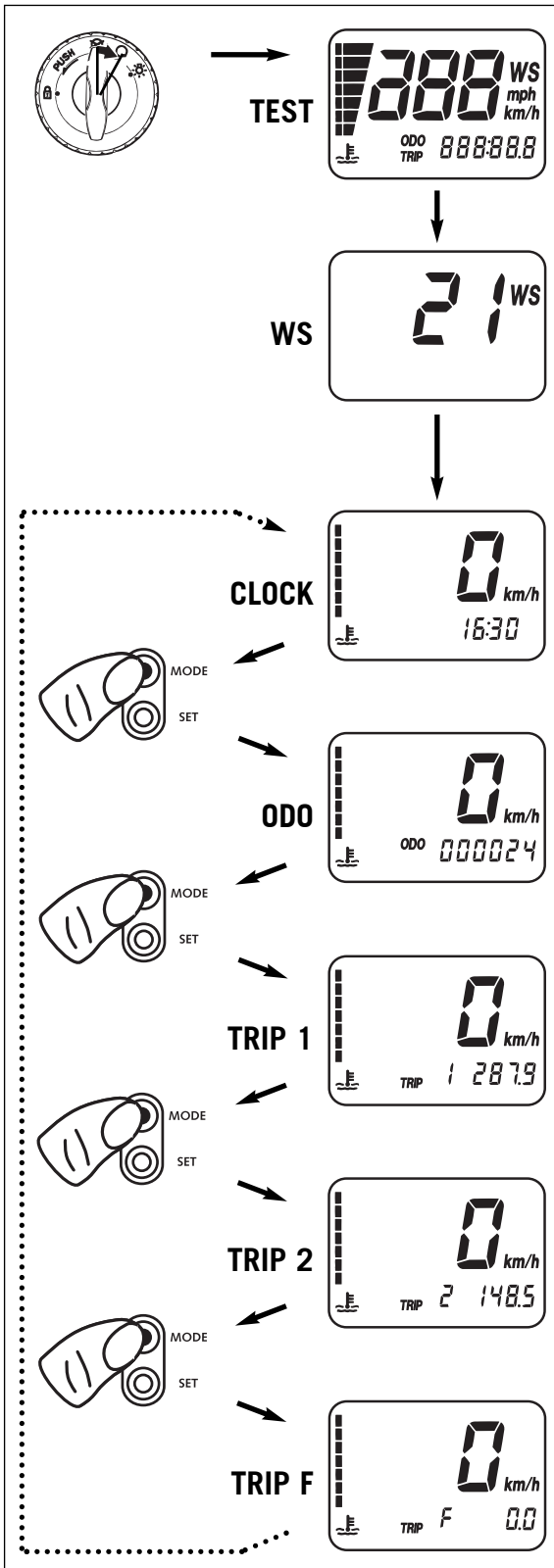

## Display

### TEST

When you switch on the ignition, all of the display elements will light up for 1 second for the function test.

### WS (wheel size)

The display will change and show the diameter of the front wheel in inches for 1 second (WS = wheel size). Then the CLOCK mode will be displayed, or the mode that was active when the ignition was switched off.

### CLOCK

You will recognize the CLOCK display by the blinking dots between the hours and minutes. It displays the speed, temperature of the cooling liquid and the clock.

To switch to the next display mode, press the MODE button.

### ODO

The speed, temperature of the cooling liquid and the total kilometers or miles traveled are shown in the ODO mode.

To switch to the next display mode, press the MODE button.

### TRIP 1

The TRIP 1 mode shows the speed, the temperature of the cooling liquid and the trip odometer 1.

To switch to the next display mode, press the MODE button.

### TRIP 2

The TRIP 2 mode shows the speed, the temperature of the cooling liquid and the trip odometer 2.

To switch to the next display mode, press the MODE button.

### TRIP F

The TRIP F (fuel) mode shows the speed, the temperature of the cooling liquid and the distance traveled since reaching the low-fuel mark (the low-fuel indicator lamp lights up).

To return to the UHR mode, press the MODE button.



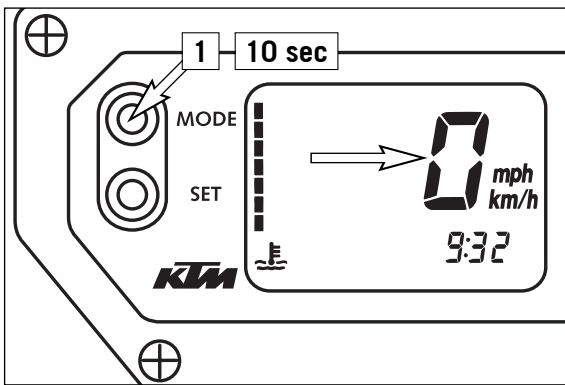

## Setting options in the display

### KILOMETERS OR MILES.

You can have the speed and distance shown in kilometers or miles in the display. The display can be adapted to the respective country on long-distance trips.

To switch from kilometers to miles, switch on the ignition and press the MODE [1] button for approx. 10 seconds. The **km/h** display will switch to **mph**. The speed and the stored distances will be converted and displayed in miles.

To return to kilometers, proceed as described above.

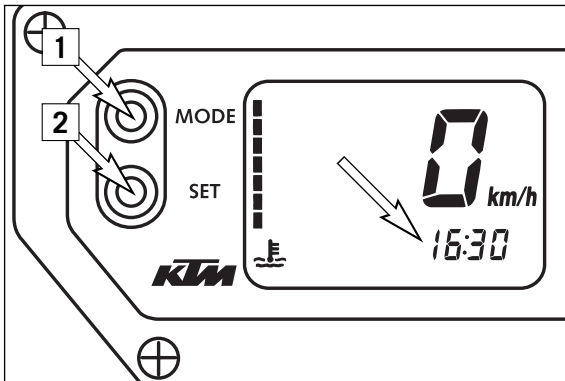

### CLOCK

Switch on the ignition and change to the CLOCK mode.

Simultaneously press MODE [1] and SET [2]. The numbers on the clock will start to blink. Use the MODE button to set the hours and the SET button to set the minutes.

To press the MODE and SET buttons simultaneously.

### NOTE:

**0:00** will be displayed if the clock is not supplied with electricity. This can be caused by a defective fuse or a fault in the board electric system (see Troubleshooting).

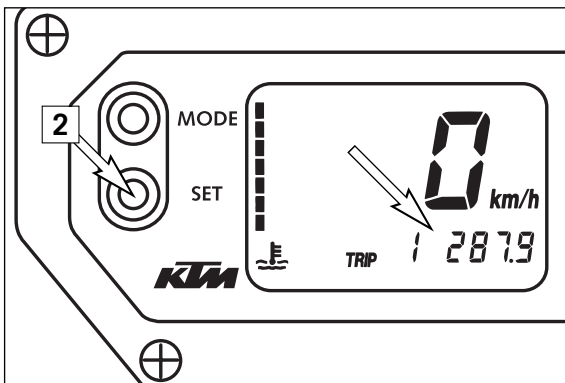

### TRIP 1

The trip meter 1 runs continuously and counts up to 999.9. It can be used to measure the length of a certain route on a trip or the distance between two refueling stops.

To return the trip meter 1 to zero, switch on the ignition, change to the TRIP 1 mode and press the SET button.

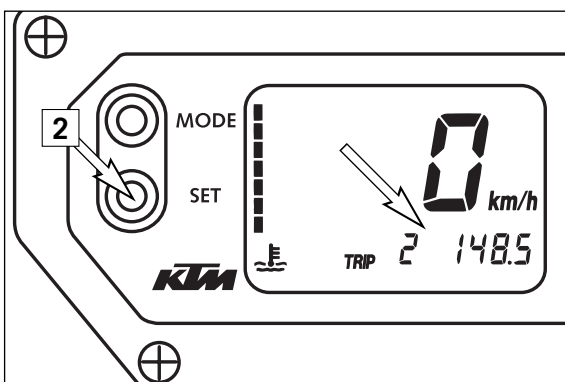

### RESETTING TRIP 2

The trip meter 2 runs continuously and counts up to 999.9. It can be used similarly to TRIP 1 or together with a switch available as an accessory (see below) for trips according to a roadbook.

To return the trip meter 2 to zero, switch on the ignition, change to the TRIP 2 mode and press the SET button.

### NOTE:

A Tripmaster switch (Part no. 582.14.069.044) is available as an accessory and enhances the trip meter 2 functions. You can correct the displayed route by increasing or decreasing in increments of 0.1. For example, if you have taken the wrong road when driving according to a roadbook, you can easily correct the display to correspond to the roadbook again. It can also be used to change the display modes. The switch is mounted on the handlebars so that you can keep your hands on the handlebars.

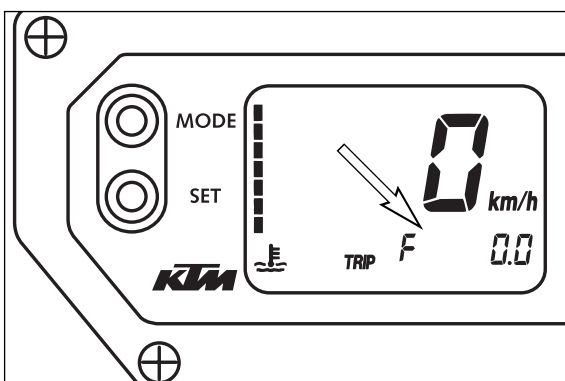

### TRIP F

When the fuel level reaches the reserve mark, the display will automatically switch to TRIP F and begin to count (no matter which display mode was active before). At the same time, the fuel warning lamp will light up. You will still have enough reserve fuel for at least 35 kilometers.

After refueling, it will take approx. 8 minutes for the fuel warning lamp to switch off and for TRIP F to automatically reset to 0 and return to the previous display mode.

NOTE: Press the SET key for 2 seconds to immediately turn off the fuel warning lamp.

NOTE: To use up the reserve fuel in the tank, move the fuel cock to the RES position by hand.

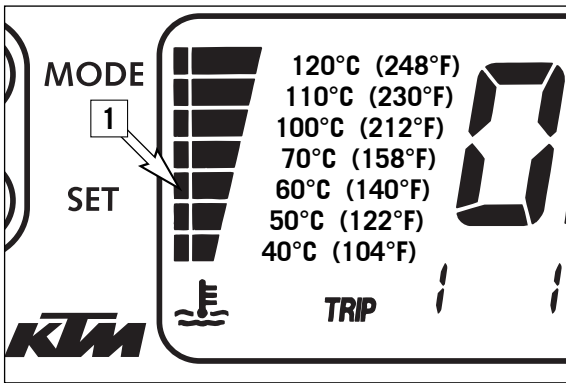

## Cooling liquid temperature display

The temperature display [1] is shown in 7 bars. The more bars that light up, the hotter the cooling liquid. When the lowest bar lights up, the cooling liquid has reached a temperature of approx. 40°C (104°F). When the upper bar lights up 120°C (248°F), all of the bars will start to blink and the red warning lamp [2] will light up.

### ⚠ WARNING

POSSIBLE CAUSES FOR AN INCREASE IN TEMPERATURE, CAUSING THE RED WARNING LIGHT FOR THE COOLING LIQUID TEMPERATURE TO LIGHT UP (ALSO SEE PAGE 36):

- DRIVING TOO SLOWLY AND DRIVING WITH A HEAVY LOAD AT HIGH AIR TEMPERATURES
- NOT ENOUGH COOLING LIQUID IN THE SYSTEM
- THE VENTILATOR ON THE LEFT RADIATOR IS NOT RUNNING
- IMPROPER USE OF THE CLUTCH WHEN DRIVING SLOWLY

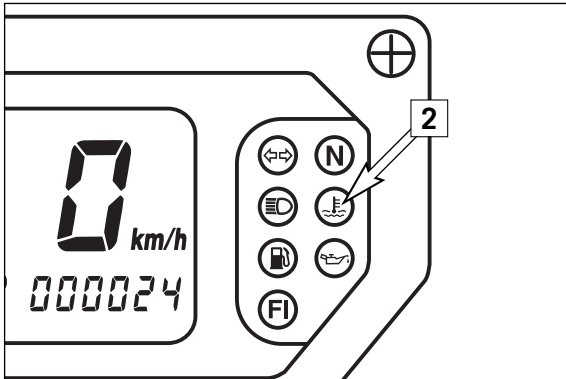

## Indicator lamps



The green indicator lamp will blink in the blinker rhythm when the blinker is switched on.

NOTE:

The indicator lamp will blink slower when a blinker is broken.



The green indicator lamp will light up when the gearbox is in an idling position.



The blue indicator lamp will light up when the high beams are switched on.



The red warning light will light up when the cooling liquid has reached a temperature of approx. 120°C (248°F).



The orange warning light will light up when the fuel level has reached the reserve mark. At the same time the display will automatically change to TRIP F (see TRIP F).



This warning light has no function.



This indicator lamp has no function.

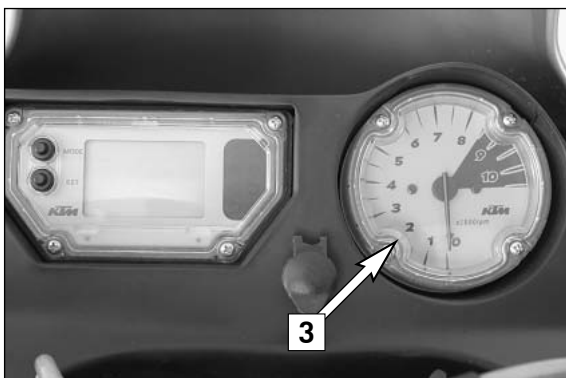

## Tachometer

The tachometer [3] shows the engine speed in revolutions per minute (rpm). Do not push the engine into the black zone, which begins at 8500 rpm.

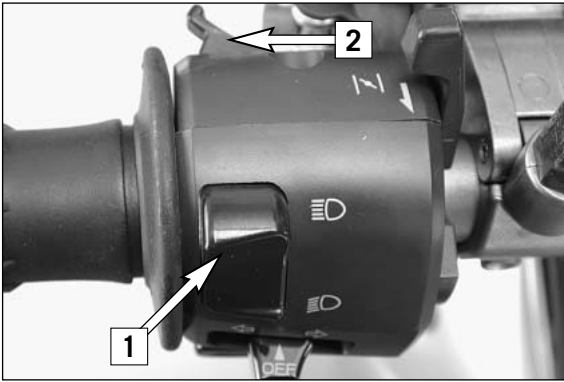

## Combination switch

The rocker switch LIGHTS [1] actuates the high beam or low beam.

 = High-beam light

 = Low-beam light

 = The light signal (high beam) is actuated with button [2].

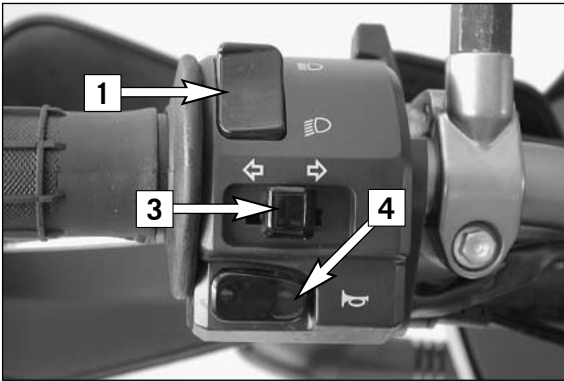

 The indicator switch [3] returns to central position after actuation. Press flasher switch towards switch housing to switch off the flasher.

 The horn is sounded with button [4].

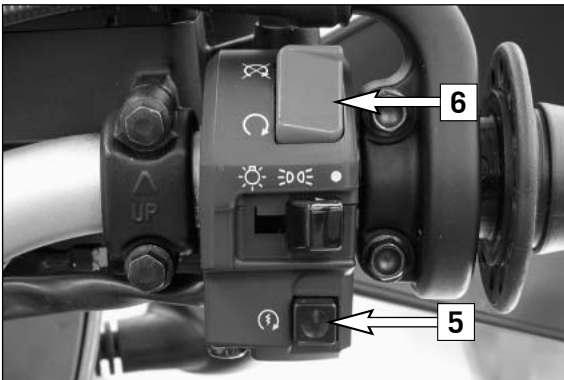

## Starter tip switch, emergency OFF tip switch, light switch

 Use the starter tip switch [5] to operate the electric starter.

The light switch has 3 positions:

 = Light off

 = Parking light on

 = Headlight on

The emergency off switch [6] is provided for emergency situations and should not be used to switch off the engine.

The engine is ready for operation in position  (ignition circuit and starter circuit are switched on).

The engine cannot be started in position  (ignition circuit and starter circuit are interrupted).

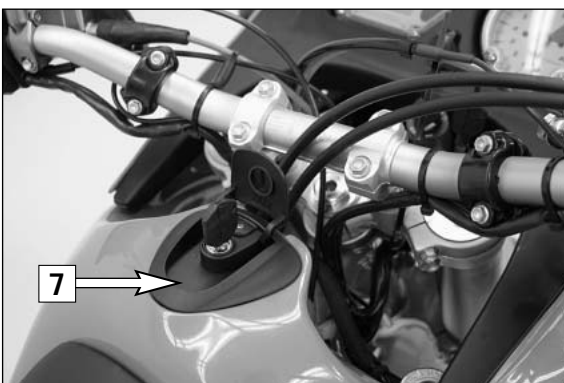

## Filler cap

The filler cap [7] can be locked and is provided with a fuel evaporation control system.

To open the cap insert the ignition key, turn it 90° counterclockwise, then lift off the filler cap.

To close the tank insert the filler cap, turn the ignition key 90° clockwise and take out the key.

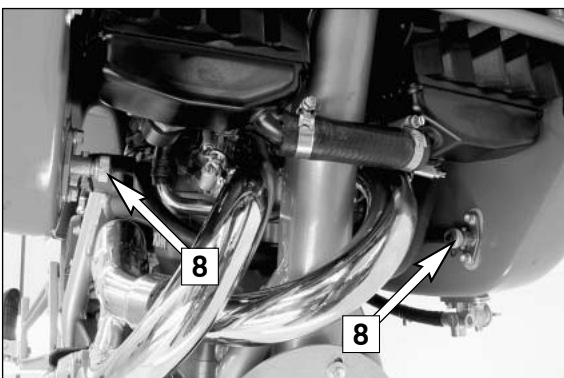

## Fuel taps

The motorcycle is equipped with a fuel taps and 2 auxiliary fuel cocks [8]. A fuel pump pumps the fuel from the tank to the carburetor.

The auxiliary fuel cocks on the inside of the tank are connect the two tank chambers via a line. They must always be open.

Open position: turn the knob to the limit in a counter-clockwise direction.

### NOTE:

Only close the two auxiliary fuel cocks when you remove the fuel tank (see chapter on removing the tank).

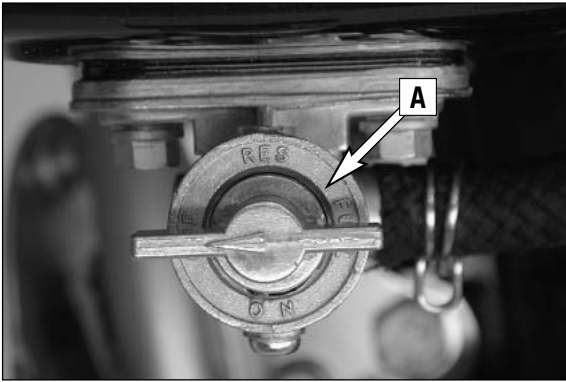

Fuel tap [A] on the left side of the tank has 3 positions.

- OFF** In this position the fuel tap is closed. No fuel can flow to the carburetor.
- ON** When using the motorcycle, the twist grip must be set to the **ON** position. Now fuel can flow to fuel pump. In this position the tank empties down to the fuel reserve of approx. 3,5 liters (0,9 US gallone).
- RES** The reserve, approximately 3,5 liters (0,9 US gallone), cannot be tapped until the twist grip is turned to the **RES** position. Fill the tank as soon as possible and remember to turn the twist grip back to the **ON** position so that you will have backup fuel next time, too.

NOTE:

The fuel tap must be open during operation. The fuel tap must be closed for parking.

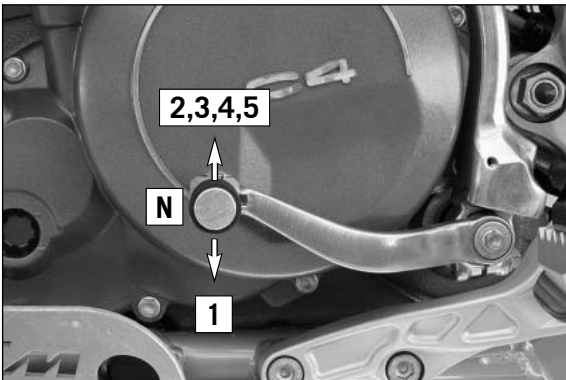
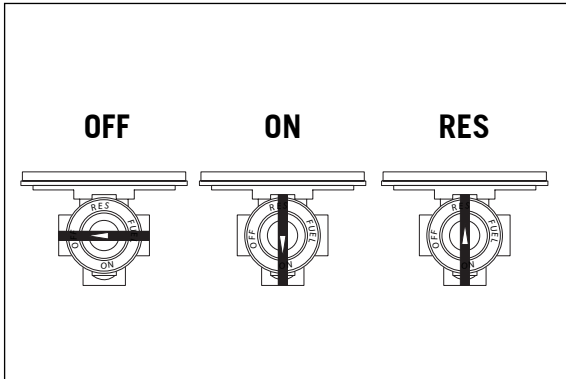

## Shift lever

The shift lever is mounted on the left side of the engine. The position of the gears is shown in the illustration. Neutral, or the idle speed, is located between first and second gear.



## Kickstarter

The kickstarter is mounted on the left side of the engine. Its upper part can be swivelled.

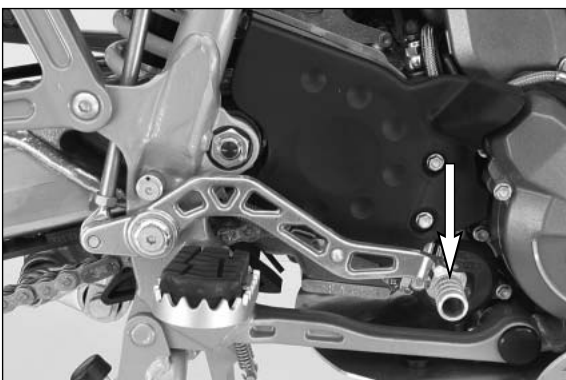

## Foot brake pedal

The foot brake pedal is located in front of the right footrest. Its basic position can be adjusted to your seat position (see maintenance work).

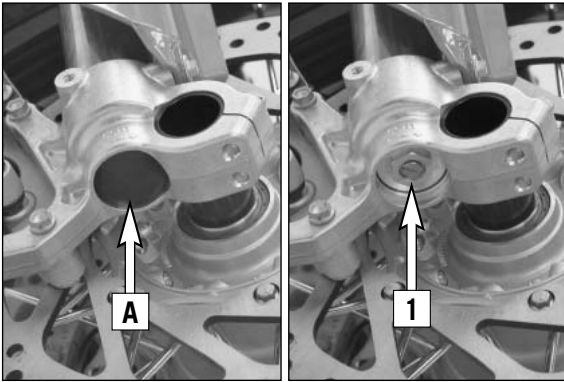

## Compression damping of fork

The compression damping is to be set at the lower end of the fork tubes. It only regulates the degree of damping during compression. Remove closing cap **[A]**. By using the knob **[1]** (COM), the degree of damping of the compression can be adjusted. Turn the knob clockwise to increase damping, turn it counterclockwise to reduce damping during compression.

### BASIC SETTING

- turn rotary knob clockwise as far as it will go
- turn it back counterclockwise by as many clicks as are specified for the relevant type of fork

WP 14187B26 . . . .16 clicks

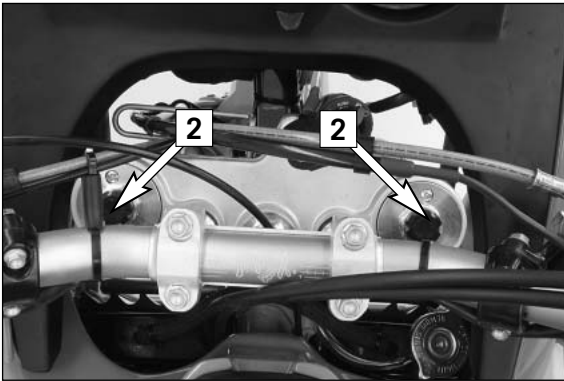

## Rebound damping of fork

The rebound damping is to be set at the upper end of the fork tubes. It only regulates the degree of damping during rebounding. By using the knob **[2]** (REB), the degree of damping of the rebound can be adjusted. Turn the knob clockwise to increase damping, turn it counterclockwise to reduce damping during rebounding.

### BASIC SETTING

- turn rotary knob clockwise as far as it will go
- turn it back counter-clockwise by as many clicks as are specified for the relevant type of fork

WP 14187B26 . . . .12 clicks

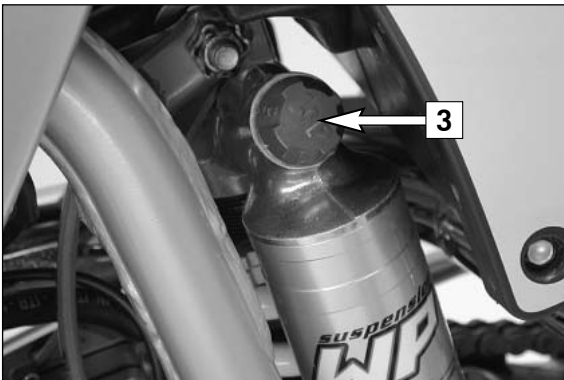

## Compression damping of shock absorber

With the knob **[3]** the degree of damping of the compression can be adjusted to 7 positions. Turn the knob counterclockwise to increase damping, turn it clockwise to reduce damping during compression.

### BASIC SETTING:

WP 01187B04 . . . .position 6

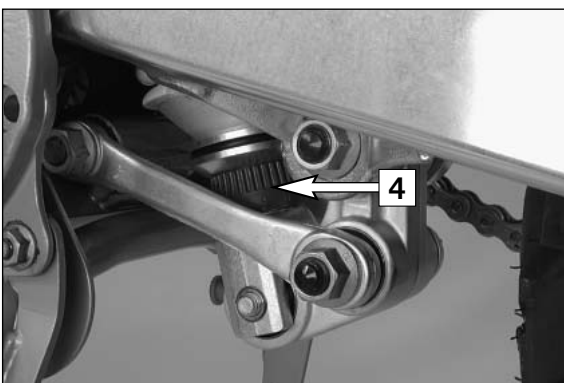

## Rebound damping of shock absorber

With the setting wheel **[4]** the degree of damping of the rebound can be adjusted to 11 positions. Turn the knob to the left side to increase damping, turn it to the right side to reduce damping during rebounding.

### BASIC SETTING:

WP 01187B04 . . . .position 7

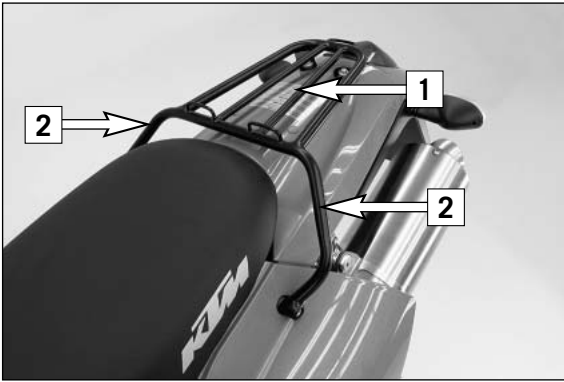

### Baggage carrier / Grips

The baggage carrier [1] may be loaded with up to 10 kg. The two lateral hoops [2] serve as handles for the passenger



### Footrests

The passenger footrests [3] fold up.

## Instructions for initial operation

- Make sure the work for the „pre-delivery inspection“ was performed by your authorized KTM workshop. The DELIVERY CERTIFICATE and SERVICE MANUAL will be handed over when you pick up your vehicle.
- Read the entire manual carefully before your first drive.
- Enter the chassis, engine and key numbers on page 1.
- Familiarize yourself with the operating elements.
- Adjust the foot brake pedal to the most comfortable positions for you.
- Make the basic settings on the multi-functional digital speedometer.
- Get used to handling the motorcycle on an empty car park, before starting on a longer drive. Also try to drive as slowly as possible and in standing position, to improve your feeling for the vehicle.
- Do not drive along off-road tracks which go beyond your ability and experience.
- Hold the handlebar with both hands and leave your feet on the foot rests while driving.
- Remove your foot from the foot brake pedal when you are not braking. If the foot brake pedal is not released the brake pads rub continuously and the braking system is overheated.
- You may only be accompanied by a passenger if your motorcycle is fitted and registered for such purposes. The passenger must hold tight to the brackets or hold on to the driver during the drive, with his feet on the passenger foot rests.
- Do not make any alterations to the motorcycle and always use ORIGINAL KTM SPARE PARTS. Spare parts from other manufacturers can impair the safety of the motorcycle.
- New tires have a smooth surface and must be run in. For this purpose, carefully ride the motorcycle at moderate speed, tilting the vehicle at different angles so that the surface is evenly roughened. Tires will not display their full grip characteristics before they are properly run in.
- Motorcycles are sensitive to changes in the weight distribution. Read the section on "Accessories and payload" when carrying luggage.
- Pay attention to running in instructions.

## Running in

Even finely machined surfaces of engine parts have rougher surfaces than parts that slide on each other for a long time. Therefore, every engine must be run in. For this reason, do not demand maximum performance from the engine for the first 100 kilometers. The vehicle must be run in at low, changing performance level for the first 1000 KM (620 miles). The maximum number of revolutions per minute must not go exceed 4800 rpm. Do not accelerate the engine up to the black mark on the tachometer (8500 r.p.m.) during a running-in period of 1000 km. Exceeding the above listed rotations as well as pushing high rpm when the engine is cold will have an adverse effect on the life of your engine.

## ⚠ WARNING

- WEAR SUITABLE CLOTHING WHEN DRIVING A MOTORCYCLE. CLEVER KTM DRIVERS ALWAYS WEAR A HELMET, BOOTS, GLOVES AND A JACKET, REGARDLESS OF WHETHER DRIVING ALL DAY OR JUST FOR A SHORT TRIP. THE PROTECTIVE CLOTHING SHOULD BE BRIGHTLY COLOURED SO THAT OTHER USERS OF THE ROADS CAN SEE YOU AS EARLY AS POSSIBLE. YOUR PASSENGER OF COURSE WILL ALSO NEED SUITABLE PROTECTIVE CLOTHING.
- ALWAYS TURN ON THE LIGHT MAKE SURE THAT OTHER DRIVERS BECOME AWARE OF YOU AS EARLY AS POSSIBLE.
- DO NOT DRIVE AFTER HAVING CONSUMED ALCOHOL.
- DRIVE AT A MODERATE SPEED FOR THE FIRST FEW KILOMETERS OF EACH TRIP TO ALLOW THE TIRES TO REACH THE NECESSARY OPERATING TEMPERATURE. MAXIMUM ROAD GRIP IS ASSURED WHEN THE TIRES ARE WARM.
- THE FRONT AND REAR WHEEL ARE ONLY ALLOWED TO BE TIRED WITH TIRES THAT HAVE THE SAME PROFILE TYPE.
- OBSERVE THE TRAFFIC REGULATIONS, DRIVE DEFENSIVELY AND TRYING TO LOOK AHEAD AS FAR AS POSSIBLE SO THAT ANY HAZARDS CAN BE RECOGNIZED AS EARLY AS POSSIBLE.
- ADJUST YOUR DRIVING SPEED ACCORDING TO THE CONDITIONS AND YOUR DRIVING SKILLS.
- DRIVE CAREFULLY ON UNKNOWN ROADS
- REPLACE THE HELMET VISOR RESPECTIVELY GOGGLE GLASSES IN PLENTY OF TIME. WHEN LIGHT SHINES DIRECTLY ON SCRATCHED VISOR OR GOGGLES, YOU WILL BE PRACTICALLY BLIND.
- NEVER LEAVE YOUR MOTORCYCLE WITHOUT SUPERVISION AS LONG AS THE ENGINE IS RUNNING.

## Accessories and payload

Accessory parts and baggage can significantly decrease a motorcycle's driving stability. Please observe the following warnings.

## ⚠ WARNING

- ONLY USE ACCESSORIES THAT HAVE BEEN RELEASED BY KTM. FOR EXAMPLE, FRONT PANELLING CAN IMPAIR THE DRIVING PROPERTIES OF THE MOTORCYCLE. CASES, EXTRA TANKS ETC. CAN ALTER THE WEIGHT DISTRIBUTION AND THUS ALSO IMPAIR THE VEHICLE'S DRIVING PROPERTIES.
- NEVER DRIVE FASTER THAN 130 KPH (80 MPH) IF YOUR MOTORCYCLE IS LOADED WITH CASES OR OTHER BAGGAGE. THEY WILL IMPAIR THE MOTORCYCLE'S HANDLING AT HIGHER SPEEDS AND CAN EASILY CAUSE IT TO GO OUT OF CONTROL
- IF YOU HAVE CASES MOUNTED, DO NOT EXCEED THE MANUFACTURER'S RECOMMENDED MAXIMUM PAYLOAD.
- FASTEN THE BAGGAGE CLOSE TO THE CENTER OF THE MOTORCYCLE AND DISTRIBUTE THE WEIGHT EVENLY ON THE FRONT AND REAR WHEELS AND ON THE LEFT AND RIGHT.
- BAGGAGE MUST BE SECURELY AND ADEQUATELY FASTENED; LOOSE BAGGAGE WILL SIGNIFICANTLY IMPAIR DRIVING SAFETY.
- A HIGH PAYLOAD WILL CHANGE THE MOTORCYCLE'S HANDLING AND CONSIDERABLY INCREASE THE BRAKING DISTANCE; ADAPT YOUR DRIVING SPEED ACCORDINGLY.
- NEVER EXCEED THE MAXIMUM PERMISSIBLE LADEN WEIGHT AND THE AXLE WEIGHTS. THE MAXIMUM PERMISSIBLE LADEN WEIGHT IS MADE UP OF THE FOLLOWING COMPONENTS:
  - MOTORCYCLE READY FOR OPERATION AND TANK FULL
  - LUGGAGE
  - DRIVER AND PASSENGER WITH PROTECTIVE CLOTHING AND HELMET.

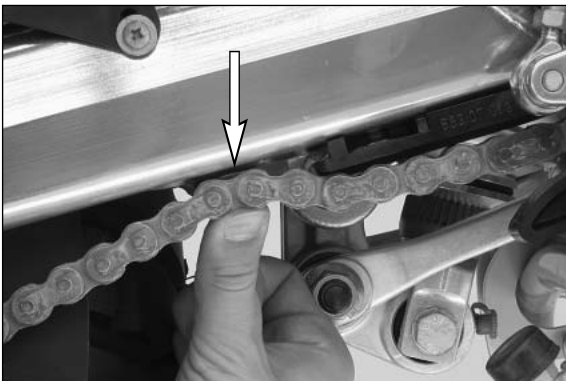
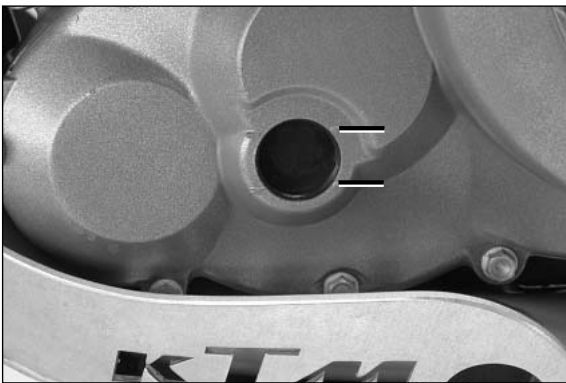

## Check the following before each start

When you start off, the motorcycle must be in a perfect technical condition. For safety reasons, you should make a habit of performing an overall check of your motorcycle before each start.

The following checks should be performed:

- 1 CHECK THE OIL LEVEL**  
Insufficient oil results in premature wear and consequently to engine damage.
  - 2 FUEL**  
Check the fuel level in the tank.
  - 3 CHAIN**  
A loose chain can fall off; an extremely worn chain can tear, and insufficient lubrication can result in unnecessary wear to the chain and rear sprockets.
  - 4 TIRES**  
Check for damaged tires. Tires showing cuts or dents must be replaced. The tread depth must comply with the legal regulations. Also check the air pressure. Insufficient tread and incorrect air pressure reduce the driving performance.
  - 5 BRAKES**  
Check correct functioning of the braking system. Check for sufficient brake fluid in the reservoir. The reservoirs have been designed in such a way that brake fluid does not need to be refilled even when the brake pads are worn. If the level of brake fluid falls below the minimum value, this indicates a leak in the braking system or completely worn out brake pads. Arrange for the braking system to be checked by a KTM specialist garage, as complete failure of the braking system can be expected. Also check the state of the brake hoses and the thickness of the brake linings.  
Check free travel at hand brake lever and foot brake pedal.
- ⚠ WARNING**
- IF THE RESISTANCE IN THE HAND BRAKE LEVER OR FOOT BRAKE PEDAL FEELS "SPONGY" (TOO MUCH GIVE), THIS IS AN INDICATION THAT SOMETHING IS WRONG WITH THE BRAKE SYSTEM. DON'T RIDE YOUR MOTORCYCLE ANYMORE WITHOUT FIRST HAVING THE BRAKE SYSTEM LOOKED OVER BY A KTM DEALER.
- 6 CABLES**  
Check correct setting and easy running of all control cables.
  - 7 COOLING LIQUID**  
Check the level of cooling liquid when the engine is cold.
  - 8 ELECTRICAL SYSTEM**  
Check headlight, parking light, tail light, brake light, flashers, indicator lamps and horn for faultless operation.
  - 9 LUGGAGE**  
If you are taking luggage with you, check that this is securely fastened.





## Starting when the engine is cold

- 1 Open the fuel tap.
- 2 Turn on the ignition (ignition key position: ○).
- 3 Switch the gear to neutral (green lamp [1] lights).
- 4 Switch on the emergency off switch [2].
- 5 Operate the choke lever [3].
- 6 Operate the starter tip switch [4] without accelerating.
- 7 If the engine starts, push the choke lever back a little bit, as soon as the engine runs unevenly.
- 8 Swing up the centerstand
- 9 Switch on the light before setting off.

### ⚠ WARNING

DO NOT START THE ENGINE AND ALLOW IT TO IDLE IN A CLOSED ROOM. EXHAUST FUMES ARE POISONOUS AND CAN CAUSE LOSS OF CONSCIOUSNESS AND DEATH. ALWAYS PROVIDE ADEQUATE VENTILATION WHILE THE ENGINE IS RUNNING.

### ! CAUTION

- MAXIMUM PERIOD FOR CONTINUOUS STARTING: 5 SECONDS. WAIT AT LEAST 5 SECONDS BEFORE TRYING AGAIN.
- DON'T RIDE YOUR MOTORCYCLE WITH FULL LOAD AND DON'T REV ENGINE WHEN COLD. BECAUSE THE PISTON IS WARMING UP FASTER THAN THE WATER COOLED CYLINDER, IT CAN CAUSE ENGINE DAMAGE. ALWAYS KEEP IN MIND THAT THE ENGINE SHOULD BE WARMED UP WITH SMALL LOAD AT MEDIUM R.P.M.

IF THE ENGINE DOES NOT CRANK WHEN YOU ACTUATE THE STARTER TIP SWITCH:

- the transmission is switched to idle
- Check if the emergency OFF switch is on
- Check if the ignition is on
- the headlight is on. (Light switch in ☀ position).
  - If this is not the case, the battery is discharged
  - If the lights are on, proceed as described in the „Trouble-shooting“ section or contact a KTM dealer.

IF THE ENGINE CRANKS BUT DOES NOT START, WHEN YOU ACTUATE THE STARTER TIP SWITCH:

- Check if the fuel tap is open
- Check if the choke lever has been operated
- Check if sufficient fuel is in the tank
  - If this is not the case, refill the tank
  - if sufficient fuel is in the tank, proceed as described in the „Trouble-shooting“ section or contact a KTM dealer.

### NOTE:

If you have trouble starting the motorcycle, this could be due to old fuel in the float chamber. The easily inflammable components of the new fuels evaporate during longer periods of standstill. When the motorcycle has been out of operation for more than a week, it is therefore recommended to drain the old fuel from the float chamber. The engine will immediately start off when the float chamber is filled with new fuel.

### NOTE:

This motorcycle is equipped with a safety starting system. The engine can only be started if the transmission is in neutral or the clutch lever is pulled. If the side stand is folded down, the engine can only be started if the transmission is in neutral or the clutch lever is pulled. The engine will stall if a gear is engaged and the clutch lever is released with the side stand folded down.

THE ELECTRIC STARTER DOESN'T CRANK THE ENGINE WHEN THE STARTER TIP SWITCH IS OPERATED EVEN THOUGH SUFFICIENT ELECTRIC CURRENT IS AVAILABLE:

- Pull the hand decompression lever [5], start and release the lever.

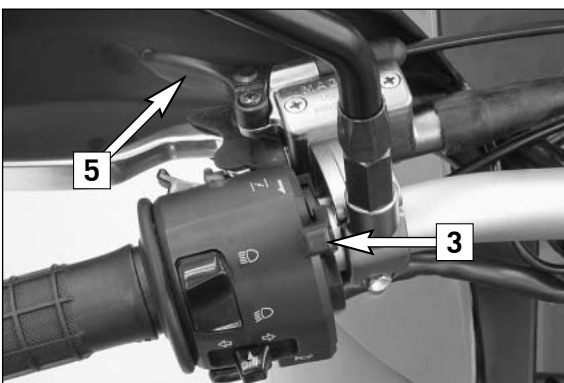
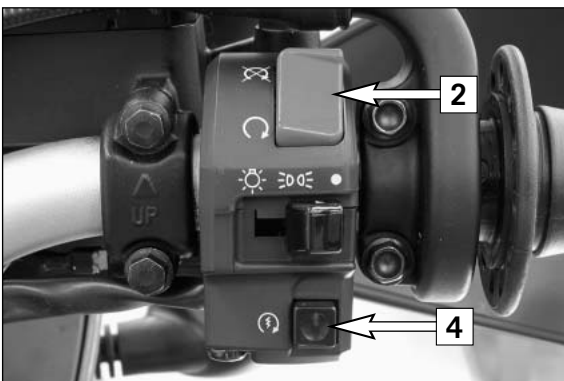
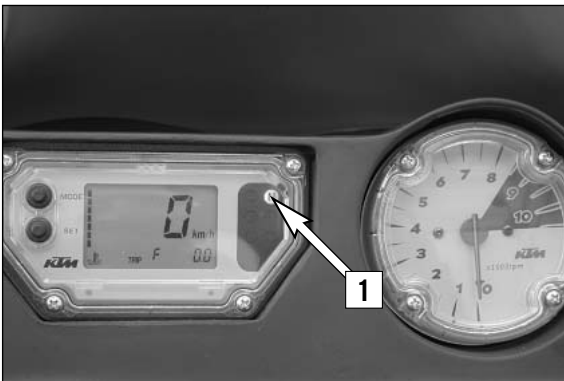

## Starting when the engine is warm or hot

- 1 Open the fuel tap.
- 2 Turn on the ignition (ignition key position: ○).
- 3 Switch the gear to neutral (green lamp [1] lights).
- 4 Switch on the emergency off switch [2].
- 5 Operate the starter switch [4] without accelerating.
- 6 Swing up the centerstand
- 7 Switch on the light before setting off.

## What to do when the engine is „flooded“

The throttle must be fully opened when starting. If necessary change spark plug.

## Starting the engine with the kickstarter

Be sure to kick up the side or center stand before you start the engine to avoid any damage. Start as described above, then push the kickstarter hard all the way.

### ⚠ WARNING

- IF YOU WANT TO START THE ENGINE, MAKE SURE THAT YOU ALWAYS PUT ON STURDY MOTORCYCLE BOOTS IN ORDER TO AVOID INJURIES. YOU MIGHT SLIP OFF THE KICKSTARTER, OR THE ENGINE MAY KICK BACK THE KICKSTARTER.
- ALWAYS KICK KICKSTARTER BRISKLY ALL THE WAY WITHOUT OPENING THE THROTTLE. KICKING THE KICKSTARTER WITH NOT ENOUGH MOMENTUM, AND AN OPENED THROTTLE GRIP INCREASE THE KICK-BACK HAZARD.
- AT TEMPERATURES BELOW ZERO, MAKE SURE THE KICKSTARTER IS LATCHED IN PLACE BEFORE DEPRESSING IT.

### ! CAUTION

BEFORE YOU ACTUATE THE KICKSTARTER, BE SURE TO KICK UP THE SIDE STAND.



## Starting off

Pull the clutch lever. Put the engine into first gear, slowly release the clutch lever and open throttle at the same time.

### ⚠ WARNING

BEFORE YOU START OFF, CHECK THAT THE CENTER STAND HAS BEEN SWUNG RIGHT UP TO THE TOP. IF THE STAND DRAGS ON THE GROUND, THE MOTORCYCLE CAN GO OUT OF CONTROL.

## Shifting/Riding

You are now in first gear, referred to as the drive or uphill gear. Depending on the conditions (traffic, road gradient, etc.), you can shift to a higher gear. Close throttle, at the same time pull clutch lever and shift to the next higher gear. Let clutch lever go again and open throttle. If you turned on the choke, make sure you turn it off again as soon as engine is warm.

When you reach full speed through turning the throttle grip all the way, turn throttle back to 3/4; the speed hardly decreases although the engine will use less gas. Never open the throttle wider than the engine can handle. Excessive turning of the throttle grip will increase full consumption.

By shifting down, use the brakes if necessary and close throttle at the same time. Pull clutch lever and shift down to the next gear. Let clutch lever go slowly and open throttle or shift down again. If the engine is killed f.ex. at a crossing, simply pull the clutch lever and start. It is not necessary to switch the gear to NEUTRAL.

### ⚠ WARNING

- AVOID ABRUPT LOAD CYCLES IN CURVES AND ON WET OR SLIPPERY ROADS. OTHERWISE, THE MOTORCYCLE COULD EASILY GET OUT OF CONTROL.
- NEVER TURN THE IGNITION KEY TO POSITION ☒ OR Ⓜ WHILE THE MOTORCYCLE IS MOVING.
- DO NOT TRY TO CHANGE THE SETTINGS OF THE MULTIFUNCTIONAL DIGITAL SPEEDOMETER WHILE DRIVING. YOUR ATTENTION WILL BE DISTRACTED FROM THE TRAFFIC AND MAY CAUSE YOU TO LOSE CONTROL OF YOUR MOTORCYCLE.
- AFTER FALLING WITH THE MOTORCYCLE, CHECK ALL FUNCTIONS THOROUGHLY BEFORE STARTING UP OPERATIONS AGAIN.

### ! CAUTION

- HIGH RPM RATES WHEN THE ENGINE IS COLD HAVE AN ADVERSE EFFECT ON THE LIFE OF YOUR ENGINE. WE RECOMMEND YOU RUN THE ENGINE IN A MODERATE RPM RANGE FOR A FEW MILES GIVING IT A CHANCE TO WARM UP. AFTER THAT NO FURTHER PRECAUTIONS IN THIS RESPECT NEED BE TAKEN.
- SHIFT TO THE NEXT HIGHER GEAR BY 8500 RPM AT THE LATEST.
- NEVER HAVE THE THROTTLE WIDE OPEN WHEN CHANGING DOWN TO A LOWER GEAR. THE ENGINE WILL OVERSPEED, DAMAGING THE VALVES. IN ADDITION, THE REAR WHEEL BLOCKS SO THAT THE MOTORCYCLE CAN EASILY GET OUT OF CONTROL.
- IF THE RED COOLING LIQUID TEMPERATURE LAMP LIGHTS UP WHILE YOU ARE DRIVING, THIS INDICATES COOLING SYSTEM TROUBLE. IMMEDIATELY STOP AND TURN OFF THE ENGINE. DRIVING WITH THE WARNING LAMP ON WILL CAUSE ENGINE DAMAGE.
- PLACE A CLOTH ON THE RADIATOR CAP. OPEN THE CAP SLOWLY, SO THE EXCESS PRESSURE IN THE COOLING SYSTEM CAN ESCAPE. **CAUTION SCALDING HAZARD!** - AND CHECK THE COOLING LIQUID LEVEL.
- DO NOT DRIVE ON, UNTIL THERE IS SUFFICIENT LIQUID IN THE COOLING SYSTEM. HOWEVER, CALL ON ONE OF KTM'S DEALERS AS SOON AS POSSIBLE IN ORDER TO HAVE THE DEFECT REMEDIED.
- IF ANY ABNORMAL VIBRATIONS OCCUR WHILE DRIVING, CHECK THAT THE ENGINE FASTENING SCREWS ARE TIGHT.
- IN THE EVENT THAT, WHILE RIDING YOUR MOTORCYCLE, YOU NOTICE ANY UNUSUAL OPERATION-RELATED NOISE, STOP IMMEDIATELY, TURN THE ENGINE OFF, AND CONTACT AN AUTHORIZED KTM DEALER.

## Braking

Close throttle and apply the hand and foot brakes at the same time. Carefully apply the brakes on sandy, wet or slippery surfaces. Always brake with feeling, blocking wheels can cause you to skid or fall. Also change down to lower gears depending on your speed.

Always finish braking before you enter a curve.

When driving downhill, use the braking effect of the engine. Change down one or two gears but do not overspeed the engine. In this way, you will not need to brake so much and the brakes will not overheat.

### ⚠ WARNING

- DELAYED BRAKE ACTION MUST BE EXPECTED DUE TO WET BRAKE DISKS DURING RAINY WEATHER OR AFTER CLEANING OF THE MOTORCYCLE. IN THIS CASE, REPEATEDLY APPLY THE BRAKES UNTIL THEY ARE DRY.
- DELAYED BRAKE ACTION CAN ALSO OCCUR ON SALTED OR DIRTY ROADS. IN THIS CASE, REPEATEDLY APPLY THE BRAKES TO REMOVE THE DIRT.
- WHEN YOU BRAKE, THE BRAKE DISCS, BRAKE PADS, BRAKE CALIPER AND BRAKE FLUID HEAT UP. THE HOTTER THESE PARTS GET, THE WEAKER THE BRAKING EFFECT. IN EXTREME CASES, THE ENTIRE BRAKING SYSTEM CAN FAIL.
- DIRTY BRAKE DISCS CAUSE INCREASED TEAR OF BRAKE PADS AND BRAKE DISCS.
- IF THE RESISTANCE IN THE HAND BRAKE LEVER OR FOOT BRAKE PEDAL FEELS "SPONGY" (TOO MUCH PLAY), THIS IS AN INDICATION THAT SOMETHING IS WRONG WITH THE BRAKE SYSTEM. DON'T RIDE YOUR MOTORCYCLE ANYMORE WITHOUT FIRST HAVING THE BRAKE SYSTEM LOOKED OVER BY A KTM DEALER.

## Stopping and parking

Apply the brakes fully and put the engine into neutral. To stop the engine, switch off the ignition. Close fuel tap. Park on solid ground and lock the vehicle.

### ⚠ WARNING

- MOTORCYCLE ENGINES PRODUCE A GREAT AMOUNT OF HEAT WHILE RUNNING. THE ENGINE RADIATORS, EXHAUST, EXHAUST SYSTEM, BRAKE DISCS, AND SHOCK ABSORBERS CAN BECOME VERY HOT. DO NOT TOUCH ANY OF THESE PARTS AFTER OPERATING THE MOTORCYCLE, AND TAKE CARE TO PARK IT WHERE PEDESTRIANS ARE NOT LIKELY TO TOUCH IT AND GET BURNED.
- NEVER PARK YOUR MOTORCYCLE IN PLACES WHERE THERE EXIST FIRE HAZARDS DUE TO DRY GRASS OR OTHER EASILY FLAMMABLE MATERIALS.

### ! CAUTION

- PARK YOUR MOTORCYCLE, SO THAT IT RESTS STABLY ON THE SIDESTAND (HARD GROUND, LEVEL SURFACE) AND CAN'T TIP OVER.
- DO NOT LEAVE THE PARKING LIGHT ON FOR MORE THAN THREE HOURS WITH THE ENGINE OFF. OTHERWISE YOU WILL NOT BE ABLE TO START THE ENGINE WITH THE ELECTRIC STARTER.
- THE FUEL TAPS MUST ALWAYS BE CLOSED WHEN PARKING THE MOTORCYCLE. OTHERWISE THE CARBURETOR CAN OVERFLOW AND FUEL COULD FLOW INTO THE ENGINE.
- ALWAYS TAKE OUT THE IGNITION KEY WHEN PARKING YOUR MOTORCYCLE SO THAT IT CANNOT BE USED BY UNAUTHORIZED PERSONS.



#### NOTE REGARDING THE CENTER STAND:

We advise the following procedure to place the motorcycle on the center stand as effortlessly as possible:

- a) press main stand to ground using foot,
- b) swing out kickstarter and pull motorcycle backwards at an angle as illustrated (see illustration).

Make sure that the ground is solid and that your motorcycle is standing securely.

### ! CAUTION

THE SIDE STAND IS DIMENSIONED FOR THE WEIGHT OF THE MOTORCYCLE ONLY. IF YOU ARE SITTING ON THE MOTORBIKE AND THUS APPLY AN ADDITIONAL LOAD ONTO THE SIDE STAND, YOU MAY CAUSE DAMAGE TO THE SIDE STAND OR THE FRAME, AND YOUR MOTORBIKE MAY FALL OVER.



## Refueling

In the condition at delivery, the LC4 engine requires unleaded premium-grade fuel with at least 95 octane (ROZ) (USA=Premium RON91).

If using lower octane fuel, it is easy to change over to the pre-programmed ignition curve for 80 - 94 octane (ROZ) (see activating the ignition curve for low-octane fuel).

After refueling, it will take approx. 8 minutes for the fuel warning lamp to switch off and for TRIP F to automatically reset to 0 and return to the previous display mode.

NOTE:

Press the SET key for 2 seconds to immediately turn off the fuel warning lamp.

### ! CAUTION

- USE UNLEADED PREMIUM GRADE GASOLINE (95 OCTANES). NEVER USE ANY GASOLINE HAVING LESS THAN 95 OCTANES BECAUSE IT MAY DAMAGE THE ENGINE.
- BE CAREFUL NOT TO LET FUEL DRIP ON THE PAINTED PARTS, WIPE UP ANY SPILLS IMMEDIATELY. THE FUEL WILL DISCOLOR THE CLEAR COAT AND MAKE IT TURN YELLOW.

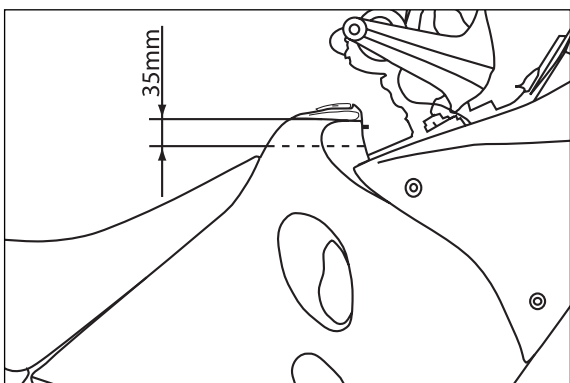

Fuel expands when its temperature rises. Therefore do not fill the tank to the top (see fig.).

### ! WARNING

GASOLINE IS HIGHLY FLAMMABLE AND POISONOUS. EXTREME CAUTION SHOULD BE USED WHEN HANDLING GASOLINE. DO NOT REFUEL THE MOTORCYCLE NEAR OPEN FLAMES OR BURNING CIGARETTES. ALWAYS SWITCH OFF THE ENGINE BEFORE REFUELLING. BE CAREFUL NOT TO SPILL GASOLINE ON THE ENGINE OR EXHAUST PIPE WHILE THE ENGINE IS HOT. WIPE UP SPILLS PROMPTLY. IF GASOLINE IS SWALLOWED OR SPLASHED IN THE EYES, SEEK A DOCTOR'S ADVICE IMMEDIATELY.

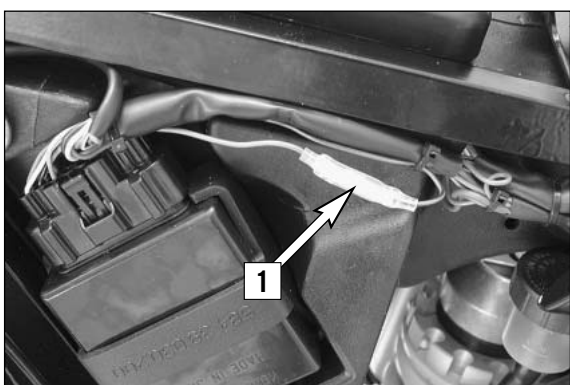

## Activating the ignition curve for low-octane fuel

If you are traveling to a country where fuel having at least 95 octane (ROZ) (USA=Premium RON91) is not available, you can easily activate the corresponding ignition curve. A plug and socket connection [1] on a brown/black cable is located on the right side of the vehicle next to the CDI box.

If the two connectors are connected to each other, the ignition curve for fuel having at least 95 octane (ROZ) is activated.

If you disconnect the plug and socket connection, the ignition curve for fuel having 80 - 94 octane (ROZ) is activated. Although this causes the engine to lose some of its power output, it prevents poor glow ignitions and engine damage.

### ! CAUTION

IF FUEL HAVING AT LEAST 95 OCTANE (ROZ) IS NOT AVAILABLE, THE IGNITION CURVE FOR 80 - 94 OCTANE (ROZ) MUST BE ACTIVATED TO PREVENT ENGINE DAMAGE.

# PERIODIC MAINTENANCE SCHEDULE »

| A WASHED MOTORCYCLE CAN BE CHECKED MORE QUICKLY WHICH SAVES MONEY!   |  | 640 LC4<br>ADVENTURE<br>2006 | 1st Service<br>after<br>1000 km | 2nd Service after<br>5000 km, then<br>every 5000 km<br>or once a year |
|--|--|------------------------------|---------------------------------|---|
| ENGINE   | Change engine oil, oil filter, and fine filter   |                              | ●                               | ●   |
|  | Clean oil screens and magnet of drain plug   |                              | ●                               | ●   |
|  | Check oil lines for damage and kink-less arrangement   |                              | ●                               | ●   |
|  | Check and adjust spark plug, replace it every 10,000 km  |                              |                                 | ●   |
|  | Check and adjust valve clearance   |                              | ●                               | ●   |
|  | Check engine fastening screws for tight fit  |                              | ●                               | ●   |
|  | Make sure all engine screws accessible from the outside are screwed tight  |                              | ●                               | ●   |
| CARBURETOR   | Check carburetor connection boots for cracks and leaks   |                              |                                 | ●   |
|  | Check idle setting   |                              | ●                               | ●   |
|  | Check bleeder hoses for damage and kink-free arrangement   |                              | ●                               | ●   |
| ADD-ON-PARTS   | Check cooling system for leaks, antifreeze protection  |                              | ●                               | ●   |
|  | Check radiator fan for proper operation  |                              |                                 | ●   |
|  | Check exhaust system for leaks and suspension  |                              | ●                               | ●   |
|  | Check actuating cables for damage, smooth operation, and kink-less arrangement, adjust and lubricate them  |                              | ●                               | ●   |
|  | Check fluid level of the clutch master cylinder  |                              | ●                               | ●   |
|  | Clean air filter and air filter box  |                              |                                 | ●   |
|  | Check cables for damage and kink-less arrangement  |                              |                                 | ●   |
|  | Check headlamp adjustment  |                              |                                 | ●   |
|  | Check electrical system for function (low/high beams, stop light, turn indicators, headlamp, flasher, tell-tale lamps, speedometer illumination, horn, side-stand switch, clutch switch, emergency-off switch) |                              | ●                               | ●   |
|  | Make sure all screws and nuts are tight  |                              | ●                               | ●   |
| BRAKES   | Check brake fluid level, lining thickness, and brake discs   |                              | ●                               | ●   |
|  | Check brake lines for damage and leaks   |                              | ●                               | ●   |
|  | Check/adjust smooth operation, free travel of handbrake/footbrake levers   |                              | ●                               | ●   |
|  | Check screws of brake system for tight fit   |                              | ●                               | ●   |
| CHASSIS  | Check shock absorber and fork for leaks and proper operation   |                              | ●                               | ●   |
|  | Check O-ring of shock absorber for wear  |                              |                                 | ●   |
|  | Clean fork dust sleeves  |                              |                                 | ●   |
|  | Bleed fork legs  |                              | ●                               | ●   |
|  | Check swinging-fork pivot  |                              | ●                               | ●   |
|  | Check/adjust steering-head bearing   |                              | ●                               | ●   |
|  | Lubricate reversing lever  |                              |                                 | ●   |
| Check all chassis screws for tight fit (fork plates, fork leg, axle nuts/screws, swinging-fork pivot, reversing lever, suspension strut) |  | ●                            | ●                               |   |
| WHEELS   | Check spoke tension and rim joint  |                              | ●                               | ●   |
|  | Check tire condition and inflation pressure  |                              | ●                               | ●   |
|  | Check chain and chain guides for wear, force fit and tension.  |                              | ●                               | ●   |
|  | Check screws on pinion and chain sprocket for locking devices and a tight fit  |                              | ●                               | ●   |
|  | Lubricate chain  |                              | ●                               | ●   |
|  | Check wheel bearings and jerk damper for play  |                              |                                 | ●   |

# PERIODIC MAINTENANCE SCHEDULE »

| IMPORTANT RECOMMENDED MAINTENANCE PROCEDURES TO BE PERFORMED BASED ON A SEPARATE SUPPLEMENTARY ORDER |                      |                           |
|--|----------------------|---------------------------|
|  | at least once a year | every 2 years or 20000 km |
| Perform complete fork maintenance  | ●                    |                           |
| Perform complete shock absorber maintenance  |                      | ●                         |
| Perform complete reversing lever maintenance   |                      | ●                         |
| Clean and lubricate steering-head bearing and sealing elements                                       | ●                    |                           |
| Clean and adjust the carburetor  | ●                    |                           |
| Treat the electrical contacts and switches with contact spray  | ●                    |                           |
| Treat battery connections with contact grease  | ●                    |                           |
| Change the brake fluid   | ●                    |                           |

**IF MOTORCYCLE IS USED FOR COMPETITION 5000 KM SERVICE SHOULD BE CARRIED OUT AFTER EVERY RACE!**

SERVICE INTERVALLS SHOULD NEVER BE EXCEED BY MOOR THAN 500 KM.

MAINTENANCE WORK DONE BY KTM AUTHORISED WORKSHOPS IS NOT A SUBSTITUTE OF CARE AND CHECKS DONE BY THE RIDER!

| VITAL CHECKS AND CARE PROCEDURES TO BE CONDUCTED BY THE OWNER OR THE MECHANIC                                    |                   |                      |                       |             |
|--|-------------------|----------------------|-----------------------|-------------|
|  | before each start | after every cleaning | for cross country use | once a year |
| Check oil level  | ●                 |                      |                       |             |
| Check brake fluid level  | ●                 |                      |                       |             |
| Check brake pads for wear  | ●                 |                      |                       |             |
| Check lighting system for proper operation   | ●                 |                      |                       |             |
| Check horn for proper operation  | ●                 |                      |                       |             |
| Lubricate and adjust actuating cables and nipples  |                   | ●                    |                       |             |
| Bleed fork legs in regular intervals   |                   |                      | ●                     |             |
| Remove and clean fork dust sleeves in regular intervals  |                   |                      | ●                     |             |
| Clean and lubricate chain as necessary   |                   | ●                    | ●                     |             |
| Check chain tension  | ●                 | ●                    | ●                     |             |
| Clean air filter and filter box (depending on the dirt accumulation)   |                   |                      | ●                     |             |
| Check tire pressure and wear   | ●                 |                      |                       |             |
| Check coolant level  | ●                 |                      |                       |             |
| Check fuel lines for leaks   | ●                 |                      |                       |             |
| Drain float chamber  |                   | ●                    |                       |             |
| Check all control elements for smooth running  | ●                 |                      |                       |             |
| Check brake performance  | ●                 | ●                    |                       |             |
| Treat exposed metal components (except for the braking and exhaust systems) with wax-based anti-corrosion agents |                   | ●                    |                       |             |
| Treat ignition/steering lock and light switch with contact spray   |                   | ●                    |                       |             |
| Check all screws, nuts, and hose clamps for their tight fit  |                   |                      |                       | ●           |

# MAINTENANCE WORK ON CHASSIS AND ENGINE »

## **⚠ WARNING**

MAINTENANCE AND ADJUSTING WORK MARKED WITH AN ASTERISK (\*) REQUIRES EXPERT SKILLS AND TECHNICAL KNOW-HOW. FOR YOUR OWN SAFETY, ALWAYS HAVE SUCH WORK PERFORMED BY A SPECIALIZED KTM DEALER WHERE YOUR MOTORCYCLE WILL BE OPTIMALLY SERVICED BY APPROPRIATELY QUALIFIED SKILLED STAFF.

## **! CAUTION**

- WHEN CLEANING THE MOTORCYCLE, DO NOT USE A HIGH PRESSURE CLEANING UNIT IF POSSIBLE, OTHERWISE WATER WILL PENETRATE THE BEARINGS, CARBURETOR, ELECTRIC CONNECTORS ETC.
- WHEN TRANSPORTING YOUR KTM, ENSURE THAT IT IS HELD UPRIGHT WITH RESTRAINING STRAPS OR OTHER MECHANICAL FASTENING DEVICES. IF THE MOTORCYCLE SHOULD FALL OVER, FUEL CAN LEAK FROM THE CARBURETOR OR FUEL TANK
- DO NOT USE TOOTHED WASHERS OR SPRING WASHERS WITH THE ENGINE FASTENING SCREWS, AS THESE WORK INTO THE FRAME PARTS AND KEEP WORKING LOOSE. INSTEAD, USE SELF-LOCKING NUTS.
- IF YOU UNSCREW ANY SCREWED CONNECTIONS WITH SELF-LOCKING NUTS, THEY MUST BE REPLACED WHEN MOUNTING. IF NO SELF-LOCKING NUTS ARE AVAILABLE, APPLY LOCTITE 243 TO THE THREAD. THE SCREWS AND NUTS MUST BE REPLACED IF THE THREAD IS DAMAGED.
- ALL SCREWS AND NUTS MUST BE TIGHTENED TO THE SPECIFIED TORQUE FIGURES USING A TORQUE WRENCH. IF SCREWS OR NUTS ARE NOT ADEQUATELY TIGHTENED, THEY CAN BECOME LOOSE AND CAUSE THE MOTORCYCLE TO GO OUT OF CONTROL WHILE YOU DRIVE. TIGHTENING THE SCREWS AND NUTS TOO TIGHTLY CAN DAMAGE THE THREAD AND COMPONENTS.
- LET YOUR MOTORCYCLE COOL DOWN BEFORE BEGINNING ANY MAINTENANCE WORK IN ORDER TO AVOID GETTING BURNED.
- PROPERLY DISPOSE OF OIL, GREASE, FILTERS, FUEL, CLEANSERS, BRAKE FLUID, COOLING LIQUID, ETC. OBSERVE THE REGULATIONS EFFECTIVE IN YOUR COUNTRY. ALSO OBSERVE THE SAFETY REGULATIONS WHEN HANDLING THESE SUBSTANCES.
- UNDER NO CIRCUMSTANCES MAY USED OIL BE DISPOSED OF IN THE SEWAGE SYSTEM OR IN THE OPEN COUNTRYSIDE. 1 LITER USED OIL CONTAMINATES 1,000.000 LITERS WATER.

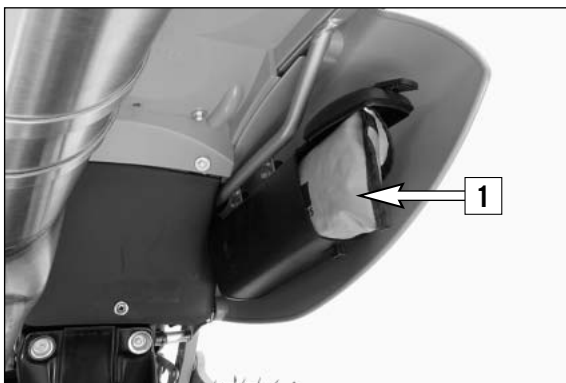

### **Tool set**

The tool kit [1] is located in the tool box under the right side cover.

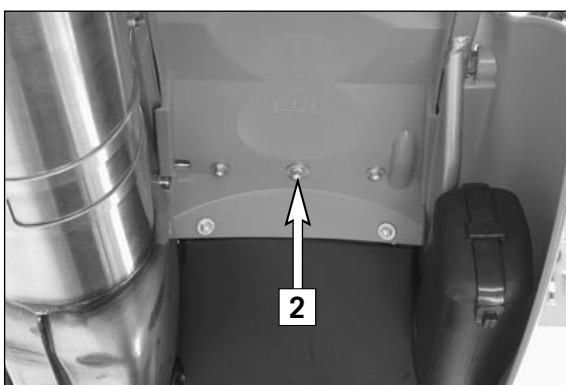

### **Removing the seat**

Remove the collar screws [2] from the underside of the fender. Lift the rear of the seat, pull backwards, and unhook it from the oval-head screw [3].

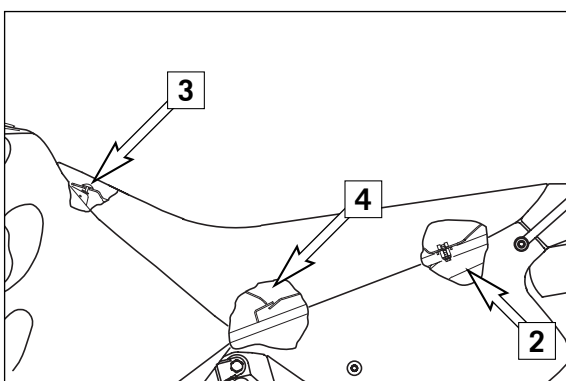

To install the seat, hook the seat into the oval-head screw, set the rear portion down on the frame, and slide it forward. If necessary, press down on the front area of the seat so that the seat catches on the retaining bracket [4]. Insert and tighten the collar screw.

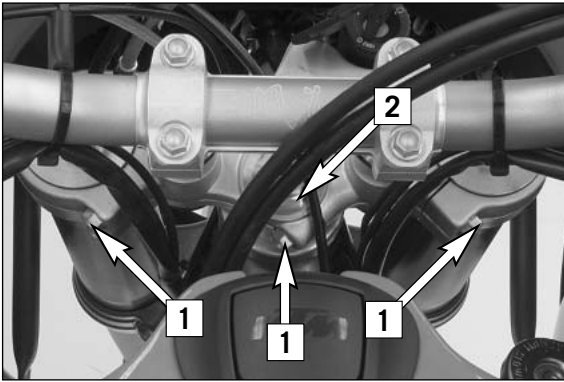

## Checking and adjusting steering head bearing \*

Check steering head bearing for play periodically. To check this put motorcycle on a stand so that the front wheel is off the ground. Now try to move the fork forward and backward. To adjust, loosen the five clamp screws [1] of the top triple clamp and turn steering stem bolt clockwise [2] until there is no more play. Don't tighten the steering stem bolt all the way, otherwise the bearings will be damaged. With a plastic hammer, lightly rap on the triple clamp to avoid tension. Re-tighten the five clamp screws with 15 Nm (11 ft.lb).

### ⚠ WARNING

IF THE STEERING HEAD BEARING IS NOT ADJUSTED TO BE FREE OF PLAY, THE MOTORCYCLE WILL SHOW AN UNSTEADY DRIVING PERFORMANCE AND CAN GET OUT OF CONTROL.

### ! CAUTION

IF YOU DRIVE WITH PLAY IN THE STEERING HEAD BEARING FOR LONGER PERIODS, FIRST THE BEARINGS AND THEN THE BEARING SEATS IN THE FRAME WILL BE DESTROYED.

At least once a year, the steering head bearings should be greased (Motorex Long Therm 2000).

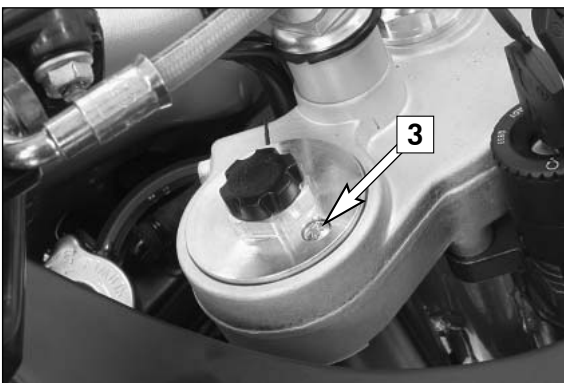
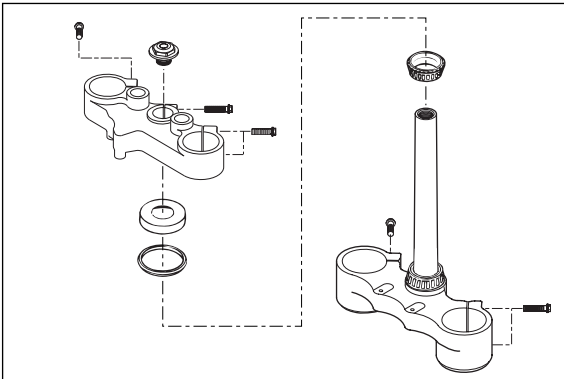

## Bleeder screw front fork

The bleeder screws [3] should now and then be released a few turns to let overpressure, if any, escape from the interior of the fork. To do this, place the motorcycle on a stand with the front wheel lifted off the ground. When riding the motorcycle mainly on street, it will be enough to have this job performed in the course of the periodical maintenance service.

### ! CAUTION

EXCESSIVE PRESSURE IN THE INTERIOR OF THE FORK CAN CAUSE LEAKS IN THE FORK. IF YOUR FORK IS LEAKING, IT IS RECOMMENDED TO OPEN THE BLEEDER SCREWS BEFORE HAVING THE SEALS REPLACED.

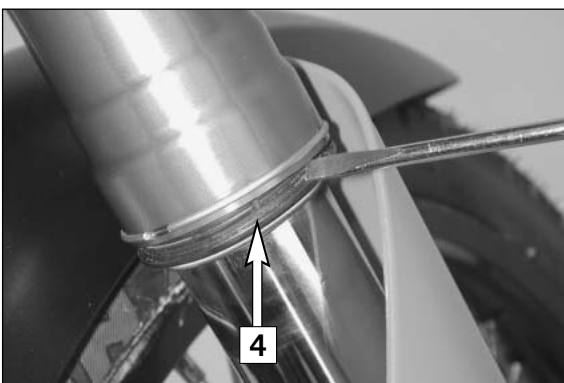

## Cleaning the dust sleeves of the telescopic fork

The dust-protection bellows [4] are to remove dust and coarse dirt particles from the fork tube. However, after some time, dirt may also get in behind the dust-protection bellows. If this dirt is not removed, the oil sealing rings located behind it may start to leak.

Use a screwdriver to lever the dust-protection bellows out of the outer tubes and slide them downward.

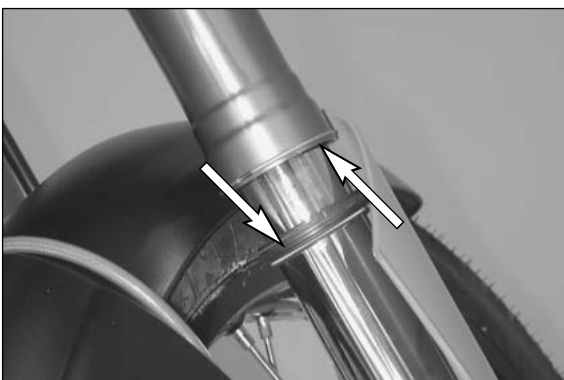

Clean dust-protection bellows, outer tubes, and fork tubes thoroughly, and oil them thoroughly with Universal oil spray (Motorex Joker 440) or engine oil. Then, push dust-protection bellows into the outer tubes by hand.

### ⚠ WARNING

NO OIL MAY REACH THE FRONT TIRE OR THE BRAKE DISKS SINCE THIS WOULD CONSIDERABLY REDUCE THE TIRE'S ROAD GRIP AND THE BRAKING EFFECT OF THE FRONT BRAKE.



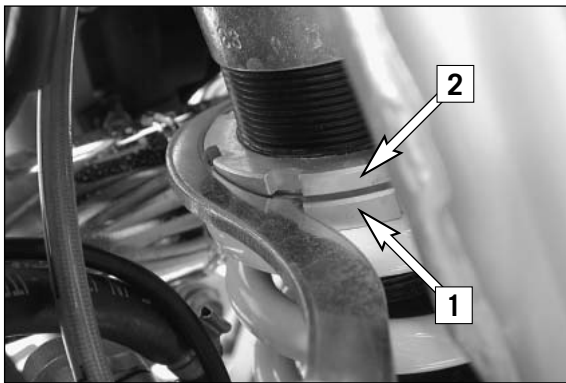

## Changing the spring preload of the shock absorber

KTM sets the shock absorber for a driver only, weighing approximately 75 kg (165 lb). If you want to take a passenger with you, or if you weigh considerably more or less than 75 kg (165 lb), you should change the spring preload [A] accordingly. This is easily done.

NOTE:

- Before changing the spring preload note down the basic setting, e.g. how many threads are visible above the adjusting ring.
- One rotation of the adjusting ring [1] changes the spring preload by approximately 1,75 mm (0,07 in).

Loosen the locking ring [2] with the hook wrench from the tool set. Change the spring preload with the adjusting ring [1] and re-tighten the locking ring.

BASIC SETTING – SPRING PRELOAD

WP 01187B04 .....A = 27 mm (1.1 in)

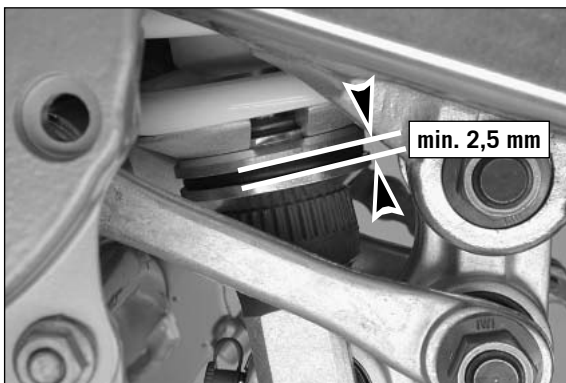
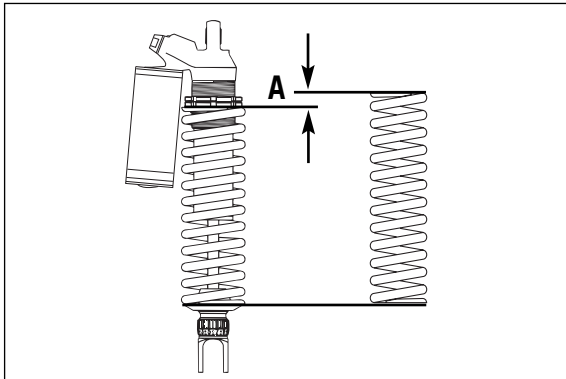

## Checking rubber ring on the WP rear shock absorber

A rubber ring mounted on the rear shock absorber serves as a vibration damper. This ring gets pressed together with time and loses its shock absorbing quality.

Measure the distance between the two discs at various points around their circumferences. The space should be at least 2.5 mm (0,1 in) wide. Have the rubber ring replaced by an KTM dealer when compaction due to wear has exceeded this lower limit.

### ! CAUTION

NOT REPLACING THE RUBBER RING IN TIME CAN RESULT IN DAMAGE TO THE REAR SHOCK ABSORBER.

### ⚠ WARNING

THE DAMPING UNIT OF THE SHOCK ABSORBER IS FILLED WITH HIGH COMPRESSED NITROGEN. NEVER TRY TO TAKE THE SHOCK ABSORBER APART OR TO DO ANY MAINTENANCE WORK YOURSELF. SEVERE INJURIES COULD BE THE RESULT.

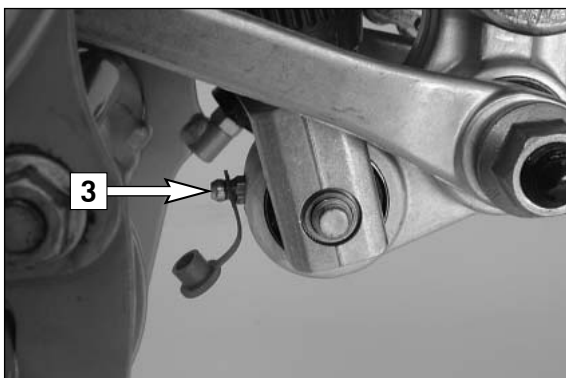

## Lubricating the shock absorber linkage

The bearings in the rocker arm must be greased in regular intervals. For this purpose, a grease nipple [3] is mounted on the rocker arm.

### ! CAUTION

AFTER EACH TIME THE MOTORCYCLE IS WASHED, IT IS ESPECIALLY IMPORTANT TO GREASE THE GREASE NIPPLE TO PUSH ANY WATER OUT OF THE BEARINGS.

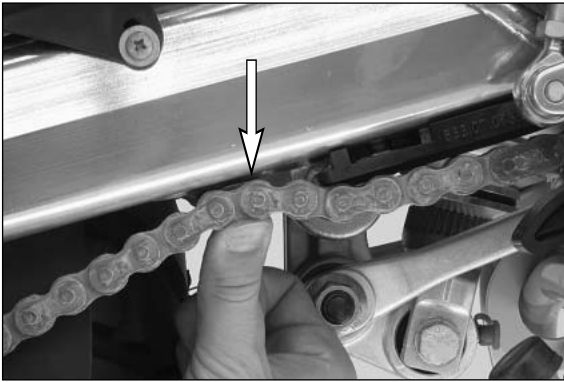

## Checking chain tension

Support the motorcycle on the center stand or side stand, respectively. Switch transmission to neutral.

Push the chain upwards approx. 30 mm (1,2 in) from the end of the chain sliding component until the upper part of the chain is tensioned (see illustr.) Now, the distance [A] between chain and swingarm should be 0 mm. The upper part of the chain [B] must be tight (see illustr.).

Correct chain tension, if necessary!

### ⚠ WARNING

- IF CHAIN TENSION IS TOO GREAT, PARTS WITHIN THE SECONDARY POWER TRANSMISSION (CHAIN, CHAIN SPROCKETS, TRANSMISSION AND REAR WHEEL BEARINGS) WILL BE SUBJECTED TO UNNECESSARY STRESS, RESULTING IN PREMATURE WEAR AND EVEN CHAIN BREAKAGE.
- TOO MUCH SLACK IN THE CHAIN, ON THE OTHER HAND, CAN RESULT IN THE CHAIN JUMPING OFF THE CHAIN WHEELS. IF THIS HAPPENS, THE CHAIN COULD ALSO BLOCK THE REAR WHEEL OR DAMAGE THE ENGINE.
- IN EITHER CASE THE OPERATOR IS LIKELY TO LOSE CONTROL OF THE MOTORCYCLE.

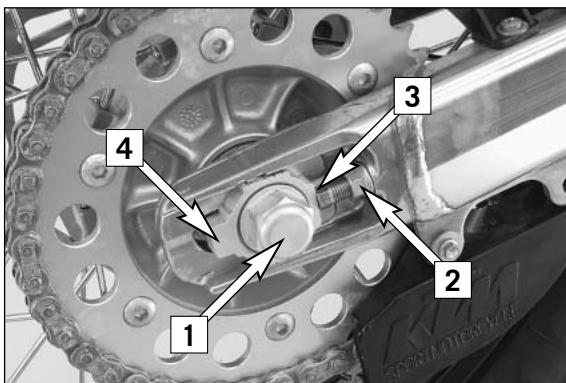
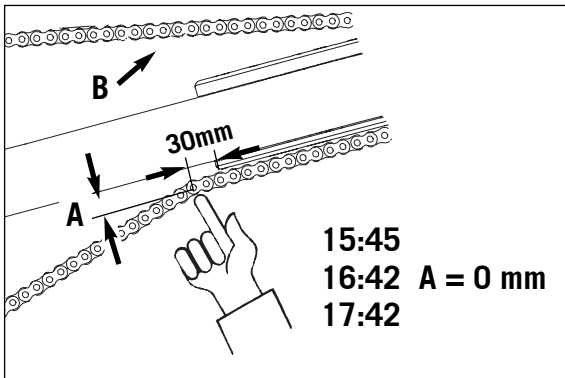

## Correct chain tension

Loosen collar nut [1], loosen counter nuts [2], and turn right and left adjusting screws [3] equally far. Tighten counter nuts [2].

Before tightening the wheel spindle, verify that the chain adjusters [4] are sitting close to the adjusting screws and that the rear wheel has been aligned with the front wheel.

Tighten collar nut [1] with 80 Nm (59 ft.lb).

### ⚠ WARNING

IF YOU DON'T HAPPEN TO HAVE A TORQUE WRENCH AT HAND, MAKE SURE YOU HAVE THE TIGHTENING TORQUE CORRECTED BY A KTM DEALER AS SOON AS POSSIBLE. A LOOSE AXLE MAY LEAD TO AN UNSTABLE DRIVING BEHAVIOR OF YOUR MOTORCYCLE.

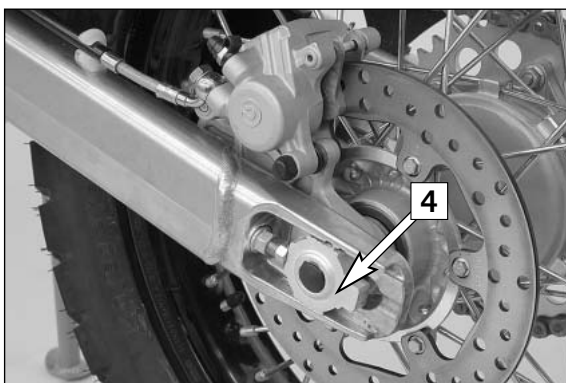

### NOTE:

The large adjusting range of the chain adjusters (32mm) allows you to use different secondary ratios in combination with the same chain length. The chain adjusters [4] can be rotated by 180°.

### ! CAUTION

ALWAYS MOUNT THE CHAIN TENSIONER EQUALLY ALIGNED.

## Chain maintenance

For long chain life, good maintenance is very important. X-ring chains require only modest maintenance. The best way is to use lots of water, but never use brushes or solvents. After letting the chain dry, you can use a special X-ring chain spray (Motorex Chainlube Racing).

### ⚠ WARNING

- NO LUBRICATION IS ALLOWED TO REACH THE REAR TIRE OR THE BRAKE DISK, OTHERWISE THE ROAD ADHERENCE AND THE REAR WHEEL BRAKING EFFECTS WOULD BE STRONGLY REDUCED AND THE MOTORCYCLE COULD EASILY GET OUT OF CONTROL.
- THE CHAIN DOES NOT HAVE A CHAIN JOINT FOR SAFETY REASONS. ALWAYS HAVE THE CHAIN REPLACED IN AN AUTHORIZED KTM WORKSHOP WHERE THE SERVICE TECHNICANS HAVE THE REQUIRED ORIGINAL RIVETING TOOL.
- NEVER MOUNT A NORMAL CHAIN JOINT.

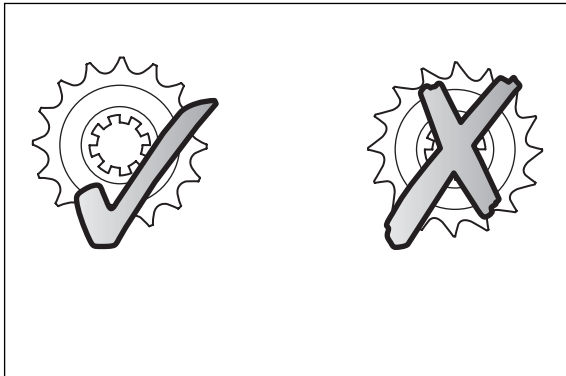

Also check sprockets and chain guides for wear, and replace if necessary.

## Chain wear

In order to check the chain wear, regard the following instructions: Shift the gear into idling and pull the upper chain strand with approx. 10-15 kilogram (33 lb) upwards (see figure). Now one can measure a space of 18 chain reels at the lower chain strand. The chain should be replaced at the latest when a space of 272 mm (10,70 in) is measured. Chains do not always wear off evenly, therefore repeat the measurement at different places on the chain.

NOTE: If you mount a new chain, the sprockets should also be replaced. New chains wear faster if used on old used sprockets.

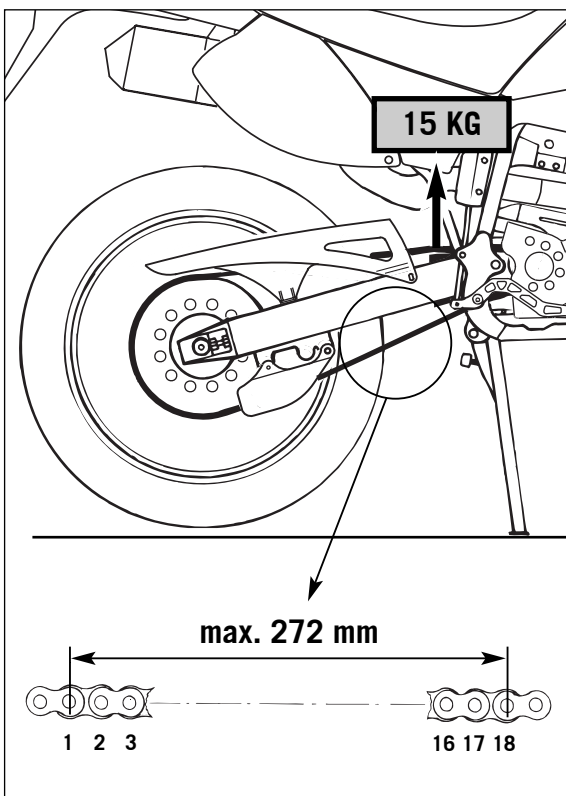

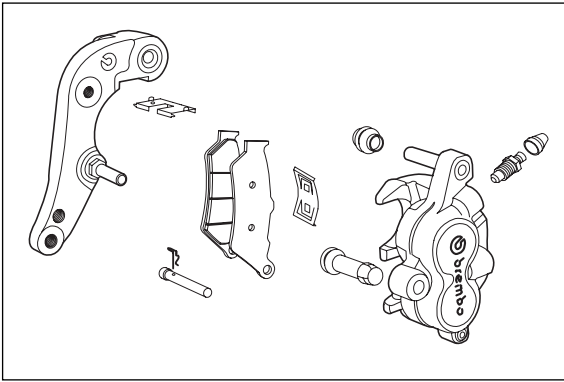

## General informations about KTM disc brakes

### BRAKE CALIPERS:

The brake calipers of this series “float“. This means that the brake calipers are not solidly attached to the caliper support. Thus, the brake pads are always in optimum contact with the brake disc. Secure the screws of the caliper support with Loctite 243 and tighten to 25 Nm (19 ft.lb).

### ⚠ WARNING

FOR SAFETY REASONS, ALWAYS HAVE MAINTENANCE WORK AND REPAIRS TO THE BRAKE SYSTEM PERFORMED BY AN AUTHORIZED KTM WORKSHOP.

### BRAKE PADS:

The brake pads are fitted with TOSHIBA TT2701HH sintered lining at the front and TOSHIBA TT2161FF sintered lining at the back. These linings provide an optimal combination of dosing, brake performance and life cycle. The lining type is stated on the back of the brake pad and also recorded in the homologation papers.

### ⚠ WARNING

BRAKE SHOES AVAILABLE IN THE ACCESSORY TRADE ARE OFTEN NOT AUTHORIZED FOR OPERATION OF YOUR KTM MOTORCYCLE IN ROAD TRAFFIC. THE BRAKE SHOE'S DESIGN AND FRICTION FACTOR AND THEREFORE THE BRAKING POWER CAN DEVIATE SIGNIFICANTLY FROM ORIGINAL KTM BRAKE SHOES. IF YOU USE DIFFERENT BRAKE SHOES THAN THOSE PROVIDED WITH THE ORIGINAL EQUIPMENT, IT CANNOT BE WARRANTED THAT THEY ARE AUTHORIZED FOR USE IN ROAD TRAFFIC. YOUR MOTORCYCLE WILL NOT LONGER COMPLY WITH THE REGULATIONS AUTHORIZING THE USE OF VEHICLES FOR ROAD TRAFFIC AND THE WARRANTY WILL BE VOID.

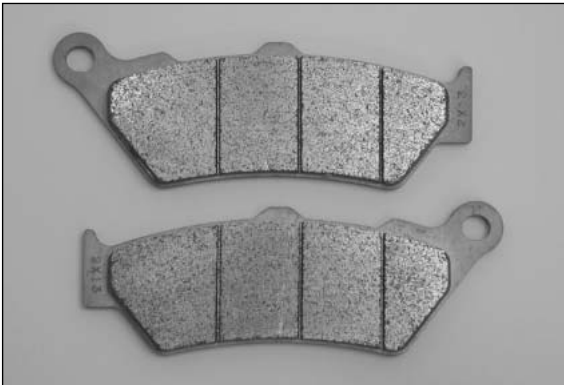

### BRAKE FLUID:

KTM fills the brake systems with Motorex Brake Fluid DOT 5.1 brake fluid, one of the best brake fluids that is currently available. We recommend that you continue to use it. DOT 5.1 brake fluid is based on glycol ether and of an amber color. If you do not have any DOT 5.1 for refilling, you may use DOT 4 brake fluid. However, you should replace it as soon as possible by DOT 5.1.

**Never** use **DOT 5** braking fluid. It is based on silicone oil and has a purple color. Gaskets and brake hoses are not compatible with it.

Brake fluid is exposed to a high thermal load and absorbs moisture from the air, which lowers the boiling point. The brake fluid should therefore be changed at the prescribed intervals.

### ⚠ WARNING

HAVE THE BRAKE FLUID CHANGED AT LEAST ONCE ANNUALLY. IF YOU WASH YOUR MOTORCYCLE OFTEN, THE BRAKE FLUID SHOULD BE CHANGED EVEN MORE FREQUENTLY. BRAKE FLUID TENDS TO ABSORB WATER. THEREFORE, VAPOR POCKETS MAY FORM IN „OLD“ BRAKE FLUIDS EVEN AT LOW TEMPERATURES, CAUSING THE BRAKE SYSTEM TO FAIL.



### BRAKE FLUID RESERVOIRS:

The brake fluid reservoirs on the front and rear wheel brakes have been designed in such a way that even if the brake pads are worn it is not necessary to top up the brake fluid. If the brake fluid level drops below the minimum level either the brake system has a leak or the brake pads are completely worn. In this case, consult an authorized KTM dealer immediately.

### BRAKE DISCS:

Wear reduces the thickness of the brake disc in the area of contact [1] with the brake pads. The brake disk should not be thinner than 4.5 mm (0.18 in) at the weakest point [A]. Check the wear at several points.

### ⚠ WARNING

BRAKE DISKS THAT ARE LESS THAN 4.5 MM (0.18 IN) THICK ARE A SAFETY HAZARD. HAVE WORN BRAKE DISKS REPLACED IMMEDIATELY.

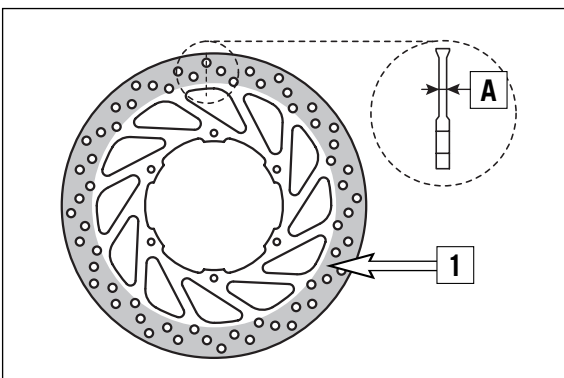

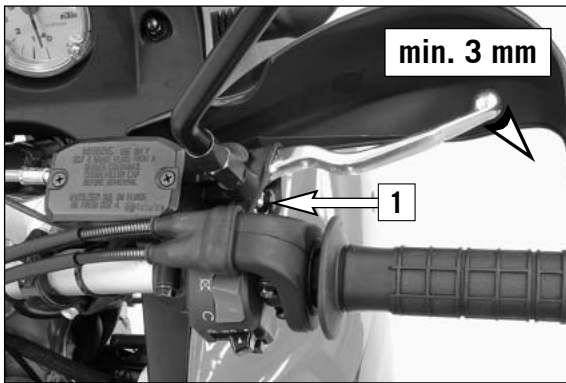

## Adjusting of free travel at the hand brake lever

Free travel at the hand brake lever may be readjusted by using adjusting screw [1]. In this way, the position of the point of pressure (i.e., the resistance you feel on the hand brake lever when the brake pads are pressed against the brake disc) can be adjusted for any hand size.

### ⚠ WARNING

AT THE HAND BRAKE LEVER, FREE TRAVEL MUST AT LEAST BE 3 MM. ONLY THEN MAY THE PISTON IN THE HAND BRAKE CYLINDER BE MOVED (TO BE RECOGNIZED BY THE GREATER RESISTANCE OF THE HAND BRAKE LEVER). IF THIS FREE TRAVEL IS NOT PROVIDED, PRESSURE WILL BUILD UP IN THE BRAKING SYSTEM, AND THE FRONT WHEEL BRAKE MAY FAIL DUE TO OVERHEATING.



## Checking of brake fluid level - front brake

The brake fluid reservoir is linked with the hand brake cylinder at the handlebar and the reservoir is provided with an inspection glass. With the reservoir in a horizontal position, the brake fluid level should not go below middle of the glass.

### ⚠ WARNING

IF THE BRAKE FLUID LEVEL DROPS BELOW THE MINIMUM EITHER THE BRAKE SYSTEM HAS A LEAK OR THE BRAKE PADS ARE COMPLETELY WORN DOWN. IN THIS CASE, CONSULT AN AUTHORIZED KTM DEALER IMMEDIATELY.

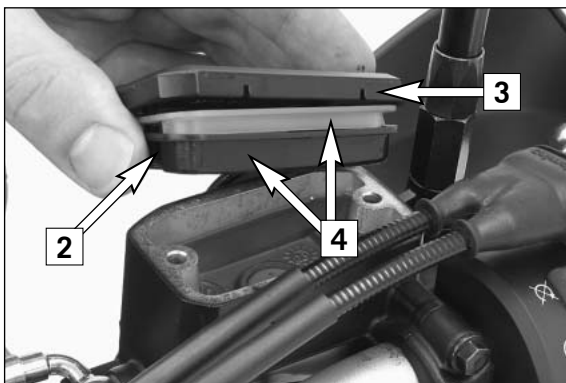

## Refilling the front brake fluid reservoir \*

Loosen screws [2] and remove lid [3] and membrane [4].

Place hand brake cylinder in a horizontal position and fill the brake fluid reservoir to 5 mm (0.2 in) below the rim with brake fluid DOT 5.1 (Motorex Brake Fluid DOT 5.1). Replace membrane and lid, tighten screws. Rinse off spilled or overflowing brake fluid with water.

### ⚠ WARNING

- NEVER USE DOT5 BRAKE FLUID! IT IS BASED ON SILICONE OIL AND OF A PURPLE COLOR. SEALS AND BRAKE HOSES MUST BE ESPECIALLY ADAPTED TO IT.
- STORE BRAKE FLUID OUT OF REACH OF CHILDREN.
- BRAKE FLUID CAN CAUSE SKIN IRRITATION. AVOID CONTACT WITH SKIN AND EYES. IF YOU GET BRAKE FLUID IN YOUR EYES, RINSE WITH PLENTY OF WATER AND CONSULT A DOCTOR.

### ! CAUTION

- DON'T LET BRAKE FLUID GET IN CONTACT WITH PAINT, IT IS AN EFFECTIVE PAINT REMOVER.
- USE ONLY CLEAN BRAKE FLUID TAKEN FROM A TIGHTLY SEALED CONTAINER.

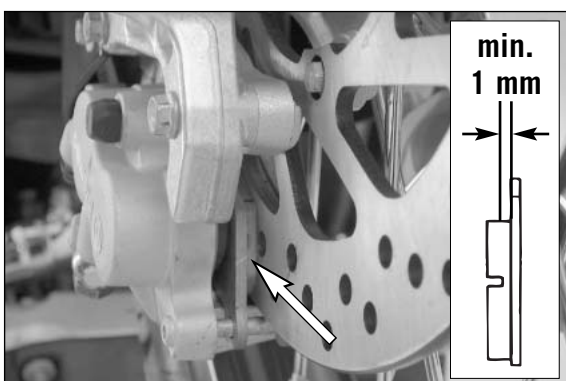
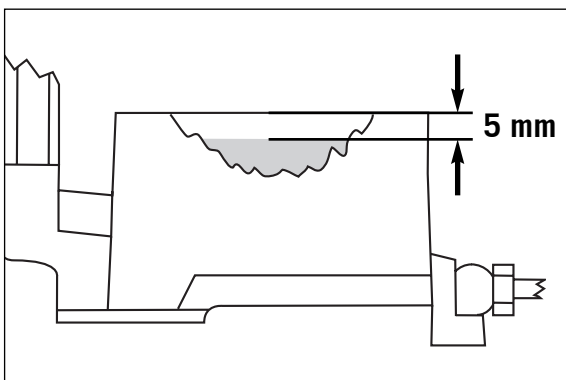

## Checking the front brake pads

The brake pads can be inspected from below. The linings must be at least 1 mm (0,04 in) thick.

### ⚠ WARNING

AT THEIR MOST WORN POINT BRAKE PAD LININGS SHOULD NOT BE THINNER THAN 1 MM, OTHERWISE THEY COULD LEAD TO BRAKE FAILURE. FOR YOUR OWN SAFETY DON'T PUT OFF HAVING YOUR BRAKE PADS CHANGED.

### ! CAUTION

IF THE BRAKE PADS ARE REPLACED TOO LATE SO THAT THE LINING IS PARTLY OR ENTIRELY WORN AWAY, THE STEEL COMPONENTS OF THE BRAKE PAD WILL RUB AGAINST THE BRAKE DISC, IMPAIRING THE BRAKING EFFECT AND DESTROYING THE BRAKE DISC.

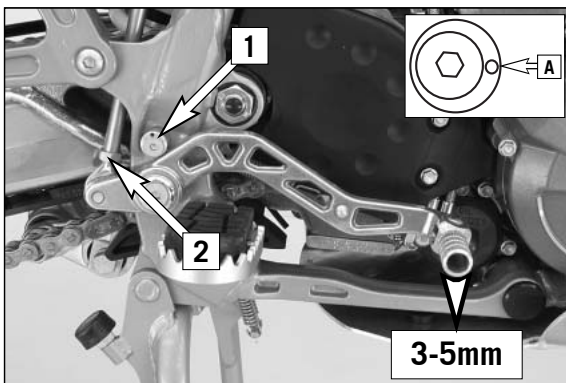

## Changing the basic position of the brake pedal \*

The basic setting of the foot brake pedal can be changed by turning the end stop roller [1]. Using the push rod [2], the free play on the foot brake pedal must be set.

Measured on the outside, the foot brake pedal must have 3-5 mm of free play, before the push rod can move the piston in the brake cylinder (to be recognised from the resistance on the foot brake pedal).

To keep the stop roller from turning while tightening, insert a hexagon wrench in bore [A].

### ⚠ WARNING

IF THIS CLEARANCE IS MISSING, PRESSURE ACCUMULATES IN THE BRAKING SYSTEM AND THE BRAKE PADS BEGIN TO RUB. THE BRAKING SYSTEM OVERHEATS AND CAN FAIL COMPLETELY IN EXTREME CASES.

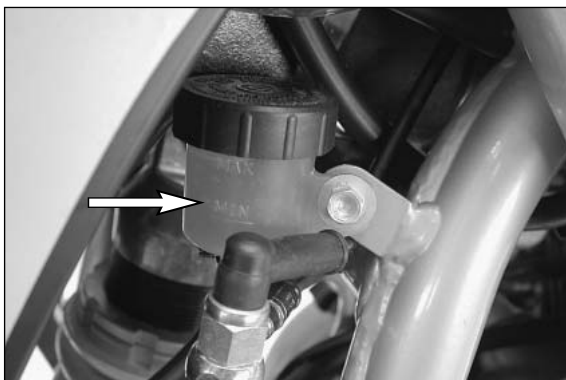

## Checking rear brake fluid level

The reservoir for the rear disc brake is located on the left-hand side of the vehicle next to the carburetor carburetor connection boot. The brake fluid level may not drop below the „MIN“ marking when the vehicle is in an upright position.

### ⚠ WARNING

IF THE BRAKE FLUID LEVEL DROPS BELOW THE MINIMUM EITHER THE BRAKE SYSTEM HAS A LEAK OR THE BRAKE PADS ARE COMPLETELY WORN DOWN. IN THIS CASE, CONSULT AN AUTHORIZED KTM DEALER IMMEDIATELY.

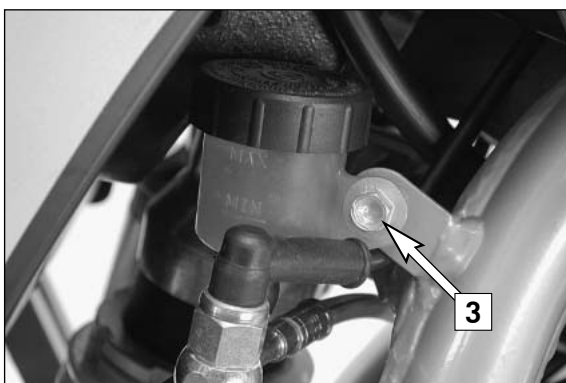

## Refilling the rear brake fluid reservoir \*

When the brake fluid level has dropped to the MIN mark, you need to refill the brake fluid reservoir.

For easier access to the brake fluid reservoir it is recommended to remove the hexagon screw [3]. Then move the container outwards as indicated in the illustration. Remove plug [4] with rubber boot [5] and add brake fluid DOT 5.1 (Motorex Brake Fluid DOT 5.1) up to the „MAX“ mark. Replace rubber boot and plug. Overflow or spilled brake liquid must be rinsed off with water. Mount the screw and fix the brake fluid reservoir to the frame, always making sure to prevent kinks in the connecting hose.

### ⚠ WARNING

- NEVER USE DOT5 BRAKE FLUID! IT IS BASED ON SILICONE OIL AND OF A PURPLE COLOR. SEALS AND BRAKE HOSES MUST BE ESPECIALLY ADAPTED TO IT.
- STORE BRAKE FLUID OUT OF REACH OF CHILDREN.
- BRAKE FLUID CAN CAUSE SKIN IRRITATION. AVOID CONTACT WITH SKIN AND EYES. IF YOU GET BRAKE FLUID IN YOUR EYES, RINSE WITH PLENTY OF WATER AND CONSULT A DOCTOR

### ! CAUTION

- DON'T LET BRAKE FLUID GET IN CONTACT WITH PAINT, IT IS AN EFFECTIVE PAINT REMOVER.
- USE ONLY CLEAN BRAKE FLUID TAKEN FROM A TIGHTLY SEALED CONTAINER.

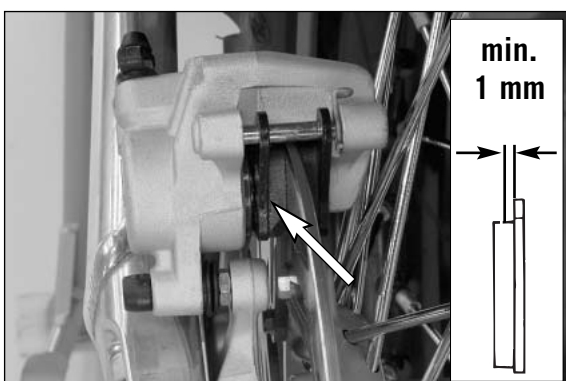
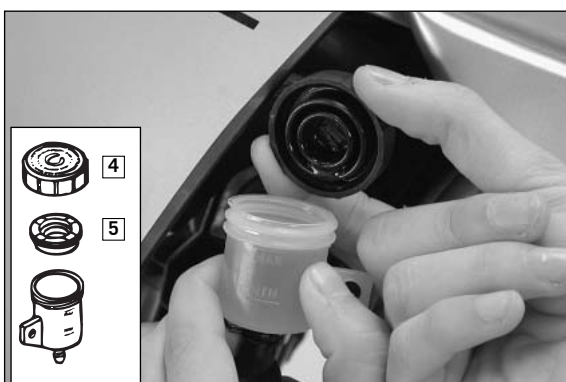

## Checking the rear brake pads

The brake pads can be inspected from the rear. The thickness of the linings may not be less than 1 mm (0.04 in).

### ⚠ WARNING

AT THEIR MOST WORN POINT BRAKE PAD LININGS SHOULD NOT BE THINNER THAN 1 MM, OTHERWISE THEY COULD LEAD TO BRAKE FAILURE. FOR YOUR OWN SAFETY DON'T PUT OFF HAVING YOUR BRAKE PADS CHANGED.

### ! CAUTION

IF THE BRAKE PADS ARE REPLACED TOO LATE SO THAT THE LINING IS PARTLY OR ENTIRELY WORN AWAY, THE STEEL COMPONENTS OF THE BRAKE PAD WILL RUB AGAINST THE BRAKE DISC, IMPAIRING THE BRAKING EFFECT AND DESTROYING THE BRAKE DISC.

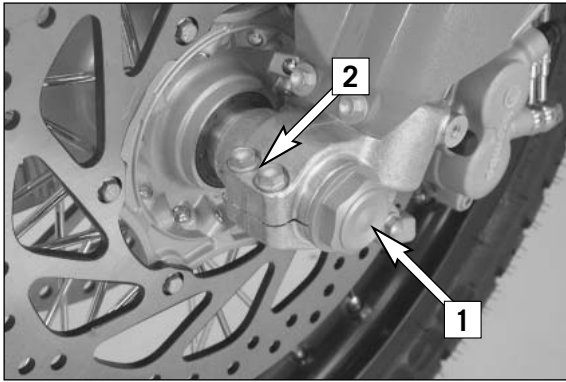

## Dismounting and mounting the front wheel \*

Jack the motorcycle up at the underride protection until the front wheel no longer touches the ground.

Loosen the collar screw [1] and the clamp screws [2] at both fork leg axle passages. Unscrew the collar screw approx. 8 turns, pressing your hand against the collar screw to push the axle passage out of the fork leg and remove the collar screw. Hold the front wheel and pull out the axle passage. Slightly pull one brake caliper out and take the front wheel off the fork.

Take the left [3] and right distance bushing out of the shaft seal rings.

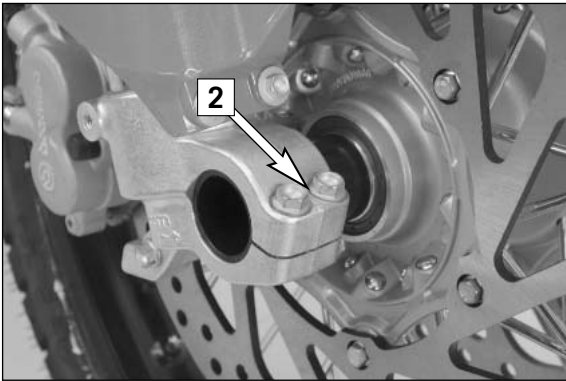

### ! CAUTION

- DO NOT OPERATE THE HAND BRAKE WHEN THE FRONT WHEEL HAS BEEN DISMOUNTED.
- BE CAREFUL NOT TO DAMAGE THE BRAKE DISKS WHEN YOU LAY THE FRONT WHEEL DOWN.

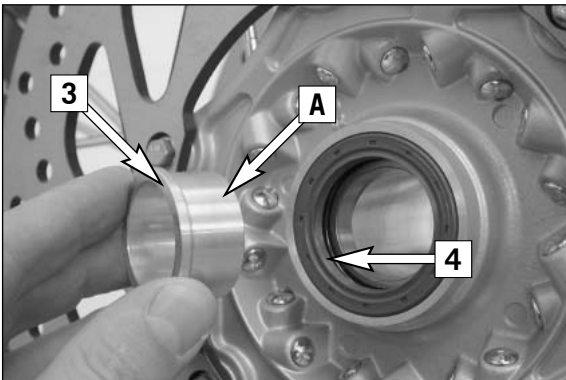

Before remounting the front wheel, clean and grease the shaft seal rings [4] and the bearing surface [A] of the distance bushings and mount the distance bushings (wide distance bushing in the left shaft seal ring). Slightly push back the brake pads with a screwdriver. Position the front wheel against the brake disks according to the direction of travel (see arrow [B]).

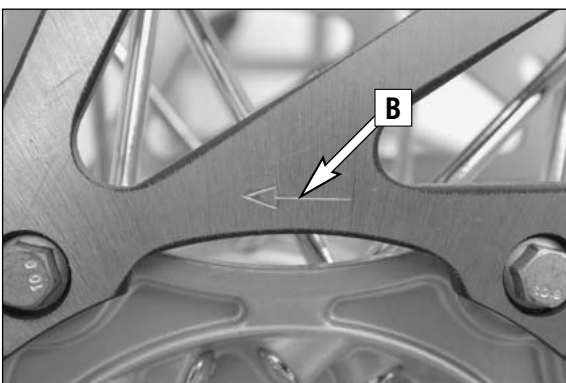

To mount the front wheel, lift the wheel into the fork, slightly pull one brake caliper out and push the tire in between the brake calipers. Insert the brake disks in the brake calipers and mount the axle passage.

Mount the collar screw [1] and tighten slightly. Tighten the clamp screws [2] on the right fork leg axle passage (in the direction of travel) tighten to prevent the axle passage from turning and tighten the collar nut to 60 Nm.

Loosen the clamp screws on the right fork leg axle passage, take the motorcycle off the stand, actuate the front wheel brake and vigorously compress the fork several times to align the fork legs.

Now you can tighten the clamp screws on both fork leg axle passages to 15 Nm.

### ⚠ WARNING

- IF YOU DO NOT HAVE A TORQUE WRENCH TO MOUNT THE WHEEL, HAVE THE TORQUES CORRECTED BY AN AUTHORIZED KTM WORKSHOP AS SOON AS POSSIBLE. A LOOSE AXLE PASSAGE CAN CAUSE THE MOTORCYCLE'S HANDLING PERFORMANCE TO BECOME INSTABLE.
- AFTER MOUNTING THE FRONT WHEEL, KEEP OPERATING THE HAND BRAKE UNTIL THE PRESSURE POINT RETURNS.
- ALWAYS KEEP THE BRAKE DISKS FREE FROM OIL AND GREASE, OTHERWISE THE BRAKING EFFECT WILL BE SIGNIFICANTLY REDUCED.

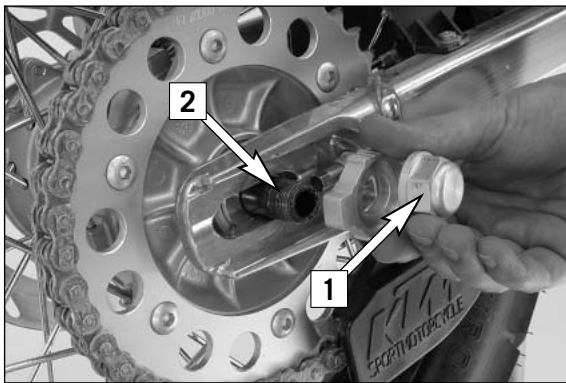

## Dismounting and mounting the rear wheel

Jack the motorcycle up by frame so that the rear wheel no longer touches the ground. Loosen the collar nut [1], hold the rear wheel and pull out the wheel spindle [2] until the rear wheel is free but the brake caliper support is still held. Push the rear wheel as far forward as possible, take the chain from the rear sprocket and carefully take the rear wheel out of the swingarm.

### ! CAUTION

- DO NOT OPERATE THE REAR BRAKE WHEN THE REAR WHEEL HAS BEEN DISMOUNTED.
- IF THE AXLE IS DISMOUNTED, CLEAN THE THREAD OF THE WHEEL SPINDLE AND COLLAR NUT THOROUGHLY AND APPLY A NEW COAT OF GREASE (MOTOREX LONG THERM 2000) TO PREVENT THE THREAD FROM JAMMING.
- ALWAYS PUT DOWN THE WHEEL WITH THE BRAKE DISC ON TOP TO PREVENT DAMAGING OF THE BRAKE DISC.

### NOTE:

When removing the rear wheel always check the damping rubbers.

The rear wheel is remounted in reverse order. Before tightening the collar nut to 80 Nm (59 ft.lbs), push the rear wheel forwards so that the chain tensioners lie on the tension screws.

### ⚠ WARNING

- IF YOU DON'T HAPPEN TO HAVE A TORQUE WRENCH AT HAND, MAKE SURE YOU HAVE THE TIGHTENING TORQUE CORRECTED BY A KTM DEALER AS SOON AS POSSIBLE. A LOOSE WHEEL SPINDLE MAY LEAD TO AN UNSTABLE DRIVING BEHAVIOR OF YOUR MOTORCYCLE.
- AFTER MOUNTING THE REAR WHEEL, KEEP OPERATING THE FOOTBRAKE UNTIL THE PRESSURE POINT RETURNS.
- IT IS VERY IMPORTANT TO KEEP THE BRAKE DISC FREE FROM OIL AND GREASE, OTHERWISE THE BRAKING EFFECT WOULD BE STRONGLY REDUCED.

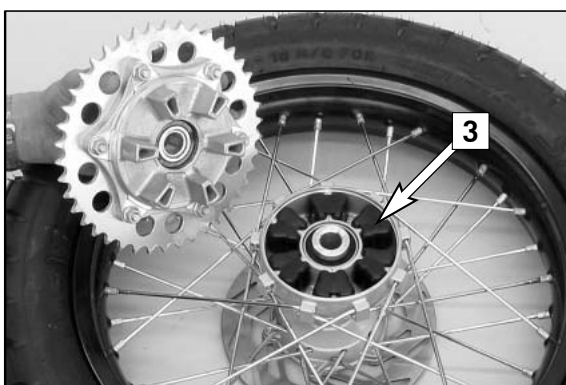
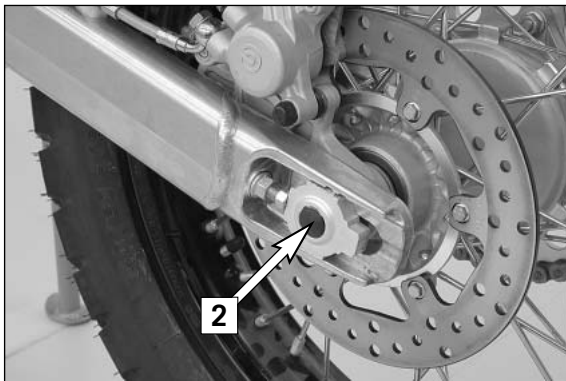

## Checking the shock absorption rubbers in the rear hub \*

LC4 models have a damped rear wheel hub. For this purpose, the engine power is conveyed from the rear sprocket via 6 shock absorption rubbers [3] to the rear wheel. These 6 absorption rubbers wear with increasing operation time, and should be checked for wear whenever the rear wheel is dismounted.

For this purpose, lie the rear wheel on a work bench with the rear sprocket upwards, and put the wheel spindle in the hub. Now hold the rear wheel firmly and try to turn the rear sprocket. The rear sprocket may not turn more than maximum 5 mm (0,2 in) measured on the outside. If the play in the chain wheel is larger, all 6 shock absorption rubbers are to be replaced. Check the shock absorption rubbers for signs of damage and dirt.

### ! CAUTION

IF THE SHOCK ABSORPTION RUBBERS ARE NOT REPLACED IN GOOD TIME, THE REAR SPROCKET CARRIER AND THE REAR HUB WILL BE DAMAGED. ALWAYS REPLACE ALL 6 ABSORPTION RUBBERS, NEVER SINGLE RUBBERS.

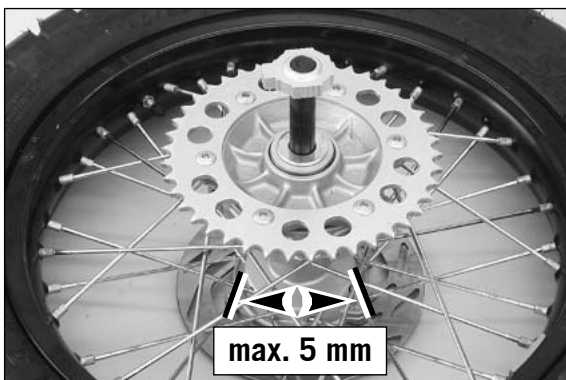





## Tires, air pressure

Tire type, tire condition, and how much air pressure the tires have in them affect the way your motorcycle rides, and they must therefore be checked whenever you're getting ready to go anywhere on your motorcycle.

### ⚠ WARNING

IN ORDER TO ENSURE RIDING SAFETY AND OPTIMAL RIDING PERFORMANCE, ONLY KTM-APPROVED TIRES MAY BE USED. OTHER TIRES CAN HAVE A NEGATIVE EFFECT ON RIDING PERFORMANCE (E.G. VIBRATION AT HIGHER SPEEDS).

Approved tires for 640 LC4 Adventure (as of July 2003)  
 BRIDGESTONE . . . .TW 301/302  
 METZELER . . . . .Enduro 3, Enduro 4, Karoo  
 MICHELIN . . . . .Sirac, T63  
 PIRELLI . . . . .MT21, MT60, MT70, MT90

| TIRES – AIR PRESSURE |                  |                  |
|----------------------|------------------|------------------|
|                      | front            | rear             |
| Road, driver only    | 1,8 bar (21 psi) | 2,0 bar (29 psi) |
| Road, with passenger | 2,0 bar (29 psi) | 2,2 bar (32 psi) |

- Tire type and size can be found in the technical specifications and in the homologation certificate
- Tire condition has to be checked every time you want to ride your motorcycle. Before leaving check for punctures and nails or other sharp objects that might have become embedded in the tire.
- Refer to the specific regulations in your country for minimum tire tread requirements. We recommend replacing tires at the latest when the tread is down to 2 mm.
- Tire pressure should be checked regularly on a "cold" tire. Proper pressure ensures optimum driving comfort and extends the life of your tires.

### ⚠ WARNING

- DO NOT MOUNT TIRES WHICH HAVE NOT BEEN APPROVED BY KTM. OTHER TIRES COULD HAVE ADVERSE EFFECTS ON THE WAY YOUR MOTORCYCLE RIDES.
- THE FRONT AND REAR WHEEL ARE ONLY ALLOWED TO BE TIED WITH TIRES THAT HAVE THE SAME PROFILE TYPE.
- FOR YOUR OWN SAFETY REPLACE DAMAGED TIRES IMMEDIATELY.
- WORN TIRES CAN HAVE A NEGATIVE EFFECT ON HOW YOUR MOTORCYCLE PERFORMS, ESPECIALLY ON WET SURFACES
- IF AIR PRESSURE IS TOO LOW, ABNORMAL WEAR AND OVERHEATING OF THE TIRE CAN RESULT
- NEW WHEELS HAVE A SMOOTH SURFACE, WHICH MEANS THAT THEY MUST BE RUN IN TO ACHIEVE FULL GRIP. FOR THIS PURPOSE, RIDE THE MOTORCYCLE CAREFULLY AT MODERATE SPEED DURING THE FIRST 200 KILOMETERS WITH NEW TIRES, TILTING THE VEHICLE AT DIFFERENT ANGLES SO THAT ALL SECTIONS ARE PROPERLY ROUGHENED. TIRES WILL NOT DISPLAY THEIR FULL GRIP CHARACTERISTICS UNTIL THEY ARE PROPERLY RUN IN.
- FOR REASONS OF SAFETY, IT IS RECOMMENDED TO EXCHANGE THE VALVE INSERT WHENEVER A NEW TIRE IS MOUNTED.



## Checking spoke tension

The correct spoke tension is very important for the stability of the wheels and thus for riding safety. A loose spoke causes the wheel to become unbalanced and before long other spokes will have come loose. Check spoke tension, especially on a new motorcycle, in regular intervals. For checking, tap on each spoke with the blade of a screw driver (see illustration). A clear tone must be the result. Dull tones indicate loose spokes. If necessary, have the spokes retightened and the wheel centered by a KTM dealer.

### ⚠ WARNING

- SPOKES CAN TEAR IF YOU CONTINUE TO RIDE WITH THEM LOOSE. THIS MAY LEAD TO AN UNSTABLE HANDLING OF YOUR MOTORCYCLE.
- EXCESSIVELY TENSIONED SPOKES MAY RUPTURE DUE TO LOCAL OVERLOADING. THE SPOKES MUST BE TENSIONED TO 5 NM ± 1 NM.

# MAINTENANCE WORK ON CHASSIS AND ENGINE »

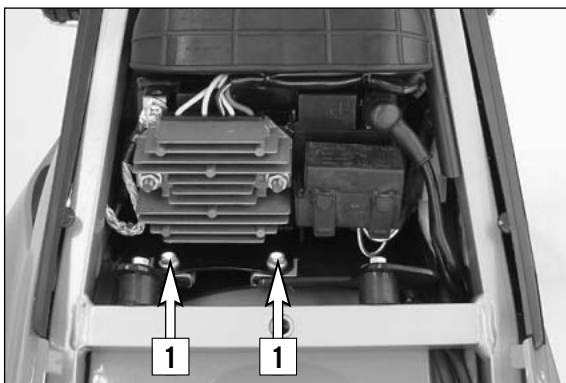

## Battery

The battery is located under the seat and is maintenance-free. It is not necessary to check the electrolyte level or to refill water. Simply keep the battery poles clean and slightly grease them with an acid-free grease if necessary.

Removing the battery:

Remove screws [1] and swing retaining bracket and voltage regulator out of the way.

First disconnect the negative and then the positive pole of the battery.

Remove battery.

When replacing, connect first the positive and then the negative pole.

### ⚠ WARNING

- IF ELECTROLYTE (SULPHURIC ACID) LEAKS FROM THE BATTERY, PROCEED WITH GREAT CARE. THE ELECTROLYTE CAN CAUSE SEVERE BURNS.
- IN THE CASE OF SKIN CONTACT RINSE THOROUGHLY WITH WATER.
- IN THE CASE OF CONTACT WITH THE EYES, THOROUGHLY RINSE EYES WITH WATER FOR AT LEAST 15 MINUTES. IMMEDIATELY CONSULT A DOCTOR.
- THE BATTERY IS A CLOSED MODEL BUT CAN NEVERTHELESS EMIT EXPLOSIVE GASES. AVOID SPARKS AND OPEN FIRE NEAR THE BATTERY.
- DEFECTIVE BATTERIES MUST BE STORED OUT OF THE REACH OF CHILDREN. ENSURE PROPER DISPOSAL OF DISCARDED BATTERIES.

### ! CAUTION

- TO AVOID DAMAGE, DO NOT REMOVE THE LOCKING BAR [2]!
- NEVER DISCONNECT THE BATTERY WHILE THE ENGINE IS RUNNING. THIS WILL DESTROY THE RECTIFIER-REGULATOR.
- THE BATTERY MUST BE INSTALLED WITH THE TERMINALS FACING THE FRONT (AS SHOWN IN THE ILLUSTRATION), OTHERWISE ELECTROLYTE CAN ESCAPE.

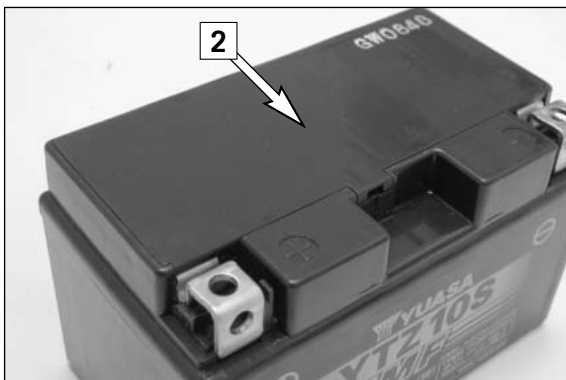

## BATTERY STORAGE:

When preparing the motorcycle for a longer period of standstill, remove the battery and recharge it. Storage temperature: 0 - 35°C (30 - 95°F). Do not expose to direct sunlight.

## Charging the battery

NOTE: A battery charger, item no. 58429074000 is available from your KTM dealer.

You can also use the battery charger to test the battery's off load voltage, startability and the generator capacity.

Remove the battery and check the charging level. Use a voltmeter to measure the voltage between the battery poles (off-load voltage).

Accurate results can only be obtained if the battery has neither been charged nor discharged during a period of 30 minutes preceding the measuring.

Recharging is not required if the voltage exceeds 12.4 V.

Recharge if the voltage is below 12.4 V.

## CHARGING:

Charge the battery for 5 to a max. of 10 hours with 0.9 amperes and a max. of 14.4 volts.

For a quick charge, do not charge the battery longer than 1 hour with 4.5 amperes and a max. of 14.4 volts.

### ! CAUTION

- IF THE CHARGE CONDITION CANNOT BE ESTABLISHED, THE BATTERY MAY ONLY BE CHARGED 5 TO A MAX. OF 10 HOURS WITH 0.9 AMPERES AND A MAX. OF 14.4 VOLTS.
- ALWAYS CONNECT THE BATTERY TO THE CHARGING UNIT BEFORE TURNING THE CHARGING UNIT ON.
- WHEN RECHARGING THE BATTERY IN CLOSED ROOMS THERE IS SUFFICIENT VENTILATION. EXPLOSIVE GASES ARE RELEASED DURING THE BATTERY CHARGING PROCESS.
- CHARGING TIME AND CHARGING VOLTAGE SHOULD NOT EXCEED THE STATED VALUES. OTHERWISE ELECTROLYTE WILL BE RELEASED THROUGH THE SAFETY VALVES.
- AVOID QUICK CHARGING IF POSSIBLE.
- TO AVOID DAMAGE, DO NOT REMOVE THE LOCKING BAR.

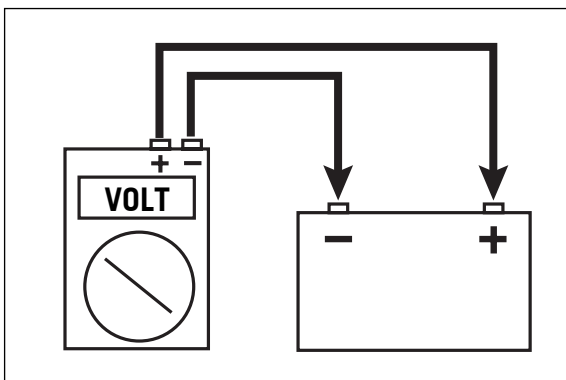



## Fuses

Fuse box [A] is located under the seat. See "Removing the seat" to remove and mount the seat. The fuses are numbered on the inside of the fuse box. The fuses marked "RES" are spare fuses.

Main fuse 1 (20 amperes) protects all power consumers against short circuits.

Fuse 2 (10 Ampere) protects the following power-consuming units:

- electronic speedometer
- capacitor

Fuse 3 (10 Ampere) protects the following power-consuming units:

- ignition
- starter system

Fuse 4 (10 Ampere) protects the following power-consuming units:

- flasher lights
- brake light
- horn
- fan

Fuse 5 (10 Ampere) protects the following power-consuming units:

- headlight
- parking light

Replace a blown fuse only with an equivalent one. If a new fuse that has just been set in gets blown again, you are strongly advised to have it inspected by a KTM dealer.

## ! CAUTION

UNDER NO CIRCUMSTANCES IS A STRONGER FUSE ALLOWED TO BE SET IN OR A FUSE ALLOWED TO BE "REPAIRED". AN INEXPERT TREATMENT COULD DAMAGE THE WHOLE ELECTRICAL INSTALLATION!

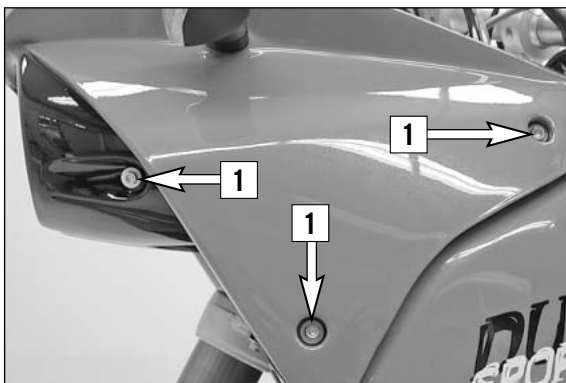
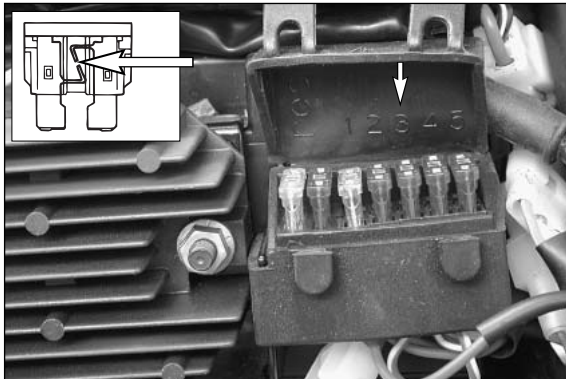

## Removing and mounting the headlight mask \*

The headlight mask must be removed to replace the headlight lamps, the indicator lamps or the tachometer lamps.

### REMOVING THE HEADLIGHT MASK

Use the wrench from the tool kit to remove the 6 screws [1] of the headlight mask.

Swing the headlight mask forward, disconnect the flasher cables and remove the mask.

### MOUNTING THE HEADLIGHT MASK

Hold the headlight mask and connect the flasher cables.

Position the headlight mask and replace the screws without tightening them yet.

Tighten all 6 screws at once with 5 Nm (4 ft.lbs).



## Replacing the headlight bulb \*

The headlights are accessible after you have removed the headlight mask.

Turn the cover [2] counterclockwise, and remove it.

Detach the spring bar [3], and remove the lamp from the headlight insert and connect a new H1 lamp (12 V 55 W)

## ! CAUTION

THE GLASS OF THE BULB MUST BE FREE OF OIL AND GREASE. THE HEAT CAUSES THE OIL TO VAPORIZE. THE RESULTING VAPOR ON THE REFLECTOR DECREASES THE BRIGHTNESS OF THE HEADLIGHT.

Start the engine and check the headlight for proper functioning.

Place the cover in position, and turn it clockwise.

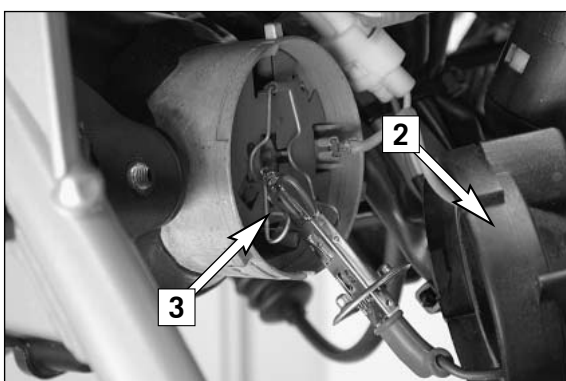

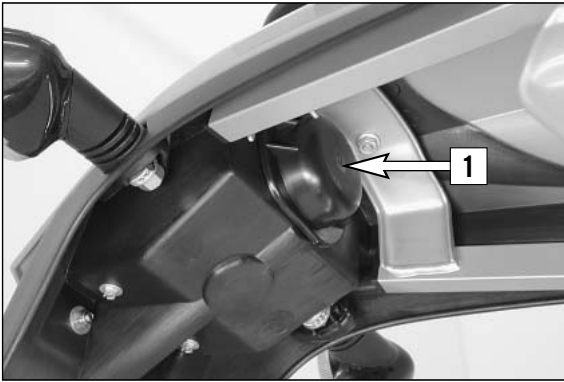

## Exchanging the brake light and tail light bulb

Remove the cap [1] on the underside of the license plate retainer.

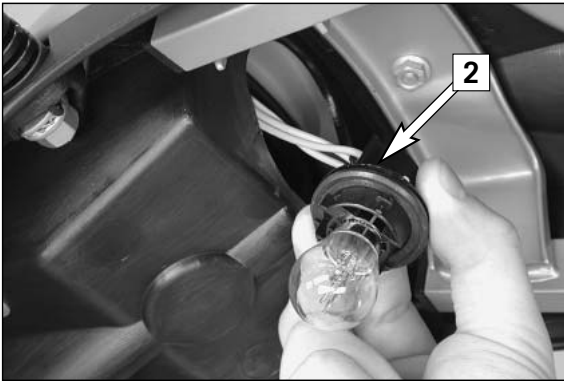

Turn the lamp socket [2] approximately 30° counterclockwise and pull it out of the tail light housing.

Slightly depress the bulb, turn it approx. 30° counterclockwise and pull it out of the socket.

To mount the lamp reverse the worksteps indicated above.

NOTE: Since the bulb on the tail end is subjected to higher vibrations, heavy-duty bulbs are available from your KTM dealer.



## Removing the tank \*

Removing the seat (see page 22)

Removing the headlight mask (see page 34)

Close the auxiliary fuel cocks (turn in a clockwise direction) and the fuel cock (OFF position).

Close the fuel lines to the 3 fuel cocks.

Unplug the plug connector [3] to the gasoline level sensor.

### ! CAUTION

THE GASOLINE LEVEL SENSOR WILL BE DAMAGED IF THE PLUG CONNECTOR [3] IS NOT UNPLUGGED WHEN YOU REMOVE THE TANK.

Remove the collar nut [4] and washers.

Lift the rear tank 10-12 cm and lift off.

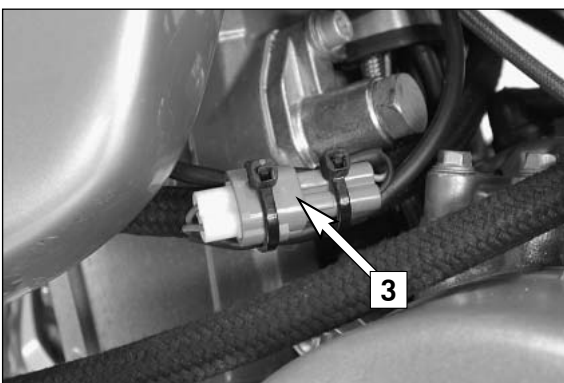

Mount the tank carefully. Mount the insulating disk, steel disk and collar nut and tighten. Connect the fuel lines and open the fuel cocks. Connect the plug and socket connector for the gasoline level sensor and fix to the fuel lines with cable clips.

NOTE:

The line leading to the fuel pump must be connected to the fuel cock.

Mount the headlight mask (see page 34).

Mount the seat (see page 22).

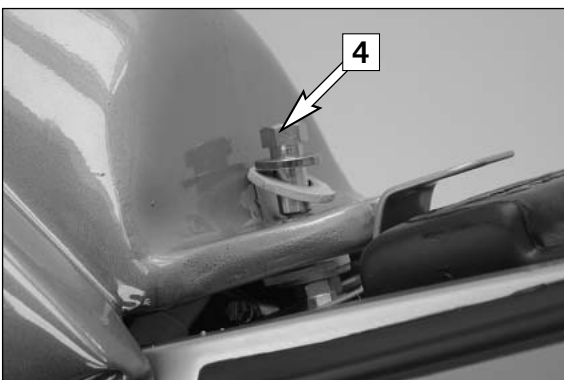



## Cooling system

Coolant is circulated by a water pump located in the engine. When the engine is cold the cooling liquid circulates only through the cylinder and the cylinder head. After the engine has reached its operating temperature (about 70°C, 158°F), the thermostat opens and the cooling liquid is also pumped through both aluminum radiators.

Air blowing in through the radiators cools the cooling liquid. The slower the speed of the motorcycle, the less the cooling liquid is cooled down. Dirty radiator fins also reduce the cooling efficiency.

If little or no air blows through the radiators, for example when riding through slow traffic or waiting at traffic lights, the coolant temperature will rise. If the coolant temperature rises to 98°C (208,4°F), the fan [1] on the left radiator will switch on. This fan will provide additional air circulation through the radiator thereby preventing the cooling system from overheating.

### ! CAUTION

THE RED COOLING LIQUID TEMPERATURE WARNING LIGHT [2] WILL BEGIN TO LIGHT UP, IF THE COOLING LIQUID TEMPERATURE REACHES APPROX. 120°C (248°F) AND HENCEFORTH HAS EXCEEDED ITS NORMAL OPERATING TEMPERATURE.

POSSIBLE CAUSES:

- RIDING SLOWLY WITH A LARGE LOAD AT A HIGHER AIR TEMPERATURE:  
IF POSSIBLE INCREASE YOUR RUNNING SPEED, SO THAT MORE AIR CAN BLOW THROUGH THE RADIATORS. SHOULD THE WARNING LIGHT STILL BE ON OFF AFTER 300 METERS, STOP IMMEDIATELY, SWITCH OFF THE ENGINE AND LOOK FOR OTHER POSSIBLE CAUSES.
- TOO LITTLE COOLING LIQUID IN THE SYSTEM:  
LET THE ENGINE COOL DOWN, AND CHECK THE SYSTEM FOR LEAKAGE'S. ALSO EXAMINE THE COOLING LIQUID LEVEL. **CAUTION SCALDING HAZARD!** DO NOT DRIVE ON, UNTIL THERE IS SUFFICIENT LIQUID IN THE COOLING SYSTEM. GO TO YOUR NEAREST KTM GARAGE AND GET IT SEEN TO. IF YOU DRIVE WITH THE COOLING LIQUID TEMPERATURE WARNING LIGHT ON, YOU WILL CAUSE EVEN MORE DAMAGES TO THE ENGINE.
- THE COOLING FAN ON THE LEFT COOLER IS NOT WORKING:  
THE COOLING FAN MUST BE RUNNING, WHEN THE COOLING LIQUID TEMPERATURE IS 98°C (208,4°F) AND THE IGNITION IS ON. IF THE FAN IS NOT WORKING, AND THERE APPEARS TO BE SUFFICIENT COOLING LIQUID, THE ONLY THING YOU CAN DO IS TO DRIVE ON TO YOUR NEAREST KTM GARAGE AT THE LEAST POSSIBLE ENGINE LOAD.
- CONTINUOUS USE OF THE CLUTCH (RIDING THE CLUTCH) AT LOWER SPEEDS.

A mixture of 50% antifreezer and 50% distilled water is used as cooling liquid. However, the anti-freeze protection must be at least -25° C (-13° F). Aside from antifreezing protection, this mixture also provides great corrosion protection which is why it must not be replaced by pure water.

### ! CAUTION

FOR THE COOLING SYSTEM, USE ONLY HIGH-GRADE ANTIFREEZER (MOTOREX ANTI-FREEZE). USING LOWERGRADE ANTIFREEZE AGENTS, CAN CAUSE CORROSION AND COOLANT FOAMING.

Pressure induced by heating of the cooling liquid in the cooling system is controlled by a valve in the radiator cap [3]; a water temperature rising up to 120° C (248° F) is admissible, without fear of problems.

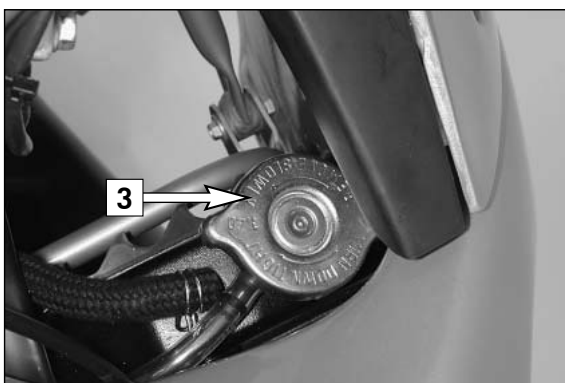
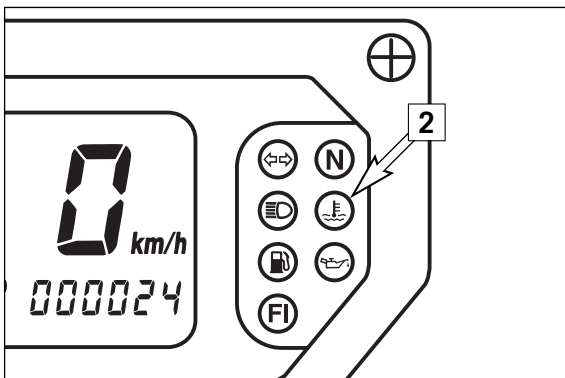

## Checking the cooling liquid level

The cooling liquid should be 10 mm (0,4 in) above the cooling elements when the engine is cold (cf. diagram). In the event of the cooling liquid being drained, always fill the system before hand, then top off while the engine is running.

### ! WARNING

IF POSSIBLE, ALWAYS CHECK LEVEL OF COOLING LIQUID WHEN ENGINE IS COLD. IF YOU HAVE TO OPEN THE RADIATOR CAP WHEN ENGINE IS HOT, USE A RAG TO COVER THE CAP AND OPEN SLOWLY TO RELEASE PRESSURE.

**CAUTION – SCALDING HAZARD!**

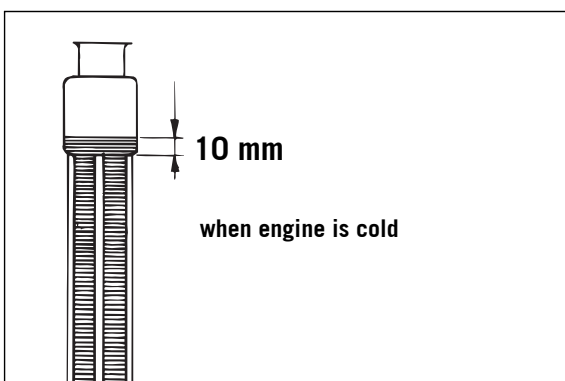

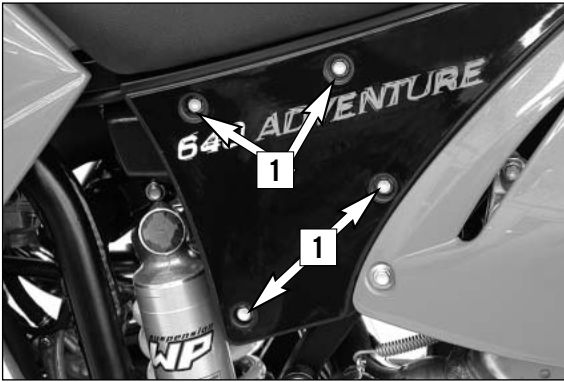

## Cleaning the air filter \*

It is very important for the engine's life expectancy to clean the air filter regularly.

To clean the air filter, remove screws [1] and the filter box cover. Detach retaining clip [2] and remove the air filter [3] including the filter holder [4] from the filter box.

Remove the air filter from the filter holder and wash thoroughly in special cleaning fluid. Motorex offers environmentally-friendly products for professional oil filter maintenance (Motorex Bio Dirt Remover and Motorex Liquid Bio Power). Press out the water from the air filter – but do not wring – and allow the filter to dry. Lubricate the dry air filter thoroughly with high-grade filter oil, rubbing to coat the entire filter surface.

Clean the filter box and cover and check the carburetor connection boot for damage.

Mount the air filter on the filter holder, position in the filter box (make sure to center) and fix with the retaining clip. Check whether the air filter is positioned correctly and mount the filter box cover.

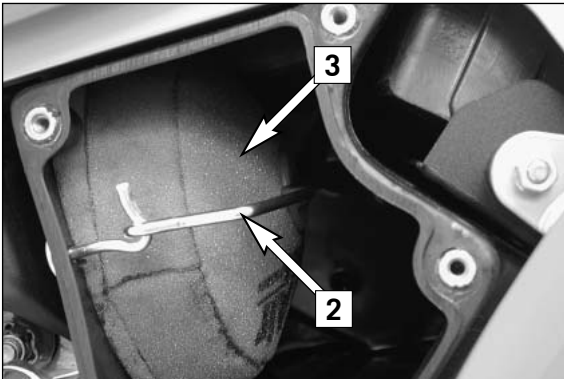

## ! CAUTION

- DO NOT CLEAN AIR FILTER WITH FUEL OR PETROLEUM SINCE THESE WILL DAMAGE THE FOAM. KTM RECOMMENDS THE PRODUCTS MADE BY MOTOREX (BIO DIRT REMOVER AND LIQUID BIO POWER) FOR AIR FILTER MAINTENANCE. FOR CLEANING PURPOSES AND TO OIL THE AIR FILTER.
- DUST AND DIRT CAN ACCUMULATE AND DAMAGE THE ENGINE IF THE AIR FILTER IS NOT MOUNTED CORRECTLY.

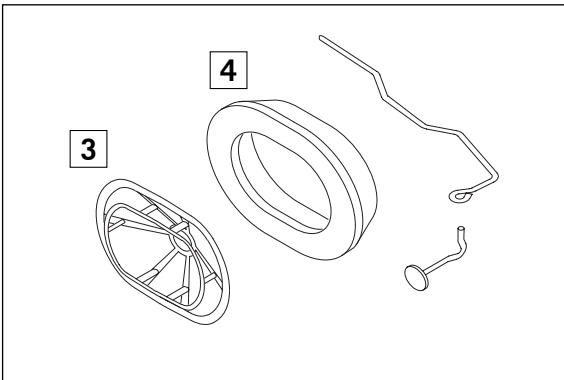

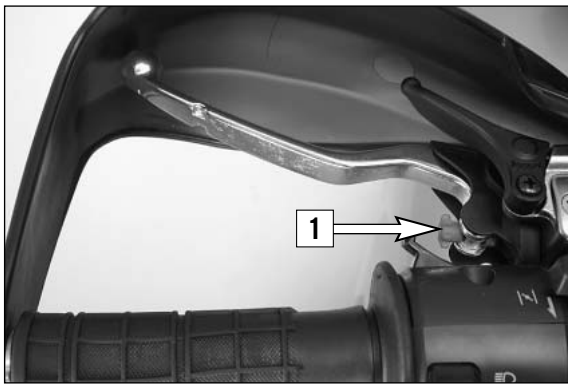

## Changing the original position of the clutch lever

The adjusting screw [1] can be used for individual adjustment of the original position of the clutch lever, thus allowing adjustment to an optimal position for every hand size.

Turning the adjusting screw counterclockwise reduces the distance between the clutch lever and the handlebar. Turning the adjusting screw clockwise increases the distance between the clutch lever and the handlebar.

### ! CAUTION

ADJUSTMENT OF THE CLUTCH LEVER POSITION IS ONLY POSSIBLE WITHIN CERTAIN LIMITS. ONLY TURN THE ADJUSTING SCREW MANUALLY AND NEVER APPLY EXCESSIVE FORCE.

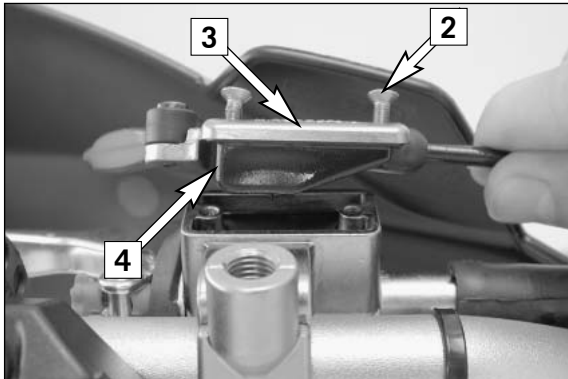

## Checking the oil level of the hydraulic clutch

To check the oil level in the master cylinder of the clutch remove the cover. For this purpose, remove screws [2] and cover [3] together with the rubber boot [4]. The oil level in the horizontal-standing master cylinder should be 4 mm below the upper edge.

If necessary, add SAE 10 biodegradable hydraulic oil (Motorex clutch fluid 75), available from your authorized KTM workshop.

### ! CAUTION

KTM USES BIODEGRADABLE, HYDRAULIC MINERAL OIL TO ACTUATE THE HYDRAULIC CLUTCH. DO NOT MIX THIS OIL WITH ANY OTHER HYDRAULIC OIL. ALWAYS USE ORIGINAL KTM HYDRAULIC OIL (AVAILABLE FROM YOUR AUTHORIZED KTM WORKSHOP) TO MAKE SURE YOUR CLUTCH OPERATES SMOOTHLY. NEVER REFILL WITH BRAKE FLUID.

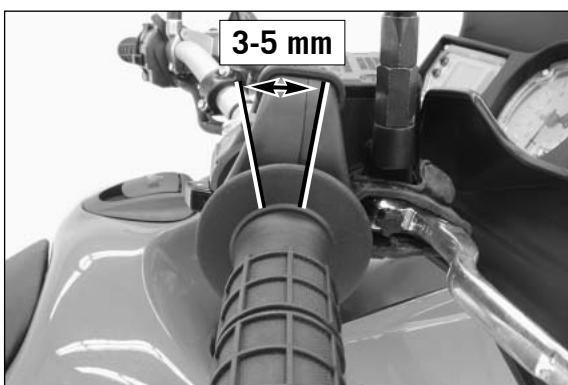

## Adjusting the throttle cable \*

When starting to turn the throttle grip, you should feel an initial backlash of 3-5 mm (0.11-0.19 in).

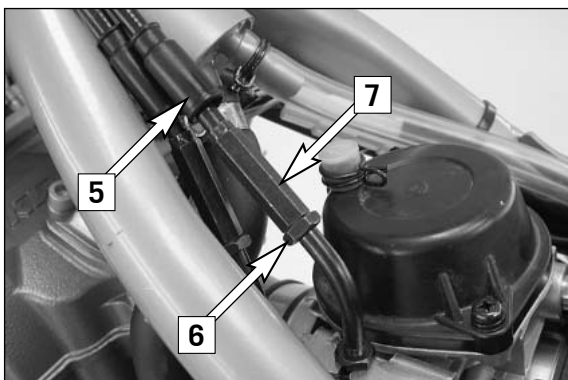

If a correction is necessary, start by removing the tank. Slide back the protection cover [5]. To set the backlash, loosen the counter nut [6] and turn the adjusting screw [7] accordingly. Then, fasten the counter nut and slide the protection cover back on.

Make sure that the throttle grip will return to the idle position automatically once you let go of it.

To check the correctness of this setting, start the engine, turn the handlebar left and right, in both cases as far as it will go. This must not cause any changes in idling speed. Otherwise, you have to increase the backlash of the throttle cable.

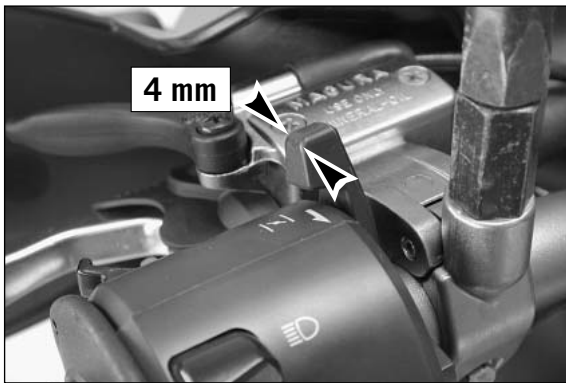

## Checking and adjusting the choke cable play \*

The choke lever must always have a play of approx. 4 mm (0.16 in).

### ! CAUTION

IF THERE IS NO PLAY IN THE CHOKE CABLE, THE BORE OF THE COLD STARTER SYSTEM CANNOT BE COMPLETELY CLOSED. THIS RESULTS IN HIGH FUEL CONSUMPTION, AN UNEVEN RUNNING ENGINE, AND AN EXTREME WEAR OF PISTON AND CYLINDER.

Remove the seat and tank to adjust.

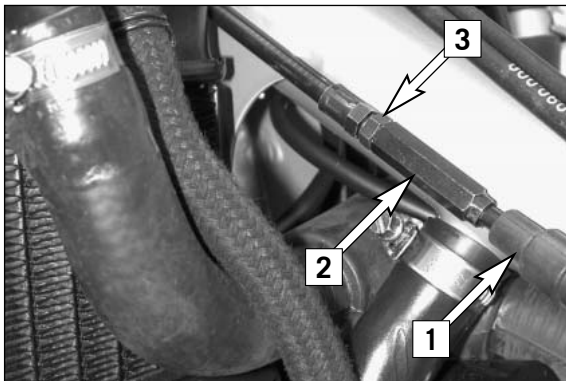

Push the choke lever all the way to the front and slide the protecting cap [1] from the adjusting part [2].

Loosen the lock nut [3] and correct the play by turning the adjusting part. Tighten lock nut and slide protecting cap back on.

Mount the tank and seat.

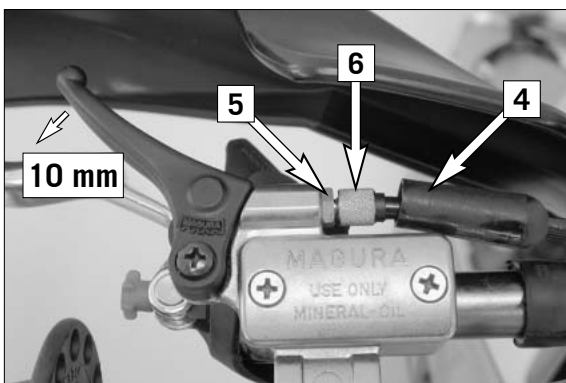

## Checking the adjustment of the hand decompression cable \*

To check, set piston at compression, so that the valves are closed. While doing this, slowly operate the kickstarter through its stroke until the clicking sound (disengaging) of the automatic decompression can be heard. Now the decompression lever must be operated 10 mm (0,39 in) until resistance is felt (the exhaust valves begin to open). To adjust move back the protective cover [4], loosen the counter nut [5] and correct the adjusting screw [6] accordingly. Tighten counter nut and push back protective cover.

### ! CAUTION

THE SETTING OF THE HAND DECOMPRESSION CABLE SHOULD BE REGULARLY CHECKED (SEE MAINTENANCE WORK). A LACK OF PLAY IN THE HAND DECOMPRESSION LEVER CAN RESULT IN ENGINE DAMAGE.

NOTE:

No adjustment need be made to the automatic decompressor.

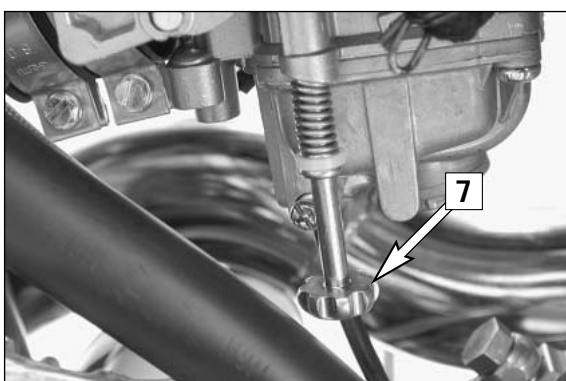

## Adjust idling speed \*

Use the adjusting screw [7] to adjust the basic position of the throttle valve and, thus, the idle speed. Turning in clockwise direction will increase the idling speed, turning in counterclockwise direction will reduce the idling speed. Normal idling speed 1400 - 1500 rpm.



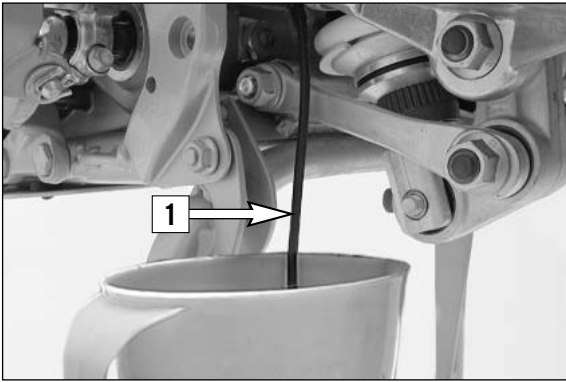

## Draining of float chamber of the carburetor \*

Following every wet-cleaning procedure, the float chamber of the carburetor should be drained in order to remove any water that may have penetrated into it. Water in the float chamber leads to engine malfunction.

Wait until the engine is cold before commencing to perform the worksteps indicated below.

Close the fuel tap.

Put the end of the hose [1] that leads downward behind the engine into an appropriate container.

Open the drain plug [2], turning it counterclockwise a few times, and let the fuel drain from the float chamber.

Then tighten the drain plug and open the fuel tap.

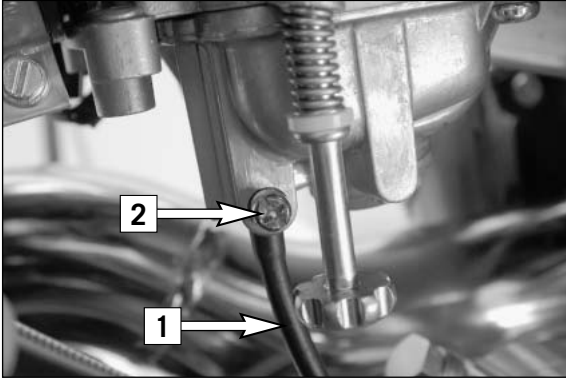

**JASO T903 MA**

TEMPERATUR

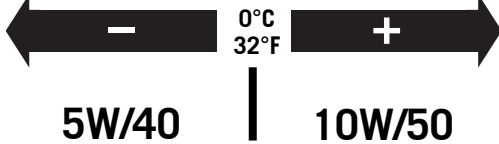

## Engine oil

Automobile engine oil used to be used for four-stroke motorcycles before there were separate motorcycle specifications. Different technical developments made it necessary to have a separate specification for four-stroke motorcycles - the JASO T903 MA standard. Whereas car engines require long changing intervals, motorcycle engines require a higher power output at higher speeds. Most motorcycle engines also use the same oil to lubricate the transmission and the clutch. The JASO MA standard responds to these special requirements. Only use fully synthetic engine oils that meet the JASO MA quality requirements (see information on the can).

KTM recommends Motorex Power Synt 4T in the 10W/50 viscosity (for temperatures over 0°C, 32°F) or 5W/40 (for temperatures under 0°C, 32°F).

## Checking the engine oil level

The engine oil level can be checked when the engine is cold or warm.

To check, place the motorcycle in an upright position on a level surface (center stand).

If the engine is cold, the oil level should be visible at the lower edge A of the inspection glass.

If the engine is warm, the oil level should be visible at the upper edge B of the inspection glass.

Add engine oil if necessary.

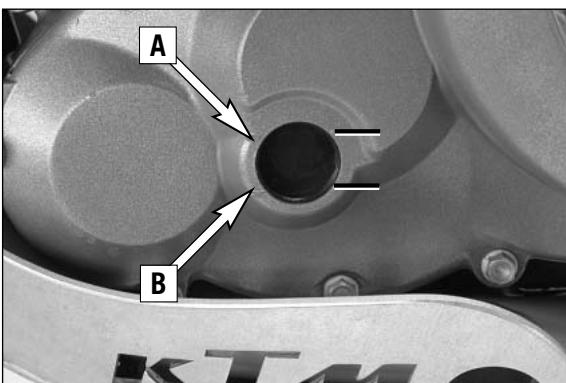

## ! CAUTION

- INSUFFICIENT AMOUNTS OF OR LOW-GRADE ENGINE OIL LEAD TO PREMATURE WEAR IN THE ENGINE.
- DO NOT OVERFILL THE ENGINE CASE.
- DO NOT UNDERFILL THE ENGINE CASE.

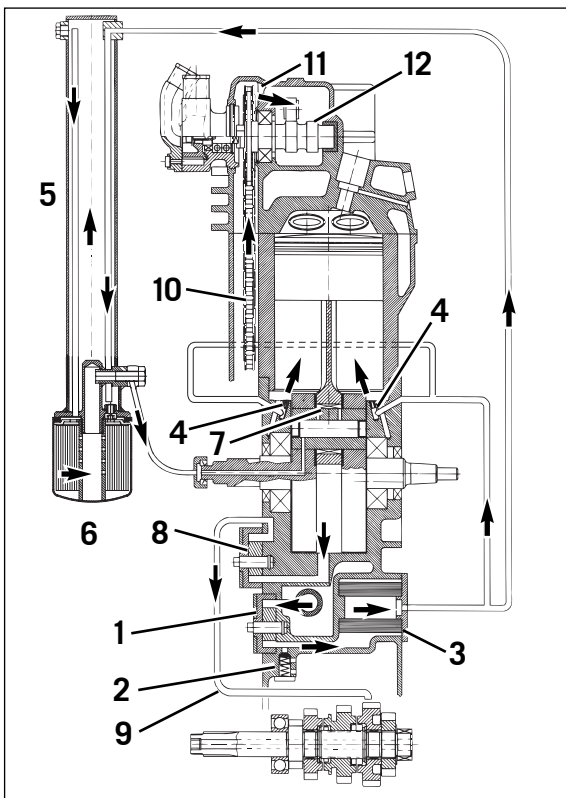

## Oil circuit

The oil pump [1] pumps the motor oil past the bypass valve [2] and through the oil filter [3]. Beyond the oil filter, one of the oil lines forks off to the jets [4], they inject motor oil to the piston pin bearing and the piston head. The second oil line leads the main oil flow to the frame breast pipe [5] where the motor oil is cooled off. Then the motor oil flows through the fine screen filter [6] that removes even the finest of contaminants from the motor oil. The cleansed motor oil is pumped via an oil line and the clutch cover into the crankshaft to the conrod bearing [7] and drains from there into the crank case. A additional oil pump [8] suctions the motor oil out of the crank case and pumps it through the oil canal [9] to the gear wheels of the 4th and 5th gears. The motor oil reaches the oil sump via the gear wheels. The timing chain [10] also dips into the oil sump and propels motor oil upwards to the cylinder head. The motor oil reaches the camshaft [12] and the valves through the bore [11].

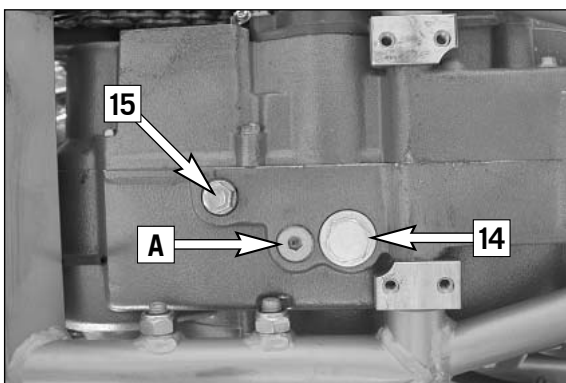

## Oil and screen filter change, bleeding of the oil system \*

Note: The frame breast pipe is integrated into the oil circuit for the sake of more effectively cooling the motor oil. It is thus important when changing the oil to also remove the fine screen filter, to drain the motor oil from the breast pipe and to de-aerate the oil system.

If the oil system is not bled at all or bled insufficiently, the bearings of the engine will not get enough lubrication, which in turn may result in engine failure.

Therefore, we recommend that you have the engine oil changed by your authorized KTM mechanic. During the guaranty period, the oil change must be performed by an authorized KTM mechanic. Otherwise, the guarantee will become void.

The engine oil change is to be carried out when the engine is still warm.

### ⚠ WARNING

AN ENGINE HAVING BEEN RUN WARM, AND THE ENGINE OIL IN IT IS VERY HOT – DO NOT BURN YOURSELF.

Place the motorcycle on a horizontal surface.

Remove 5 screws to remove the engine guard [13].

Remove the two screw plugs [14] and [15] and drain oil into a vessel. Loosen the fine filter [6] with an oil-filter wrench and unscrew by hand.

### ! CAUTION

PLUG [A] MUST NOT BE REMOVED, THIS IS PART OF THE BY-PASS VALVE.

The screw [16] must be removed to allow the motor oil to flow out of the frame breast pipe.

Clean the plugs thoroughly with petroleum and compressed air in order to remove any metal filings. After the oil has drained completely, clean the sealing areas and remount the plugs together with their gaskets. Tighten plug [14] with 30 Nm and plug [15] with 20 Nm. Tighten the screw [16] with 10 Nm. Clean sealing surfaces on the frame breast pipe [17], fill new fine screen filter with engine oil, and oil rubber gasket [18]. Replace fine screen filter and screw it back in place, your bare hand will do.

Remove screw connection on the clutch cover, fill with 1.3 litre engine oil and attach plug again.

### ! CAUTION

- USE ONLY ORIGINAL KTM FINE SCREEN FILTERS. USING ANOTHER FILTER BRAND CAN RESULT IN DAMAGE TO THE ENGINE.
- IF THE ENGINE OIL HAS BEEN DRAINED FROM THE FRONT PIPE OF THE FRAME, YOU MUST BLEED THE OIL SYSTEM !

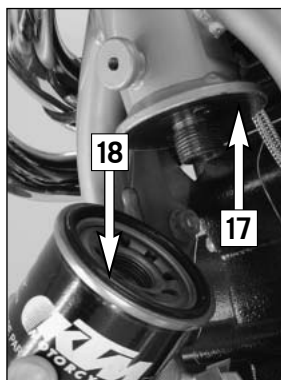
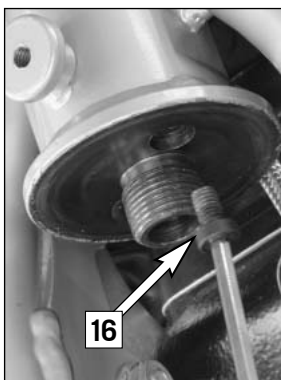
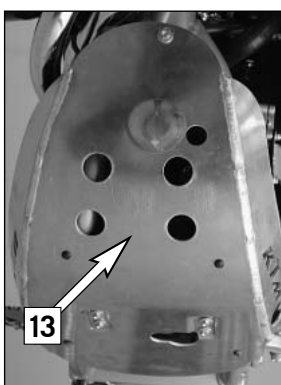

# MAINTENANCE WORK ON CHASSIS AND ENGINE »



## BLEEDING OF THE OIL SYSTEM

To facilitate bleeding of the oil system, we have added a hose connection piece and a plastic hose to the set of tools. Take an empty oil can (1 liter) and drill a 7 mm-diameter hole into the lid. Screw the hose connection piece into the lid from the outside, and secure it from the inside with the M8 hexagon nut. Slip the plastic hose onto the hose connection piece, and you will have your filling tool.

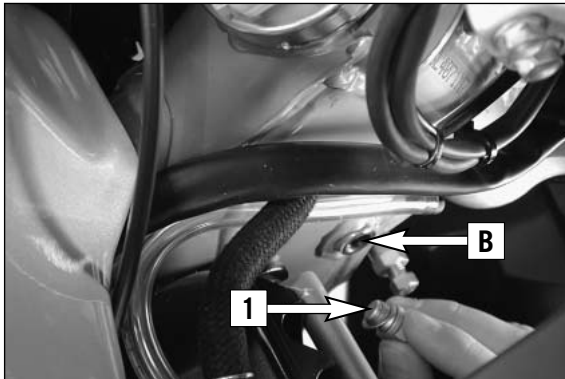

Fill 0.6 liters of engine oil into the can and remove the plug [1] next to the steering head. Introduce the plastic hose into the vent hole [B], (see page 30) and fill 0.6 liters of engine oil into the frame's front tube. Remove plastic hose, start engine, and let it idle (approx. 20 seconds) until oil escapes at the hole [B]. As soon as oil starts to escape, turn off the engine, and mount the plug together with the gasket and tighten to 25Nm.

Allow the engine to warm up, check the engine oil level and correct if necessary.

Afterwards, check the entire oil system for leakage. Mount the engine guard.

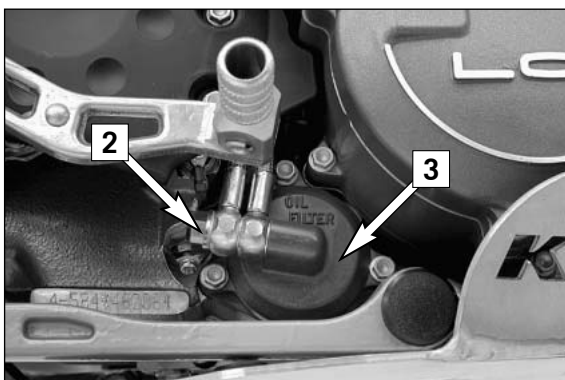

## Changing oil filter \*

Replace the oil filter when changing the engine oil. Press the foot brake pedal and place a screwdriver or similar between foot brake pedal and stopper roll so that the oil filter cover is more accessible. Remove banjo bolt [2] and the three screws. Remove oil filter cover [3] and oil filter. Clean the filter case, oil filter cover and sealing areas. Make sure the oil duct in the oil filter cover is not clogged.

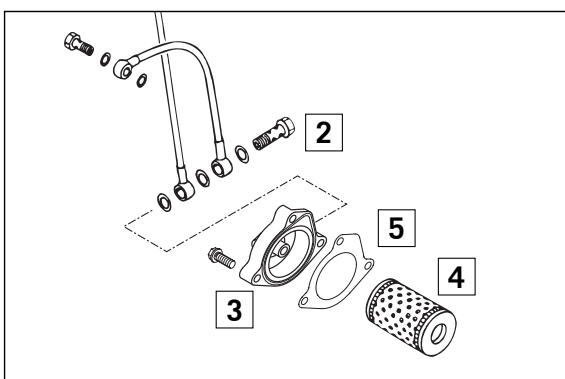

Place the new oil filter [4] on the connection in the oil filter cover and mount together with a new seal [5]. Tighten the 3 screws in the filter cover to 5 Nm (4 ft.lb). Tighten the hollow screw with seals and tighten to 15 Nm (11 ft.lb). Finally, start the engine and check the oil system for leakage.

## TROUBLE SHOOTING »

If you let the specified maintenance work on your motorcycle be carried out, disturbances can hardly be expected. Should an error occur nevertheless, we advise you to use the trouble shooting chart in order to find the cause of error.

We would like to point out that many operations cannot be performed by oneself. In case of uncertainty, please contact a KTM-dealer.

| TROUBLE  | CAUSE  | REMEDY  |
|--|--|---|
| Engine does not switch on  | Operating error  | Switch on the ignition, shift into neutral, switch on the emergency OFF switch  |
|  | Battery is dead  | Charge the battery and determine the cause of discharging; visit an authorized workshop   |
|  | Defective ignition or emergency OFF switch   | Check the ignition and the emergency OFF switch, visit an authorized workshop   |
| Engine does not switch on and the neutral indicator lamp does not light up | Blown starter fuse   | Replace the fuse (3)  |
|  | Blown main fuse  | Remove the seat and replace the main fuse (1); if it blows again, visit an authorized workshop  |
|  | Battery is dead  | Charge the battery and determine the cause of discharging; visit an authorized workshop   |
| Engine only starts if the clutch lever is pulled                           | Defective back-up starter system   | Visit an authorized workshop  |
| Engine cranks with gear engaged  | Defective back-up starter system   | Visit an authorized workshop  |
| Engine switches on but does not start                                      | Operating error  | Open the fuel tap or auxiliary fuel tap, refuel, do not actuate the choke, follow start-up instructions (see driving instructions)  |
|  | Motorcycle was not operated for a longer period of time, old fuel in the float chamber | The highly inflammable constituents in the new fuel volatilize if left standing over longer periods of time.<br>If the motorcycle was not used for over 1 week, drain the old fuel from the float chamber. The engine will start immediately after the float chamber is filled with fresh ignitable fuel. |
|  | Fuel supply is interrupted   | Disconnect the fuel hose from the carburetor, place the end in a vessel and open the fuel tap,<br>– if fuel leaks out, clean the carburetor<br>– if no fuel leaks out, check whether the tank ventilation is clogged and clean the fuel tap   |
|  | Defective fuel pump  | Disconnect the fuel hose from the carburetor, place the end in a vessel, open the fuel tap and start,<br>– if fuel leaks out, clean the carburetor<br>– if no fuel leaks out,<br>- check the vacuum pipe from the cylinder head to the fuel pump for leaks<br>- visit an authorized workshop              |
|  | Engine is flooded  | Open the throttle completely when you start or replace the spark plug   |
|  | Spark plug is sooted or wet  | Clean and dry or replace the spark plug   |
| Electrode distance is too large  | Set the electrode distance to 0.9 mm   |   |

# TROUBLE SHOOTING »

| TROUBLE                               | CAUSE  | REMEDY   |
|---------------------------------------|--|--|
| Engine switches on but does not start | Spark plug connector or spark plug is defective  | Remove the spark plug, connect the ignition wire, apply the spark plug to the ground (bright area on the engine) and start; a strong spark should be visible at the spark plug <ul style="list-style-type: none"> <li>– if no spark is visible, replace the spark plug</li> <li>– if no spark is visible yet, disconnect the spark plug cap from the ignition wire, hold approx. 5 mm away from the ground and start</li> <li>– if a spark is visible now, replace the spark plug connector</li> <li>– if no spark is visible, have the ignition system checked</li> </ul> |
|                                       | Socket connector on CDI unit, pulse generator or ignition coil oxidizes                | Remove the seat, right side cover and fuel tank, clean the socket connectors and treat with contact spray  |
|                                       | Water in the carburetor or jets clogged  | Remove and clean the carburetor  |
|                                       | Carburetor not correctly connected to intake flange                                    | Mount the carburetor correctly   |
| Engine does not idle                  | Idling jet is clogged  | Disassemble the carburetor and clean the jets  |
|                                       | Adjusting screws on the carburetor are turned in the wrong position                    | Have the carburetor adjusted   |
|                                       | Spark plug is defective  | Replace the spark plug   |
|                                       | Ignition system is defective   | Have the ignition system checked   |
| Engine does not rev up                | Fuel level is too high in the carburetor   | Disassemble the carburetor, clean and check for wear   |
|                                       | Float needle valve leaks   | Replace the float needle valve   |
|                                       | Float leaks  | Replace the float  |
|                                       | Choke cable has no clearance, causing the cold-start system to be constantly activated | Adjust the choke cable   |
|                                       | Throttle slide diaphragm is defective  | Replace the diaphragm  |
|                                       | Leaks in the carburetor  | Check the vacuum hoses and vent hoses on the carburetor for a tight fit and kink-free installation   |
|                                       | Loose carburetor jets  | Tighten the jets   |
|                                       | Defective electronic ignition advance  | Have the ignition system checked   |
| Engine does not have enough power     | The fuel supply is partly interrupted or the carburetor soiled                         | Clean and check the fuel system and the carburetor; have the fuel pump checked   |
|                                       | Float leaks  | Replace the float  |
|                                       | Diaphragm on the throttle slide is defective   | Replace the diaphragm  |
|                                       | Carburetor leaks   | Check the vacuum hoses and vent hoses on the carburetor for a tight fit and kink-free installation   |
|                                       | Air filter is heavily soiled   | Clean or replace the air filter, visit an authorized workshop  |
|                                       | Valve clearance is too small   | Have the valve clearance adjusted  |
|                                       | Compression loss due to incorrect adjustment of hand decompression lever               | Adjust the hand decompression cable  |
|                                       | Electronic ignition advance is defective   | Have the ignition system checked   |

# TROUBLE SHOOTING »

| TROUBLE   | CAUSE   | REMEDY  |
|---|---|---|
| Engine gets too hot   | <p>Not enough cooling liquid in the cooling system</p> <p>Radiator fins are heavily soiled</p> <p>Foam has formed in the cooling system</p> <p>Bent radiator hose</p> <p>Defective thermostat</p> <p>Fan fuse has blown</p> <p>Defective thermostwitch</p> <p>Defective fan</p> | <p>Add cooling liquid (see maintenance work), check the cooling system for leaks</p> <p>Clean the radiator fins with a water jet</p> <p>Replace the cooling liquid, use a brand-name antifreeze</p> <p>Shorten or replace the radiator hose</p> <p>Remove the thermostat and have it checked or replaced (opening temperature 70°C); visit an authorized workshop</p> <p>Replace the fuse (4) and check the fan for proper functioning (see below)</p> <p>Visit an authorized workshop</p> <p>Check the fan for proper functioning. To check, start the engine and short-circuit the connections on the thermostwitch (lower right fan); visit an authorized workshop</p> |
| High oil consumption  | <p>Bent transmission vent hose</p> <p>Engine oil level is too high</p> <p>Engine oil is too thin (viscosity)</p>  | <p>Run the vent hose without kinks or replace</p> <p>Check the oil level with the engine at operating temperature and correct if necessary.</p> <p>Use a thicker engine oil. See the "Engine Oil" chapter</p>   |
| Electrical system does not work                             | <p>Main fuse has blown</p> <p>Battery is dead</p>   | <p>Remove the seat and replace the main fuse. If it blows again, visit an authorized workshop</p> <p>Charge the battery and determine the cause for discharging; visit an authorized workshop</p>   |
| Headlight and parking light do not light up                 | Blown fuse  | Replace the fuse (5)  |
| Turn signal, brake light, fan and horn do not work          | Blown fuse  | Replace the fuse (4)  |
| Neutral indicator lamp does not light up in neutral         | <p>Defective neutral switch</p> <p>Loose terminals, defective cable</p>   | <p>Apply the cable to the ground; if the indicator lamp lights up, replace the neutral switch</p> <p>Check connections and cables</p>   |
| Battery is dead   | <p>Ignition (power consumers) not switched off</p> <p>Battery is not being charged by the generator</p>   | <p>Charge the battery</p> <p>Remove the seat and check the voltage regulator cables; have the voltage regulator and the generator checked at an authorized workshop</p>   |
| No multifunctional digital speedometer display              | Main fuse has blown   | Replace the main fuse (1) under the seat  |
| No speed display on the multifunctional digital speedometer | Pickup cable is damaged or the socket connector has oxidized  | <p>Check the pickup cable for damage and replace if necessary</p> <p>Remove the headlight mask and check the socket connector.</p> <p>Visit an authorized workshop</p>  |

## CLEANING »

Clean your motorcycle regularly in order to maintain the beauty of its plastic surfaces. The best manner would be to use warm water that has been mixed with a normal trade washing detergent and a sponge. The hard dirt can be removed before with the help of a soft water jet.

### ! CAUTION

NEVER CLEAN YOUR MOTORCYCLE WITH A HIGH-PRESSURED CLEANER OR A HIGH-PRESSURED WATER JET. THE WATER COULD OTHERWISE RUN INTO THE ELECTRICAL COMPONENTS, CONNECTORS, SHEATHED CABLES, BEARINGS, CARBURETOR ETC. AND CAUSE DISTURBINGS OR LEAD TO A PREMATURE DESTRUCTION OF THESE PARTS.

- You should use normal trade-mark detergents to clean the engine. Strongly dirtied parts should be cleaned additionally with the help of a paint brush.
- Before cleaning with water, plug the exhaust pipe to prevent water ingress
- After the motorcycle has been rinsed with a soft water jet, it should be dried by air pressure and a cloth. Then take a short drive until the engine has reached the working temperature and also use the brakes. Due to the heat, the water also evaporates at the unapproachable parts of the engine and the brakes.
- Slide back the protective covers on the handlebar-mounted instruments so that any water that may have seeped into this part of the motorcycle is allowed to evaporate.
- After the motorcycle has cooled down, oil and grease all sliding and pivot points. Treat the chain with a chain spray too.
- To prevent failures in the electric system, you should treat the ignition lock, the emergency OFF switch, light switch and the socket connectors with contact spray.

## CONSERVATION FOR WINTER OPERATION »

In the event that the motorcycle is also used in winter and on roads where one has to expect salt spraying, you will have to take precautions against the aggressive road salt.

- Thoroughly clean and let the motorcycle dry after every ride.
- Treat engine, carburetor, swing arm, and all other bare or galvanized parts (except for brake discs) with a wax-based anti-corrosion agent.

### ⚠ WARNING

KEEP ANTI-CORROSION AGENT FROM GETTING INTO CONTACT WITH THE BRAKE DISCS, FOR OTHERWISE THIS WILL SIGNIFICANTLY REDUCE THE BRAKING POWER.

### ! CAUTION

AFTER RIDES ON SALTED ROADS, CLEAN MOTORCYCLE THOROUGHLY WITH COLD WATER AND LET IT DRY WELL!

## STORAGE »

Should you desire to make a pause over a longer space of time, please observe the following instructions:

- Clean motorcycle thoroughly (see chapter: CLEANING)
- Change engine oil, oil filter and fine screen filter (old engine oil contains aggressive contaminations).
- Check antifreezer and amount of cooling liquid.
- Let the engine warm up again, close fuel tap and wait until the engine dies off by itself. By this means, carburetor jets are prevented from becoming resinous by the old fuel.
- Remove spark plug and fill in approx. 5 ccm of engine oil into the cylinder through the opening. Actuate kick-starter 10 times in order to distribute the oil onto the cylinder walls and mount the spark plug.
- Set piston to compression so that the valves will be closed (slowly operate the kickstarter, until you can hear the automatic decompressor click (release))
- Let fuel flow out of tank into an appropriate container.
- Correct tire pressure.
- Lubricate pivot points of the control levers, foot rests, etc. as well as the chain.
- Service the shock absorber linkage
- Disassemble and charge battery (see chapter: BATTERY).
- The storage place should be dry and not subject to excessive temperature fluctuations.
- Cover the motorcycle with an air permeated tarpaulin or blanket. Do not use non air permeable materials as a possible humidity might not be able to escape and could cause corrosion.

### ! CAUTION

IT WOULD BE VERY BAD TO LET THE ENGINE RUN FOR A SHORT TIME DURING THE STORAGE PERIOD. THE ENGINE WOULD NOT GET WARMED UP ENOUGH AND THE THUS DEVELOPED STEAM WOULD CONDENSE DURING THE COMBUSTION PROCESS AND CAUSE THE VALVES AND EXHAUST TO RUST.

### RE-INITIATION AFTER TIME OF STORAGE

- Mount the charged battery (regard polarity) and adjust the clock.
- Fill up tank with fresh fuel.
- Check motorcycle as before each start (see driving instructions)
- Take a short, careful test ride first.

NOTE: Before you put your motorcycle away for the winter, you have to check all parts for their function and wear. Should any service jobs, repairs, or any refitting be necessary, you should have them carried out during the off-season (lower workload at mechanics shops). This way, you can avoid the long waiting times at your mechanic at the beginning of the next biking season.





# TECHNICAL SPECIFICATIONS – ENGINE »

| ENGINE                 | 640 LC4 ADVENTURE  |
|------------------------|--|
| Design                 | Liquid-cooled single cylinder 4-stroke engine with balancer shaft and electric starter |
| Displacement           | 625 ccm  |
| Bore / Stroke          | 101 / 78 mm  |
| Ratio                  | 11.7 : 1   |
| Fuel                   | unleaded premium gasoline with a least RON 95  |
| Valve timing           | 4 valves over rocker arm and 1 overhead camshaft, camshaft drive through single chain  |
| Camshaft               | 249/1  |
| Valve diameter         | Intake: 36 mm    Exhaust: 32 mm  |
| Valve clearance cold   | 0.12 mm - 0.15 mm  |
| Crank shaft bearing    | 2 cylinder roller bearing  |
| Connecting rod bearing | needle bearing   |
| Top end bearing        | bronze bushing   |
| Piston                 | forged/cast aluminium alloy  |
| Piston rings           | 1 compression ring, 1 taper face ring, 1 oil scraper ring                              |
| Engine lubrication     | 2 Eaton-Oilpumps   |
| Engine oil             | see table #  |
| Quantity of engine oil | 2.1 liters including frame   |
| Primary ratio          | straight geared spur wheels 31 : 79 teeth  |
| Clutch                 | multi disc clutch in oil bath, hydraulically operated                                  |
| Transmission           | 5-speed claw shifted   |
| Ignition system        | contactless DC- CDI ignition with digital advanced system type KOKUSAN                 |
| Ignition timing        | adjustment to max. 38° BTDC at 6000 rpm  |
| Generator              | 12V 200W   |
| Spark plug             | NGK DCPR 8 E   |
| Spark plug gap         | 0.9 mm   |
| Cooling system         | liquid cooled, permanent rotation of cooling liquid through mechanic driven water pump |
| Cooling liquid         | 1 liter, 50% antifreeze, 50% distilled water, at least -25 ° C (-13 ° F)               |
| Starting equipment     | electric starter, kick starter   |

| BASIC CARBURETOR SETTING |                   |
|--------------------------|-------------------|
|                          | 640 LC4 ADVENTURE |
| Type                     | BST40-266         |
| Main jet                 | 152,5             |
| Needle jet               | X-6 689           |
| Idling jet               | 45                |
| Jet needle               | 6G5               |
| Needle clip position     | 3rd from top      |
| Mixt. adj. screw open    | 2.25              |

| GEAR RATIOS   |              |                            |  |  |
|---------------|--------------|----------------------------|--|--|
| Primary ratio | Transmission | Original final drive ratio | Available chain drive sprockets for chain 5/8x1/4" | Available final drive sprockets for chain 5/8x1/4" |
| 31:79         | 1.Gang 14:35 | 16:42                      | 14 t<br>15 t<br>16 t<br>17 t                       | 38 t   |
|               | 2.Gang 15:24 |                            |  | 40 t   |
|               | 3.Gang 18:21 |                            |  | 42 t   |
|               | 4.Gang 20:19 |                            |  | 45 t   |
|               | 5.Gang 22:18 |                            |  | 48 t<br>50 t<br>52 t                               |

#

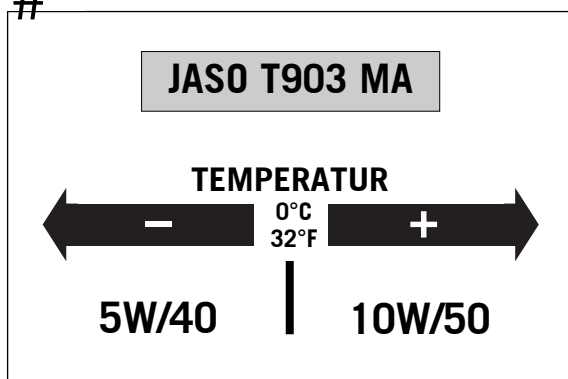

## Engine oil

Only use fully synthetic engine oils that meet the JASO MA quality requirements (see information on the can).  
KTM recommends Motorex Power Synt 4T in the 10W/50 viscosity (for temperatures over 0°C, 32°F) or 5W/40 (for temperatures under 0°C, 32°F).

## TECHNICAL SPECIFICATIONS – ENGINE »

| TIGHTENING TORQUES – ENGINE 640 LC4 ADVENTURE |                               |                      |
|---|-------------------------------|----------------------|
| Hexagon nut at primary gear                   | M20x1.5                       | Loctite 243 + 170 Nm |
| Collar nut flywheel                           | M16x1.25 left                 | 80° C + 150 Nm       |
| Hexagon nut for inner clutch hub              | M18x1.5                       | Loctite 243 + 90 Nm  |
| Kickstarter stop screw                        | M12x1.5                       | 50 Nm                |
| Allan head screw freewheel hub                | M6x12/M6x12.5                 | Loctite 648 + 12 Nm  |
| Allan head screw oil pumps                    | M6                            | Loctite 243 + 8 Nm   |
| Hexagon screw camshaft gear                   | M10                           | Loctite 243 + 35 Nm  |
| Allan head screw cylinder head top sect.      | M6x25/M6x35/M6x65/M6x70 (8.8) | 10 Nm                |
| Allan head screw cylinder head top sect.      | M6x50/M6x55 (12.9)            | 15 Nm                |
| Cylinder head screws                          | M10                           | 53 Nm                |
| Collar nuts at cylinder base                  | M10                           | 50 Nm                |
| Hexagon nut chain sprocket                    | M20x1.5                       | Loctite 243 + 60 Nm  |
| Oil drain plug                                | M22x1.5                       | 30 Nm                |
| Magnetic plug                                 | M12x1.5                       | 20 Nm                |
| Plug bypass valve                             | M12x1.5                       | 20 Nm                |
| Hollow screws oil lines                       | M8x1                          | 10 Nm                |
| Hollow screws oil lines                       | M10x1                         | 15 Nm                |
| Jet screw clutch cover                        | M8                            | 10 Nm                |
| Screw plug timing-chain tensioner             | M12x1.5                       | 20 Nm                |
| Counternuts valve adjusting screws            | M7x0.75                       | 16 Nm                |
| Crankshaft locking bolt                       | M8                            | 20 Nm                |
| Spark plug                                    | M12x1.25                      | 20 Nm                |
| Engine mounting bolt                          | M8                            | 40 Nm                |
| Engine mounting bolt                          | M10                           | 70 Nm                |

# TECHNICAL SPECIFICATIONS – CHASSIS »

| CHASSIS                          | 640 LC4 ADVENTURE  |
|----------------------------------|--|
| Frame                            | Central chrome-moly-steel frame  |
| Fork                             | WP Suspension Up Side Down MXMA 4860   |
| Wheel travel front/rear          | 275/300 mm (10.5/12 in)  |
| Rear suspension                  | Central shock absorber (WP Suspension BAVP4681) with PRO-LEVER linkage to rear-swingarm with needle bearing  |
| Front brake                      | Disc brake, 2 perforated brake discs Ø 300 mm (11.8 in), brake caliper floated   |
| Rear brake                       | Disc brake, perforated brake disc Ø 220 mm (8.7 in), brake caliper floated   |
| Tyres front                      | 90/90-21 Enduro 3  |
| Air press. road, driver only     | 1.8 bar (21 psi)   |
| Air press. road, with passenger  | 2.0 bar (29 psi)   |
| Tyres rear                       | 140/80-18 Enduro 3   |
| Air press. road, driver only     | 2.0 bar (29 psi)   |
| Air press. road, with passenger  | 2.2 bar (32 psi)   |
| Fuel tank capacity               | 25.5 liter (6.7 US gallons) of that 3.5 liter (0.9 US gallons) reserve   |
| Final drive ratio                | 16 : 42  |
| Chain                            | 5/8 x 1/4" X-Ring  |
| Lampenbestückung                 | head light . . . . .H1 12V 55W (socket P14.5S)<br>parking light . . . . .12V 2W (socket Ba9s)<br>brake- rear light . . . . .12V 21/5W (socket BaY15d)<br>flasher light . . . . .12V 10W (socket Ba15s)<br>license plate illintion . . . . .12V 5W (socket W2.1x9.5d) |
| Battery                          | 12V 8.6 Ah   |
| Steering angle                   | 62.5°  |
| Wheel base                       | 1510 ± 10 mm (59.4 ± 0.4 in)   |
| Seat high                        | 945 mm (37.2 in)   |
| Ground clearance                 | 315 mm (12.4 in)   |
| Dead weight without fuel         | 158 kg (340 lbs)   |
| Max. permissible front axle load | 150 kg (331 lbs)   |
| Max. permissible rear axle load  | 230 kg (507 lbs)   |
| Max. permissible laden weight    | 380 kg (839 lbs)   |

| STANDARD ADJUSTMENT – FORK |                       |
|----------------------------|-----------------------|
| 640 LC4 ADVENTURE          | WP 4860 MXMA 14187B26 |
| Compression adjuster       | 16                    |
| Rebound adjuster           | 12                    |
| Spring                     | 4.6 N/mm              |
| Spring preload             | 4 mm                  |
| Air chamber length         | 120 mm                |
| Fork oil                   | SAE 5                 |

| STANDARD-ADJUSTMENT – SHOCK ABSORBER |                       |
|--------------------------------------|-----------------------|
| 640 LC4 ADVENTURE                    | WP BAVP 4681 01187B04 |
| Compression adjuster                 | 6                     |
| Rebound adjuster                     | 7                     |
| Spring                               | 70/260                |
| Spring preload                       | 27 mm                 |

## TECHNICAL SPECIFICATIONS – CHASSIS »

| TIGHTENING TORQUES – CHASSIS 640 LC4 ADVENTURE |           |                     |
|--|-----------|---------------------|
| Collar nut front axle                          | M16x1,5   | 40 Nm               |
| Collar nut rear axle                           | M20x1,5   | 80 Nm               |
| Shock absorber top/bottom                      | M10       | 45 Nm               |
| Collar screws brake disk front/rear            | M6 (10.9) | Loctite 243 + 10 Nm |
| Screw brake caliper front                      | M8        | Loctite 243 + 25 Nm |
| Bearing bolt linkage arm/frame                 | M12       | 60 Nm               |
| Collar nuts rocker arm bolts                   | M14x1,5   | 100 Nm              |
| Engine mounting screw                          | M10       | 45 Nm               |
| Sprocket screws on nuts                        | M8        | Loctite 243 + 35 Nm |
| Collar nut swingarm bolt                       | M14x1,5   | 100 Nm              |
| Clamping screws top triple clamp               | M8        | 20 Nm               |
| Clamping screws bottom triple clamp            | M8        | 15 Nm               |
| Clamping screws fork stubs                     | M8        | 15 Nm               |
| Bleeder screw oil reservoir frame              | M16x1,5   | 25 Nm               |
| Spoke nipple                                   | WS 7      | 4 Nm (3 - 6 Nm)     |
| Other screws on chassis                        | M6        | 10 Nm               |
|  | M8        | 25 Nm               |
|  | M10       | 45 Nm               |
| Other collar nuts an chassis                   | M6        | 15 Nm               |
|  | M8        | 30 Nm               |
|  | M10       | 50 Nm               |

|   | Page |  | Page     |
|---|------|--|----------|
| Activating the ignition curve for low-octane fuel . . . . .       | 19   | Filler cap . . . . .   | 10       |
| Adjust idling speed . . . . .                                     | 39   | Foot brake pedal . . . . .   | 11       |
| Adjusting of free travel at the hand brake lever . . . . .        | 28   | Footrests . . . . .  | 13       |
| Adjusting the throttle cable . . . . .                            | 38   | Fuel taps . . . . .  | 10       |
| Baggage carrier / Grips . . . . .                                 | 13   | Fuses . . . . .  | 34       |
| Battery . . . . .   | 33   | General informations about KTM disc brakes . . . . .                 | 27       |
| Bleeder screw front fork . . . . .                                | 23   | General tips and warnings for starting the motorcycle . . . . .      | 14       |
| Braking . . . . .   | 18   | Hand brake lever . . . . .   | 6        |
| Chain maintenance . . . . .                                       | 26   | Hand decompression lever . . . . .                                   | 5        |
| Chain wear . . . . .  | 26   | Ignition lock . . . . .  | 6        |
| Changing oil filter . . . . .                                     | 42   | Indicator lamps . . . . .  | 9        |
| Changing the basic position of the brake pedal . . . . .          | 29   | Instructions for initial operation . . . . .                         | 14       |
| Changing the original position of the clutch lever . . . . .      | 38   | Kickstarter . . . . .  | 11       |
| Changing the spring preload of the shock absorber . . . . .       | 24   | Lubricating the shock absorber linkage . . . . .                     | 24       |
| Changing the wheel size . . . . .                                 | 32   | Maintenance work on chassis and engine . . . . .                     | 22       |
| Charging the battery . . . . .                                    | 33   | Multi-functional digital speedometer . . . . .                       | 7        |
| Chassis number . . . . .  | 5    | Oil and screen filter change, bleeding of the oil system . . . . .   | 41       |
| Check the following before each start . . . . .                   | 15   | Oil circuit . . . . .  | 41       |
| Checking and adjusting steering head bearing . . . . .            | 23   | Operation instruments . . . . .                                      | 5        |
| Checking and adjusting the choke cable play . . . . .             | 39   | Periodic maintenance schedule . . . . .                              | 20       |
| Checking chain tension . . . . .                                  | 25   | Re-initiation after time of storage . . . . .                        | 46       |
| Checking of brake fluid level - front brake . . . . .             | 28   | Rebound damping of fork . . . . .                                    | 12       |
| Checking rear brake fluid level . . . . .                         | 29   | Rebound damping of shock absorber . . . . .                          | 12       |
| Checking rubber ring on the WP rear shock absorber . . . . .      | 24   | Refilling the front brake fluid reservoir . . . . .                  | 28       |
| Checking spoke tension . . . . .                                  | 32   | Refilling the rear brake fluid reservoir . . . . .                   | 29       |
| Checking the adjustment of the hand decompression cable . . . . . | 39   | Refueling . . . . .  | 19       |
| Checking the cooling liquid level . . . . .                       | 36   | Removing and mounting the headlight mask . . . . .                   | 34       |
| Checking the engine oil level . . . . .                           | 40   | Removing the seat . . . . .  | 22       |
| Checking the front brake pads . . . . .                           | 28   | Removing the tank . . . . .  | 35       |
| Checking the oil level of the hydraulic clutch . . . . .          | 38   | Replacing the headlight bulb . . . . .                               | 34       |
| Checking the rear brake pads . . . . .                            | 29   | Running in . . . . .   | 14       |
| Checking the shock absorption rubbers in the rear hub . . . . .   | 31   | Serial number locations . . . . .                                    | 5        |
| Choke lever . . . . .   | 6    | Setting options in the display . . . . .                             | 8        |
| CLEANING . . . . .  | 46   | Shift lever . . . . .  | 11       |
| Cleaning the air filter . . . . .                                 | 37   | Shifting/Riding . . . . .  | 17       |
| Cleaning the dust sleeves of the telescopic fork . . . . .        | 23   | Socket for electric accessories . . . . .                            | 6        |
| Clutch lever . . . . .  | 5    | Starter tip switch, emergency OFF tip switch, light switch . . . . . | 10       |
| Combination switch . . . . .                                      | 10   | Starting off . . . . .   | 17       |
| Compression damping of fork . . . . .                             | 12   | Starting the engine with the kickstarter . . . . .                   | 17       |
| Compression damping of shock absorber . . . . .                   | 12   | Starting when the engine is cold . . . . .                           | 16       |
| Conservation for winter operation . . . . .                       | 46   | Starting when the engine is warm or hot . . . . .                    | 17       |
| Cooling liquid temperature display . . . . .                      | 9    | Stopping and parking . . . . .                                       | 18       |
| Cooling system . . . . .  | 36   | Storage . . . . .  | 46       |
| Correct chain tension . . . . .                                   | 25   | Tachometer . . . . .   | 9        |
| Dismounting and mounting the front wheel . . . . .                | 30   | Technical specifications – chassis . . . . .                         | 50       |
| Dismounting and mounting the rear wheel . . . . .                 | 31   | Technical specifications – engine . . . . .                          | 48       |
| Display . . . . .   | 7    | Tires, air pressure . . . . .  | 32       |
| Draining of float chamber of the carburetor . . . . .             | 40   | Tool set . . . . .   | 22       |
| Driving instructions . . . . .                                    | 15   | Trouble shooting . . . . .   | 43       |
| Engine number, engine type . . . . .                              | 5    | What to do when the engine is „flooded“ . . . . .                    | 17       |
| Engine oil . . . . .  | 40   | Wiring diagram . . . . .   | appendix |
| Exchanging the brake light and tail light bulb . . . . .          | 35   |  |          |

# SCHALTPLAN » WIRING DIAGRAM

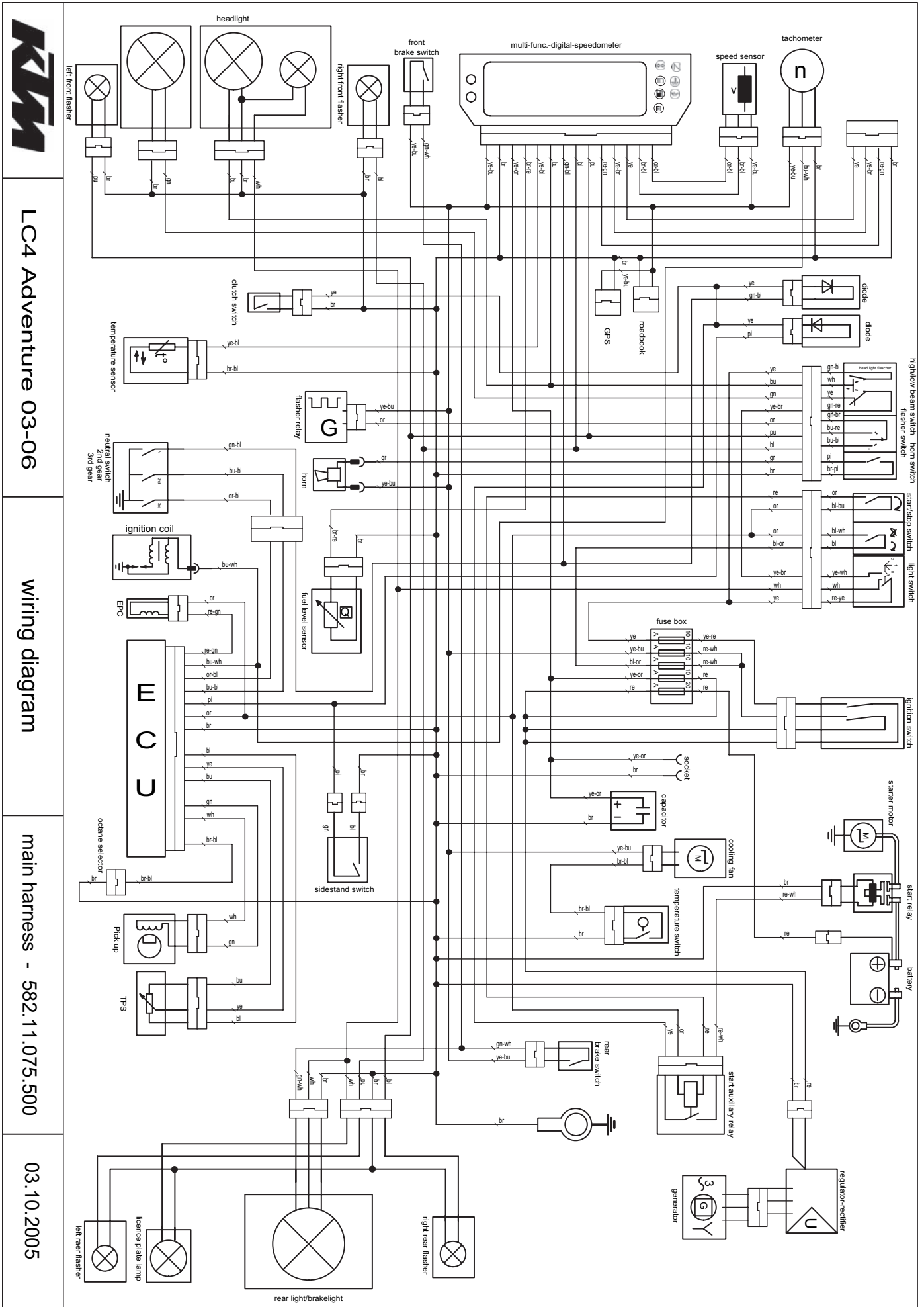

LC4 Adventure 03-06

wiring diagram

main harness - 582.11.075.500

03.10.2005

ignition switch

|  |     |     |     |   |     |     |
|--|-----|-----|-----|---|-----|-----|
|  | r-w | r-w | r-w | o | y-r | r-w |
| ON  |     | ●   | ●   |   | ●   | ●   |
| OFF  |     |     |     |   |     |     |
| LOCKED   |     |     |     |   |     |     |



brake switch

|  |       |       |
|--|-------|-------|
| cable harness  | gn-wh | ye-bu |
| cable switch   | bl    | bl    |
| pushed  | ●     | ●     |
| unpushed   |       |       |

sidestand switch

|   |    |    |
|---|----|----|
| cable harness   | br | pi |
| cable switch  | bl | bl |
| folded up  | ●  | ●  |
| folded down   |    |    |

high/low beam switch

|  |    |    |       |
|--|----|----|-------|
| cable harness  | bu | gn | ye-br |
| cable switch   | wh | ye | gn-re |
| LO    |    | ●  | ●     |
| HI  | ●  | ●  |       |



clutch switch

|  |    |    |
|--|----|----|
| switch position  | ye | br |
| pulled  | ●  | ●  |
| unpulled   |    |    |

horn switch

|   |    |       |
|---|----|-------|
| cable harness   | gr | br    |
| cable switch  | pi | br-pi |
| HORN  | ●  | ●     |
| OFF   |    |       |



flasher switch

|  |       |       |       |    |       |
|--|-------|-------|-------|----|-------|
| cable harness  | or    | pu    | bl    | gr | br    |
| cable switch   | gn-br | bu-re | bu-bl | pi | br-pi |
| TURN L  | ●     | ●     |       |    |       |
| TURN R  | ●     | ●     |       |    |       |
| OFF  |       |       |       |    |       |

passing light

|  |       |    |
|--|-------|----|
| cable harness  | ye    | bu |
| cable switch   | gn-bl | wh |
| P. HORN  | ●     | ●  |
| OFF  |       |    |

light switch

|  |       |    |       |
|--|-------|----|-------|
| cable harness  | ye-br | wh | ye    |
| cable switch   | ye-wh | wh | re-ye |
| LIGHT OFF  |       |    |       |
| P. LIGHT  | ●     | ●  |       |
| LIGHT     | ●     | ●  |       |

kill switch

|   |    |       |
|---|----|-------|
| cable harness   | re | or    |
| cable switch  | or | bl-wh |
| RUN  | ●  | ●     |
| STOP  |    |       |

start switch

|   |       |       |
|---|-------|-------|
| cable harness   | or    | bl-or |
| cable switch  | bl-bu | bl    |
| START  | ●     | ●     |
| unpushed  |       |       |

# SCHALTPLAN » WIRING DIAGRAM

| ENGLISH                                   | DEUTSCH                                | ITALIANO  |
|---|--|---|
| Additional instruments (roadbook;GPS;...) | Externe Instrumente                    | Strumenti supplementari                           |
| Battery                                   | Batterie                               | Batteria  |
| Clutch switch                             | Kupplungsschalter                      | Interruttore frizione                             |
| Cooling fan                               | Lüftermotor                            | Motorino ventola                                  |
| Diode                                     | Diode                                  | Diodo   |
| Electronic Power Control (EPS)            | Electronic Power Control (EPS)         | Electronic Power Control (EPS)                    |
| Flasher relay                             | Blinkerrelais                          | Relè indicatori                                   |
| Flasher switch                            | Blinkerschalter                        | Deviatore indicatori di direzione                 |
| Front brake switch                        | vorderer Bremslichtschalter            | Interruttore luce ant. di stop                    |
| Fuel level sensor                         | Benzinstandgeber                       | Sensore livello benzina                           |
| Fuse box                                  | Sicherungskasten                       | Scatola fusibili                                  |
| Gear sensor                               | Gangerkennung                          | Sensore marce                                     |
| Generator                                 | Generator                              | Generatore  |
| Headlight                                 | Scheinwerfer                           | Faro anteriore                                    |
| High / low beam switch                    | Auf-Abblendschalter                    | Commutatore abbagliante/anabbagliante             |
| Horn                                      | Hupe                                   | Avvisatore acustico                               |
| Horn switch                               | Hornschalte                            | Interruttore avvisatore acustico                  |
| Ignition coil                             | Zündspule                              | Bobina d'accensione                               |
| Ignition switch                           | Zündschloss                            | Interruttore d'accensione                         |
| Left front flasher                        | linker vorderer Blinker                | Indicatore ant. sx                                |
| Left rear flasher                         | linker hinterer Blinker                | Indicatore post. sx                               |
| Licence plate lamp                        | Kennzeichenbeleuchtung                 | Luce targa  |
| Light switch                              | Lichtschalter                          | Deviatore luci                                    |
| Multi-func.-digital-speedometer           | Multifunktionsdigitaltacho             | Tachimetro digitale multifunzione                 |
| Neutral switch                            | Leerlaufschalter                       | Interruttore folle                                |
| Octane selector                           | Oktanangepassung                       | Adattamento anticipo agli ottano                  |
| Pick up                                   | Impulsgeber                            | Pick up   |
| Rear brake switch                         | hinterer Bremslichtschalter            | Interruttore luce post. di stop                   |
| Rear light / brakelight                   | hinteres Begrenzungslicht / Bremslicht | Luce post. di posizione/stop                      |
| Regulator-rectifier                       | Regelgleichrichter                     | Regolatore-raddrizzatore                          |
| Right front flasher                       | rechter vorderer Blinker               | Indicatore ant. dx                                |
| Right rear flasher                        | Rechter hinterer Blinker               | Indicatore post. dx                               |
| Sidestand switch                          | Seitenständerschalter                  | Interruttore cavalletto lat.                      |
| Speed sensor                              | Geschwindigkeitssensor                 | Sensore velocità                                  |
| Start auxillary relay                     | Starterhilfsrelais                     | Relè ausiliario d'avviamento                      |
| Start relay                               | Startrelais                            | Relè d'avviamento                                 |
| Start/stop switch                         | Start / stop schalter                  | Interruttore combinato d'avviamento e d'emergenza |
| Starter motor                             | Startermotor                           | Motorino d'avviamento                             |
| Tachometer                                | Drehzahlmesser                         | Contagiri   |
| Temperature sensor                        | Temperatursensor                       | Sensore temperatura                               |
| Temperature switch                        | Temperaturschalter                     | Interruttore termico                              |
| Throttle position sensor (TPS)            | Vergaserpotentiometer                  | Potenzioometro carburatore (sensore TPS)          |

| CABLE COLOURS | KABELFARBEN | CAVO COLORATO |
|---------------|-------------|---------------|
| bl: black     | bl: schwarz | bl: nero      |
| ye: yellow    | ye: gelb    | ye: giallo    |
| bu: blue      | bu: blau    | bu: blu       |
| gr: green     | gr: grün    | gr: verde     |
| re: red       | re: rot     | re: rosso     |
| wh: white     | wh: weiß    | wh: bianco    |
| br: brown     | br: braun   | br: marrone   |
| or: orange    | or: orange  | or: arancione |
| pi: pink      | pi: rosa    | pi: rosa      |
| gr: grey      | gr: grau    | gr: grigio    |
| pu: purple    | pu: violett | pu: violetto  |



# SCHALTPLAN » WIRING DIAGRAM

| ENGLISH                                    | FRANCAIS                              | ESPANOL                                     |
|--|---------------------------------------|---|
| Additional instruments (roadbook; GPS;...) | Accessoires                           | Instrumentos externos                       |
| Battery                                    | Batterie                              | Batería                                     |
| Clutch switch                              | Contacteur d'embrayage                | Interruptor de embrague                     |
| Cooling fan                                | Ventilateur                           | Motor del ventilador                        |
| Diode                                      | Diode                                 | Diodos                                      |
| Electronic Power Control (EPS)             | Electronic Power Control (EPS)        | Electronic Power Control (EPS)              |
| Flasher relay                              | Relais de clignotants                 | Relé de la luz intermitente                 |
| Flasher switch                             | Bouton de clignotants                 | Interruptor de la luz intermitente          |
| Front brake switch                         | Contacteur de frein avant             | Interruptor de luz del freno delantero      |
| Fuel level sensor                          | Jauge à essence                       | Indicador del nivel de gasolina             |
| Fuse box                                   | Boîte à fusibles                      | Caja de fusibles                            |
| Gear sensor                                | Contacteur de rapport de boîte engagé | Reconocimiento de marchas                   |
| Generator                                  | Alternateur                           | Generador                                   |
| Headlight                                  | Phare                                 | Faro  |
| High / low beam switch                     | Contacteur code/phare                 | Interruptor de encender/apagar la luz larga |
| Horn                                       | Avertisseur sonore                    | Cláxon                                      |
| Horn switch                                | Bouton d'avertisseur sonore           | Interruptor del cláxon                      |
| Ignition coil                              | Bobine d'allumage                     | Bobina de encendido                         |
| Ignition switch                            | Contacteur d'allumage                 | Cerradura de encendido                      |
| Left front flasher                         | Clignotant avant gauche               | Luz intermitente izquierda delantera        |
| Left rear flasher                          | Clignotant arrière gauche             | Luz intermitente izquierda trasera          |
| Licence plate lamp                         | Eclairage de plaque                   | Luz de la matrícula                         |
| Light switch                               | Contacteur d'éclairage                | Interruptor de luces                        |
| Multi-func.-digital-speedometer            | Ordinateur de bord                    | Velocímetro digital multifuncional          |
| Neutral switch                             | Contacteur de point mort              | Interruptor de ralentí                      |
| Octane selector                            | Sélection pour l'indice d'octane      | Ajuste de octano                            |
| Pick up                                    | Capteur d'allumage                    | Generador de impulsos                       |
| Rear brake switch                          | Contacteur de frein arrière           | Interruptor de luz del freno trasero        |
| Rear light / brakelight                    | Feu rouge/stop                        | Luces de parqueo traseras /luces de freno   |
| Regulator-rectifier                        | Régulateur/redresseur                 | Regulador rectificador                      |
| Right front flasher                        | Clignotant avant droit                | Luz intermitente derecha delantera          |
| Right rear flasher                         | Clignotant arrière droit              | Luz intermitente derecha trasera            |
| Sidestand switch                           | Contacteur de béquille latérale       | Interruptor del caballete lateral           |
| Speed sensor                               | Capteur de vitesse                    | Sensor de velocidad                         |
| Start auxillary relay                      | Relais secondaire de démarreur        | Relé auxiliaire del arranque                |
| Start relay                                | Relais de démarreur                   | Relé del arranque                           |
| Start/stop switch                          | Contacteur start/stop                 | Interruptor arranque / parada               |
| Starter motor                              | Démarreur                             | Motor de arranque eléctrico                 |
| Tachometer                                 | Compte-tours                          | Cuenta revoluciones                         |
| Temperature sensor                         | Sonde de température                  | Sensor de temperatura                       |
| Temperature switch                         | Contacteur de température             | Interruptor de temperatura                  |
| Throttle position sensor (TPS)             | Capteur d'ouverture de carburateur    | Potenciómetro del carburador                |

| CABLE COLOURS | COULEUR DE CABLE | COLOR DE CABLE |
|---------------|------------------|----------------|
| bl: black     | bl: noir         | bl: negro      |
| ye: yellow    | ye: jaune        | ye: amarillo   |
| bu: blue      | bu: bleu         | bu: azul       |
| gr: green     | gr: vert         | gr: verde      |
| re: red       | re: rouge        | re: rojo       |
| wh: white     | wh: blanc        | wh: blanco     |
| br: brown     | br: brun         | br: marron     |
| or: orange    | or: orange       | or: naranja    |
| pi: pink      | pi: rose         | pi: rosado     |
| gr: grey      | gr: gris         | gr: gris       |
| pu: purple    | pu: violet       | pu: violeta    |



09/2005 FOTO: MITTERBAUER



KTM Group Partner



**KTM-Sportmotorcycle AG**  
A-5230 Mattighofen  
[www.ktm.at](http://www.ktm.at)