



990 ADVENTURE ORANGE ABS EU 2007





SPARE PARTS MANUAL: CHASSIS

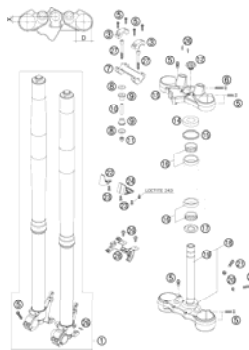
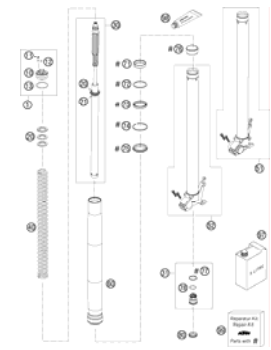
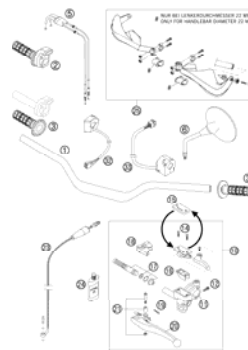
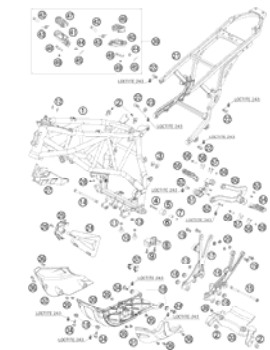
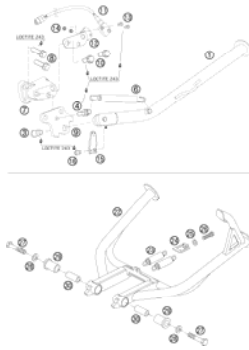
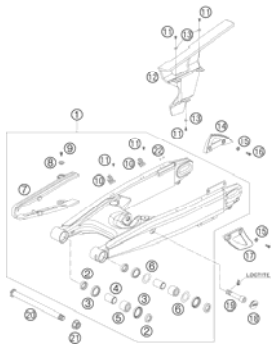
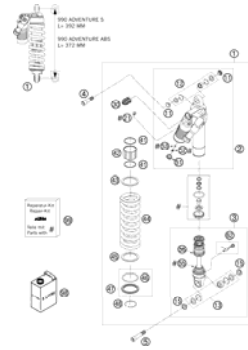
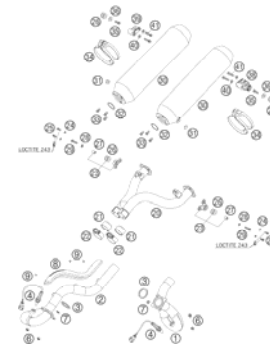
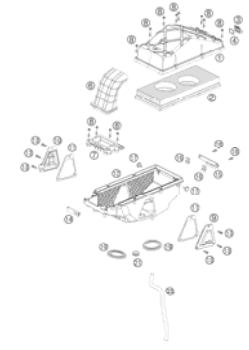

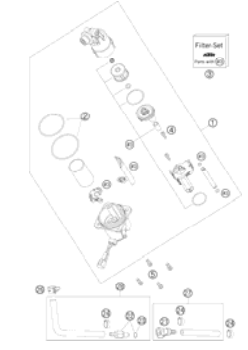
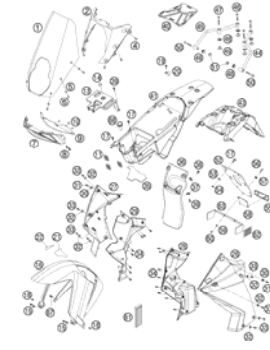
ART.NO.: 3CF9803G5EN

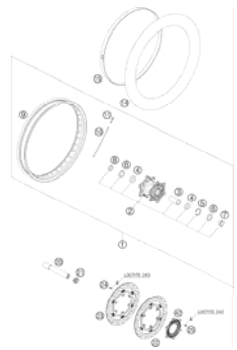
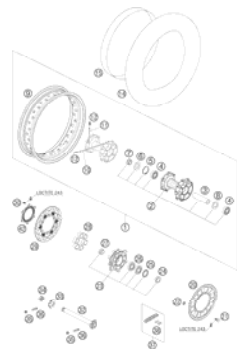
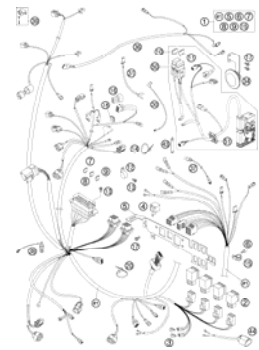
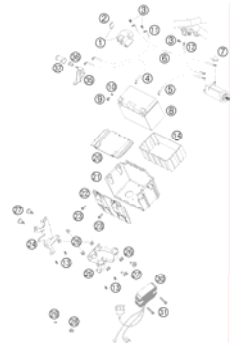
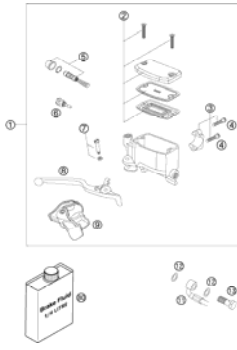
ENGLISH

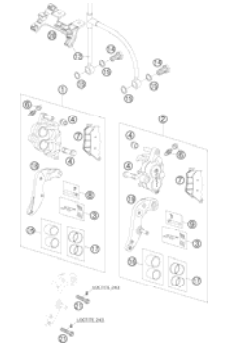
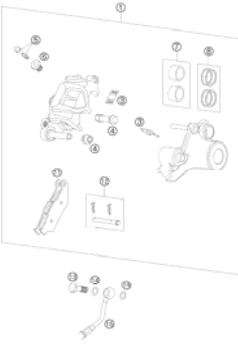
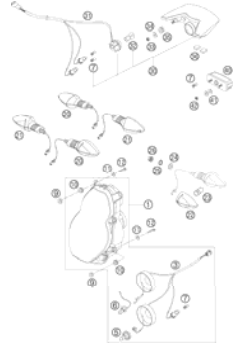

<p>TELESCOPIC FORK</p>  <p>4</p>	<p>FORK LEGS</p>  <p>5</p>	<p>HANDLEBAR, CONTROLS</p>  <p>6</p>	<p>FRAME, SUB FRAME, ENGINE GUARD</p>  <p>7</p>
<p>SIDE AND CENTER STAND</p>  <p>9</p>	<p>SWING ARM</p>  <p>10</p>	<p>MONOSHOCK</p>  <p>11</p>	<p>EXHAUST SYSTEM</p>  <p>12</p>
<p>AIR FILTER BOX</p>  <p>13</p>	<p>TANK, SEAT, COVER</p>  <p>14</p>	<p>FUEL PUMP</p>  <p>16</p>	<p>MASK, FENDERS</p>  <p>17</p>

<p>DECAL</p>  <p>19</p>	<p>FRONT WHEEL</p>  <p>20</p>	<p>REAR WHEEL</p>  <p>21</p>	<p>WIRING HARNESS</p>  <p>22</p>
<p>BATTERY BOX</p>  <p>23</p>	<p>HAND BRAKE CYLINDER</p>  <p>24</p>	<p>REAR BRAKE CONTROL</p>  <p>25</p>	<p>BRAKE CALIPER FRONT</p>  <p>26</p>
<p>BRAKE CALIPER REAR</p>  <p>27</p>	<p>LIGHTING SYSTEM</p>  <p>28</p>	<p>COCKPIT SUPPORT, SPEEDOMETER</p>  <p>29</p>	<p>SPECIAL TOOLS</p>  <p>30</p>

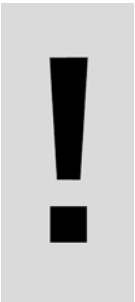
<p>ACCESSORIES</p>  <p style="text-align: right;">31</p>	<p>ANTIBLOCK SYSTEM ABS</p>  <p style="text-align: right;">32</p>		
	<div style="display: flex; align-items: center;">  <p>All information contained is without obligation. KTM-Sportmotorcycle AG particularly reserves the right to modify any equipment, technical specifications, prices, colors, shapes, materials, services, service work, constructions, equipment and the like so as to adapt them to local conditions or to cancel any of the above items, all without previous announcement and without giving reasons. KTM may stop manufacturing certain models without previous notice. KTM shall not be held liable for any deviations of availability and/or ability to deliver, illustrations, descriptions, printing and/or other errors. The illustrated models partly contain extra equipment, which is not applied to standard models. © by KTM-SPORTMOTORCYCLE AG, Mattighofen AUSTRIA; All rights reserved; Reprint, also in extracts, with written allowance of KTM-SPORTMOTORCYCLE AG, Mattighofen only.</p> </div>		

TELESCOPIC FORK

990 ADVENTURE ORANGE ABS EU 2007

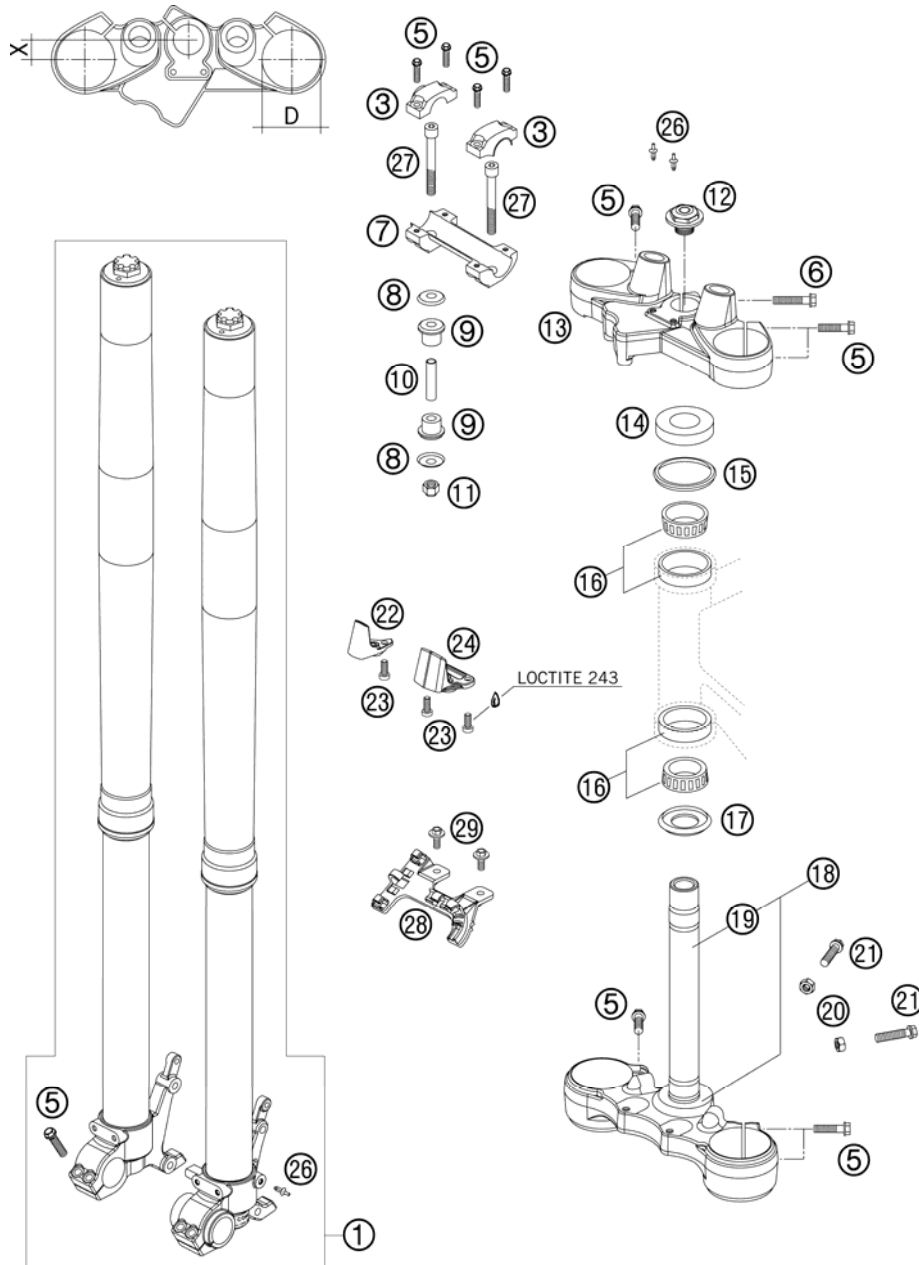

FIG	PART NUMBER	DESCRIPTION	QTY
1*	14187C24	TELESCOPIC FORK WP D48 07	1
3*	5900103830001S	HANDLEBAR CLAMP 28MM 07	2
5	0015080303	HH COLLAR SCREW M 8X30 WS=10	16
6	0015080353	HH COLLAR SCREW M 8X35 WS=10	1
7*	5900103920001S	HANDLEBAR SUPPORT 28MM 07	1
8	56401042000	WASHER 10,5X32X2	4
9	56401040000	RUBBER BUSHING	4
10	56401041100	SPACER TUBE 10,2X12X44	2
11	0982100003	SELF LOCK.NUT DIN0982-M10 HIGH	2
12	54801036200	STEER.HEAD SCREW M20x1,5 SW=27	1
13*	6000103401801S	TOP TRIPLE CLAMP X=18MM/D=54MM	1
14	54201086000	STEERING HEAD COVER	1
15	54601184000	STEERING HEAD GASKET TOP	1
16	54201081100	TAPERED ROLLER BEARING CPL. 06	2
17	54601084100	O-RING SUPPORT W. SEALING LIP	1
18*	6000103201801S	BOTTOM TRIPLE CLAMP CPL. D=60	1
19	60001033000	FORK TUBE LC8 ADV 03	1
20	0934080003	HEXAGON NUT DIN0934-M 8	2
21	0933080253	HH SCREW DIN0933-M 8X25	2
22	60101077000	BRAKE HOSE GUIDE TOP 06	1
23	0012060164	AH SCREW DIN6912 M6X16 SL	3
24	60101079000	CABLE GUIDE 06	1
26	60003088000	PLASTIC CAP FOR M6 03	4
27	0984100703	AH SCREW DIN6912-M10X70	2
28	60101078000	BRAKE HOSE GUIDE LOWER 06	1
29	0014060153	HH COLLAR SCREW M 6X15 WS=8	2

076010100 / C076010100

* NEW PART

X AS REQUIRED

FORK LEGS

990 ADVENTURE ORANGE ABS EU 2007

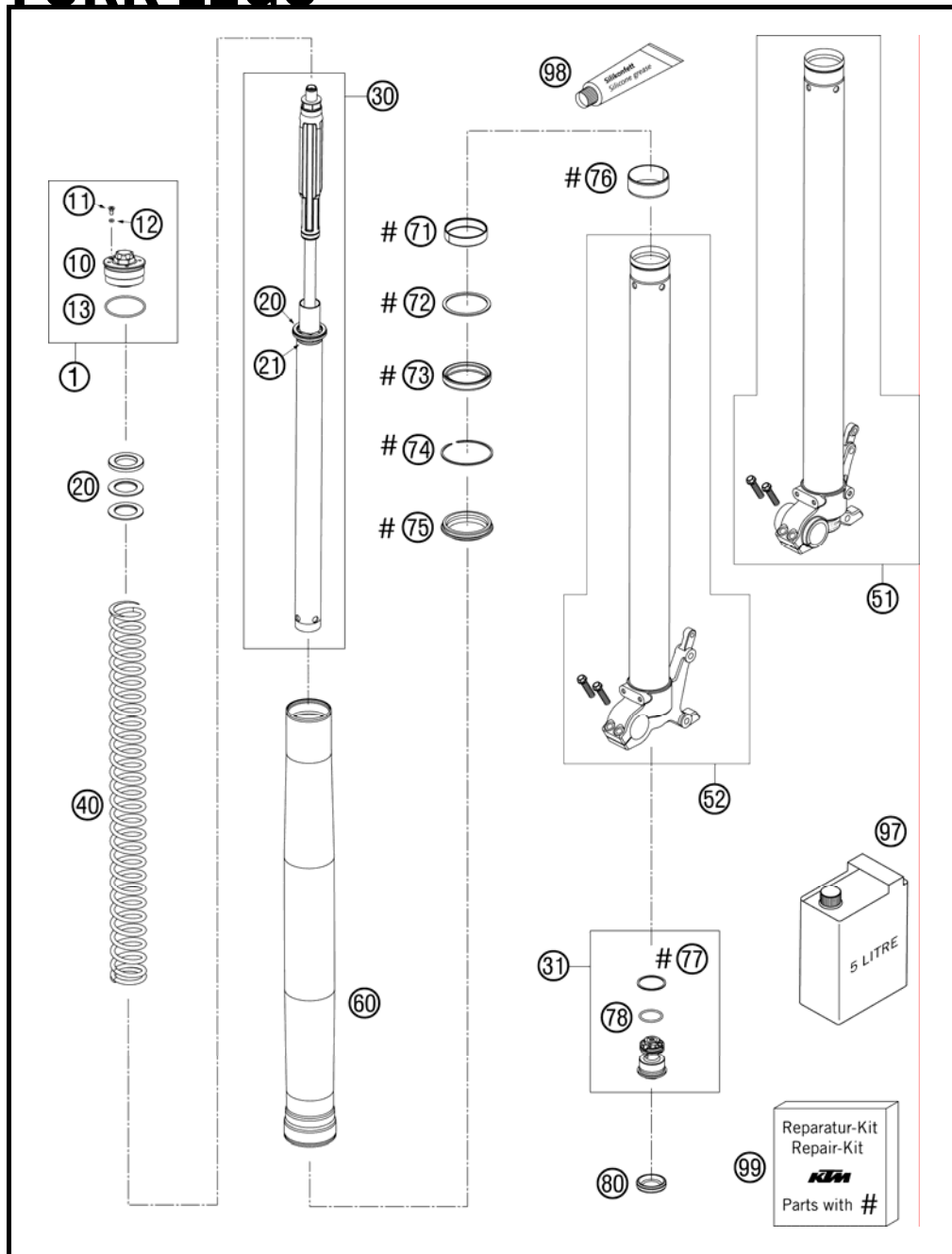

FIG	PART NUMBER	DESCRIPTION	QTY
1	48600431S	PRE-LOAD ADJ. CPL. M51X1,5 05	2
10	48600431	SCREW CAP M51X1,5 05	2
11	48600481	VENT SCREW M4X8	2
12	48600046	O-RING NBR 3X1,5	2
13	46810340	O-RING NBR 45X2	2
20	48600036	SPACER 42X26,5X2,5	2
20	48600037	SPACER 42X26,5X5	2
20	48600053	SPACER 42X26,5X1,5	2
21	48600021	INTERM. RING 26,2 X 43 X 3	2
30	48600140S	CARDRIDGE CPL. ADV ABS 07	2
31	48600586S1	TAP COMPRESSION CPL. 07	2
40	91410040S	SPRING 4,8N/MM SET D=5,25MM	2
51	48600499S1	AXLE CLAMP LEFT ADV. CPL. 07	1
52	48600500S1	AXLE CLAMP RIGHT ADV. CPL. 07	1
60	48600422E	OUTER TUBE 610/54/60DARKGREY07	2
71	48600429	DU-BUSH D48XD52X12DDL02	2
72	48600013	SUPPORT RING 50 X 57,6 X 1,5	2
73	48600399	OIL SEAL RING 48X57,8X9,5	2
74	48600070	LOCK WASHER SB58	2
75	48600400	DUST CAP D=48 58,4X11,8	2
76	48600428	DU-BUSH D47XD49X20DDL02	2
77	48600004	COPPER WASHER 29,5X33,5X1	2
78	35480320	O-RING NBR 24X2	2
80	48600141	RUBBER CAP D=35MM	2
97	48600401S1	FORK OIL SAE 5 2005	1
98	T511	SILICONE GREASE F. DUST STRI	1
99*	R14013	REPAIR-KIT GASKET 4860 MXMA 06	1

076010103 / C076010102

* NEW PART

X AS REQUIRED

HANDLEBAR, CONTROLS

990 ADVENTURE ORANGE ABS EU 2007

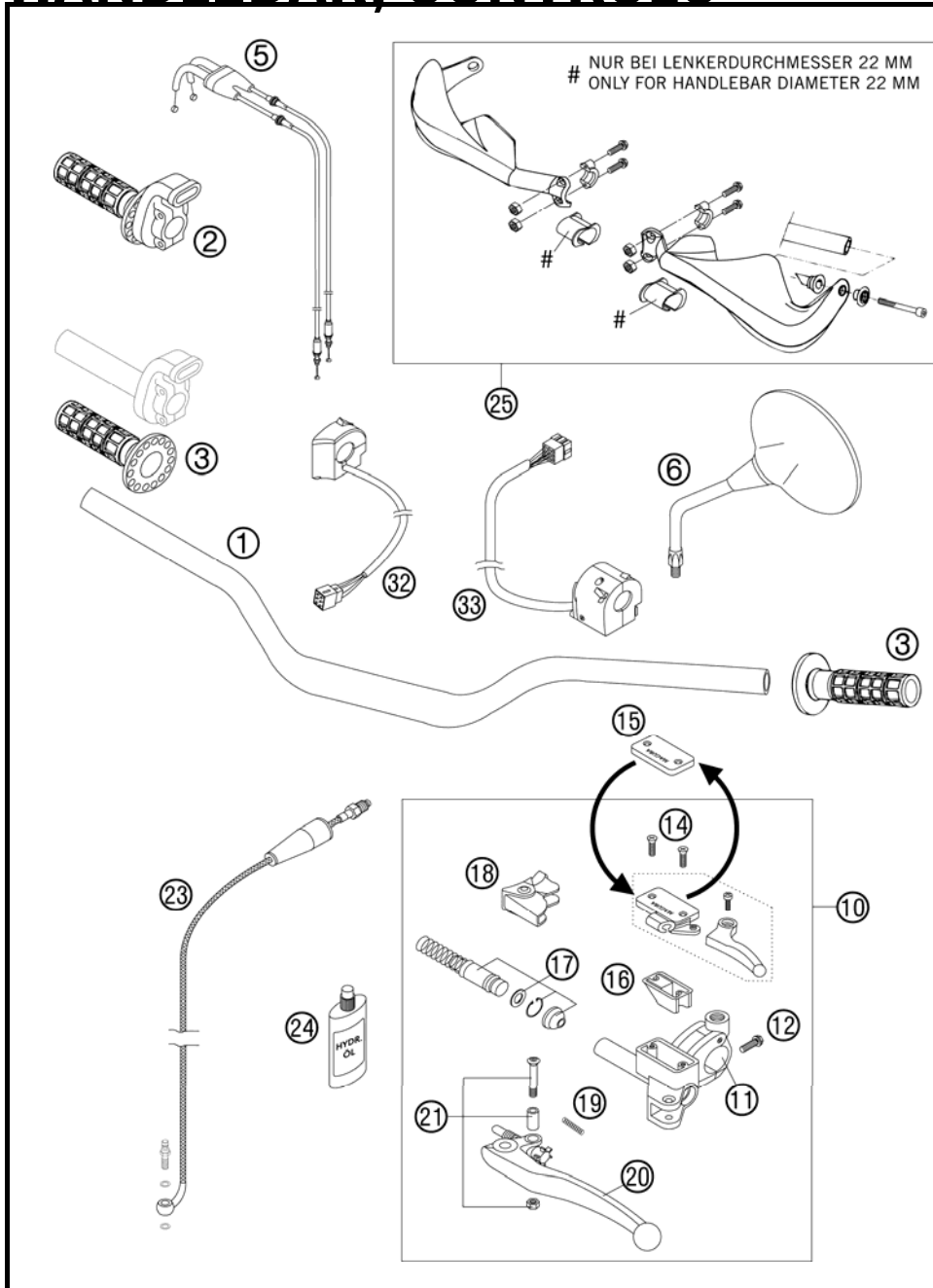

FIG	PART NUMBER	DESCRIPTION	QTY
1	60002001000	HANDLEBAR D=28MM 03	1
2	58702010000	THROTTLE GRIP CPL. DUKE 2000	1
3	58302021100	GRIPP SET	1
5	60002091000	THROTTLE CABLE LC8 ADV 2003	1
6	58412040100	REAR MIRROR L/S+R/S LC4 2001	2
10	60002030000	MASTER CYLINDER CPL. LC8 2003 COVER W/ CHOKE LEVER SUPPORT	1
11	60002044000	CLAMP MIRROR WITH CLAMP	1
12	0015060203	HH COLLAR SCREW M 6X20 WS=8	1
14	0965040123	FLAT HEAD SCREW DIN0965-M 4X12	2
15	50302033000	COVER FOR HYDR. CLUTCH '98	1
16	50302034000	RUBBER FOR RESERVOIR '98	1
17	50302032000	REP.SET PISTON CLUT.HYDR. '98	1
18	50302037000	PROTECT.CAP FOR LEVER PERCH'98	1
19	59002035000	SPRING FOR CLUTCH LEVER 03	1
20	60002031000	CLUTCH LEVER LONG CPL. 2003	1
21	50302038000	LEVER SCREW CPL. 125-200 '98	1
23	60032063100	CLUTCH PIPE LC8 ADV '03	1
24	50302036200	OIL FOR HYD. CLUTCH 75ML	1
25	6000207910030	HANDGUARD L/S+R/S CPL.BLACK 04	1
32	60011074100	START-STOP SWITCH 03	1
33	60011070000	LIGHT SWITCH A.D. 03	1

076010200 / C076010200

* NEW PART

X AS REQUIRED

FRAME, SUB FRAME, ENGINE GUARD

990 ADVENTURE ORANGE ABS EU 2007

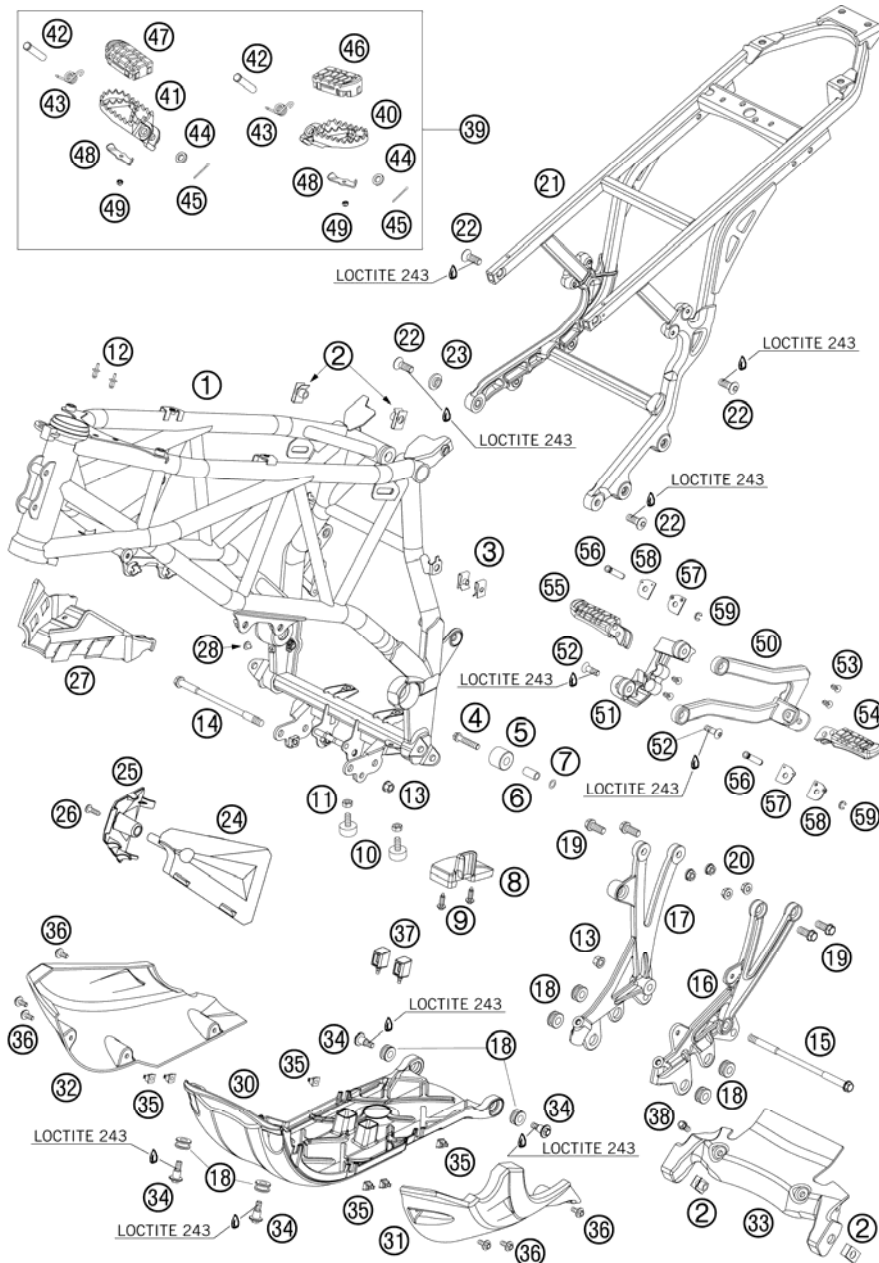

FIG	PART NUMBER	DESCRIPTION	QTY
1*	6010300110033	FRAME "FD07" 990 ADVENTURE 07	1
2	54603048000	RANGE CHANGE METAL NUT M8	4
3	54603048100	RANGE CHANGE METAL NUT M6	2
4	0015080403	HH COLLAR SCREW M 8X40 WS=10	1
5	58403060000	CHAIN ROLL 12X29X22,5 '98	1
6	58403060065	BUSH CHAIN ROLL 8X12X23 '98	1
7	36003014000	LOCK WASHER 8MM	1
8	60004076100	CHAIN SLIDING BLOCK 05	1
9	0017060204	EJOT PT SCREW K60X20 ALU WS=6	2
10	58303070100	BUMP RUBBER M8X25MM	2
11	0934080003	HEXAGON NUT DIN0934-M 8	2
12	60003088000	PLASTIC CAP FOR M6 03	2
13	54630044000	COLLAR NUT M10 WS=13	2
14	60003013000	ENGINE BRAC. SCREW M10X172 03	1
15	60003014000	ENGINE BRAC. SCREW M10X206 03	1
16	60003005000	ENGINE SUPPORT LEFT 03	1
17	60003006000	ENGINE SUPPORT RIGHT 03	1
18	60003098000	RUBBER SLEEVE 03	8
19	0015100243	HH COLLAR SCREW M10X24 WS=13	4
20	54310086100	SELF LOCKING NUT M10 CU WS=14	4
21*	6000300200092	SUB FRAME PLATINUM 07	1
22	60003004027	FL.HEAD SCREW M10X1,25 L=27 03	4
23	60003001051	COLLAR BUSHING 10X15X25X4 03	1
24	62503085000	COVER FRAME L/S FRONT 05	1
25	62503086000	COVER FRAME R/S FRONT 05	1
26	0081500181	SCREW FOR PLASTIC D=5X18	1
27	60003087000	SPLASH PROTECTOR FRAME 05	1
28*	60103088000	PLUG ZK 8/5 06	1
30	60003091000	UNDERRIDE PROTECTION 03	1
31*	60003092100	UNDERRIDE PROTECTION LEFT 06	1
32*	60003093100	UNDERRIDE PROTECTION RIGHT 06	1
33*	6000309400001S	LOWER TANK HOLDER FRONT 07	1
34	60003097000	COLLAR SCREW M8 03	4
35	60003095000	CAGE NUT M6 SL 4MM 03	6
36	0014060153	HH COLLAR SCREW M 6X15 WS=8	6
37	60003096000	VIBRATION DAMPER 03	2

076010300 / C076010300

* NEW PART

X AS REQUIRED

FRAME, SUB FRAME, ENGINE GUARD

990 ADVENTURE ORANGE ABS EU 2007

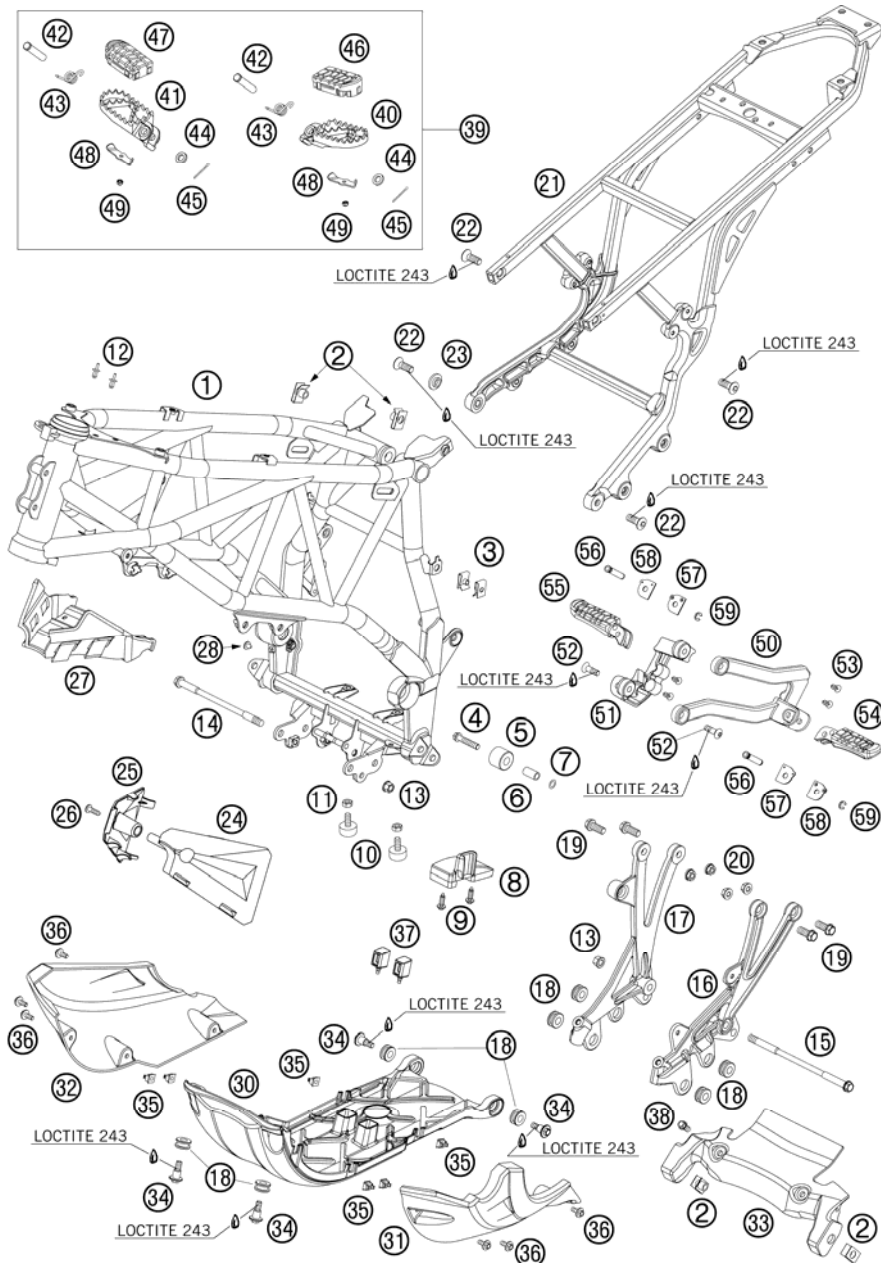

FIG	PART NUMBER	DESCRIPTION	QTY
38	0015080163	HH COLLAR SCREW M 8X16 WS=10	2
39	60003040033	FOOTREST L/S+R/S CPL. 03	1
40	59003040250	FOOT PED L/S SILVER 02	1
41	59003041250	FOOT PED R/S SILVER 02	1
42	54803044000	BOLT FOR FOOT PED 03	2
43	54603041000	FOOTREST SPRING L/S & R/S	2
44	0125100003	WASHER DIN0125-A10,5	2
45	0094032253	PIN DIN0094-3,2X25 STEEL	2
46	60003040010	FOOTREST RUBBER FRONT L/S 03	1
47	60003041010	FOOTREST RUBBER FRONT R/S 03	1
48	60003044010	CLOSING PANEL FRONT L/S R/S 03	2
49	0985050003	SELF LOCKING NUT DIN0985-M 5	2
50*	6000304800001S	FOOTREST BRACKET REAR L/S 07	1
51*	6000304900001S	FOOTREST BRACKET REAR R/S 07	1
52	54510052100	SPROCKET SCREW-AH M8X26 WS=6	4
53	54403135000	PLASTIC CAP SFL10	4
54	60003050000	FOOTREST CPL. L/S REAR 03	1
55	60003051000	FOOTREST CPL. R/S REAR 03	1
56	60003044000	BOLT FOR FOOTREST REAR 03	2
57	60003152000	ENGAGE PANEL FOOTREST L/S 03	2
58	60003052000	ENGAGE PANEL FOOTREST R/S 03	2
59	0799060003	TAB WASHER DIN6799-RS 6,0	2

076010300 / C076010300

* NEW PART

X AS REQUIRED

SIDE AND CENTER STAND

990 ADVENTURE ORANGE ABS EU 2007

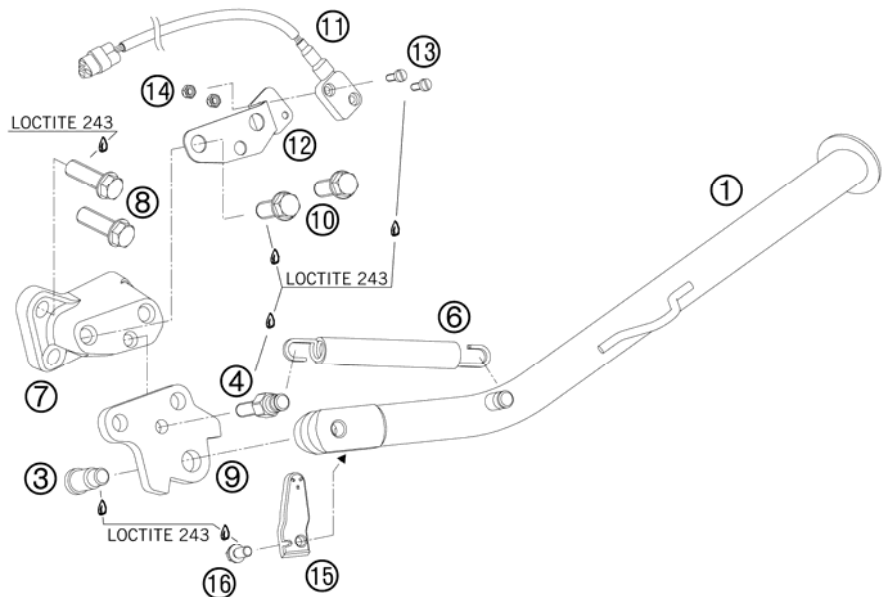
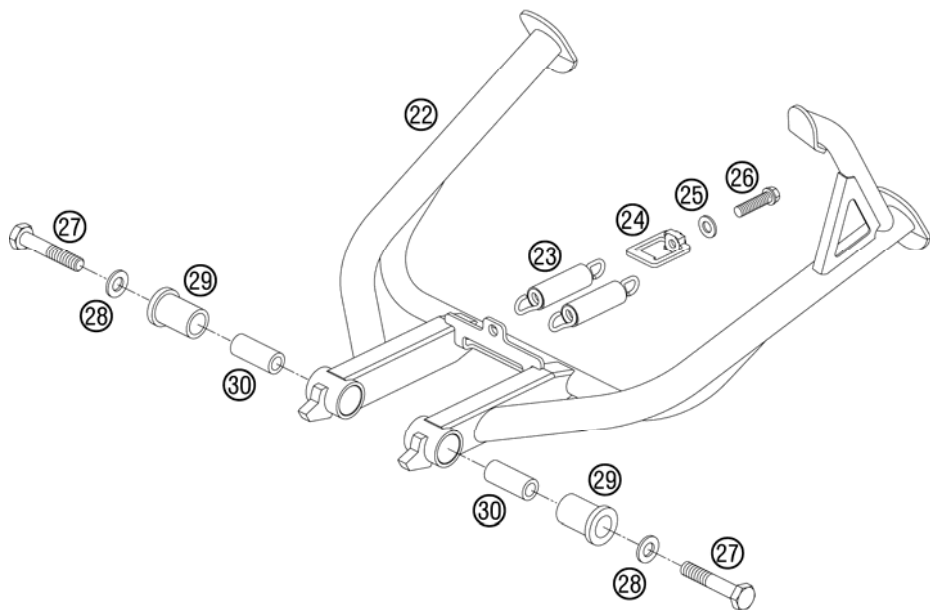

FIG	PART NUMBER	DESCRIPTION	QTY
1	6010302310030	SIDE STAND L=302MM 06	1
3	62503027100	SCREW F. SIDE STAND M10X31,2	1
4	61003028001	SCREW SIDE STAND SPRING 05	1
6	61003024000	SPRING L=116 MM 05	1
7	60003026000	SIDE STAND BRACKET 03	1
8	0015100303	HH COLLAR SCREW M10X30 WS=13	2
9	60103028000	SIDE STAND PICKUP 06	1
10	0015100243	HH COLLAR SCREW M10X24 WS=13	2
11	61011045000	SIDE STAND SENSOR 05	1
12	60103029000	SUPPORT F.SIDE STAND SWITCH 06	1
13	0084040123	CYL.HEAD SCREW DIN84A M4x12	2
14	0985040003	SELF LOCKING NUT DIN0985-M 4	2
15	60103029050	MAGNET HOLDER ADV. 06	1
16	0015060123	HH COLLAR SCREW M 6X12 WS=8	1
22	6000302240030	CENTER STAND L=333MM 05	1
23	60003030000	SPRING FOR CENTER STAND 03	2
24	60003022115	SPRING TENSIONER 03	1
25	0125080003	WASHER DIN0125-A 8,4	1
26	0015080303	HH COLLAR SCREW M 8X30 WS=10	1
27	56503093000	SPECIAL SCREW M10X55 WS=17	2
28	0125100003	WASHER DIN0125-A10,5	2
29	60003022020	BEARING BUSH CENTER STAND 03	2
30	60003022021	SPACER 10X16X38 MM 03	2



076010301 / C076010301

* NEW PART

X AS REQUIRED

SWING ARM

990 ADVENTURE ORANGE ABS EU 2007

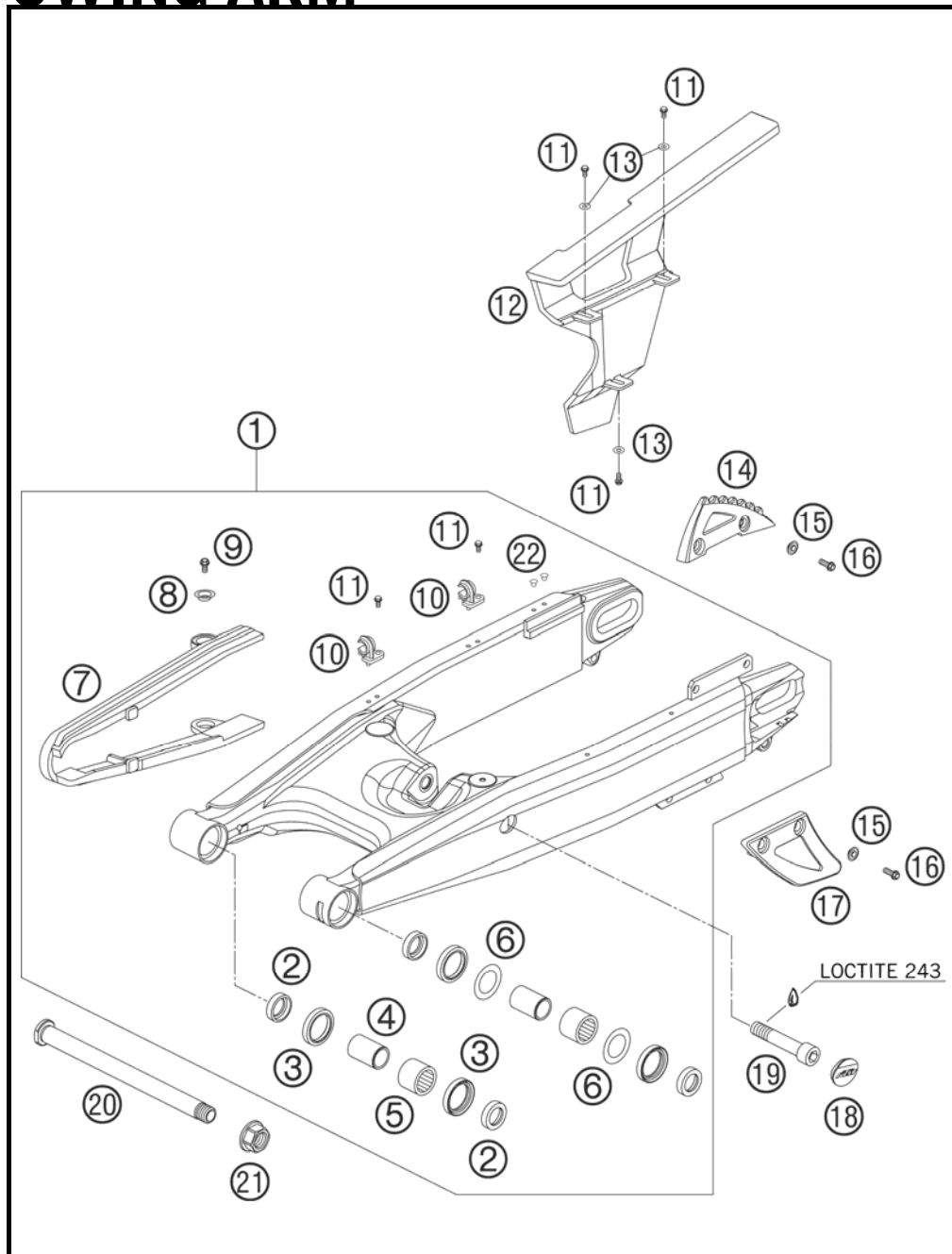

FIG	PART NUMBER	DESCRIPTION	QTY
1	60004030244	SWINGARM CPL. "G6" LC8 ADV. 06	1
2	60004034000	BUCKET F. SHAFT SEAL RING 03	4
3	0760304073	SHAFT SEAL RING 30X40X7	4
4	60004032000	INNER RING JR20X25X38,5 03	2
5	60004031000	NEEDLE BUSH HK2526B 03	2
6	60004033000	STOP DISK 03	2
7	60004066000	CHAIN SLID. GUARD SWINGARM 03	1
8	72210079000	BUCKET	2
9	0015060103	HH COLLAR SCREW M 6X10 WS=8	2
10	60104042000	RET. CLAMP F. BRAKE HOSE	2
11	0009050103	SPECIAL SCREW M 5,0X10	5
12*	60004061100	CHAINGUARD 06	1
13	0021050003	WASHER DIN9021-A 5,3	3
14	60004075000	REAR SPROCKET GUARD 03	1
15	50308053000	BUSH FOR SPOILER 6X11X16X7,5	4
16	0015060163	HH COLLAR SCREW M 6X16 WS=8	4
17	60004070000	CHAIN GUIDE 03	1
18	60004041000	PLUG SWINGARM 03	1
19	60004017000	SCREW M14X1,5 L=73MM 03	1
20	60004037144	SWINGARM BOLT CPL. 05	1
21	60004038000	COLLAR NUT M19X1,5 WS=27MM 03	1
22	60104043000	PLUG 06	2

066010400 / C076010400

* NEW PART

X AS REQUIRED

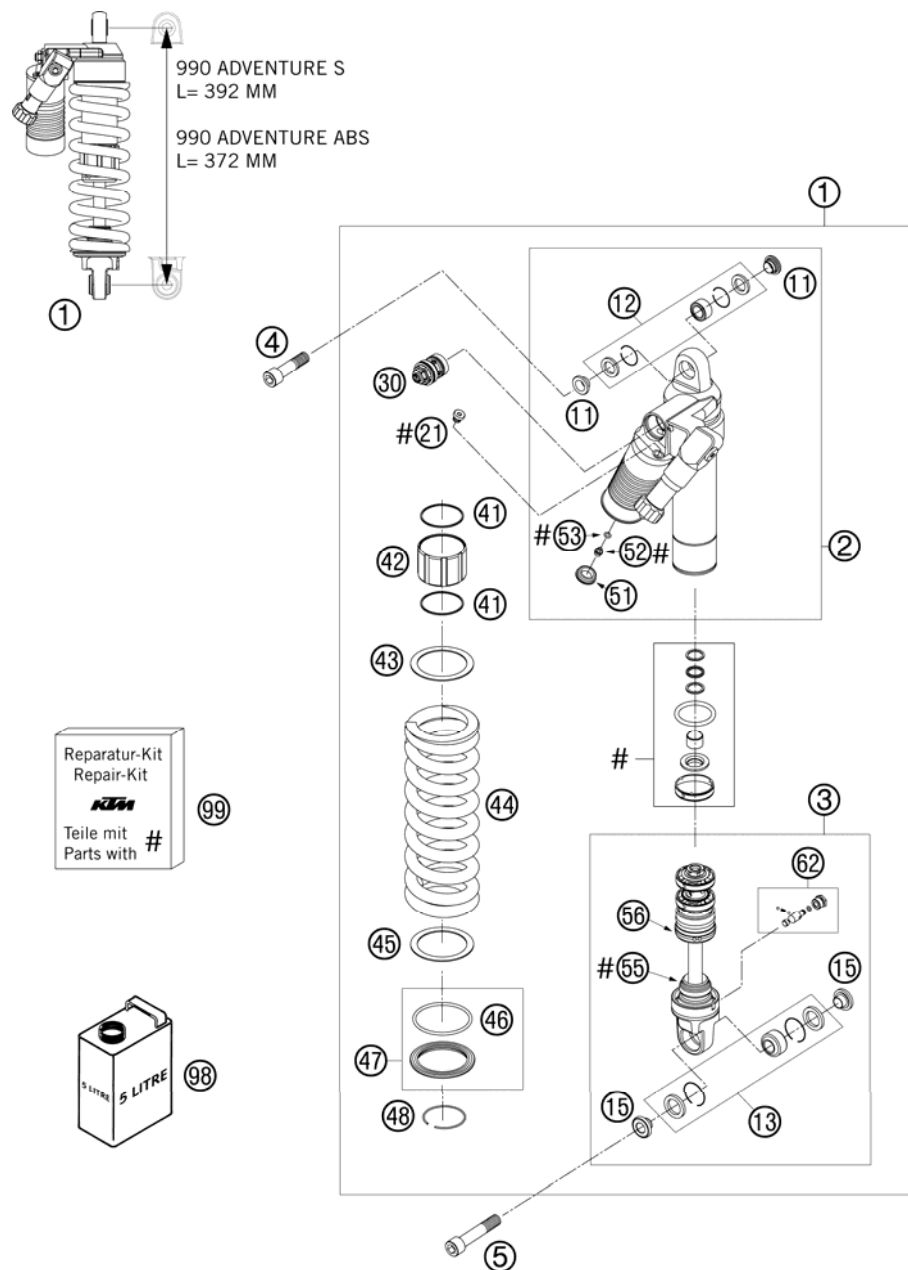

FIG	PART NUMBER	DESCRIPTION	QTY
1*	12187C08	MONOSHOCK 990 ADVENTURE	07 1
2	50180412S1	MONOSHOCK UPPER PART CPL.	07 1
3	50180358S3	MONOSHOCK LOWER PART CPL.	07 1
4	60004016000	SCREW M14X1,5 L=55MM	03 1
5	60004017000	SCREW M14X1,5 L=73MM	03 1
11	50180366	ADAPTOR BUSH KGW 14X24	2 2
12	R12012	REP. KIT BEAR./SEAL UP. ADV 07	1 1
13	R12013	REP. KIT BEAR./SEAL LOWER ADV 07	1 1
15	50180365	ADAPTOR BUSH KGW D=32 14X32	2 2
21	50180095	BLEED PLUG R 1/8	1 1
30	50180213S4	DCC-COMPR.DAMP.CONTROL CPL.	03 1
41	50180133	CIRCLIP 50X1,5	2 2
42	50180081	SPRING GUIDANCE L=40	1 1
43	50180114	INTERM.RING SCREW SPRING RET.	1 1
44	91210036	SPRING 150-225 (62) D=14,5	1 1
45	50180402	INTERM.RING SPRING RET. H=3,5	1 1
46	50180352	O-RING VITON 66,27X3,53	1 1
47	50180463S	SPRING RET. D=80 W. O-RING 05	1 1
48	50180273	CIRCLIP 58,2X2	1 1
51	46811208	RUBBER CAP "DO NOT OPEN"	1 1
52	36120151	SCREW PLUG M5X6	1 1
53	46810893	O-RING NBR 5,28X1,78	1 1
55	50180276	BUMP RUBBER WP60 D=18-26	1 1
56	50180165	COVER D=50	1 1
62	50180434S	ADJUSTING SCREW REBOUND TRAVEL	1 1
98*	50180342S1	SHOCK ABSORBER FLUID 5 LT '03	1 1
99	R12008	REPAIR-KIT GASKET 5018 PDS 03	1 1

076010404 / C076010401

* NEW PART

X AS REQUIRED

EXHAUST SYSTEM

990 ADVENTURE ORANGE ABS EU 2007

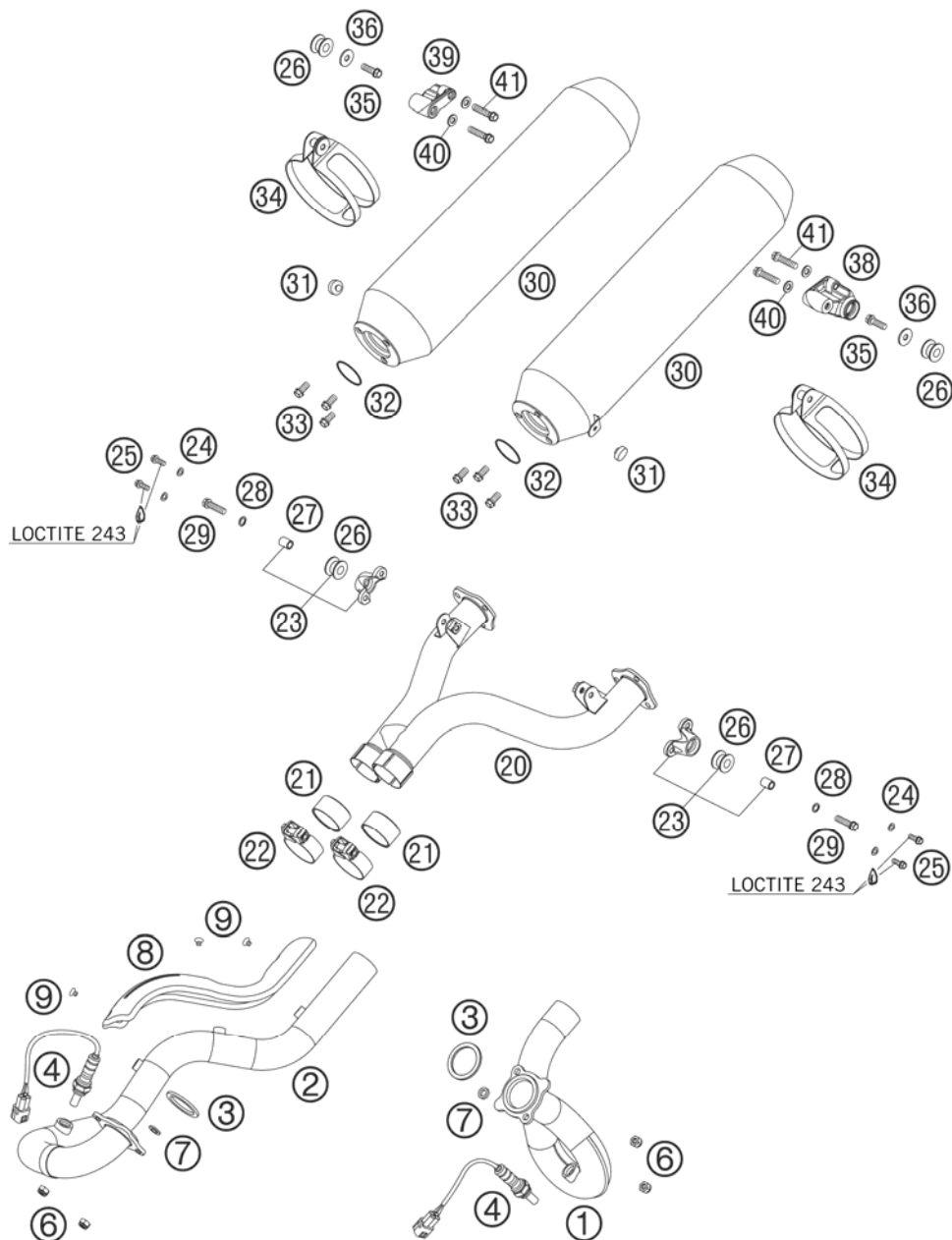

FIG	PART NUMBER	DESCRIPTION	QTY
1	60105008000	EXHAUST PIPE REAR 06	1
2	60105007000	EXHAUST PIPE FRONT 06	1
3	61005005000	EXHAUST GASKET 05	2
4	61041090000	LAMBDA SENSOR 05	2
6	51010086100	SELF LOCKING NUT M 8 CU	4
7	0125080003	WASHER DIN0125-A 8,4	2
8	60005011000	THERMAL SHIELD 05	1
9	0991060082	FLAT H.SCREW M6X8 DIN7991 NIRO	3
20	60005048000	DISTRIBUTOR TUBE LC8 03	1
21	60005005001	GRAPHIT RING 42X47X25 03	2
22	60105051000	CLAMP CPL. D=49,2MM 06	2
23	58405085044	SILENCER BRACKET CPL. 2001	2
24	0137060003	SPRING WASHER DIN0137-B 6	4
25	0015060203	HH COLLAR SCREW M 6X20 WS=8	4
26	54305068100	DAMP. COMPONENT SILICONE GREY	4
27	56505069000	SPACER BUSHING 8,4X12X16	2
28	36003014000	LOCK WASHER 8MM	2
29	0015080303	HH COLLAR SCREW M 8X30 WS=10	2
30	60105083000	SILENCER "990 A" 06	2
31	54308042000	RUBBER BUFFER	2
32	60005005002	EXHAUST GASKET 03	2
33	0015080163	HH COLLAR SCREW M 8X16 WS=10	6
34	60005095000	CLAMP FOR SILENCER CPL. 03	2
35	0015080253	HH COLLAR SCREW M 8X25 WS=10	2
36	0021080003	WASHER DIN9021-A 8,4	2
38*	6000508500001S	SILENCER/HANDLE HOLDER L/S 07	1
39*	6000508600001S	SILENCER/HANDLE HOLDER R/S 07	1
40	0125080003	WASHER DIN0125-A 8,4	4
41	0015080353	HH COLLAR SCREW M 8X35 WS=10	4

066010500 / C076010500

* NEW PART

X AS REQUIRED

AIR FILTER BOX

990 ADVENTURE ORANGE ABS EU 2007

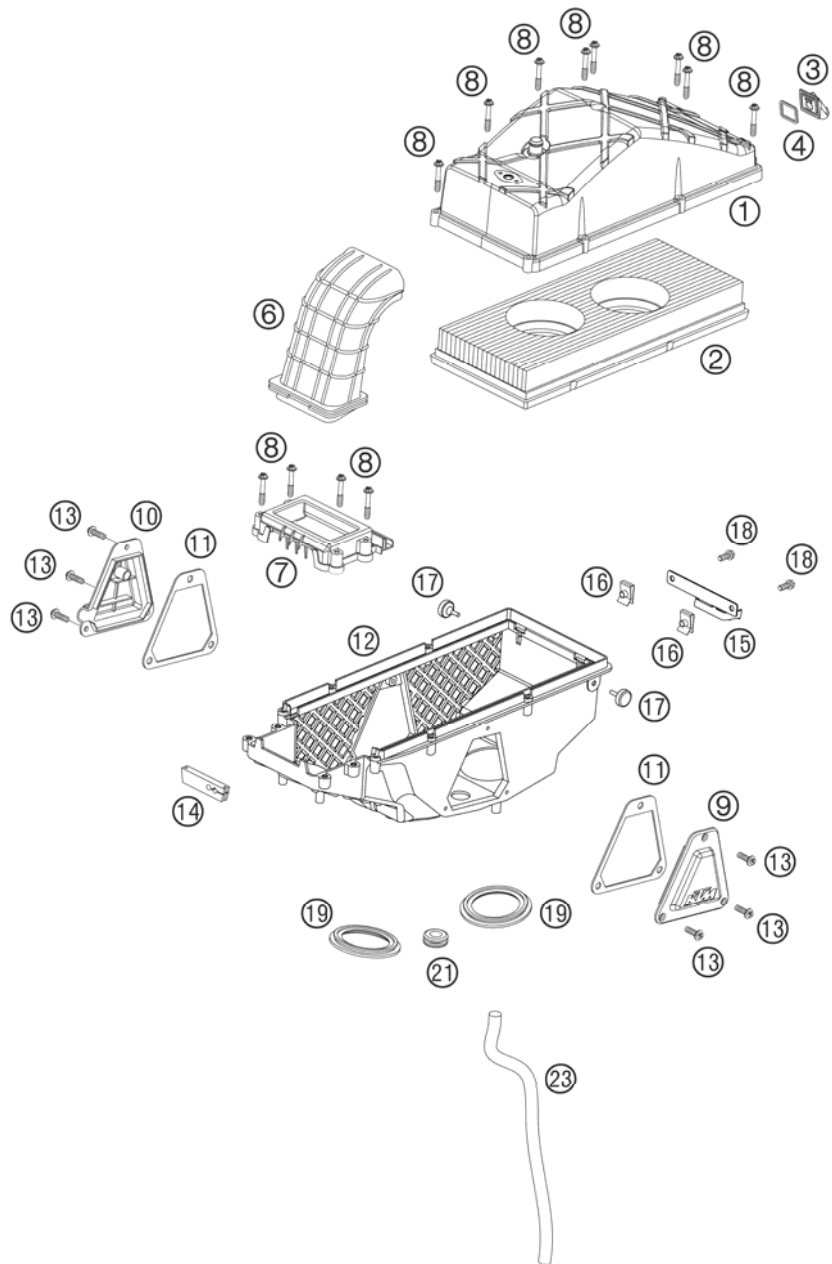

FIG	PART NUMBER	DESCRIPTION	QTY
1	61006002000	AIRBOX COVER 990 DUKE	04
2	61006015000	AIR FILTER EFI	05
3	60006007000	CONNECTOR FOR SAS LC8	03
4	60006007050	GASKET SAS CONNECTOR	03
6	60006040000	INTAKE SNORKEL	03
7	60006004000	AIRBOX FRONT PART LC8	03
8	60006006000	SPECIAL SCREW K60X35/15	03
9	60006003002	AIRBOX COVER L/S R/S	03
10	61006003002	AIRBOX COVER R/S EFI	05
11	60006003050	GASKET F. AIRBOX COVER L/S R/S	05
12	61006001000	FILTER BOX LOWER PART 990	05
13	0017060203	EJOT PT SCREW K60X20 WS=6	06
14	61006001030	RUBBER SLEEVE F. THR. CABLE	05
15	61006001020	SAS-BRACKET PANEL	05
16	54603048100	RANGE CHANGE METAL NUT M6	02
17	60006001021	DISTANCE RUBBER AIRBOX	03
18	0015060163	HH COLLAR SCREW M 6X16 WS=8	02
19	60036045000	RUBBER SLEEVE AIRBOX	03
21	60006001041	RUBBER SLEEVE FUEL HOSE	03
23	57005020001	HOSE 10X14 PER METER	x

066010600 / C066010600

* NEW PART

X AS REQUIRED

TANK, SEAT, COVER

990 ADVENTURE ORANGE ABS EU 2007

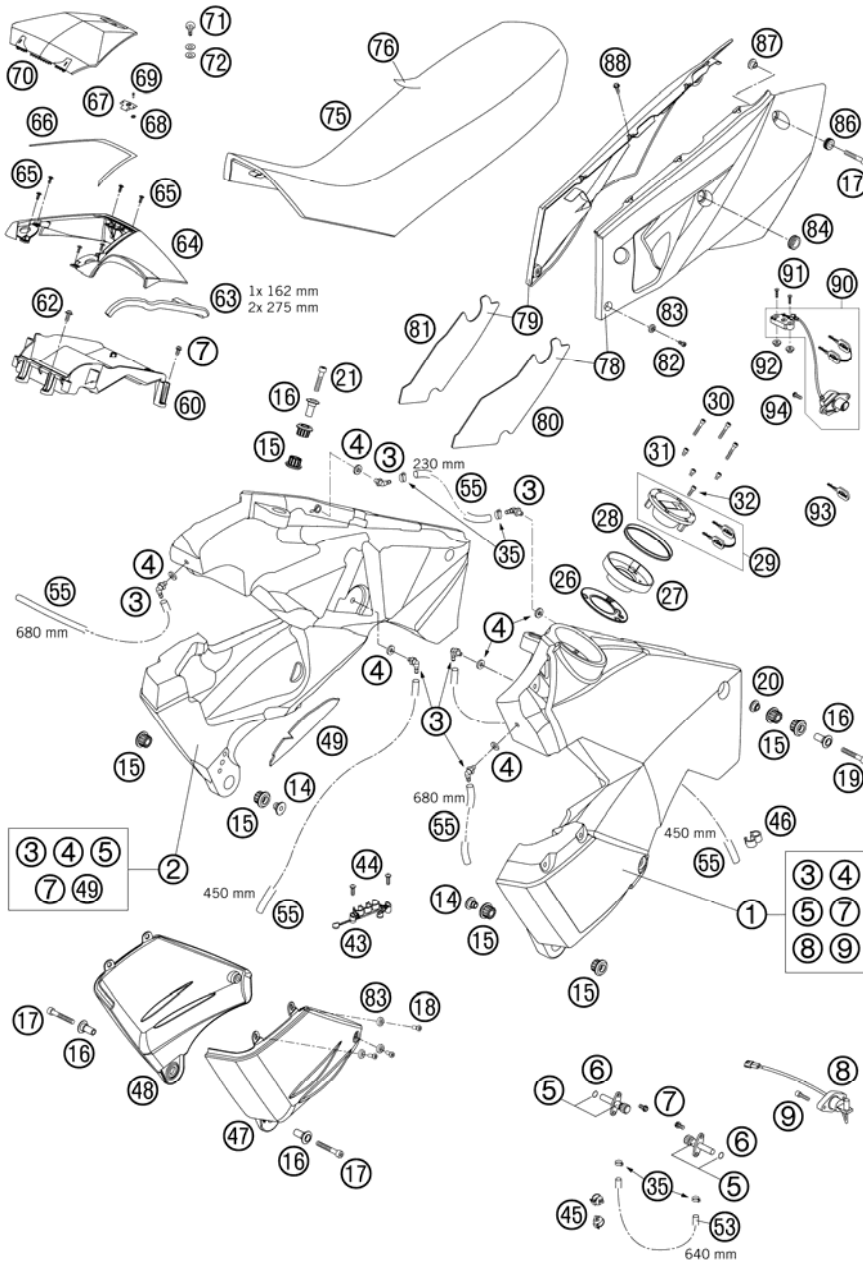

FIG	PART NUMBER	DESCRIPTION	QTY
1*	6010701314471A	FUEL TANK L/S CPL. ORANGE 06 DECAL OVER-COATED	1
2*	6010711313371A	FUEL TANK R/S CPL. ORANGE 07 DECAL OVER-COATED	1
3	60007024000	CONNECT.PIECE F.OVERFLOW M7 03	4
4	60007024050	GASKET FOR CONNECTING PIECE 03	4
5	58507003000	FUEL COCK CPL. SMALL RALLYE'96	2
6	55007006200	O-RING 11X1,8 NBR 70	2
7	0015060123	HH COLLAR SCREW M 6X12 WS=8	6
8	58207080000	GAS-LEVEL SENSOR ADV. 2002	1
9	0912050163	AH SCREW DIN0912-M 5X16	2
14	60007062000	BEAR.BUSH.INSIDE L=15,5MM 03	2
15	60007065000	TANK RUBBER BUSHING 03	12
16	60007060000	BEARING BUSHING OUTSIDE 03	6
17	0912080553	AH SCREW DIN912 M8X55	4
18	0984060163	AH SCREW DIN912-M 6X16	6
19	0912080503	AH SCREW DIN912 M8X50	2
20	60007061000	BEARING BUSHING INSIDE 03	2
21	0912080403	AH SCREW DIN912 M8X40	2
26	60007008051	SEAL. FLANGE F.TANK INSERT 03	2
27	60007008150	TANK INSERT 05	2
28	60007008052	SEAL. RING F. TANK INSERT 03	2
29	60007008000	TANK PLUG CPL. 03	2
30	0912050303	AH SCREW DIN0912-M 5X30	6
31	0912050083	AH SCREW DIN 912 M 5X8	6
32	0912050123	AH SCREW DIN0912-M 5X12	2
35	58031005000	CLAMP YDNAC 10128 12MM	2
43	60011057000	HOSE HOLDER TRIPLE 03	1
44	0081500181	SCREW FOR PLASTIC D=5X18	2
45	57013072100	WIRING HOLDER 16MM	2
46	55011022100	CLAMP D=6/8MM, BLACK	1
47	60107013050	TANK PROTECTOR L/S 06	1
48	60107113050	TANK PROTECTOR R/S 06	1
49*	60007095100	THERMAL PROTECT. FOIL TANK 07	1
53	60007116001	HOSE 6X12 PER METER	x
55	60007026001	HOSE NBR 5,4X9,4 PER METER	x

076010700 / C076010700

* NEW PART

X AS REQUIRED

TANK, SEAT, COVER

990 ADVENTURE ORANGE ABS EU 2007

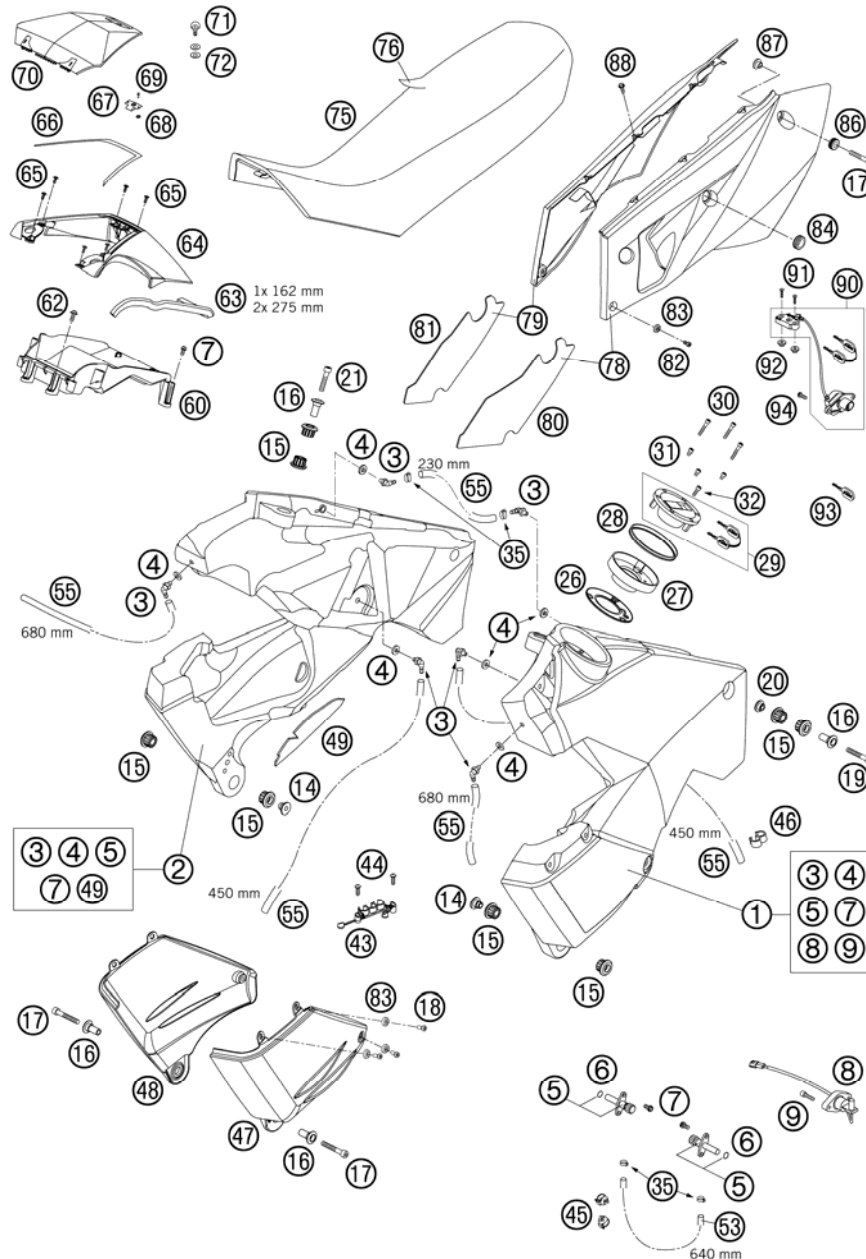

FIG	PART NUMBER	DESCRIPTION	QTY
60	60007023100	STORAGE BOX BOTTOM PART 06	1
62	0014060153	HH COLLAR SCREW M 6X15 WS=8	2
63	58312085100	EDGE PROTECTOR PER METER	1
64	6000701900071A	STOR.BOX CENT.PART ORANGE 06	1
65	0016050121	SCREW FOR PLASTIC 50X12	6
66	60007019050	GASKET F.STOR.BOX CENT.PART 03	1
67	45007040050	QUICK RELEASE LATCHPLATE	1
68	0021030003	WASHER DIN9021-A 3,2MM	2
69	0011321000	DUMMY RIVET 3,2X10 ALU	2
70	6000702000071A	COVER F. STORAGE BOX ORANGE 06	1
71	60007020030	QUICK RELEASE PIN WITH RING 03	1
72	60007020040	PLASTIC WASHER 03	2
75	6000704020030	SEAT BLACK 05	1
76	6000704025030	SEAT COVER BLACK 05	1
78	6000804100034A	SIDE COVER L/S REAR GRAY 06 DECAL OVER-COATED	1
79	6000804200034A	SIDE COVER R/S REAR GRAY 06 DECAL OVER-COATED	1
80*	60008041150	THER.PROT.FOIL SI. CO. L/S 07	1
81*	60008042150	THER.PROT.FOIL SI. COV. R/S 07	1
82	0984060163	AH SCREW DIN6912-M 6X16	2
83	60008045000	SPECIAL WASHER D=16,5MM 03	8
84	58707050050	RUBBER SLEEVE F.SEAT LOCK '99	1
86	41001052000	RUBBER SLEEVE D=12MM	2
87	60012008002	COLLAR BUSHING 8,2X12X20X9 03	2
88	0017060203	EJOT PT SCREW K60X20 WS=6	6
90	60007050000	SEAT LOCK LC8 ADV. 03	1
91	0738060301	COU.SUNK SCR. AH ISO7380 M6X30	2
92	60008013050	DISTANCE BUSH. 7X12X18X3,7 03	2
93	40011166100	KEY BLANK LC4/DUKE/LC8	x
94	0081500181	SCREW FOR PLASTIC D=5X18	2

076010700 / C076010700

* NEW PART

X AS REQUIRED

FUEL PUMP

990 ADVENTURE ORANGE ABS EU 2007

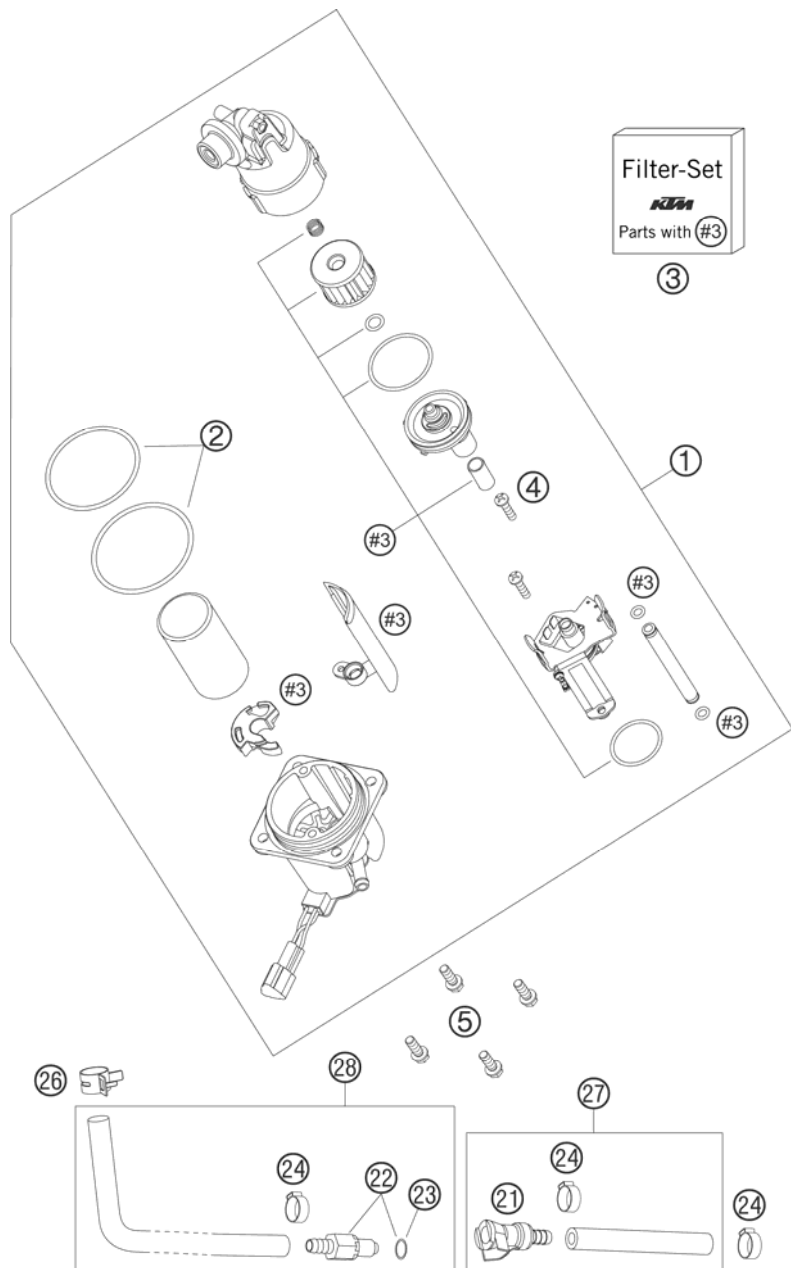

FIG	PART NUMBER	DESCRIPTION	QTY
1	61007088100	FUEL PUMP 06	1
2	61007089000	O-RING SET FOR FUEL PUMP 05	1
3	61007090000	FILTER-SET FUEL PUMP 05	1
4	61007091000	SCREW FOR FILTER-SET 05	2
5	0015060163	HH COLLAR SCREW M 6X16 WS=8	4
21	5850701050030	CLUTCH CPC BLACK 05	1
22	5850701030030	PLUG CPC BLACK 05	1
23	58507012000	O-RING VITON F. PLUG CPC 05	1
24	00050153706	VARIABLE ONE-EAR CLAMP 15,3MM	3
26	00049140121	CLAMP STD DN14	1
27	60107016051	FUEL HOSE CPL. 06	1
28	60107016050	FUEL HOSE 90° 1 CPL. 06	1

066010707 / C076010707

* NEW PART

X AS REQUIRED

MASK, FENDERS

990 ADVENTURE ORANGE ABS EU 2007

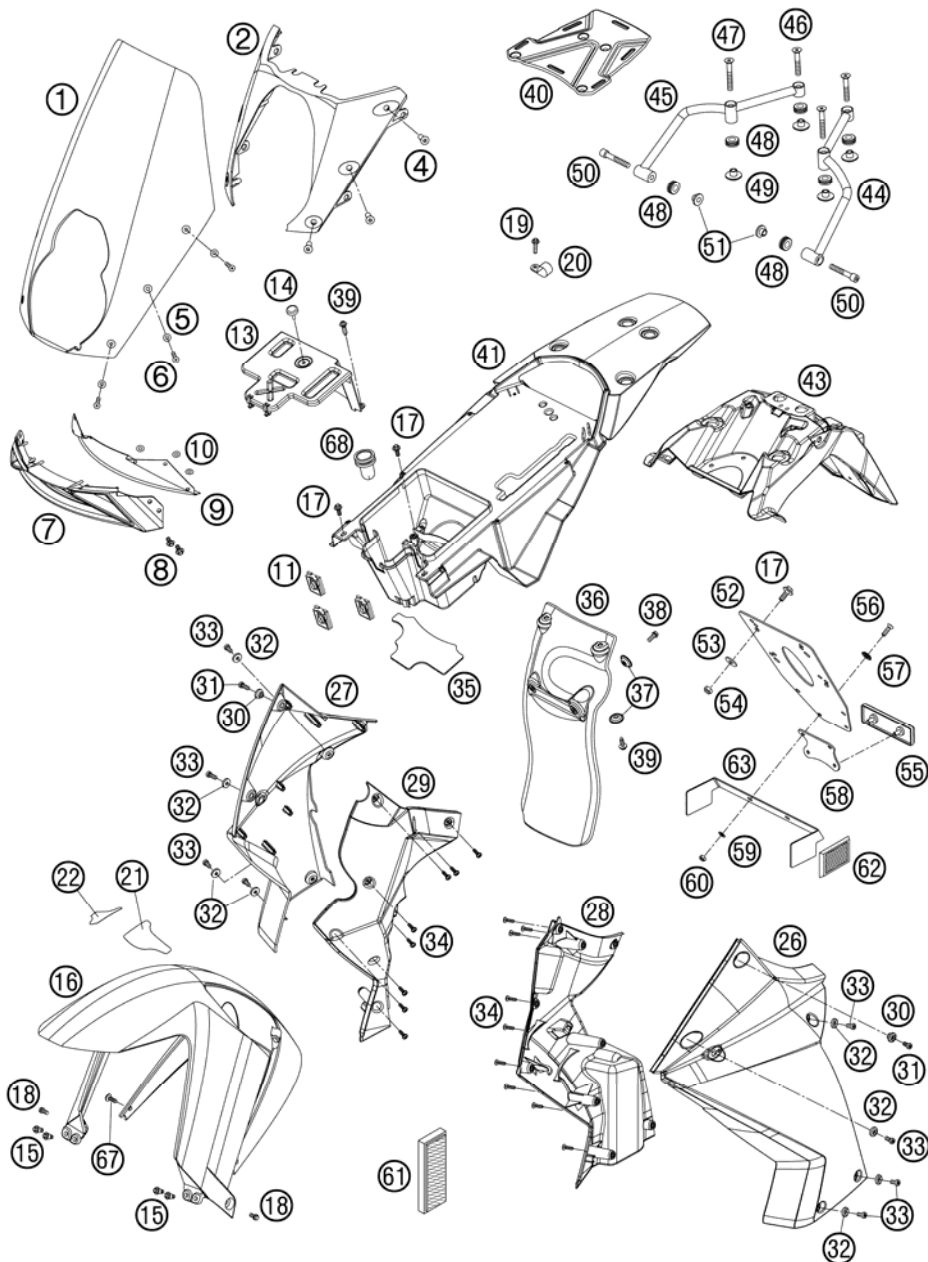

FIG	PART NUMBER	DESCRIPTION	QTY
1	60008008000	FAIRING SCREEN 03	1
2*	60008001100	HEAD LIGHT MASK 07	1
4	60008008050	BLIND PLUG-IN NUT M5 WN 16A 03	6
5	60008046000	SPECIAL WASHER D=12MM 03	6
6	0991050204	FLAT HEAD SCREW DIN7991-M 5X20	6
7	60008011000	AIR INTAKE 03	1
8	0014060103	HH COLLAR SCREW M 6X10 WS=8	4
9	60008011060	AIR INTAKE GRILL 03	1
10	60008011050	SPRING NUT 012410 03	6
11	60108017010	RUBBER SLEEVE 30X40 MM 06	3
13	60108017000	COVER F. STORAGE COMP. REAR 06	1
14	60006001021	DISTANCE RUBBER AIRBOX 03	1
15	59001092050	SPECIAL SCREW M6X12,5 WS=8	4
16	6010801000070A	FENDER FRONT ORANGE 06	1
17	0014060153	HH COLLAR SCREW M 6X15 WS=8	6
18	0015060103	HH COLLAR SCREW M 6X10 WS=8	2
19	0081500181	SCREW FOR PLASTIC D=5X18	4
20	57013070000	PVC-CLAMP 7/16" HEYCO 3377	4
21	60108010060	PROTECTIVE FILM L/S 06	1
22	60108010070	PROTECTIVE FILM R/S 06	1
26	6000805000070A	SIDE COVER L/S ORANGE 06 DECAL OVER-COATED	1
27	6000805100070A	SIDE COVER R/S ORANGE 06 DECAL OVER-COATED	1
28*	60008050150	INNER COVER LEFT 07	1
29*	60008051150	INNER COVER RIGHT	1
30	60008052000	BUSH F. SIDE COVER 03	2
31	0984060163	AH SCREW DIN6912-M 6X16	2
32	60008045000	SPECIAL WASHER D=16,5MM 03	8
33	0012060123	AH SCREW DIN6912 M6X12	8
34	0016050121	SCREW FOR PLASTIC 50X12	17
35*	60008013160	THER.PROT.FOIL REAR FENDER 07	1
36	60006010000	SPLASH PROTECT. LC8 03	1
37	72210079000	BUCKET	4
38	0015060163	HH COLLAR SCREW M 6X16 WS=8	2
39	0017060203	EJOT PT SCREW K60X20 WS=6	4

076010800 / C076010800

* NEW PART

X AS REQUIRED

MASK, FENDERS

990 ADVENTURE ORANGE ABS EU 2007

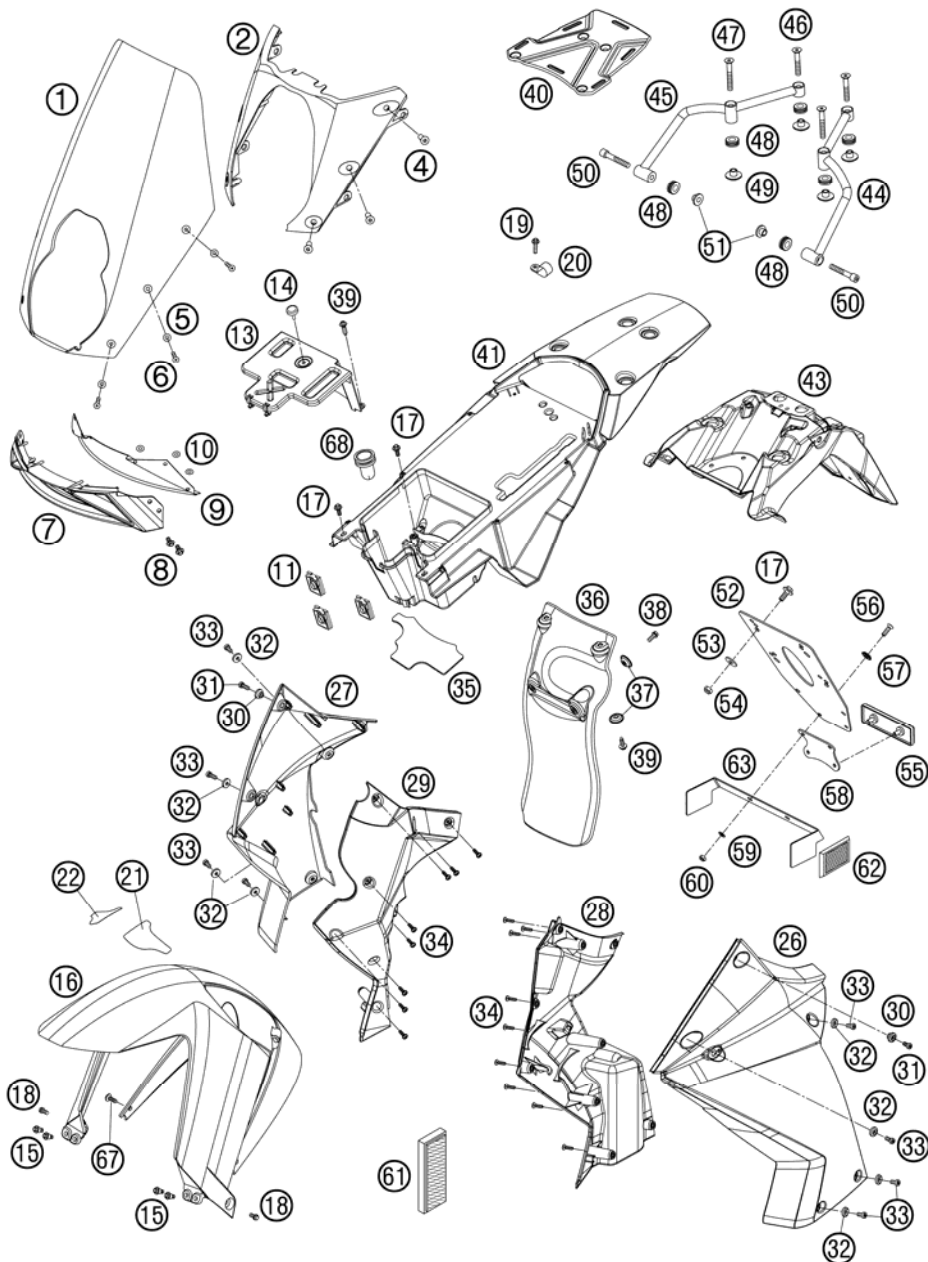

FIG	PART NUMBER	DESCRIPTION	QTY
40*	6001201000001S	BAGGAGE RACK LC8 07	1
41	6010801300030	REAR FENDER BLACK 06	1
43	60108015000	LICENSE NUMBER CARRIER 06	1
44	60012008000	HANDLE L/S 03	1
45	60012009000	HANDLE R/S 03	1
46	0991080503	FLAT HEAD SCREW DIN7991-M 8X50	2
47	0991080653	FLAT HEAD SCREW DIN7991-M 8X65	2
48	41001052000	RUBBER SLEEVE D=12MM	6
49	60012008003	COLLAR BUSHING 8,2X12X28X9 03	4
50	0912080553	AH SCREW DIN912 M8X55	2
51	60012008002	COLLAR BUSHING 8,2X12X20X9 03	2
52*	60012081200	LICENCE FITTING 06	1
53	0021060003	WASHER DIN9021-A 6,4	4
54	0985060003	SELF LOCK. NUT DIN0985-M 6	4
55	58412080000	REFLECTOR RED LC4 '98	1
56	0966050163	OVAL HEAD SCREW DIN0966-M 5X16	2
57	40006006000	WASHER 6MM	2
58	58412080050	BRACKET FOR REFLECTOR	1
59	0125050003	WASHER DIN0125-A 5,3	2
60	0985050003	SELF LOCKING NUT DIN0985-M 5	2
61	60012080000	SIDE REFLECTOR YELLOW 03	2
		FOR USA+ AUS ONLY	
62	16512180100	SIDE REFLECTOR RED REAR	2
		FOR USA ONLY	
63	62512081000	BRACKET SIDE REFLECTOR 06	1
		FOR USA ONLY	
67	0014060133	HH COLLAR SCREW M 6X13 WS=8	2
68	50206020000	RUBBER GRIMMET SLOTTED	1

076010800 / C076010800

* NEW PART

X AS REQUIRED

DECAL

990 ADVENTURE ORANGE ABS EU 2007

FIG	PART NUMBER	DESCRIPTION	QTY
1	60108099000	DECAL SET 990 ADV. ORANGE 06	1



①

066010807 / C076010807

* NEW PART

X AS REQUIRED

FRONT WHEEL

990 ADVENTURE ORANGE ABS EU 2007

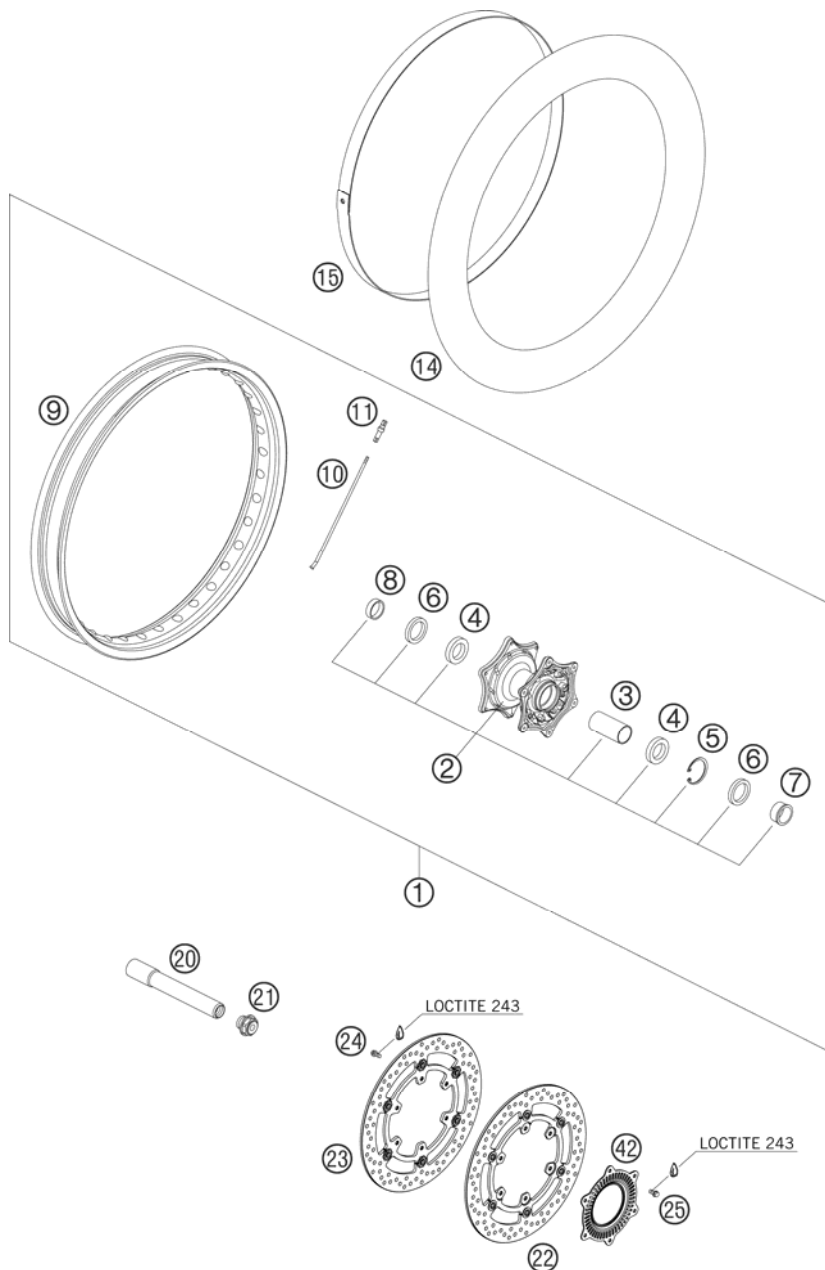

FIG	PART NUMBER	DESCRIPTION	QTY
1*	6000900114430	FR. WHEEL CPL 2,15X21 BLACK 07 BLACK	1
2	60009010044	FRONT HUB CPL. 03	1
3	60009014000	BEAR. SPACERTUBE FRONT 03	1
4	0625069068	GR.BALL BEAR.6906 DDU2CG23S6NM	2
5	0472047175	CIRCLIP DIN0472-47X1,75	1
6	0760354771	SHAFT SEAL RING 35X47X7 TC	2
7	60009012000	SPACER BUSH. FR. WHEEL L/S 03	1
8	60009013000	SPACER BUSH. FR. WHEEL R/S 03	1
9*	6000907010030	RIM FRONT 2,15X21" BLACK 07	1
10	60009071000	SPOKE M5X230,5 13,5 DEG	36
11	58309072000	SPOKE NIPPLE M5-TA (8X21MM)	36
14	50309075000	HOSE 21"	1
15	60009073000	RIM TAPE 21" 28/ 2MM 03	1
20	60009081000	WHEEL SPINDEL FRONT 03	1
21	60009082000	COLLAR SCREW FRONT AXLE 03	1
22	60109060100	BRAKE DISK FRONT 300MM ABS 06	1
23	60109060000	BRAKE DISK FRONT 300MM 06	1
24	59009062013	SPECIAL SCREW M6X13 WS=8 10.9	6
25	59009062016	SPECIAL SCREW M6X16 WS=8 10.9	6
42	60142020000	SENSOR WHEEL FRONT 06	1

066010900 / C076010900

* NEW PART

X AS REQUIRED

REAR WHEEL

990 ADVENTURE ORANGE ABS EU 2007

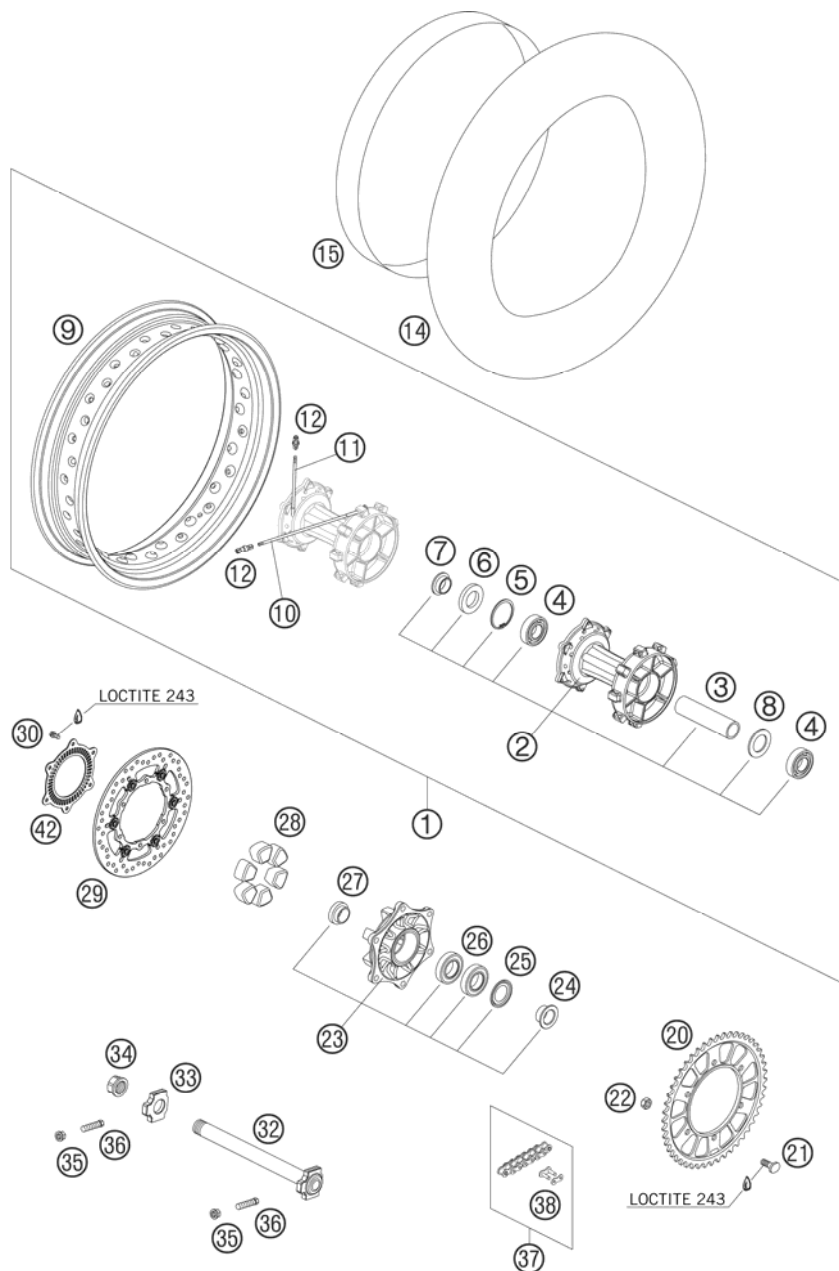

FIG	PART NUMBER	DESCRIPTION	QTY
1*	6011000114430	R. WHEEL CPL. 4,25X18 BLACK 07	1
2	60110010044	REAR HUB CPL. 06	1
3	60010011000	BEAR. SPACERTUBE L=124,8MM 03	1
4	0625062052	GR.BALL BEAR. 6205-2RSHC3HMTF7	2
5	0472052200	CIRCLIP DIN0472-52X2	1
6	0760305271	SHAFT SEAL RING 30X52X7	1
7	60110013000	SPACER BUSH. REAR WHEEL R/S 06	1
8	60010015000	SPACER RING 03	1
9*	6001007020030	RIM 4,25X18 BLACK	1
10	60010171000	SPOKE M5X219 19 DEG 03	18
11	60010071000	SPOKE M5X194 10 DEG 03	18
12	58309072000	SPOKE NIPPLE M5-TA (8X21MM)	36
14	50310075100	HOSE 110/100C-18	1
15	60010073000	RIM TAPE 18" 50/2 03	1
20	60010051042	REAR SPROCKET 42-T 03	1
20	60010051045	REAR SPROCKET 45-T 03	x
21	60010052000	SPROCKET SCREW M10X1,25 03	6
22	0980101253	HEXAG.NUT DIN 980V M10X1,25 SL	6
23	60110050044	SPROCKET SUPPORT CPL. 06	1
24	60110012000	SPACER BUSH. SPROCKET SUPP. 06	1
25	60110016000	NILOS RING 6006AV	1
26	0625060060	BALL BEARING 6006 DDU2CG23S6NM	2
27	60110014000	SPACER BUSH. SPR. SUPP. IN. 06	1
28	54610459000	DAMPING RUBBER '91	6
29	60110060000	BRAKE DISK REAR D=240MM 06	1
30	59009062016	SPECIAL SCREW M6X16 WS=8 10.9	6
32	60010081044	WHEEL SPINDLE REAR CPL. 03	1
33	60010084000	CHAIN TENSIONER R/S LC8 03	1
34	60010086000	COLLAR NUT WH. SPINDLE REAR 03	1
35	58414030000	HH COLLAR NUT M10X1,25 WS=13	2
36	50304040100	SCREW M10X1,25X50 WS=10	2
37*	60010365118	CHAIN 525 INCL. MASTER LINK	1
		RIVET TOOL NECCESARY	
38*	60010266000	MASTER LINK FOR CHAIN 525 07	x
42	60142021000	SENSOR WHEEL REAR 06	1

066011000 / C076011000

* NEW PART

X AS REQUIRED

WIRING HARNESS

990 ADVENTURE ORANGE ABS EU 2007

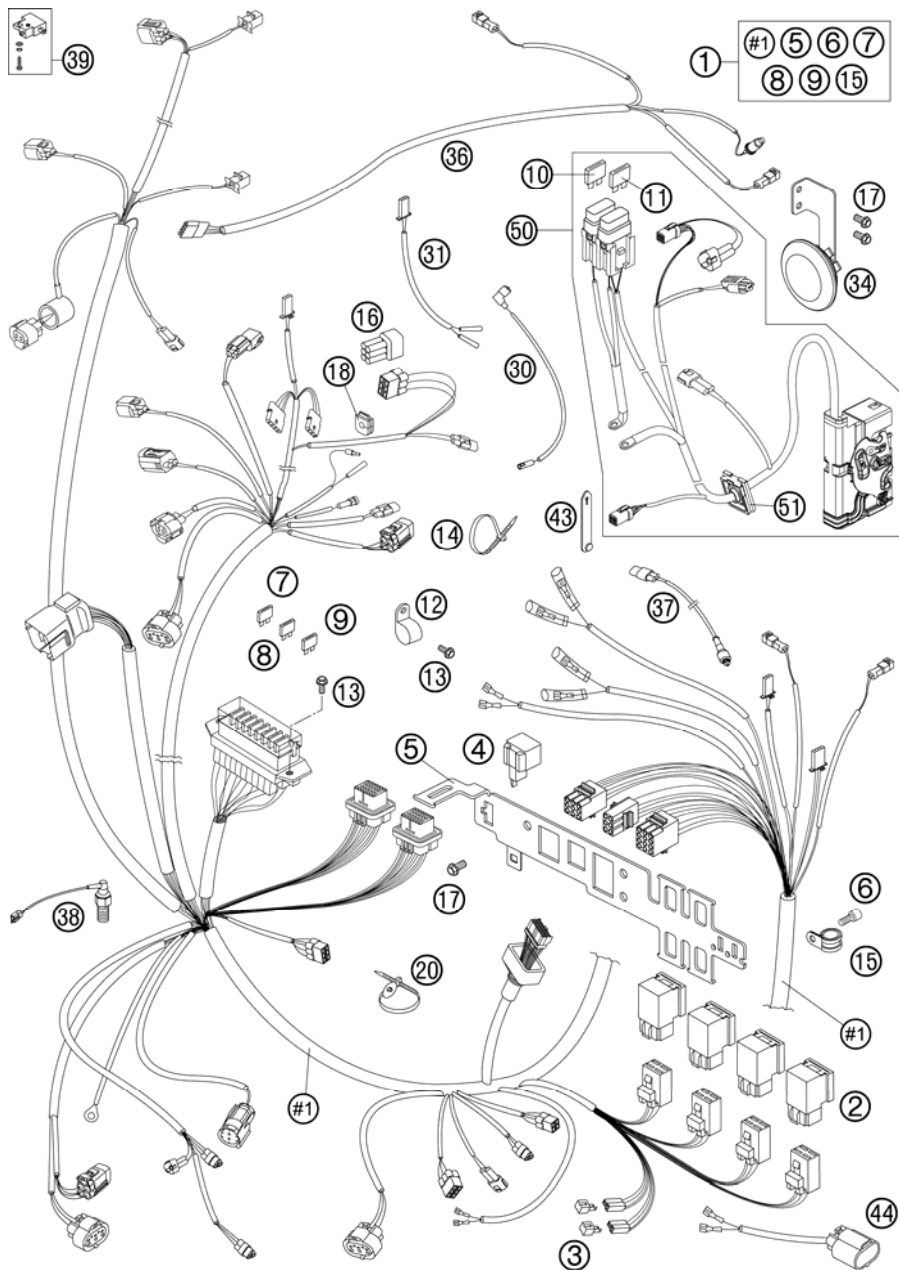

FIG	PART NUMBER	DESCRIPTION	QTY
1*	60111075200	MAIN CABLE HARNESS 990 ADV. 07	1
2*	61111057000	RELAY CM1A-R-12V-H80 07	4
3	58411096100	DIODE S3H-15 97	2
4	44611207200	FLASHER UNIT 97	1
5	60111083000	BRACKET FOR PLUGS 06	1
6	0912050123	AH SCREW DIN0912-M 5X12	1
7	58011109105	FUSE 5 A 2003	x
8	58011109110	FUSE 10 A 2000	x
9	58011109115	FUSE 15 A	x
10	58011109125	FUSE 25 A	x
11	58011109140	FUSE 40 A	x
12	57013070400	PVC CLAMP 17,4MM HEYCO 3381	1
13	0015050123	HH COLLAR SCREW M 5X12 WS=8	3
14	44011076100	CABLE TIE 100/2,5MM BLACK	x
14	44011076200	CABLE TIE 200/3,6MM BLACK	x
14	44011076305	CABLE TIE 300/4,8MM BLACK	x
15	49007439000	CLAMP RSGU 15/12	1
16	000700000BH	SPARE CONNECTOR BH DIAGNOSTIC PORT	1
17	0015060103	HH COLLAR SCREW M 6X10 WS=8	4
18	60108017015	RUBBER SLEEVE 22X18 MM 06	1
20	60011193000	CABLE TIE WITH PLUG 03	1
30	60011092000	OIL-PRESSURE SWITCH CABLE 03	1
31	60011025000	FLASHER CABLE FRONT 03	2
34	60011060100	DC HORN 12V 06	1
36	60111076000	WIRING HARNESS REAR 06	1
37	58411049100	CLUTCH SWITCH 03	1
38	50311051100	BRAKE LIGHT SWITCH REAR '98	1
39	60011050000	BRAKE LIGHT SW. FRONT CPL. 03	1
43	60011093045	RUBBER CABLE TIE 45MM 03	x
43	60011093060	RUBBER CABLE TIE 60MM 03	x
43	60011093075	RUBBER CABLE TIE 75MM 03	x
44*	61111020000	STARTER INTERLOCK	1
50	60111079000	WIRING HARNESS ABS 06	1
51	60108017010	RUBBER SLEEVE 30X40 MM 06	1

076011100 / C076011100

* NEW PART

X AS REQUIRED

BATTERY BOX

990 ADVENTURE ORANGE ABS EU 2007

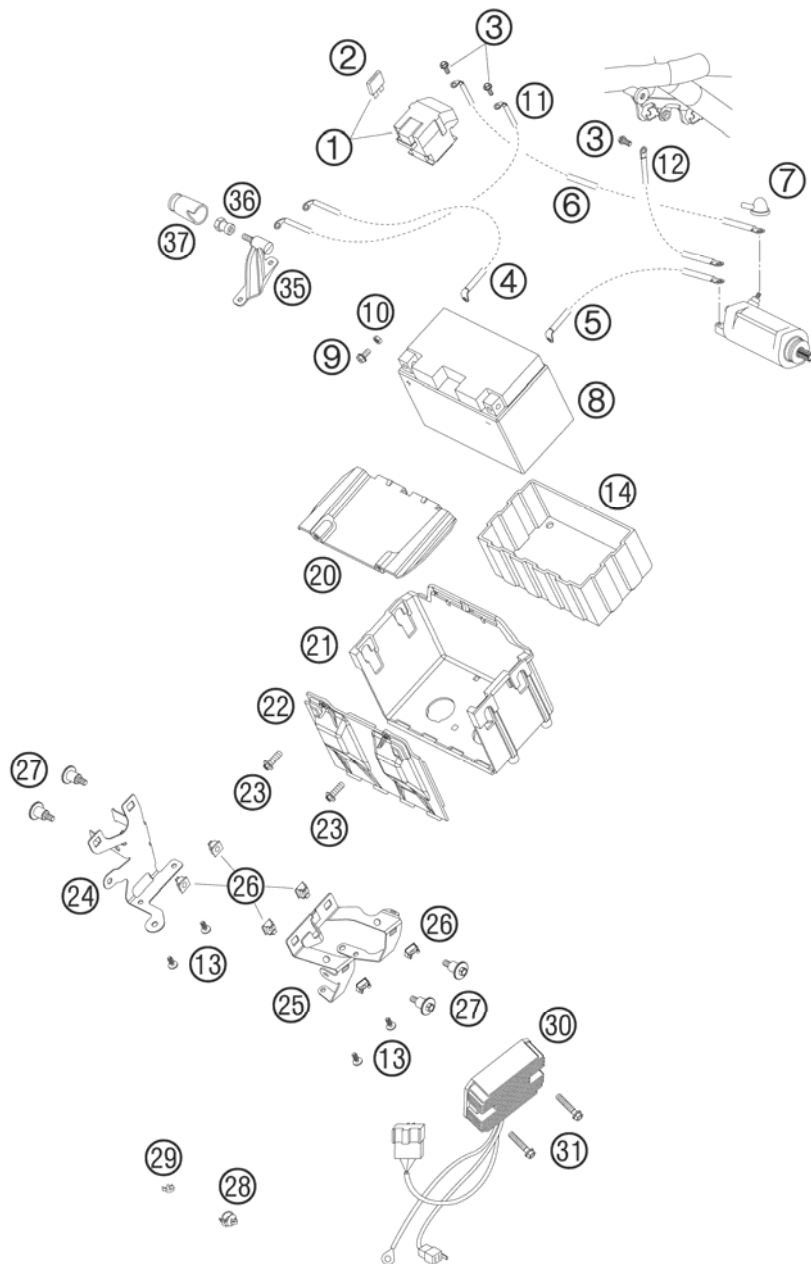

FIG	PART NUMBER	DESCRIPTION	QTY
1	60011058000	STARTER RELAY 03	1
2*	58011109130	FUSE 30 A	x
3	0015060103	HH COLLAR SCREW M 6X10 WS=8	3
4	60011059050	BATTERY CABLE L=350MM LC8 03	1
5	60011097000	GROUND CABLE L=470MM 03	1
6	60011059000	STARTERCABLE L=475MM LC8 03	1
7	60040009000	RUBBER CAP STARTER PORT 03	1
8	60011053000	BATTERY 12V/11AH 03	1
9	0014060103	HH COLLAR SCREW M 6X10 WS=8	2
10	0934060003	HEXAGON NUT DIN0934-M 6	2
11	60111059000	BATTERY CABLE 250MM 06	1
12	60111097000	GROUND CABLE 100MM 06	1
13	0016050121	SCREW FOR PLASTIC 50X12	4
14	58411053050	BATTERY COVER 96	1
20	60011054007	BATTERY BOX TOP PART 03	1
21	60011054000	BATTERY BOX 03	1
22	60011054006	BATTERY BOX FRONT PART 03	1
23	0017060203	EJOT PT SCREW K60X20 WS=6	2
24	60111056000	BRACKET STARTER RELAY 06	1
25	60011055000	BRACKET VOLTAGE REGULATOR 03	1
26	60011038000	CAGE NUT M6 SL K100-1 1,5MM	6
27	60038083000	SCREW OIL TANK FIXING 03	4
28	58111076000	CABLE SUPPORT KHS NR.150-47610	5
29	57013072100	WIRING HOLDER 16MM	2
30	60011034000	VOLTAGE REGULATOR LC8 03	1
31	0015060303	HH COLLAR SCREW M 6X30 WS=8	2
35	60111048000	POSITIVE POL EXTENSION 06	1
36	60111048020	HEXAGON NUT M6 SW=13 L=20	1
37	60111048035	COVER CAP OUTER 06	1

066011105 / C07601105

* NEW PART

X AS REQUIRED

HAND BRAKE CYLINDER

990 ADVENTURE ORANGE ABS EU 2007

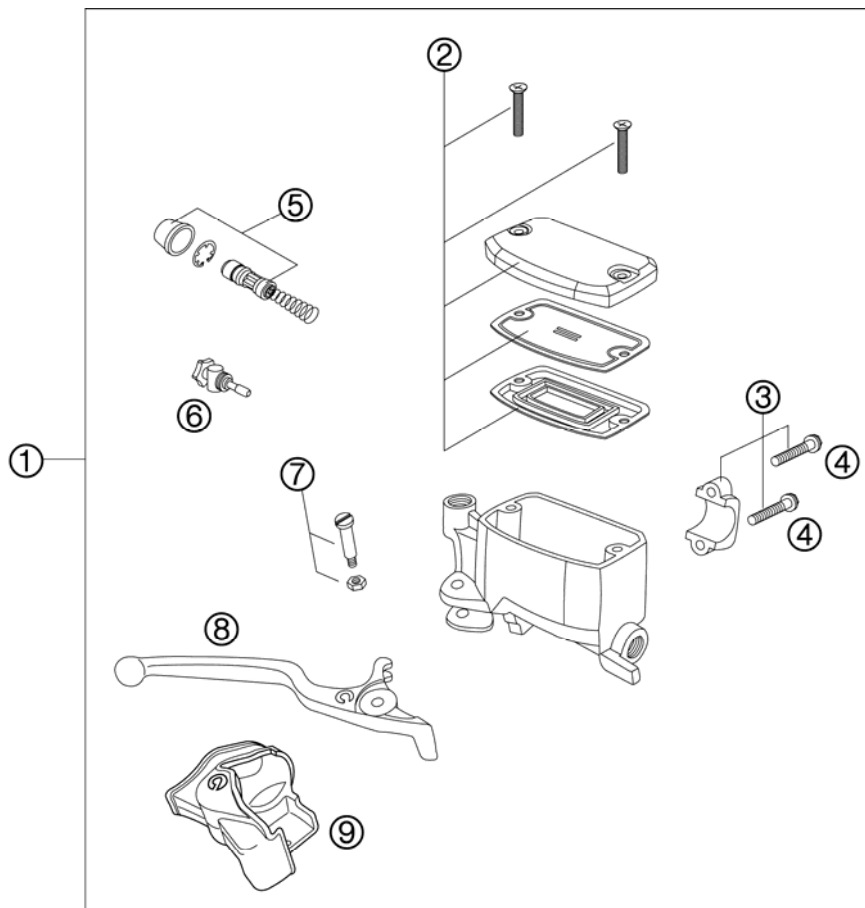

FIG	PART NUMBER	DESCRIPTION	QTY
1	60013001000	HAND BRAKE CYLINDER 03	1
2	60013003000	HAND BRAKE CYL. COVER CPL. 03	1
3	60013005000	CLAMP CPL. 03	1
4	0015060253	HH COLLAR SCREW M 6X25 WS=8	2
5	60013008000	REP.SET PISTON LC8 ADV 03	1
6	60013007000	ADJUSTING SCREW CPL. LC8 ADV	1
7	60013006000	LEVER SCREW CPL. 2003	1
8	60013002000	HAND BRAKE LEVER 2003	1
9	60013004000	PROTECTION CAP HAND BRAKE CYL.	1
11	60142010000	BRAKE HOSE L=1320MM 06	1
12*	0603100141	COPPER GASKET DIN7603-10X14X1	2
13	50213025000	HOLLOW SCREW M10X1X19	1
80*	00062030000	BRAKE FLUID DOT 5.1	1

076011300 / C076011300

* NEW PART

X AS REQUIRED

REAR BRAKE CONTROL

990 ADVENTURE ORANGE ABS EU 2007

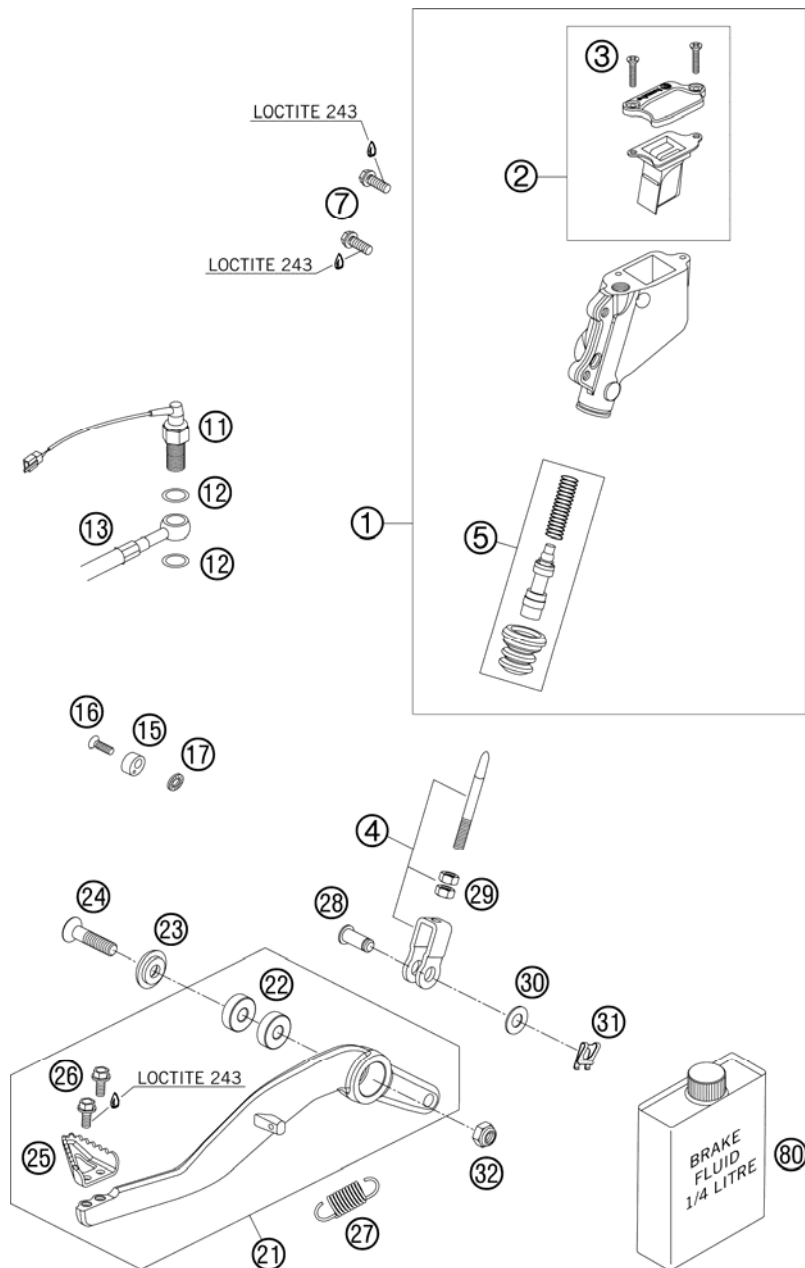

FIG	PART NUMBER	DESCRIPTION	QTY
1*	60013060200	MAIN BRAKE CYLINDER CPL. 07	1
2*	60013059100	COVER MAIN BRAKE CYLINDER CPL.	1
3	0965040161	FLAT HEAD SCREW DIN0965-M 4X16	2
4*	63013056044	PUSH ROD CPL. 06	1
5	60013061000	REPAIR KIT PISTON 03	1
7	59009062016	SPECIAL SCREW M6X16 WS=8 10.9	2
11	50311051100	BRAKE LIGHT SWITCH REAR '98	1
12*	0603100141	COPPER GASKET DIN7603-10X14X1	2
13	60142012000	BRAKE HOSE L=745MM 06	1
15*	58413048000	BRAKE LEVER STOP LC4 03	1
16*	0991060203	FLAT H.SCREW DIN7991-M6X20 8.8	1
17*	0797060003	TOOTH LOCK WASH. DIN6797-A 6,4	1
21*	6001305004401S	FOOT BRAKE LEVER CPL. 07	1
22	0625006087	GROOVED BALL BEAR. 608 2RS C3	2
23	60003061000	SPECIAL WASHER ALU 8X24MM 03	1
24	0991080353	FLAT HEAD SCREW DIN7991-M 8X35	1
25	60013051000	STEP PLATE FOOT BRAKE LEVER 03	1
26	0015050123	HH COLLAR SCREW M 5X12 WS=8	2
27	54603062000	RETURN SPRING FOR BRAKE LEVER	1
28	60013057000	BOLT F. LINK FORK 8X20X16,5	1
29	0934060003	HEXAGON NUT DIN0934-M 6	2
30	0125080003	WASHER DIN0125-A 8,4	1
31	60013058000	SECURING CLIP D=8MM 03	1
32	0985080003	SELF LOCKING NUT DIN0985-M 8	1
80*	00062030000	BRAKE FLUID DOT 5.1	1

076011310 / C076011310

* NEW PART

X AS REQUIRED

BRAKE CALIPER FRONT

990 ADVENTURE ORANGE ABS EU 2007

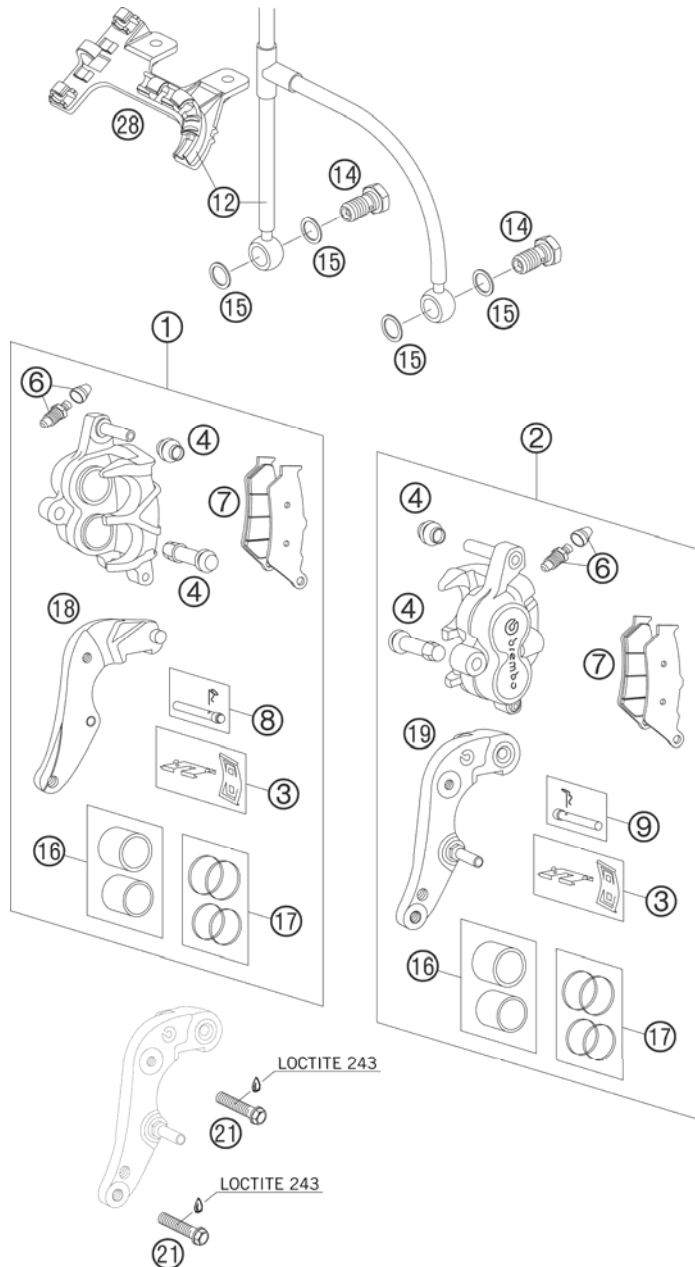

FIG	PART NUMBER	DESCRIPTION	QTY
1	60113016000	BRAKE CALIPER FRONT R/S 06 WITH BRAKE CALIPER SUPPORT	1
2	60113015000	BRAKE CALIPER FRONT L/S 06 WITH BRAKE CALIPER SUPPORT	1
3	60013018000	RETAINING PLATE SET FRONT 03	2
4	54613218000	CUP SET SHORT	2
6	60013020000	BLEEDER SCREW WITH CAP	2
7	60013030000	BRAKE PAD SET FR.TT2172HHA '03	2
8	60013017100	BOLT SET R/S	1
9	60013017000	BOLT SET L/S	1
12	60142011000	BRAKE HOSE 1190/715/810MM 06	1
14	50213025000	HOLLOW SCREW M10X1X19	2
15*	0603100141	COPPER GASKET DIN7603-10X14X1	4
16	60013083000	BRAKE PISTONS	2
17	60013019000	REP.KIT SEALING RINGS 30/32MM	2
18	60113049000	BRAKE CALIPER SUPPORT FR. R/S WITH RETAINING PLATE	1
19	60113049100	BRAKE CALIPER SUPPORT FR. L/S WITH RETAINING PLATE	1
21	0015080353	HH COLLAR SCREW M 8X35 WS=10	4
28	60101078000	BRAKE HOSE GUIDE LOWER 06	1

066011320 / C076011320

* NEW PART

X AS REQUIRED

BRAKE CALIPER REAR

990 ADVENTURE ORANGE ABS EU 2007

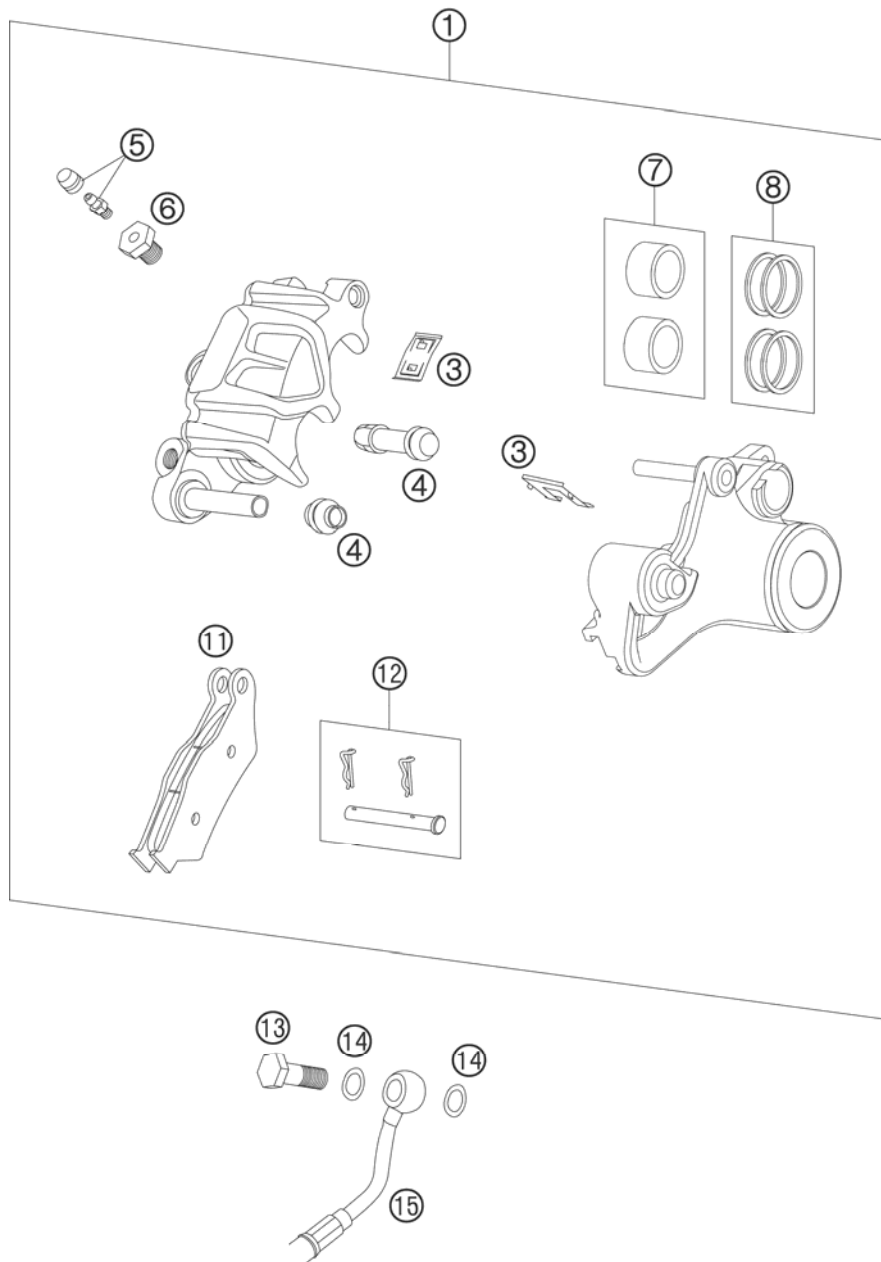

FIG	PART NUMBER	DESCRIPTION	QTY
1	6011308000	BRAKE CALIP.REAR "TT2701HH" 06	1
2	60013018100	RETAINING PLATE SET REAR 03	1
3	54613218000	CUP SET SHORT	1
4	60013020200	BLEEDER SCREW WITH CAP M6	1
5	60013020100	ADAPTER SCREW	1
6	60013083200	BRAKE PISTONS 05	1
7	60013081000	REP.KIT SEALINING RINGS	1
8	50313030200	BRAKEP.SET FR.TOSHIBA TT2701HH	1
9	60013017200	BOLT SET	1
10	50213025000	HOLLOW SCREW M10X1X19	1
11*	0603100141	COPPER GASKET DIN7603-10X14X1	2
12	60142013000	BRAKE HOSE L=1060MM 06	1

066011330 / C076011330

* NEW PART

X AS REQUIRED

LIGHTING SYSTEM

990 ADVENTURE ORANGE ABS EU 2007

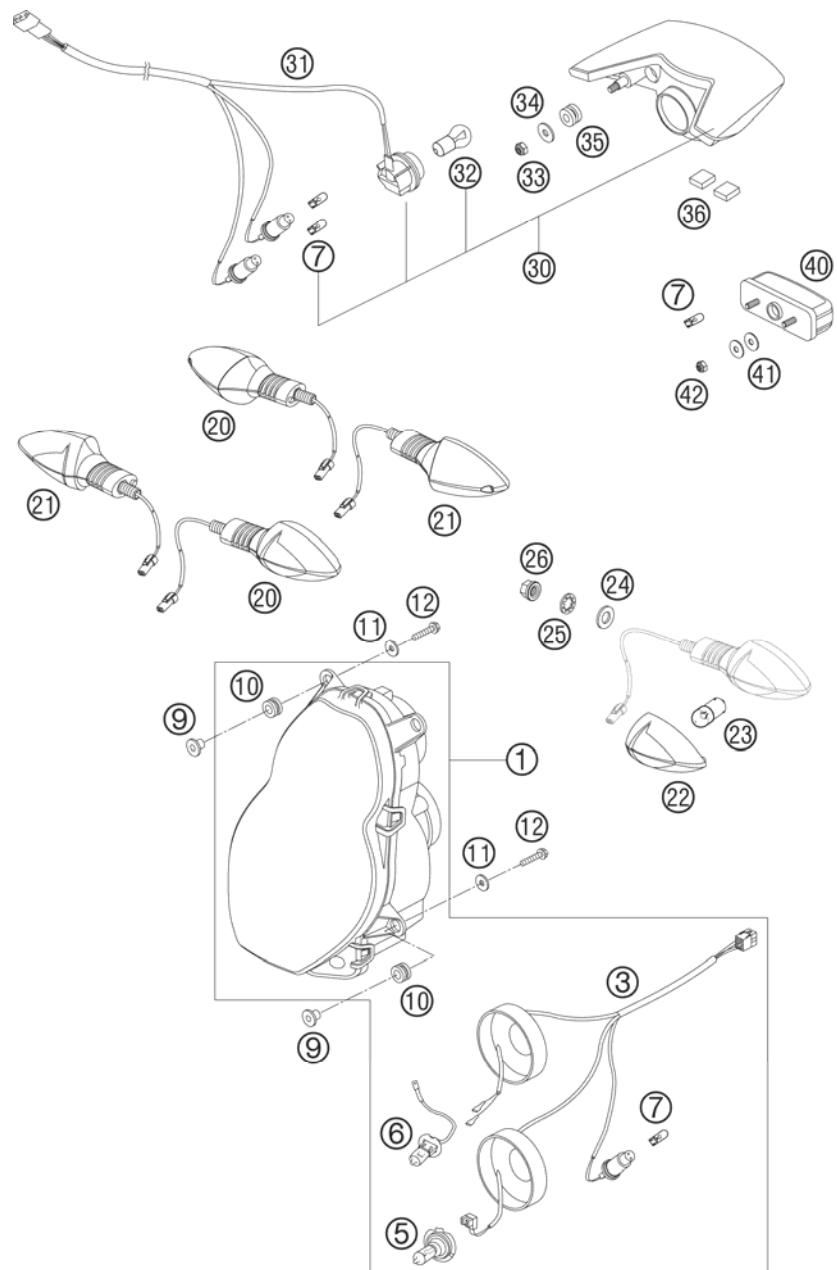

FIG	PART NUMBER	DESCRIPTION	QTY
1	60014001000	HEAD LIGHT RIGHT TR. EU 03	1
3	60014001050	HEAD LIGHT WIRING HAR. EU/GB	1
5	60014003100	BULB H7 12V 55W	1
6	60014003000	BULB H3 12V 55W	1
7	49011435100	BULB 12V 5W (W2,1X9,5D) PHIL.	4
9	60014007000	SPACER BUSHING HEAD LIGHT 03	4
10	31008008000	RUBBER GROMMIT BLACK	4
11	0021050003	WASHER DIN9021-A 5,3	4
12	0016050253	SCREW FOR PLASTIC 03	4
20	60114025000	FLASHER CPL.FRONT L/S REAR R/S	2
21	60114026000	FLASHER CPL.FRONT R/S REAR L/S	2
22	60114028000	FLASHER LENS L/S R/S TRANSP.06	4
23	60114027000	BULB 12V ORANGE (RY10W)	4
24	0125100003	WASHER DIN0125-A10,5	4
25	0797100003	LOCK WASHER DIN6797-J10,5 ZI	4
26	58414030000	HH COLLAR NUT M10X1,25 WS=13	4
30	60014040000	REAR LIGHT CPL. 03	1
31	60011077000	WIRING HARNESS REAR LIGHT 05	1
32	60014048000	BULB 12V 21W	1
33	0985060003	SELF LOCK. NUT DIN0985-M 6	2
34	0021060003	WASHER DIN9021-A 6,4	2
35	58214069051	RUBBER GROMMET 16X10,8X3 02	2
36	60014040050	BUMP RUBBER 20X20X6 MM 03	2
40	58414047000	LICENSE-PLATE ILLUMINATION '98	1
41	0021050003	WASHER DIN9021-A 5,3	4
42	0985050003	SELF LOCKING NUT DIN0985-M 5	2

066011400 / C076011400

* NEW PART

X AS REQUIRED

COCKPIT SUPPORT, SPEEDOMETER

990 ADVENTURE ORANGE ABS EU 2007

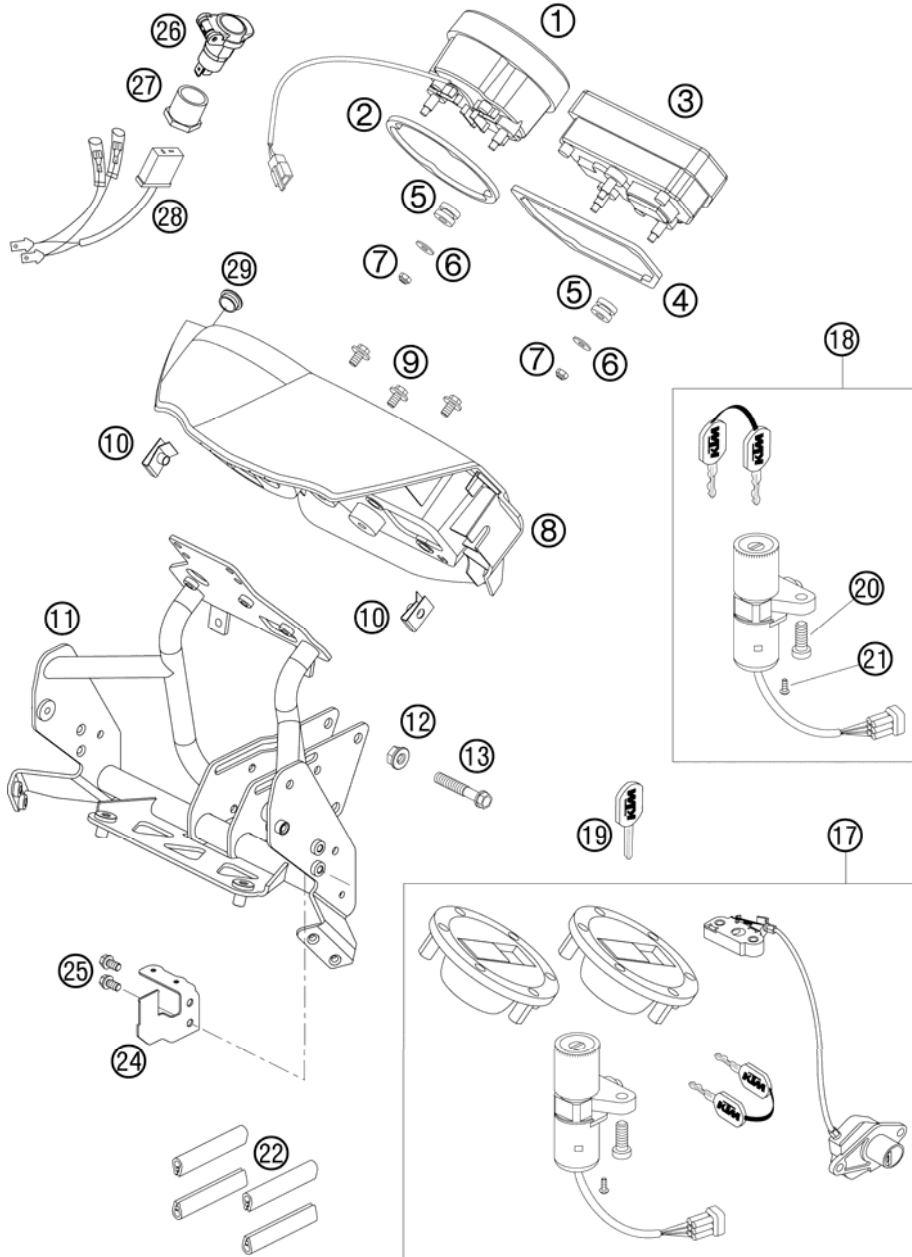

FIG	PART NUMBER	DESCRIPTION	QTY
1	60014075000	REV COUNTER LC8 03	1
2	60014068100	DAMPING RING SPEEDOMETER 03	1
3	61014069000	DIGITAL SPEEDOMETER 05	1
4	60014068000	DAMPING RING TACHOMETER 03	1
5	58214069051	RUBBER GROMMET 16X10,8X3 02	5
6	0021050003	WASHER DIN9021-A 5,3	5
7	0985050003	SELF LOCKING NUT DIN0985-M 5	5
8*	60114070100	INSTRUMENTS COVER ABS 07	1
9	0014060103	HH COLLAR SCREW M 6X10 WS=8	3
10	54603048100	RANGE CHANGE METAL NUT M6	2
11	60114010000	COCKPIT SUPPORT 06	1
12	54310086200	SELF LOCKING NUT M8 10.9	2
13	0015080453	HH COLLAR SCREW M 8X45 WS=10	2
17	60011066044	LOCK SYSTEM LC8 ADV. 03	1
18	60011066000	IGNITION LOCK LC8 ADV. 03	1
19	40011166100	KEY BLANK LC4/DUKE/LC8	x
20	60011064000	TAMPERPROOF SCREW F. IGN. LOCK	2
21	0985040123	FLAT HEAD SCREW DIN7985-M 4X12	2
22	60114010070	EDGE PROTECTOR 14X9,5X66 MM 06	4
24*	60103001166	SUPPORT ROLLOVER SENSOR 06	1
25	0015060103	HH COLLAR SCREW M 6X10 WS=8	2
26*	60111042000	SOCKET 07	1
27*	60111042050	NUT FOR SOCKET 07	1
28*	60111042060	CABLE FOR SOCKET 07	1
29*	60114071000	PLUG FOR SOCKET/INSTR. COVER	1

076011405 / C076011405

* NEW PART

X AS REQUIRED

SPECIAL TOOLS

990 ADVENTURE ORANGE ABS EU 2007

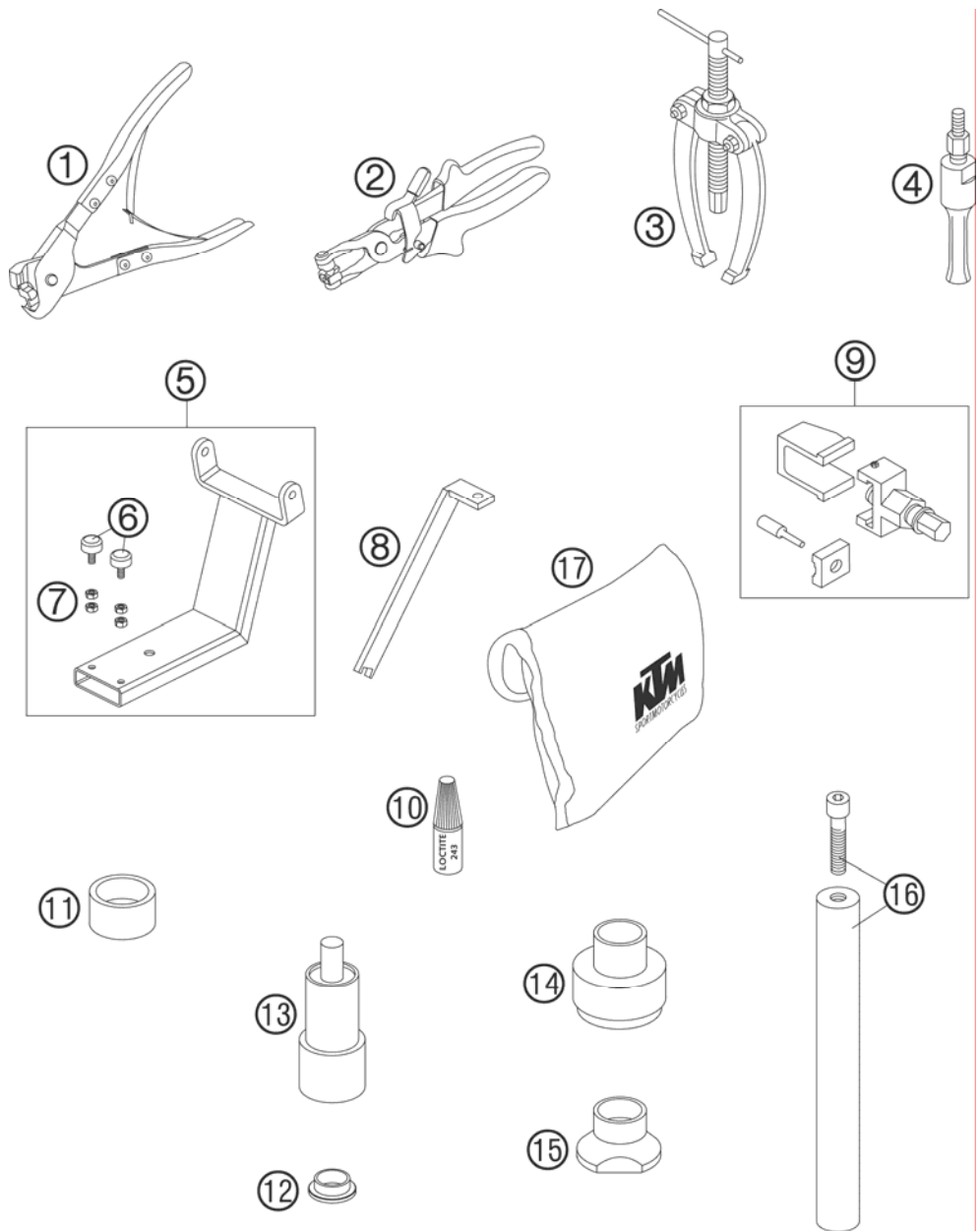

FIG	PART NUMBER	DESCRIPTION	QTY
1	60029057000	PLIERS F. VAR.ONE-EAR CLAMP 03	1
2	60029057100	PLIERS F. CLAMP 03	1
3	15112017000	BUSHING EXTRACTOR	1
4	60029018000	INTERN.BEAR.PULLER 28 MM	1
5	60029055100	ATTACHMENT WHEELED JACK 03	1
6	58303070000	STOP RUBBER M8	2
7	09340800003	HEXAGON NUT DIN0934-M 8	4
8	60029055000	HOLDER CENTER STAND 03	1
9*	58429020000	RIVET TOOL LC4	1
10	6899785	LOCTITE 243 BLUE 6CCM	1
11	60029056000	ANVIL DOLLY 03	1
12	60010013000	SPACER BUSH. REAR WHEEL R/S 03 FOR SWINGARM BEARING	1
13	58429086000	PRESS. TOOL F. LINK BEAR. LC4	1
14	58429091000	MOUNT.TOOL STEER.HEAD BEAR.LC4	1
15	58429092000	DISMOUNT. TOOL F. BEARINGS LC4	1
16	58429089000	HOLDING TOOL CHASSIS LC4	1
17	61029099000	TOOL SET 950/990 05	1

066011900 / C076011900

* NEW PART

X AS REQUIRED



FIG	PART NUMBER	DESCRIPTION	QTY
0	00063099111	BAG FOR INSTRUCTION MANUAL	1
0	312305	DOCUMENTS BAG 2006	1
0	312313	KTM BALLPOINT ORANGE	1
0	3210039	CUSTOMER WELCOME LETTER	1
0	3211149	OWN. MANUAL 990 ADVENTURE/S 07	1

070002000 / C076012000

* NEW PART

X AS REQUIRED

ANTIBLOCK SYSTEM ABS

990 ADVENTURE ORANGE ABS EU 2007

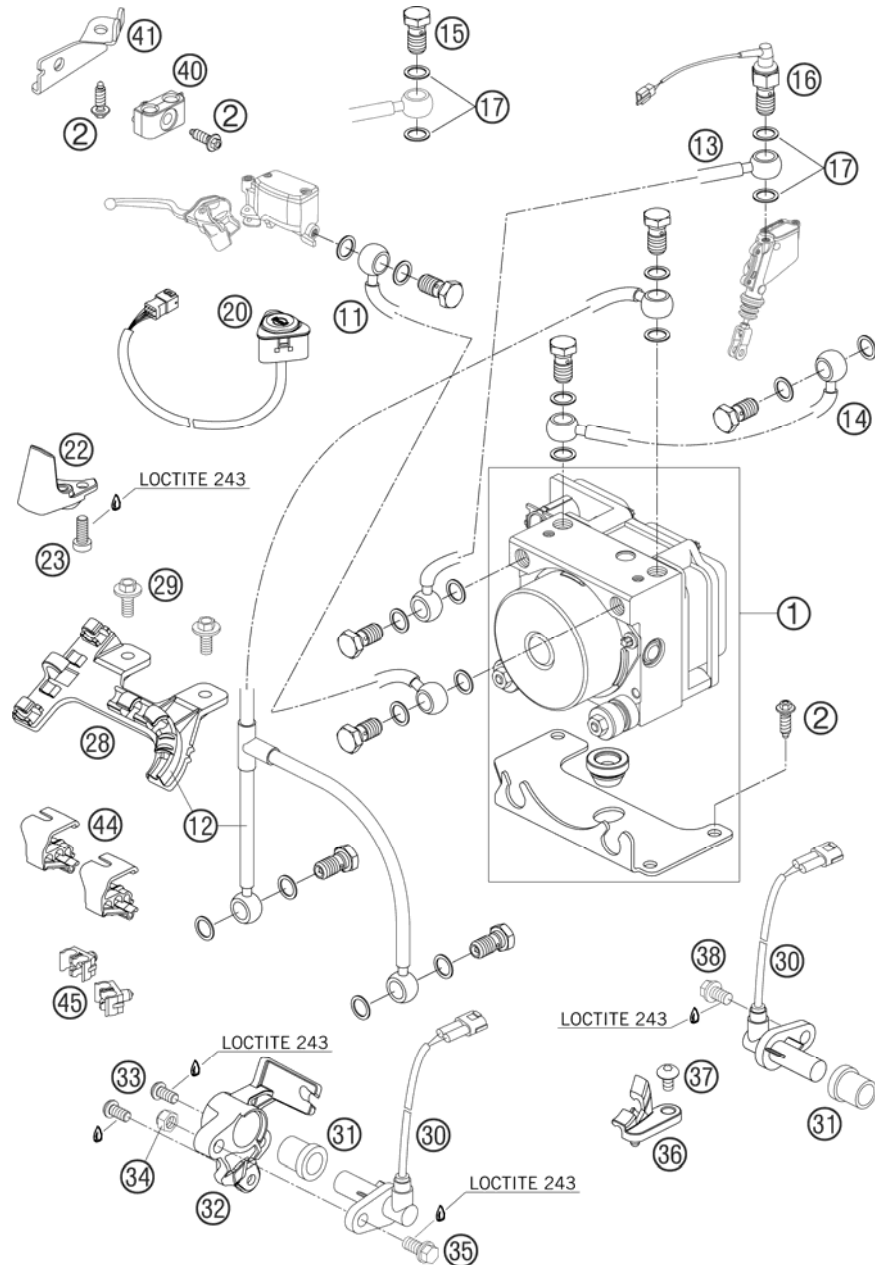

FIG	PART NUMBER	DESCRIPTION	QTY
1	60142031144	ABS MODULE INCL. SUPPORT	1
2	0017060203	EJOT PT SCREW K60X20 WS=6	5
11	60142010000	BRAKE HOSE L=1320MM 06	1
12	60142011000	BRAKE HOSE 1190/715/810MM 06	1
13	60142012000	BRAKE HOSE L=745MM 06	1
14	60142013000	BRAKE HOSE L=1060MM 06	1
15	50213025000	HOLLOW SCREW M10X1X19	7
16	50311051100	BRAKE LIGHT SWITCH REAR '98	1
17*	0603100141	COPPER GASKET DIN7603-10X14X1	18
20	60142070000	SWITCH ABS 06	1
22	60101077000	BRAKE HOSE GUIDE TOP 06	1
23	0012060164	AH SCREW DIN912 M6X16 SL	1
28	60101078000	BRAKE HOSE GUIDE LOWER 06	1
29	0014060153	HH COLLAR SCREW M 6X15 WS=8	2
30	60142025000	ABS-SENSOR 06	2
31	60142024050	SLEEVE SENSOR HOLDER ABS	2
32	60142024000	SENSOR HOLDER FRONT 06	1
33	0018050103	INT. TORX OVAL HEAD M 5X10 8.8	2
34	0985060003	SELF LOCK. NUT DIN0985-M 6	1
35	0015060163	HH COLLAR SCREW M 6X16 WS=8	1
36	60142026000	CABLE SUPPORT SWING ARM 06	1
37	58605083010	SCREW TORX M5X10 05	1
38	59009062013	SPECIAL SCREW M6X13 WS=8 10.9	1
40	60113046000	SUPPORT FOR BRAKE HOSE 06	1
41	60113045000	SUPPORT FOR BRAKE HOSE REAR 06	1
44	60113047000	SUPPORT FOR BRAKE HOSE REAR 06	2
45	60113026000	HOSE SUPPORT 7/7 MM 06	2

066014200 / C076014200

* NEW PART

X AS REQUIRED



KTM-Sportmotorcycle AG
A-5230 Mattighofen
www.ktm.at

KTM Group Partner



3CF9803G5EN



Art.Nr.: 3CF9803G5EN 11/2006