





990 SUPERMOTO T ORANGE EU 2010

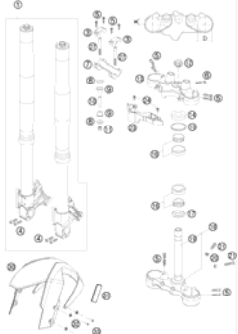
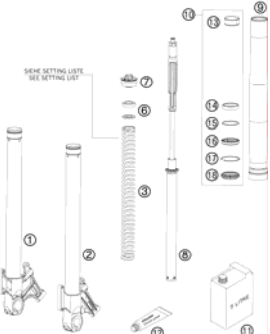
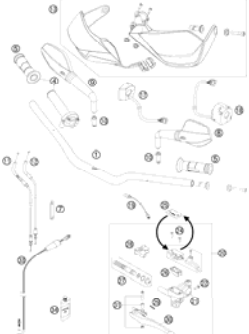

SPARE PARTS MANUAL: CHASSIS

ART.NO.: 3CF9803J9EN

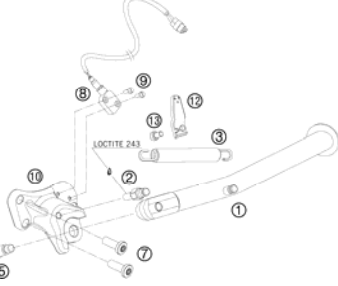
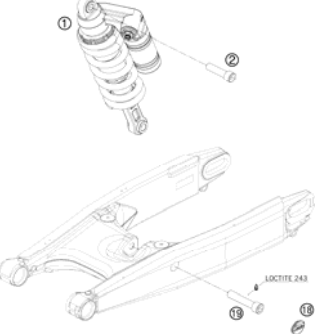
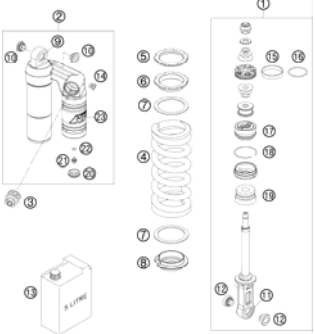
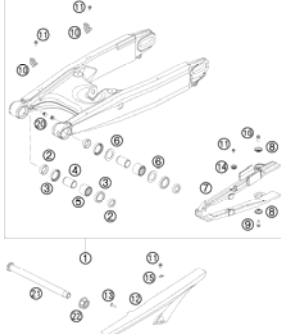
ENGLISH

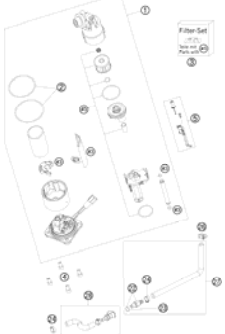
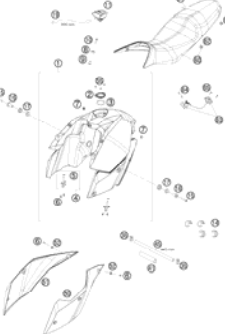

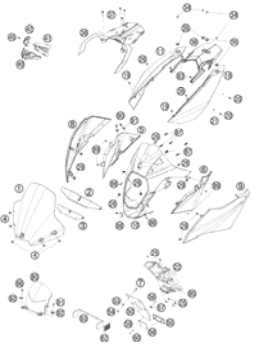
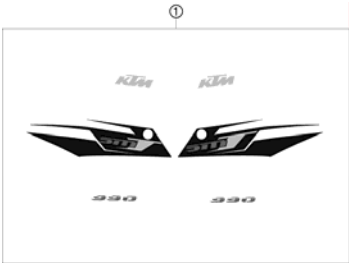
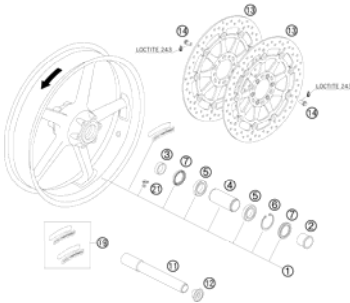
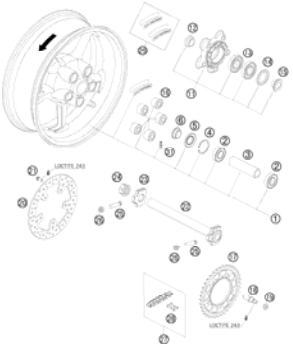
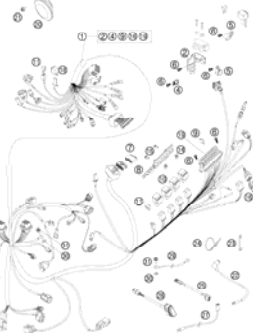
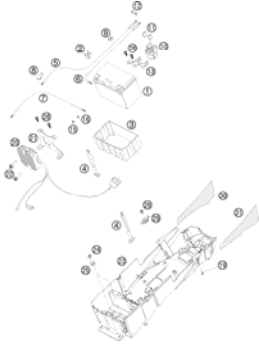
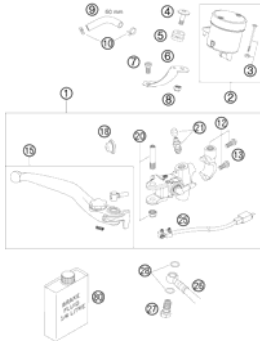
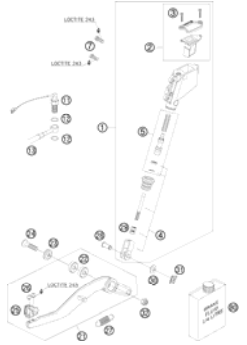
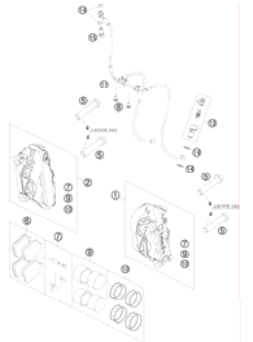
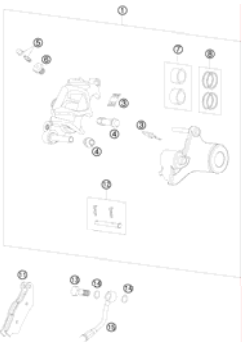
<p>FRONT FORK, TRIPLE CLAMP</p>  <p>4</p>	<p>FRONT FORK DISASSEMBLED</p>  <p>5</p>	<p>HANDLEBAR, CONTROLS</p>  <p>6</p>	<p>FRAME</p>  <p>7</p>
<p>SIDE STAND</p>  <p>9</p>	<p>MONOSHOCK</p>  <p>10</p>	<p>SHOCK ABSORBER DISASSEMBLED</p>  <p>11</p>	<p>SWING ARM</p>  <p>12</p>
<p>EXHAUST SYSTEM</p>  <p>13</p>	<p>AIR BOX</p>  <p>14</p>	<p>FUEL PUMP</p>  <p>15</p>	<p>TANK, SEAT, COVERS</p>  <p>16</p>

MASK, FENDERS  17	DECAL  19	FRONT WHEEL  20	REAR WHEEL  21
WIRING HARNESS  22	BATTERY  23	HAND BREAK CYLINDER  24	REAR BRAKE CONTROL  25
BRAKE CALIPER FRONT  26	BRAKE CALIPER REAR  27	LIGHTING SYSTEM  28	INSTRUMENTS / LOCKSYSTEM  29

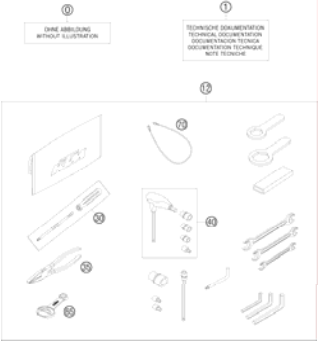
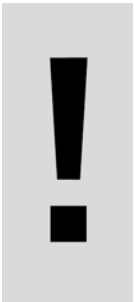
<p>ACCESSORIES KIT</p>  <p>30</p>			
	<div style="display: flex; align-items: center;">  <p>All information contained is without obligation. KTM-Sportmotorcycle AG particularly reserves the right to modify any equipment, technical specifications, prices, colors, shapes, materials, services, service work, constructions, equipment and the like so as to adapt them to local conditions or to cancel any of the above items, all without previous announcement and without giving reasons. KTM may stop manufacturing certain models without previous notice. KTM shall not be held liable for any deviations of availability and/or ability to deliver, illustrations, descriptions, printing and/or other errors. The illustrated models partly contain extra equipment, which is not applied to standard models. © by KTM-SPORTMOTORCYCLE AG, Mattighofen AUSTRIA; All rights reserved; Reprint, also in extracts, with written allowance of KTM-SPORTMOTORCYCLE AG, Mattighofen only.</p> </div>		

FRONT FORK, TRIPLE CLAMP

990 SUPERMOTO T ORANGE EU 2010

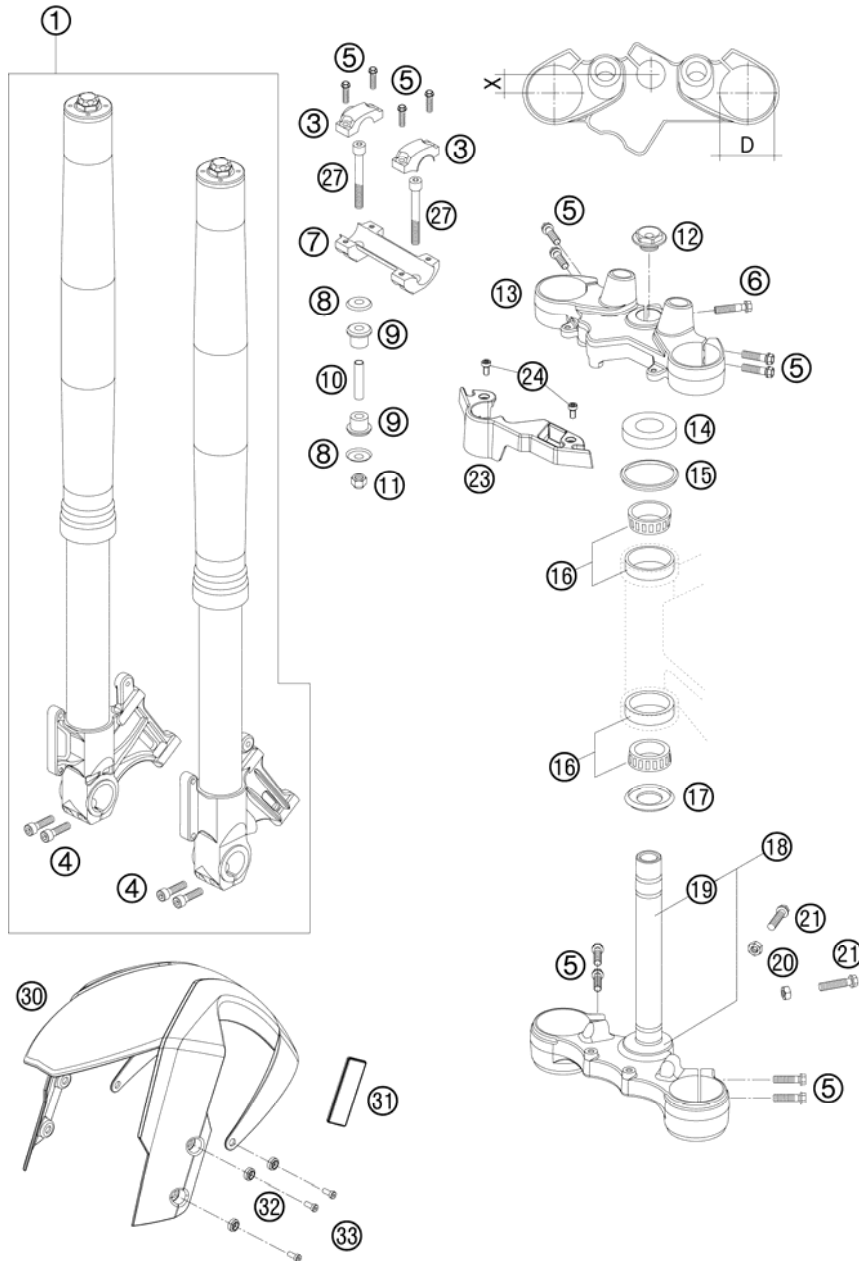

FIG	PART NUMBER	DESCRIPTION	QTY
1	14187E4301	FRONT FORK WP SM-T 2009	1
3	5900103830001S	HANDLEBAR CLAMP 28MM 07	2
4	0912080303	AH SCREW DIN0912-M 8X30	4
5	0035080306	AH-COLLAR SCREW M8X30 ISA45	12
6	0035080356	AH-COLLAR SCREW M8X35 ISA45	1
7	5900103920001S	HANDLEBAR SUPPORT 28MM 07	1
8	56401042000	WASHER 10,5X32X2	4
9	56401040000	RUBBER BUSHING	4
10	56401041100	SPACER TUBE 10,2X12X44	2
11	0982100003	SELF LOCK.NUT DIN0982-M10 HIGH	2
12	54801036200	STEER.HEAD SCREW M20x1,5 SW=27	1
13	6250103402633S	TOP TRIPLE CLAMP	1
14	61001086000	STEERING HEAD COVER 05	1
15	54601184000	STEERING HEAD GASKET TOP	1
16	54201081100	TAPERED ROLLER BEARING CPL. 06	2
17	54601084100	O-RING SUPPORT W. SEALING LIP	1
18	6250103202633S	BOTTOM TRIPLE CLAMP CPL.	1
19	60001033000	FORK TUBE LC8 ADV 03	1
20	0934080003	HEXAGON NUT DIN0934-M 8	2
21	0933080303	HH SCREW DIN0933-M 8X30	2
23	62001070000	CABLE GUIDE	1
24	014580060126	CYL. SCREW DIN14580 M 6X12	2
27	0984100703	AH SCREW DIN0912-M10X70	2
30	6110801000030	FRONT FENDER BLACK 07	1
31	58412080100	REFLECTOR YELLOW '99	2
32	61108045000	SPECIAL WASHER	6
33	014580060166	CYL. SCREW DIN14580 M 6X16	6

096200110 / C096200110

* NEW PART

X AS REQUIRED

FRONT FORK DISASSEMBLED

990 SUPERMOTO T ORANGE EU 2010

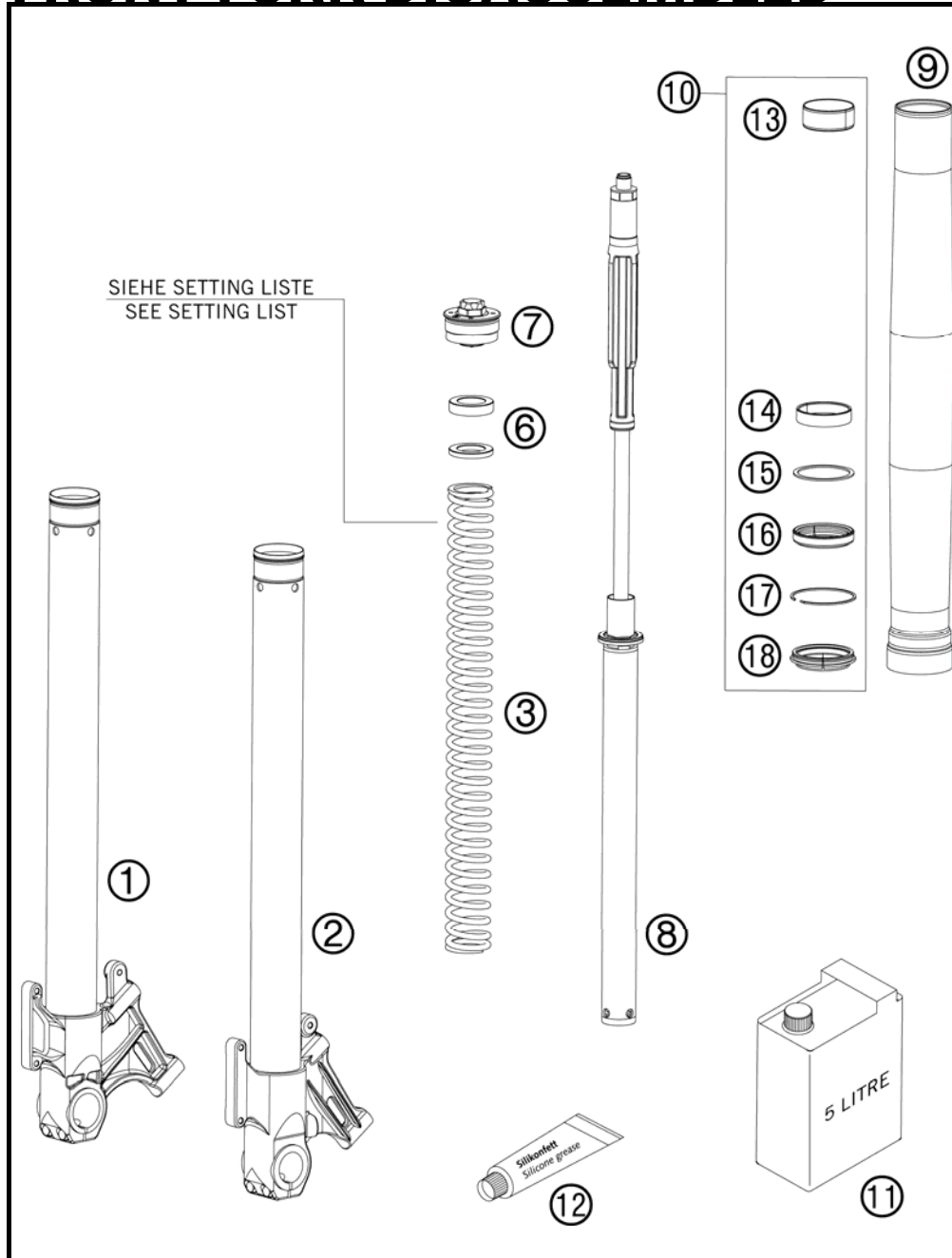

FIG	PART NUMBER	DESCRIPTION	QTY
1	48600685S4	AXLE CLAMP R/S CPL. 09	1
2	48600686S4	AXLE CLAMP L/S CPL. 09	1
3	91410066S	SPRING D43,2 L450 6,2N/MM D5,5	x
3	91410067S	SPRING D43.2 L450 6.5N/MM D5.5	x
3	91410075S	SPRING	1
6	48600036	SPACER 42X26,5X2,5	2
6	48600037	SPACER 42X26,5X5	2
6	48600053	SPACER 42X26,5X1,5	2
7	48600431S	PRE-LOAD ADJ. CPL. M51X1,5 05	2
8	48600839S1	CARTRIDGE CPL. 990 SM-R 2009	1
9	48600712	OUTER TUBE L610 D54/D60 2L ROA	2
10	R14017	REPAIR-KIT GASKET 09	1
11	48600765S1	FORK OIL SAE5 5L 2008	1
12	T511	SILICONE GREASE F. DUST STRI	1
13	48600428	DU-BUSH D47XD49X20DDL02	2
14	48600429	DU-BUSH D48XD52X12DDL02	2
15	48600013	SUPPORT RING 50 X 57,6 X 1,5	2
16	48600399	OIL SEAL RING 48X57,8X9,5	2
17	48600070	LOCK WASHER SB58	2
18	48600816	DUST SEAL	2

086250130 / C096200130

* NEW PART

X AS REQUIRED

HANDLEBAR, CONTROLS

990 SUPERMOTO T ORANGE EU 2010

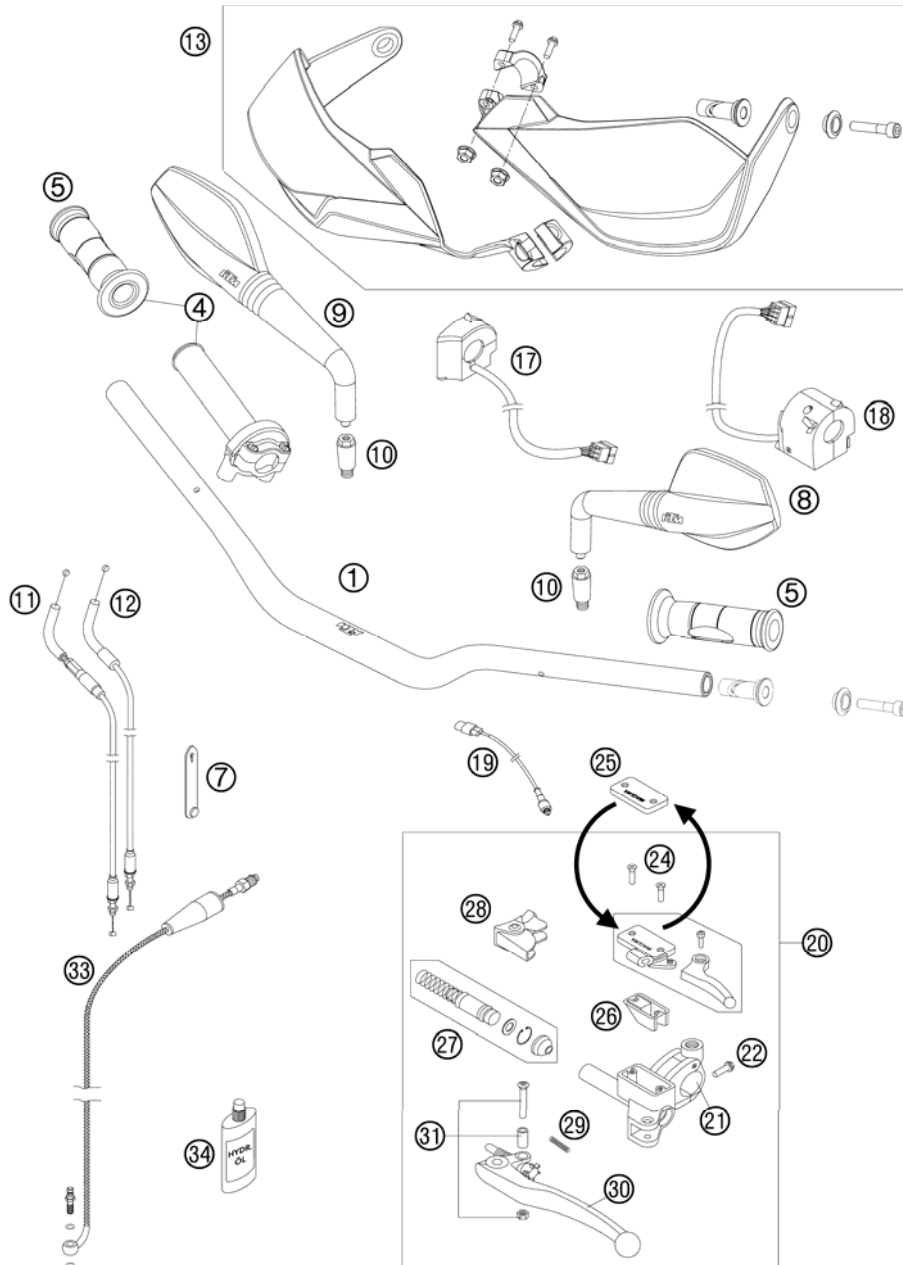

FIG	PART NUMBER	DESCRIPTION	QTY
1	62602001000	HANDLEBAR 990 SM	1
4	61002010000	THROTTLE GRIP 05	1
5	61002021000	GRIPP SET	1
7	60011093045	RUBBER CABLE TIE 45MM 03	x
8	61112040000	REVIEW MIRROR L/S 07	1
9	61112041000	REVIEW MIRROR R/S 07	1
10	58412040050	SUPPORT FOR MIRROR LC4 '98	2
11	62502091000	THROTTLE CABLE OPEN 05	1
12	62502092000	THROTTLE CABLE CLOSE 05	1
13	6200207904430	HAND GUARDS CPL.L/S+R/S BLACK	1
17	62011074000	START-STOP SWITCH	1
18	60011070000	LIGHT SWITCH A.D. 03	1
19	62011049000	CLUTCH SWITCH 09	1
20	60002030000	MASTER CYLINDER MAGURA D=10.5	1
21	60002044000	CLAMP MIRROR WITH CLAMP	1
22	0035100309S	AH-COLLAR SCREW M10X30 ISA45	1
24	0965040123	FLAT HEAD SCREW DIN0965-M 4X12	2
25	50302033000	COVER FOR HYDR. CLUTCH '98	1
26	50302034000	RUBBER FOR RESERVOIR '98	1
27	50302032000	REP.SET PISTON MAGURA D=10.5	1
28	50302037000	PROTECT.CAP FOR LEVER PERCH'98	1
29	59002035000	SPRING FOR CLUTCH LEVER 03	1
30	60002031000	CLUTCH LEVER LONG CPL. 2003	1
31	50302038000	LEVER SCREW CPL. 125-200 '98	1
33	60032063100	CLUTCH PIPE LC8 ADV '03	1
34	50302036200	OIL FOR HYD. CLUTCH 75ML	1

096200210 / C096200210

* NEW PART

X AS REQUIRED

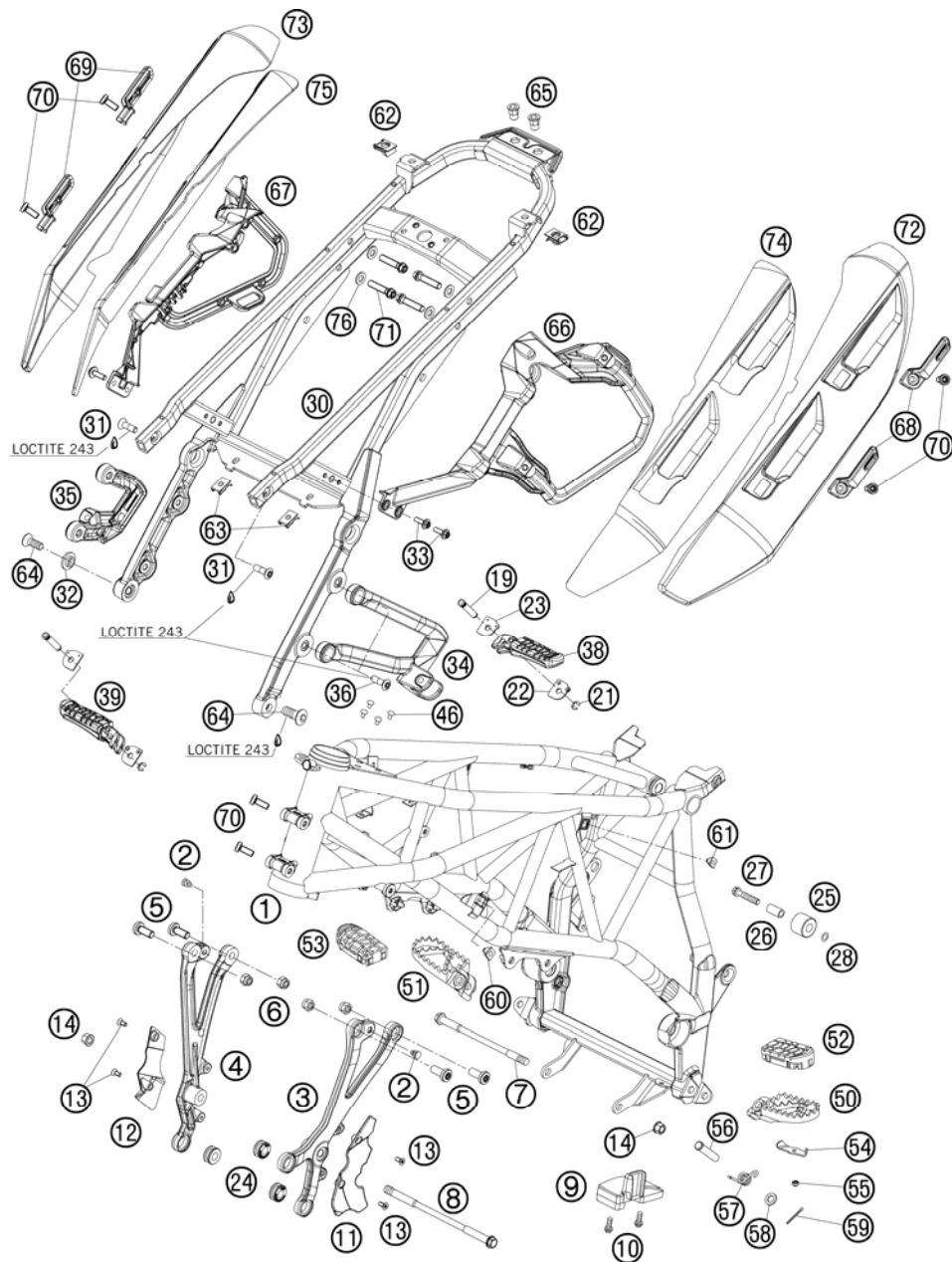

FIG	PART NUMBER	DESCRIPTION	QTY
1	6200300100033	FRAME "FH09" 990 SM-T SW 09	1
2	54403135000	PLASTIC CAP SFL10	2
3	6250300500033S	ENGINE SUPPORT L/S 07	1
4	6250300600033S	ENGINE SUPPORT R/S 07	1
5	0035100249	AH-COLLAR SCREW M10X24 ISA45	4
6	54310086100	SELF LOCKING NUT M10 CU WS=14	4
7	60003013000	ENGINE BRAC. SCREW M10X172 03	1
8	60003014000	ENGINE BRAC. SCREW M10X206 03	1
9	60004076100	CHAIN SLIDING BLOCK 05	1
10	0017060204	EJOT PT SCREW K60X20 ALU WS=6	2
11	62603005050	COVER ENGINE SUPPORT LEFT	1
12	62603006050	COVER ENGINE	1
13	0019050121	COUNTERSUNK SCREW ISA25 M5X12	4
14	54630044000	COLLAR NUT M10 WS=13	2
19	60003044000	BOLT FOR FOOTREST REAR 03	2
21	0799060003	TAB WASHER DIN6799-RS 6,0	2
22	60003152000	ENGAGE PANEL FOOTREST L/S 03	2
23	60003052000	ENGAGE PANEL FOOTREST R/S 03	2
24	60003098000	RUBBER SLEEVE 03	3
25	58403060000	CHAIN ROLL 12X29X22,5 '98	1
26	58403060065	BUSH CHAIN ROLL 8X12X23 '98	1
27	0025080406	HH COLLAR SCREW M8X40 TX40	1
28	36003014000	LOCK WASHER 8MM	1
30	6260300210092	SUB FRAME SM PLATIN	1
31	0019100289S	COUNTERSUNK SCREW ISA45 M10X28	2
32	60003001051	COLLAR BUSHING 10X15X25X4 03	1
33	0024060206	HH COLLAR SCREW M6X20 TX30	4
34	6250304800001S	FOOTREST BRACKET REAR L/S 07	1
35	6250304900001S	FOOTREST BRACKET REAR R/S 07	1
36	0019080266S	COUNTER-SUNK SCREW ISA45 M8X26	4
38	60003050000	FOOTREST CPL. L/S REAR 03	1
39	60003051000	FOOTREST CPL. R/S REAR 03	1
46	60103088000	PLUG ZK 8/5 06	4
50	59003040250	FOOT PEG L/S SILVER 02	1
51	59003041250	FOOT PEG R/S SILVER 02	1

096200310 / C096200310

* NEW PART

X AS REQUIRED

FRAME

990 SUPERMOTO T ORANGE EU 2010

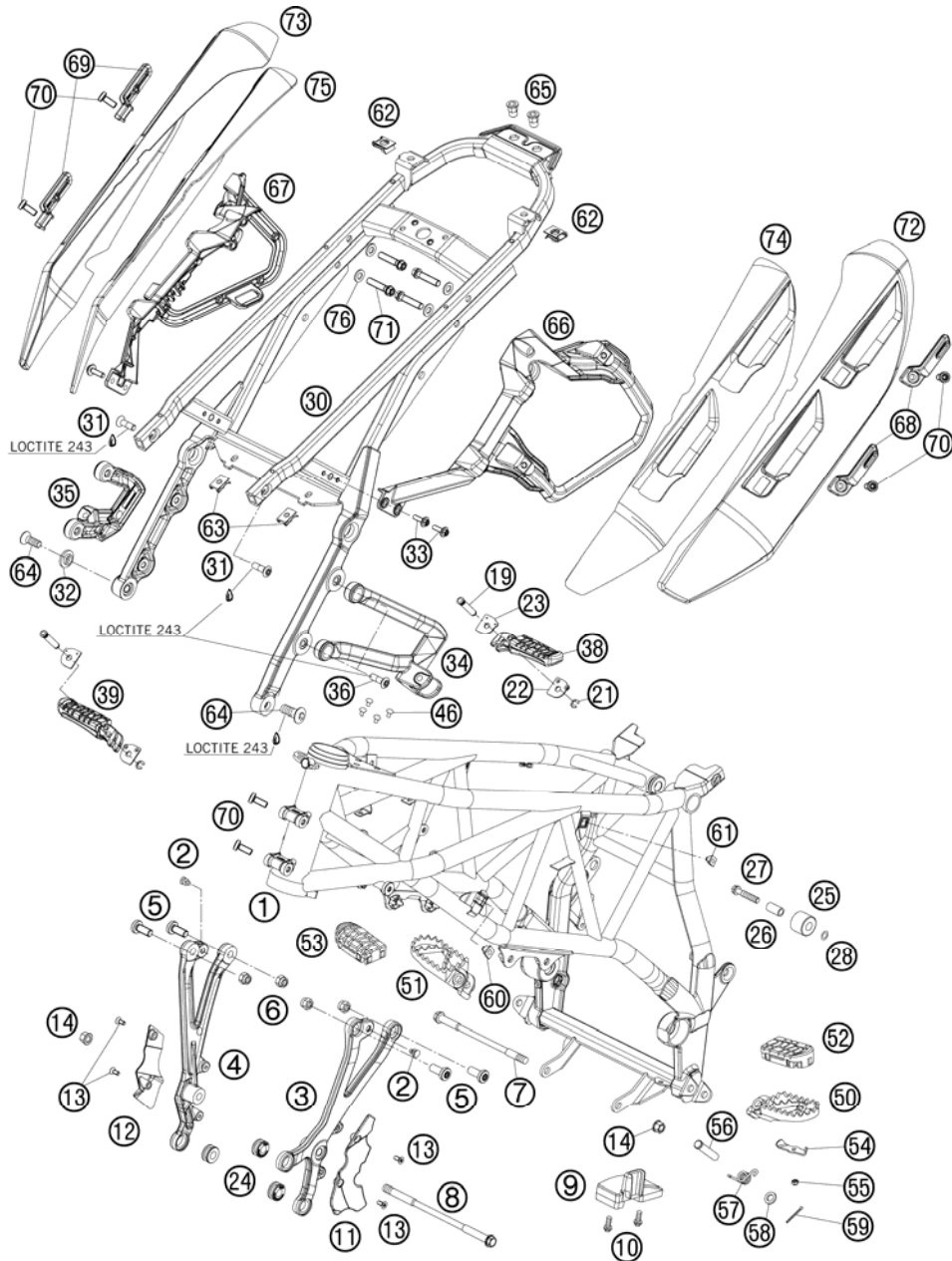

FIG	PART NUMBER	DESCRIPTION	QTY
52	60003040010	FOOTREST RUBBER FRONT L/S 03	1
53	60003041010	FOOTREST RUBBER FRONT R/S 03	1
54	60003044010	CLOSING PANEL FRONT L/S R/S 03	2
55	0985050003	SELF LOCKING NUT DIN0985-M 5	2
56	54803044000	BOLT FOR FOOT PED 03	2
57	54603041000	FOOTREST SPRING L/S & R/S	2
58	0125100003	WASHER DIN0125-A10,5	2
59	0094032253	PIN DIN0094-3,2X25 STEEL	2
60	60003095100	CAGE NUT M8	2
61	60011038000	CAGE NUT M6 SL K100-1 1,5MM	2
62	54603048000	RANGE CHANGE METAL NUT M8	2
63	54603048100	RANGE CHANGE METAL NUT M6	2
64	0019100239S	COUNTERSUNK SCREW ISA45 M10X23	2
65	61003002080	BLIND RIVET NUT M8 HUC/ROF 5 0	2
66	62008041050	SUPPORT SIDE PART L/S	1
67	62008042050	SUPPORT SIDE PART R/S	1
68	62008041070	BAG SUPPORT L/S CPL.	2
69	62008042070	BAG SUPPORT R/S CPL.	2
70	0035080206S	AH-COLLAR SCREW M8X20 ISA45	8
71	0025080356	HH COLLAR SCREW M8X35 TX40	4
72	62005090000	HEAT SHIELD L/S 09	1
73	62005091000	HEAT SHIELD R/S 09	1
74	62005090050	THERMAL PROTECTION FOIL L/S	1
75	62005091050	THERMAL PROTECTION FOIL R/S	1
76	0125080003	WASHER DIN0125-A 8,4	4

096200310 / C096200310

* NEW PART

X AS REQUIRED

SIDE STAND

990 SUPERMOTO T ORANGE EU 2010

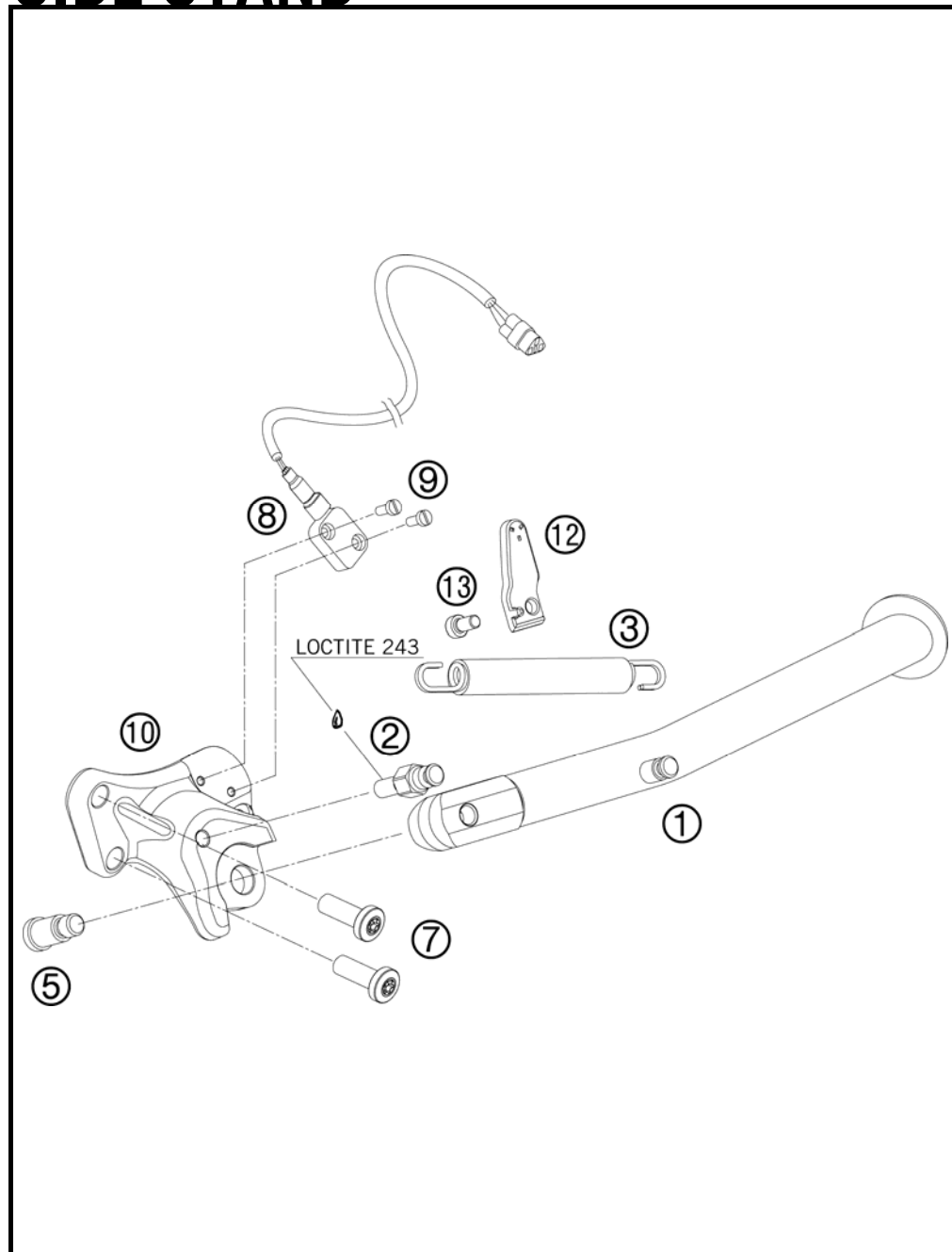

FIG	PART NUMBER	DESCRIPTION	QTY
1	6250302300033	SIDE STAND L=236MM 07	1
2	76503028001	SPECIAL SCR. SIDE STAND SPRING	1
3	61003024000	SPRING L=116 MM 05	1
5	62503027200	SCREW FOR SIDE STAND M10X31,2	1
7	0035100309S	AH-COLLAR SCREW M10X30 ISA45	2
8	61011045000	SIDE STAND SENSOR 05	1
9	0084040103	CYL.HEAD SCREW DIN84A M4x10	2
10	62603026000	SIDE STAND BRACKET	1
12	60103029050	MAGNET HOLDER ADV. 06	1
13	014580060126	CYL. SCREW DIN14580 M 6X12	1

096200360 / C096200360

* NEW PART

X AS REQUIRED

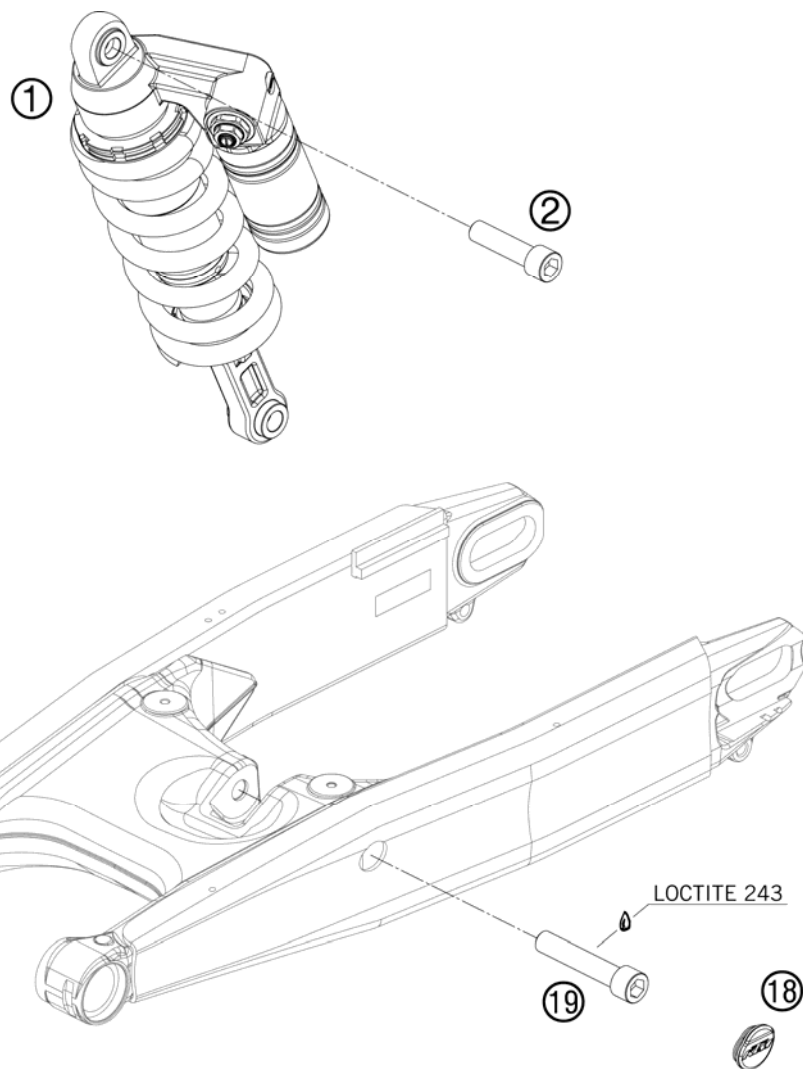

FIG	PART NUMBER	DESCRIPTION	QTY
1	15187E43	MONOSHOCK 990 SUPERMOTO T 09	1
2	60004016000	SCREW M14X1,5 L=55MM 03	1
18	60004041000	PLUG SWINGARM 03	1
19	60004017000	SCREW M14X1,5 L=73MM 03	1

096200410 / C096200410

* NEW PART

X AS REQUIRED

SHOCK ABSORBER DISASSEMBLED

990 SUPERMOTO T ORANGE EU 2010

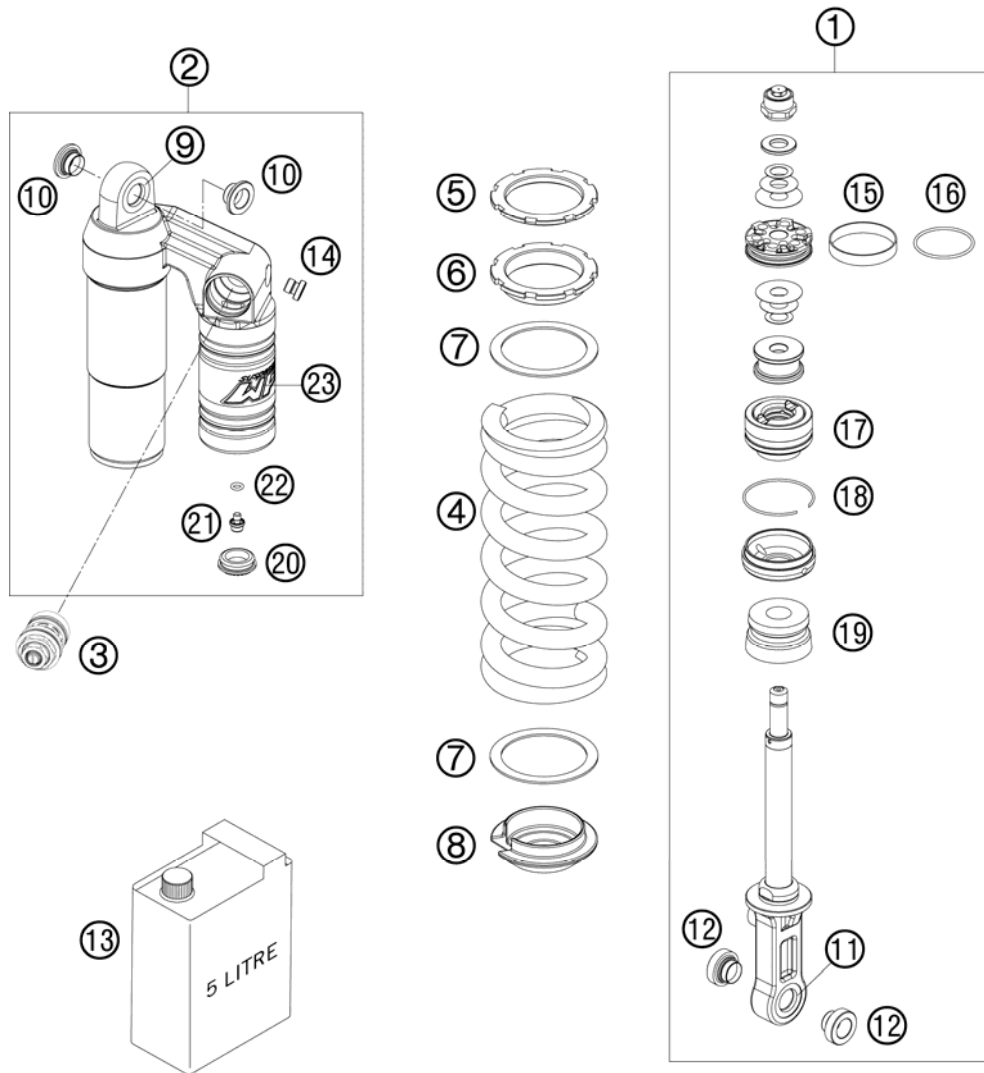

FIG	PART NUMBER	DESCRIPTION	QTY
1	46180654SA10	SHOCK ABS. BOTTOM 990 SM-T 09	1
2	46180834SA	SHOCK ABSORBER CASE CPL.	1
3	50180213S6	DCC-COMPR.DAMP.CONTROL CPL. 04	1
4	91010301S	SPRING 140-200(59)D13,5 ORANGE	1
5	46180766	COUNTERNUT	1
6	46180765	ADJUSTING NUT M54X1,5	1
7	50180410	INTERM.RING D=58	2
8	46180396	SPRING RETAINER H=15 D=28	1
9	R12012	REP. KIT BEAR./SEAL UP. 07	1
10	50180366	ADAPTOR BUSH KGW 14X24	2
11	R15009	BEARING KIT KGW 1525 990 DUKE	1
12	46180362	ADAPTOR BUSH KGW 14X32 07	2
13	50180342S1	SHOCK ABSORBER FLUID 5 LT '03	1
14	50180095	BLEED PLUG R 1/8	1
15	46810361	PISTON RING	1
16	46810035	O-RING VITON 37,82X1,78	1
17	46180669S	ADAPTOR CPL. D=46 H=28 07	1
18	46810010	CIRCLIP 49X1,5	1
19	46180365	BUMP RUBBER WP60 H=30 D=18-26	1
20	46811208	RUBBER CAP "DO NOT OPEN"	1
21	36120151	SCREW PLUG M5X6	1
22	46810893	O-RING NBR 5,28X1,78	1
23	52000044	STICKER WP KTM	1

096200430 / C096200430

* NEW PART

X AS REQUIRED

SWING ARM

990 SUPERMOTO T ORANGE EU 2010

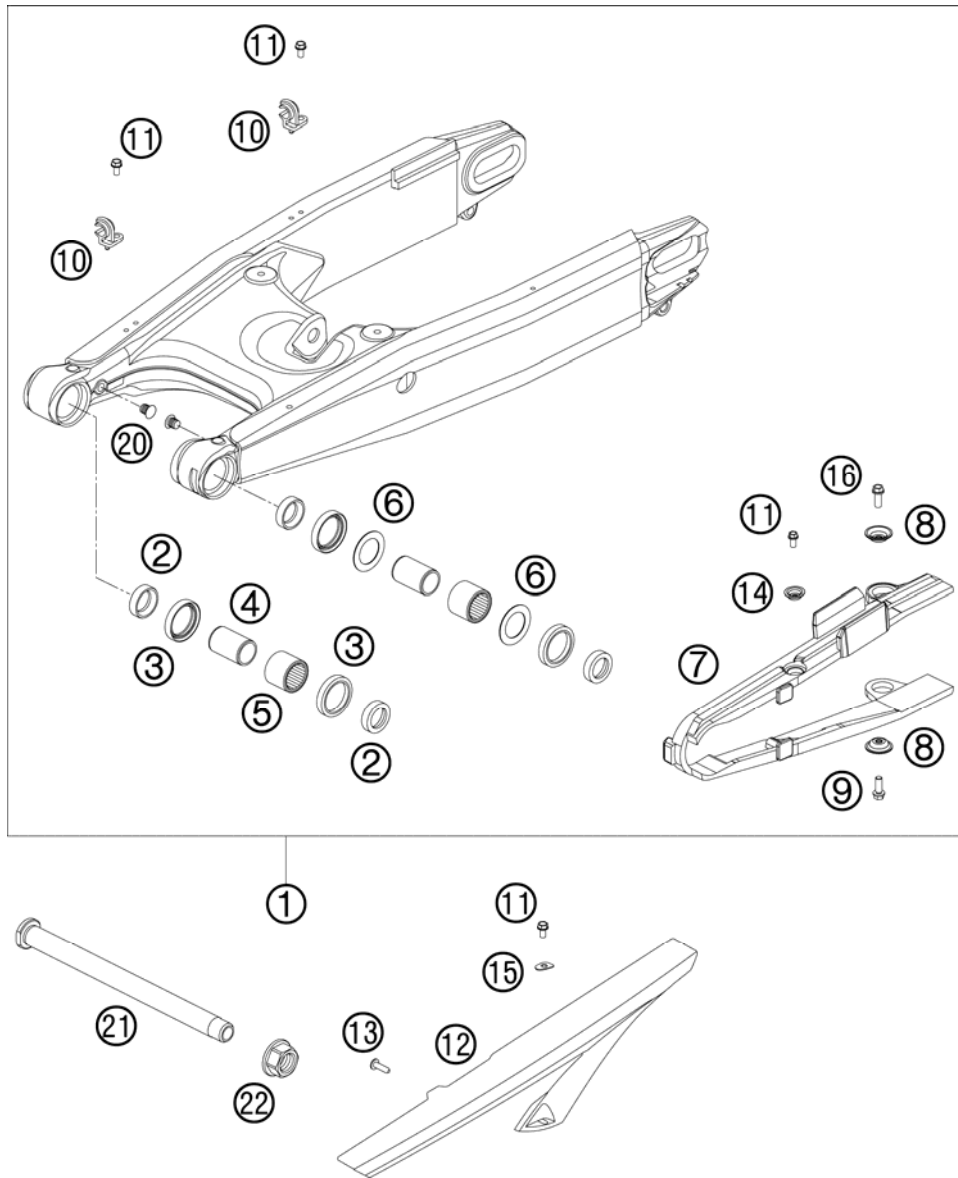

FIG	PART NUMBER	DESCRIPTION	QTY
1	6100403004433	SWING ARM CPL. SM-R SD-R 07	1
2	60004034000	BUCKET F. SHAFT SEAL RING 03	4
3	0760304073	SHAFT SEAL RING 30X40X7	4
4	60004032000	INNER RING JR20X25X38,5 03	2
5	60004031000	NEEDLE BUSH HK2526B 03	2
6	60004033000	STOP DISK 03	2
7	63004066100	CHAIN SLID.GUARD SWINGARM 10	1
8	72210079000	BUCKET	2
9	59009062013	SPECIAL SCREW M6X13 WS=8 10.9	1
10	5461107610030	RET. CLAMP F. BRAKE HOSE BLACK	2
11	0009050103	SPECIAL SCREW M 5,0X10	4
12	61004060000	CHAINGUARD 05	1
13	0081050181	SCREW FOR PLASTIC K50X18 T20	1
14	46104066050	BUSH FOR CHAINSLIDER GUARD 02	1
15	61004060050	WASHER CHAINGUARD 05	1
16	59009062016	SPECIAL SCREW M6X16 WS=8 10.9	1
20	60004042000	PLUG SFL12 GREY 05	2
21*	60004037244	SWINGARM BOLT CPL.	1
22	60004038000	COLLAR NUT M19X1,5 WS=27MM 03	1

106200491 / C106200490

* NEW PART

X AS REQUIRED

EXHAUST SYSTEM

990 SUPERMOTO T ORANGE EU 2010

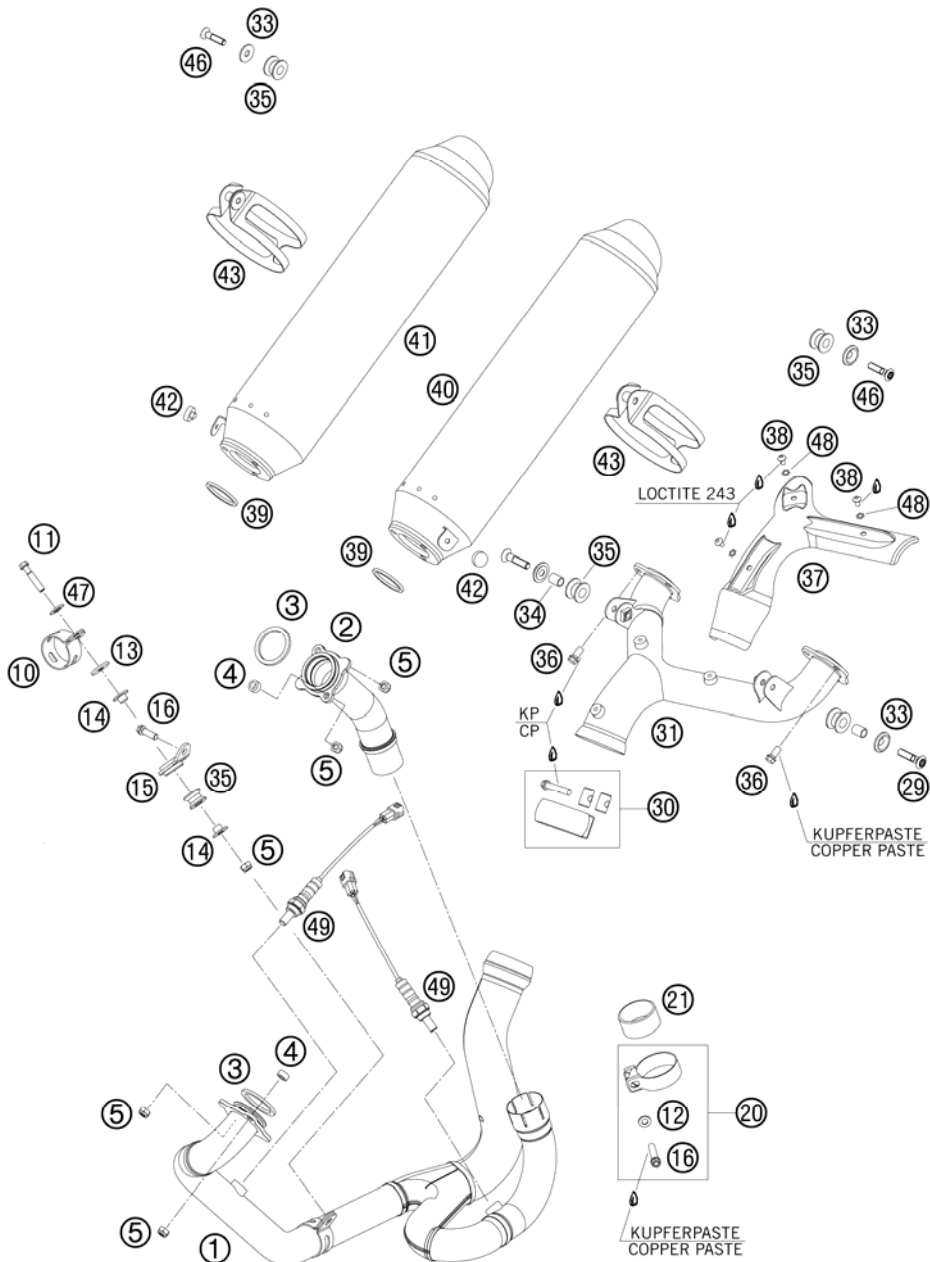

FIG	PART NUMBER	DESCRIPTION	QTY
1	62605007000	EXHAUST MANIFOLD	1
2	61105008000	EXHAUST PIPE REAR 07	1
3	61005005000	EXHAUST GASKET 05	2
4	61005009000	SPACER BUSH. 8,5X15X7,5 05	2
5	51010086100	SELF LOCKING NUT M 8 CU	5
10	61005007049	CLAMP EXHAUST PIPE 05	1
11	0025080406	HH COLLAR SCREW M8X40 TX40	1
12	0125080003	WASHER DIN0125-A 8,4	1
13	51005067000	INSULATE WASHER 8,5X28X3	1
14	58405050065	COLLAR BUSH 8,5X12X23,5X10	2
15	62505015150	EXHAUST PIPE BRACKET FRONT 07	1
16	0025080356	HH COLLAR SCREW M8X35 TX40	2
20	61105051000	EXHAUST CLAMP 52,2MM 07	1
21	58405005001	GRAPHITRING 45X50X25	1
29	0019080356	COUNTERSUNK SCREW ISA45 M8X35	2
30	61005052000	EXHAUST CLAMP CPL. 05	1
31	62505048100	DISTRIBUTOR TUBE 05	1
32	0025080306	HH COLLAR SCREW M8X30 TX40	4
33	62603061000	SPECIAL WASHER 8X24 ALU H=4,2	4
34	62505069000	SPACER BUSH. 8,5X12X18MM 05	2
35	54305068100	DAMP. COMPONENT SILICONE GREY	4
36	0025080166	HH COLLAR SCREW M8X16 TX40	6
37	62505047000	THERMAL SHIELD 05	1
38	58605083010	SCREW TORX M5X10 05	3
39	60005005002	EXHAUST GASKET 03	2
40	62605082000	SILENCER L/S 08	1
41	62605083000	SILENCER R/S 08	1
42	54308042000	RUBBER BUFFER	2
43	61005052000	EXHAUST CLAMP CPL. 05	2
46	0019080306S	COUNTER-SUNK SCREW ISA45 M8X30	2
47	0021080003	WASHER DIN9021-A 8,4	1
48	0797050000	TOOTH LOCK WASHER DIN6797-J	3
49	61041090000	LAMBDA SENSOR 05	2

096200510 / C096200510

* NEW PART

X AS REQUIRED

AIR BOX

990 SUPERMOTO T ORANGE EU 2010

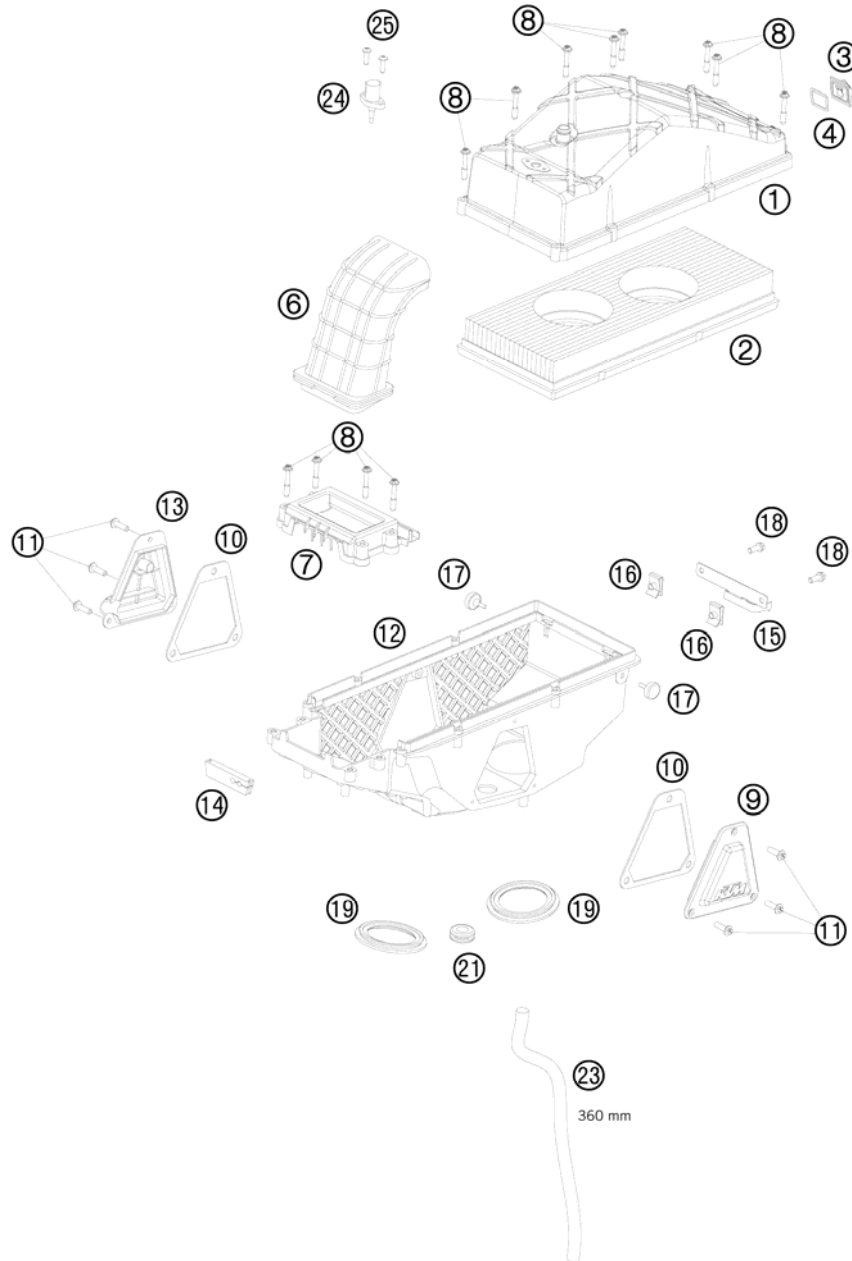

FIG	PART NUMBER	DESCRIPTION	QTY
1	61006002000	AIRBOX COVER 990 DUKE	04
2	61006015000	AIR FILTER EFI	05
3	60006007000	CONNECTOR FOR SAS LC8	03
4	60006007050	GASKET SAS CONNECTOR	03
6	60006040000	INTAKE SNORKEL	03
7	60006004000	AIRBOX FRONT PART LC8	03
8	60006006000	SPECIAL SCREW K60X35/15	03
9	60006003002	AIRBOX COVER L/S R/S	03
10	60006003050	GASKET F. AIRBOX COVER L/S R/S	03
11	0017060203	EJOT PT SCREW K60X20 WS=6	03
12	61006001000	FILTER BOX LOWER PART 990	05
13	61006003002	AIRBOX COVER R/S EFI	05
14	61006001030	RUBBER SLEEVE F. THR. CABLE	05
15	61006001020	SAS-BRACKET PANEL	05
16	54603048100	RANGE CHANGE METAL NUT M6	05
17	60006001021	DISTANCE RUBBER AIRBOX	03
18	0025060166	HH COLLAR SCREW M6X16 TX30	03
19	60036045000	RUBBER SLEEVE AIRBOX	03
21	60006001041	RUBBER SLEEVE FUEL HOSE	03
23	57005020001	HOSE 10X14 PER METER	x
24	61041080000	AMBIENT-AIR TEMPERATURE SENSOR	1
25	0081500181	SCREW FOR PLASTIC D=5X18	2

096200610 / C096200610

* NEW PART

X AS REQUIRED

FUEL PUMP

990 SUPERMOTO T ORANGE EU 2010

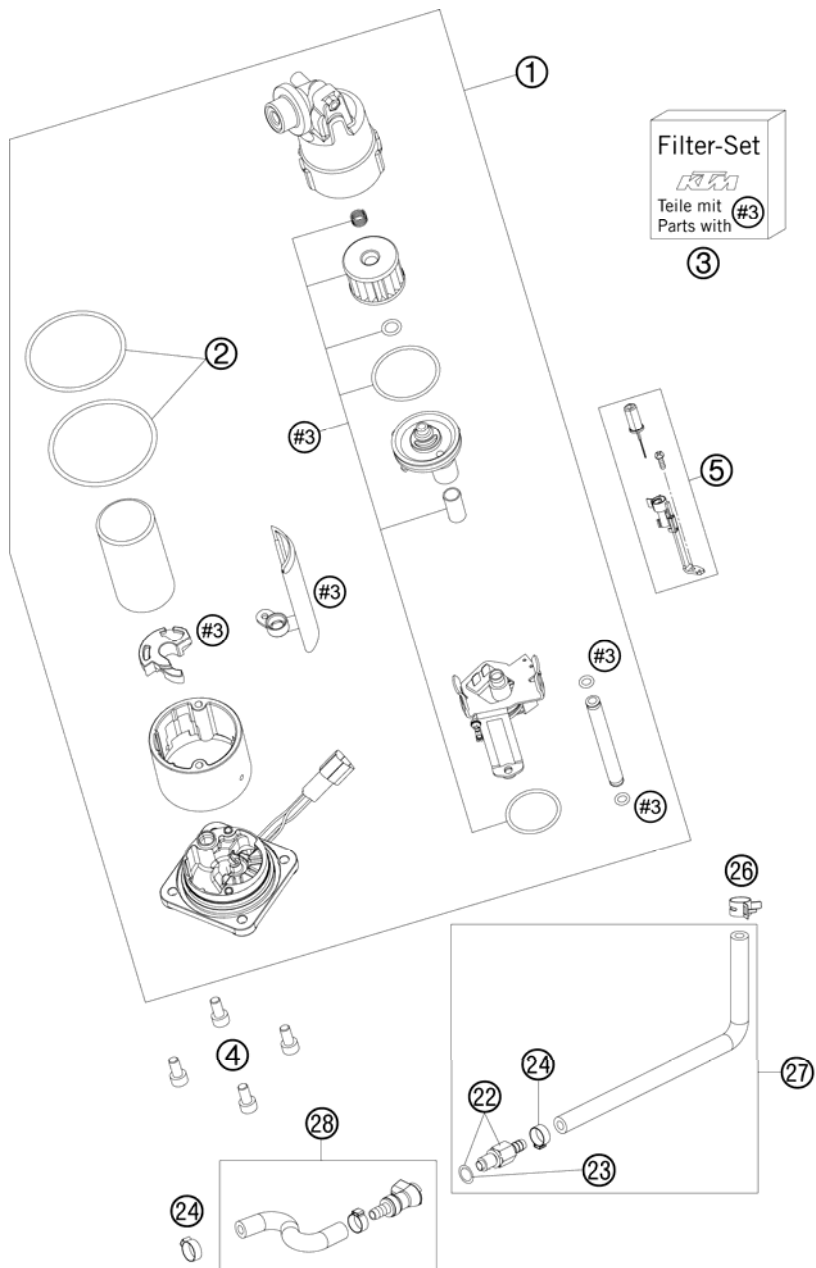

FIG	PART NUMBER	DESCRIPTION	QTY
1	61007088200	PUMP WITHOUT RESERVE INDICATOR REQUIRED: ITEM NUMBER 5	1
2	61007089000	O-RING SET FOR FUEL PUMP 05	1
3	61007090000	FILTER-SET FUEL PUMP 05	1
4	014580060166	CYL. SCREW DIN14580 M 6X16	4
5	62612045000	CONV. KIT FUEL RESERVE INDICAT	1
22	5850701030030	PLUG CPC BLACK 05	1
23	58507012000	O-RING VITON F. PLUG CPC 05	1
24	00050153706	VARIABLE ONE-EAR CLAMP 15,3MM	2
26	00049140121	CLAMP STD DN14	1
27	61007116050	FUEL HOSE 1 CPL.	1
28	62607016044	FUEL HOSE CPL.	1

086260730 / C086260730

* NEW PART

X AS REQUIRED

TANK, SEAT, COVERS

990 SUPERMOTO T ORANGE EU 2010

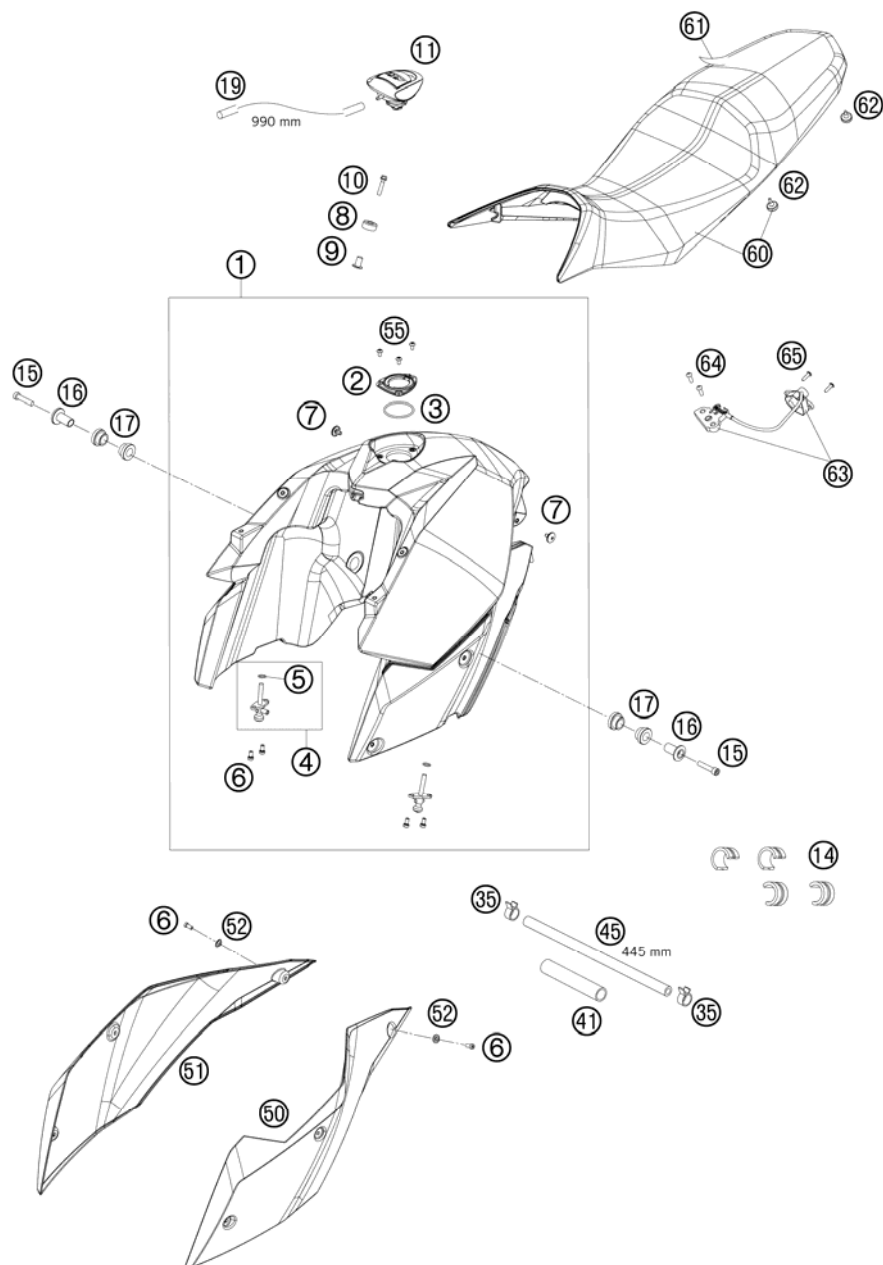

FIG	PART NUMBER	DESCRIPTION	QTY
1	6200701304433	FUEL TANK CPL. 09	1
2	76507008050	CLOSURE FLANGE	1
3	0770050030	O-RING 50,00X3,00 VITON	1
4	58507003000	FUEL COCK CPL. SMALL RALLYE'96	2
5	0770020130	O-RING 1,78x10,82x14,38 2-013	2
6	014580060126	CYL. SCREW DIN14580 M 6X12	10
7	58407011100	SCREW FOR SEAT M6X11,5/8	2
8	50307014000	TANK ROLLER 12X26X12 '98	1
9	62503009000	COLLAR BUSHING 9,5X18X19,8X1,5	1
10	0025060306	HH COLLAR SCREW M6X30 TX30	1
11	58407008300	TANK PLUG	1
14	61007014000	SPACER FUEL TANK 05	4
15	0912080403	AH SCREW DIN912 M8X40	2
16	61007060000	BEARING BUSHING OUTSIDE 05	2
17	61007065000	TANK RUBBER BUSHING FRONT 05	4
19	60007026001	HOSE NBR 5,4X9,4 PER METER	x
35	58031005000	CLAMP YDNAC 10128 12MM	2
41	62507016050	THERMAL PROTECTION L=105MM 05	1
45	60007216445	HOSE 6X13 L=445 MM 08	1
50	6260805000077A	SPOILER R/S ORANGE	1
51	6260805100077A	SPOILER R/S ORANGE	1
52	60008045000	SPECIAL WASHER D=16,5MM 03	6
55	58605083010	SCREW TORX M5X10 05	3
60	62007040000	SEAT CPL.	1
61	62007040050	SEAT COVER	1
62	60006001021	DISTANCE RUBBER AIRBOX 03	4
63	62607050000	SEAT LOCK	1
64	0738060181	COU.SUNK SCR. AH ISO7380 M6X18	2
65	0081050181	SCREW FOR PLASTIC K50X18 T20	2

096200710 / C096200710

* NEW PART

X AS REQUIRED

MASK, FENDERS

990 SUPERMOTO T ORANGE EU 2010

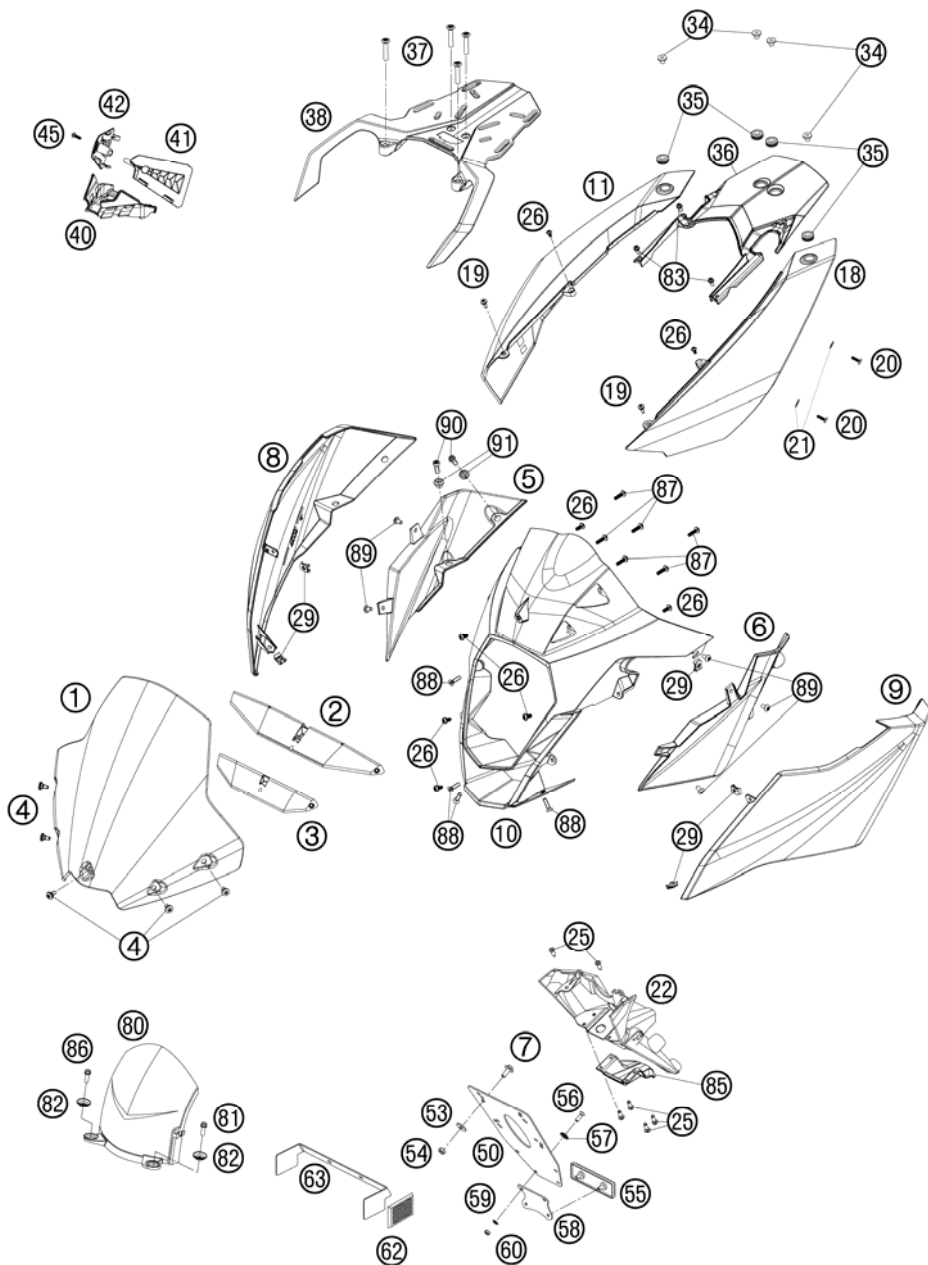

FIG	PART NUMBER	DESCRIPTION	QTY
1	62008008000	WIND SHIELD	1
2	62008008050	WIND SHIELD SUPPORT UPPER	1
3	62008008060	WIND SHIELD SUPPORT LOWER	1
4	69008021160	SPECIAL SCREW M5X12	5
5	62008003050	MASKSPOILER INNER PART R/S 09	1
6	62008002050	MASKSPOILER INNER PART L/S 09	1
7	0024060156	HH COLLAR SCREW M6X15 TX30	4
8	6200800300033A	MASK SPOILER R/S	1
9	6200800200033A	MASK SPOILER L/S	1
10	6200800100030	HEADLIGHT MASK	1
11	6260804210033A	SIDE COVER R/S REAR	1
18	6260804110033A	SIDE COVER L/S REAR	1
19	69008021060	SPECIAL SCREW M5X17	2
20	62008043000	EJOT ALTRACS SCHR.WN5151 50X16	4
21	75008023000	WASHER REAR-UT D=14MM	4
22	62508015000	NUMB.PLATE CARRIER 05	1
23	0024060136	HH COLLAR SCREW M6X13 TX30	2
25	0017060203	EJOT PT SCREW K60X20 WS=6	6
26	0081050121	SCREW FOR PLASTIC K50X12 T20	8
29	69008021080	RANGE CHANGE METAL NUT M5	6
34	60012008002	COLLAR BUSHING 8,2X12X20X9 03	4
35	41001052000	RUBBER SLEEVE D=12MM	4
36	6260801300030	FENDER REAR BLACK 08	1
37	0019080456	COUNTERSUNK SCREW ISA45 M5X45	4
38	62012010033	BAGGAGE CARRIER CPL	1
40	60003087000	SPLASH PROTECTOR FRAME 05	1
41	62603085000	COVER STEARING HEAD UP.L/S	1
42	62603086100	COVER STEARING HEAD UP.R/S	1
45	0081050181	SCREW FOR PLASTIC K50X18 T20	2
50	60012081200	LICENCE FITTING 06	1
53	0021060003	WASHER DIN9021-A 6,4	4
54	0985060003	SELF LOCK. NUT DIN0985-M 6	4
55	58412080000	REFLECTOR RED LC4 '98	1
56	0966050163	OVAL HEAD SCREW DIN0966-M 5X16	2
57	40006006000	WASHER 6MM	2

096200810 / C096200810

* NEW PART

X AS REQUIRED

MASK, FENDERS

990 SUPERMOTO T ORANGE EU 2010

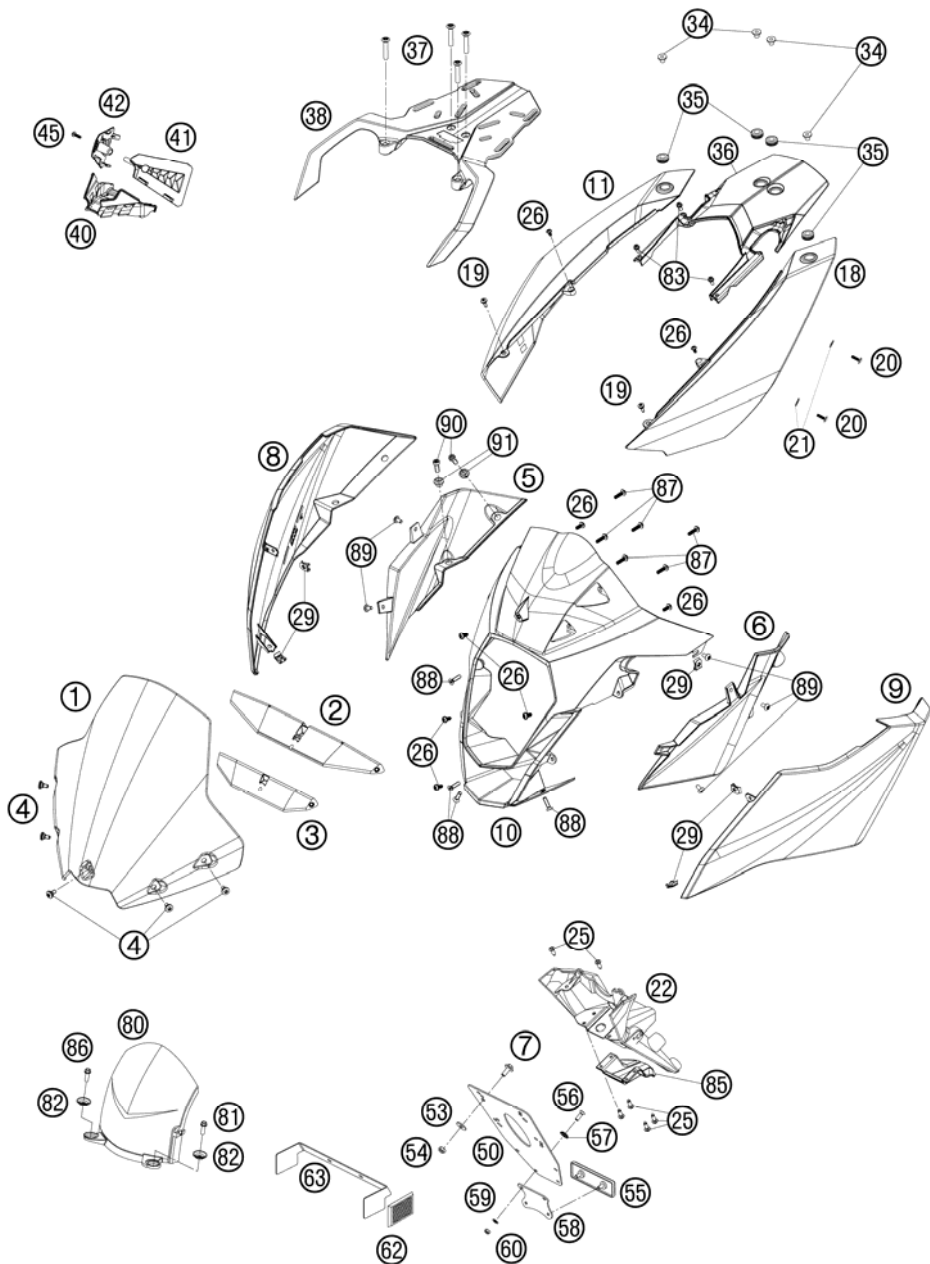

FIG	PART NUMBER	DESCRIPTION	QTY
58	58412080050	BRACKET FOR REFLECTOR	1
59	0125050003	WASHER DIN0125-A 5,3	2
60	0985050003	SELF LOCKING NUT DIN0985-M 5	2
62	16512180100	SIDE REFLECTOR RED REAR	2
63	62512081000	BRACKET SIDE REFLECTOR 06	1
80	61008014000	SPLASH PROTECT. 05	1
81	59009062016	SPECIAL SCREW M6X16 WS=8 10.9	1
82	72210079000	BUCKET	2
83	0025060126	HH COLLAR SCREW M6X12 TX30	4
85	62608015001	COVER NUMB. PLATE CARRIER	1
86	59009062013	SPECIAL SCREW M6X13 WS=8 10.9	1
87	0081050181	SCREW FOR PLASTIC K50X18 T20	6
88	0019050201	COUNTERSUNK SCREW ISA25 M5X20	4
89	58605083010	SCREW TORX M5X10 05	6
90	014580060166	CYL. SCREW DIN14580 M 6X16	4
91	75001094010	BUSHING MUD FLAP 07	4

096200810 / C096200810

* NEW PART

X AS REQUIRED

DECAL

990 SUPERMOTO T ORANGE EU 2010

FIG	PART NUMBER	DESCRIPTION	QTY
1	62008099000	DECAL SET 990 SM-T OR/SILV 09	1

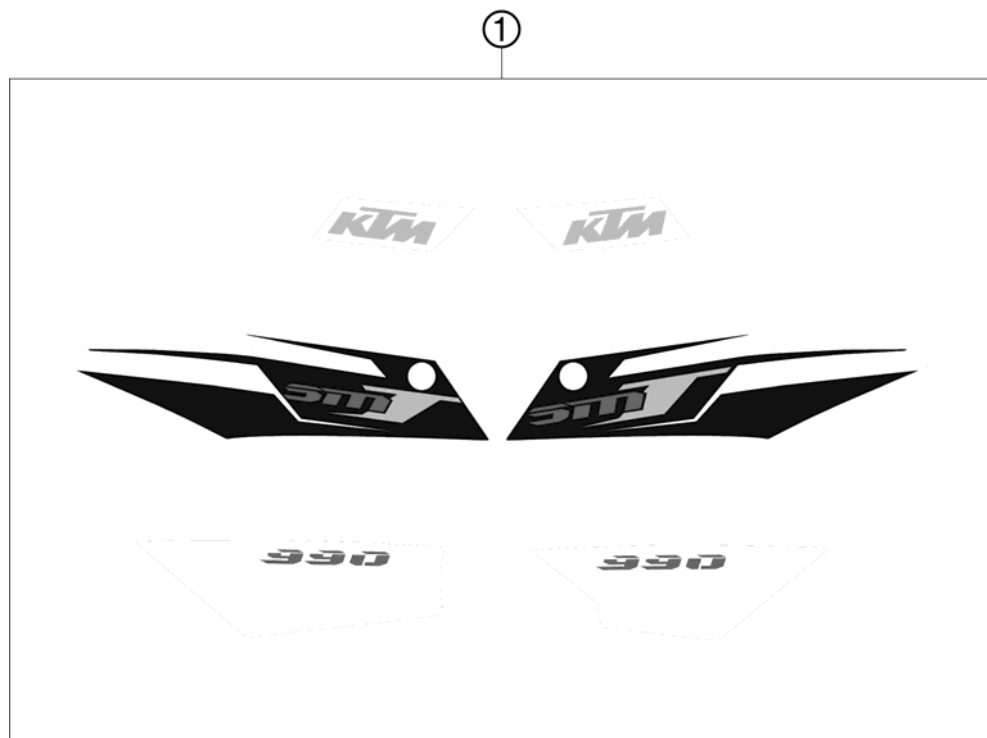

096200830 / C096200830

* NEW PART

X AS REQUIRED

FRONT WHEEL

990 SUPERMOTO T ORANGE EU 2010

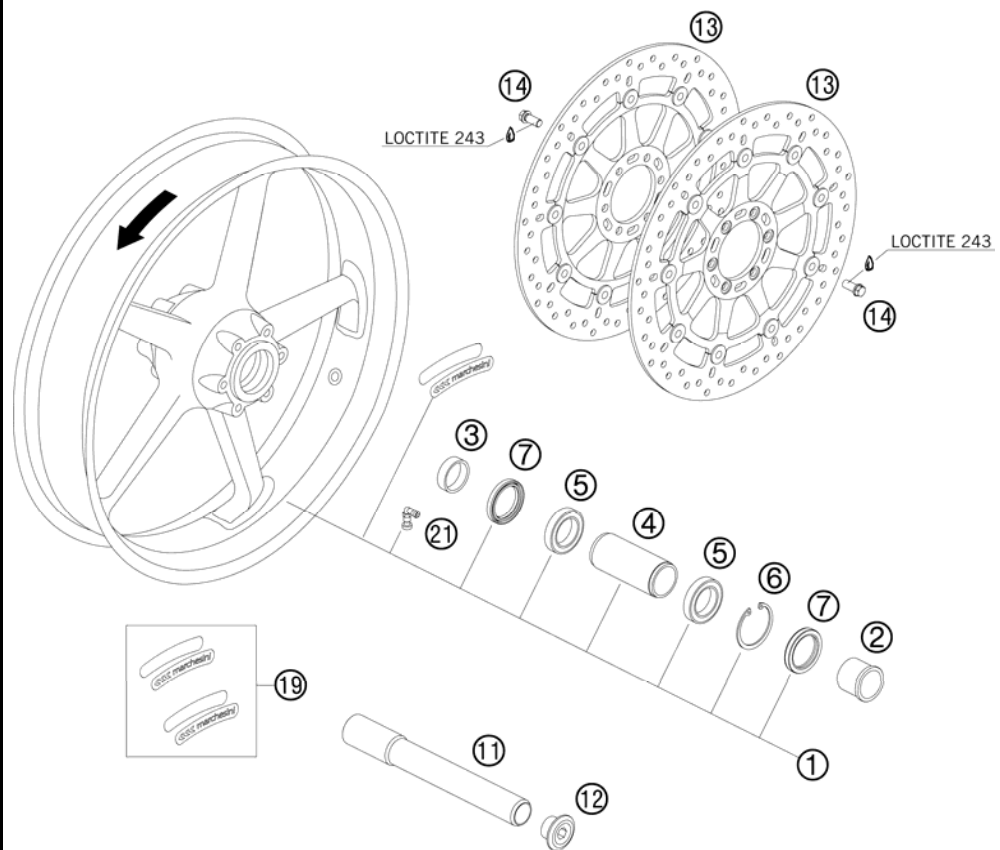

FIG	PART NUMBER	DESCRIPTION	QTY
1	6100900104430	FRONT WHEEL CPL. BLACK 07	1
2	61009012000	SPACER BUSH. FR. WHEEL L/S 05	1
3	60009013000	SPACER BUSH. FR. WHEEL R/S 03	1
4	61009011000	BEARING SPACER TUBE FRONT 05	1
5	0625069068	GR.BALL BEAR.6906 DDU2CG23S6NM	2
6	0472048175	LOCK RING DINO472-48X1,75	1
7	0760354771	SHAFT SEAL RING 35X47X7 TC	2
11	61009081000	WHEEL SPINDEL FRONT 05	1
12	61009082000	AH SCREW M25X1,5 WS=12 05	1
13	6250906000030	BRAKE DISK D=305MM 07	2
14	61009062018	SPECIAL SCREW M8X18 05	12
19	00050000120	STICKER MARCH. 2L/S+2R/S WHITE	1
21	61009076000	VALVE ANGLED 90° 05	1

086260910 / C096200910

* NEW PART

X AS REQUIRED

REAR WHEEL

990 SUPERMOTO T ORANGE EU 2010

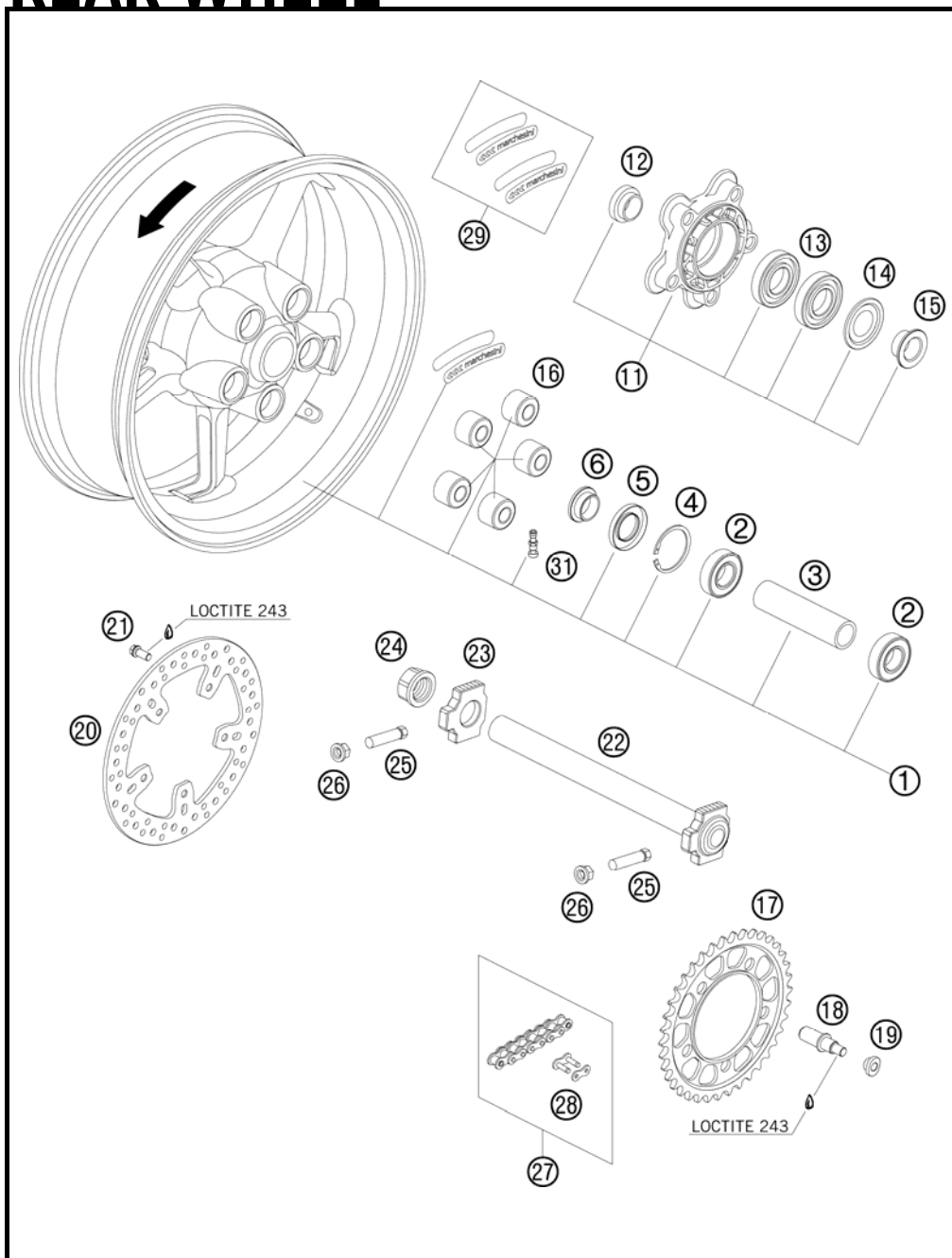

FIG	PART NUMBER	DESCRIPTION	QTY
1	6101000104430	REAR WHEEL CPL. BLACK 07	1
2	0625062052	GR.BALL BEAR. 6205-2RSHC3HMTF7	2
3	61010011000	BEARING SPACER TUBE REAR 05	1
4	0472052200	CIRCLIP DIN0472-52X2	1
5	0760305271	SHAFT SEAL RING 30X52X7	1
6	60010013000	SPACER BUSH. REAR WHEEL R/S 03	1
11	61010050144	SPROCKET SUPPORT CPL. 06	1
12	60110014000	SPACER BUSH. SPR. SUPP. IN. 06	1
13	0625060060	BALL BEARING 6006 DDU2CG23S6NM	2
14	60110016000	NILOS RING 6006AV	1
15	60110012000	SPACER BUSH. SPROCKET SUPP. 06	1
16	61010059000	DAMPING RUBBER 05	5
17	61010051138	REAR SPROCKET 38-T STEEL 05	x
17	61010051139	REAR SPROCKET 39-T STEEL 05	x
17	61010051140	REAR SPROCKET 40-T STEEL 05	x
17	61010051141	REAR SPROCKET 41-T STEEL 05	1
17	61010051142	REAR SPROCKET 42-T STEEL 05	x
18	61010056000	BOLT FOR SPROCKET SUPPORT 05	5
19	61010057000	NUT REAR SPROCKET 05	5
20	61010060000	BRAKE DISK REAR D=240MM 05	1
21	61009062018	SPECIAL SCREW M8X18 05	5
22*	60010081144	WHEEL SPINDLE REAR CPL.	1
23	60010084000	CHAIN TENSIONER R/S LC8 03	1
24	61010086000	COLLAR NUT M25X1,5 WS=32 05	1
25	50304040100	SCREW M10X1,25X50 WS=10	2
26	58414030000	HH COLLAR NUT M10X1,25 WS=13	2
27	60010165118	CHAIN 525 WITH MASTER LINK 03	1
28	60010066000	MASTER LINK FOR CHAIN 525 03	x
		NEEDS RIVET TOOL	
29	00050000120	STICKER MARCH. 2L/S+2R/S WHITE	1
31	58709076000	VALVE CPL. BREMBO DUKE 2003	1

086261010 / C106201010

* NEW PART

X AS REQUIRED

WIRING HARNESS

990 SUPERMOTO T ORANGE EU 2010



FIG	PART NUMBER	DESCRIPTION	QTY
1	62011075000	WIRING HARNESS SM-T 09	1
2	62011083000	PLUG SUPPORT PANEL	1
4	62011094000	BRACKET CABELFIXING	1
5	57013070400	PVC CLAMP 17,4MM HEYCO 3381	2
6	0081050121	SCREW FOR PLASTIC K50X12 T20	6
7	61011075020	DUMMY PLUG ALARM SYSTEM 05	1
8	62511057050	BRACKET RELAY 05	1
9	58011109110	FUSE 10 A 2000	x
9	58011109115	FUSE 15 A	x
10	61111057000	RELAY CM1A-R-12V-H80 07	4
11	58411096100	DIODE S3H-15 97	2
14	54603048200	RANGE CHANGE METAL NUT M5	2
15	0025050126	HH COLLAR SCREW M5X12 TX30	2
16	000700000BH	SPARE CONNECTOR BH 6-PINS	1
18	44611207200	FLASHER UNIT 97	1
19	58511075510	FUSE-BOX COVER	1
20	62511060000	DC HORN 05	1
21	0024060156	HH COLLAR SCREW M6X15 TX30	1
22	60011092000	OIL-PRESSURE SWITCH CABLE 03	1
23	60011093045	RUBBER CABLE TIE 45MM 03	x
23	60011093075	RUBBER CABLE TIE 75MM 03	x
24	44011076140	CABLE TIE 14072,5MM BLACK	x
24	44011076200	CABLE TIE 200/3,6MM BLACK	x
25	62611047000	CABLE FOR ROLLOVER SENSOR 08	1
27	61111018000	TEMPERATURE SENSOR 07	1
28	61111020000	STARTER INTERLOCK	1
29	60111097000	GROUND CABLE 100MM 06	1
30	58411098100	CONTACT WASHER M6 VSV-K6	2
31	0025060106	HH COLLAR SCREW M6X10 TX30	2

096201110 / C096201110

* NEW PART

X AS REQUIRED

BATTERY

990 SUPERMOTO T ORANGE EU 2010

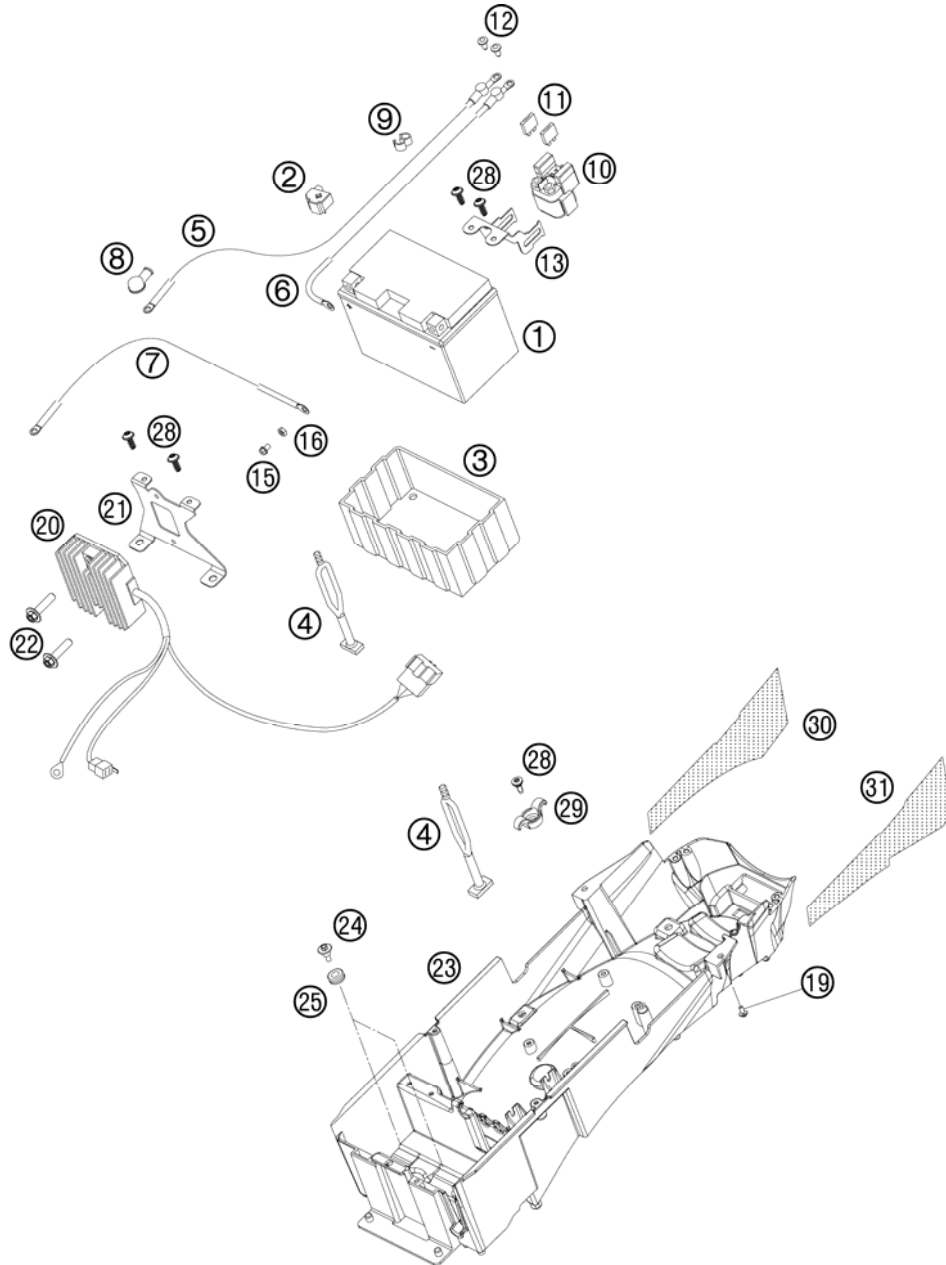

FIG	PART NUMBER	DESCRIPTION	QTY
1	60011053000	BATTERY 12V/11AH	03
2	62511059160	COVER POSITIVE POLE	06
3	58411053050	BATTERY COVER	96
4	50303018000	RUBBER L=145MM	2
5	62511059000	STARTER CABLE L=650MM	05
6	62511059050	BATTERY CABLE L=125MM	05
7	62511097000	GROUND CABLE L=650MM	05
8	60040009000	RUBBER CAP STARTER PORT	03
9	55011022100	CLAMP D=6/8MM, BLACK	1
10	58211058000	STARTER RELAY 12V '99	1
11	58011109130	FUSE 30 A	x
12	0902060083	AH OVAL SCREW ISO 7380 M 6X8	2
13	62511058050	BRACKET START RELAY	05
15	0024060106	HH COLLAR SCREW M6X10 TX30	2
16	0934060003	HEXAGON NUT DIN0934-M 6	2
19	0024060136	HH COLLAR SCREW M6X13 TX30	2
20	62511034100	VOLTAGE REGULATOR	1
21	62511037000	BRACKET VOLTAGE REGULATOR	05
22	0024060256	HH COLLAR SCREW M6X25 TX30	2
23	62508019400	REAR END LOWER PART 08	1
24	60035001000	SPECIAL SCREW M6X21 WS=8	2
25	41001052000	RUBBER SLEEVE D=12MM	4
28	0081050121	SCREW FOR PLASTIC K50X12 T20	5
29	62508021000	SUPPORT TOOL SET	05
30	62508019360	THERMAL PROTECTON FOIL R/S 07	1
31	62508019250	THERMAL PROTECTON FOIL L/S 07	1

096201130 / C096201130

* NEW PART

X AS REQUIRED

HAND BRAKE CYLINDER

990 SUPERMOTO T ORANGE EU 2010

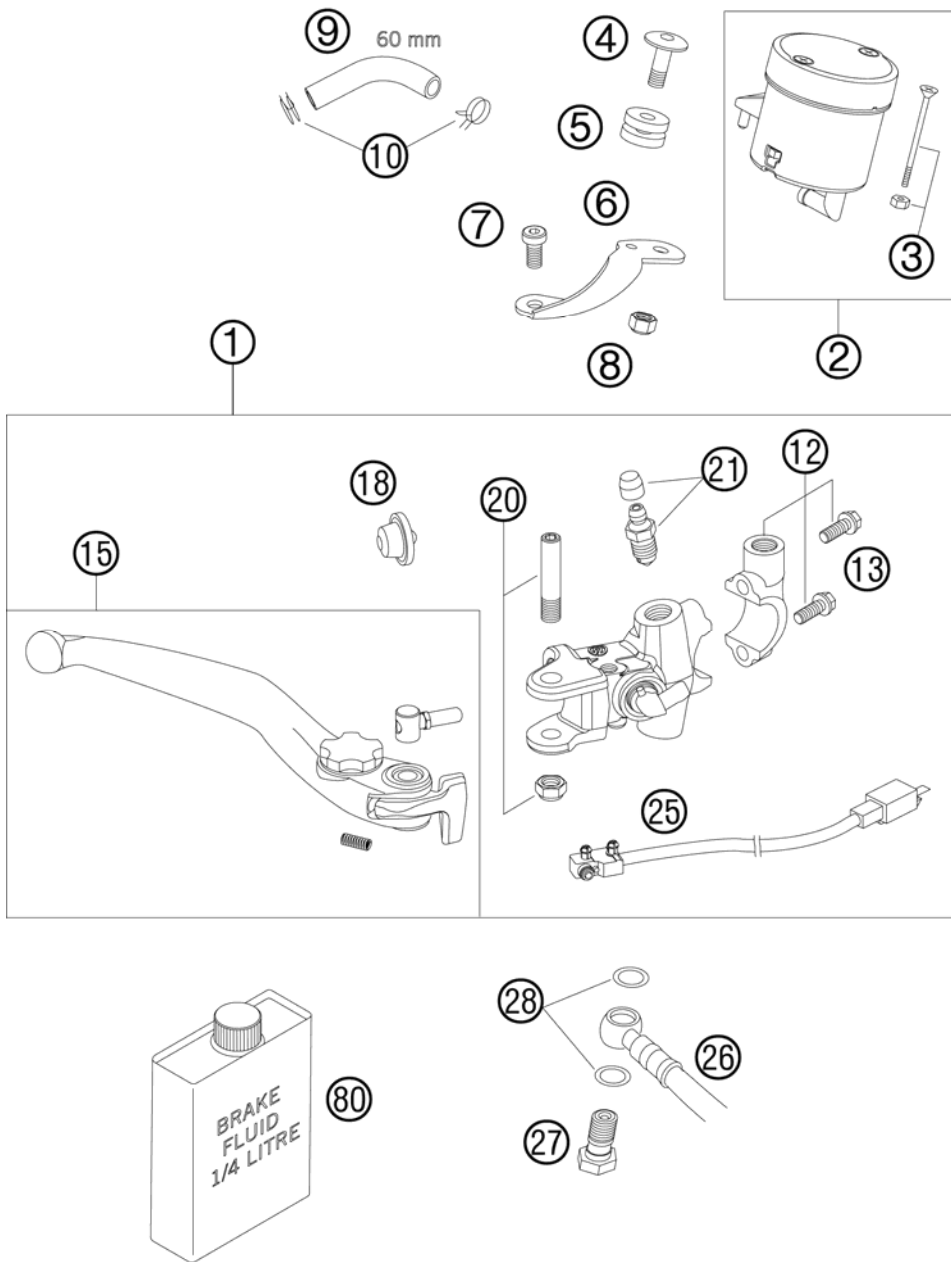

FIG	PART NUMBER	DESCRIPTION	QTY
1	62513001100	HAND BRAKE CYLINDER 07	1
2	61013009002	BRAKE FLUID RESERVOIR CPL.	1
3	61013009003	SCREW + NUT FOR RESERVOIR	2
4	61013013050	SCREW RET.PANEL-RESERVOIR	1
5	61013013000	RUBBER BUSH 05	1
6	61013009001	RET.PANEL FLUID RES. FRONT 05	1
7	61013021000	SCREW RET.PANEL-BRAKE CYLINDER	1
8	61013009004	NUT FOR RESERVOIR	1
9	58007016101	HOSE FOR RESERVOIR 6X1,5	1
10	58007017000	YDNAC CLAMP 10101 (9MM)	2
12	61013005000	CLAMP CPL. 05	1
13	0025060256	HH COLLAR SCREW M6X25 TX30	2
15	62513002144	HAND BRAKE LEVER CPL. 07	1
18	61013008000	RUBBER CUP 05	1
20	61013006000	LEVER SCREW CPL. 05	1
21	60013020000	BLEEDER SCREW WITH CAP	1
25*	62011050000	BREAK LIGHT SWITCH FRONT	1
26	6201301200030	BRAKE PIPE FRONT	1
27	50213025000	HOLLOW SCREW M10X1X19	1
28	0603100141	COPPER GASKET DIN7603-10X14X1	2
80	00062030000	BRAKE FLUID DOT5.1 0,25L	1

086261310 / C096201310

* NEW PART

X AS REQUIRED

REAR BRAKE CONTROL

990 SUPERMOTO T ORANGE EU 2010

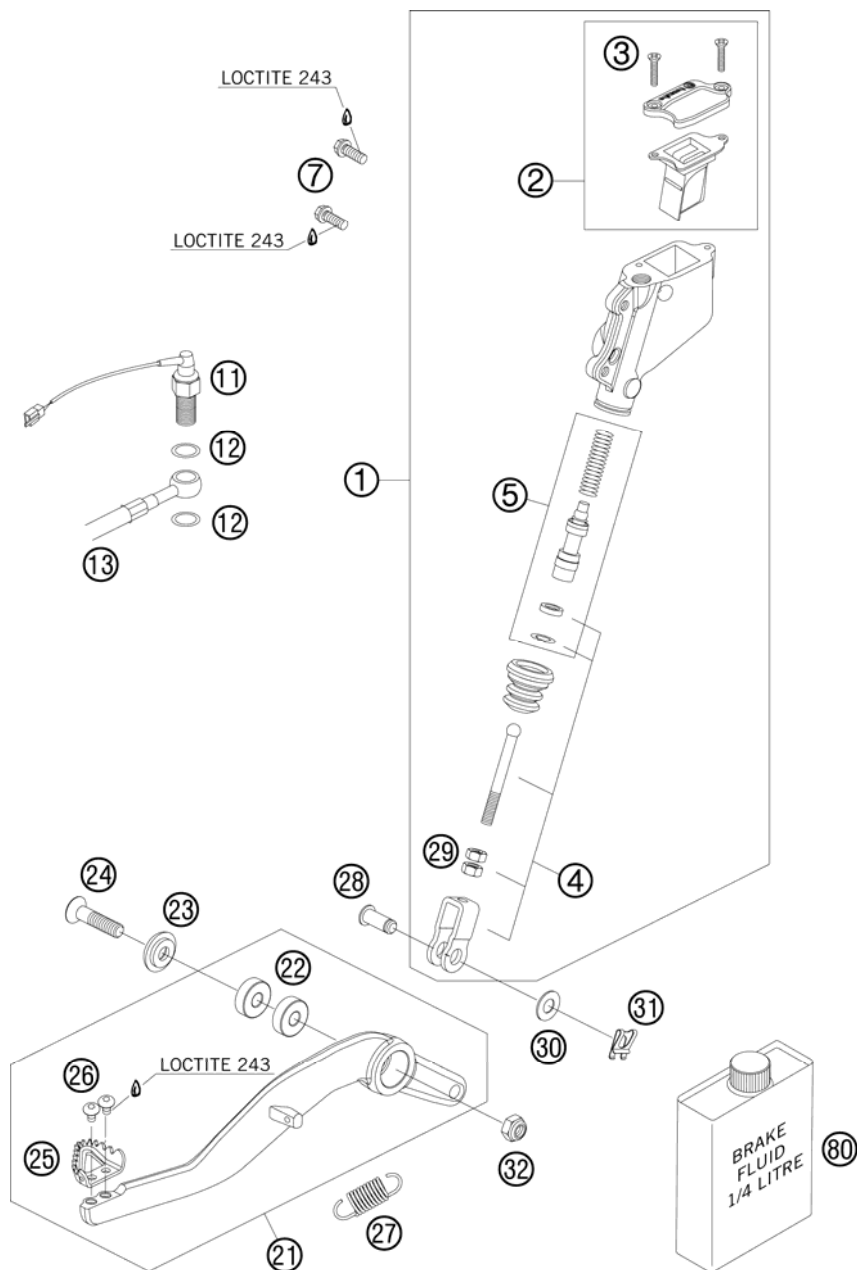

FIG	PART NUMBER	DESCRIPTION	QTY
1	60013060200	MAIN BRAKE CYLINDER CPL. 07	1
2	60013059100	COVER MAIN BRAKE CYLINDER CPL.	1
3	0965040161	FLAT HEAD SCREW DIN0965-M 4X16	2
4	60013056044	PUSH ROD CPL. '03	1
5	60013061000	REPAIR KIT PISTON 03	1
7	59009062016	SPECIAL SCREW M6X16 WS=8 10.9	2
11	50311051100	BRAKE LIGHT SWITCH REAR '98	1
12	0603100141	COPPER GASKET DIN7603-10X14X1	2
13	6251307200030	BRAKE HOSE REAR 07	1
21	6251305004401S	FOOT BRAKE LEVER CPL. 07	1
22	0625006087	GROOVED BALL BEAR. 608 2RS C3	2
23	62603062000	SPECIAL WASHER 8X24 ALU H=2,6	1
24	0019080356	COUNTERSUNK SCREW ISA45 M8X35	1
25	54813051100	STEP PLATE FOR BRAKE LEVER	1
26	58605083010	SCREW TORX M5X10 05	2
27	54603062000	RETURN SPRING FOR BRAKE LEVER	1
28	60013057000	BOLT F. LINK FORK 8X20X16,5	1
29	0934060003	HEXAGON NUT DIN0934-M 6	2
30	0125080003	WASHER DIN0125-A 8,4	1
31	60013058000	SECURING CLIP D=8MM 03	1
32	0985080003	SELF LOCKING NUT DIN0985-M 8	1
80	00062030000	BRAKE FLUID DOT5.1 0,25L	1

086261330 / C096201330

* NEW PART

X AS REQUIRED

BRAKE CALIPER FRONT

990 SUPERMOTO T ORANGE EU 2010

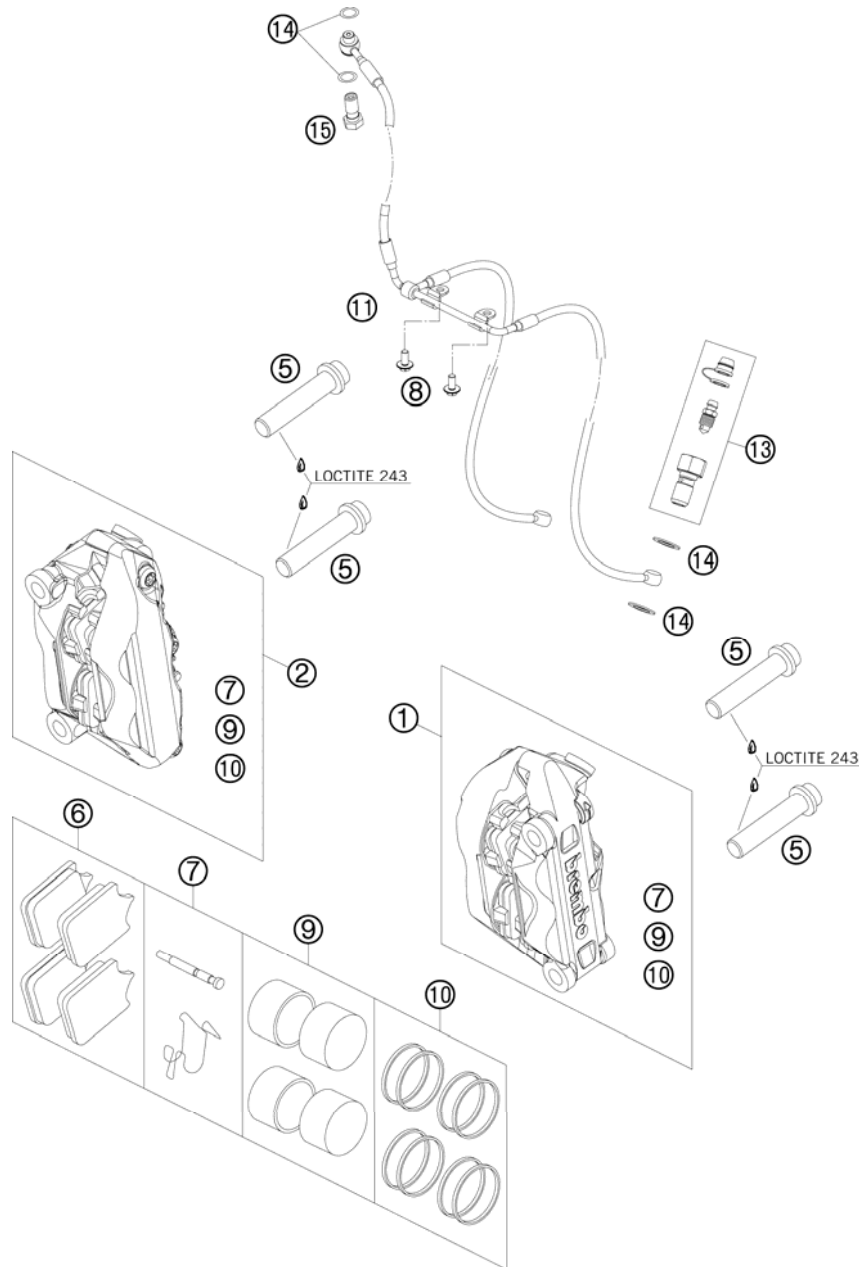

FIG	PART NUMBER	DESCRIPTION	QTY
1	6251311500130	CALIPER L/S BLACK WITHOUT PADS	1
2	6251311600130	CALIPER R/S BLACK WITHOUT PADS	1
5	0035100559	AH-COLLAR SCREW M10X1,25X55	4
6	61013030000	BRAKE PAD FR. TOSHIBA TT2172HH	2
6	61013030100	BRAKE PAD FR. HAWK 7342-49	x
7	61013018000	PINS + SPRINGS F. BRAKECALIPER	2
8	0024060136	HH COLLAR SCREW M6X13 TX30	2
9	61013019000	BRAKE PISTONS 4X	2
10	61013019100	REP.KIT SEALING RINGS 4X	2
11	6201301200030	BRAKE PIPE FRONT	1
13	62513020000	BLEEDER SCREW CPL. 05	2
14	0603100141	COPPER GASKET DIN7603-10X14X1	6
15	50213025000	HOLLOW SCREW M10X1X19	1

096201360 / C096201360

* NEW PART

X AS REQUIRED

BRAKE CALIPER REAR

990 SUPERMOTO T ORANGE EU 2010

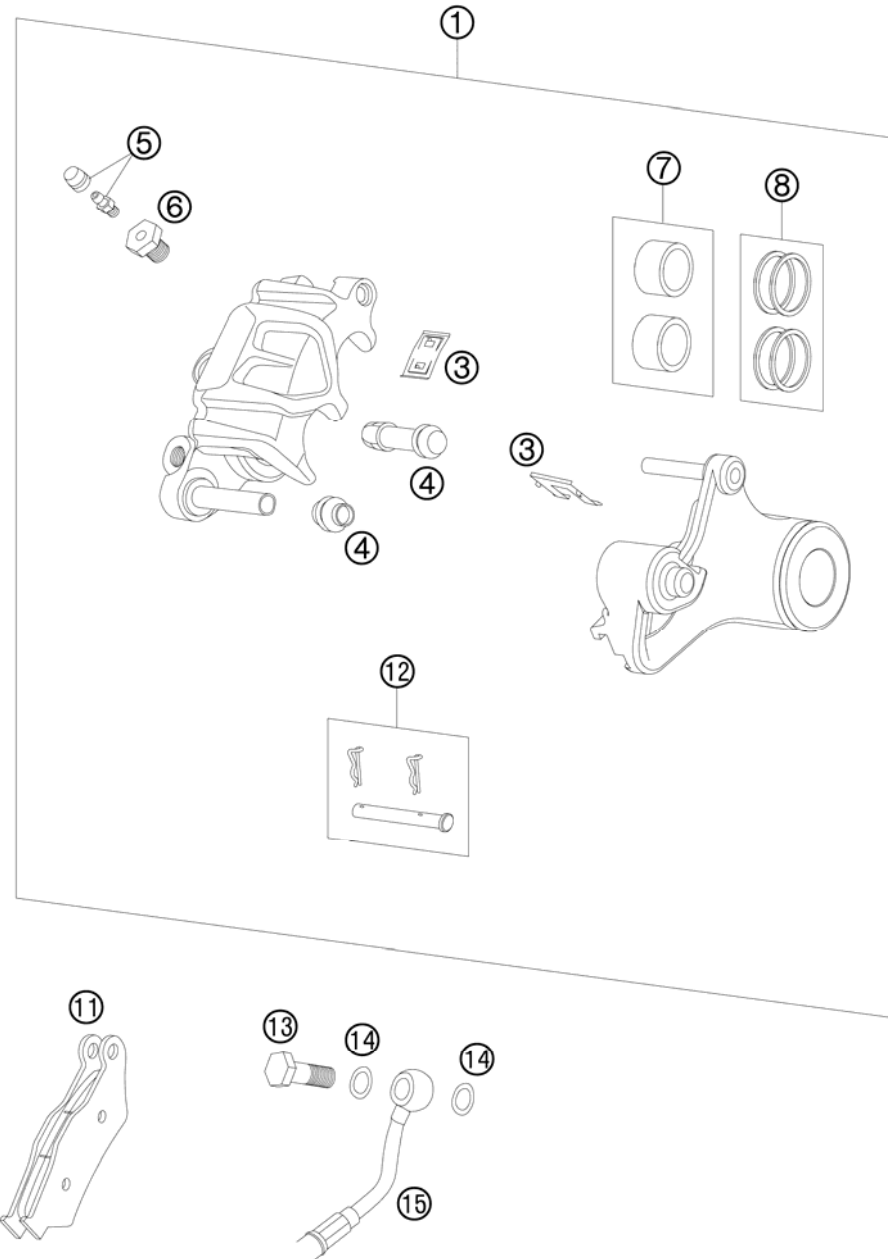

FIG	PART NUMBER	DESCRIPTION	QTY
1	6001308000130	CALIPER REAR WITHOUT PADS	1
2	60013018100	RETAINING PLATE SET REAR 03	1
3	54613218000	CUP SET SHORT	1
4	60013020200	BLEEDER SCREW WITH CAP M6	1
5	60013020100	ADAPTER SCREW	1
6	60013083200	BRAKE PISTONS 05	1
7	60013081000	REP.KIT SEALINING RINGS	1
8	50313030200	BRAKEP.SET FR.TOSHIBA TT2701HH	1
9	77013017000	BOLT CPL. 09	1
10	54813020100	HOLLOW SCREW BLACK M10X1X19	1
11	0603100141	COPPER GASKET DIN7603-10X14X1	2
12	6251307200030	BRAKE HOSE REAR 07	1

096261390 / C096201390

* NEW PART

X AS REQUIRED

LIGHTING SYSTEM

990 SUPERMOTO T ORANGE EU 2010

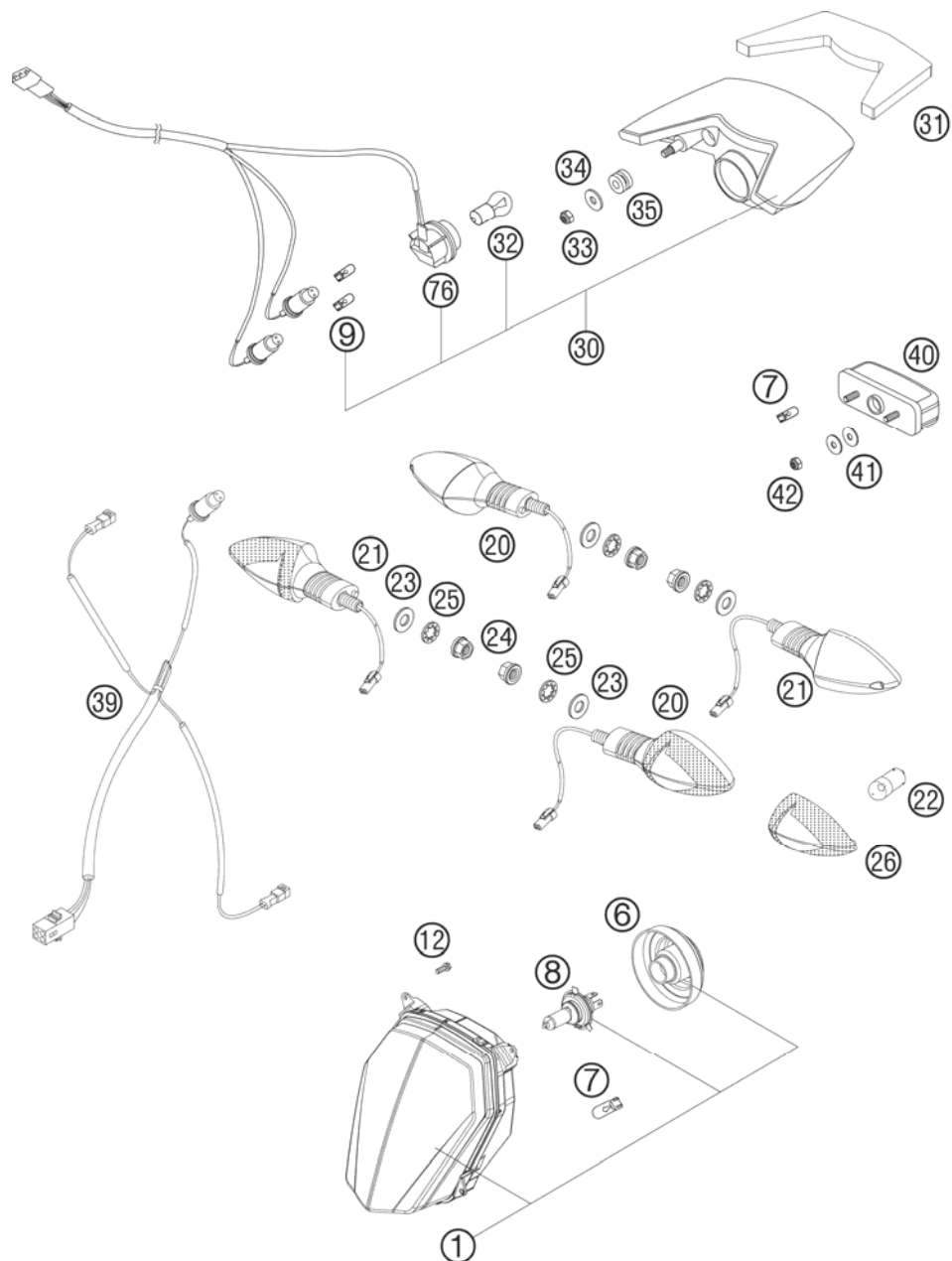
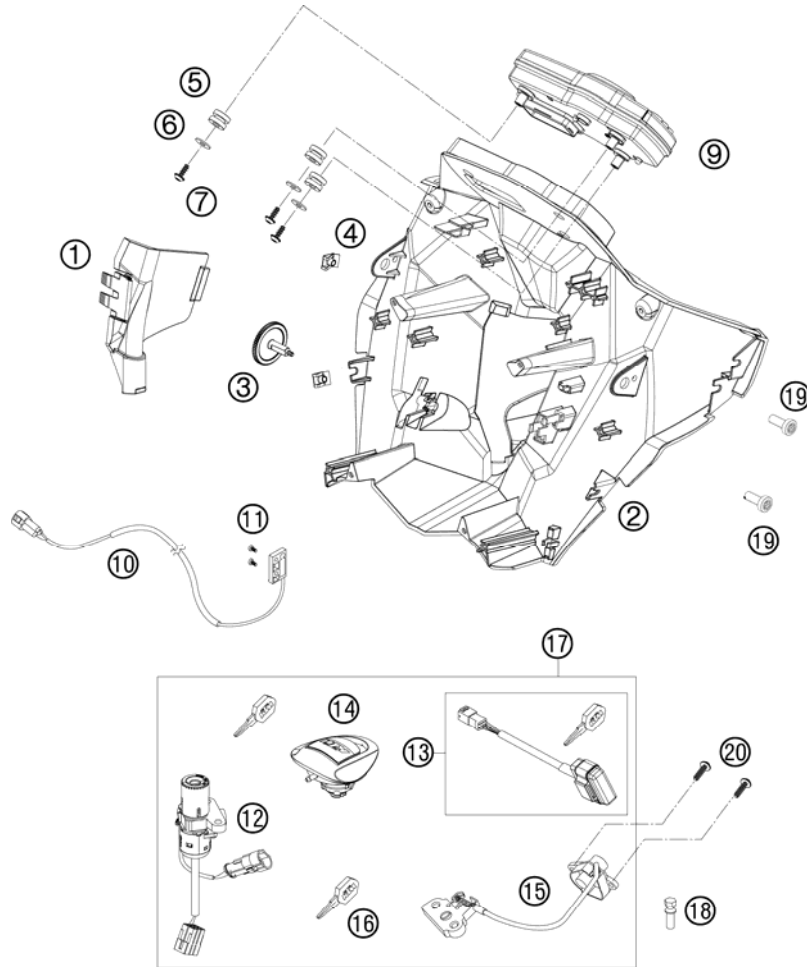

FIG	PART NUMBER	DESCRIPTION	QTY
1	62614001000	HEAD LIGHT RIGHT TR. 08	1
6	76514001050	RUBBER CAP FOR HEAD LIGHT	1
7	49011435100	BULB 12V 5W (W2,1X9,5D) PHIL.	2
8	57111038000	BULB H4 12V 60/55W (P43T)	1
9	49011435200	BULB RED WR5W 12V	2
12	0025050126	HH COLLAR SCREW M5X12 TX30	4
20	60114025000	FLASHER CPL.FRONT L/S REAR R/S	2
21	60114026000	FLASHER CPL.FRONT R/S REAR L/S	2
22	60114027000	BULB 12V ORANGE (RY10W)	4
23	0433100003	WASHER 18x10,5x1,6	4
24	58414030000	HH COLLAR NUT M10X1,25 WS=13	4
25	0797100003	LOCK WASHER DIN6797-J10,5 ZI	4
26	60114028000	FLASHER LENS L/S R/S TRANSP.06	4
30	58614140044	REAR LIGHT CPL.SMOKED GLASS 07	1
31	62614040050	METAMOLL FOR HEAD LIGHT 08	1
32	60014048100	BULB RED PR21W 12V	1
33	0985060003	SELF LOCK. NUT DIN0985-M 6	2
34	0021060003	WASHER DIN9021-A 6,4	2
35	58214069051	RUBBER GROMMET 16X10,8X3 02	2
39	62611076000	WIRING HARNESS REAR 08	1
40	58414047000	LICENSE-PLATE ILLUMINATION '98	1
41	0021050003	WASHER DIN9021-A 5,3	4
42	0985050003	SELF LOCKING NUT DIN0985-M 5	2
76	58611176100	CABLE HARNESS REAR PART 07	1

086261410 / C086261410

* NEW PART

X AS REQUIRED



ACHTUNG !!! Zum Anlernen des EWS-Steuergeräts sind zwei schwarze Zündschlüssel erforderlich.

CAUTION !!! To program the ICU control unit, the two black ignition keys are required.

FIG	PART NUMBER	DESCRIPTION	QTY
1	62014010050	COVER COCKPIT SUPPORT	1
2	62014010000	COCKPIT SUPPORT	1
3	62014010060	ADJUSTING KNURL COCKP. SUPPORT	1
4	69008021080	RANGE CHANGE METAL NUT M5	6
5	58214069051	RUBBER GROMMET 16X10,8X3	02
6	0021050003	WASHER DIN9021-A 5,3	3
7	0081050121	SCREW FOR PLASTIC K50X12 T20	3
9*	61114169300	SPEEDOMETER	10
10	62514068100	SPEEDOMETER SENSOR 06	1
11	0084040083	CYL.HEAD SCREW DIN0084-M 4X8 A	2
12	62011066000	IGNITION LOCK	1
13	62611021000	IMMOBILIZER 990 SM	08
14	58407008300	TANK PLUG	1
15	62607050000	SEAT LOCK	1
16	62611067000	KEY WITH TRANSPONDER	1
17	62011066044	LOCK SET	1
18	60011064000	TAMPERPROOF SCREW F. IGN. LOCK	2
19	0035080206S	AH-COLLAR SCREW M8X20 ISA45	4
20	0081050181	SCREW FOR PLASTIC K50X18 T20	2

096201430 / C106201430

* NEW PART

X AS REQUIRED

ACCESSORIES KIT

990 SUPERMOTO T ORANGE EU 2010

①
OHNE ABBILDUNG
WITHOUT ILLUSTRATION

①
TECHNISCHE DOKUMENTATION
TECHNICAL DOCUMENTATION
DOCUMENTACION TECNICA
DOCUMENTATION TECHNIQUE
NOTE TECNICHE

⑫

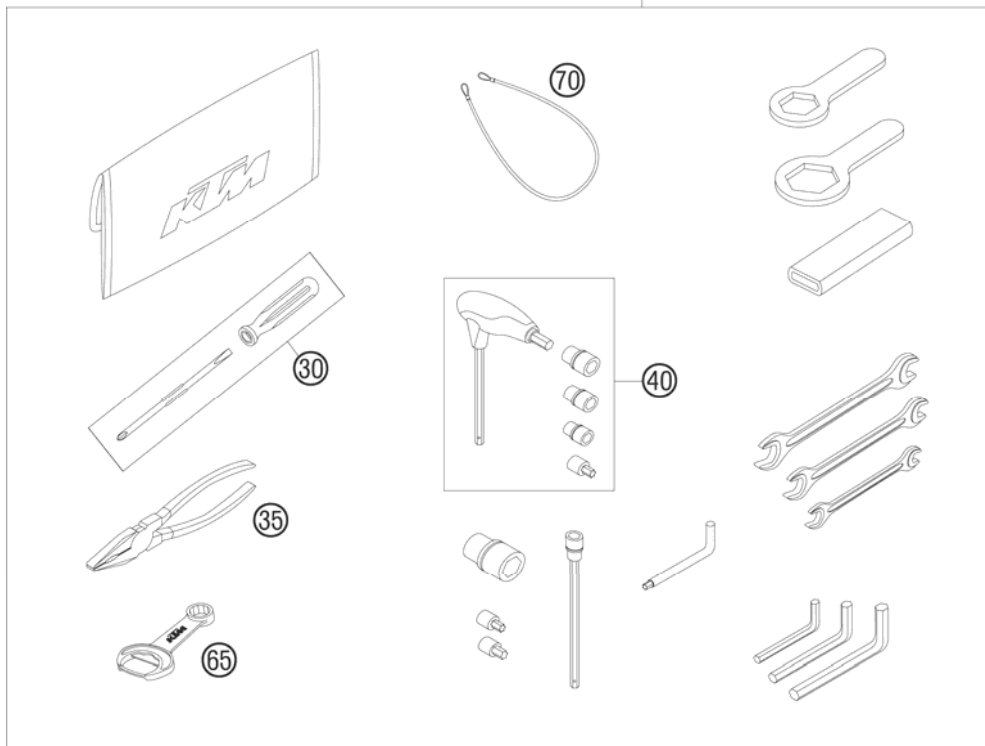

FIG	PART NUMBER	DESCRIPTION	QTY
0	0021060003	WASHER DIN9021-A 6,4	4
0	0024060156	HH COLLAR SCREW M6X15 TX30	4
0	0125050003	WASHER DIN0125-A 5,3	2
0	0966050163	OVAL HEAD SCREW DIN0966-M 5X16	2
0	0985050003	SELF LOCKING NUT DIN0985-M 5	2
0	0985060003	SELF LOCK. NUT DIN0985-M 6	4
0	312305	DOCUMENTS BAG 2006	1
0	312313	KTM BALLPOINT PEN ORANGE	1
0	3210039	CUSTOMER WELCOME LETTER	1
0	40006006000	WASHER 6MM	2
0	58412040050	SUPPORT FOR MIRROR LC4 '98	2
0	58412080000	REFLECTOR RED LC4 '98	1
0	58412080050	BRACKET FOR REFLECTOR	1
0	60012081200	LICENCE FITTING 06	1
0	61112040000	REVIEW MIRROR L/S 07	1
0	61112041000	REVIEW MIRROR R/S 07	1
1	3211519EN	OWN.MAN. 990 SM/SM-R/SM-T 2010	1
12	61129099000	TOOL SET 08	1
30	53012024100	SCREW DRIVER L=105MM	1
35	53012028200	GRIP ORANGE B&F	1
40	60029070200	T-WRENCH WS=6/8/10 TX=45 B&F	1
65	50329071100	WRENCH WS=13 B&F + OPENER	1
70	60012015000	HELMET LOCK 04	1

086012001 / C106202000

* NEW PART

X AS REQUIRED







KTM-Sportmotorcycle AG
A-5230 Mattighofen
www.ktm.at

KTM Group Partner



3CF9803J9EN



Art.Nr.: 3CF9803J9EN 11/2009