



990 ADVENTURE DAKAR EDITI EU 2011



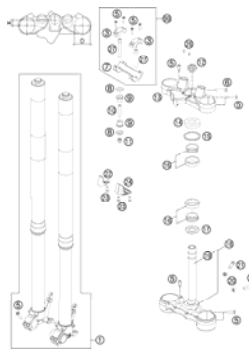
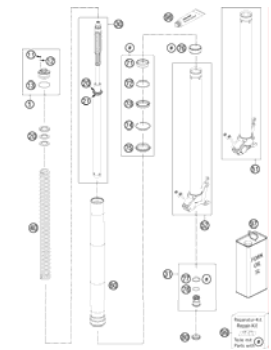
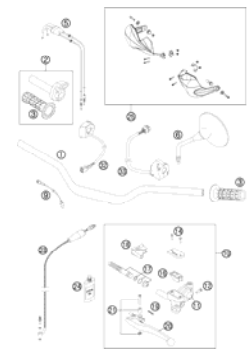
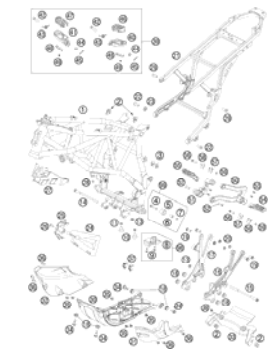
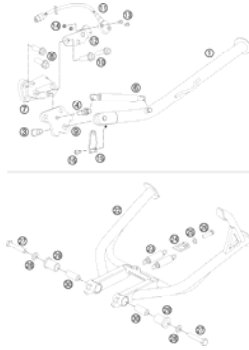
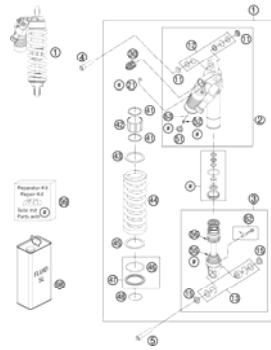
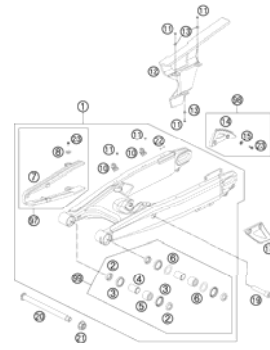

SPARE PARTS MANUAL: CHASSIS

ART.NO.: 3CF9803KBEN

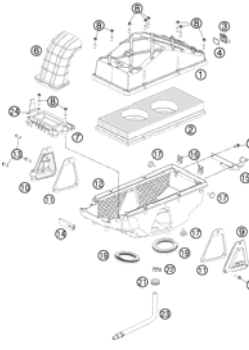
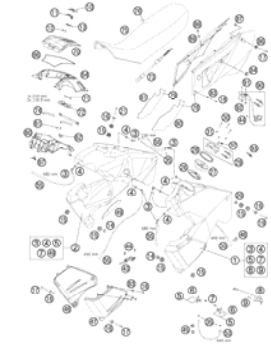
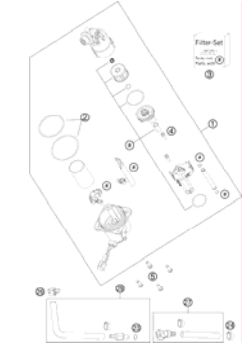
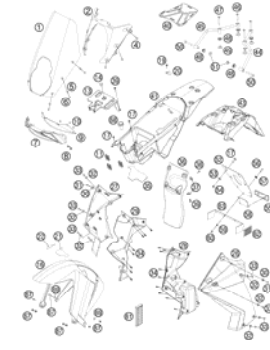
ENGLISH

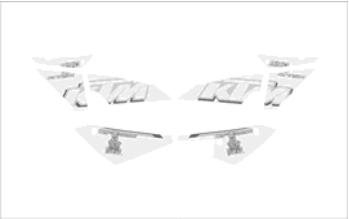
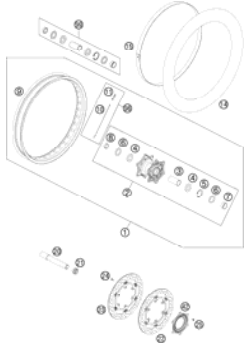
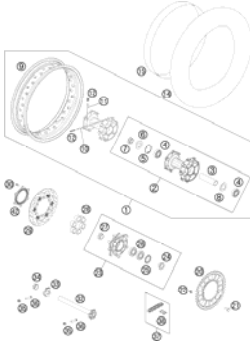

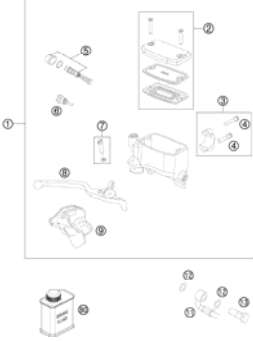
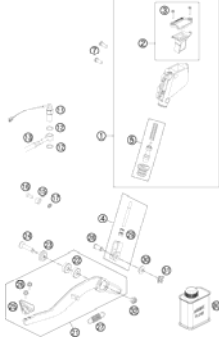
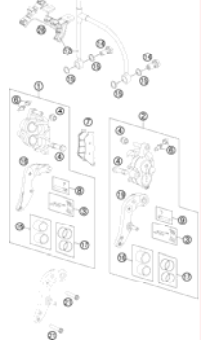
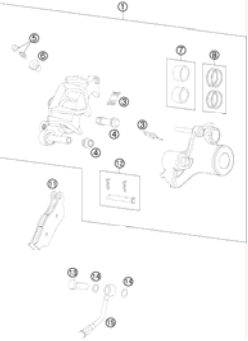
<p>FRONT FORK, TRIPLE CLAMP</p>  <p>4</p>	<p>FRONT FORK DISASSEMBLED</p>  <p>5</p>	<p>HANDLEBAR, INSTRUMENTS</p>  <p>6</p>	<p>FRAME</p>  <p>7</p>
<p>SIDE- CENTER STAND</p>  <p>9</p>	<p>MONOSHOCK</p>  <p>10</p>	<p>SWING ARM</p>  <p>11</p>	<p>EXHAUST SYSTEM</p>  <p>12</p>
<p>AIR FILTER BOX</p>  <p>13</p>	<p>TANK, SEAT, COVER</p>  <p>14</p>	<p>FUEL PUMP</p>  <p>16</p>	<p>MASK, FENDER</p>  <p>17</p>

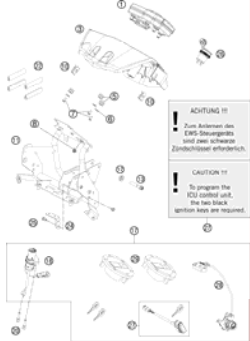
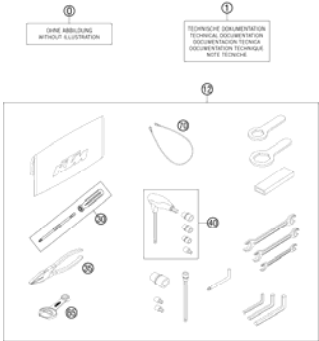
DECAL  19	FRONT WHEEL  20	REAR WHEEL  21	WIRING HARNESS  22
BATTERY  24	HAND BRAKE CYLINDER  25	REAR BRAKE CONTROL  26	BRAKE CALIPER FRONT  27
BRAKE CALIPER REAR  28	LIGHTNING SYSTEM  29	INSTRUMENTS, LOCK SYSTEM  30	ACCESSORIES KIT  31

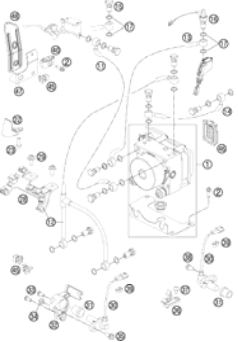
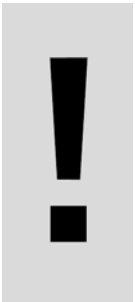
<p>ANTI-SKID SYSTEM ABS</p>  <p>32</p>			
	 <p>All information contained is without obligation. KTM-Sportmotorcycle AG particularly reserves the right to modify any equipment, technical specifications, prices, colors, shapes, materials, services, service work, constructions, equipment and the like so as to adapt them to local conditions or to cancel any of the above items, all without previous announcement and without giving reasons. KTM may stop manufacturing certain models without previous notice. KTM shall not be held liable for any deviations of availability and/or ability to deliver, illustrations, descriptions, printing and/or other errors. The illustrated models partly contain extra equipment, which is not applied to standard models. © by KTM-SPORTMOTORCYCLE AG, Mattighofen AUSTRIA; All rights reserved; Reprint, also in extracts, with written allowance of KTM-SPORTMOTORCYCLE AG, Mattighofen only.</p>		

FRONT FORK DISASSEMBLED

990 ADVENTURE DAKAR EDITI EU 2011

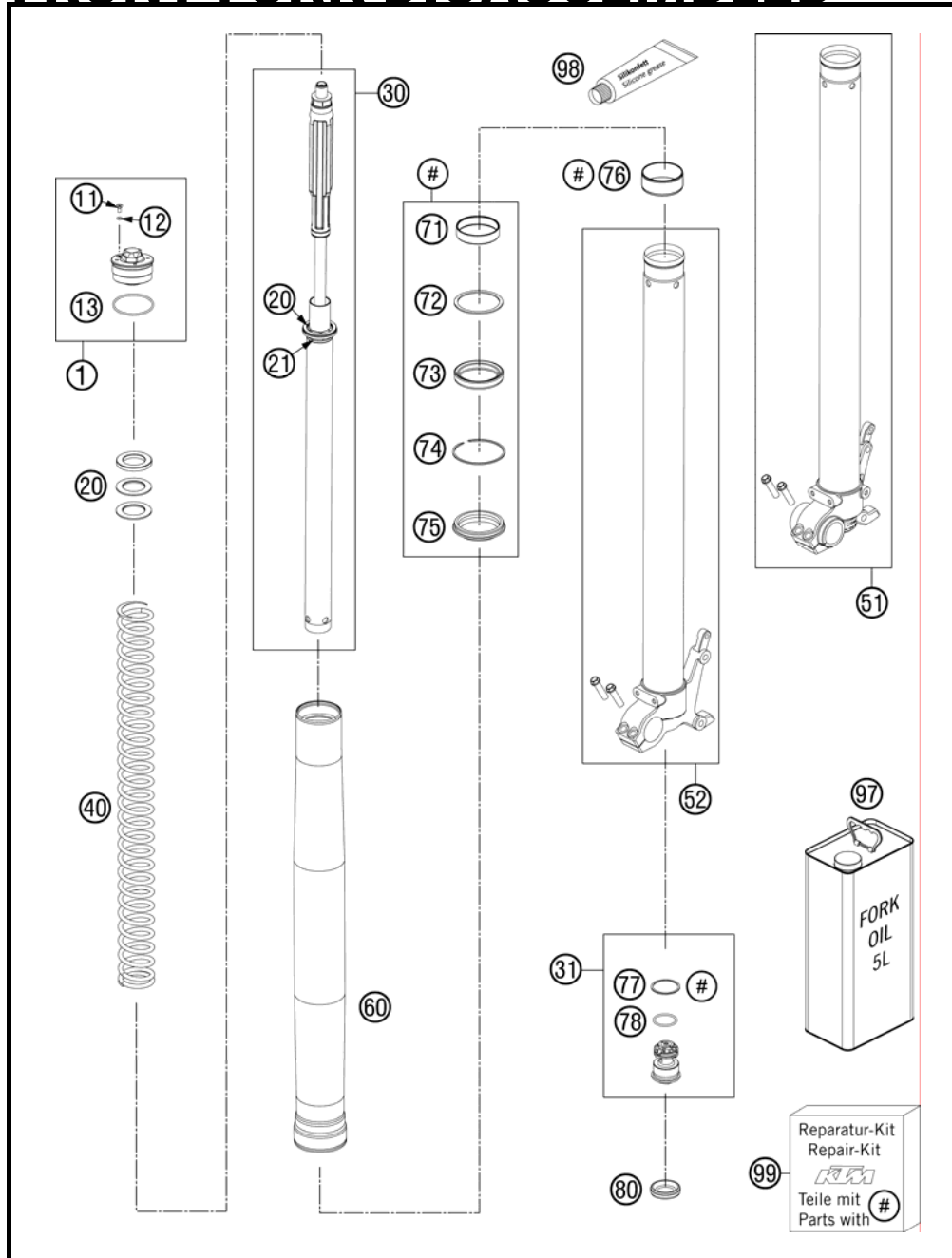

FIG	PART NUMBER	DESCRIPTION	QTY
1	48600431S	PRE-LOAD ADJ. CPL. M51X1,5 05	2
11	48600481	VENT SCREW M4X8	2
12	48600046	O-RING NBR 3X1,5	2
13	46810340	O-RING NBR 45X2	2
20	48600036	SPACER 42X26,5X2,5	2
20	48600037	SPACER 42X26,5X5	2
20	48600053	SPACER 42X26,5X1,5	2
21	48600021	INTERM. RING 26,2 X 43 X 3	2
30	48600140S	CARTRIDGE CPL. ADV ABS 07	1
31	48600586S2	TAP COMPRESSION CPL.	2
40	91410040S	SPRING 4,8N/MM SET D=5,25MM	1
40	91410041SA	SPRING 432.465.00.046W d5.25	x
40	91410042SA	SPRING 432.465.00.050W d5.25	x
51	48600872S1	AXLE CLAMP LEFT ADV. CPL. 09	1
52	48600873S1	AXLE CLAMP RIGHT ADV. CPL. 09	1
60	48600553E	OUTER TUBE L=640MM D=54/60 06	2
71	48600429	DU-BUSH D48XD52X12DDL02	2
72	48600013	SUPPORT RING 50 X 57,6 X 1,5	2
73	48600399	OIL SEAL RING 48X57,8X9,5	2
74	48600070	LOCK WASHER SB58	2
75	48600400	DUST CAP D=48 58,4X11,8	2
76	48600428	DU-BUSH D47XD49X20DDL02	2
77	48600004	COPPER WASHER 29,5X33,5X1	2
78	35480320	O-RING NBR 24X2	2
80	48600141	RUBBER CAP D=35MM	2
97	48600765S1	FORK OIL SAE5 5L 2008	1
98	T511	SILICONE GREASE F. DUST STRI	1
99	R14013	REPAIR-KIT EXC FRONT FORK06/07	1

116010130 / C116010130

* NEW PART

X AS REQUIRED

HANDLEBAR, INSTRUMENTS

990 ADVENTURE DAKAR EDITI EU 2011

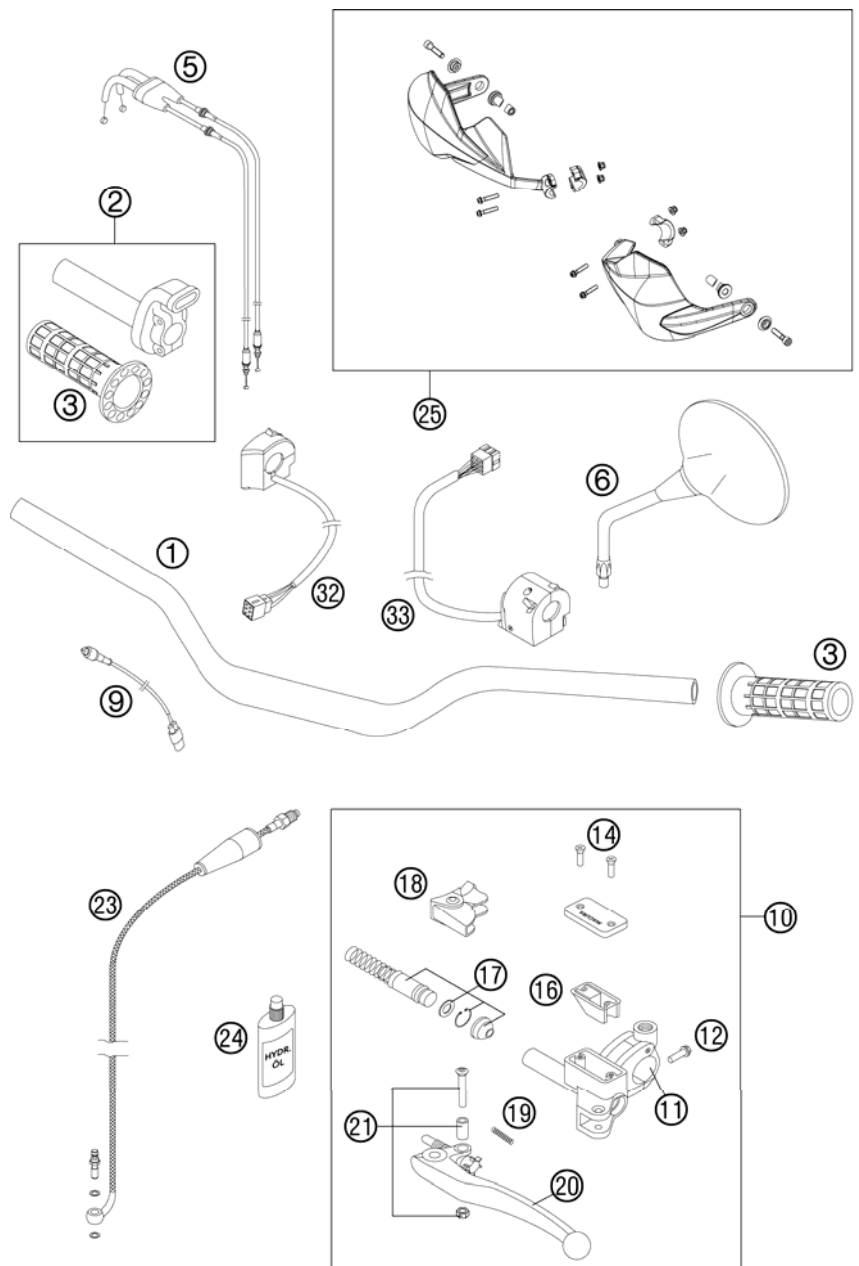

FIG	PART NUMBER	DESCRIPTION	QTY
1	60002001100	HANDLEBAR D=28MM NEKEN '08	1
2	58702010000	THROTTLE GRIP CPL. DUKE 2000	1
3	58302021100	GRIPP SET FULL WAFFLE	1
5	60002091000	THROTTLE CABLE LC8 ADV 2003	1
6	58412040100	REAR MIRROR L/S+R/S LC4 2001	2
9	58411049100	CLUTCH SWITCH '03	1
10	60002130000	MASTER CYLINDER MAGURA D=10.5	1
11	60002044000	CLAMP MIRROR WITH CLAMP	1
12	0025060206	HH COLLAR SCREW M6X20 TX30	1
14	0965040123	FLAT HEAD SCREW DIN0965-M 4X12	2
16	50302034000	RUBBER FOR RESERVOIR '98	1
17	50302032000	REP.SET PISTON MAGURA D=10.5	1
18	50302037000	PROTECT.CAP FOR LEVER PERCH'98	1
19	59002035000	SPRING FOR CLUTCH LEVER '03	1
20	60002031000	CLUTCH LEVER LONG CPL. 2003	1
21	50302038000	LEVER SCREW CPL. 125-200 '98	1
23	60032063100	CLUTCH PIPE LC8 ADV '03	1
24	50302036200	OIL FOR HYD. CLUTCH 75ML	1
25*	6020217900004	HANGUARDS CLOSED, ORANGE	1
32	60011074100	START-STOP SWITCH '03	1
33	60011070000	LIGHT SWITCH A.D. '03	1

116010212 / C116010212

* NEW PART

X AS REQUIRED

FRAME

990 ADVENTURE DAKAR EDITI EU 2011

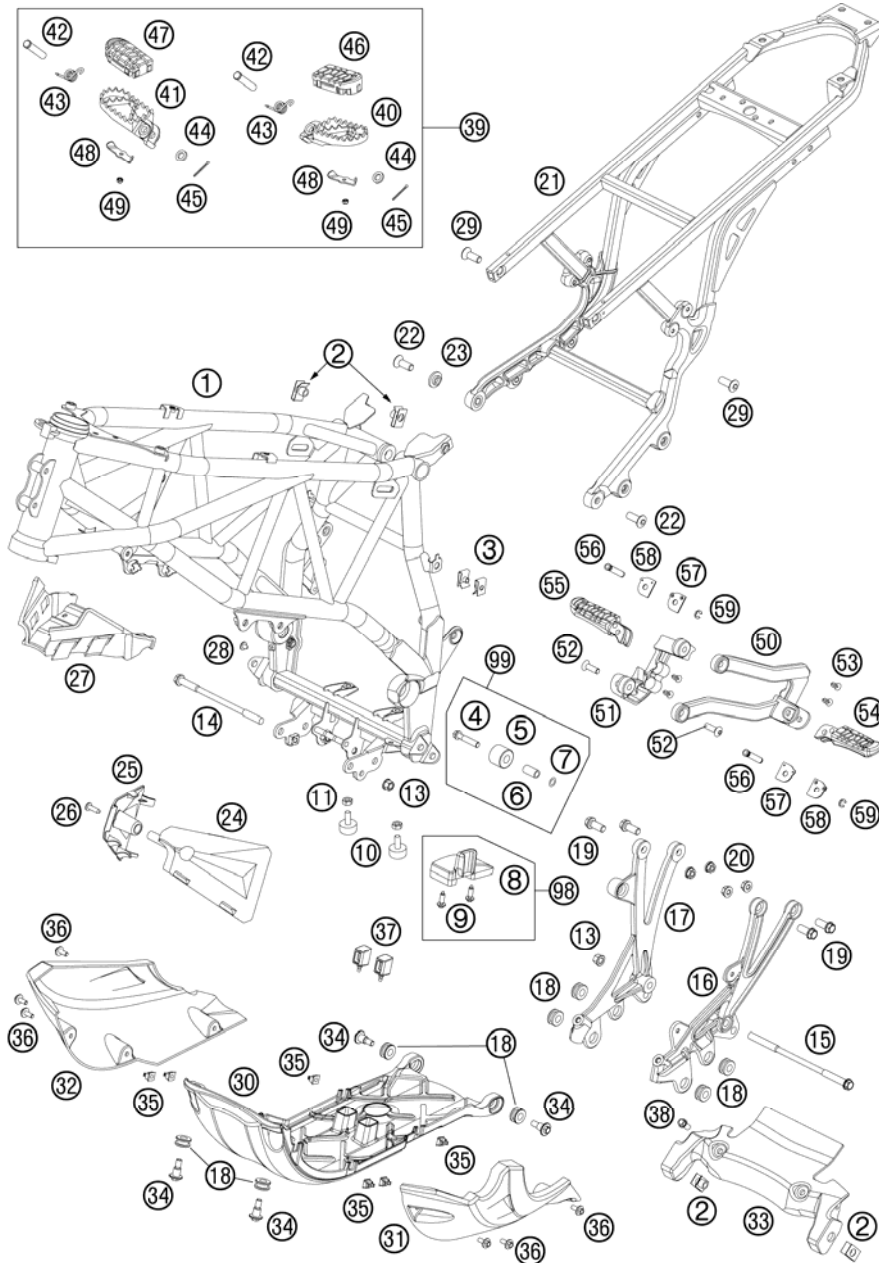

FIG	PART NUMBER	DESCRIPTION	QTY
1*	6010300120004	FRAME "601KA" ORANGE	1
2	54603048000	RANGE CHANGE METAL NUT M8	4
3	54603048100	RANGE CHANGE METAL NUT M6	2
4	0025080406	HH COLLAR SCREW M8X40 TX40	1
5	58403060000	CHAIN ROLL 12X29X22,5 '98	1
6	58403060065	BUSH CHAIN ROLL 8X12X23 '98	1
7	36003014000	LOCK WASHER 8MM	1
8	60004076100	CHAIN SLIDING BLOCK 05	1
9	0017060204	EJOT PT SCREW K60X20 ALU WS=6	2
10	58303070100	BUMP RUBBER M8X25MM	2
11	0934080003	HEXAGON NUT DIN0934-M 8	2
13	54630044000	COLLAR NUT M10 WS=13	2
14	60003013000	ENGINE BRAC. SCREW M10X172 03	1
15	60003014000	ENGINE BRAC. SCREW M10X206 03	1
16	6000300500001	ENGINE SUPPORT LEFT 07	1
17	6000300600001	ENGINE SUPPORT RIGHT 07	1
18	60003098000	RUBBER SLEEVE 03	8
19	0035100249	AH-COLLAR SCREW M10X24 ISA45	4
20	54310086100	SELF LOCKING NUT M10 CU WS=14	4
21	6000300200033	SUB FRAME BLACK 09	1
22	0019100239S	COUNTERSUNK SCREW ISA45 M10X23	2
23	60003001051	COLLAR BUSHING 10X15X25X4 03	1
24	62503085000	COVER FRAME L/S FRONT 05	1
25	62503086000	COVER FRAME R/S FRONT 05	1
26	0081050181	SCREW FOR PLASTIC K50X18 T20	1
27	60003087000	SPLASH PROTECTOR FRAME 05	1
28	60103088000	PLUG ZK 8/5 06	1
29	0019100289S	COUNTERSUNK SCREW ISA45 M10X28	2
30	6000309100092	UNDERRIDE PROTECTION 10	1
31	60003092100	UNDERRIDE PROTECTION LEFT 06	1
32	60003093100	UNDERRIDE PROTECTION RIGHT 06	1
33	6000309400092	LOWER TANK HOLDER FRONT 10	1
34	60003097000	COLLAR SCREW M8 03	4
35	60003095000	CAGE NUT M6 SL 4MM 03	6
36	0024060156	HH COLLAR SCREW M6X15 TX30	6

116010310 / C116010311

* NEW PART

X AS REQUIRED

FRAME

990 ADVENTURE DAKAR EDITI EU 2011

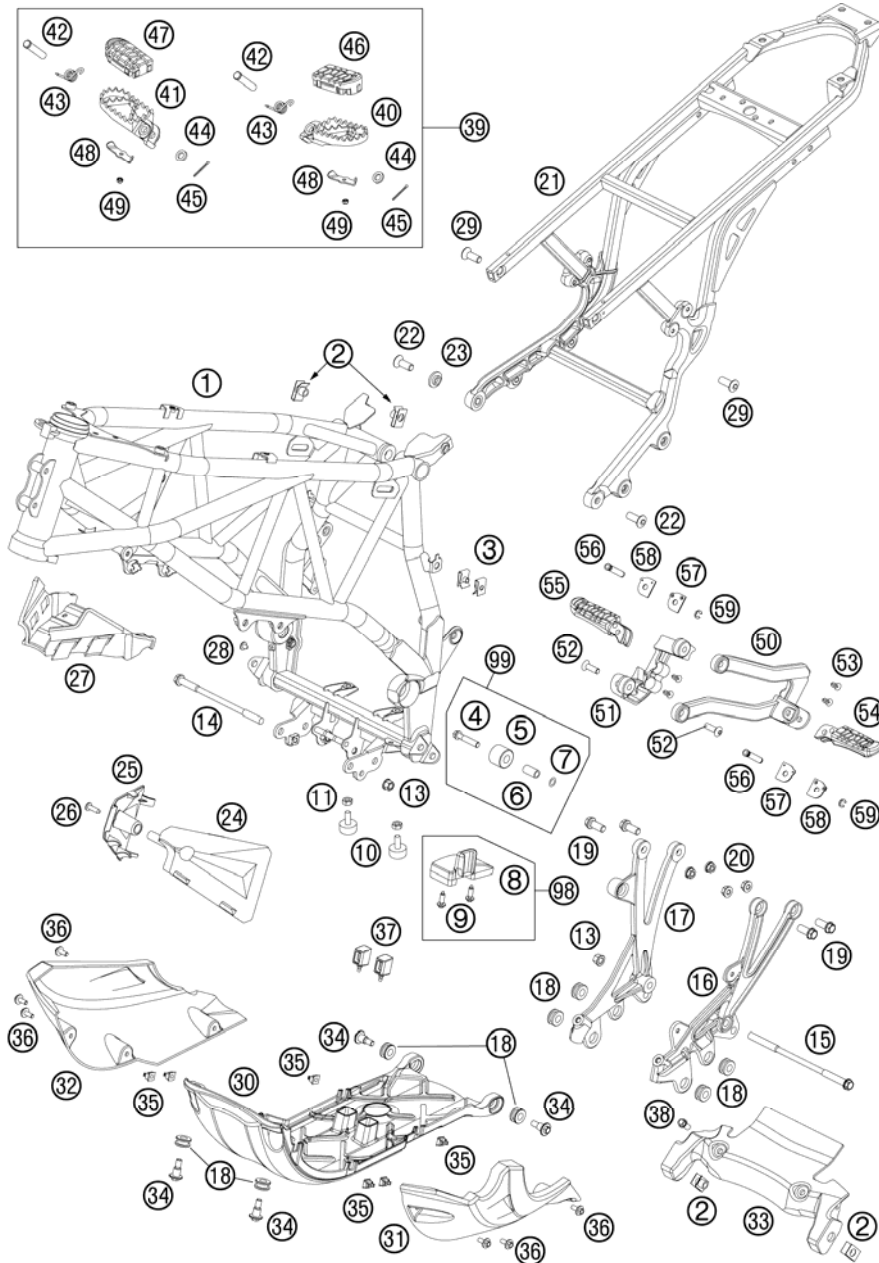

FIG	PART NUMBER	DESCRIPTION	QTY
37	60003096000	VIBRATION DAMPER 03	2
38	0025080166	HH COLLAR SCREW M8X16 TX40	2
39	60003040033	FOOTPEG L/S+R/S CPL. 03	1
40	59003040250	FOOT PEG L/S SILVER 02	1
41	59003041250	FOOT PEG R/S SILVER 02	1
42	54803044000	BOLT FOR FOOT PED 03	2
43	54603041000	FOOTREST SPRING L/S & R/S	2
44	0125100003	WASHER DIN0125-A10,5	2
45	0094032253	PIN DIN0094-3,2X25 STEEL	2
46	60003040010	FOOTREST RUBBER FRONT L/S 03	1
47	60003041010	FOOTREST RUBBER FRONT R/S 03	1
48	60003044010	CLOSING PANEL FRONT L/S R/S 03	2
49	0985050003	SELF LOCKING NUT DIN0985-M 5	2
50	6000304800033S	FOOTREST BRACKET REAR L/S 09	1
51	6000304900033S	FOOTREST BRACKET REAR R/S 09	1
52	0019080266S	COUNTER-SUNK SCREW ISA45 M8X26	4
53	54403135000	PLASTIC CAP SFL10	4
54	60003050000	FOOTREST CPL. L/S REAR 03	1
55	60003051000	FOOTREST CPL. R/S REAR 03	1
56	60003044000	BOLT FOR FOOTREST REAR 03	2
57	60003152000	ENGAGE PANEL FOOTREST L/S 03	2
58	60003052000	ENGAGE PANEL FOOTREST R/S 03	2
59	0799060003	TAB WASHER DIN6799-RS 6,0	2
98	60004076110	CHAIN SLIDING KIT BELOW	x
99	58403060010	CHAIN ROLL KIT	1

116010310 / C116010311

* NEW PART

X AS REQUIRED

SIDE-CENTER STAND

990 ADVENTURE DAKAR EDITI EU 2011

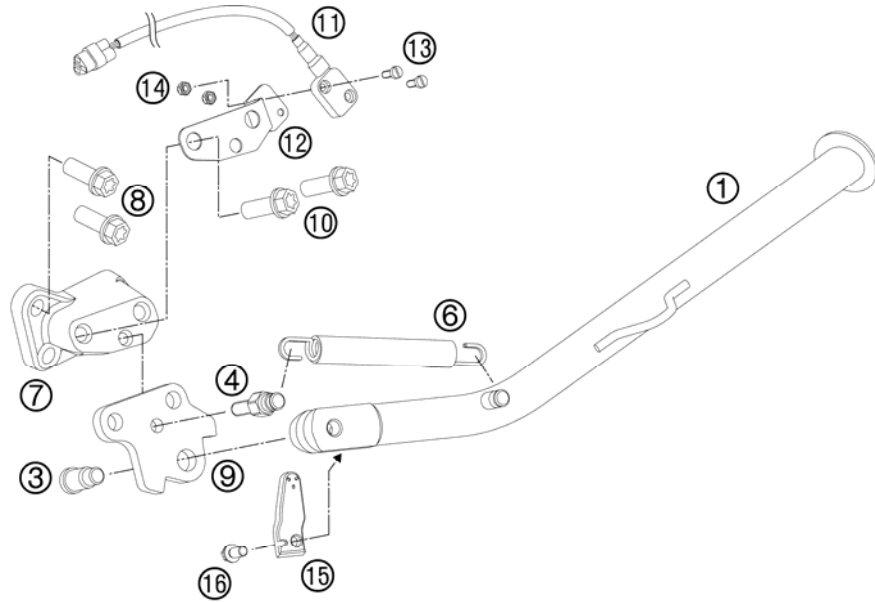
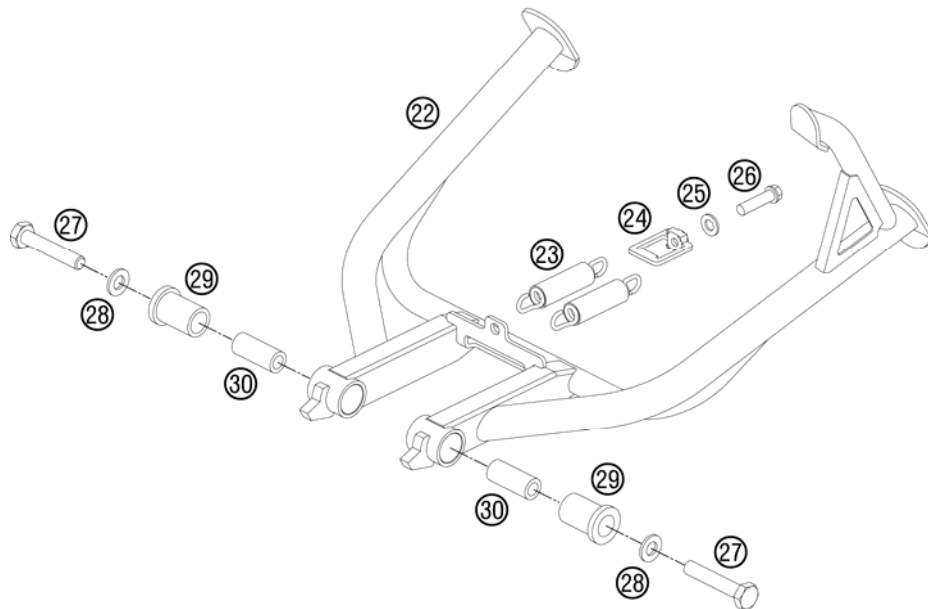

FIG	PART NUMBER	DESCRIPTION	QTY
1	6010302310030	SIDE STAND L=302MM 06	1
3	62503027200	SCREW FOR SIDE STAND M10X31,2	1
4	61003028001	SCREW SIDE STAND SPRING 05	1
6	61003024000	SPRING L=116 MM 05	1
7	60003026000	SIDE STAND BRACKET 03	1
8	0035100309S	AH-COLLAR SCREW M10X30 ISA45	2
9	60103028000	SIDE STAND PICKUP 06	1
10	0035100249	AH-COLLAR SCREW M10X24 ISA45	2
11	61011045000	SIDE STAND SENSOR 05	1
12	60103029000	SUPPORT F.SIDE STAND SWITCH 06	1
13	0084040123	CYL.HEAD SCREW DIN84A M4x12	2
14	0985040003	SELF LOCKING NUT DIN0985-M 4	2
15	60103029050	MAGNET HOLDER ADV. 06	1
16	0025060126	HH COLLAR SCREW M6X12 TX30	1
22*	6000302250033	CENTER STAND L=326MM 11	1
23	60003030000	SPRING FOR CENTER STAND 03	2
24	60003022115	SPRING TENSIONER 03	1
25	0125080003	WASHER DIN0125-A 8,4	1
26	0025080306	HH COLLAR SCREW M8X30 TX40	1
27	56503093000	SPECIAL SCREW M10X55 WS=17	2
28	0125100003	WASHER DIN0125-A10,5	2
29	60003022020	BEARING BUSH CENTER STAND 03	2
30	60003022021	SPACER 10X16X38 MM 03	2



116010360 / C116010360

* NEW PART

X AS REQUIRED

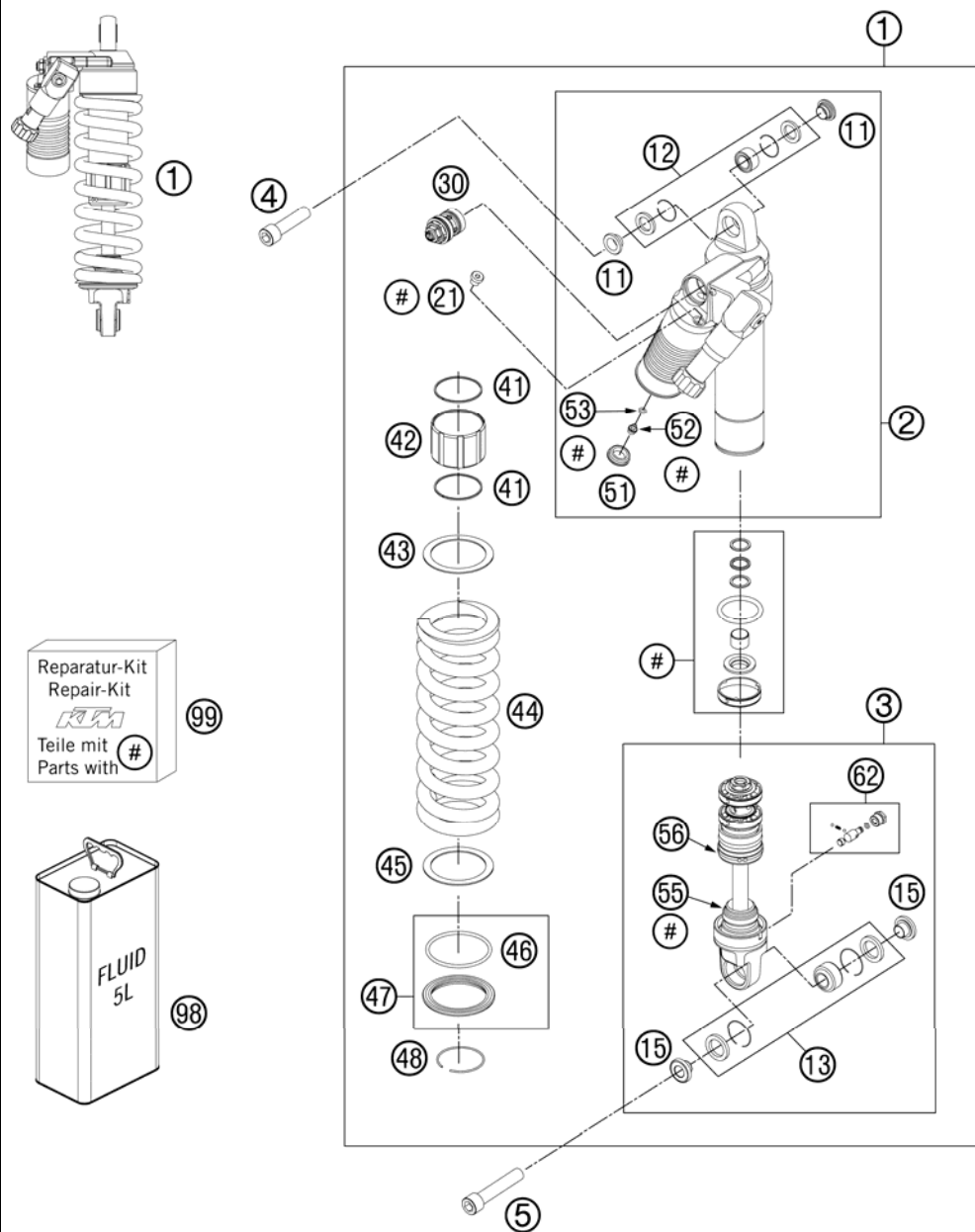

FIG	PART NUMBER	DESCRIPTION	QTY
1	12187E08	MONOSHOCK 990 ADVENTURE	09
2	50180412S1	MONOSHOCK UPPER PART CPL.	07
3	50180358S3	MONOSHOCK LOWER PART CPL.	07
4	60004016000	SCREW M14X1,5 L=55MM	03
5	60004017000	SCREW M14X1,5 L=73MM	03
11	50180366	ADAPTOR BUSH KGW 14X24	2
12	R12012	REP. KIT BEAR./SEAL UP.	07
13	R12013	REP. KIT BEAR./SEAL LOWER ADV	07
15	50180365	ADAPTOR BUSH KGW D=32 14X32	2
21	50180095	BLEED PLUG R 1/8	1
30	50180213S4	DCC-COMPR.DAMP.CONTROL CPL.	03
41	50180133	CIRCLIP 50X1,5	2
42	50180081	SPRING GUIDANCE L=40	1
43	50180114	SPACER RING FOR SPRING	1
44	91210035SA	SPRING 140-225 (62) D=14,5	x
44	91210036SA	SPRING 150-225 (62) D=14,5	x
45	50180402	INTERM.RING SPRING RET. H=3,5	1
46	50180352	O-RING VITON 66,27X3,53	1
47	50180463S	SPRING RET. D=80 W. O-RING	05
48	50180273	CIRCLIP 58,2X2	1
51	46811208	RUBBER CAP "DO NOT OPEN"	1
52	36120151	SCREW PLUG M5X6	1
53	46810893	O-RING NBR 5,28X1,78	1
55	50180276	BUMP RUBBER WP60 D=18-26	1
56	50180165	COVER D=50	1
62	50180434S	ADJUSTING SCREW REBOUND TRAVEL	1
98	50180751S1	SHOCK ABSORBER FLUID 5 LT	1
99	R12008	REPAIR-KIT GASKET 5018 PDS	03

116010410 / C116010410

* NEW PART

X AS REQUIRED

SWING ARM

990 ADVENTURE DAKAR EDITI EU 2011

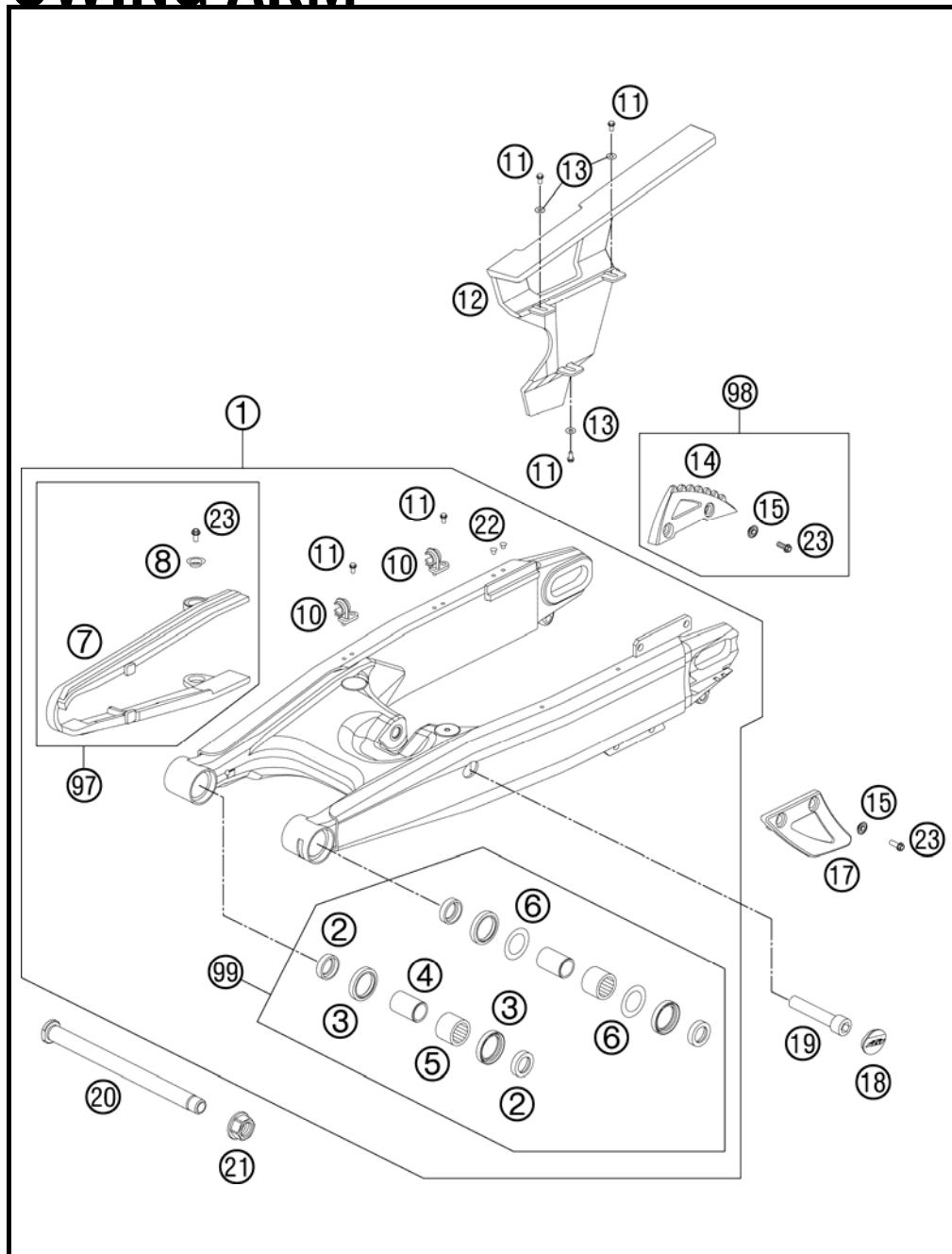

FIG	PART NUMBER	DESCRIPTION	QTY
1	6000403024433	SWINGARM CPL. LC8 AD. BLACK 09	1
2	60004034000	BUCKET F. SHAFT SEAL RING 03	4
3	0760304073	SHAFT SEAL RING 30X40X7	4
4	60004032000	INNER RING JR20X25X38,5 03	2
5	60004031000	NEEDLE BUSH HK2526B 03	2
6	60004033000	STOP DISK 03	2
7	60004066000	CHAIN SLID. GUARD SWINGARM 03	1
8	72210079000	BUCKET	2
10	60104042000	RET. CLAMP F. BRAKE HOSE	2
11	0009050106	EJOT SPIRAL SCREW SF M5X10-K	5
12	60004061100	CHAINGUARD 06	1
13	0021050003	WASHER DIN9021-A 5,3	3
14	60004075000	REAR SPROCKET GUARD 03	1
15	50308053000	BUSH FOR SPOILER 6X11X16X7,5	4
17	60004070000	CHAIN GUIDE 03	1
18	60004041000	PLUG SWINGARM 03	1
19	60004017000	SCREW M14X1,5 L=73MM 03	1
20	60004037244	SWINGARM BOLT CPL.	1
21	60004038000	COLLAR NUT M19X1,5 WS=27MM 03	1
22	60104043000	PLUG 06	2
23	59009062016	SPECIAL SCREW M6X16 WS=8 10.9	6
97	60004066010	CHAIN GUARD KIT ADV	1
98	60004075010	SPROCKET GUARD KIT	1
99	60004230010	SWINGARM REP. KIT	1

116010490 / C116010490

* NEW PART

X AS REQUIRED

EXHAUST SYSTEM

990 ADVENTURE DAKAR EDITI EU 2011

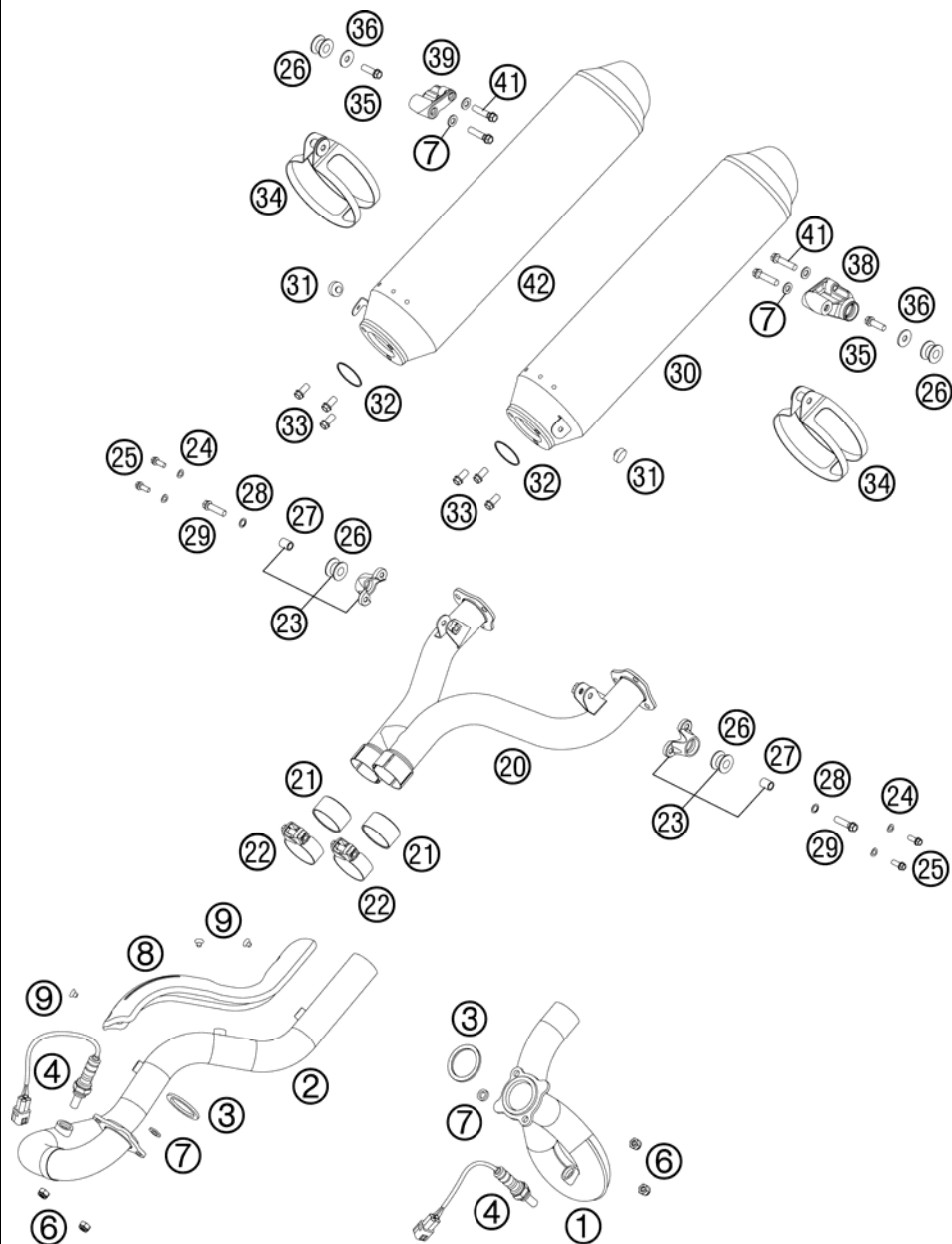

FIG	PART NUMBER	DESCRIPTION	QTY
1	60105008000	EXHAUST PIPE REAR 06	1
2	60105007000	EXHAUST PIPE FRONT 06	1
3	61005005000	EXHAUST GASKET 05	2
4	61041090000	LAMBDA SENSOR 05	2
6	51010086100	SELF LOCKING NUT M 8 CU	4
7	0125080003	WASHER DIN0125-A 8,4	6
8	60005011000	THERMAL SHIELD 05	1
9	0991060082	FLAT H.SCREW M6X8 DIN7991 NIRO	3
20	60005048000	DISTRIBUTOR TUBE LC8 03	1
21	60005005001	GRAPHIT RING 42X47X25 03	2
22	60105051000	CLAMP CPL. D=49,2MM 06	2
23	58405085044	SILENCER BRACKET CPL. 2001	2
24	0137060003	SPRING WASHER DIN0137-B 6	4
25	0025060206	HH COLLAR SCREW M6X20 TX30	4
26	54305068100	DAMP. COMPONENT SILICONE GREY	4
27	56505069000	SPACER BUSHING 8,4X12X16	2
28	36003014000	LOCK WASHER 8MM	2
29	0025080306	HH COLLAR SCREW M8X30 TX40	2
30	60105082100	SILENCER L/S 09	1
31	54308042000	RUBBER BUFFER	2
32	60005005002	EXHAUST GASKET 03	2
33	0025080166	HH COLLAR SCREW M8X16 TX40	6
34	60005095000	CLAMP FOR SILENCER CPL. 03	2
35	0025080256	HH COLLAR SCREW M8X25 TX40	2
36	0021080003	WASHER DIN9021-A 8,4	2
38	6000508500001S	SILENCER/HANDLE HOLDER L/S 07	1
39	6000508600001S	SILENCER/HANDLE HOLDER R/S 07	1
41	0025080356	HH COLLAR SCREW M8X35 TX40	4
42	60105083100	SILENCER R/S 09	1

116010510 / C116010510

* NEW PART

X AS REQUIRED

AIR FILTER BOX

990 ADVENTURE DAKAR EDITI EU 2011

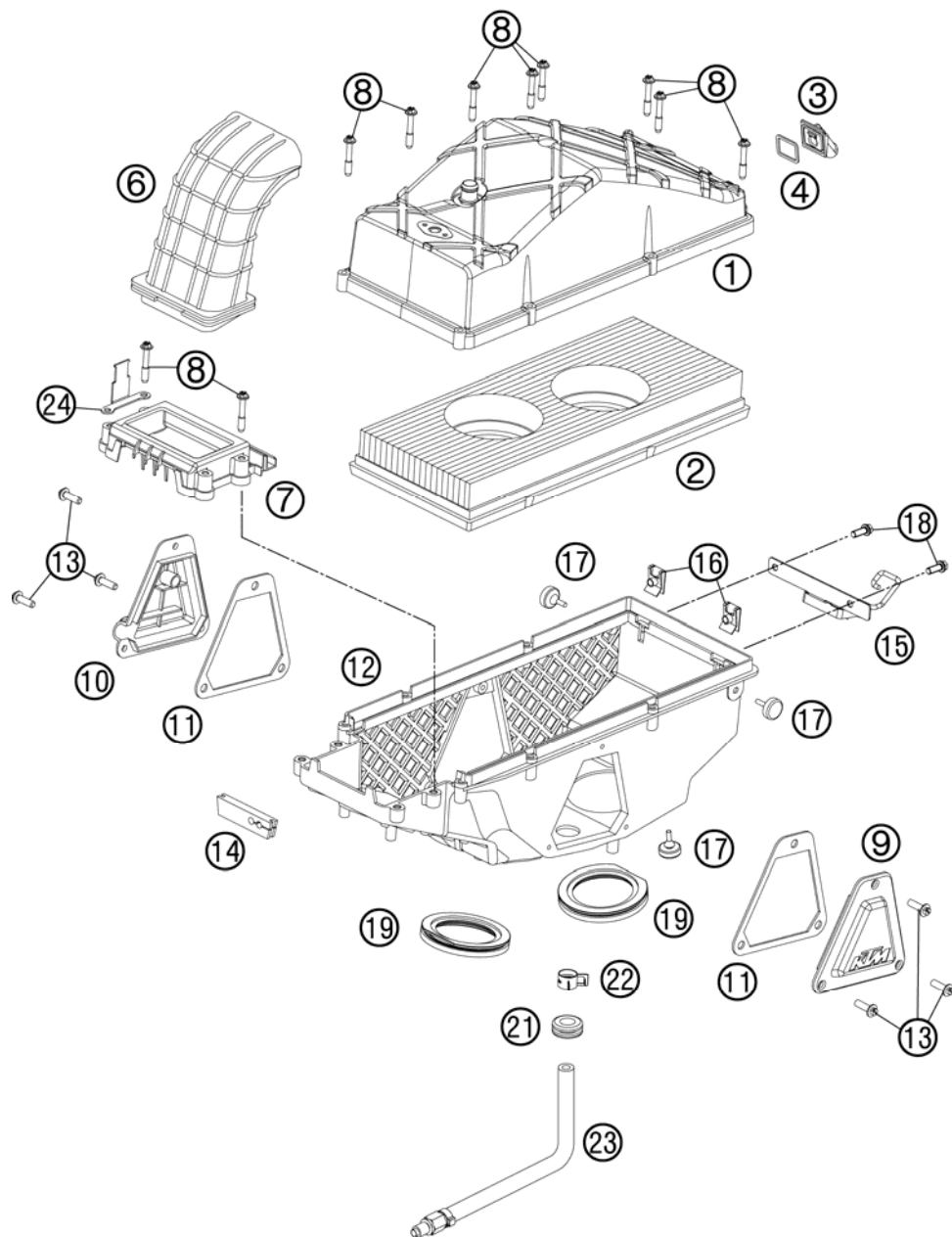

FIG	PART NUMBER	DESCRIPTION	QTY
1	61006002000	AIRBOX COVER 990 DUKE	04
2	61006015000	AIR FILTER EFI	05
3	60006007000	CONNECTOR FOR SAS LC8	03
4	60006007050	GASKET SAS CONNECTOR	03
6	60006040000	INTAKE SNORKEL	03
7	60006004000	AIRBOX FRONT PART LC8	03
8	60006006000	SPECIAL SCREW K60X35/15	03
9	60006003002	AIRBOX COVER L/S R/S	03
10	61006003002	AIRBOX COVER R/S EFI	05
11	60006003050	GASKET F. AIRBOX COVER L/S R/S	03
12	61006001000	FILTER BOX LOWER PART 990	05
13	0017060203	EJOT PT SCREW K60X20 WS=6	06
14	61006001030	RUBBER SLEEVE F. THR. CABLE	05
15*	62106001020	SLS BRACKET PANEL	01
16	54603048100	RANGE CHANGE METAL NUT M6	02
17	60006001021	DISTANCE RUBBER AIRBOX	03
18	0025060166	HH COLLAR SCREW M6X16 TX30	02
19	60036045000	RUBBER SLEEVE AIRBOX	03
21	60006001041	RUBBER SLEEVE FUEL HOSE	03
22	00049140121	CLAMP STD DN14	01
23	60107016150	FUEL HOSE 1 CPL.	01
24	60111022000	RETAINING PLATE IMMOBILIZER	01

116010610 / C116010610

* NEW PART

X AS REQUIRED

TANK, SEAT, COVER

990 ADVENTURE DAKAR EDITI EU 2011

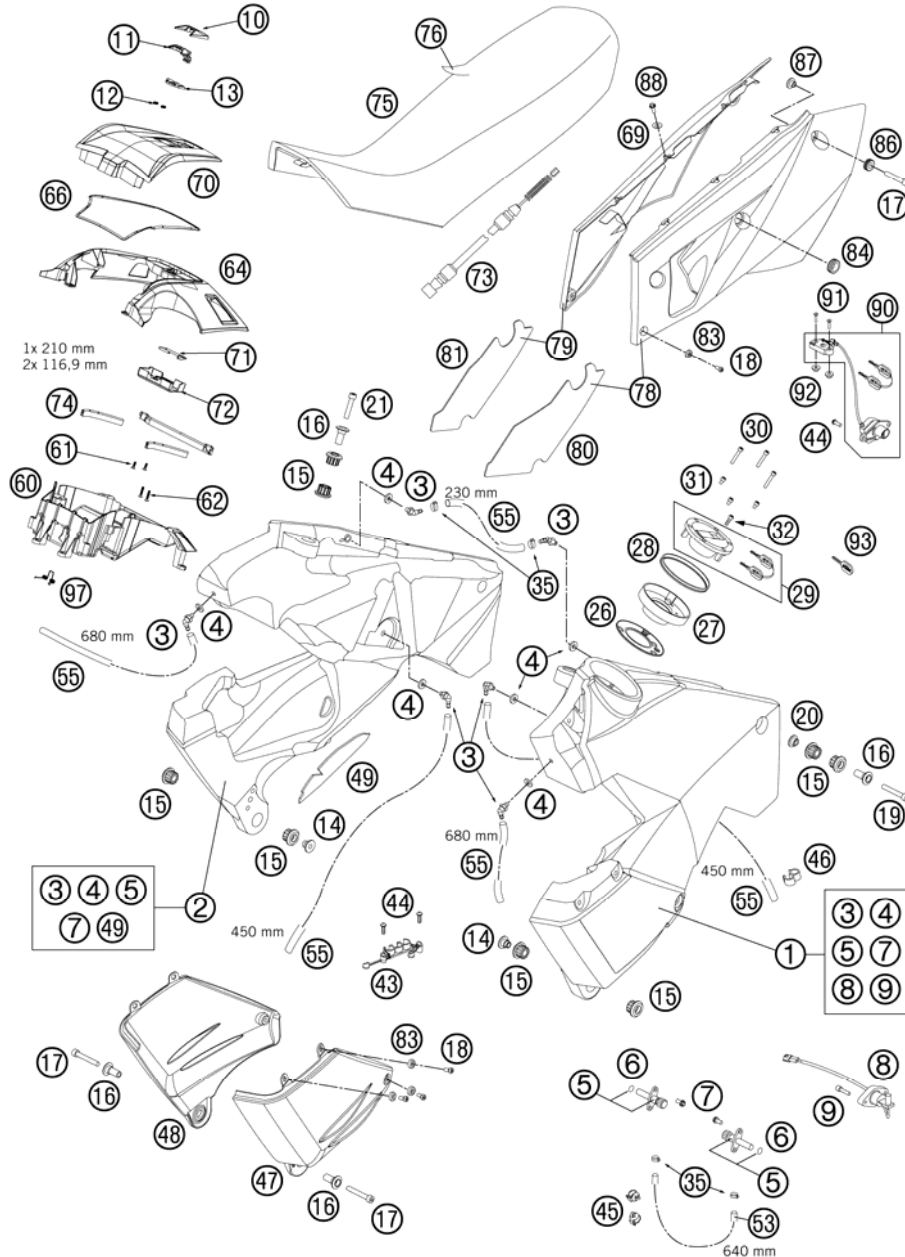

FIG	PART NUMBER	DESCRIPTION	QTY
1*	6010701324406B	FUEL TANK L/S CPL. BLUE DAKAR DECAL OVER-COATED	1
2*	6010711323306B	FUEL TANK R/S CPL. BLUE DECAL OVER-COATED	1
3	60007024000	CONNECT.PIECE F.OVERFLOW M7 03	4
4	60007024050	GASKET FOR CONNECTING PIECE 03	4
5	58507003000	FUEL COCK CPL. SMALL RALLYE'96	2
6	0770020130	O-RING 1,78x10,82x14,38 2-013	2
7	0025060126	HH COLLAR SCREW M6X12 TX30	6
8	58207080000	GAS-LEVEL SENSOR ADV. 2002	1
9	0912050163	AH SCREW DIN0912-M 5X16	2
10	60107020051	COVER PUSH BUTTON	1
11	60107020052	PUSH BUTTON	1
12	60107020053	COIL SPRING	2
13	60107020054	PUSH BUTTON SUPPORT	1
14	60007062000	BEAR.BUSH.INSIDE L=15,5MM 03	2
15	60007065000	TANK RUBBER BUSHING 03	12
16	60007060000	BEARING BUSHING OUTSIDE 03	6
17	0912080553	AH SCREW DIN912 M8X55	4
18	0984060163	AH SCREW DIN6912-M 6X16	8
19	0912080503	AH SCREW DIN912 M8X50	2
20	60007061000	BEARING BUSHING INSIDE 03	2
21	0912080403	AH SCREW DIN912 M8X40	2
26	60007008051	SEAL. FLANGE F.TANK INSERT 03	2
27	60007008150	TANK INSERT 05	2
28	60007008052	SEAL. RING F. TANK INSERT 03	2
29	60007108000	TANK PLUG	2
30	0912050303	AH SCREW DIN0912-M 5X30	6
31	0912050083	AH SCREW DIN 912 M 5X8	6
32	0912050123	AH SCREW DIN0912-M 5X12	2
35	58031005000	CLAMP YDNAC 10128 12MM	2
43	60011057000	HOSE HOLDER TRIPLE 03	1
44	0081050181	SCREW FOR PLASTIC K50X18 T20	4
45	57013072100	WIRING HOLDER 16MM	2
46	55011022100	CLAMP D=6/8MM, BLACK	1

116010710 / C116010713

* NEW PART

X AS REQUIRED

TANK, SEAT, COVER

990 ADVENTURE DAKAR EDITI EU 2011

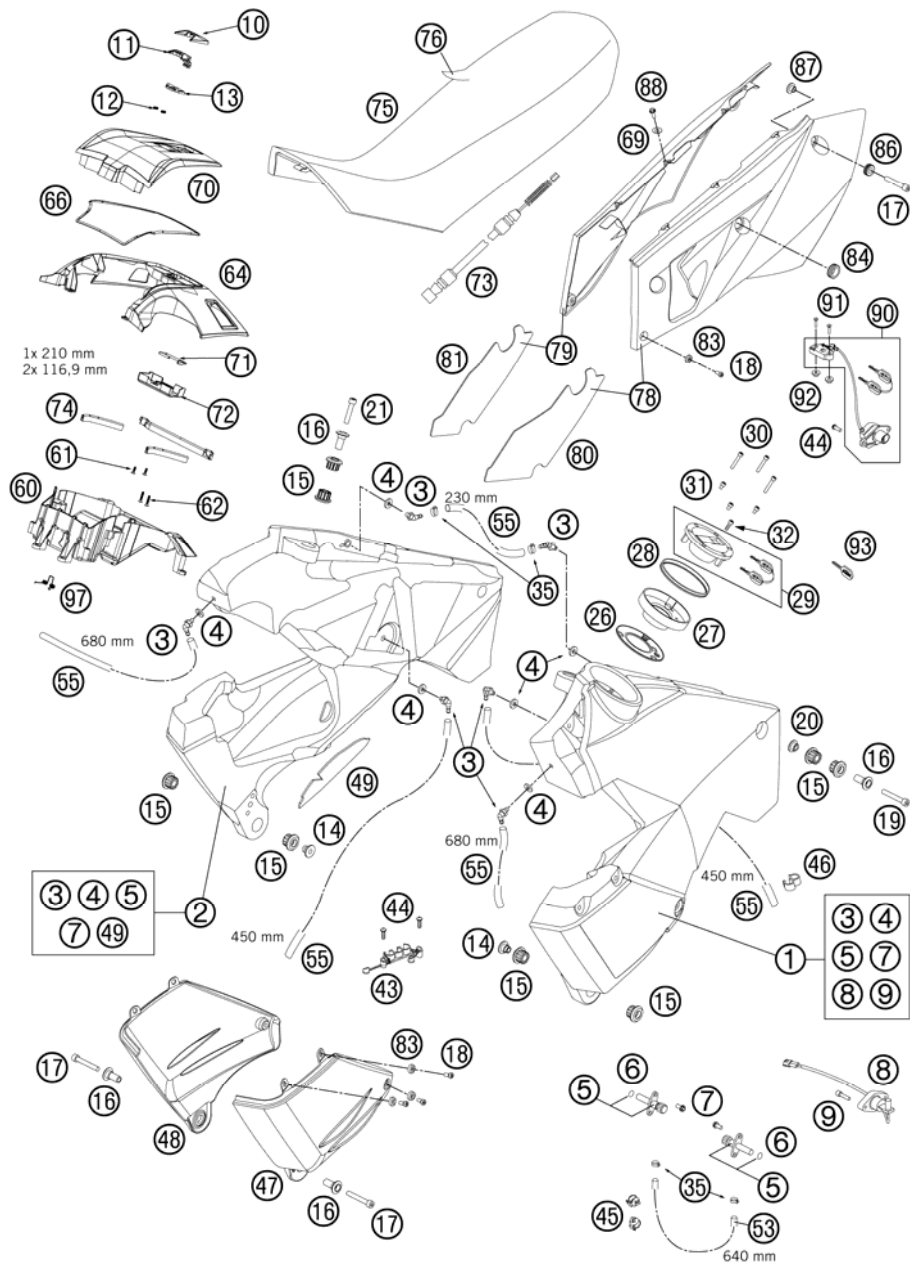

FIG	PART NUMBER	DESCRIPTION	QTY
47	60107013050	TANK PROTECTOR L/S 06	1
48	60107113050	TANK PROTECTOR R/S 06	1
49	60007095100	THERMAL PROTECT. FOIL TANK 07	1
53	60007216640	HOSE 6X13 L=640 MM 09	1
55	78015019000	HOSE EPA D=6/10 L=2000MM	x
60	60107023000	STORAGE BOX BOTTOM PART	1
61	0081030103	SCREW K30X10 T10	2
62	0081030163	SCREW K30X16 T10	2
64	6010701900033	STOR.BOX CENT.PART BLACK 09	1
66	60107020070	COVER GASKET	1
69	60007020040	PLASTIC WASHER 03	6
70	6010702000033	COVER FOR STORAGE BOX 09	1
71	60107019082	LOCK BOLT STORAGE COMPARTMENT	1
72	60107019080	SUPPORT F. LOCK BOLT	1
73	60107032000	STORAGE BOX CABLE	1
74	58312085100	EDGE PROTECTOR PER METER	x
75*	60007040300	SEAT BLACK	1
76*	60007040350	SEAT COVER	1
78*	6010804100006C	SIDE COVER L/S REAR " DAKAR "	1
		DECAL OVER-COATED	
79*	6010804200006C	SIDE COVER R/S REAR " DAKAR "	1
		DECAL OVER-COATED	
80	60008041150	THER.PROT.FOIL SI. CO. L/S 07	1
81	60008042150	THER.PROT.FOIL SI. COV. R/S 07	1
83	60008045000	SPECIAL WASHER D=16,5MM 03	8
84	60107053000	RUBBER SLEEVE F.SEAT LOCK 09	1
86	41001052000	RUBBER SLEEVE D=12MM	2
87	60012008002	COLLAR BUSHING 8,2X12X20X9 03	2
88	0017060203	EJOT PT SCREW K60X20 WS=6	6
90	60107050000	SEAT LOCK	1
91	0738060301	COU.SUNK SCR. AH ISO7380 M6X30	2
92	60008013050	DISTANCE BUSH. 7X12X18X3,7 03	2
93	40011166100	KEY BLANK LC4/DUKE/LC8	x
97	60107023080	STORAGE COVER BOX SPRING	1

116010710 / C116010713

* NEW PART

X AS REQUIRED

FUEL PUMP

990 ADVENTURE DAKAR EDITI EU 2011

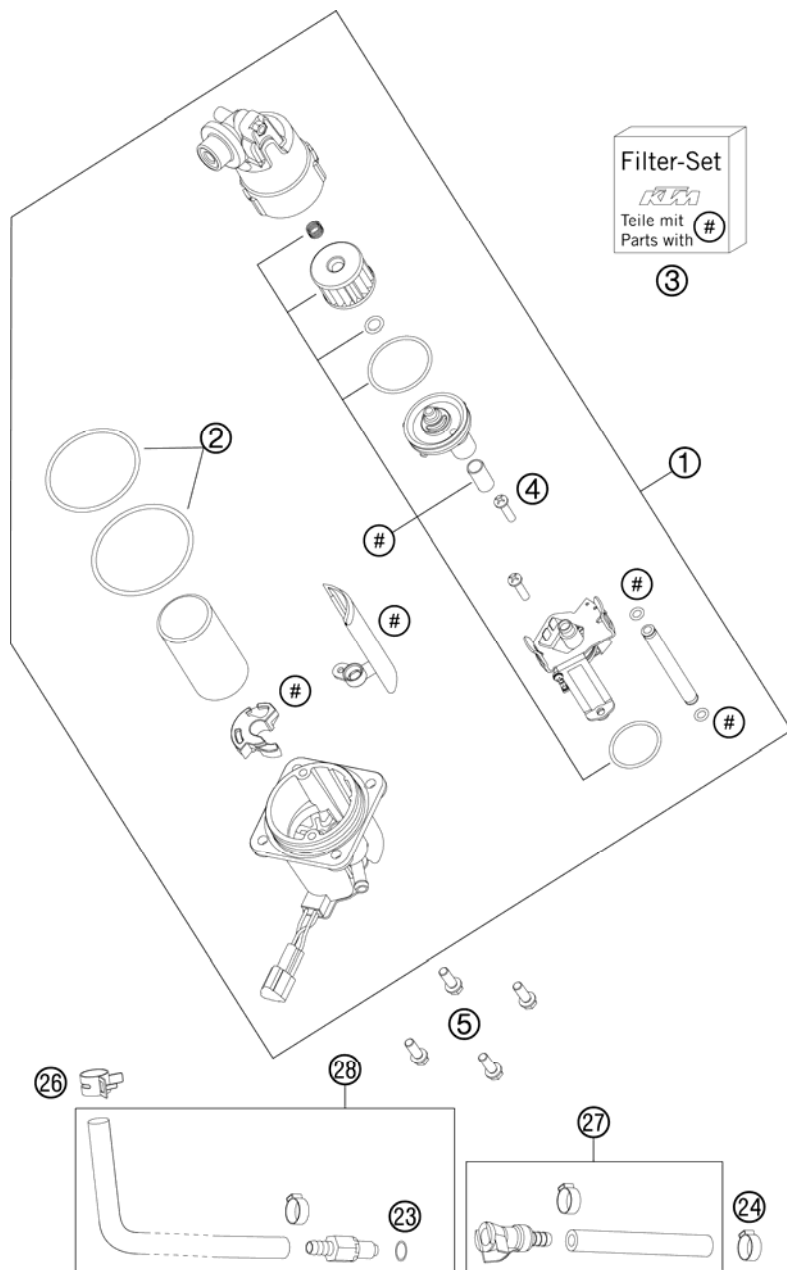

FIG	PART NUMBER	DESCRIPTION	QTY
1	61007088100	PUMP WITHOUT RESERVE INDICATOR	1
2	61007089000	O-RING SET FOR FUEL PUMP 05	1
3	61007090000	FILTER-SET FUEL PUMP 05	1
4	61007091000	SCREW FOR FILTER-SET 05	2
5	0025060166	HH COLLAR SCREW M6X16 TX30	4
23	58507012000	O-RING VITON F. PLUG CPC 05	1
24	00050157706	VARIABLE ONE-EAR CLAMP 15,7MM	1
26	00049140121	CLAMP STD DN14	1
27	60107016151	FUEL HOSE CPL. 08	1
28	60107016150	FUEL HOSE 1 CPL.	1

116010730 / C116010730

* NEW PART

X AS REQUIRED

MASK, FENDER

990 ADVENTURE DAKAR EDITI EU 2011

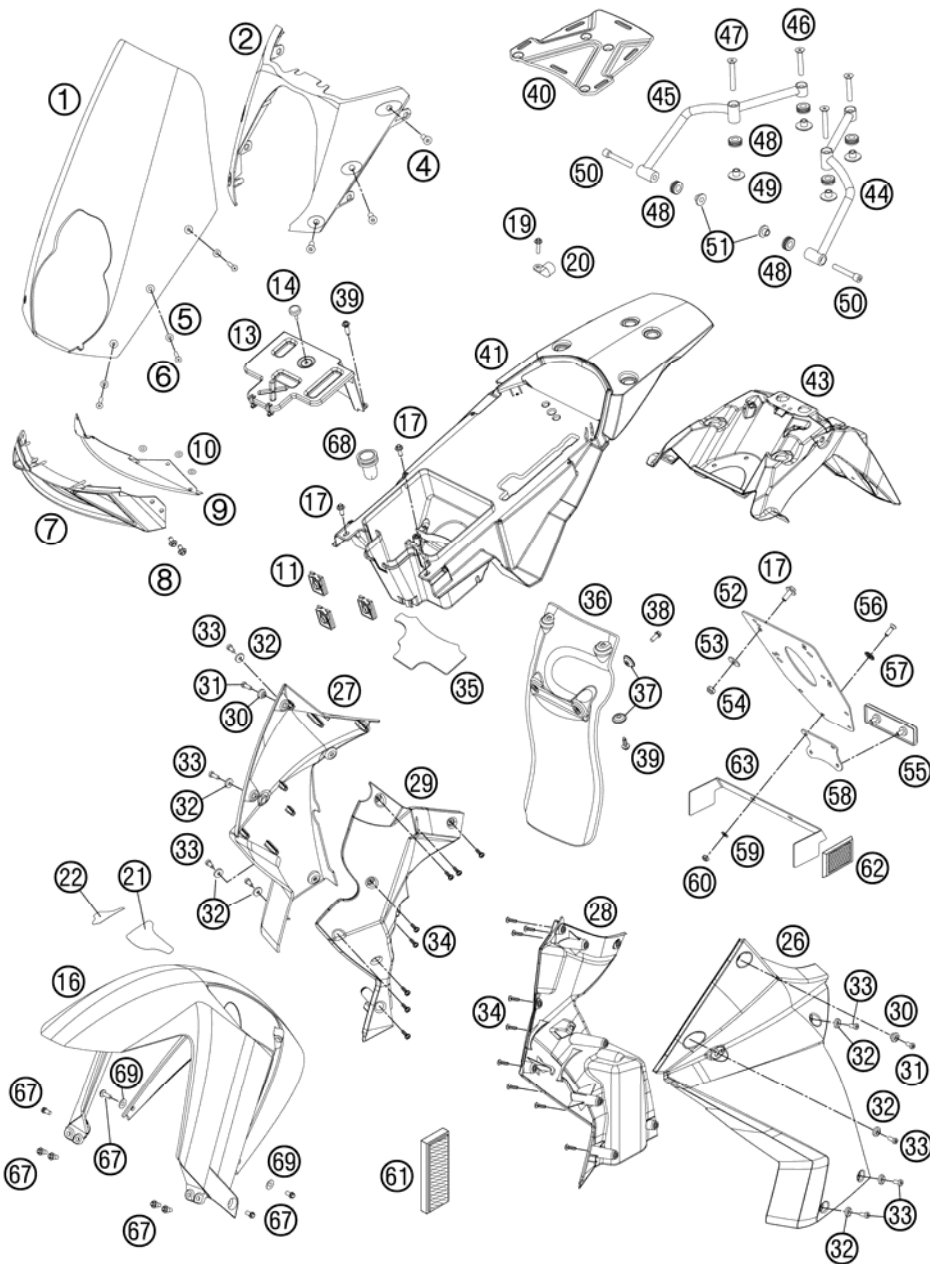

FIG	PART NUMBER	DESCRIPTION	QTY
1	60008008000	FAIRING SCREEN 03	1
2	60008001100	HEAD LIGHT MASK 07	1
4	60008008050	BLIND PLUG-IN NUT M5 WN 16A 03	6
5	60008046000	SPECIAL WASHER D=12MM 03	6
6	0019050201	COUNTERSUNK SCREW ISA25 M5X20	6
7	60008011000	AIR INTAKE 03	1
8	0024060106	HH COLLAR SCREW M6X10 TX30	4
9	60008011060	AIR INTAKE GRILL 03	1
10	60008011050	SPRING NUT 012410 03	6
11	60108017010	RUBBER SLEEVE 30X40 MM 06	3
13	60108017000	COVER F. STORAGE COMP. REAR 06	1
14	60006001021	DISTANCE RUBBER AIRBOX 03	1
16	6010801000006A	FRONT FENDER BLUE 06	1
17	0024060156	HH COLLAR SCREW M6X15 TX30	6
19	0081050181	SCREW FOR PLASTIC K50X18 T20	4
20	57013070000	PVC-CLAMP 7/16" HEYCO 3377	4
21	60108010060	PROTECTIVE FILM L/S 06	1
22	60108010070	PROTECTIVE FILM R/S 06	1
26*	6000805000006C	SIDE COVER L/S BLUE DECAL OVER-COATED	1
27*	6000805100006C	SIDE COVER R/S BLUE DECAL OVER-COATED	1
28	60008050150	INNER COVER LEFT 07	1
29	60008051150	INNER COVER RIGHT	1
30	60008052000	BUSH F. SIDE COVER 03	2
31	0984060163	AH SCREW DIN6912-M 6X16	2
32	60008045000	SPECIAL WASHER D=16,5MM 03	8
33	0012060123	AH SCREW DIN6912 M6X12	8
34	0081050121	SCREW FOR PLASTIC K50X12 T20	17
35	60008013160	THER.PROT.FOIL REAR FENDER 07	1
36	60006010100	SPLASHBACK 08	1
37	72210079000	BUCKET	4
38	0025060166	HH COLLAR SCREW M6X16 TX30	2
39	0017060203	EJOT PT SCREW K60X20 WS=6	4
40	6001201000001S	BAGGAGE RACK LC8 07	1

116010810 / C116010813

* NEW PART

X AS REQUIRED

MASK, FENDER

990 ADVENTURE DAKAR EDITI EU 2011

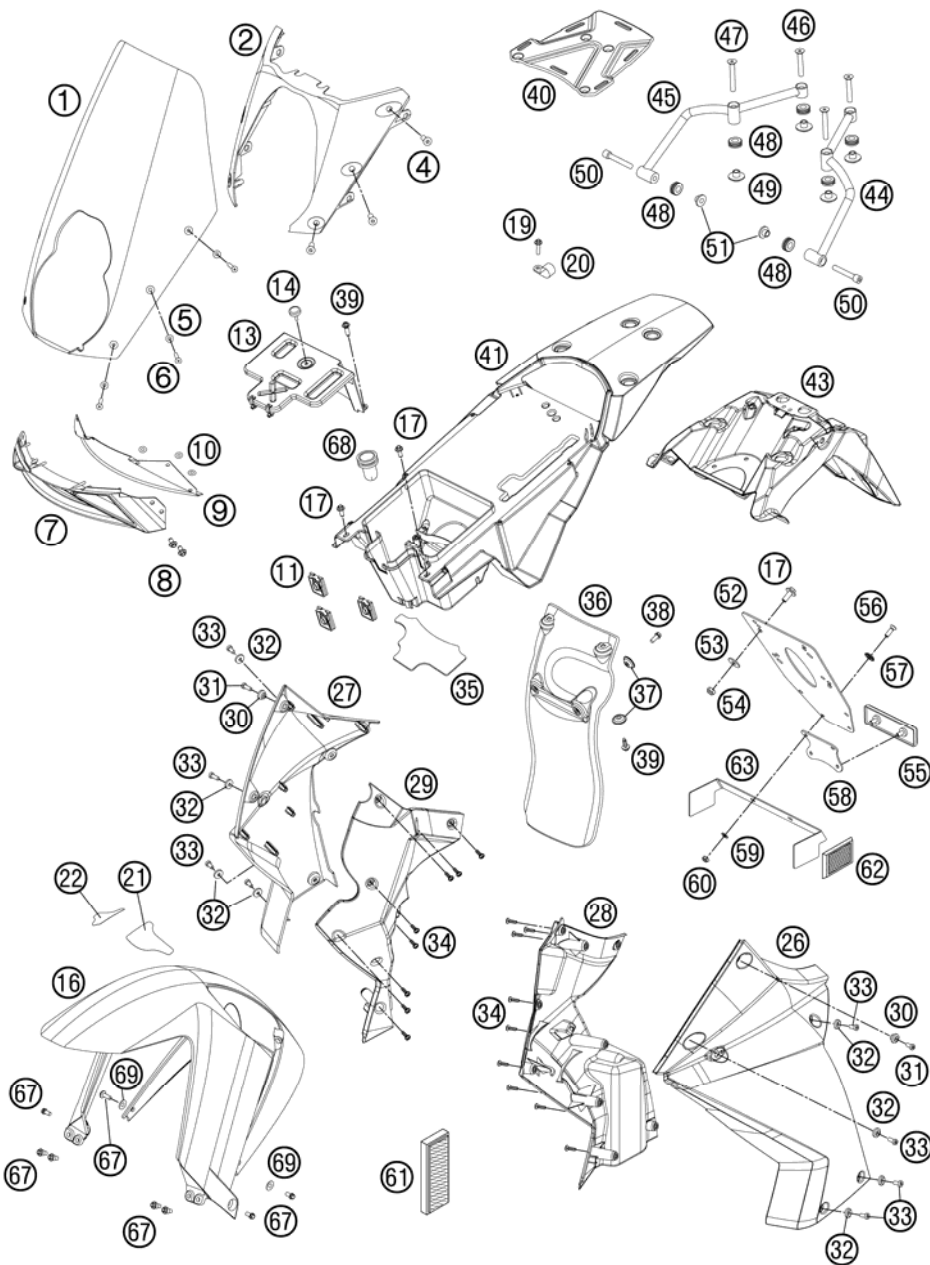

FIG	PART NUMBER	DESCRIPTION	QTY
41	6010801310033	REAR FENDER BLACK 09	1
43	60108015000	LICENSE NUMBER CARRIER 06	1
44	60012008000	HANDLE L/S 03	1
45	60012009000	HANDLE R/S 03	1
46	0991080503	FLAT HEAD SCREW DIN7991-M 8X50	2
47	0991080653	FLAT HEAD SCREW DIN7991-M 8X65	2
48	41001052000	RUBBER SLEEVE D=12MM	6
49	60012008003	COLLAR BUSHING 8,2X12X28X9 03	4
50	0912080553	AH SCREW DIN912 M8X55	2
51	60012008002	COLLAR BUSHING 8,2X12X20X9 03	2
52	60012081200	LICENCE FITTING 06	1
53	0021060003	WASHER DIN9021-A 6,4	4
54	0985060003	SELF LOCK. NUT DIN0985-M 6	4
55	58412080000	REFLECTOR RED LC4 '98	1
56	0966050163	OVAL HEAD SCREW DIN0966-M 5X16	2
57	40006006000	WASHER 6MM	2
58	58412080050	BRACKET FOR REFLECTOR	1
59	0125050003	WASHER DIN0125-A 5,3	2
60	0985050003	SELF LOCKING NUT DIN0985-M 5	2
61	60012080000	SIDE REFLECTOR YELLOW 03	2
62	16512180100	SIDE REFLECTOR RED REAR FOR USA+ AUS ONLY	2
63	62512081000	BRACKET SIDE REFLECTOR 06 FOR USA ONLY	1
67	0024060136	HH COLLAR SCREW M6X13 TX30	8
68	50206020000	RUBBER GRIMMET SLOTTED	1
69	60007020040	PLASTIC WASHER 03	2

116010810 / C116010813

* NEW PART

X AS REQUIRED

DECAL

990 ADVENTURE DAKAR EDITI EU 2011

FIG	PART NUMBER	DESCRIPTION	QTY
1*	60108099600	DECAL SET 990 ADV. DAKAR 2011	1

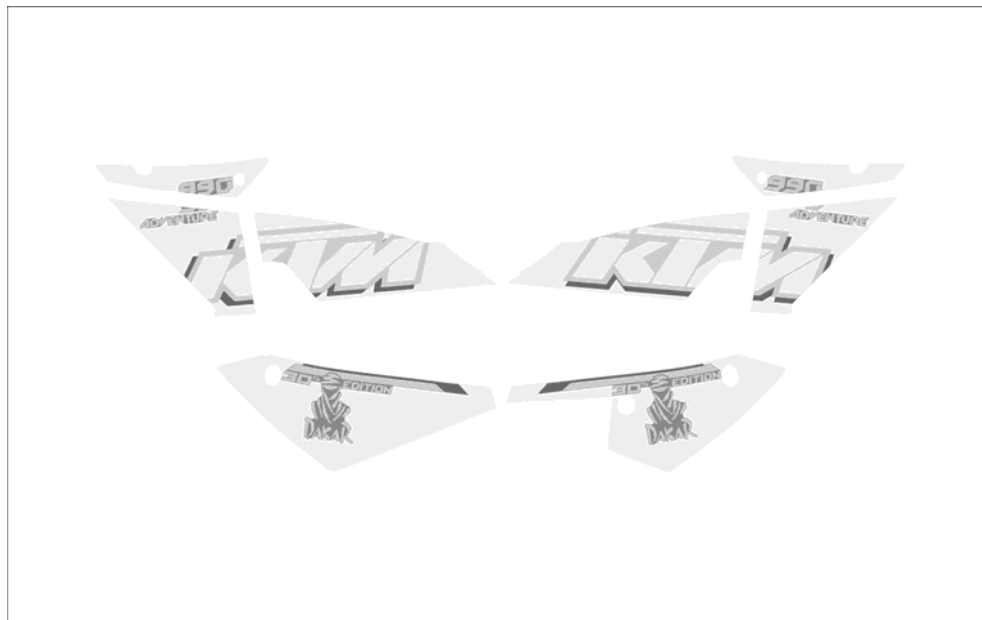

①

116010833 / C116010833

* NEW PART

X AS REQUIRED

FRONT WHEEL

990 ADVENTURE DAKAR EDITI EU 2011

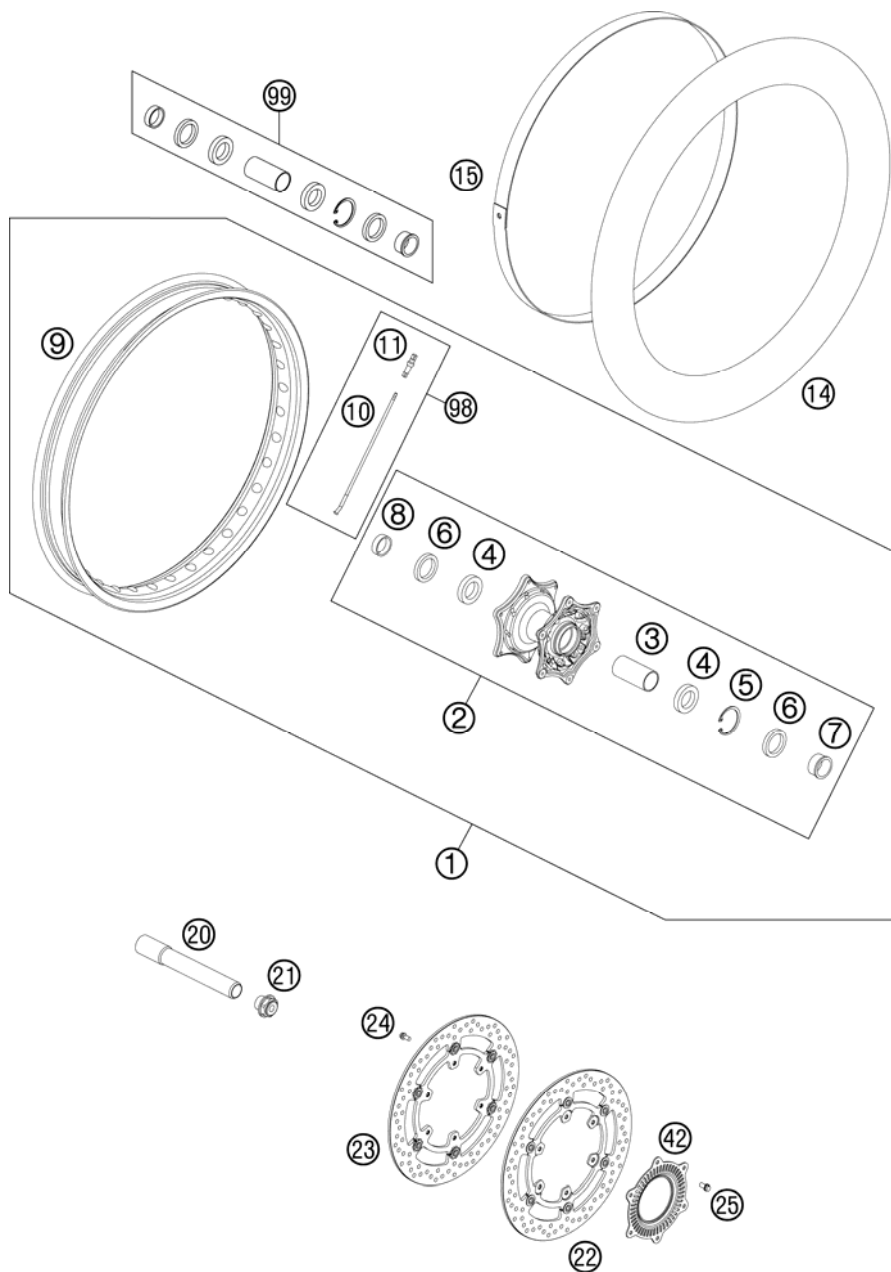

FIG	PART NUMBER	DESCRIPTION	QTY
1	6010900114430	FRONT WHEEL CPL. 2,15X21" BLACK	1
2	6000901004433	FRONT WHEEL HUB CPL. BLACK	1
3	60009014000	BEAR. SPACERTUBE FRONT 03	1
4	0625069068	GR.BALL BEAR.6906 DDU2CG23S6NM	2
5	0472047175	CIRCLIP DIN0472-47X1,75	1
6	0760354771	SHAFT SEAL RING 35X47X7 TC	2
7	60009012000	SPACER BUSH. FR. WHEEL L/S 03	1
8	60009013000	SPACER BUSH. FR. WHEEL R/S 03	1
9	6000907010030	RIM FRONT 2,15X21" BLACK 07	1
10	60009071000	SPOKE M5X230,5 13,5 DEG	36
11	58309072100	SPOKE NIPPLE M5-TA 8X21MM	36
14	50309075000	HOSE 21"	1
15	60009073000	RIM TAPE 21" 28/ 2MM 03	1
20	60009081000	WHEEL SPINDEL FRONT 03	1
21	60009082000	COLLAR SCREW FRONT AXLE 03	1
22	60109060100	BRAKE DISK FRONT 300MM ABS 06	1
23	60109060000	BRAKE DISK FRONT 300MM 06	1
24	59009062013	SPECIAL SCREW M6X13 WS=8 10.9	6
25	59009062016	SPECIAL SCREW M6X16 WS=8 10.9	6
42	60142020000	SENSOR WHEEL FRONT 06	1
98	00050000913	SPOKE KIT FRONT "21"	x
99	60009015010	FRONT WHEEL REP. KIT ADV	x

116010910 / C116010910

* NEW PART

X AS REQUIRED

REAR WHEEL

990 ADVENTURE DAKAR EDITI EU 2011

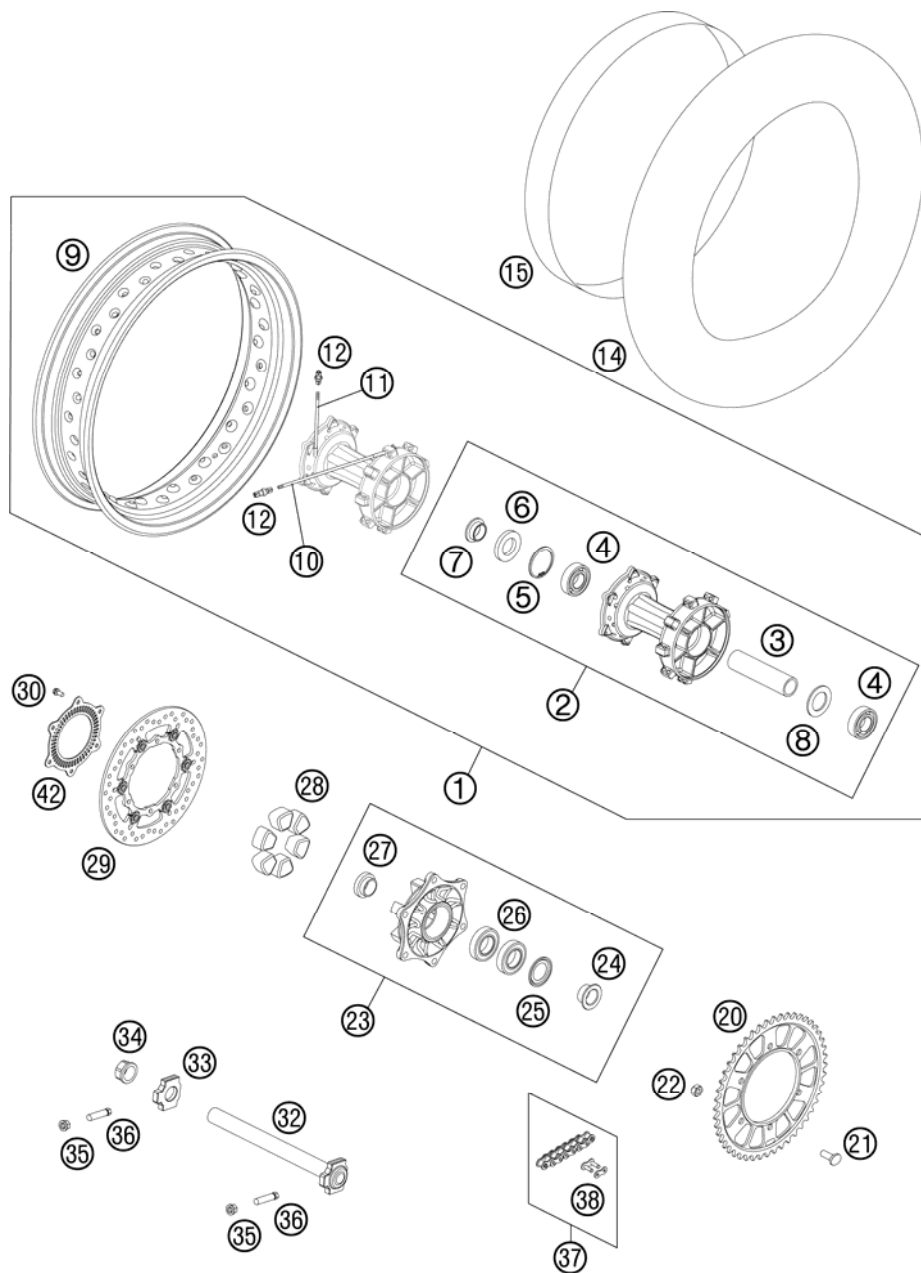

FIG	PART NUMBER	DESCRIPTION	QTY
1	6011000124430	REAR WHEEL CPL. 4,25X18"SW	1
2	6011001004433	REAR HUB CPL. BLACK	1
3	60010011000	BEAR. SPACERTUBE L=124,8MM 03	1
4	0625062052	GR.BALL BEAR. 6205-2RSHC3HMTF7	2
5	0472052200	CIRCLIP DIN0472-52X2	1
6	0760305271	SHAFT SEAL RING 30X52X7	1
7	60110013000	SPACER BUSH. REAR WHEEL R/S 06	1
8	60010015000	SPACER RING 03	1
9	6001007020030	RIM 4,25X18 BLACK	1
10	60010171000	SPOKE M5X219 19 DEG 03	18
11	60010071000	SPOKE M5X194 10 DEG 03	18
12	58309072100	SPOKE NIPPLE M5-TA 8X21MM	36
14	50310075100	HOSE 110/100C-18	1
15	60010073000	RIM TAPE 18" 50/2 03	1
20	60010051042	REAR SPROCKET 42-T 03	1
20	60010051045	REAR SPROCKET 45-T 03	x
21	60010052000	SPROCKET SCREW M10X1,25 03	6
22	0980101253	HEXAG.NUT DIN 980V M10X1,25 SL	6
23	6011005004433	SPROCKET SUPPORT CPL. BLACK	1
24	60110012000	SPACER BUSH. SPROCKET SUPP. 06	1
25	60110016000	NILOS RING 6006AV	1
26	0625060060	BALL BEARING 6006 DDU2CG23S6NM	2
27	60110014000	SPACER BUSH. SPR. SUPP. IN. 06	1
28	54610459000	RUBBER DAMPING BLOCK '91	6
29	60110060000	BRAKE DISK REAR D=240MM 06	1
30	59009062016	SPECIAL SCREW M6X16 WS=8 10.9	6
32	60010081144	WHEEL SPINDLE REAR CPL.	1
33	60010084000	CHAIN TENSIONER R/S LC8 03	1
34	60010086000	COLLAR NUT WH. SPINDLE REAR 03	1
35	58414030000	HH COLLAR NUT M10X1,25 WS=13	2
36	50304040100	SCREW M10X1,25X50 WS=10	2
37	60010365118	CHAIN 525 INCL. MASTER LINK	1
		RIVET TOOL NECCESARY	
38	60010266000	MASTER LINK FOR CHAIN 525 07	x
42	60142021000	SENSOR WHEEL REAR 06	1

116011010 / C116011010

* NEW PART

X AS REQUIRED

WIRING HARNESS

990 ADVENTURE DAKAR EDITI EU 2011

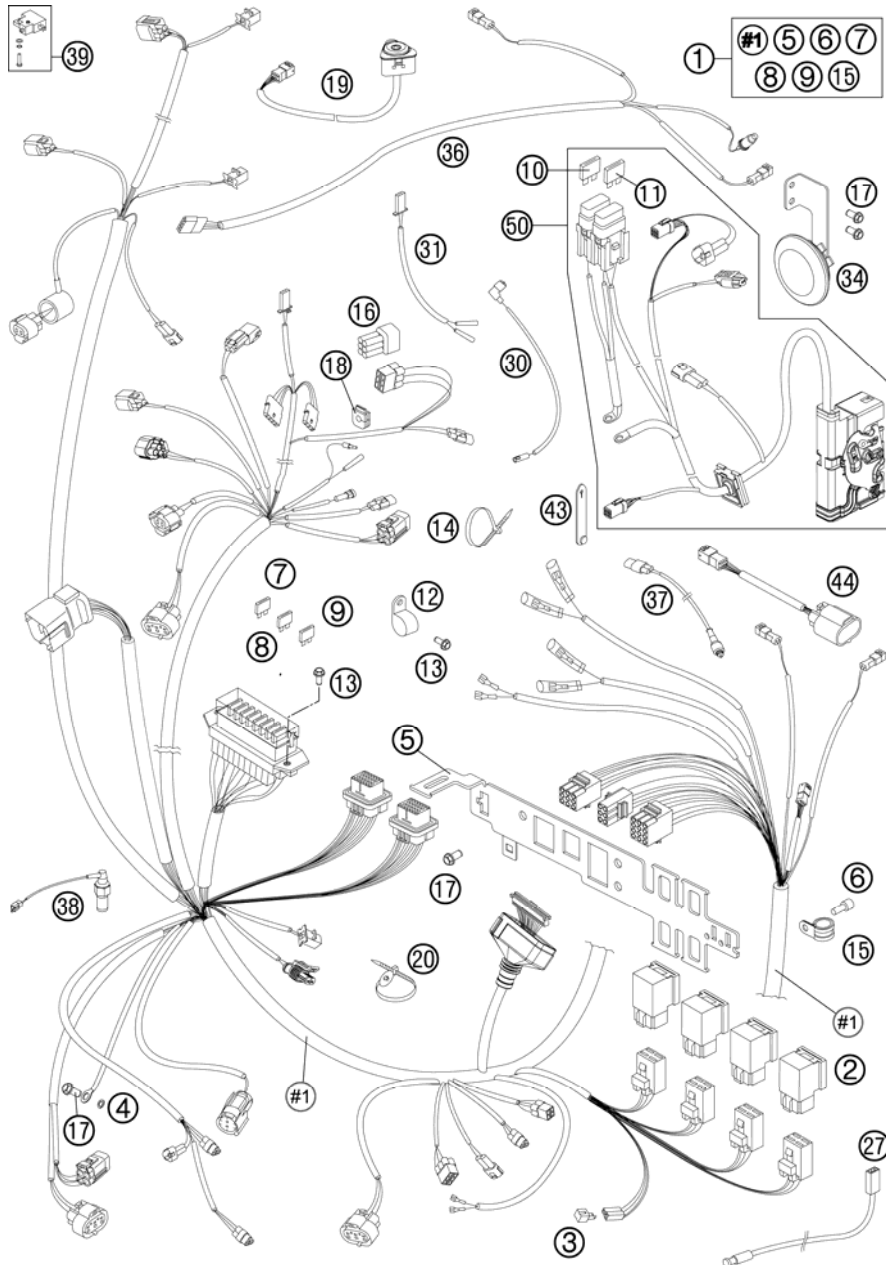

FIG	PART NUMBER	DESCRIPTION	QTY
1	60111075333	WIRING HARNESS 09	1
2	61111057000	RELAY CM1A-R-12V-H80 07	4
3	58411096100	DIODE S3H-15 97	2
4	58411098100	CONTACT WASHER M6 VSV-K6	1
5	60111083000	BRACKET FOR PLUGS 06	1
6	0912050123	AH SCREW DIN0912-M 5X12	1
7	58011109105	FUSE 5 A 2003	x
8	58011109110	FUSE 10 A 2000	x
9	58011109115	FUSE 15 A	x
10	58011109125	FUSE 25 A	x
11	58011109140	FUSE 40 A	x
12	57013070400	PVC CLAMP 17,4MM HEYCO 3381	1
13	0025050126	HH COLLAR SCREW M5X12 TX30	3
14	44011076140	CABLE TIE 140/2,5MM BLACK	x
14	44011076200	CABLE TIE 200/3,6MM BLACK	x
14	44011076305	CABLE TIE 300/4,8MM BLACK	x
15	49007439000	CLAMP RSGU 15/12	1
16	000700000BH	SPARE CONNECTOR BH 6-PINS DIAGNOSTIC PORT	1
17	0025060106	HH COLLAR SCREW M6X10 TX30	6
18	60108017015	RUBBER SLEEVE 22X18 MM 06	1
19	60211022000	HAZARD WARNING BUTTON	1
20	60011193000	CABLE TIE WITH PLUG 03	1
27	61111018000	TEMPERATURE SENSOR 07	1
30	60011092000	OIL-PRESSURE SWITCH CABLE 03	1
31	60011025000	FLASHER CABLE FRONT 03	2
34	60011060100	DC HORN 12V 06	1
36	60111076000	WIRING HARNESS REAR 06	1
37	58411049100	CLUTCH SWITCH 03	1
38	50311051100	BRAKE LIGHT SWITCH REAR '98	1
39	60011050000	BRAKE LIGHT SW. FRONT CPL. 03	1
43	60011093045	RUBBER CABLE TIE 45MM 03	x
43	60011093060	RUBBER CABLE TIE 60MM 03	x
43	60011093075	RUBBER CABLE TIE 75MM 03	x
44	61111020000	STARTER INTERLOCK	1

116011110 / C116011110

* NEW PART

X AS REQUIRED

WIRING HARNESS

990 ADVENTURE DAKAR EDITI EU 2011

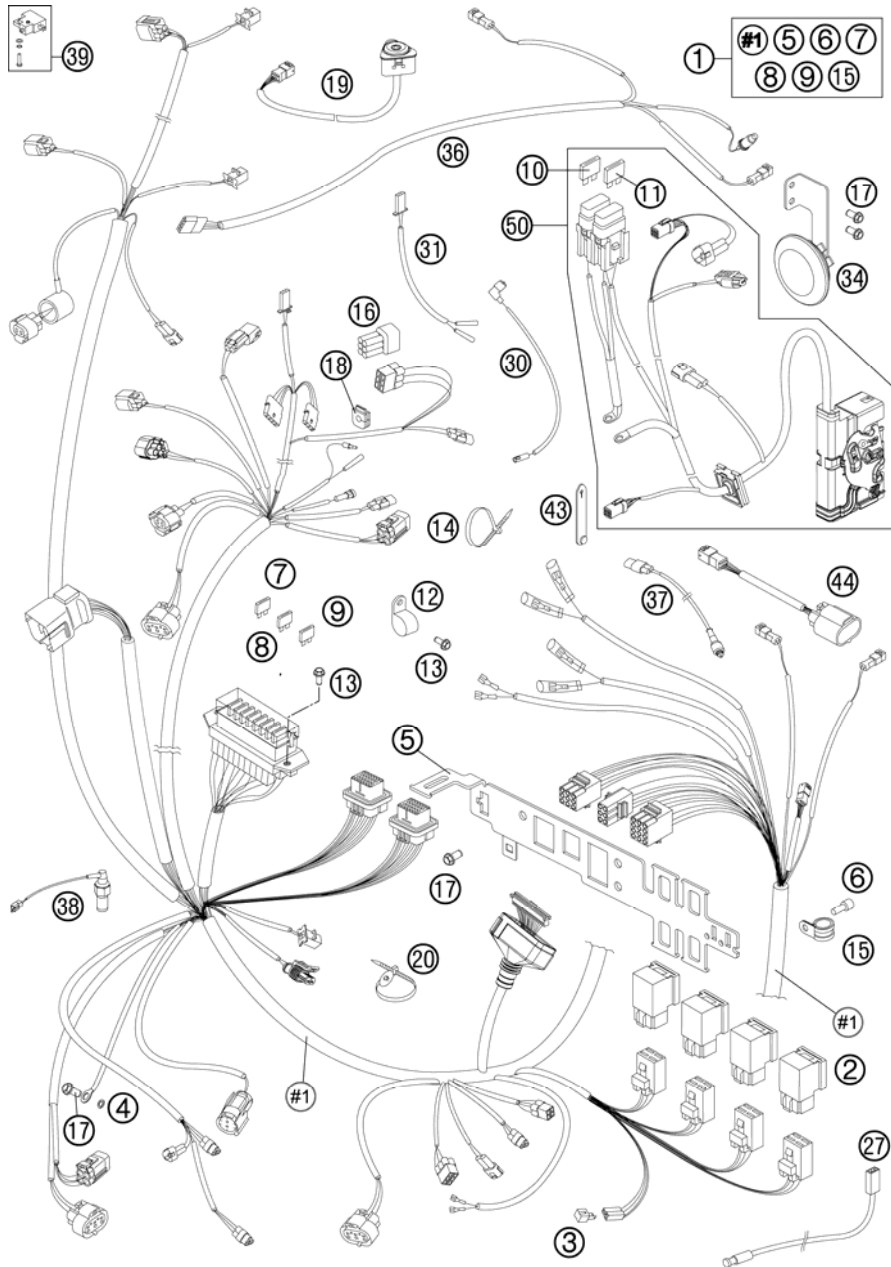

FIG	PART NUMBER	DESCRIPTION	QTY
50	60111079000	WIRING HARNESS ABS	1

116011110 / C116011110

* NEW PART

X AS REQUIRED

BATTERY

990 ADVENTURE DAKAR EDITI EU 2011

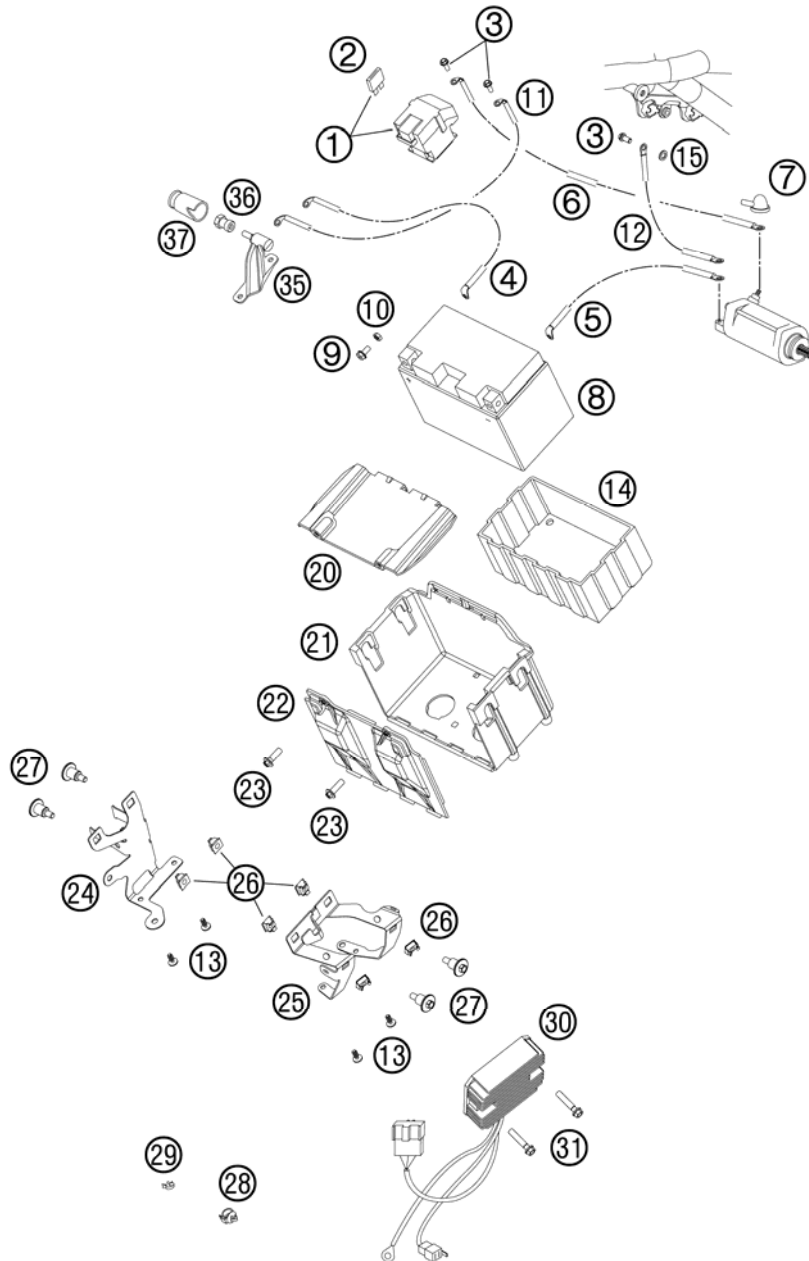

FIG	PART NUMBER	DESCRIPTION	QTY
1	60011058000	STARTER RELAY 03	1
2	58011109130	FUSE 30 A	x
3	0025060106	HH COLLAR SCREW M6X10 TX30	3
4	60011059050	BATTERY CABLE L=350MM LC8 03	1
5	60011097000	GROUND CABLE L=470MM 03	1
6	60011059000	STARTERCABLE L=475MM LC8 03	1
7	60040009000	RUBBER CAP STARTER PORT 03	1
8	60011053000	BATTERY 12V/11AH 03	1
9	0024060106	HH COLLAR SCREW M6X10 TX30	2
10	0934060003	HEXAGON NUT DIN0934-M 6	2
11	60111059000	BATTERY CABLE 250MM 06	1
12	60111097000	GROUND CABLE 100MM 06	1
13	0081050121	SCREW FOR PLASTIC K50X12 T20	4
14	58411053050	BATTERY COVER 96	1
15	58411098100	CONTACT WASHER M6 VSV-K6	1
20	60011054007	BATTERY BOX TOP PART 03	1
21	60011054000	BATTERY BOX 03	1
22	60011054006	BATTERY BOX FRONT PART 03	1
23	0017060203	EJOT PT SCREW K60X20 WS=6	2
24	60111056000	BRACKET STARTER RELAY 06	1
25	60011055000	BRACKET VOLTAGE REGULATOR 03	1
26	60011038000	CAGE NUT M6 SL K100-1 1,5MM	6
27	60038083000	SCREW OIL TANK FIXING 03	4
28	58111076000	CABLE SUPPORT KHS NR.150-47610	5
29	57013072100	WIRING HOLDER 16MM	2
30	60011034100	VOLTAGE REGULATOR	1
31	0025060306	HH COLLAR SCREW M6X30 TX30	2
35	60111048000	POSITIVE POL EXTENSION 06	1
36	60111048020	HEXAGON NUT M6 SW=13 L=20	1
37	60111048035	COVER CAP OUTER 06	1

116011130 / C116011130

* NEW PART

X AS REQUIRED

HAND BRAKE CYLINDER

990 ADVENTURE DAKAR EDITI EU 2011

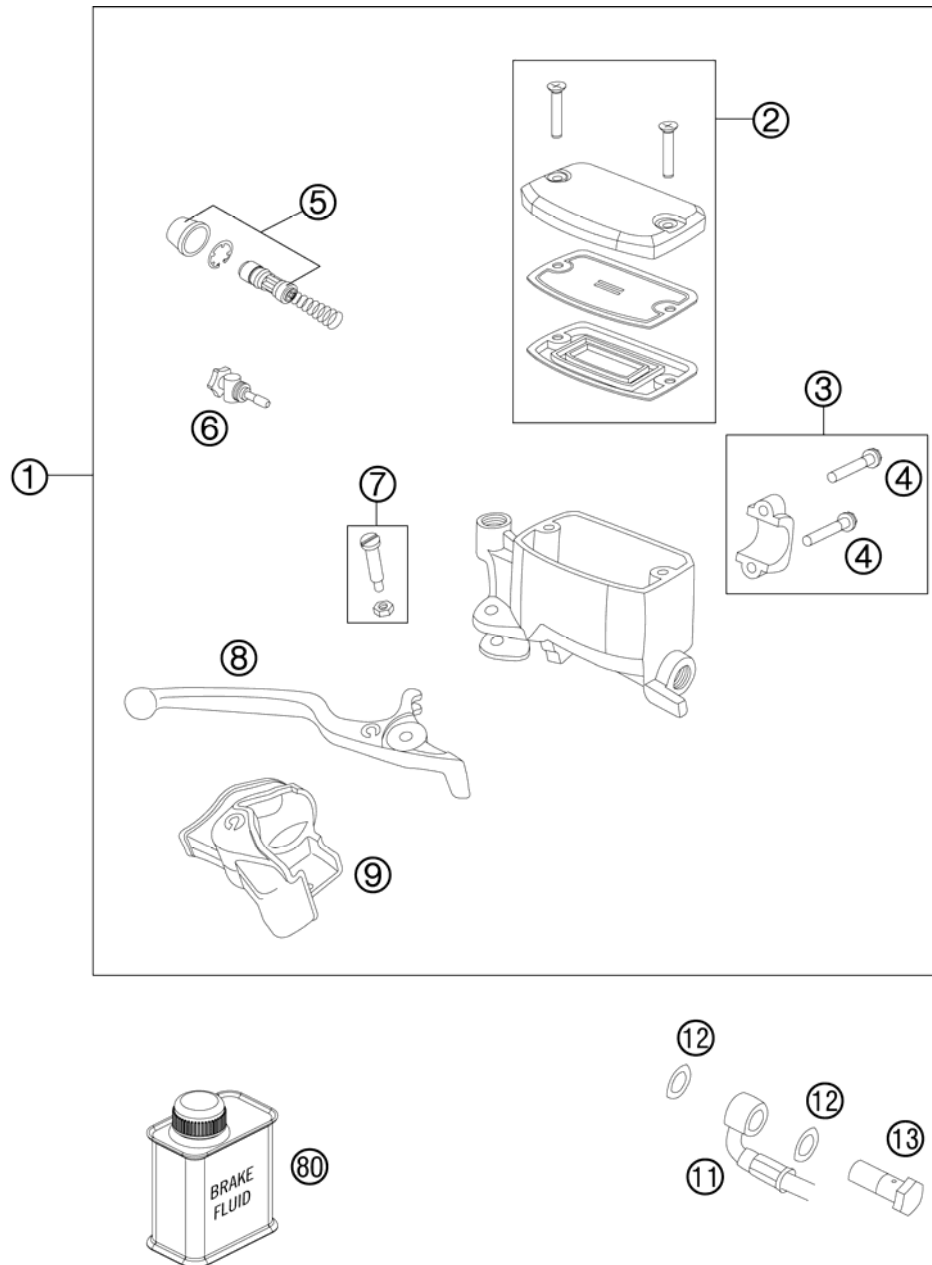

FIG	PART NUMBER	DESCRIPTION	QTY
1	60013001000	HAND BRAKE CYLINDER 03	1
2	60013003000	HAND BRAKE CYL. COVER CPL. 03	1
3	60013005000	CLAMP CPL. 03	1
4	0025060256	HH COLLAR SCREW M6X25 TX30	2
5	60013008000	REP.SET PISTON LC8 ADV 03	1
6	60013007000	ADJUSTING SCREW CPL. LC8 ADV	1
7	60013006000	LEVER SCREW CPL. 2003	1
8	60013002000	HAND BRAKE LEVER 2003	1
9	60013004000	PROTECTION CAP HAND BRAKE CYL.	1
11	60142010000	BRAKE HOSE L=1320MM 06	1
12	0603100141	COPPER GASKET DIN7603-10X14X1	2
13	50213025000	HOLLOW SCREW M10X1X19	1
80	00062030000	BRAKE FLUID DOT5.1 0,25L	1

116011310 / C116011310

* NEW PART

X AS REQUIRED

REAR BRAKE CONTROL

990 ADVENTURE DAKAR EDITI EU 2011

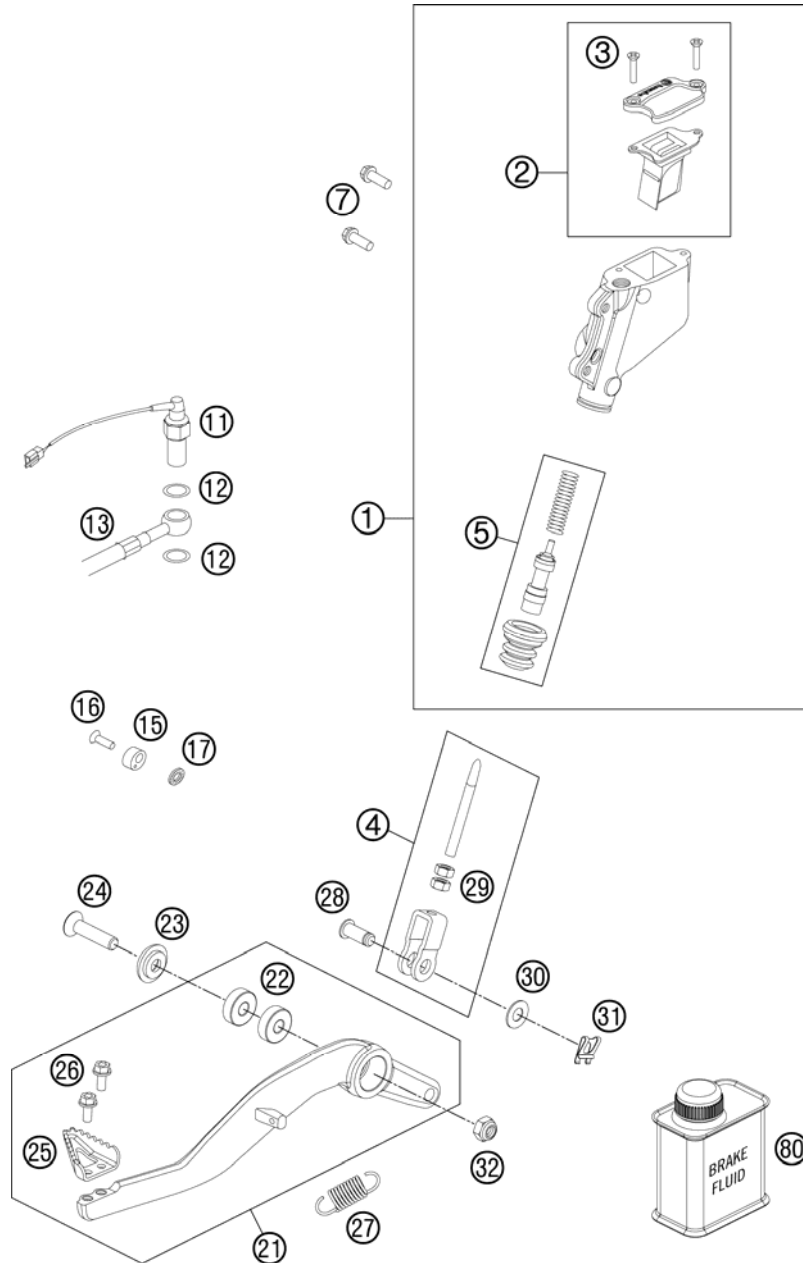

FIG	PART NUMBER	DESCRIPTION	QTY
1	60013060300	MAIN BRAKE CYLINDER CPL. 07	1
2	60013059100	COVER MAIN BRAKE CYLINDER CPL.	1
3	0965040161	FLAT HEAD SCREW DIN0965-M 4X16	2
4	63013056044	PUSH ROD CPL. 06	1
5	60013061100	REPAIR KIT PISTON 07	1
7	59009062016	SPECIAL SCREW M6X16 WS=8 10.9	2
11	50311051100	BRAKE LIGHT SWITCH REAR '98	1
12	0603100141	COPPER GASKET DIN7603-10X14X1	2
13	60142012200	BRAKE HOSE L=360 08	1
15	58413048000	BRAKE LEVER STOP LC4 03	1
16	0991060202	FLAT HEAD DIN7991-M 6X20	1
17	0797060003	TOOTH LOCK WASH. DIN6797-A 6,4	1
21	6001305004401S	FOOT BRAKE LEVER CPL. 07	1
22	0625006087	GROOVED BALL BEAR. 608 2RS C3	2
23	62603062000	SPECIAL WASHER 8X24 ALU H=2,6	1
24	0019080356	COUNTERSUNK SCREW ISA45 M8X35	1
25	60013051000	STEP PLATE FOOT BRAKE LEVER 03	1
26	0025050126	HH COLLAR SCREW M5X12 TX30	2
27	54603062000	RETURN SPRING FOR BRAKE LEVER	1
28	60013057000	BOLT F. LINK FORK 8X20X16,5	1
29	0934060003	HEXAGON NUT DIN0934-M 6	2
30	0125080003	WASHER DIN0125-A 8,4	1
31	60013058000	SECURING CLIP D=8MM 03	1
32	0985080003	SELF LOCKING NUT DIN0985-M 8	1
80	00062030000	BRAKE FLUID DOT5.1 0,25L	1

116011330 / C116011330

* NEW PART

X AS REQUIRED

BRAKE CALIPER FRONT

990 ADVENTURE DAKAR EDITI EU 2011

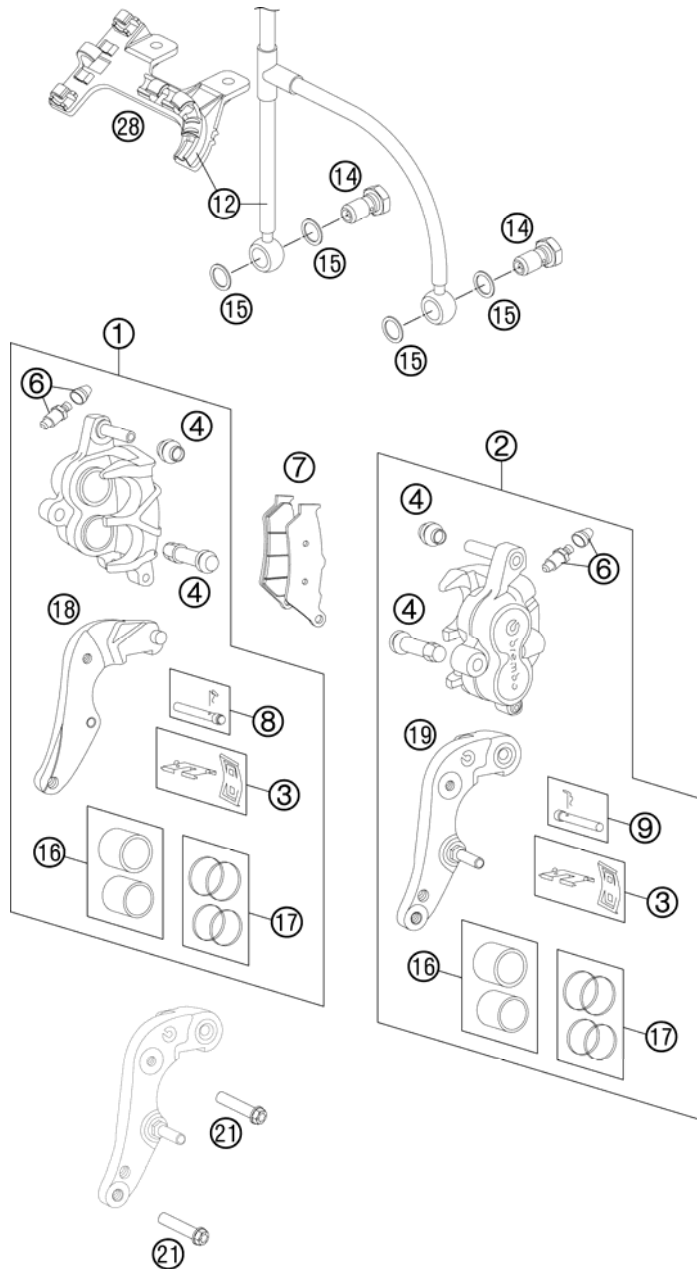

FIG	PART NUMBER	DESCRIPTION	QTY
1	6011301600133	BRAKE CAL. FR.R/S-WITHOUT PADS WITH BRAKE CALIPER SUPPORT	1
2	6011301500133	BRAKE CAL. FR.L/S-WITHOUT PADS WITH BRAKE CALIPER SUPPORT	1
3	60013018000	RETAINING PLATE SET FRONT 03	2
4	54613218000	CUP SET SHORT	2
6	60013020000	BLEEDER SCREW WITH CAP	2
7	60013030000	BRAKE PADS TOSHIBA TT 2172 HHA	2
8	60013017100	BOLT SET R/S	1
9	60013017000	BOLT SET L/S	1
12	60142011000	BRAKE HOSE 1190/715/810MM 06	1
14	50213025000	HOLLOW SCREW M10X1X19	2
15	0603100141	COPPER GASKET DIN7603-10X14X1	4
16	60013083000	BRAKE PISTONS 30/32MM	2
17	60013019000	REP.KIT SEALING RINGS 30/32MM	2
18	60113049000	BRAKE CALIPER SUPPORT FR. R/S WITH RETAINING PLATE	1
19	60113049100	BRAKE CALIPER SUPPORT FR. L/S WITH RETAINING PLATE	1
21	0025080356S	HH COLLAR SCREW M8X35 TX40	4
28	60101078000	BRAKE HOSE GUIDE LOWER 06	1

116011360 / C116011360

* NEW PART

X AS REQUIRED

BRAKE CALIPER REAR

990 ADVENTURE DAKAR EDITI EU 2011

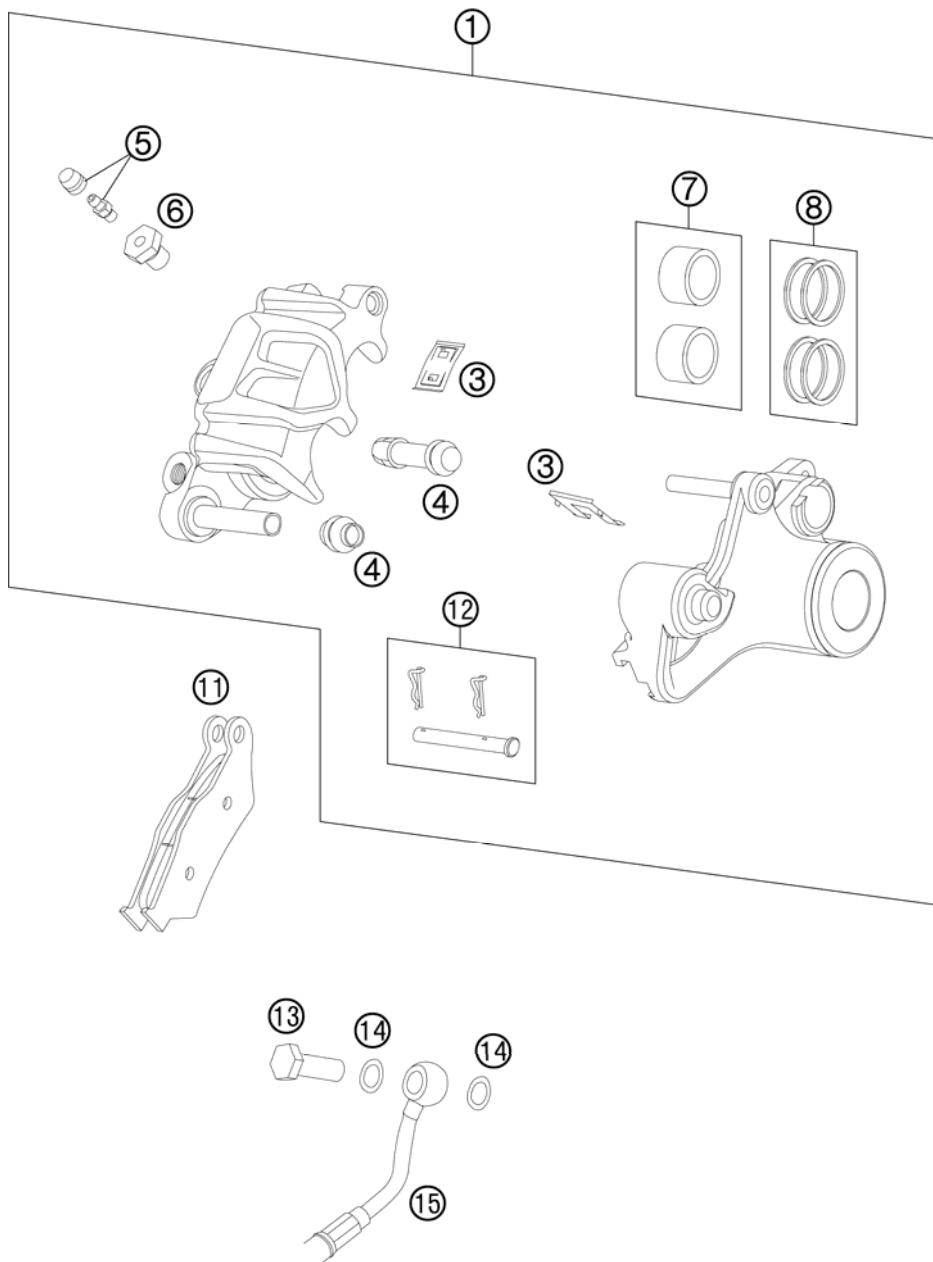

FIG	PART NUMBER	DESCRIPTION	QTY
1	6011308000133	BRAKE CALIPER REAR	1
3	60013018100	RETAINING PLATE SET REAR 03	1
4	54613218000	CUP SET SHORT	1
5	60013020200	BLEEDER SCREW WITH CAP M6	1
6	60013020100	ADAPTER SCREW	1
7	60013083200	BRAKE PISTONS 05	1
8	60013081000	REP.KIT SEALINING RINGS	1
11	50313030200	BRAKEP.SET FR.TOSHIBA TT2701HH	1
12	77013017000	BOLT CPL. 09	1
13	50213025000	HOLLOW SCREW M10X1X19	1
14	0603100141	COPPER GASKET DIN7603-10X14X1	2
15	60142013200	BRAKE HOSE L=845 08	1

116011390 / C116011390

* NEW PART

X AS REQUIRED

LIGHTNING SYSTEM

990 ADVENTURE DAKAR EDITI EU 2011

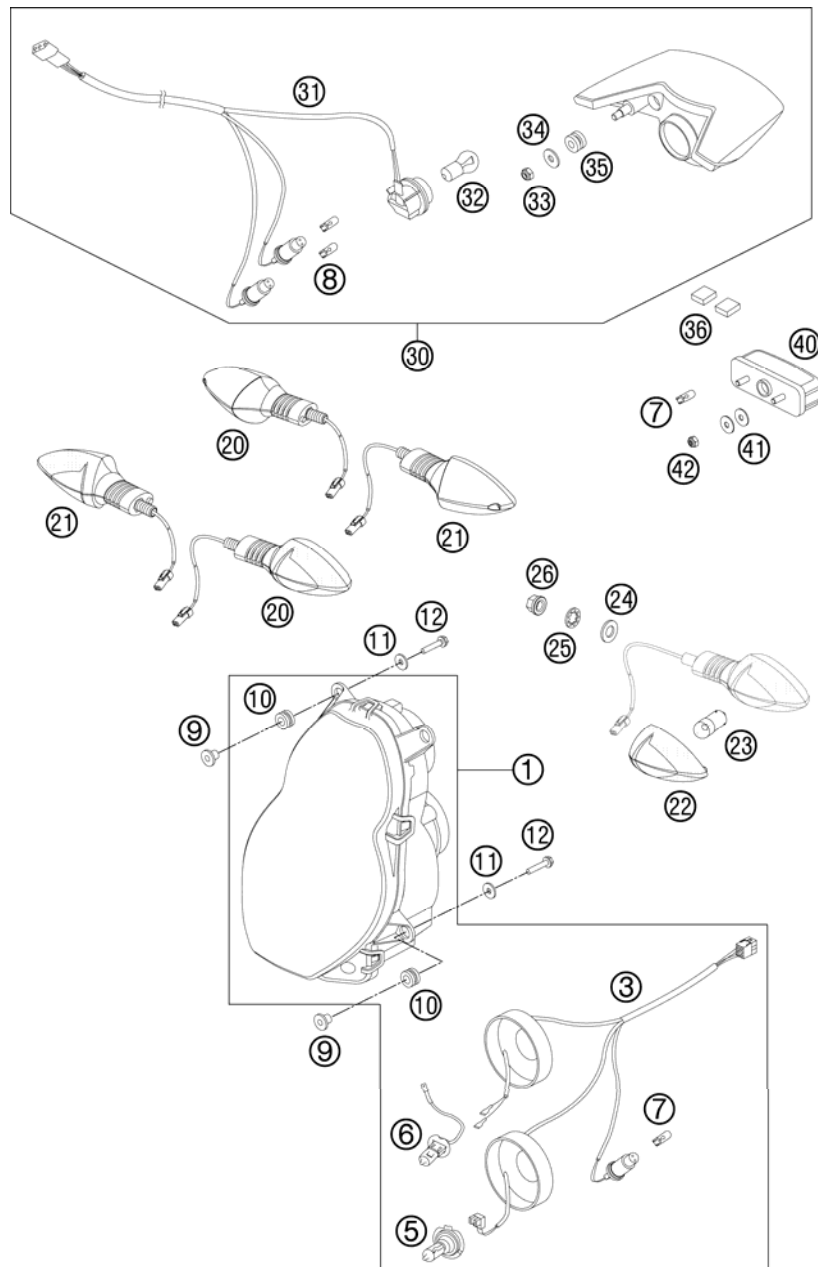

FIG	PART NUMBER	DESCRIPTION	QTY
1	60014001000	HEAD LIGHT RIGHT TR. EU 03	1
3	60014001050	HEAD LIGHT WIRING HAR. EU/GB	1
5	60014003100	BULB H7 12V 55W	1
6	60014003000	BULB H3 12V 55W	1
7	49011435100	BULB 12V 5W (W2,1X9,5D) PHIL.	2
8	49011435200	BULB RED WR5W 12V	2
9	60014007000	SPACER BUSHING HEAD LIGHT 03	4
10	31008008000	RUBBER GROMMIT BLACK	4
11	0021050003	WASHER DIN9021-A 5,3	4
12	0016050253	SCREW FOR PLASTIC 03	4
20	60114025000	FLASHER CPL.FRONT L/S REAR R/S	2
21	60114026000	FLASHER CPL.FRONT R/S REAR L/S	2
22	60114028000	FLASHER LENS L/S R/S TRANSP.06	4
23	60114027000	BULB 12V ORANGE (RY10W)	4
24	0125100003	WASHER DIN0125-A10,5	4
25	0797100003	LOCK WASHER DIN6797-J10,5 ZI	4
26	58414030000	HH COLLAR NUT M10X1,25 WS=13	4
30	60014140044	REAR LIGHT CPL. 09	1
31	60111077000	WIRING HARNESS REAR LIGHT 09	1
32	60014048100	BULB RED PR21W 12V	1
33	0985060003	SELF LOCK. NUT DIN0985-M 6	2
34	0021060003	WASHER DIN9021-A 6,4	2
35	58214069051	RUBBER GROMMET 16X10,8X3 02	2
36	60014040050	BUMP RUBBER 20X20X6 MM 03	2
40	58414047000	LICENSE-PLATE ILLUMINATION '98	1
41	0021050003	WASHER DIN9021-A 5,3	4
42	0985050003	SELF LOCKING NUT DIN0985-M 5	2

116011410 / C116011410

* NEW PART

X AS REQUIRED

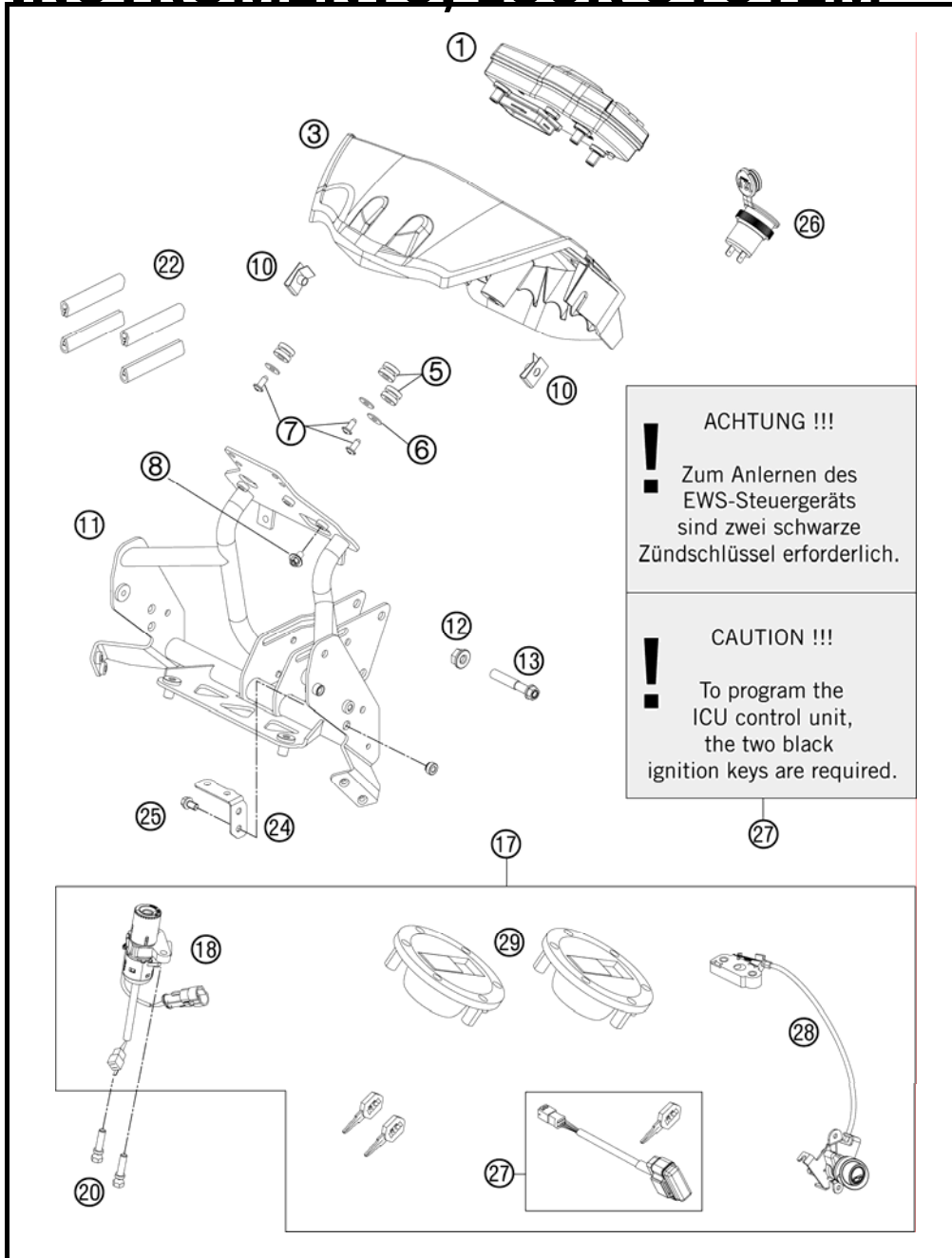

FIG	PART NUMBER	DESCRIPTION	QTY
1	60114169200	SPEEDOMETER 10	1
3	60114070200	INSTRUMENTS COVER ABS 09	1
5	58214069051	RUBBER GROMMET 16X10,8X3 02	3
6	0021050003	WASHER DIN9021-A 5,3	3
7	0081050121	SCREW FOR PLASTIC K50X12 T20	3
8	0024060106	HH COLLAR SCREW M6X10 TX30	3
10	54603048100	RANGE CHANGE METAL NUT M6	2
11	60114010000	COCKPIT SUPPORT 06	1
12	54310086200	SELF LOCKING NUT M8 10.9	2
13	0025080456	HH COLLAR SCREW M8X45 TX40	2
17	60111066044	LOCK SYSTEM 990 ADV. 09	1
18	60111066000	IGNITION LOCK	1
20	60011064000	TAMPERPROOF SCREW F. IGN. LOCK	2
22	60114010070	EDGE PROTECTOR 14X9,5X66 MM 06	4
24	60103001166	SUPPORT ROLLOVER SENSOR 06	1
25	0025060106	HH COLLAR SCREW M6X10 TX30	2
26	60111042100	SOCKET	1
27	62611021000	IMMOBILIZER 990SM W. MASTERKEY	1
28	60107050000	SEAT LOCK	1
29	60007108000	TANK PLUG	2

116011430 / C116011430

* NEW PART

X AS REQUIRED

ACCESSORIES KIT

990 ADVENTURE DAKAR EDITI EU 2011

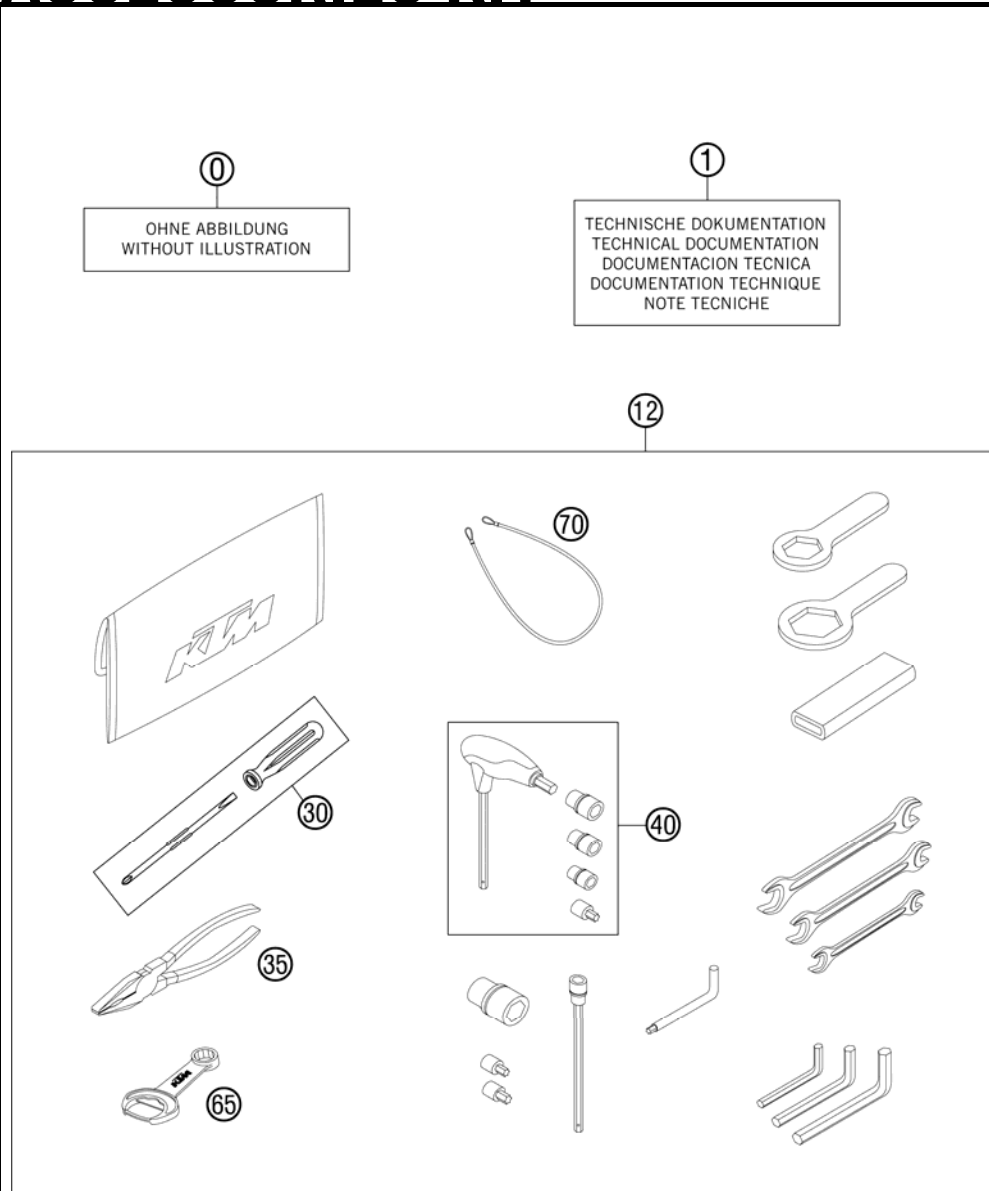

FIG	PART NUMBER	DESCRIPTION	QTY
0*	00063004202	PRINT LABEL 60X51 MM	1
0	00063099111	BAG FOR INSTRUCTION MANUAL	1
0*	0019050201	COUNTERSUNK SCREW ISA25 M5X20	6
0	0021060003	WASHER DIN9021-A 6,4	4
0	0024060156	HH COLLAR SCREW M6X15 TX30	10
0	0125050003	WASHER DIN0125-A 5,3	2
0	0966050163	OVAL HEAD SCREW DIN0966-M 5X16	2
0	0985050003	SELF LOCKING NUT DIN0985-M 5	2
0	0985060003	SELF LOCK. NUT DIN0985-M 6	4
0	312305	DOCUMENTS BAG 2006	1
0	312313	KTM BALLPOINT PEN ORANGE	1
0*	3210040	CUSTOMER WELCOME LETTER	1
0	40006006000	WASHER 6MM	2
0	58412040100	REAR MIRROR L/S+R/S LC4 2001	2
0	58412080000	REFLECTOR RED LC4 '98	1
0	58412080050	BRACKET FOR REFLECTOR	1
0	60003092100	UNDERRIDE PROTECTION LEFT 06	1
0	60003093100	UNDERRIDE PROTECTION RIGHT 06	1
0	60008008000	FAIRING SCREEN 03	1
0	60008008050	BLIND PLUG-IN NUT M5 WN 16A 03	6
0	60008046000	SPECIAL WASHER D=12MM 03	6
0	6001206810004	TANK PROTECTION ORANGE	1
0	60012081200	LICENCE FITTING 06	1
0	60035040044	RADIATOR PROTECTION CPL.	1
1*	3211657EN	OWN. MAN. 990 ADVENTURE/R 2011	1
12	61129099000	TOOL SET 08	1
30	53012024100	SCREW DRIVER L=105MM	1
35	53012028200	GRIP ORANGE B&F	1
40	60029070200	T-WRENCH WS=6/8/10 TX=45 B&F	1
65	50329071100	WRENCH WS=13 B&F + OPENER	1
70	60012015000	HELMET LOCK 04	1

116012000 / C116012003

* NEW PART

X AS REQUIRED

ANTI-SKID SYSTEM ABS

990 ADVENTURE DAKAR EDITI EU 2011

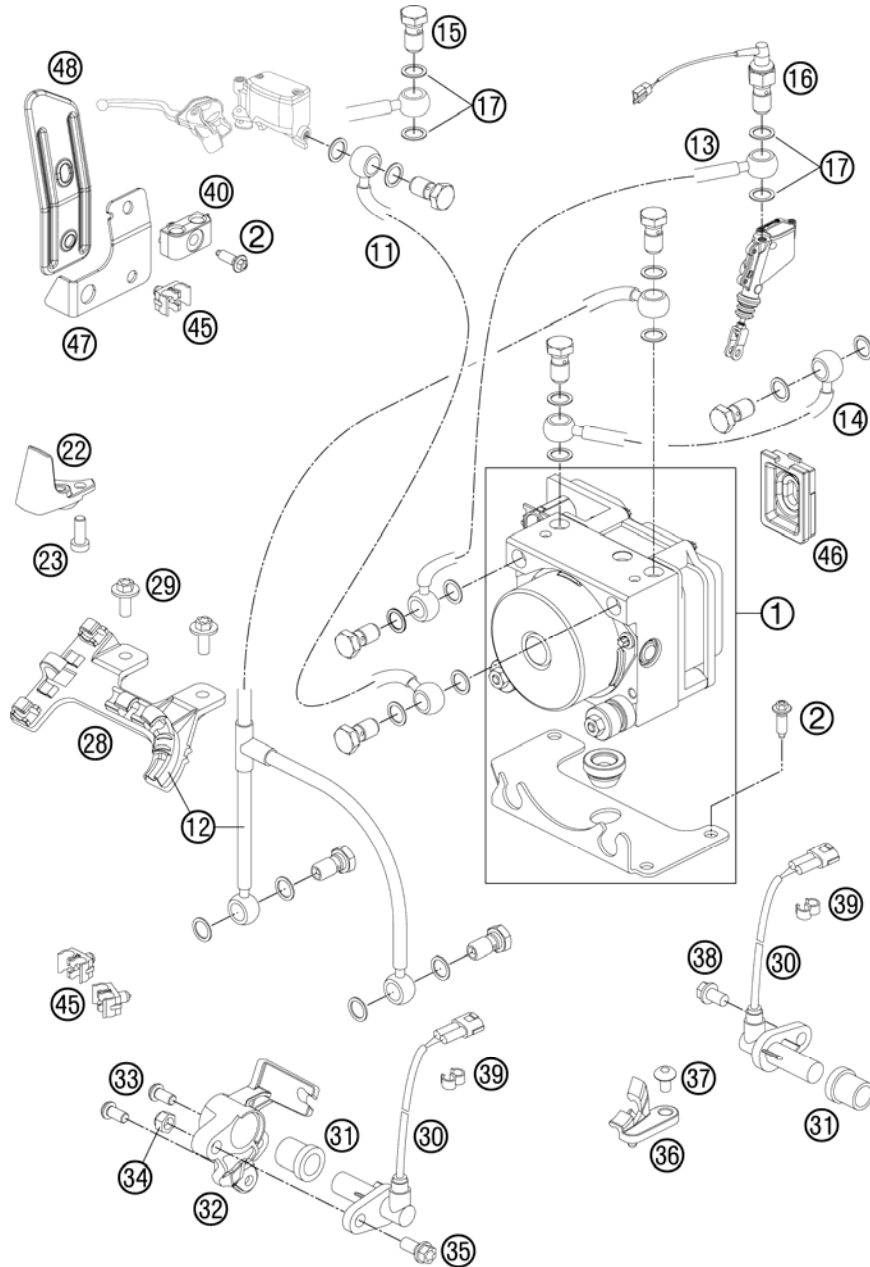

FIG	PART NUMBER	DESCRIPTION	QTY
1	60142031244	ABS-MODULE INCL. SUPPORT	08
2	0017060203	EJOT PT SCREW K60X20 WS=6	6
11	60142010000	BRAKE HOSE L=1320MM	06
12	60142011000	BRAKE HOSE L=1190/715/810MM	06
13	60142012200	BRAKE HOSE L=360	08
14	60142013200	BRAKE HOSE L=845	08
15	50213025000	HOLLOW SCREW M10X1X19	8
16	50311051100	BRAKE LIGHT SWITCH REAR '98	1
17	0603100141	COPPER GASKET DIN7603-10X14X1	18
22	60101077000	BRAKE HOSE GUIDE TOP	06
23	0012060164	AH SCREW DIN6912 M6X16 SL	1
28	60101078000	BRAKE HOSE GUIDE LOWER	06
29	0024060156	HH COLLAR SCREW M6X15 TX30	2
30	60142025000	ABS-SENSOR	06
31	60142024050	SLEEVE SENSOR HOLDER ABS	2
32	60142024000	SENSOR HOLDER FRONT	06
33	0018050103	INT. TORX OVAL HEAD M 5X10 8.8	2
34	0985060003	SELF LOCK. NUT DIN0985-M 6	1
35	0025060166	HH COLLAR SCREW M6X16 TX30	1
36	60142026000	CABLE SUPPORT SWING ARM	06
37	58605083010	SCREW TORX M5X10	05
38	59009062013	SPECIAL SCREW M6X13 WS=8 10.9	1
39	60111094000	CLAMP 5/7 MM	06
40	60113046000	SUPPORT FOR BRAKE HOSE	06
45	60113026000	HOSE SUPPORT 7/7 MM	06
46	60108017010	RUBBER SLEEVE 30X40 MM	06
47	60113044000	RETAINING PLATE BRAKE HOSE REA	1
48	60113043000	HEAT PROTECT. BRAKE REAR HI.07	1

116014210 / C116014210

* NEW PART

X AS REQUIRED



KTM-Sportmotorcycle AG
A-5230 Mattighofen
www.ktm.at

KTM Group Partner



3CF9803KBEN



Art.Nr.: 3CF9803KBEN 2/2011